

HG60FXA
HG75FXB
HG90FXB
HG90FX-MB

EN User Manual
Hob

USER MANUAL

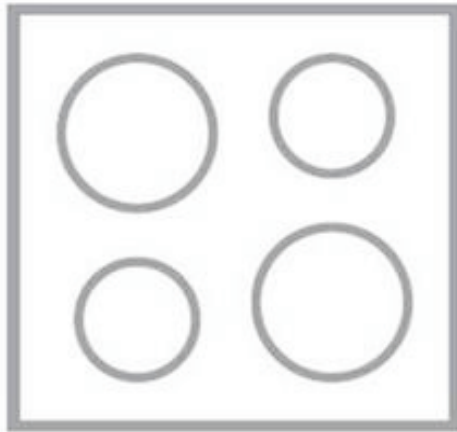

AEG

GENERAL NOTICE



We invite you to read this instruction booklet carefully, before installing and using the equipment. It is very important that you keep this booklet together with the equipment for any future consultation.

If this equipment should be sold or transferred to another person, make sure that the new user receives the booklet, so that they can learn how to operate the appliance and read the corresponding notice.

This is a Class 3 appliance.

This appliance complies with the following Directives:

AS/NZS 5263.0 & 5263.1.1

AS/NZS60335-1 & 60335-2-102

AS/NZS CISPR 14.1

WARNING

- The installation must be carried out by authorised personnel, in conformity with the regulations in force.
- **CAUTION:** The surface temperature of underbench components exceeds 95°C. To avoid a hazard, underbench access must be restricted. Refer to the installation instructions.
- This appliance is not intended for use by persons (including children) with reduced physical, sensory or mental capabilities, or lack of experience and knowledge, unless they have been given supervision or instruction concerning use of the appliance by a person responsible for their safety.
- Children should be supervised to ensure that they do not play with the appliance.
- Before powering the equipment, check that it is properly adjusted for the type of gas at disposal (see the “installation” paragraph).
- If the supply cord is damaged it must be replaced by a special cord or assembly available from the manufacturer or its service agent.
- Before carrying out the maintenance or cleaning the equipment, cut off power supply and allow it cool down.
- Make sure that air circulates around the gas equipment. Insufficient ventilation produces a lack of oxygen.
- In case of an intense or prolonged use of the equipment, it may be necessary to improve aeration, for example by opening a window or increasing rangehood venting power, if it exists.
- The products of combustion must be discharged outside through a suction hood or an electric fan (see the “installation” paragraph).
- For any possible operation or modification, apply to an authorized Technical Assistance Centre and demand original spare parts.
- Where this appliance is installed in marine craft or in caravans, it shall not be used as a space heater.
- Not for use in marine craft, caravans or mobile homes unless each burner is fitted with a flame safeguard.
- Do not spray aerosols in the vicinity of the appliance while it is in operation.
- Do not use or store flammable materials in the appliance storage drawer or near this appliance.
- Do not use this appliance as a space heater.

DO NOT MODIFY THIS APPLIANCE.

Servicing shall be carried out only by authorised personnel.

The product label, with the serial number, is fixed to the underside of hob.

An additional label should be adhered to adjacent cabinetry for easy access- refer installation instructions.

The manufacturer refuses all responsibility for possible damages to things or people, resulting from incorrect installation or from an improper, incorrect or unreasonable use of this equipment.

INSTRUCTIONS FOR THE USER



It is necessary that all the operations regarding the installation, adjustment and adaptation to the type of gas available are carried out by authorised personnel, in conformity with the regulations in force. The specific instructions are described in the booklet section intended for the installer.

Conditions of Use.

This appliance is intended to be used in household and similar applications such as:

- Staff kitchen areas in shops, offices and other working environments
- Farm Houses
- By clients in hotels, motels and other residential type environments
- Bed and breakfast type environment

USING THE BURNERS

The symbols laser printed on the side of the knob indicate the correspondence between the knob and the burner.

Automatic start-up with valves

Turn the corresponding knob anticlockwise up to the maximum position (large flame, fig.1/1/A) and press the knob.

Once the burner has been started up, keep the knob pressed for about 6 seconds.

ATTENTION: the triple ring (wok) burner switches on only in the maximum flame position

Using the burners

In order to obtain the maximum yield without waste of gas, it is important that the diameter of the pot is suitable for the burner potential (see the following table), so as to avoid that the flame going out (fig. 2).

Use the maximum capacity to quickly make liquids reach boiling temperature, and the reduced capacity to heat food or maintain boiling. All of the operating positions must be chosen between the maximum and the minimum ones, never between the minimum position and the closing point.

The gas supply can be interrupted by turning the knob clockwise up to the closing position. If there is no power supply, it is possible to light the burners with matches, setting the knob to the start-up point (large flame, fig. 1).

BURNERS	Power (MJ/h)		Ø of cookware (*)
	NG	LPG	
Auxiliary	3,4	3,4	10 - 14 cm
Semi-rapid	6,3	5,6	16 - 18 cm
Double crown (wok on 5 burner models)	21,6	21,6	24 - 26 cm
Double crown (wok on 4 burner models)	10,3	9,6	20 - 22 cm

(*) For cookware with diameter 120mm or below use mini-trivet supplied, refer fitment instructions on page 15.

It is important to use cookware with the sizes specified and ensure the cookware is always correctly centred over the burner. Using oversize cookware can potentially cause heat damage to your benchtop and/or control knobs which will not be covered under warranty.

Notice

- When the equipment is not working, always check that the knobs are in the closing position (see fig.1).
- If the flame should blow out accidentally, the safety valve will automatically stop the gas supply, after a few seconds. To restore operation, set the knob to the lighting point (large flame, fig. 1) and press.
- While cooking with fat or oil, pay the utmost attention as these substances can catch fire when overheated.
- Do not place unstable or deformed pots on the burner, so as to prevent them from overturning or overflowing.
- Handles should be turned away from the front of the bench to avoid accidents.
- When the burner is started up, check that the flame is regular and, before taking pots away, always lower the flame or put it out.

INSTRUCTIONS FOR THE USER

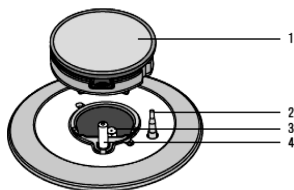

- 1 Burner
2 Flame safeguard sensor
3 Injector
4 Ignition spark plug

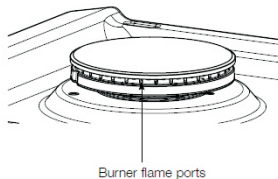

If you have a problem with the cooktop, check the table below. You may be able to solve the problem and this will save you from paying for a service call. You will have to pay for a service call even in the warranty period if the problem is one listed below

FAULT	POSSIBLE CAUSES	REMEDY
Burner will not light even though the sparker is working.	Knob not held down long enough in 'High' position for flame safeguard to engage	Repeat lighting procedure and hold knob down for 6 seconds in 'High' position (refer page 4)
	Gas supply valve turned off	Turn on gas supply to appliance
	Wrong knob turned	Ensure the knob you are turning corresponds to the burner you want to light
	Port blockage in ignition area	Ensure that ports in ignition area are clean and dry
	Ignition spark plugs wet or dirty	Dry or clean ignition spark plugs
	Injector blocked	Ensure the injector remains free of any foreign material. If necessary, use a thin piece of wire to clear the orifice.
No spark is obtained when control knob is activated	Electricity supply is disconnected or switched off	Switch on electricity or check fuses
	Ignition spark plugs wet or dirty	Dry or clean ignition spark plugs
Flames uneven or tending to lift	Flame ports blocked or wet	Clean or dry flame ports
	Burner incorrectly fitted	Ensure this component is fitted correctly
Flames not staying on when knob released	Knob not held down long enough in 'High' position for flame safeguard (where fitted) to engage	Repeat lighting procedure and hold knob down for 6 seconds in 'High' position (refer page 4)
	Knob not set between 'High' and 'Low'	Knob MUST be set between these positions
	Dirt or spillage on flame safeguard sensor (where fitted)	Clean flame safe guard sensor tip
Low heat, slow cooking	Incorrect cooking pot or pan being used	Refer to table page 4
Benchtop or knobs overheating	Incorrect cooking pot or pan used	Check table on page 4 for correct pot or pan to be used
	Pot or pan not located on burner properly	Ensure pot or pan is centrally located on burner
Cooktop stainless steel discoloured	Pot or pan being is too large	Ensure pot sizes used are as per user manual requirements. Some level of discolouration is normal, however it may be reduced by cleaning with Hillmark Steel Power cleaner, available from our AEG web store: https://shop.aegaustralia.com.au/
Outer ring of wok burner goes out when set to low	This is not a failure. This is a function of the dual wok burner to give a very low power flame option	No remedy - burner is functioning as intended

If the above points have been checked and there is still a problem with the cooktop, please call the Service Centre.

INSTRUCTIONS FOR THE USER

CLEANING

Before any operation, disconnect the appliance from the electrical supply.

Don't use a steam cleaner for the cleaning the hob.

It is advisable to clean the appliance when it is cold.

Enamelled parts

The enamelled parts must be washed with a sponge and soapy water or with a light detergent.

Do not use abrasive or corrosive products.

Do not leave substances, such as lemon or tomato juice, salt water, vinegar, coffee and milk on the enamelled surfaces for a long time.

Stainless steel parts

Stainless steel can be stained if it remains in contact with highly alkaline water or aggressive detergents for an extended period of time.

All grades of stainless steel may stain, discolour or attain an adhering layer of grime in normal operation. To achieve optimum surface appearance stainless steel must be kept clean regularly using the following cleaning procedures, this ensuring good performance and long service life.

Wash with warm soapy water and rinse with clean water. Where the stainless steel has become extremely dirty with signs of surface discolouration (due to periods of neglect or misuse) use a stainless steel cleaner. We recommend Hillmark Steel Power cleaner for removing baked on food or stubborn build up and reducing discolouration. Available from <https://shop.aegaustralia.com.au/> DO NOT use abrasive scourers or steel wool. When removing these stains be sure to follow the polish of brushing lines.

Burners and racks

These parts can be removed to make cleaning easier.

The burners must be washed with a sponge and soapy water or with a light detergent, wiped well and placed in their housing perfectly. Make sure that the flame-dividing ducts are not clogged. Check that the feeler of the safety valve and the start-up electrode are always cleaned, so as to ensure optimum operation.

Gas taps

The possible lubrication of the taps must be carried out by authorised personnel, exclusively.

In case of malfunctions of the gas taps call customer service

INSTRUCTIONS FOR THE INSTALLER



Important notice:

The operations indicated below must be followed by authorised personnel exclusively, in conformity with the regulations in force.

The manufacturing firm refuses all responsibility for damages to people, animals or things, resulting from the failure to comply with such provisions.

This appliance shall be installed only by authorised persons and in accordance with the manufacturer's installation instructions, local gas fitting regulations, municipal building codes, electrical wiring regulations, and any other statutory regulations. For Australia and New Zealand this appliance must be installed by an authorised person in compliance with AS/NZS 5601.1 Gas installations part 1: general installations, and AS/NZS 5601.2 Gas installations part 2: LP GAS installations in caravans and boats for nonpropulsive purposes. For outside of Australia/New Zealand refer to the relevant installation code for gas appliances in your country.

INSTALLATION

The installation kit contains the following:

- 1 natural gas regulator
- 1 elbow
- 1 manifold
- 2 fibre sealing washers
- 4 brackets for assembly
- 4 bracket screws
- 1 pack of cooktop to benchtop seals
- 1 duplicate rating label

- For conversion to LPG
- 1 Universal LPG sticker
- 4 or 5 injectors

Additional accessory for cooking with vessels diameter 120mm or below

- 1 mini trivet
- 1 wok trivet

Installing the top

The appliance is designed to be embedded into heat-resistant benchtop capable of withstanding 85°C.

INSTRUCTIONS FOR THE INSTALLER

Adjacent walls, cupboards and protection for combustible materials.

Ensure that the appliance is installed in accordance with clauses 6.2.5 and 6.10.1.1 of AS/NZS 5601.1, or clauses 6.9.1 and 6.9.5 of AS/NZS 5601.2 with regard to clearances to combustible surfaces and materials, and clearances to rangehoods and exhaust fans. Clearance of 200mm from the periphery of burners to vertical combustible surfaces is required. Clearances to combustible surfaces may be reduced only if combustible surfaces are protected in accordance with clause 6.10.1.2 of AS/NZS 5601.1, or clause 6.9.2 of AS/NZS 5601.2.

The equipment must not be installed near inflammable materials, such as curtains, cloths, etc. Make a cut out in the benchtop, with the dimensions indicated in fig.3, at a distance of at least 50 mm from the appliance border to the adjacent walls.

MODEL	L (mm)	P (mm)	D (mm)
HG60FXA	560	480	60
HG75FXB	720	480	60
HG90FXB HG90FX-MB	860	480	60

Rangehoods and exhaust fans* shall be installed in accordance with the manufacturer's relevant instructions. However, in no case shall the clearance between the highest part of the hob of the gas cooking appliance and a range hood be less than 650mm or, for an overhead exhaust fan, 750mm. (*An exhaust fan is defined as a mechanical device other than a rangehood for moving air from one interior space to another, or to outside of the space)

IMPORTANT:

A separation panel at least 10mm from the bottom of the cooktop must be included during installation to prevent access to the underside of the appliance. This panel can be made of any non-combustible rigid material. Refer (fig. 4).

If the hob is going to be installed on the top of an oven, precautions must be taken to guarantee an installation in accordance with current accident prevention standards. Pay particular attention to the position of the electric cable and gas pipe: they must not touch any hot parts of the oven.

Moreover, if the hob is going to be installed on the top of a built in oven without forced cooling ventilation, proper air vents must be installed to guarantee an adequate ventilation, with the lower

air entering with a cross section of at least 200cm², and the higher air exiting with a cross section of at least 60 cm².

Fastening the top

Every cook-top is equipped with a special washer. A set of hooks is also supplied for mounting the cook-top.

Depending on the type of mounting surface, the suitable type of mounting hook is supplied (hook A or hook B).

For the installation proceed as follows:

- Remove all loose components from the top.
- Turn the appliance upside down lay it's edges on foam packaging blocks to prevent damage to the ignition spark plugs and lay the seal S along the external border (fig. 5).
- Introduce and place the cook-top in the hole made in the piece of furniture, then fasten it with the screws and fastening brackets supplied (fig.6).

WARNING: Failure to fix the cooktop to the bench could result in loosening of the gas connection through movement of the cooktop and a gas leak may result.

A duplicate rating label is included with these instructions. Ensure this is attached to a readily accessible surface, so that the cooktop can be easily identified in the case of a service call.

INSTALLATION ROOM

This appliance is not provided with a device for exhausting the products of combustion.

Therefore, it is necessary to discharge these outside.

The room where this appliance is installed must have a natural air inflow, so as to ensure a regular gas combustion and room ventilation: the necessary air volume must not be lower than 20m³.

Air must come from permanent openings made on the room walls that communicate with the outside.

The section of these openings shall correspond to at least 200 cm².

OPERATION ON N.G / S.N.G.

Regulator

An appliance regulator is provided. The regulator must be positioned so that the pressure test nipple is accessible when the appliance is installed. Connect the gas supply to the 1/2" B.S.P. internal thread inlet of the regulator. Refer to page 8 for connection point position.

Regulators are supplied pre-adjusted and configured by the component maker for use with

INSTRUCTIONS FOR THE INSTALLER

Natural Gas. The appliance installer is not required to make an adjustment to obtain the correct outlet pressure setting.

An arrow on the base of the regulator indicates the direction of gas flow when the inlet and outlet of the regulator is orientated correctly. When the regulator has been fitted check for leaks from the connections with soapy water.

Gas Connection

This appliance is supplied for use with Natural Gas. However, it can be converted for use with LPG. Refer to LP conversion chapter.

Supply pipe sizing

The total hourly gas consumption for the appliance is shown on the data label. The required supply pressure (i.e. at inlet to appliance regulator) for each gas type is shown on the data label, and given in page "TECHNICAL CHARACTERISTIC TABLES". Use this information in conjunction with the length of run, number of elbows, tees and bends, the available service pressure and the supply requirements of other installed appliances to determine a suitable pipe size. For assistance in this matter refer to the appropriate section of the Installation Code AS5601.

An AGA certified class B or D flexible connection may be used to connect the cooktop in accordance with the AS5601 and in particular section 4.8. Where a hose assembly is used and the cooktop is in the installed position, the hose assembly shall be suitable for connection to a fixed consumer piping outlet located at a point 800 - 850mm above the floor and in the region outside the width of the appliance to a distance of 250mm. The point of connection to consumer piping must be accessible with appliance installed.

Elbow positioning

It is possible to reposition the elbow if required by loosening the locking nut and elbow by using two spanners. Re-tighten the entire assembly after the elbow has been repositioned. When fitting elbow to appliance, ensure that the sealing washer is fitted.

Regulator

An appliance regulator is provided. The regulator must be positioned so that the pressure test nipple is accessible when the appliance is installed. Connect the gas supply to the ½" B.S.P. internal thread inlet of the regulator (fig.7).

Assembly of Regulator

The assembly of the regulator to the cooktop manifold is achieved via the elbow union and

sealing washers supplied.

The ½" parallel thread connects to the manifold, and the sealing washer is placed between the manifold end and the flat face on the elbow.

The ½" tapered thread connects to the outlet of the regulator, and is sealed on the thread using approved thread sealing tape or approved thread sealing compound.

The inlet of the regulator is a ½" parallel thread and is connected to consumer piping or hose assembly. Regulators are supplied pre-adjusted and configured by the component maker for use with Natural Gas.

The appliance installer is not required to make an adjustment to obtain the correct outlet pressure setting.

An arrow on the base of the regulator indicates the direction of gas flow when the inlet and outlet of the regulator is orientated correctly. When the regulator has been fitted check for leaks from the connections with soapy water.

Checking the gas supply

1. Check the manometer zero point is correct.
2. Connect the manometer to the cooktop pressure point. This is located on the regulator.
3. Turn on the gas supply and electricity and try to ignite the gas. NOTE! It will take additional time to light the gas for the first time as air needs to be purged from the pipes.
4. With the appliance operating check the outlet pressure
 - when all burners of the appliance are operating at maximum,
 - when the smallest burner of the appliance is operating at minimum.

Under these conditions the outlet pressure should not vary from the nominal outlet pressure of 1.00kPa by more than $\pm 0.20\text{kPa}$

If the regulator appears to not perform satisfactorily, then check the following points:

1. If the outlet pressure is consistently too low then the inlet pressure may be too low and adjustment of an upstream regulator may be needed, or an upstream regulator or valve with insufficient flow capacity may be present in the gas supply line. If this is suspected then it may be necessary to repeat the checks whilst measuring both the inlet and outlet pressure to determine if the inlet pressure is in the range 1.13 - 5kPa.
2. Check that the regulator has been fitted to the gas supply line in the correct orientation, the arrow on the base of the body indicates the direction of gas flow.

INSTRUCTIONS FOR THE INSTALLER

Once these checks have been completed, if the regulator still fails to perform in a satisfactory manner it should be replaced.

Electrical connection

The appliance is supplied with a standard 10 Amp service cord terminated by a 3-pin plug for connection to a standard household socket. The electrical supply is required to power the electronic ignition system.

NOTE: It will be necessary for servicing purposes to disconnect the electrical power supply. The power point should therefore be accessible after the appliance is installed, as specified in the local wiring regulations.

TESTING APPLIANCE OPERATION

After installation the installer must fully test the appliance and ensure it operates correctly before handing it over to the customer.

GAS CONVERSIONS AND ADJUSTMENTS

Data Label

This appliance is suitable for Natural Gas and Universal LPG; ensure that the available gas supply matches the Data Label.

When converting from Natural Gas to Universal LPG ensure that the NG regulator is removed and replaced with the Test Point Assembly. An AGA Approved gas regulator suitable for a supply pressure of 2.75kPa should be part of the gas tank supply and the test point pressure should be adjusted to 2.75kPa (fig.7).

Replacing the injectors

If the equipment is adjusted for a type of gas that is different from the one available, it is necessary to replace the burner injectors.

The choice of the injectors to replace must be made according to the table of the "technical characteristics" as enclosed.

Act as follows:

- remove the racks and burners.
- by means of a straight spanner L, unscrew the injectors U (fig.8-8/A) and substitute it with the corresponding one. Please note the wok burner on models HG75FX-M and HG90FX-M has three injectors (refer U1 & U2 of Figure 7/A for positions)
- tighten the injectors strongly.

After changing the injectors, it is necessary to eliminate residual natural gas in the system.

To do this you have to turn to the maximum position then press the knob of each burner and wait few seconds.

Adjusting the burners

The lowest flame point must always be properly adjusted and the flame must remain on even if there is an abrupt shift from the maximum to the minimum position.

If this is not so, it is necessary to adjust the lowest flame point as follows:

- start the burner up
- turn the tap up to the minimum position (small flame)
- remove the knob from the tap rod
- introduce a flat-tip screwdriver in the hole F of the tap (fig.9) and turn the by-pass screw up to a proper adjustment of the lowest flame point.

For the models with triple crown is possible adjust the lowest flame point for the external or internal ring. Is sufficient to turn the screws indicated in fig. 9/A.

As regards U-LPG gas burners, the by-pass screw must be tightened completely.

MAINTENANCE

Maintenance Schedule

No regular maintenance is required for the hotplates except cleaning.

Replacing the power supply cable

If the power supply cable should be replaced, it is necessary to use a cable with a section of 3x0.75mm², type H05VV-F or H05RR-F, complying with the regulations in force.

The connection to the terminal board must be effected as shown in fig.10 - 10/A:

brown cable L	(phase)
blue cable N	(neutral)
green-yellow cable ⊕	(ground)

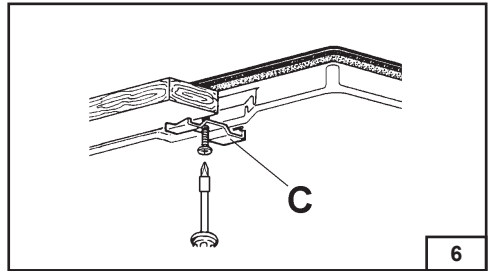
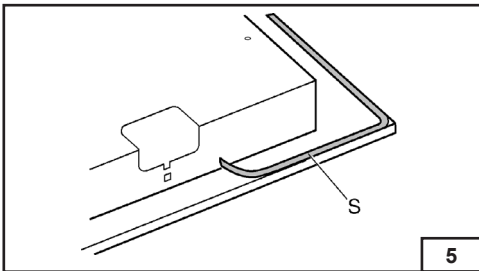
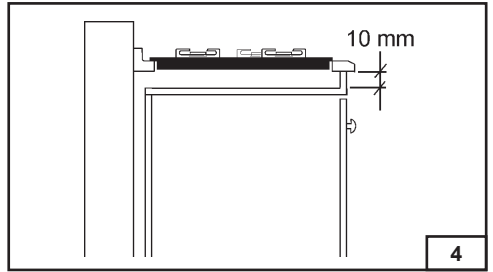
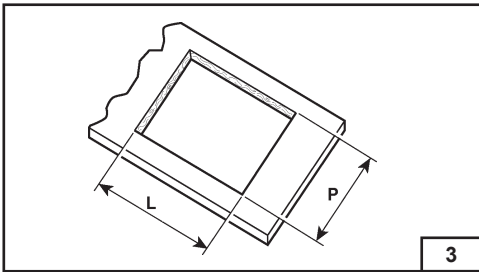
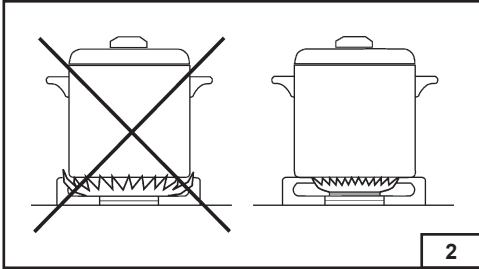
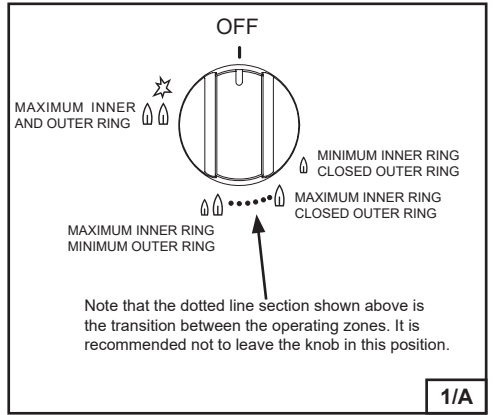
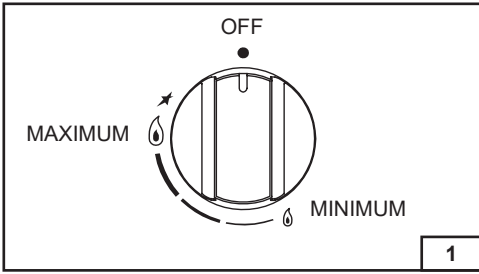

Gas connection for NATURAL GAS

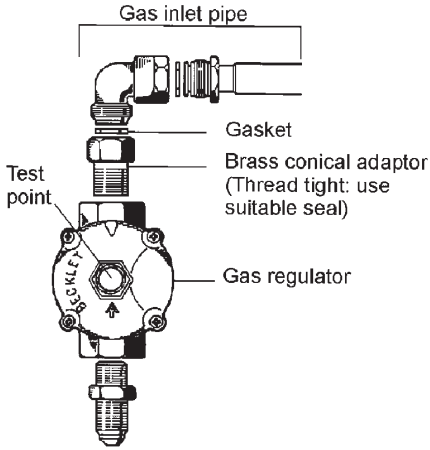

Gas connection for UNIVERSAL LPG

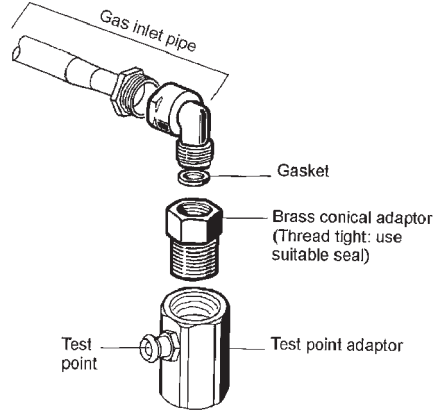

7

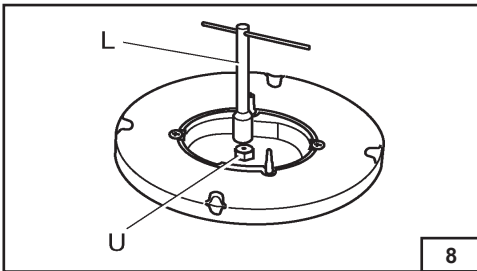

8

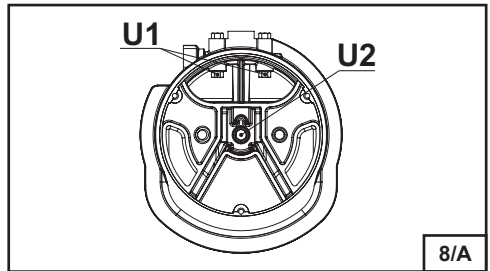

8/A

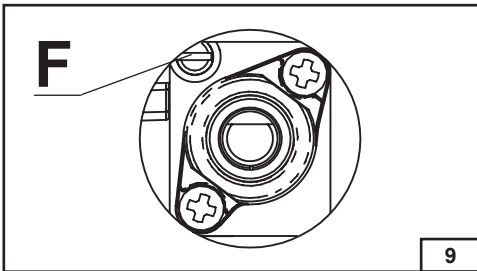

9

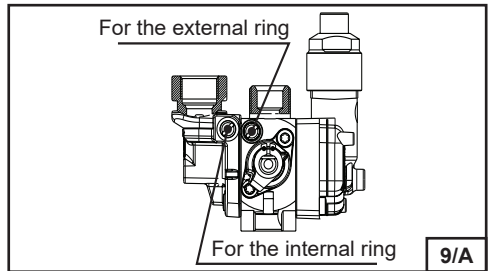

9/A

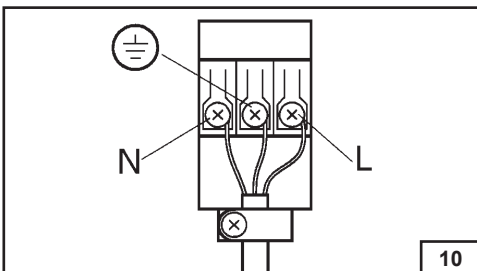

10

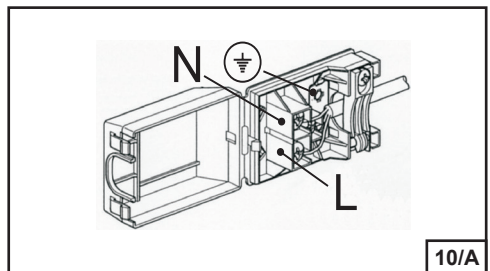

10/A

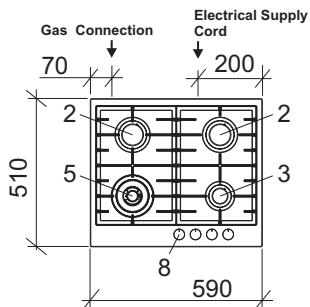

MODEL: HG60FXA

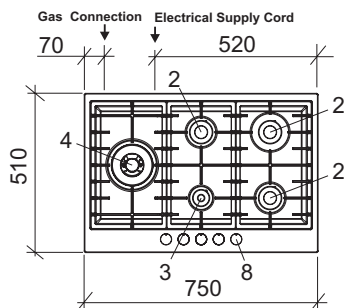

MODEL: HG75FXB

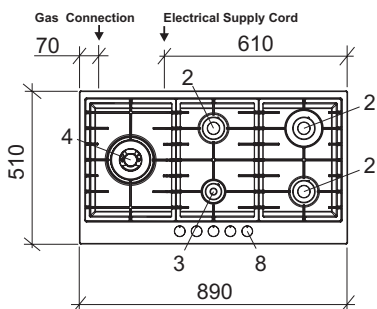

MODEL: HG90FXB
MODEL: HG90FX-MB

- 2 Semi-rapid burner
- 3 Auxiliary burner
- 4 Triple ring burner
- 5 Double ring burner
- 8 Control knob for burner

NG
6.3 MJ/h
3.4 MJ/h
21.6 MJ/h
10.3 MJ/h

Universal LPG
5.6 MJ/h
3.4 MJ/h
21.6 MJ/h
9.6 MJ/h

MODEL	A (mm)	B (mm)
HG60FXA	27	65
HG75FXB	35	60
HG90FXB HG90FX-MB	35	60

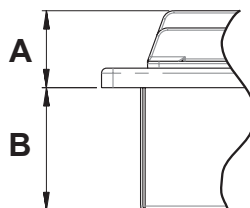

Stainless steel can be stained if it remains in contact with highly alkaline water or aggressive detergents for an extended period of time.

All grades of stainless steel may stain, discolour or attain an adhering layer of grime in normal operation. To achieve optimum surface appearance stainless steel must be kept clean regularly using the following cleaning procedures, this ensuring good performance and long service life.

Wash with warm soapy water and rinse with clean water. Where the stainless steel has become extremely dirty with signs of surface discolouration (due to periods of neglect or misuse) use a stainless steel cleaner. We recommend Hillmark Steel Power cleaner for removing baked on food or stubborn build up and reducing discolouration. Available from <https://shop.ategaaustralia.com.au/> **DO NOT** use abrasive scourers or steel wool. When removing these stains be sure to follow the polish of brushing lines.

Before first use the stainless steel may appear discoloured due to some residual oil which is applied to the hob panel to protect it during transport. This discolouration is not permanent and can be cleaned using a specialist stainless steel cleaning product.

MODEL HG60FXA

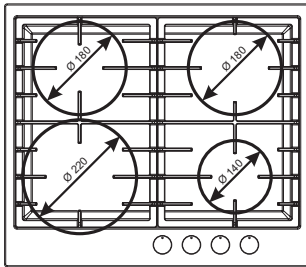

MODEL HG75FXB

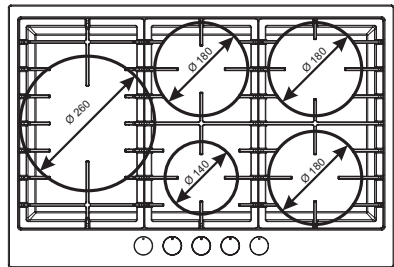

MODEL HG90FXB - HG90FX-MB

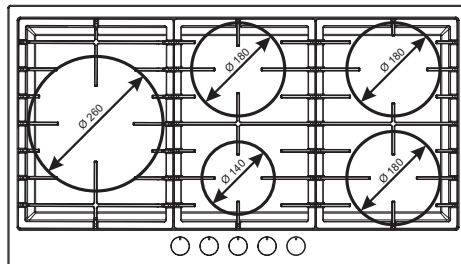

TECHNICAL CHARACTERISTIC TABLES

BURNERS		GAS	NORMAL PRESSURE	INJECTOR DIAMETER	TAPE BY PASS DIAMETER	NOMINAL HEAT INPUT (MJ/h)
N°	DESCRIPTION		KPa	1/100 mm	1/100 mm	
2	SEMI-RAPID	Universal LPG	2.75	65	31	5.6
		Natural	1.00	110	1/2 turn	6.3
3	AUXILIARY	Universal LPG	2.75	52	27	3.4
		Natural	1.00	80	1/4 turn	3.4
4	DOUBLE (WOK) CROWN	Universal LPG	2.75	50 / 83 (x2)	60	21.6
		Natural	1.00	80 / 150 (x2)	1/3 turn inner / 1 turn outer	21.6
5	DOUBLE (WOK) CROWN	Universal LPG	2.75	85	60	9.6
		Natural	1.00	145	Adjust.	10.3

WIRING DIAGRAM

MODEL: HG60FXA

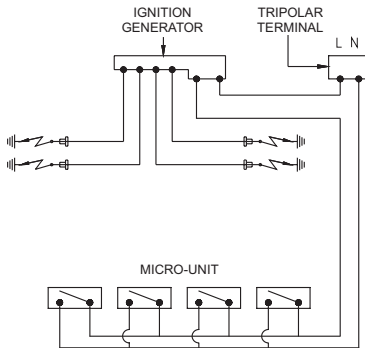

MODEL: HG75FXB / HG90FXB / HG90FX-MB

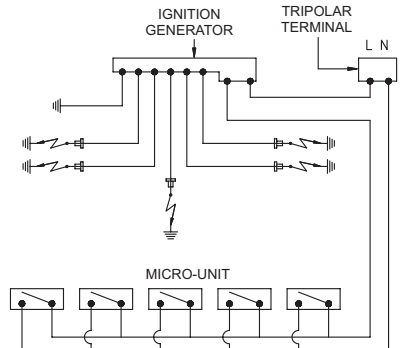

INSTRUCTIONS FOR USING THE MINI TRIVET

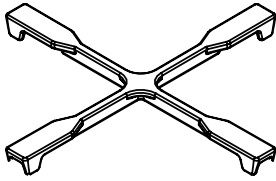

The mini-trivet included with this cooktop is to be used for cooking vessels of diameter 120mm or smaller

Correct fitment

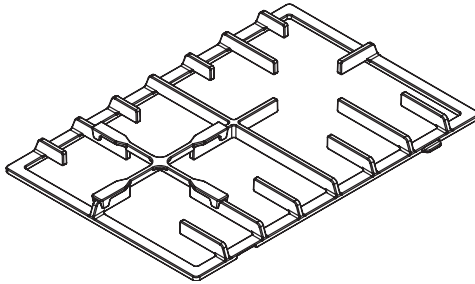

Examples of positioning of mini-trivet

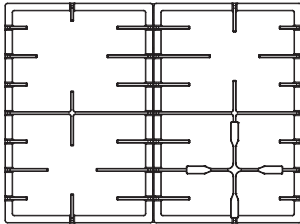

**MODEL:
HG60FXA**

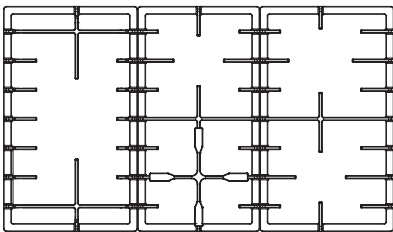

**MODEL:
HG75FXB**

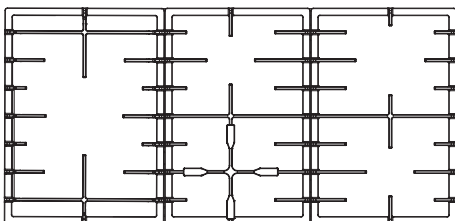

**MODEL:
HG90FXB
HG90FX-MB**

INSTRUCTIONS FOR USING THE WOK TRIVET

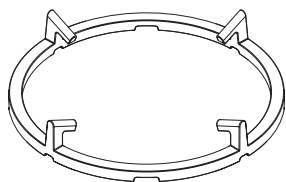

The cast iron wok trivet included with this cooktop is to be used for cooking only the wok burner.

Correct fitment

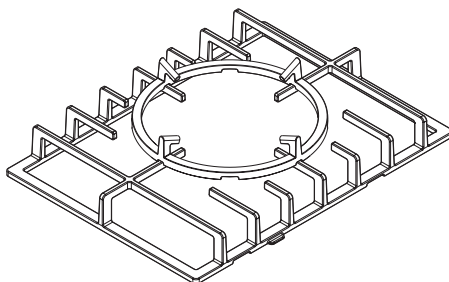

Examples of positioning cast iron wok trivet

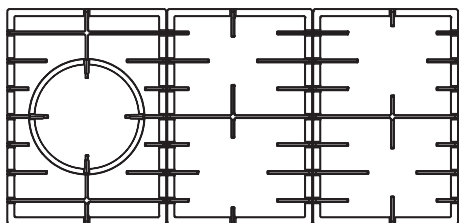

**MODELS:
HG75FXB
HG90FXB
HG90FX-MB**

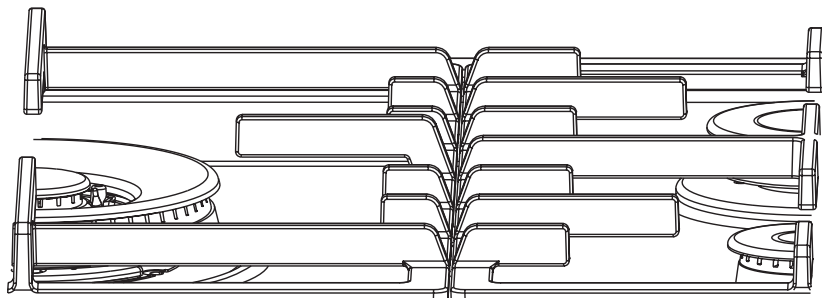

Please note the step of the trivet fingers on the wok burner main trivet. (applicable for models HG75FXB, HG90FXB and HG90FX-MB) To avoid spillages lift and move cooking receptacles to and from this burner rather than sliding across the trivets.

AEG Warranty

FOR SALES IN AUSTRALIA AND NEW ZEALAND
ALL AEG BRANDED APPLIANCES

This document sets out the terms and conditions of the product warranties for AEG Appliances. It is an important document. Please keep it with your proof of purchase documents in a safe place for future reference should there be a manufacturing defect in your Appliance. This warranty is in addition to other rights you may have under the Australian Consumer Law.

1. In this warranty:

- (a) 'ACL' or 'Australian Consumer Law' means Schedule 2 to the Competition and Consumer Act 2010;
- (b) 'Appliance' means any Electrolux product purchased by you and accompanied by this document;
- (c) 'ASC' means Electrolux's authorised serviced centres;
- (d) 'AEG' is the brand controlled by Electrolux Home Products Pty Ltd of 163 O'Riordan Street, Mascot NSW 2020, ABN 51 004 762 341 in respect of Appliances purchased in Australia and Electrolux (NZ) Limited (collectively "Electrolux") of 3-5 Niall Burgess Road, Mount Wellington, in respect of Appliances purchased in New Zealand;
- (e) 'Warranty Period' means the period specified in clause 3 of this warranty;
- (f) 'you' means the purchaser of the Appliance not having purchased the Appliance for re-sale, and 'your' has a corresponding meaning.

2. Application: This warranty only applies to new Appliances, purchased and used in Australia or New Zealand and is in addition to (and does not exclude, restrict, or modify in any way) other rights and remedies under a law to which the Appliances or services relate, including any non-excludable statutory guarantees in Australia and New Zealand.

3. Warranty Period: Subject to these terms and conditions, this warranty continues for in Australia for a period of 60 months and in New Zealand for a period of 60 months, following the date of original purchase of the Appliance.

4. Repair or replace warranty: During the Warranty Period, Electrolux or its ASC will, at no extra charge if your Appliance is readily accessible for service, without special equipment and subject to these terms and conditions, repair or replace any parts which it considers to be defective. Electrolux may, in its absolute discretion, choose whether the remedy offered for a valid warranty claim is repair or replacement. Electrolux or its ASC may use refurbished parts to repair your Appliance. You agree that any replaced Appliances or parts become the property of Electrolux.

5. Travel and transportation costs: Subject to clause 7, Electrolux will bear the reasonable cost of transportation, travel and delivery of the Appliance to and from Electrolux or its ASC. Travel and transportation will be arranged by Electrolux as part of any valid warranty claim.

6. Proof of purchase is required before you can make a claim under this warranty.

7. Exclusions: You may not make a claim under this warranty unless the defect claimed is due to faulty or defective parts or workmanship. This warranty does not cover:

- (a) light globes, batteries, filters or similar perishable parts;
- (b) parts and Appliances not supplied by Electrolux;

- (c) cosmetic damage which does not affect the operation of the Appliance;
- (d) damage to the Appliance caused by:
 - (i) negligence or accident;
 - (ii) misuse or abuse, including failure to properly maintain or service;
 - (iii) improper, negligent or faulty servicing or repair works done by anyone other than an Electrolux authorised repairer or ASC;
 - (iv) normal wear and tear;
 - (v) power surges, electrical storm damage or incorrect power supply;
 - (vi) incomplete or improper installation;
 - (vii) incorrect, improper or inappropriate operation;
 - (viii) insect or vermin infestation;
 - (ix) failure to comply with any additional instructions supplied with the Appliance;

In addition, Electrolux is not liable under this warranty if:

- (a) the Appliance has been, or Electrolux reasonably believes that the Appliance has been, used for purposes other than those for which the Appliance was intended, including where the Appliance has been used for any non-domestic purpose;
- (b) the Appliance is modified without authority from Electrolux in writing;
- (c) the Appliance's serial number or warranty seal has been removed or defaced.

8. How to claim under this warranty: To enquire about claiming under this warranty, please follow these steps:

- (a) carefully check the operating instructions, user manual and the terms of this warranty;
- (b) have the model and serial number of the Appliance available;
- (c) have the proof of purchase (e.g. an invoice) available;
- (d) telephone the numbers shown below.

9. Australia: For Appliances and services provided by Electrolux in Australia: Electrolux goods come with guarantees that cannot be excluded under the Australian Consumer Law. You are entitled to a replacement or refund for a major failure and for compensation for any other reasonably foreseeable loss or damage. You are also entitled to have the Appliance repaired or replaced if the Appliance fails to be of acceptable quality and the failure does not amount to a major failure. 'Acceptable quality' and 'major failure' have the same meaning as referred to in the ACL.

10. New Zealand: For Appliances and services provided by Electrolux in New Zealand, the Appliances come with a guarantee by Electrolux pursuant to the provisions of the Consumer Guarantees Act, the Sale of Goods Act and the Fair Trading Act. Where the Appliance was purchased in New Zealand for commercial purposes the Consumer Guarantee Act does not apply.

11. Confidentiality: You accept that if you make a warranty claim, Electrolux and its agents including ASC may exchange information in relation to you to enable Electrolux to meet its obligations under this warranty.

Important Notice

Before calling for service, please ensure that the steps listed in clause 8 above have been followed.

<p>FOR SERVICE or to find the address of your nearest authorised service centre in Australia PLEASE CALL 1300 363 664 OR EMAIL customercare@aegaustralia.com.au <i>For the cost of a local call (Australia only)</i></p>	<p>SERVICE AUSTRALIA AEG aeg.com/au</p>	<p>FOR SPARE PARTS or to find the address of your nearest spare parts centre in Australia PLEASE CALL 13 13 50 OR EMAIL customercare@aegaustralia.com.au <i>For the cost of a local call (Australia only)</i></p>
<p>FOR SERVICE or to find the address of your nearest authorised service centre in New Zealand PLEASE CALL 0800 234 234 OR EMAIL customercare@electrolux.co.nz <i>(New Zealand only)</i></p>	<p>SERVICE NEW ZEALAND AEG aegnewzealand.co.nz</p>	<p>FOR SPARE PARTS or to find the address of your nearest spare parts centre in New Zealand PLEASE CALL 0800 10 66 20 OR EMAIL customercare@electrolux.co.nz <i>(New Zealand only)</i></p>

AEG_Warr_May17

www.aeg.com/shop



AEG

Free Manuals Download Website

<http://myh66.com>

<http://usermanuals.us>

<http://www.somanuals.com>

<http://www.4manuals.cc>

<http://www.manual-lib.com>

<http://www.404manual.com>

<http://www.luxmanual.com>

<http://aubethermostatmanual.com>

Golf course search by state

<http://golfingnear.com>

Email search by domain

<http://emailbydomain.com>

Auto manuals search

<http://auto.somanuals.com>

TV manuals search

<http://tv.somanuals.com>