

▶ RKE64021DW
RKE64021DX

EN **User Manual**
Refrigerator

USER MANUAL



AEG

CONTENTS

1. SAFETY INFORMATION.....	2
2. SAFETY INSTRUCTIONS.....	4
3. INSTALLATION.....	6
4. OPERATION.....	7
5. DAILY USE.....	9
6. CARE AND CLEANING.....	9
7. TROUBLESHOOTING.....	10
8. TECHNICAL DATA.....	12

FOR PERFECT RESULTS

Thank you for choosing this AEG product. We have created it to give you impeccable performance for many years, with innovative technologies that help make life simpler - features you might not find on ordinary appliances. Please spend a few minutes reading to get the very best from it.

Visit our website for:



Get usage advice, brochures, trouble shooter, service information:

www.aeg.com/webselfservice



Register your product for better service:

www.registeraeg.com



Buy Accessories, Consumables and Original spare parts for your appliance:

www.aeg.com/shop

CUSTOMER CARE AND SERVICE

Always use original spare parts.

When contacting our Authorised Service Centre, ensure that you have the following data available: Model, PNC, Serial Number.

The information can be found on the rating plate.

 Warning / Caution-Safety information

 General information and tips

 Environmental information

Subject to change without notice.

1. SAFETY INFORMATION

Before the installation and use of the appliance, carefully read the supplied instructions. The manufacturer is not responsible for any injuries or damage that are the result of incorrect installation or usage. Always keep the instructions in a safe and accessible location for future reference.

1.1 Children and vulnerable people safety

- This appliance can be used by children aged from 8 years and above and persons with reduced physical, sensory or mental capabilities or lack of experience and knowledge if they have been given supervision or instruction concerning the use of the appliance in a safe way and understand the hazards involved.
- This appliance may be used by children between 3 and 8 years of age and persons with very extensive and complex disabilities, if they have been properly instructed.
- Children of less than 3 years of age should be kept away from the appliance unless continuously supervised.
- Do not let children play with the appliance.
- Children shall not carry out cleaning and user maintenance of the appliance without supervision.
- Keep all packaging away from children and dispose of it appropriately.

1.2 General Safety

- This appliance is intended to be used in household and similar applications such as:
 - Farm houses; staff kitchen areas in shops, offices and other working environments
 - By clients in hotels, motels, bed and breakfast and other residential type environments
- **WARNING:** Keep ventilation openings, in the appliance enclosure or in the built-in structure, clear of obstruction.
- **WARNING:** Do not use mechanical devices or other means to accelerate the defrosting process, other than those recommended by the manufacturer.
- **WARNING:** Do not damage the refrigerant circuit.
- **WARNING:** Do not use electrical appliances inside the food storage compartments of the appliance, unless

they are of the type recommended by the manufacturer.

- Do not use water spray and steam to clean the appliance.
- Clean the appliance with a moist soft cloth. Only use neutral detergents. Do not use abrasive products, abrasive cleaning pads, solvents or metal objects.
- Do not store explosive substances such as aerosol cans with a flammable propellant in this appliance.
- If the supply cord is damaged, it must be replaced by the manufacturer, its Authorised Service Centre or similarly qualified persons in order to avoid a hazard.

2. SAFETY INSTRUCTIONS

2.1 Installation



WARNING!

Only a qualified person must install this appliance.

- Remove all the packaging.
- Do not install or use a damaged appliance.
- Follow the installation instructions supplied with the appliance.
- Always take care when moving the appliance as it is heavy. Always use safety gloves and enclosed footwear.
- Make sure the air can circulate around the appliance.
- At first installation or after reversing the door wait at least 4 hours before connecting the appliance to the power supply. This is to allow the oil to flow back in the compressor.
- Before carrying out any operations on the appliance (e.g. reversing the door), remove the plug from the power socket.
- Do not install the appliance close to radiators or cookers, ovens or hobs.
- Do not expose the appliance to the rain.
- Do not install the appliance where there is direct sunlight.
- Do not install this appliance in areas that are too humid or too cold.

- When you move the appliance, lift it by the front edge to avoid scratching the floor.

2.2 Electrical connection



WARNING!

Risk of fire and electric shock.



WARNING!

When positioning the appliance, ensure the supply cord is not trapped or damaged.



WARNING!

Do not use multi-plug adapters and extension cables.

- The appliance must be earthed.
- Make sure that the parameters on the rating plate are compatible with the electrical ratings of the mains power supply.
- Always use a correctly installed shockproof socket.
- Make sure not to cause damage to the electrical components (e.g. mains plug, mains cable, compressor). Contact the Authorised Service Centre or an electrician to change the electrical components.

- The mains cable must stay below the level of the mains plug.
- Connect the mains plug to the mains socket only at the end of the installation. Make sure that there is access to the mains plug after the installation.
- Do not pull the mains cable to disconnect the appliance. Always pull the mains plug.

2.3 Use



WARNING!

Risk of injury, burns, electric shock or fire.



The appliance contains flammable gas, isobutane (R600a), a natural gas with a high level of environmental compatibility. Be careful not to cause damage to the refrigerant circuit containing isobutane.

- Do not change the specification of this appliance.
- Do not put electrical appliances (e.g. ice cream makers) in the appliance unless they are stated applicable by the manufacturer.
- If damage occurs to the refrigerant circuit, make sure that there are no flames and sources of ignition in the room. Ventilate the room.
- Do not let hot items to touch the plastic parts of the appliance.
- Do not store flammable gas and liquid in the appliance.
- Do not put flammable products or items that are wet with flammable products in, near or on the appliance.
- Do not touch the compressor or the condenser. They are hot.

2.4 Internal lighting



WARNING!

Risk of electric shock.

- The type of lamp used for this appliance is for household appliances only. Do not use it for house lighting.

2.5 Care and cleaning



WARNING!

Risk of injury or damage to the appliance.

- Before maintenance, deactivate the appliance and disconnect the mains plug from the mains socket.
- This appliance contains hydrocarbons in the cooling unit. Only a qualified person must do the maintenance and the recharging of the unit.
- Regularly examine the drain of the appliance and if necessary, clean it. If the drain is blocked, defrosted water collects in the bottom of the appliance.

2.6 Service

- To repair the appliance contact the Authorised Service Centre.
- Use original spare parts only.

2.7 Disposal



WARNING!

Risk of injury or suffocation.

- Disconnect the appliance from the mains supply.
- Cut off the mains cable and discard it.
- Remove the door to prevent children and pets to be closed inside of the appliance.
- The refrigerant circuit and the insulation materials of this appliance are ozone-friendly.
- The insulation foam contains flammable gas. Contact your municipal authority for information on how to discard the appliance correctly.
- Do not cause damage to the part of the cooling unit that is near the heat exchanger.

3. INSTALLATION



WARNING!
Refer to Safety chapters.

3.1 Positioning

This appliance can be installed in a dry, well ventilated indoor where the ambient temperature corresponds to the climate class indicated on the rating plate of the appliance:

Climate class	Ambient temperature
SN	+10°C to + 32°C
N	+16°C to + 32°C
ST	+16°C to + 38°C
T	+16°C to + 43°C

3.2 Electrical Connection



CAUTION!
Any electrical work required to install this appliance should be carried out by a qualified electrician or competent person.



WARNING!
This appliance must be earthed. The manufacturer declines any liability should these safety measures not be observed.

The wires in the mains lead are coloured in accordance with the following code:

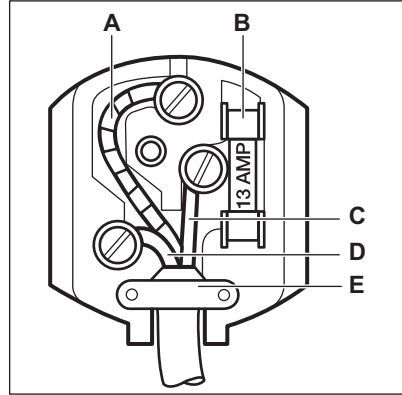

- **A** - green and yellow: Earth
- **C** - brown: Live
- **D** - blue: Neutral

As the colours of the wires in the mains lead of this appliance may not correspond with the coloured markings identifying the terminals in your plug, proceed as follows:

1. Connect the wire coloured green and yellow to the terminal marked either with the letter "E" or by the earth symbol \oplus or coloured green and yellow.
2. Connect the wire coloured blue to the terminal either marked with the letter "N" or coloured black.
3. Connect the wire coloured brown to the terminal either marked with the "L" or coloured red.
4. Check that no cut, or stray strands of wire is present and the cord clamp (**E**) is secure over the outer sheath. Make sure the electricity supply voltage is the same as that indicated on the appliance rating plate.
5. Switch on the appliance.

The appliance is supplied with a 13 amp fuse (**B**). In the event of having to change the fuse in the plug supplied, a 13 amp ASTA approved (BS 1362) fuse must be used.



WARNING!

A cut off plug inserted into a 13 amp socket is a serious safety (shock) hazard. Ensure that it is disposed of safely.

3.3 Installation of the appliance and door reversal

- i** Please refer to separate instructions on installation (ventilation requirements, levelling) and door reversal.

4. OPERATION

4.1 Control panel

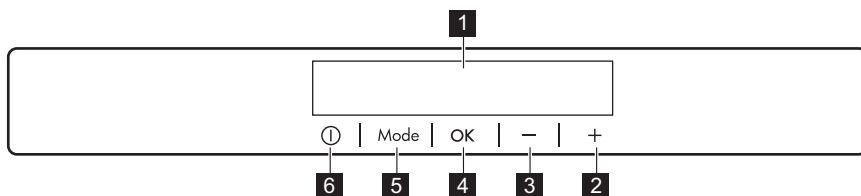

- | | |
|------------------------------------|-----------------|
| 1 Display | 5 Mode |
| 2 Temperature warmer button | 6 ON/OFF |
| 3 Temperature colder button | |
| 4 OK | |

It is possible to change the predefined sound of buttons by pressing together

Mode and Temperature colder button for some seconds. Change is reversible.

Display

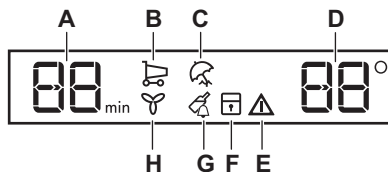

- | | |
|---------------------------------|--------------------------------|
| A. Timer function | F. ChildLock function |
| B. COOLMATIC function | G. DrinksChill function |
| C. Holiday function | H. DYNAMICAIR function |
| D. Temperature indicator | |
| E. Alarm indicator | |

4.2 Switching on

1. Connect the mains plug to the power socket.
2. Press the appliance ON/OFF if the display is off.

The temperature indicators show the set default temperature.

To select a different set temperature refer to "Temperature regulation".

If "dEMo" appears on the display, refer to "Troubleshooting" chapter.

4.3 Switching off

1. Press ON/OFF for a few seconds. The display switches off.
2. Disconnect the mains plug from the power socket.

4.4 Temperature regulation

The set temperature of the fridge may be adjusted by pressing the temperature button.

Default temperature:

- +5°C for the fridge

The temperature indicator shows the set temperature.

-  The set temperature will be reached within 24 hours. After a power failure the set temperature remains stored.

4.5 COOLMATIC function

If you need to insert a large amount of warm food, for example after doing grocery shopping, we suggest activating the COOLMATIC function to chill the products more rapidly and to avoid warming the other food which is already in the refrigerator.

1. Press Mode button repeatedly until COOLMATIC icon flashes.
2. Press OK button to confirm your selection.

The COOLMATIC indicator is displayed.

-  This function deactivates automatically after 6 hours. To switch off the function before its automatic end, repeat the steps until the COOLMATIC indicator disappears.

4.6 Holiday function

This function allows you to keep the refrigerator closed and empty during a long holiday period without the formation of a bad smell.

-  Empty the fridge compartment before turning the Holiday function on.

1. Press the Mode until the Holiday indicator icon appears. The Holiday icon flashes. The fridge temperature indicator shows the set temperature.
2. Press the OK to confirm. The Holiday icon appears. To turn off the Holiday function, repeat the procedure until the Holiday indicator icon goes off.

4.7 Door open alarm

An acoustic alarm will sound if the door is left open for a few minutes. The door open alarm conditions are indicated by:

- a flashing Alarm indicator;
- an acoustic buzzer.

When normal conditions are restored (door closed), the alarm will stop. The buzzer can also be switched off by pressing any button.

4.8 DrinksChill function

Use this function to set an acoustic alarm at the preferred time for example when a recipe requires to cool down food products for a certain length of time.

1. Press Mode until the corresponding icon appears. The DrinksChill indicator flashes. The Timer shows the set value (30 minutes) for a few seconds.
2. Press the Temperature colder or Temperature warmer button to change the Timer set value from 1 to 90 minutes.
3. Press OK to confirm. The DrinksChill indicator is displayed. The Timer starts to flash (min). It is possible to change the time at any time during the countdown and at the end by pressing the Temperature colder button and the Temperature warmer button.

At the end of the countdown, the DrinksChill indicator flashes and an alarm sounds. Press OK to switch off the sound and deactivate the function.

It is possible to deactivate the function at any time during the countdown by repeating the function steps, until the indicator disappears.

4.9 ChildLock function

Activate the ChildLock function to lock the buttons from unintentional operation.

1. Press Mode until the corresponding icon appears.
The ChildLock indicator flashes.
2. Press OK to confirm.
The ChildLock indicator is shown.
To deactivate the ChildLock function, repeat the procedure until the ChildLock indicator goes off.

4.10 DYNAMICAIR function

1. Press Mode until the corresponding icon appears.

The DYNAMICAIR indicator flashes.
2. Press OK to confirm.
The DYNAMICAIR indicator is shown.



The activation of the DYNAMICAIR function increases energy consumption.
If the function is activated automatically, the DYNAMICAIR indicator is not shown (refer to "Daily use").

To switch off the function, repeat the steps until the DYNAMICAIR indicator goes off.

5. DAILY USE



WARNING!
Refer to Safety chapters.

5.1 Storing food in a fridge compartment

Cover or wrap the food, particularly if it has a strong flavour.

Position the food so that air can circulate freely around it.

Keep the food on all shelves no closer than 20 mm from the rear wall and 15 mm from the door.

5.2 DYNAMICAIR

The refrigerator compartment is equipped with a device that allows rapid cooling of food and keeps a more uniform temperature in the compartment.

This device activates automatically when needed, for example when the temperature inside the appliance is high.

It is possible to switch on the device manually when needed (refer to "DYNAMICAIR function").

6. CARE AND CLEANING



WARNING!
Refer to Safety chapters.

6.1 Cleaning the interior

Before using the appliance for the first time, the interior and all internal accessories should be washed with lukewarm water and some neutral soap to remove the typical smell of a brand-new product, then dried thoroughly.



CAUTION!
Do not use detergents, abrasive powders, chlorine or oil-based cleaners as they will damage the finish.

6.2 Periodic cleaning



CAUTION!
Do not pull, move or damage any pipes and/or cables inside the appliance.



CAUTION!
Do not damage the cooling system.

The equipment has to be cleaned regularly:

1. Clean the inside and accessories with lukewarm water and some neutral soap.
2. Regularly check the door seals and wipe them clean to ensure they are clean and free from debris.
3. Rinse and dry thoroughly.
4. If accessible, clean the condenser and the compressor at the back of the appliance with a brush. This will improve the performance of the appliance and save electricity consumption.

6.3 Defrosting of the refrigerator

Frost is automatically eliminated from the evaporator of the refrigerator compartment every time the motor compressor stops during normal use.

It is important to periodically clean the defrost water drain hole in the middle of the refrigerator compartment channel to prevent the water overflowing and dripping onto the food inside.

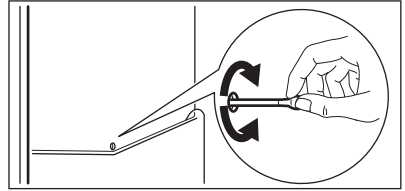

6.4 Periods of non-operation

When the appliance is not in use for long periods, take the following precautions:

1. Disconnect the appliance from electricity supply.
2. Remove all food.
3. Clean the appliance and all accessories.
4. Leave the door/doors open to prevent unpleasant smells.

7. TROUBLESHOOTING



WARNING!
Refer to Safety chapters.

7.1 What to do if...

Problem	Possible cause	Solution
The appliance is noisy.	The appliance is not supported properly.	Check if the appliance stands stable.
Audible or visual alarm is on.	The cabinet has been recently switched on or the temperature is still too high.	Refer to "Door Open Alarm/Indicator" or "High Temperature Alarm/Indicator".
	The temperature in the appliance is too high.	Refer to "Door Open Alarm/Indicator" or "High Temperature Alarm/Indicator".

Problem	Possible cause	Solution
A square symbol is shown instead of numbers on the temperature display.	Temperature sensor problem.	Contact the nearest Authorised Service Centre (the cooling system will continue to keep food products cold, but temperature adjustment will not be possible).
The lamp does not work.	The lamp is in stand-by mode.	Close and open the door.
	The lamp is defective.	Contact the nearest Authorised Service Centre.
The compressor operates continually.	Temperature is set incorrectly.	Refer to "Operation"/"Control Panel" chapter.
	Many food products were put in at the same time.	Wait a few hours and then check the temperature again.
	The room temperature is too high.	Refer to climate class chart on the rating plate.
	Food products placed in the appliance were too warm.	Allow food products to cool to room temperature before storing.
	The COOLMATIC function is switched on.	Refer to "COOLMATIC function".
The compressor does not start immediately after pressing the COOLMATIC or after changing the temperature.	This is normal, no error has occurred.	The compressor starts after some time.
Water flows inside the refrigerator.	The water outlet is clogged.	Clean the water outlet.
	Food products prevent water from flowing into the water collector.	Make sure that food products do not touch the rear plate.
Water flows on the floor.	The melting water outlet is not connected to the evaporative tray above the compressor.	Attach the melting water outlet to the evaporative tray.
Temperature cannot be set.	The FROSTMATIC or COOLMATIC function is switched on.	Switch off FROSTMATIC or COOLMATIC manually, or wait until the function resets automatically to set the temperature. Refer to "FROSTMATIC or COOLMATIC function".

Problem	Possible cause	Solution
DEMO appears on the display.	The appliance is in demonstration mode.	Keep the OK pressed for approximately 10 seconds until a long sound is heard and display shuts off for a short time.
The temperature in the appliance is too low/too high.	The temperature regulator is not set correctly.	Set a higher/lower temperature.
	The food products temperature is too high.	Let the food products temperature decrease to room temperature before storage.
	Many food products were stored at the same time.	Store less food products at the same time.
	The COOLMATIC function is switched on.	Refer to "COOLMATIC function".
There is too much condensed water on the rear wall of the refrigerator.	Door was opened too frequently.	Open the door only when necessary.
	Door was not closed completely.	Make sure the door is closed completely.
	Stored food was not wrapped.	Wrap food in suitable packaging before storing it in the appliance.
Door does not open easily.	You attempted to re-open the door immediately after closing.	Wait a few seconds between closing and re-opening of the door.



If the advice does not lead to the desired result, contact the nearest Authorised Service Centre.

Only service is allowed to replace the lighting device. Contact your Authorised Service Centre.

7.2 Replacing the lamp

The appliance is equipped with a longlife LED interior light.

8. TECHNICAL DATA

8.1 Product information sheet

Trade Mark	AEG
Model	RKE64021DW 925052129 RKE64021DX 925052130

Category	1. Refrigerator with one or more fresh-food storage compartments
Energy efficiency class	A++
Energy consumption in kWh per year, based on standard test results for 24 hours. The actual energy consumption will depend on how the appliance is used and where it is located	116
Storage volume in litres, Fridge	387
Storage volume in litres, Star	-
Storage volume in litres, Cellar zone	-
Storage volume in litres, Wine	-
Storage volume in litres, Total	387
Storage volume in litres, Freezer	-
Storage volume in litres, Chiller	-
Storage volume in litres, Other compartments	-
Star rating of freezer compartment with highest storage volume (l)	None
Design temperature of other compartments > 14 °C (°C), if any	-
Frost free (Y/N), Fridge	No
Frost free (Y/N), Freezer	-
Power cut safe in h	-
Freezing capacity in kg/24h	-
Climate class	SN-N-ST-T
Lowest ambient temperature at which this appliance is intended to be used, in °C	10
Highest ambient temperature at which this appliance is intended to be used, in °C	43
Acoustical noise emissions dB(A) re1 pW	39
Built in appliance Y/N	No
This appliance is intended to be used exclusively for the storage of wine Y/N	No

8.2 Additional technical data

Height	1850 mm	Width	595 mm
		Depth	668 mm

Voltage	230 - 240 V
Frequency	50 Hz

The technical information is situated in the rating plate, on the external or internal side of the appliance and on the energy label.

9. ENVIRONMENTAL CONCERNS

Recycle materials with the symbol . Put the packaging in relevant containers to recycle it. Help protect the environment and human health by recycling waste of electrical and electronic appliances. Do not dispose of

appliances marked with the symbol  with the household waste. Return the product to your local recycling facility or contact your municipal office.

www.aeg.com/shop



280158460-A-392019



AEG

Free Manuals Download Website

<http://myh66.com>

<http://usermanuals.us>

<http://www.somanuals.com>

<http://www.4manuals.cc>

<http://www.manual-lib.com>

<http://www.404manual.com>

<http://www.luxmanual.com>

<http://aubethermostatmanual.com>

Golf course search by state

<http://golfingnear.com>

Email search by domain

<http://emailbydomain.com>

Auto manuals search

<http://auto.somanuals.com>

TV manuals search

<http://tv.somanuals.com>