

## MFC-7840W



Before you can use the machine, you must set up the hardware and install the driver. Please read this 'Quick Setup Guide' for proper set up and installation instructions.

**STEP 1**

Setting Up the Machine

**STEP 2**





Installing the Driver &amp; Software

**Setup is Complete!**

Keep this 'Quick Setup Guide' and the supplied CD-ROM in a convenient place for quick and easy reference at all times.

To view the Quick Setup Guide in other languages, please visit <http://solutions.brother.com/>.

## Symbols used in this guide

 Warning	 Caution	 Improper Setup
<p>Warnings tell you what to do to prevent possible personal injury.</p>	<p>Cautions specify procedures you must follow or avoid to prevent possible damage to the machine or other objects.</p>	<p>Improper Setup icons alert you to devices and operations that are not compatible with the machine.</p>
 Note	 User's Guide, Software User's Guide or Network User's Guide	
<p>Notes tell you how you should respond to a situation that may arise or give tips about how the current operation works with other features.</p>	<p>Indicates reference to the User's Guide, Software User's Guide or Network User's Guide which is on the CD-ROM we have supplied.</p>	

## Getting Started

---

Carton components .....	2
Control panel .....	3

## STEP 1 – Setting Up the Machine

---

Installing the drum unit and toner cartridge assembly .....	4
Loading paper in the paper tray .....	5
Install the power cord and phone line .....	6
Selecting your language .....	7
Setting the LCD contrast .....	7
Setting the date and time .....	7
Setting your station ID .....	8
Choosing the correct Receive Mode .....	9
Tone and pulse dialing mode (Canada only) .....	10
Dial Prefix .....	10
Sending in the product registration and test sheet (USA only) .....	11

## STEP 2 – Installing the Driver & Software

---

### Windows®

For USB Interface Cable Users (For Windows® 2000 Professional/XP/XP Professional x64 Edition/Windows Vista®) .....	14
For Wired Network Interface Users (For Windows® 2000 Professional/XP/XP Professional x64 Edition/Windows Vista®) .....	17
For Wireless Network Interface Users (For Windows® 2000 Professional/XP/XP Professional x64 Edition/Windows Vista®) in infrastructure mode .....	20
For Windows Server® 2003, see the Network User's Guide on the CD-ROM.	

### Macintosh®

For USB Interface Cable Users .....	29
For Mac OS® X 10.2.4 or greater .....	29
For Wired Network Interface Users .....	31
For Mac OS® X 10.2.4 or greater .....	31
For Wireless Network Interface Users (For Mac OS® X 10.2.4 or greater) in infrastructure mode .....	34

## For Network Users

---

BRAdmin Light utility (For Windows® users) .....	43
Installing the BRAdmin Light configuration utility .....	43
Setting your IP address, Subnet Mask and Gateway using BRAdmin Light .....	43
BRAdmin Light utility (For Mac OS® X users) .....	44
Setting your IP address, Subnet Mask and Gateway using BRAdmin Light .....	44
Web Based Management (web browser) .....	45
Restoring the network settings to factory default .....	45
Print the Network Configuration List .....	45
Entering text .....	46

## Consumables and Options

---

Consumables .....	47
-------------------	----

## Carton components

Carton components may vary from one country to another.



Save all packing materials and the carton in case for any reason you must ship your machine.

### Warning

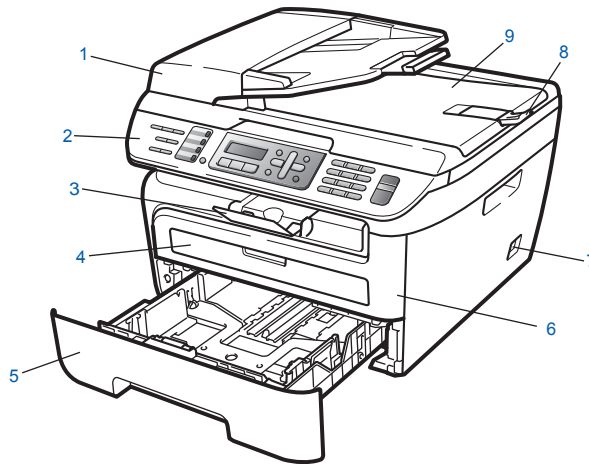
Plastic bags are used in the packaging of your machine. To avoid danger of suffocation, keep these bags away from babies and children.

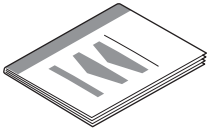
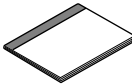
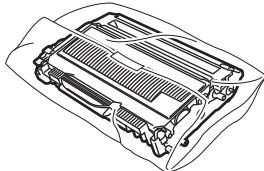
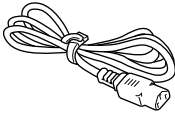

- |                                   |                                    |
|-----------------------------------|------------------------------------|
| 1 Automatic Document Feeder (ADF) | 6 Front Cover                      |
| 2 Control Panel                   | 7 Power Switch                     |
| 3 Face-down Output Tray Support   | 8 ADF Document Output Support Flap |
| 4 Manual Feed Slot                | 9 Document Cover                   |
| 5 Paper Tray                      |                                    |

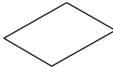
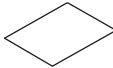
 <p><b>CD-ROMs</b> For Windows® For Macintosh®</p>	 <p><b>Quick Setup Guide</b></p>	 <p><b>User's Guide</b></p>	 <p><b>Drum Unit Assembly</b> (including Starter Toner Cartridge)</p>
 <p><b>AC Power Cord</b></p>	 <p><b>Telephone line Cord</b></p>	 <p><b>Test Sheet (USA only)</b></p>	 <p><b>Accessory Order Form</b></p>

The interface cable is not a standard accessory. Please purchase the appropriate interface cable for the interface you intend to use (USB or Network). Do NOT connect the interface cable at this time. Connecting the interface cable is done during the software installation process.

- **USB interface cable**  
Please make sure you use a USB 2.0 interface cable that is no longer than 6 feet (2 meters). When you use a USB cable, make sure you connect it to the USB port of your computer and not to a USB port on a keyboard or non-powered USB hub.
- Your machine has a USB interface that is compatible with the USB 2.0 specification. This interface is also compatible with Hi-Speed USB 2.0; however, the maximum data transfer rate will be 12 Mbits/s. The machine can also be connected to a computer that has a USB 1.1 interface.
- **Network cable**  
Use a straight-through Category5 (or greater) twisted-pair cable for 10BASE-T or 100BASE-TX Fast Ethernet Network.

## Control panel

### MFC-7840W

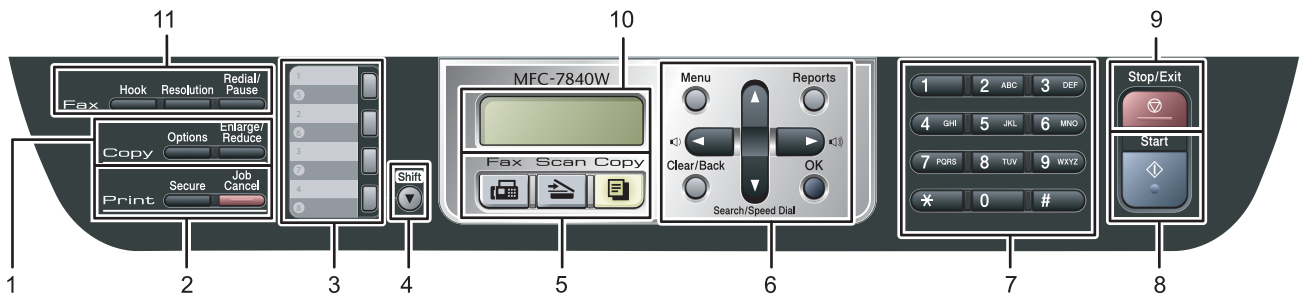

- |                  |                                 |
|------------------|---------------------------------|
| 1 Copy keys      | 7 Dial Pad                      |
| 2 Print keys     | 8 Start key                     |
| 3 One Touch keys | 9 Stop/Exit key                 |
| 4 Shift key      | 10 LCD (Liquid Crystal Display) |
| 5 Mode keys      | 11 Fax and Telephone keys       |
| 6 Menu keys      |                                 |

 For the details of the control panel, see *Control panel overview* in Chapter 1 of the User's Guide.

### Note

When you move the machine, grasp the side handholds that are under the scanner. Do NOT carry the MFC by holding it at the bottom.

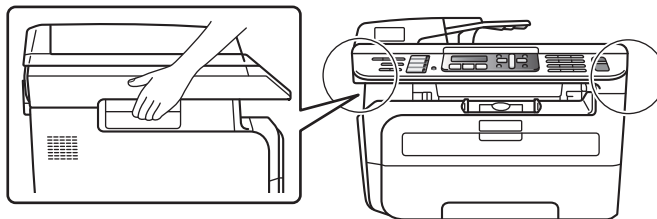

## 1 Installing the drum unit and toner cartridge assembly

### ⊘ Improper Setup

**DO NOT** connect the interface cable.  
Connecting the interface cable is done when installing the driver.

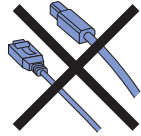

### 1 Open the front cover.

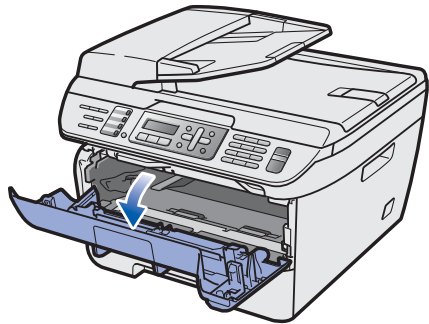

### 2 Unpack the drum unit and toner cartridge assembly.

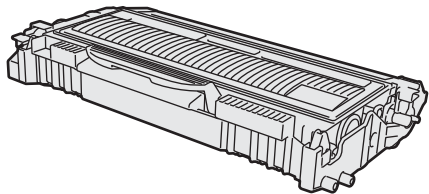

### 3 Rock it from side to side several times to distribute the toner evenly inside the assembly.

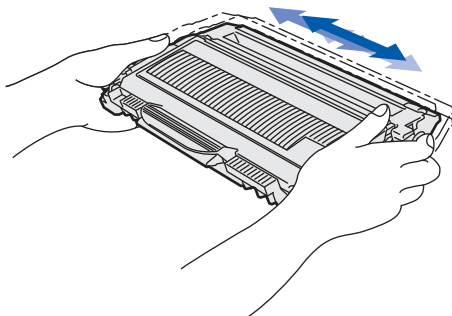

### 4 Put the drum unit and toner cartridge assembly into the machine.

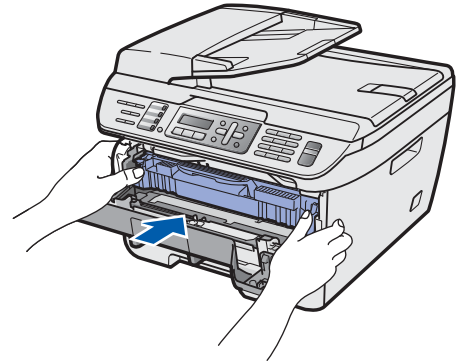
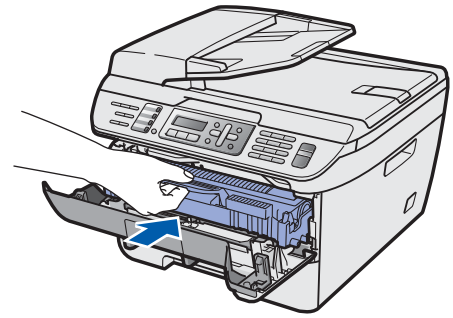

### 5 Close the front cover of the machine.

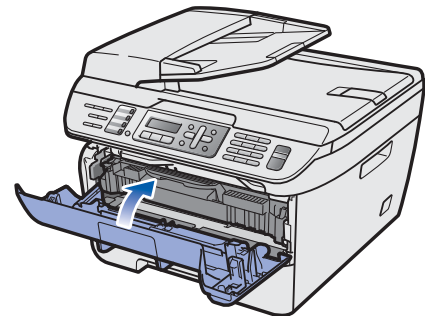

## 2 Loading paper in the paper tray

- 1 Pull the paper tray completely out of the machine.

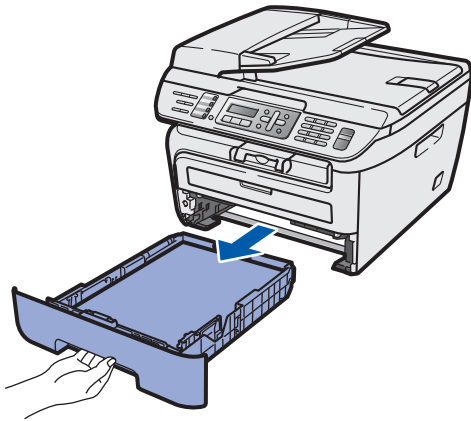

- 2 While pressing the green paper-guide release lever, slide the paper guides to fit the paper size you are using. Make sure that the guides are firmly in the slots.

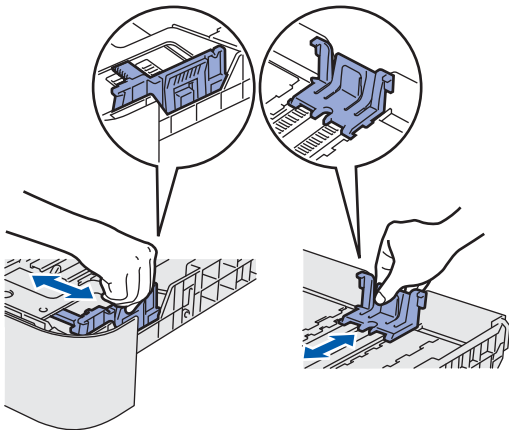

### Note

For Legal size paper, press the release button in the bottom of paper tray and pull out the back of the paper tray. (Legal size paper is not available in some regions.)

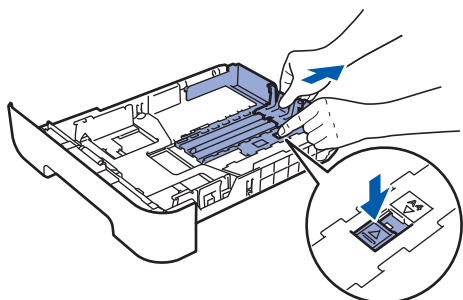

- 3 Fan the stack of paper well to avoid paper jams and misfeeds.

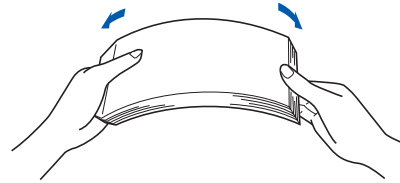

- 4 Put paper in the paper tray. Make sure that the paper is flat in the tray and below the maximum paper mark (1).

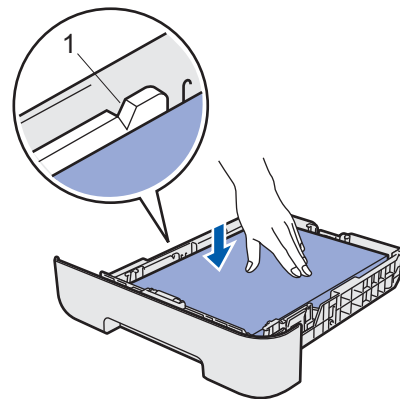

### Caution

Make sure the paper guides touch the sides of the paper so it will feed properly. If you do not this, it may cause damage to your machine.

- 5 Put the paper tray firmly back into the machine. Make sure that it is completely inserted into the machine.

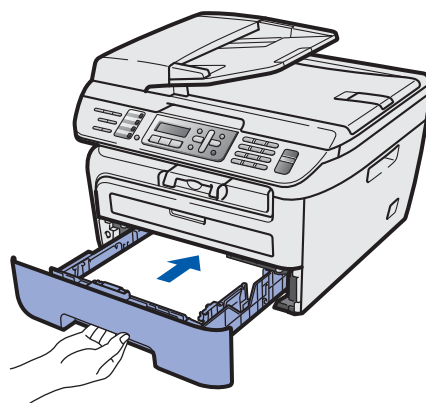

## 3 Install the power cord and phone line

- 1 Make sure that the machine power switch is off. Connect the AC power cord to the machine.

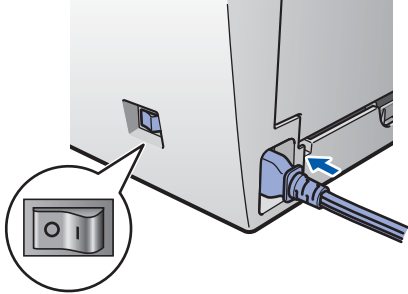

- 2 Plug the AC power cord into an AC outlet. Turn the power switch on.

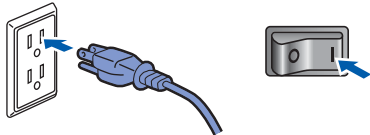

- 3 Connect one end of the telephone line cord to the jack on the machine marked **LINE** and the other end to a modular wall jack.

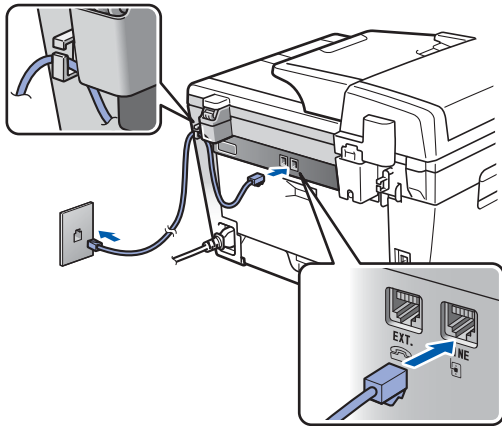

### Note

Make sure the telephone line cord is connected to the jack labeled **LINE** and not the **EXT.** jack.

### Warning

- The machine must be grounded using a 3-prong plug.
- Since the machine is grounded through the power outlet, you can protect yourself from potentially hazardous electrical conditions on the telephone network by keeping the power cord connected to your machine when you connect it to a telephone line. Similarly, you can protect yourself when you want to move your machine by disconnecting the telephone line first and then the power cord.

### Note

If you are sharing one phone line with an external telephone, connect it as shown below.

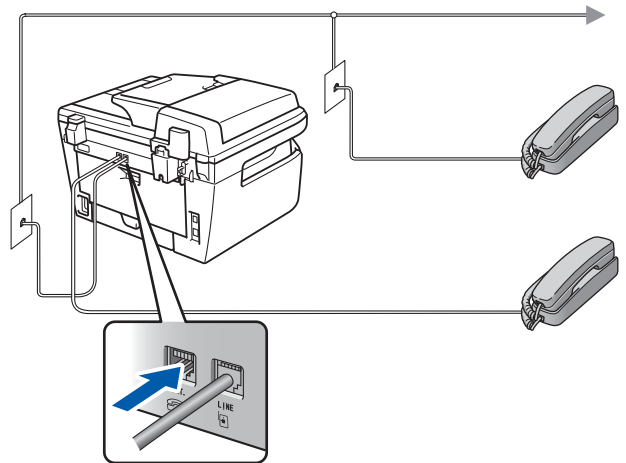

### Note

If you are sharing one phone line with an external telephone answering device, connect it as shown below.

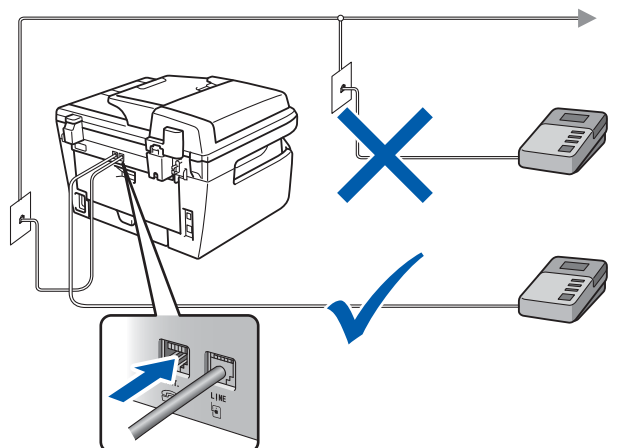



Please set the receive mode to *External TAD*.

For more details, see *Choosing the correct Receive Mode* on page 9 and *Connecting an external TAD* in Chapter 7 of the User's Guide.





## 4 Selecting your language

- 1 Press **Menu**.
- 2 Press **0**.
- 3 Press **0**.
- 4 Select your language by using  or  and then press **OK**.
- 5 Press **Stop/Exit**.

## 5 Setting the LCD contrast

You can change the contrast to help the LCD look lighter or darker.

- 1 Press **Menu**.
- 2 Press **1**.
- 3 Press **7**.
- 4 Press  to increase the contrast.  
  
—OR—  
Press  to decrease the contrast.  
Press **OK**.
- 5 Press **Stop/Exit**.

## 6 Setting the date and time

The machine displays the date and time, and if you setup the station ID, it will add it to each fax you send.

- 1 Press **Menu**.
- 2 Press **0**.
- 3 Press **2**.
- 4 Enter the last two digits of the year on the dial pad, and then press **OK**.



```
Date&Time
Year:2008
```

(e.g. Enter **0, 8** for 2008.)

- 5 Enter the two digits for the month on the dial pad, and then press **OK**.



```
Date&Time
Month:03
```

(e.g. Enter **0, 3** for March.)

- 6 Enter the two digits for the day on the dial pad, and then press **OK**.



```
Date&Time
Day:25
```

(e.g. Enter **2, 5**.)

- 7 Enter the time in 24-hour format on the dial pad, and then press **OK**.



```
Date&Time
Time:15:25
```

(e.g. Enter **1, 5, 2, 5** for 3:25 P.M.)

- 8 Press **Stop/Exit**.



### Note

*If you make a mistake and want to start again, press **Stop/Exit** and go back to step 1.*

## 7 Setting your station ID

You should store your name and fax number to be printed on all fax pages that you send.

- 1 Press **Menu**.
- 2 Press **0**.
- 3 Press **3**.
- 4 Enter your fax number (up to 20 digits) on the dial pad, and then press **OK**.

```
Station ID
Fax:
```



- 5 Enter your telephone number (up to 20 digits) on the dial pad, and then press **OK**. (If your telephone number and fax number are the same, enter the same number again.)

```
Station ID
Tel:
```

- 6 Use the dial pad to enter your name (up to 20 characters), and then press **OK**.

```
Station ID
Name:
```

### Note

- Refer to the following chart for entering your name.
- If you need to enter a character that is on the same key as the previous character, press  to move the cursor to the right.
- If you entered a letter incorrectly and want to change it, press  or  to move the cursor to the incorrect character, press **Clear/Back**.

Press key	One time	Two times	Three times	Four times	Five times
2	A	B	C	2	A
3	D	E	F	3	D
4	G	H	I	4	G
5	J	K	L	5	J
6	M	N	O	6	M
7	P	Q	R	S	7
8	T	U	V	8	T
9	W	X	Y	Z	9



For more details, see "Entering Text" in the User's Guide.

- 7 Press **Stop/Exit**.

### Note

*(USA only) The Telephone Consumer Protection Act of 1991 makes it unlawful for any person to use a computer or electronic device to send any message via a telephone fax machine unless such messages clearly contain, in a margin at the top or bottom of each transmitted page, or on the first page of the transmission, the date and time it is sent and an identification of the business or other entity or other individual sending the message and the telephone number of the sending machines or such business, other entity or individual. To program this information into your machine, see Setting the date and time on page 7 and Setting your station ID on page 8.*

## 8 Choosing the correct Receive Mode

The correct Receive mode is determined by the external devices and telephone subscriber services (Voice Mail, Distinctive Ring, etc.) you have (or will be using) on the same line as the Brother machine.

### Will you be using a Distinctive Ring number for receiving faxes?

Brother uses the term "Distinctive Ring" but telephone companies have other names for this service such as Custom Ringing, RingMaster, Personalized Ring, Teen Ring, Ident-A-Call, and Smart Ring. See Distinctive Ring in Chapter 7 of the User's Guide for instruction on setting up your machine using this feature.

### Will you be using Voice Mail on the same telephone line as your Brother machine?

If you have Voice Mail on the same telephone line as your Brother machine, there is a strong possibility that Voice Mail and the Brother machine will conflict with each other when receiving incoming calls. See Voice Mail in Chapter 7 of the User's Guide for instructions on setting up your machine using this service.

### Will you be using a Telephone Answering Device on the same telephone line as your Brother machine?

Your external telephone answering device (TAD) will automatically answer every call. Voice messages are stored on the external TAD and fax messages are printed. Choose **External TAD** as your receive mode. See the instructions below.

### Will you be using your Brother machine on a dedicated fax line?

Your machine automatically answers every call as a fax. Choose **Fax Only** as your receive mode. See the instructions below.

### Will you be using your Brother machine on the same line as your telephone?



#### Do you want to receive voice calls and faxes automatically

The **Fax/Tel** receive mode is used when sharing the Brother machine and your telephone on the same line. Choose **Fax/Tel** as your receive mode. See the instructions below.

**Important Note:** You can not receive voice messages on either Voice Mail or an answering machine when choosing the **Fax/Tel** mode.



#### Do you expect to receive very few faxes?

Choose **Manual** as your receive mode. You control the phone line and must answer every call yourself. See the instructions below.

- 1** Press **Menu**.
- 2** Press **0**.
- 3** Press **1**.
- 4** Press  or  to select the mode.  
Press **OK**.
- 5** Press **Stop/Exit**.

## 9 Tone and pulse dialing mode (Canada only)

Your machine comes set for Tone dialing service. If you have Pulse dialing service (rotary), you need to change the dialing mode.

- 1** Press **Menu**.
- 2** Press **0**.
- 3** Press **4**.
- 4** Press  or  to select **Pulse** (or **Tone**).  
Press **OK**.
- 5** Press **Stop/Exit**.

## 10 Dial Prefix

The dial prefix setting will automatically dial a predefined number before every fax number you dial. For example: If your phone system requires a 9 to dial an outside number this setting will automatically dial 9 for every fax you send.

- 1** Press **Menu**.
- 2** Press **0**.
- 3** Press **5** (For Canada, press **6**).
- 4** Enter the prefix number (up to 5 digits) on the dial pad, and then press **OK**.



### Note

- You can use the number 0 to 9, #, \* and !. (Press **Hook** to display "!".)  
You cannot use ! with any other numbers or characters.  
If your telephone system requires a timed break recall (hookflash), press **Hook** to enter the break.
- If the pulse dialing mode is on, # and \* are not available to use. (Canada only)

- 5** Press **Stop/Exit**.

## 11 Sending in the product registration and test sheet (USA only)

- 1 Fill out the Product Registration and Test Sheet.

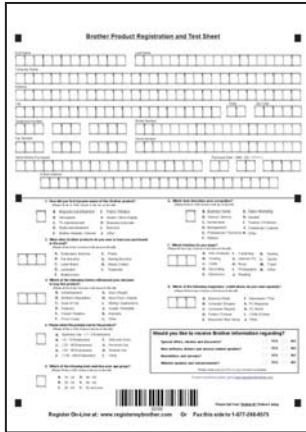
A detailed form titled "Brother Product Registration and Test Sheet". It contains various sections for user information, product details, and a test area. At the bottom, there is a barcode and contact information for Brother, including the website www.registration.brother.com and a fax number 1-877-268-9575.

- 2 Place the sheet face up in the Automatic Document Feeder.

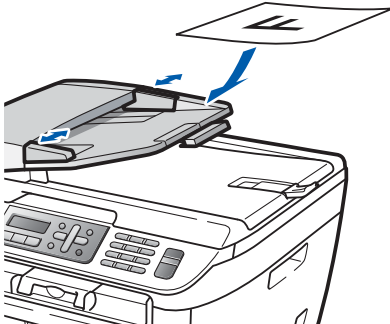

### Note

Make sure  (**Fax**) is illuminated in Green.

- 3 Enter the toll-free fax number:  
1-877-268-9575.

- 4 Press **Start**.

### Note

- You will receive a confirmation fax of your Product Registration.
- You can also register your product online using the On-Line Registration link from the installation CD-ROM or go to [www.brother.com/registration/](http://www.brother.com/registration/).

## Now go to

the next page to install the driver and software.

## Supplied CD-ROM 'MFL-Pro Suite'

### Windows®



#### Install MFL-Pro Suite

You can install the MFL-Pro Suite software and multifunction drivers.



#### Install Other Drivers or Utilities

You can install additional MFL-Pro Suite software utilities.



#### Documentation

View the Software User's Guide and Network User's Guide in HTML format. You can also view the manuals in PDF format by accessing the Brother Solutions Center. (Internet access required) The Software User's Guide and Network User's Guide include instructions for features available when connected to a computer. (eg. printing, scanning and networking details)



#### On-Line Registration

Register your machine on the Brother product Registration Page.



#### Brother Support

View contact information for Brother Customer Service and how to find a Brother Authorized Service Center. For Supplies Information, visit our site for original/genuine Brother supplies at <http://www.brother.com/original/>.



#### Repair MFL-Pro Suite (For USB users only)

If an error occurred during the installation of the MFL-Pro Suite, use this selection to automatically repair and re-install the MFL-Pro Suite.



#### Note

*MFL-Pro Suite includes the Printer Driver, Scanner Driver, Brother ControlCenter3, ScanSoft™ PaperPort™ 11SE with OCR by NUANCE™. ScanSoft™ PaperPort™ 11SE is a document management application for scanning and viewing documents.*

### Macintosh®



#### Start Here OSX

You can install the MFL-Pro Suite that includes the printer driver, scanner driver, the Brother ControlCenter2 and BRAdmin Light for Mac OS® X 10.2.4 or greater.



#### Documentation

View the Software User's Guide and Network User's Guide in HTML format. You can also view the manuals in PDF format by accessing the Brother Solutions Center. (Internet access required) The Software User's Guide and Network User's Guide include instructions for features available when connected to a computer. (eg. printing, scanning and networking details)



#### Brother Solutions Center

Access the Brother Solutions Center for FAQs, User's Guide, driver updates and tips for using your machine. (Internet access required)



#### Presto! PageManager

You can install Presto!® PageManager® to add OCR capability to the Brother ControlCenter2 and easily scan, share and organize photos and documents.



#### On-Line Registration

Register your machine on the Brother product Registration Page.



#### Utilities

You can find the following additional Utilities from this folder.

- Wireless LAN Setup Wizard
- Presto!® PageManager® Uninstaller
- BRAdmin Light

# STEP 2

# Installing the Printer Driver

Follow the instructions on this page for your operating system and interface.  
For the latest drivers, documentation, and to find the best solution for your problem, access the Brother Solution Center directly from the CD-ROM / Driver or visit <http://solutions.brother.com/>.

## Windows®



For USB Interface Cable Users ..... 14



For Wired Network Interface Users ..... 17  
For Windows Server® 2003, see Chapter 5 of the Network User's Guide



For Wireless Network Interface Users (Infrastructure mode)..... 20  
For other setup method supported and Ad-hoc mode, see the Network User's Guide on the CD-ROM for installation details.

## Macintosh®



For USB Interface Cable Users..... 29



For Wired Network Interface Users ..... 31



For Wireless Network Interface Users (Infrastructure mode) ..... 34  
For other setup method supported and Ad-hoc mode, see the Network User's Guide on the CD-ROM for installation details.

## For USB Interface Cable Users (For Windows® 2000 Professional/XP/XP Professional x64 Edition/Windows Vista®)

### Important

Make sure that you have finished the instructions from step 1 *Setting Up the Machine* on pages 4 through 11.

### Note

- Please close any applications running before installing the MFL-Pro Suite.
- The supplied CD-ROM includes ScanSoft™ PaperPort™ 11SE. This software supports Windows® 2000 (SP4 or greater), XP (SP2 or greater), XP Professional x64 Edition and Windows Vista® only. Please update to the latest Windows® Service Pack before installing MFL-Pro Suite.

- 1 Turn off and unplug the machine from the AC outlet and disconnect it from your computer, if you already connected an interface cable.

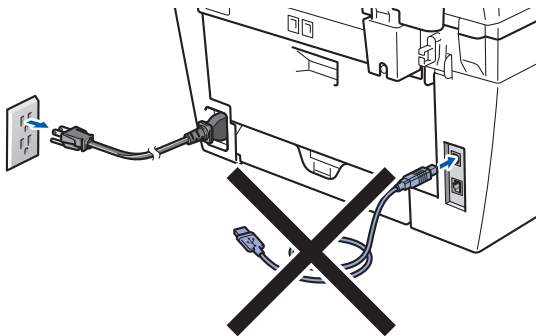

- 2 Turn on your computer. (You must be logged on with administrator rights.)
- 3 Put the supplied CD-ROM for Windows® into your CD-ROM drive. If the model name screen appears, choose your machine. If the language screen appears, choose your language.

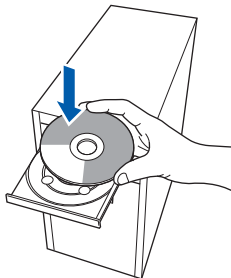

- 4 The CD-ROM main menu will appear. Click **Install MFL-Pro Suite**.



### Note

- If this window does not appear, use Windows® Explorer to run the **start.exe** program from the root folder of the Brother CD-ROM.
- For Windows Vista®, when the User Account Control screen appears, click **Allow**.

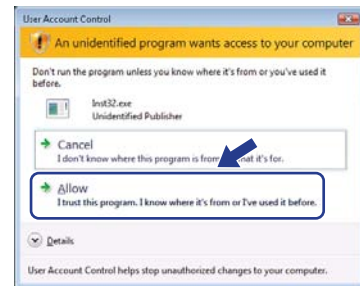

- 5 Choose **Local Connection (USB)**, and then click **Next**. The installation will continue.



### Note

If you want to install the PS driver (Brother's BR-Script Driver), choose **Custom Install** and then follow the on-screen instructions. When the **Select Features** screen appears, check **PS Printer Driver**, and then continue following the on-screen instructions.



- 6** After reading and accepting the ScanSoft™ PaperPort™ 11SE License Agreement, click **Yes**.

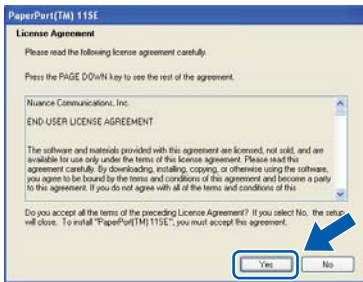

The installation of ScanSoft™ PaperPort™ 11SE will automatically start and is followed by the installation of MFL-Pro Suite.

- 7** When the Brother MFL-Pro Suite Software License Agreement window appears, click **Yes** if you agree to the Software Licence Agreement.



**Note**

For Windows Vista®, when this screen appears, click the check box and click **Install**.



- 8** When this screen appears, connect the USB interface cable to your PC, and then connect it to the machine.

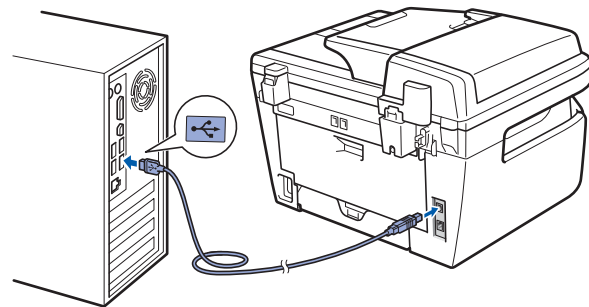

Windows®  
USB

**Improper Setup**

**DO NOT** connect the machine to a USB port on a keyboard or a non-powered USB hub. Brother recommends that you connect the machine directly to your computer.

- 9** Plug the AC power cord into an AC outlet. Turn the power switch on.

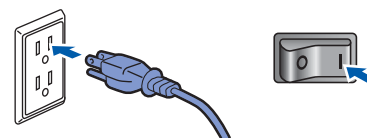

The installation of the Brother drivers will automatically start. **The installation screens appear one after another, please wait for a while.**

**Improper Setup**

**DO NOT** try to cancel any of the screens during this installation.

- 10** When the On-Line Registration screen is displayed, make your selection and follow the on-screen instructions. Once you have completed the registration process, close your web browser to return to this window. Then click **Next**.

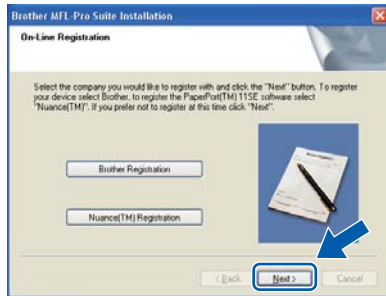

- 11** Click **Finish** to restart your computer. ( You must be logged on with Administrator rights.)



### Note

After restarting the computer, the **Installation Diagnostics** will run automatically. If the installation is unsuccessful, the installation results window will be shown. If the **Installation Diagnostics** shows a failure, please follow the on-screen instruction or read the on-line help and FAQs in **Start/All Programs/ Brother/ MFC-XXXX**.



The MFL-Pro Suite (including printer driver and scanner driver) has been installed and the installation is now complete.



### Note

**XML Paper Specification Printer Driver**  
The XML Paper Specification Printer Driver is the most suitable driver when printing from the applications that use the XML Paper Specification documents. Please download the latest driver by accessing the Brother Solutions Center at <http://solutions.brother.com/>.

## For Wired Network Interface Users (For Windows® 2000 Professional/XP/XP Professional x64 Edition/Windows Vista®)

### Important

Make sure that you have finished the instructions from step 1 *Setting Up the Machine* on pages 4 through 11.



### Note

The supplied CD-ROM includes ScanSoft™ PaperPort™ 11SE. This software supports Windows® 2000 (SP4 or greater), XP (SP2 or greater), XP Professional x64 Edition and Windows Vista® only. Please update to the latest Windows® Service Pack before installing MFL-Pro Suite.

- 1 Turn off and unplug the machine from the AC outlet.
- 2 Connect the network interface cable to the machine, and then connect it to your network.

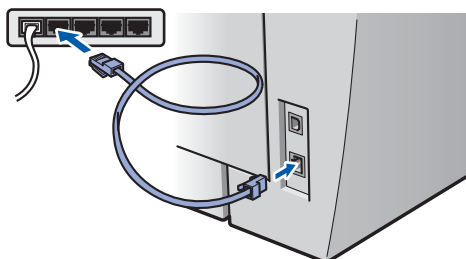

- 3 Plug the AC power cord into an AC outlet. Turn the power switch on.

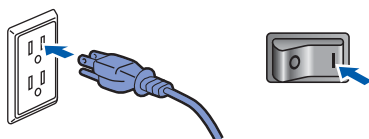

- 4 Turn on your computer. (You must be logged on with Administrator rights.) Close any applications running before installing the MFL-Pro Suite.



### Note

Before installation, if you are using personal firewall software, disable it. After the installation, restart your personal firewall software.

- 5 Put the supplied CD-ROM into your CD-ROM drive. If the model name screen appears, choose your machine. If the language screen appears, choose your language.

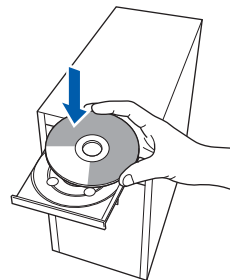

- 6 The CD-ROM main menu will appear. Click **Install MFL-Pro Suite**.



### Note

- If this window does not appear, use Windows® Explorer to run the **start.exe** program from the root folder of the Brother CD-ROM.
- For Windows Vista®, when the User Account Control screen appears, click **Allow**.

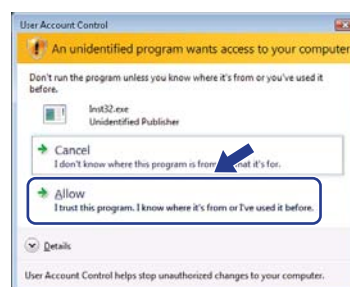

**7** Choose **Wired Network Connection (Ethernet)**, and then click **Next**.

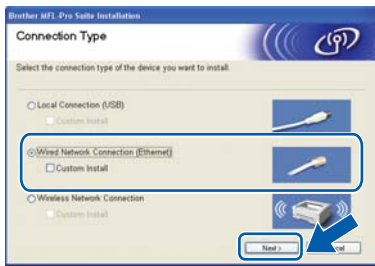

**Note**

If you want to install the PS driver (Brother's BR-Script Driver), choose **Custom Install** and then follow the on-screen instructions. When the **Select Features** screen appears, check **PS Printer Driver**, and then continue following the on-screen instructions.

**8** After reading and accepting the ScanSoft™ PaperPort™ 11SE License Agreement, click **Yes**.

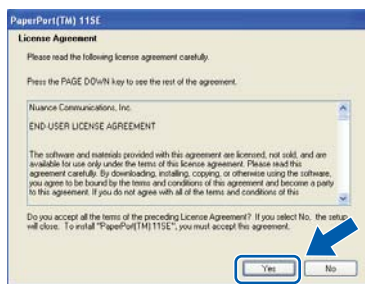

The installation of ScanSoft™ PaperPort™ 11SE will automatically start and is followed by the installation of MFL-Pro Suite.

**9** When the Brother MFL-Pro Suite Software License Agreement window appears, click **Yes** if you agree to the Software License Agreement.

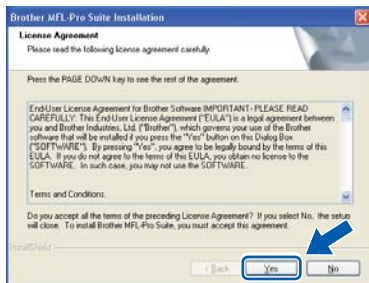

**10** For Windows® XP SP2/XP Professional x64 Edition/Windows Vista® users, when this screen appears, choose **Change the Firewall port settings to enable network connection and continue with the installation. (Recommended)** and click **Next**.

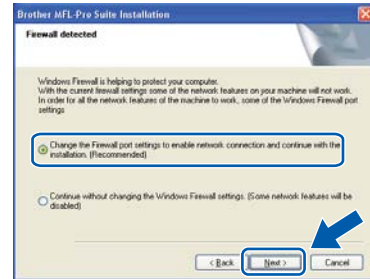

If you are not using the Windows® Firewall, see the User's Guide for your software for information on how to add the following network ports.

- For network scanning, add UDP port 54925.
- For network PC-Fax receiving, add UDP port 54926.
- If you still have trouble with your network connection, add UDP port 137.

**11** If the machine is configured for your network, choose the machine from the list, and then click **Next**.

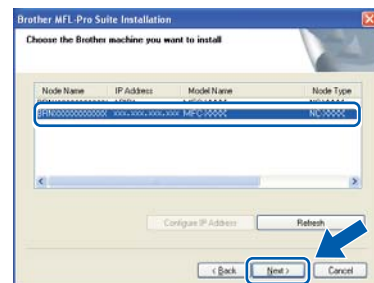

If your machine shows **APIPA** in the **IP Address** field, click **Configure IP Address** and enter an **IP address** for your machine that is suitable for your network.

**Note**

- You can find your machine's IP address and the node name by printing out the Network Configuration List. See *Print the Network Configuration List* on page 45
- If the machine is not yet configured for use on your network, the following screen appears.



Click **OK**.  
The **Configure IP Address** window will appear.  
Enter an **IP address** for your machine that is suitable for your network by following the on-screen instructions.

**12** The installation of the Brother drivers will automatically start. **The installation screens appear one after another, please wait for a while.**

## Improper Setup

**DO NOT try to cancel any of the screens during this installation.**

### Note

For Windows Vista®, when this screen appears, click the check box and click **Install**.



**13** When the On-Line Registration screen is displayed, make your selection and follow the on-screen instructions. Once you have completed the registration process, close your web browser to return to this window. Then click **Next**.



**14** Click **Finish** to restart your computer. (You must be logged on with Administrator rights.)

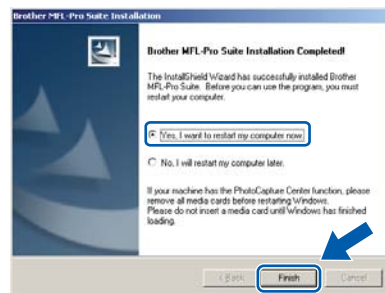

**OK!** The MFL-Pro Suite has been installed and the installation is now complete.

### Note

- **XML Paper Specification Printer Driver**  
The XML Paper Specification Printer Driver is the most suitable driver when printing from applications that use XML Paper Specification documents. Please download the latest driver by accessing the Brother Solutions Center at <http://solutions.brother.com/>.
- **MFL-Pro Suite includes the Network Printer Driver, Network Scanner Driver, Brother ControlCenter3 and ScanSoft™ PaperPort™ 11SE.**  
ScanSoft™ PaperPort™ 11SE is a document management application for viewing scanned documents.
- **After restarting the computer, the Installation Diagnostics will run automatically. If the installation is unsuccessful, the installation results window will be shown. If the Diagnostics shows a failure, please follow the on-screen instructions or read the on-line help and FAQ's in Start/All Programs/Brother/MFC-XXXX LAN.**



## For Wireless Network Interface Users (For Windows® 2000 Professional/XP/XP Professional x64 Edition/Windows Vista®) in infrastructure mode

### Connecting your wireless machine and wireless network together and installing the printer driver in infrastructure mode

First you must configure the wireless network settings of your machine to communicate with your network access point (router). After the machine is configured to communicate with your access point (router) computers on your network will have access to the machine. To use the machine from these computers, you will need to install the MFL-Pro Suite. The following steps will guide you through the configuration and installation process.

To achieve optimum results with normal every day document printing, place the Brother machine as close to the network access point (router) as possible with minimal obstructions. Large objects and walls between the two devices as well as interference from other electronic devices can affect the data transfer speed of your documents.

Due to these factors, wireless may not be the best method of connection for all types of documents and applications. If you are printing large files, such as multi-page documents with mixed text and large graphics, you may want to consider choosing wired Ethernet for a faster data transfer, or USB for the fastest throughput speed.

Although the MFC can be used in both a wired and wireless network, only one of the connection methods can be used at a time.

#### Important

The following instructions will offer two methods for installing your Brother machine in a wireless network environment. Both methods are for infrastructure mode, using a wireless router or access point that uses DHCP to assign IP addresses. If your wireless router/access point supports SecureEasySetup™, Wi-Fi Protected Setup™ or AOSS™ follow the steps on page 25 *Using the SecureEasySetup™, Wi-Fi Protected Setup™ or AOSS™ software to configure your machine for a wireless network (one-push method)*. If your wireless router/access point does not support SecureEasySetup™, Wi-Fi Protected Setup™ or AOSS™ follow the steps on page 22 *Using the Setup Wizard from the control panel LAN menu for wireless network configuration (Infrastructure Mode)*. To set up your machine in any other wireless environment (Ad-hoc mode) you can find instructions in the Network User's Guide on the CD-ROM.

You can view the Network User's Guide by following the instructions below.

- 1 Turn on your computer. Insert the Brother CD-ROM into your CD-ROM drive.
- 2 If the language screen appears, click your language. The CD-ROM main menu will appear.
- 3 Click the **Documentation**.
- 4 Click the **HTML documents**.
- 5 Click the **NETWORK USER'S GUIDE**.

#### Note

- If you are going to connect the printer to your network, we recommend that you contact your system administrator prior to installation.
- If you are using personal firewall software (e.g. Windows® Firewall), disable it. Once you are sure that you can print, restart your personal firewall software.

## Confirm your network environment

The setup process will be different depending on your network environment.

### ■ Infrastructure Mode

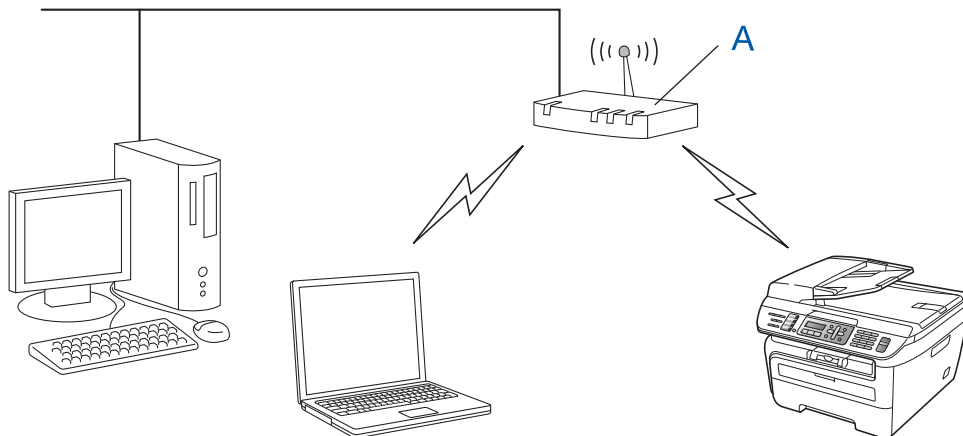

If your wireless access point (A) does not support SecureEasySetup™, Wi-Fi Protected Setup™ or AOSS™, follow the instructions, on page 22.

### ■ Installation using SecureEasySetup™, Wi-Fi Protected Setup™ or AOSS™ .

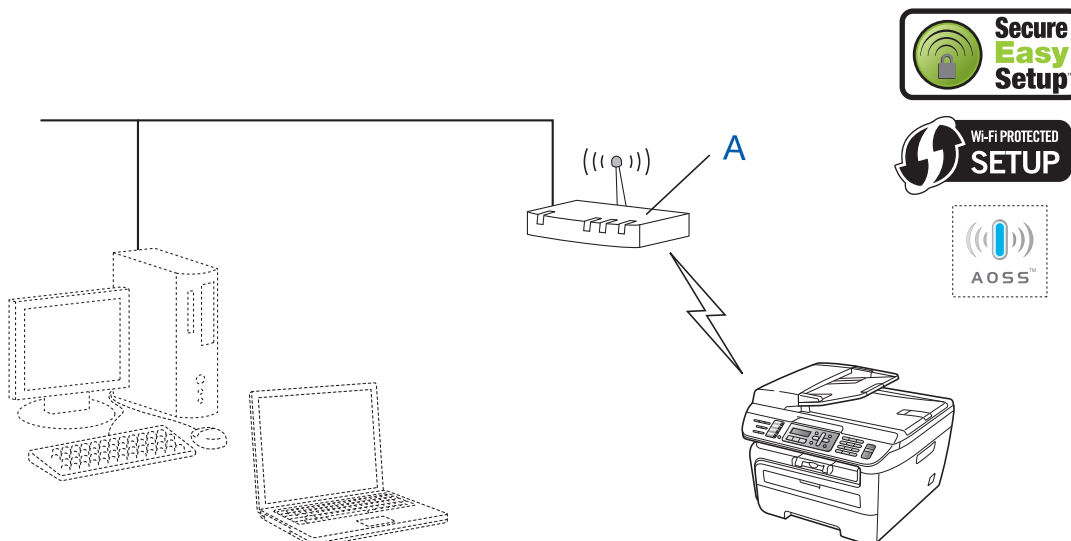

If your wireless access point (A) supports SecureEasySetup™, Wi-Fi Protected Setup™ or AOSS™, you do not need to use a computer to configure the machine. The access point (router) and your machine can automatically negotiate using the SecureEasySetup™ procedure. For instructions, go to page 25.

### ■ Configuration using the PIN Method of Wi-Fi Protected Setup™

If your wireless access point(A) supports Wi-Fi Protected Setup™, you can also configure using the PIN Method of Wi-Fi Protected Setup™. For instructions, see the Network User's Guide on the CD-ROM.

## Using the Setup Wizard from the control panel LAN menu for wireless network configuration (Infrastructure Mode)

### Important

**Make sure that you have finished the instructions from step 1 *Setting Up the Machine* on pages 4 through 11.**

These instructions will install your Brother machine in a typical small office or home wireless network environment in infrastructure mode, using a wireless router or access point that uses DHCP to assign IP addresses.

If you want to setup your machine in any other wireless environment you can find instructions in the Network User's Guide on the CD-ROM.

You can view the Network User's Guide by following the instructions below.

- 1 Turn on your PC. Insert the Brother CD-ROM labeled Windows® into your CD-ROM drive.
- 2 If the language screen appears, click your language. The CD-ROM main menu will appear.
- 3 Click **Documentation**.
- 4 Click the **HTML document**.
- 5 Click the **Network User's Guide**.



### Note

*If the window does not appear, use Windows® Explorer to run the setup.exe program from the root directory of the Brother CD-ROM.*



**Before you begin you must know your wireless network settings.**

### 1

Write down the wireless network settings of your access point or wireless router.

**SSID** (Service Set ID or Network name)

**WEP Key** (if needed)

**WPA-PSK Password** (if needed)

**Encryption** (TKIP or AES)

**LEAP user name** (if needed)

**LEAP password**

*The WEP key is for 64-bit encrypted networks or 128-bit encrypted networks and can contain both numbers and letters. If you do not know this information you should see the documentation provided with your access point or wireless router. This key is a 64-bit or 128-bit value that must be entered in an ASCII or HEXADECIMAL format.*

### For example:

64-bit ASCII:	Uses 5 text characters. e.g. "Hello" (this is case sensitive)
64-bit Hexadecimal:	Uses 10 digits of hexadecimal data. e.g. "71f2234aba"
128-bit ASCII:	Uses 13 text characters. e.g. "Wirelesscomms" (this is case sensitive)
128-bit Hexadecimal:	Uses 26 digits of hexadecimal data. e.g. "71f2234ab56cd709e5412aa3ba"

WPA-PSK enables a Protected Access Pre-shared key that allows the Brother wireless machine to associate with access points using TKIP and AES encryption. WPA-PSK uses a Pre-Shared Key that is 8 or more characters in length, up to a maximum of 63 characters.

Cisco® LEAP has been developed by Cisco Systems, Inc. which uses user ID and password for authentication. The LEAP User ID is up to a maximum of 63 characters in length, and the Password is up to a maximum of 31 characters in length.

*See Chapter 3 of the Network User's Guide for more details.*



- 2** Plug the AC power cord into an AC outlet. Turn the power switch on.

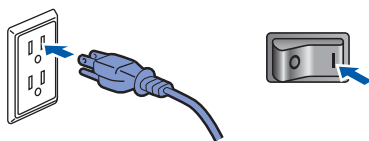

## ⊘ Improper Setup

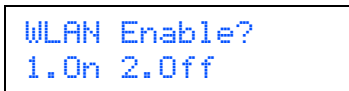

If you have previously configured the wireless settings of the machine you must reset the network (LAN) settings before you can configure the wireless settings again. Press Menu, 5, 2, 6 (or Menu, 5, 0, 1) and then press 1 to accept the change.

- 3** On your machine, press **Menu, 5, 2, 2**.



Press **1** to choose On. The wired network interface will become inactive with this setting.

- 4** The machine will search for your network and display a list of available SSIDs. You should see the SSID you wrote down earlier. If the machine finds more than one network use the

 or  to choose your network, then



press **OK**. Go to step 8.



## Note

*It will take several seconds to display a list of available SSIDs.*

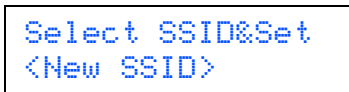

If your access point is set to not broadcast the SSID you will have to manually add the SSID name. Go to step 5.

- 5** Select <New SSID> using the  or  and press **OK**. Go to step 6.





- 6** Enter a new SSID and press **OK**. For information how to type text, see *Entering text* on page 46.



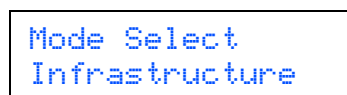

- 7** Press the  or  to choose Infrastructure, then press **OK**.



- 8** Use the  or  and **OK** keys to choose one of the options below: If your network is configured for Authentication and Encryption you must match the settings used for your network.

**No Authentication or Encryption:** Choose Open System, press **OK** then choose None for Encryption Type and press **OK**. Then press **1** to apply your settings. Go to step 12.

**No Authentication with WEP Encryption:** Choose Open System, press **OK** then use the  or  to choose WEP for the Encryption Type and press **OK**. Go to step 9.

**Authentication with WEP Encryption:** Choose Shared Key, press **OK**. Go to step 9.



**Authentication with WPA-PSK (TKIP or AES Encryption):** Choose WPA/WPA2-PSK, press **OK**. Go to step 10.

**Authentication with LEAP:** Choose LEAP, press **OK**. Go to step 11.

- 9** Choose the appropriate key number and press **OK**.







Set WEP KEY  
KEY1:

Enter the WEP key you wrote down in step 1 using the dial pad. You can use the  or  to move the cursor. For example, to enter the letter a, press the **2** key on the dial pad once. To enter the number 3, press the **3** key on the dial pad seven times.



The letters appear in this order: lower case, upper case and numbers.

Press **OK** when you have entered all the characters, then press **1** to apply your settings. Go to step 12.

**Most access points and routers can store more than one key, but they will only use one at any time for authentication and encryption.**

- 10** Press the  or  to choose TKIP or AES for Encryption Type and press **OK**. Enter the WPA-PSK Password you wrote down in step 1 using the dial pad. You can use the  or  to move the cursor. For example, to enter the letter a, press the **2** key on the dial pad once. To enter the number 3, press the **3** key on your dial pad seven times.

Press **OK** when you have entered all the characters, then press **1** to apply your settings. Go to step 12.

- 11** Enter the user name and press **OK**. You can use the  or  to move the cursor. For example, to enter the letter a, press the **2** key on the dial pad once.

Enter the password and press **OK**, and then press **1** to apply your settings. Go to step 12. (Use the chart on *Entering text* on page 46.)

- 12** Your machine will now try to connect to your wireless network using the information you have entered. If successful, Connected will appear briefly on the LCD.

Connection NG is displayed when the print server has not successfully connected to your router or access point. Try starting from step 3 again. If the same message is displayed again, reset the print server back to the default factory settings and try again. (See *Restoring the network settings to factory default* on page 45.)

- 13** The machine will automatically acquire the correct TCP/IP address information from your access point (router) if DHCP is enabled (DHCP is normally enabled as default for most access point routers).

*If your access point does not have DHCP enabled you will need to manually configure the IP address, subnet mask and gateway of the machine to suit your network. See the Network User's Guide for details.*

-  **Wireless setup is now complete. To install the MFL-Pro suite, continue to step 7 on page 26.**

 **Note**

*The supplied CD-ROM includes the ScanSoft™ PaperPort™ 11SE. This software supports Windows® 2000 (SP4 or greater), XP (SP2 or greater), XP Professional x64 Edition and Windows Vista® only. Please update to the latest Windows® Service Pack before installing MFL-Pro Suite.*

## Using the SecureEasySetup™, Wi-Fi Protected Setup™ or AOSS™ software to configure your machine for a wireless network (one-push method)

If your wireless access point supports either SecureEasySetup™, Wi-Fi Protected Setup™ (PBC<sup>1</sup>) or AOSS™, you can configure the machine easily without a computer. By pushing a button on the wireless router or access point, you can setup the wireless network and security settings. See the user's guide for your wireless LAN router or access point for instructions on how to access one-push mode. If your wireless router or access point does not support SecureEasySetup™, Wi-Fi Protected Setup™ or AOSS™ go to the page 22 for installation instructions.

<sup>1</sup> Push Button Configuration



### Note

Routers or access points that support SecureEasySetup™, Wi-Fi Protected Setup™ or AOSS™ have the symbols as shown below.



- 1 Plug the AC power cord into an AC outlet. Turn the power switch on.

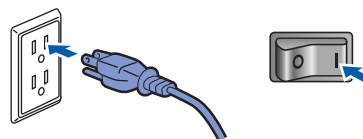

### Improper Setup

If you have previously configured the wireless settings of the machine you must reset the network (LAN) settings before you can configure the wireless settings again. Press **Menu, 5, 2, 6** (or **Menu, 5, 0, 1**) and then press **1** to accept the change.

- 2 Place the Brother machine close to the SecureEasySetup™, Wi-Fi Protected Setup™ or AOSS™ router or access point .
- 3 Push the SecureEasySetup™, Wi-Fi Protected Setup™ or AOSS™ button on your wireless router or access point. See the user's guide for your wireless router or access point for instructions.
- 4 Press **Menu, 5, 2, 3** on the control panel of the Brother machine.

```
WLAN Enable?
1.On 2.Off
```

Press **1** to choose **On**. The wired network interface will become inactive with this setting.

This feature will automatically detect which mode (SecureEasySetup™, Wi-Fi Protected Setup™ or AOSS™) your access point uses to configure your machine.

### Note

If your wireless access point supports Wi-Fi Protected Setup™ (PIN Method) and you want to configure your machine using the PIN (Personal Identification Number) Method, see *Using the PIN Method of Wi-Fi Protected Setup™ in the Network User's Guide.*

- The machine searches for an access point that supports SecureEasySetup™, Wi-Fi Protected Setup™ or AOSS™ for 2 minutes.



- If the LCD shows Connected, the machine has successfully connected to your router or access point. You can now use your machine in a wireless network.

If the LCD shows Setting WLAN, Connecting SES (Connecting WPS or Connecting AOSS), then Connection NG, the machine has not successfully connected to your router or access point. Try starting from 4 again. If the same message is indicated again, reset the machine back to the default factory settings and try again. For resetting, see *Restoring the network settings to factory default* on page 45.

If the LCD shows Setting WLAN, then Connection NG or Incorrect Mode, a session overlap or connection failure has been detected (See the Note below). The machine has detected more than 2 routers or access points on your network that have the SecureEasySetup™, Wi-Fi Protected Setup™ mode or the AOSS™ mode enabled. Make sure that only one router or access point has the SecureEasySetup™ mode, Wi-Fi Protected Setup™ mode or the AOSS™ mode enabled and try starting from 4 again.



**Note**  
*LCD messages when using the SES/WPS/AOSS control panel menu*

Setting WLAN	Searching or accessing the access point and downloading settings from the access point.
Connecting SES/WPS/AOSS	Connecting to the access point.
Connection NG	Connection failed. (If it is shown after the LCD shows Connecting SES/WPS/AOSS.)
	Session overlap is detected.
Incorrect Mode	Session overlap is detected.



**Wireless setup is now complete. To install the MFL-Pro Software suite, continue to step 7.**

- Turn on your computer. (You must be logged on with Administrator rights.) Close any applications running before installing the MFL-Pro Suite.



**Note**  
*Before installation, if you are using personal firewall software, disable it. After the installation, restart your personal firewall software.*

- Put the supplied CD-ROM into your CD-ROM drive. If the model name screen appears, choose your machine. If the language screen appears, choose your language.

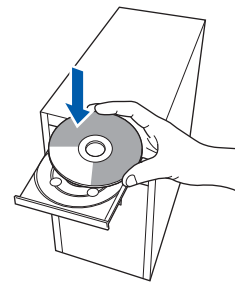

- The CD-ROM main menu will appear. Click **Install MFL-Pro Suite**.



- Note**
- If this window does not appear, use Windows® Explorer to run the **start.exe** program from the root folder of the Brother CD-ROM.
  - For Windows Vista®, when the User Account Control screen appears, click **Allow**.

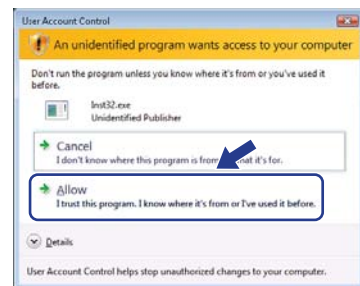

- 10** Choose **Wireless Network Connection**, and then click **Next**.



**Note**

If you want to install the PS driver (Brother's BR-Script Driver), choose **Custom Install** and then follow the on-screen instructions. When the **Select Features** screen appears, check **PS Printer Driver**, and then continue following the on-screen instructions.

- 11** Click on the **Checked and confirmed** check box, and then click **Next**. Follow the on screen instructions.

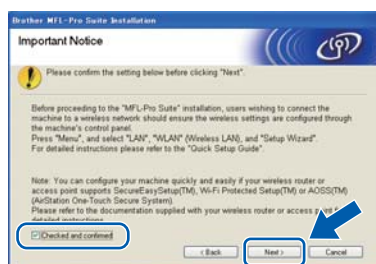

- 12** After reading and accepting the ScanSoft™ PaperPort™ 11SE License Agreement, click **Yes**.

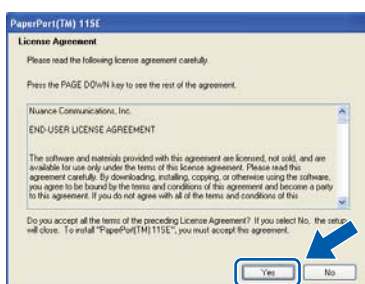

The installation of ScanSoft™ PaperPort™ 11SE will automatically start and is followed by the installation of MFL-Pro Suite.

- 13** When the Brother MFL-Pro Suite Software License Agreement window appears, click **Yes** if you agree to the Software License Agreement.

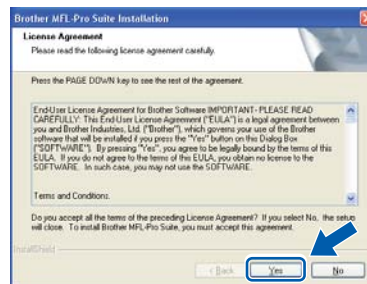

- 14** For Windows® XP SP2/XP Professional x64 Edition/Windows Vista® users, when this screen appears, choose **Change the Firewall port settings to enable network connection and continue with the installation. (Recommended)** and click **Next**.

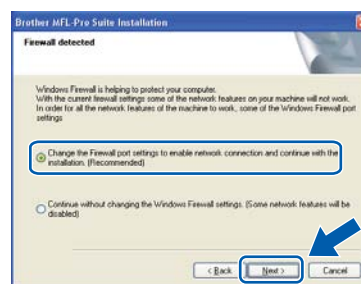

If you are not using the Windows® Firewall, see the User's Guide for your software for information on how to add the following network ports.

- For network scanning, add UDP port 54925.
- For network PC-Fax receiving, add UDP port 54926.
- If you still have trouble with your network connection, add UDP port 137.

- 15** If the machine is configured for your network, choose the machine from the list, and then click **Next**.

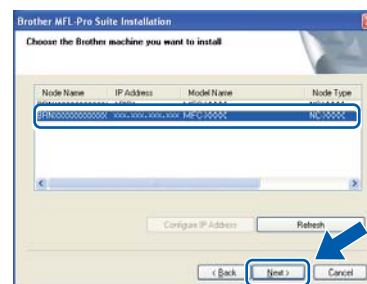

If your machine shows **APIPA** in the **IP Address** field, click **Configure IP Address** and enter an **IP address** for your machine that is suitable for your network.

Windows®  
Wireless  
Network



**Note**

- You can find your machine's IP address and the node name by printing out the Network Configuration List. See *Print the Network Configuration List on page 45*
- If the machine is not yet configured for use on your network, the following screen appears.



Click **OK**.

The **Configure IP Address** window will appear. Enter an **IP address** for your machine that is suitable for your network by following the on-screen instructions.

- 16** The installation of the Brother drivers will automatically start. **The installation screens appear one after another, please wait for a while.**

**Improper Setup**

**DO NOT try to cancel any of the screens during this installation.**

**Note**

For Windows Vista®, when this screen appears, click the check box and click **Install**.



- 17** When the On-Line Registration screen is displayed, make your selection and follow the on-screen instructions. Once you have completed the registration process, close your web browser to return to this window. Then click **Next**.



- 18** Click **Finish** to restart your computer. (You must be logged on with Administrator rights.)

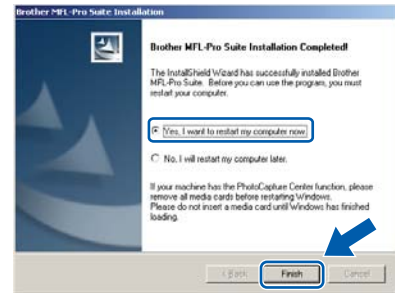

- OK!** The MFL-Pro Suite has been installed and the installation is now complete.

**Note**

- XML Paper Specification Printer Driver**  
The XML Paper Specification Printer Driver is the most suitable driver when printing from applications that use XML Paper Specification documents. Please download the latest driver by accessing the Brother Solutions Center at <http://solutions.brother.com/>.
- MFL-Pro Suite includes the Network Printer Driver, Network Scanner Driver, Brother ControlCenter3 and ScanSoft™ PaperPort™ 11SE.**  
ScanSoft™ PaperPort™ 11SE is a document management application for viewing scanned documents.
- After restarting the computer, the **Installation Diagnostics** will run automatically. If the installation is unsuccessful, the installation results window will be shown. If the **Diagnostics** shows a failure, please follow the on-screen instructions or read the on-line help and FAQ's in **Start/All Programs/Brother/MFC-XXXX LAN**.

## For USB Interface Cable Users

### For Mac OS® X 10.2.4 or greater

#### Important

Make sure that you have finished the instructions from step 1 *Setting Up the Machine* on pages 4 through 11.

#### Note

For Mac OS® X 10.2.0 to 10.2.3 users, upgrade to Mac OS® X 10.2.4 or greater. (For the latest information for Mac OS® X, visit <http://solutions.brother.com/>)

- 1 Plug the AC power cord into an AC outlet. Turn the power switch on.

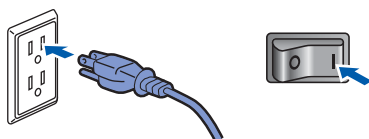

- 2 Connect the USB interface cable to your computer, and then connect it to the machine.

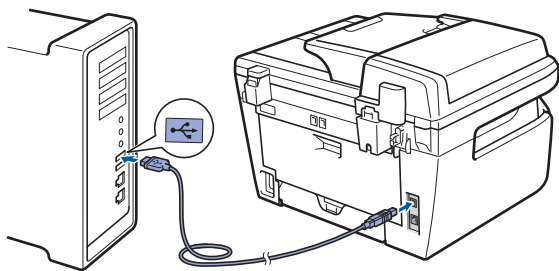

#### Improper Setup

**DO NOT** connect the machine to a USB port on a keyboard or a non-powered USB hub. Brother recommends that you connect the machine directly to your computer.

- 3 Turn on your Macintosh®.

- 4 Put the supplied CD-ROM into your CD-ROM drive.

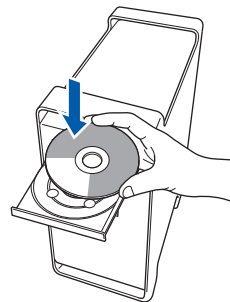

- 5 Double-click the **Start Here OSX** icon to install. Follow the on-screen instructions.



#### Note

Please see the *Software User's Guide* on the CD-ROM if you want to install the PS driver.

- 6 Choose **Local Connection (USB)**, and then click **Next**. The installation will continue.

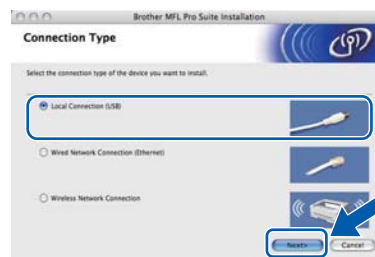

#### Note

Please wait, it will take a few seconds for the software to install. After the installation, click **Restart** to finish installing the software.

**7** The Brother software will search for the Brother device. During this time the following screen will appear.

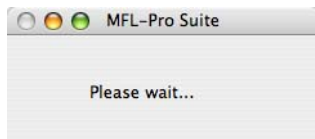

**8** When this screen appears, click **OK**.



**OK!** For Mac OS® X 10.3.x or greater users: The MFL-Pro Suite, Brother printer driver, scanner driver and Brother ControlCenter2 have been installed and the installation is now complete. Go to step 13.

**9** For Mac OS® X 10.2.4 to 10.2.8 users: Click **Add**.

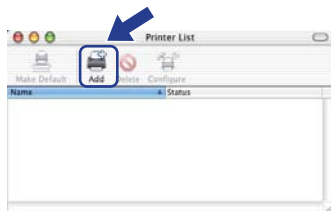

**10** Choose **USB**.

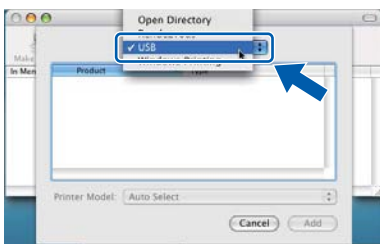

**11** Choose your model name, and then click **Add**.

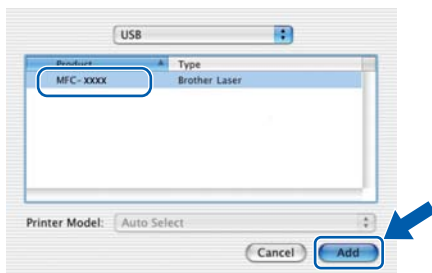

**12** Click **Print Center**, then **Quit Print Center**.

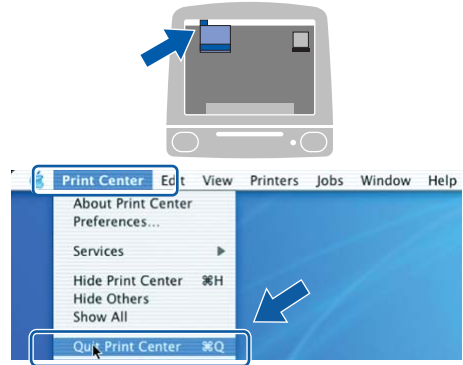

**OK!** The MFL-Pro Suite, Brother printer driver, scanner driver and Brother ControlCenter2 have been installed and the installation is now complete.

**13** To install Presto!® PageManager®, double-click the **Presto! PageManager** icon and follow the on-screen instructions.

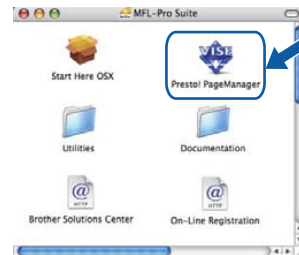

**Note**

When Presto!® PageManager® is installed OCR capability is added to the Brother ControlCenter2. You can also easily scan, share and organize photos and documents using Presto!® PageManager®.

**OK!** Presto!® PageManager® has been installed and the installation is now complete.



## For Wired Network Interface Users

### For Mac OS® X 10.2.4 or greater

#### Important

Make sure that you have finished the instructions from step 1 *Setting Up the Machine* on pages 4 through 11.

- 1 Plug the AC power cord into an AC outlet. Turn the power switch on.

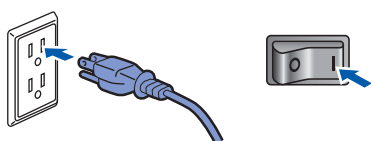

- 2 Connect the network interface cable to the machine, and then connect it to your network.

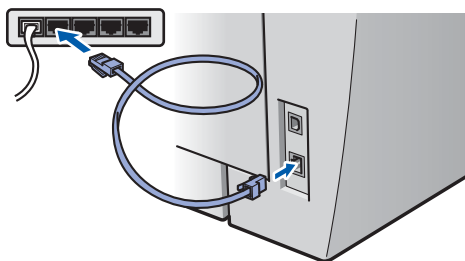

- 3 Turn on your Macintosh®.

- 4 Put the supplied CD-ROM into your CD-ROM drive.

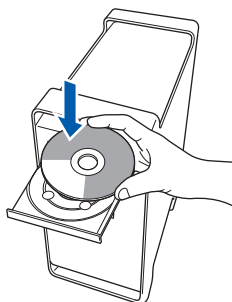

- 5 Double-click the **Start Here OSX** icon to install. Follow the on-screen instructions.



#### Note

Please see the *Network User's Guide on the CD-ROM* if you want to install the PS driver.

- 6 Choose **Wired Network Connection (Ethernet)**, and then click **Next**. The installation will continue.



#### Note

Please wait, it will take a few seconds for the software to install. After the installation, click **Restart** to finish installing the software.

**7** The Brother software will search for the Brother device. During this time the following screen will appear.

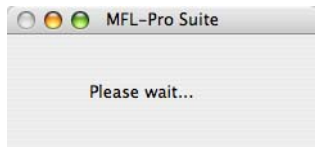

**Note**

- If the machine is configured for your network, choose the machine from the list, and then click **OK**. This window will not appear if there is only one machine connected on the network, it will be chosen automatically. Go to step **8**.



- If this screen appears click **OK**.



Enter a name for your Macintosh® in **Display Name** up to 15 characters long and click **OK**. Go to step **8**.

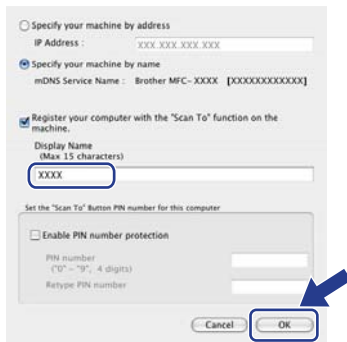

- If you want to use the machine's Scan key to scan over the network you must check the **Register your computer with the "Scan To" function on the machine box**.
- The name you enter will appear on the machine's LCD when you press the **Scan** key and choose a scan option. (For more information, see *Network Scanning in the Software User's Guide on the CD-ROM*.)

**8** When this screen appears, click **OK**.



**OK!** For Mac OS® X 10.3.x or greater users: The MFL-Pro Suite, Brother printer driver, scanner driver and Brother ControlCenter2 have been installed and the installation is now complete. Go to step **13**.

**9** For Mac OS® X 10.2.4 to 10.2.8 users: Click **Add**.

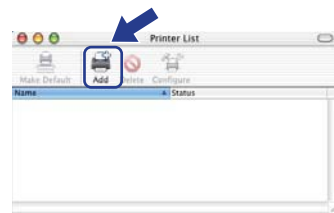

**10** Make the selection shown below.

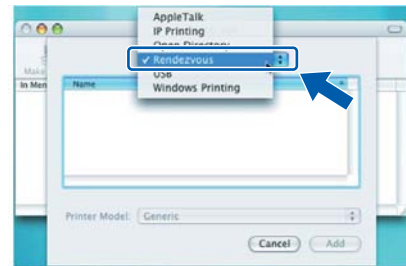

**11** Choose your model name, and then click **Add**.

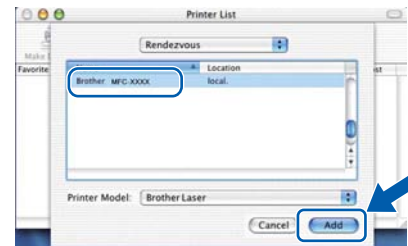

**12** Click **Print Center**, then **Quit Print Center**.

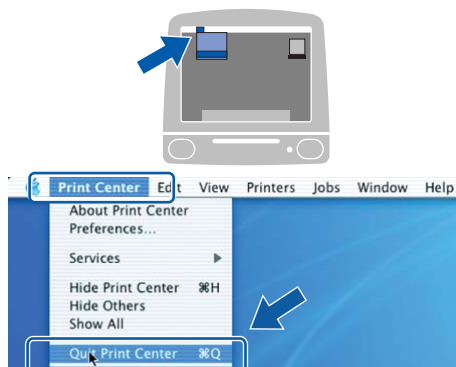

**OK!** The **MFL-Pro Suite**, **Brother printer driver**, **scanner driver** and **Brother ControlCenter2** have been installed and the installation is now complete.

**13** To install **Presto!®PageManager®**, double-click the **Presto! PageManager** icon and follow the on-screen instructions.



**Note**

*When **Presto!®PageManager®** is installed OCR capability is added to the **Brother ControlCenter2**. You can also easily scan, share and organize photos and documents using **Presto!®PageManager®**.*

**OK!** **Presto!®PageManager®** has been installed and the installation is now complete.

## For Wireless Network Interface Users (For Mac OS® X 10.2.4 or greater) in infrastructure mode

### Connecting your wireless machine and wireless network together and installing the printer driver in infrastructure mode

First you must configure the wireless network settings of your machine to communicate with your network access point (router). After the machine is configured to communicate with your access point (router) computers on your network will have access to the machine. To use the machine from these computers, you will need to install the MFL-Pro Suite. The following steps will guide you through the configuration and installation process.

To achieve optimum results with normal every day document printing, place the Brother machine as close to the network access point (router) as possible with minimal obstructions. Large objects and walls between the two devices as well as interference from other electronic devices can affect the data transfer speed of your documents.

Due to these factors, wireless may not be the best method of connection for all types of documents and applications. If you are printing large files, such as multi-page documents with mixed text and large graphics, you may want to consider choosing wired Ethernet for a faster data transfer, or USB for the fastest throughput speed.

Although the MFC can be used in both a wired and wireless network, only one of the connection methods can be used at a time.

#### Important

The following instructions will offer two methods for installing your Brother machine in a wireless network environment. Both methods are for infrastructure mode, using a wireless router or access point that uses DHCP to assign IP addresses. If your wireless router/access point supports SecureEasySetup™, Wi-Fi Protected Setup™ or AOSS™ follow the steps on page 39 *Using the SecureEasySetup™, Wi-Fi Protected Setup™ or AOSS™ software to configure your machine for a wireless network (one-push method)*. If your wireless router/access point does not support SecureEasySetup™, Wi-Fi Protected Setup™ or AOSS™ follow the steps on page 36 *Using the Setup Wizard from the control panel LAN menu for wireless network configuration (Infrastructure Mode)*. To set up your machine in any other wireless environment (Ad-hoc mode) you can find instructions in the Network User's Guide on the CD-ROM.

You can view the Network User's Guide by following the instructions below.

- 1 Turn on your Macintosh®. Insert the Brother CD-ROM into your CD-ROM drive.
- 2 If the language screen appears, click your language. The CD-ROM main menu will appear.
- 3 Double-click the **Documentation**.
- 4 Double-click the top page file in HTML format.
- 5 Double-click the **NETWORK USER'S GUIDE**.

#### Note

- If you are going to connect the printer to your network, we recommend that you contact your system administrator prior to installation.
- If you are using personal firewall software (e.g. Windows® Firewall), disable it. Once you are sure that you can print, restart your personal firewall software.

## Confirm your network environment

The setup process will be different depending on your network environment.

### ■ Infrastructure Mode

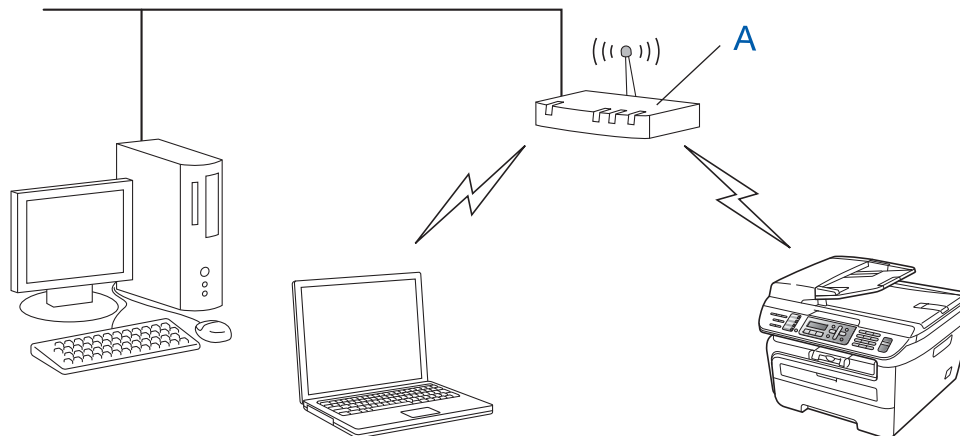

If your wireless access point (A) does not support SecureEasySetup™, Wi-Fi Protected Setup™ or AOSS™, follow the instructions, on page 36.

### ■ Installation using SecureEasySetup™, Wi-Fi Protected Setup™ or AOSS™ .

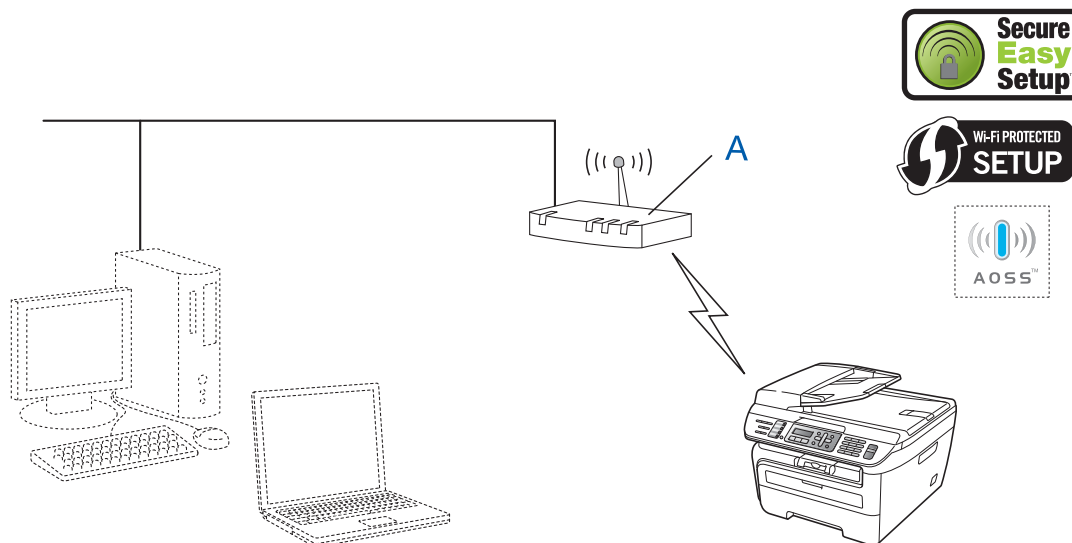

If your wireless access point (A) supports SecureEasySetup™, Wi-Fi Protected Setup™ or AOSS™, you do not need to use a computer to configure the machine. The access point (router) and your machine can automatically negotiate using the SecureEasySetup™ procedure. For instructions, go to page 39.

### ■ Configuration using the PIN Method of Wi-Fi Protected Setup™

If your wireless access point(A) supports Wi-Fi Protected Setup™, you can also configure using the PIN Method of Wi-Fi Protected Setup™. For instructions, see the Network User's Guide on the CD-ROM.

## Using the Setup Wizard from the control panel LAN menu for wireless network configuration (Infrastructure Mode)

### Important

**Make sure that you have finished the instructions from step 1 *Setting Up the Machine* on pages 4 through 11.**

These instructions will install your Brother machine in a typical small office or home wireless network environment in infrastructure mode, using a wireless router or access point that uses DHCP to assign IP addresses.

If you want to setup your machine in any other wireless environment you can find instructions in the Network User's Guide on the CD-ROM.

You can view the Network User's Guide by following the instructions below.

- 1 Turn on your Macintosh®. Insert the Brother CD-ROM into your CD-ROM drive.
- 2 Double-click **Documentation**.
- 3 Double-click your language folder.
- 4 Double-click the **HTML document**.
- 5 Double-click the **Network User's Guide**.

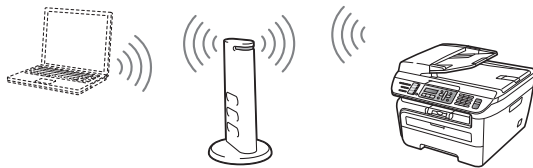

**Before you begin you must know your wireless network settings.**

- 1 Write down the wireless network settings of your access point or wireless router.

**SSID** (Service Set ID or Network name)

\_\_\_\_\_

**WEP Key** (if needed)

\_\_\_\_\_

**WPA-PSK Password** (if needed)

\_\_\_\_\_

**Encryption** (TKIP or AES)

\_\_\_\_\_

**LEAP user name** (if needed)

\_\_\_\_\_

**LEAP password**

*The WEP key is for 64-bit encrypted networks or 128-bit encrypted networks and can contain both numbers and letters. If you do not know this information you should see the documentation provided with your access point or wireless router. This key is a 64-bit or 128-bit value that must be entered in an ASCII or HEXADECIMAL format.*

### For example:

- |              |  |
|--------------|--|
| 64-bit       | Uses 5 text characters.                          |
| ASCII:       | e.g. "Hello" (this is case sensitive)            |
| 64-bit       | Uses 10 digits of hexadecimal data.              |
| Hexadecimal: | e.g. "71f2234aba"                                |
| 128-bit      | Uses 13 text characters.                         |
| ASCII:       | e.g. "Wirelesscomms"<br>(this is case sensitive) |
| 128-bit      | Uses 26 digits of hexadecimal data.              |
| Hexadecimal: | e.g.<br>"71f2234ab56cd709e5412aa3ba"             |

WPA-PSK enables a Protected Access Pre-shared key that allows the Brother wireless machine to associate with access points using TKIP and AES encryption. WPA-PSK uses a Pre-Shared Key that is 8 or more characters in length, up to a maximum of 63 characters.

Cisco® LEAP has been developed by Cisco Systems, Inc. which uses user ID and password for authentication. The LEAP User ID is up to a maximum of 63 characters in length, and the Password is up to a maximum of 31 characters in length.

See Chapter 3 of the Network User's Guide for more details.

- 2** Plug the AC power cord into an AC outlet. Turn the power switch on.

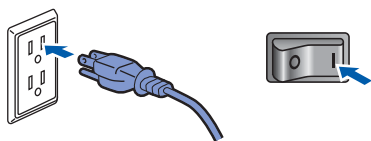

### ⊘ Improper Setup



If you have previously configured the wireless settings of the machine you must reset the network (LAN) settings before you can configure the wireless settings again. Press **Menu, 5, 2, 6** (or **Menu, 5, 0, 1**) and then press **1** to accept the change.

- 3** On your machine, press **Menu, 5, 2, 2**.

```
WLAN Enable?
1.On 2.Off
```

Press **1** to choose **On**. The wired network interface will become inactive with this setting.

- 4** The machine will search for your network and display a list of available SSIDs. You should see the SSID you wrote down earlier. If the machine finds more than one network use the

 or  to choose your network, then

press **OK**. Go to step **8**.

```
Select ▲▼ or OK
salesgroup
```

### Note

*It will take several seconds to display a list of available SSIDs.*



If your access point is set to not broadcast the SSID you will have to manually add the SSID name. Go to step **5**.

- 5** Select **<New SSID>** using the  or  and press **OK**. Go to step **6**.



```
Select SSID&Set
<New SSID>
```

- 6** Enter a new SSID and press **OK**. For information how to type text, see *Entering text* on page 46.



```
SSID:
```

- 7** Press the  or  to choose **Infrastructure**, then press **OK**.

```
Mode Select
Infrastructure
```

- 8** Use the  or  and **OK** keys to choose one of the options below: If your network is configured for Authentication and Encryption you must match the settings used for your network.

**No Authentication or Encryption:** Choose **Open System**, press **OK** then choose **None** for **Encryption Type** and press **OK**. Then press **1** to apply your settings. Go to step **12**.

**No Authentication with WEP Encryption:** Choose **Open System**, press **OK** then use the  or  to choose **WEP** for the **Encryption Type** and press **OK**. Go to step **9**.

**Authentication with WEP Encryption:** Choose **Shared Key**, press **OK**. Go to step **9**.

**Authentication with WPA/WPA2-PSK (TKIP or AES Encryption):** Choose **WPA/WPA2-PSK**, press **OK**. Go to step **10**.



**Authentication with LEAP:** Choose **LEAP**, press **OK**. Go to step **11**.



- 9** Choose the appropriate key number and press **OK**.







Set WEP KEY  
KEY1:

Enter the WEP key you wrote down in step 1 using the dial pad. You can use the  or  to move the cursor. For example, to enter the letter a, press the **2** key on the dial pad once. To enter the number 3, press the **3** key on the dial pad seven times.



The letters appear in this order: lower case, upper case, numbers and then special letters.

Press **OK** when you have entered all the characters, then press **1** to apply your settings. Go to step 12.

**Most access points and routers can store more than one key, but they will only use one at any time for authentication and encryption.**

- 10** Press the  or  to choose TKIP or AES for Encryption Type and press **OK**. Enter the WPA-PSK Password you wrote down in step 1 using the dial pad. You can use the  or  to move the cursor. For example, to enter the letter a, press the **2** key on the dial pad once. To enter the number 3, press the **3** key on your dial pad seven times.

Press **OK** when you have entered all the characters, then press **1** to apply your settings. Go to step 12.

- 11** Enter the user name and press **OK**. You can use the  or  to move the cursor. For example, to enter the letter a, press the **2** key on the dial pad once.

Enter the password and press **OK**, and then press **1** to apply your settings. Go to step 12. (Use the chart on *Entering text* on page 46.)

- 12** Your machine will now try to connect to your wireless network using the information you have entered. If successful, Connected will appear briefly on the LCD.

Connection NG is displayed when the print server has not successfully connected to your router or access point. Try starting from step 3 again. If the same message is displayed again, reset the print server back to the default factory settings and try again. (See *Restoring the network settings to factory default* on page 45.)

- 13** The machine will automatically acquire the correct TCP/IP address information from your access point (router) if DHCP is enabled (DHCP is normally enabled as default for most access point routers).

*If your access point does not have DHCP enabled you will need to manually configure the IP address, subnet mask and gateway of the machine to suit your network. See the Network User's Guide for details.*



**Wireless setup is now complete. To install the MFL-Pro suite, continue to step 7 on page 40.**



## Using the SecureEasySetup™, Wi-Fi Protected Setup™ or AOSS™ software to configure your machine for a wireless network (one-push method)

If your wireless access point supports either SecureEasySetup™, Wi-Fi Protected Setup™ (PBC<sup>1</sup>) or AOSS™, you can configure the machine easily without a computer. By pushing a button on the wireless router or access point, you can setup the wireless network and security settings. See the user's guide for your wireless LAN router or access point for instructions on how to access one-push mode. If your wireless router or access point does not support SecureEasySetup™, Wi-Fi Protected Setup™ or AOSS™ go to the page 36 for installation instructions.

<sup>1</sup> Push Button Configuration



### Note

Routers or access points that support SecureEasySetup™, Wi-Fi Protected Setup™ or AOSS™ have the symbols as shown below.



- 1 Plug the AC power cord into an AC outlet. Turn the power switch on.

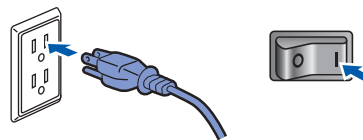

### Improper Setup

If you have previously configured the wireless settings of the machine you must reset the network (LAN) settings before you can configure the wireless settings again. Press Menu, 5, 2, 6 (or Menu, 5, 0, 1) and then press 1 to accept the change.

- 2 Place the Brother machine close to the SecureEasySetup™, Wi-Fi Protected Setup™ or AOSS™ router or access point.
- 3 Push the SecureEasySetup™, Wi-Fi Protected Setup™ or AOSS™ button on your wireless router or access point. See the user's guide for your wireless router or access point for instructions.
- 4 Press Menu, 5, 2, 3 on the control panel of the Brother machine.

```
WLAN Enable?
1.On 2.Off
```

Press 1 to choose On. The wired network interface will become inactive with this setting.

This feature will automatically detect which mode (SecureEasySetup™, Wi-Fi Protected Setup™ or AOSS™) your access point uses to configure your machine.

### Note

If your wireless access point supports Wi-Fi Protected Setup™ (PIN Method) and you want to configure your machine using the PIN (Personal Identification Number) Method, see Using the PIN Method of Wi-Fi Protected Setup™ in the Network User's Guide.

- The machine searches for an access point that supports SecureEasySetup™, Wi-Fi Protected Setup™ or AOSS™ for 2 minutes.



- If the LCD shows Connected, the machine has successfully connected to your router or access point. You can now use your machine in a wireless network.

If the LCD shows Setting WLAN, Connecting SES (Connecting WPS OR Connecting AOSS), then Connection NG, the machine has not successfully connected to your router or access point. Try starting from 4 again. If the same message is indicated again, reset the machine back to the default factory settings and try again. For resetting, see *Restoring the network settings to factory default* on page 45.

If the LCD shows Setting WLAN, then Connection NG or Incorrect Mode, a session overlap or connection failure has been detected (See the Note below). The machine has detected more than 2 routers or access points on your network that have the SecureEasySetup™, Wi-Fi Protected Setup™ mode or the AOSS™ mode enabled. Make sure that only one router or access point has the SecureEasySetup™ mode, Wi-Fi Protected Setup™ mode or the AOSS™ mode enabled and try starting from 4 again.



**Note**  
*LCD messages when using the SES/WPS/AOSS control panel menu*

Setting WLAN	Searching or accessing the access point and downloading settings from the access point.
Connecting SES/WPS/AOSS	Connecting to the access point.
Connection NG	Connection failed. (If it is shown after the LCD shows Connecting SES/WPS/AOSS.)
	Session overlap is detected.
Incorrect Mode	Session overlap is detected.

- Turn on your Macintosh®.
- Put the supplied CD-ROM into your CD-ROM drive.

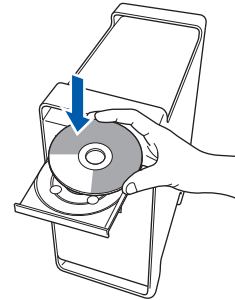

- Double-click the **Start Here OSX** icon to install. Follow the on-screen instructions.



**Note**  
*Please see the Software User's Guide on the CD-ROM if you want to install the PS driver.*

- Choose **Wireless Network Connection**, and then click **Next**.



- Click on the **Checked and confirmed** check box, and then click **Next**. Follow the on screen instructions.

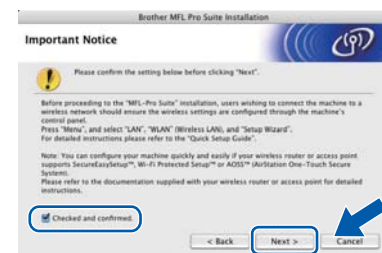

Please wait, it will take a few seconds for the software to install. After the installation, click **Restart** to finish installing the software.



**Wireless setup is now complete. To install the MFL-Pro Software suite, continue to step 7.**

- 12** The Brother software will search for the Brother device. During this time the following screen will appear.

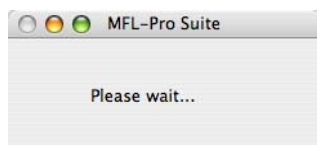

**Note**

- If the machine is configured for your network, choose the machine from the list, and then click **OK**. This window will not appear if there is only one machine connected on the network, it will be chosen automatically. Go to step **13**.

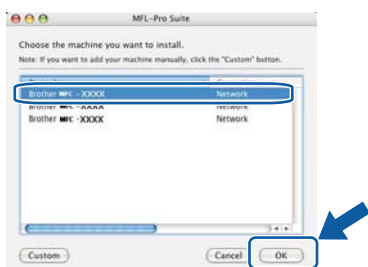

- If this screen appears click **OK**.



Enter a name for your Macintosh® in **Display Name** up to 15 characters long and click **OK**. Go to step **13**.

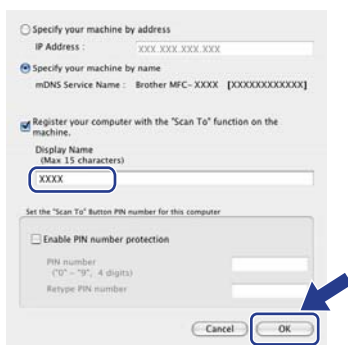

- If you want to use the machine's Scan key to scan over the network you must check the **Register your computer with the "Scan To" function on the machine** box.
- The name you enter will appear on the machine's LCD when you press the **Scan** key and choose a scan option. (For more information, see *Network Scanning in the Software User's Guide on the CD-ROM*.)

- 13** When this screen appears, click **OK**.



- OK!** For Mac OS® X 10.3.x or greater users: The MFL-Pro Suite, Brother printer driver, scanner driver and Brother ControlCenter2 have been installed and the installation is now complete. Go to step **18**.

- 14** For Mac OS® X 10.2.4 to 10.2.8 users: Click **Add**.

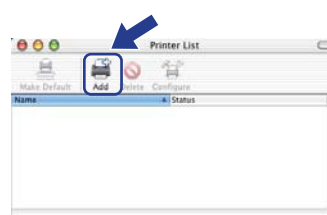

- 15** Make the selection shown below.

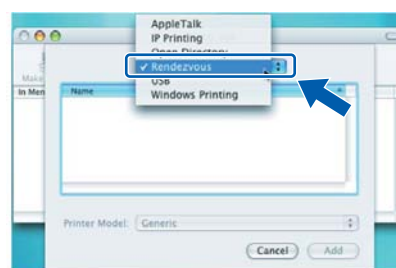

- 16** Choose your model name, and then click **Add**.

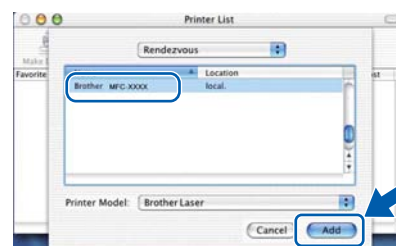

- 17** Click **Print Center**, then **Quit Print Center**.

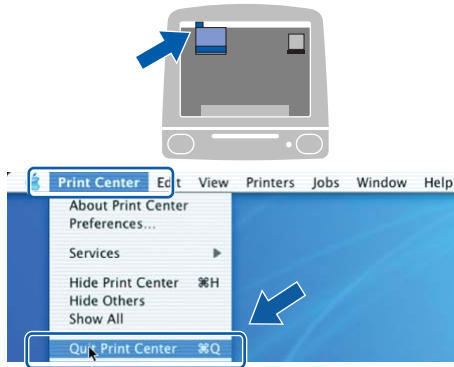

- OK!** The **MFL-Pro Suite**, **Brother printer driver**, **scanner driver** and **Brother ControlCenter2** have been installed and the installation is now complete.

- 18** To install **Presto!® PageManager®**, double-click the **Presto! PageManager** icon and follow the on-screen instructions.

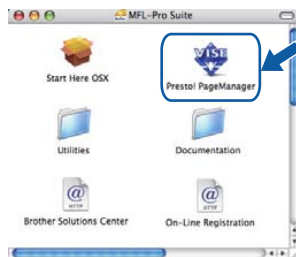

**Note**

*When **Presto!® PageManager®** is installed OCR capability is added to the **Brother ControlCenter2**. You can also easily scan, share and organize photos and documents using **Presto!® PageManager®**.*

- OK!** **Presto!® PageManager®** has been installed and the installation is now complete.

## BRAdmin Light utility (For Windows® users)

BRAdmin Light is a utility for initial setup of Brother network connected devices. It also can search for Brother products on your network, view the status and configure basic network settings, such as IP address. For more information on BRAdmin Light, visit us at <http://solutions.brother.com/>.



**Note** *If you require more advanced printer management, use the latest Brother BRAdmin Professional utility version that is available as a download from <http://solutions.brother.com/>.*

### Installing the BRAdmin Light configuration utility



**Note** *The default password for the print server is 'access'. You can use BRAdmin Light to change this password.*

- 1 Click **Install Other Drivers or Utilities** on the menu screen.



- 2 Click **BRAdmin Light** and follow the on-screen instructions.



### Setting your IP address, Subnet Mask and Gateway using BRAdmin Light



**Note** *If you have a DHCP/BOOTP/RARP server in your network, you don't have to do the following operation. The print server will automatically obtain its own IP address.*

- 1 Start BRAdmin Light. It will search for new devices automatically.

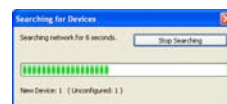

- 2 Double-click the unconfigured device.

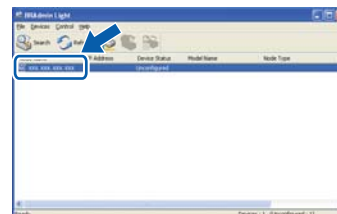

- 3 Choose **STATIC** for the **Boot Method**. Enter the **IP Address**, **Subnet Mask** and **Gateway**, and then click **OK**.



- 4 The address information will be saved to the machine.

## BRAdmin Light utility (For Mac OS® X users)

BRAdmin Light is a utility for initial setup of Brother network connected devices. It also can search for Brother products on your network, view the status and configure basic network settings, such as IP address from a computer running Mac OS® X 10.2.4 or greater.

The BRAdmin Light software will be installed automatically when you install the printer driver. If you have already installed the printer driver, you don't have to install it again. For more information on BRAdmin Light, visit us at <http://solutions.brother.com/>.

### Setting your IP address, Subnet Mask and Gateway using BRAdmin Light

#### Note

- If you have a DHCP/BOOTP/RARP server in your network, you don't have to do the following operation. The print server will automatically obtain its own IP address.
- Make sure that version 1.4.1\_07 or later of Java™ client software is installed on your computer.
- The default password for the print server is 'access'. You can use BRAdmin Light to change this password.

- 1 Double-click the **Macintosh HD** icon on your desktop.

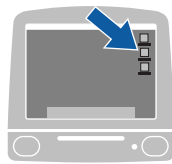

- 2 Choose **Library**, **Printers**, **Brother** and then **Utilities**.

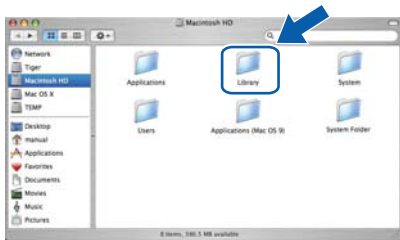

- 3 Double-click the file **BRAdmin Light.jar** and run the software. BRAdmin Light will then search for new devices automatically.

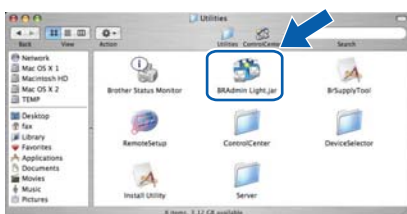

- 4 Double-click the unconfigured device.

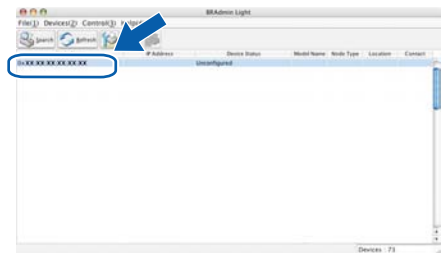

- 5 Choose **STATIC** for the **Boot Method**. Enter the **IP Address**, **Subnet Mask** and **Gateway**, and then click **OK**.



- 6 The address information will be saved to the machine.



## Web Based Management (web browser)

The Brother print server is equipped with a web server that allows you to monitor its status or change some of its configuration settings, using HTTP (Hyper Text Transfer Protocol).

### Note

- The User Name is **'admin'** and the default password is **'access'**. You can use a web browser to change this password.
- We recommend Microsoft Internet Explorer 6.0<sup>®</sup> (or higher) or Firefox<sup>®</sup> 1.0 (or higher) for Windows<sup>®</sup> and Safari<sup>™</sup> 1.0 for Macintosh<sup>®</sup>. Please also make sure that JavaScript and cookies are always enabled in whichever browser you use. We recommend you upgrade to Safari<sup>™</sup> 1.2 or higher to enable JavaScript. To use a web browser, you will need to know the IP address of the print server.

- 1 Open your browser.
- 2 Type `http:// printer_ip_address /` into your browser (Where "printer\_ip\_address" is the IP address of the printer or the print server name).
  - For example `http://192.168.1.2/`

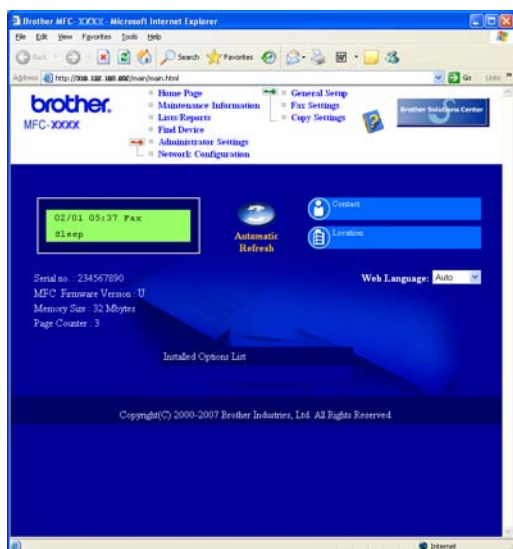

 See Chapter 2 of the Network User's Guide.



## Restoring the network settings to factory default

To restore all network settings of the internal Print/Scan server to factory default, please follow the steps below.

- 1 Make sure the machine is not in use, then disconnect all the cables from the machine (except power cable).
- 2 Press **Menu, 5, 0**.
- 3 Press **1** to select **Reset**.
- 4 Press **1** to select **Yes**.
- 5 The machine will restart. Re-connect cables once this is complete.

## Print the Network Configuration List

You can print the Network Configuration List to confirm the current network settings. To print the Network Configuration List:

- 1 Make sure that the front cover is closed and the AC power cord is plugged in.
- 2 Turn on the machine and wait until the machine is in the Ready state.
- 3 Press **Reports** and  or  to select **Network Configuration**. Press **OK**. The machine will print the current network settings.



## Entering text

When setting certain menu selections, such as the Station ID, you will need to type text characters. The dial pad keys have letters printed on them. The keys: **0**, **#** and **\*** do *not* have printed letters because they are used for special characters.

Press the appropriate dial pad key the required number of times to access the characters below:

Press Key	one time	two times	three times	four times
<b>2</b>	A	B	C	2
<b>3</b>	D	E	F	3
<b>4</b>	G	H	I	4
<b>5</b>	J	K	L	5
<b>6</b>	M	N	O	6
<b>7</b>	P	Q	R	S
<b>8</b>	T	U	V	8
<b>9</b>	W	X	Y	Z

### Inserting spaces

To enter a space in a fax number, press the  once between numbers. To enter a space in a name, press the  twice between characters.



### Making corrections

If you entered a letter incorrectly and want to change it, press the  to move the cursor to the incorrect character, and then press **Clear/Back**.

### Repeating letters

To enter a character on the same key as the previous character, press the  to move the cursor right before pressing the key again.

### Special characters and symbols

Press **\***, **#** or **0**, then press the  or  to move the cursor to the symbol or character you want. Press **OK** to choose it. The symbols and characters below will appear depending on your menu selection.

Press **\*** for (space) ! " # \$ % & ' ( ) \* + , - . / €  
Press **#** for ; < = > ? @ [ ] ^ \_ ¥ ~ ` | { }  
Press **0** for É À È Ê Î Ç Ë Ö 0

## Consumables

When the time comes to replace consumable items, an error message will be indicated on the LCD. For more information about the consumables for your machine, visit us at <http://solutions.brother.com/> or contact your local Brother reseller.

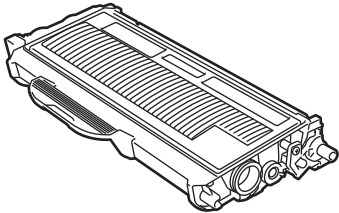
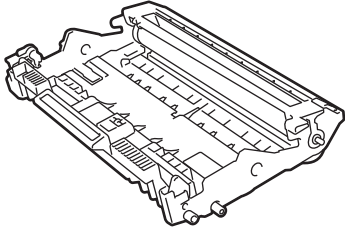
<b>Toner Cartridge</b>	<b>Drum Unit</b>
<b>TN-330/TN-360</b>	<b>DR-360</b>
	



## **Trademarks**

The Brother logo is a registered trademark of Brother Industries, Ltd.

Brother is a registered trademark of Brother Industries, Ltd.

Multi-Function Link is a registered trademark of Brother International Corporation.

Windows Vista is either a registered trademark or a trademark of Microsoft Corporation in the United States and other countries.

Microsoft, Windows and Windows Server are registered trademarks of Microsoft Corporation in the United States and/or other countries.

Macintosh and True Type are registered trademarks of Apple Inc.

Postscript and Postscript 3 are registered trademarks or trademarks of Adobe Systems Incorporated.

Nuance, the Nuance logo, PaperPort and ScanSoft are trademarks or registered trademarks of Nuance Communications, Inc. or its affiliates in the United States and / or other countries.

Presto! PageManager is a registered trademark of NewSoft Technology Corporation.

BROADCOM, SecureEasySetup and the SecureEasySetup logo are trademarks or registered trademarks of Broadcom Corporation.

AOSS is a trademark of Buffalo Inc.

Wi-Fi, WPA and WPA2 are registered trademarks and Wi-Fi Protected Setup is a trademark of Wi-Fi Alliance.

Each company whose software title is mentioned in this manual has a Software License Agreement specific to its proprietary programs.

**All other brand and product names mentioned in this manual are trademarks or registered trademarks of their respective companies.**

## **Compilation and Publication**

Under the supervision of Brother Industries Ltd., this manual has been compiled and published, covering the latest product descriptions and specifications.

The contents of this manual and the specifications of this product are subject to change without notice.

Brother reserves the right to make changes without notice in the specifications and materials contained herein and shall not be responsible for any damages (including consequential) caused by reliance on the materials presented, including but not limited to typographical and other errors relating to the publication.

This product is designed for use in a Professional Environment.

**brother**®



## Free Manuals Download Website

<http://myh66.com>

<http://usermanuals.us>

<http://www.somanuals.com>

<http://www.4manuals.cc>

<http://www.manual-lib.com>

<http://www.404manual.com>

<http://www.luxmanual.com>

<http://aubethermostatmanual.com>

Golf course search by state

<http://golfingnear.com>

Email search by domain

<http://emailbydomain.com>

Auto manuals search

<http://auto.somanuals.com>

TV manuals search

<http://tv.somanuals.com>