

fx-CG10

fx-CG20

fx-CG20 AU

Software Version 2.01

User's Guide

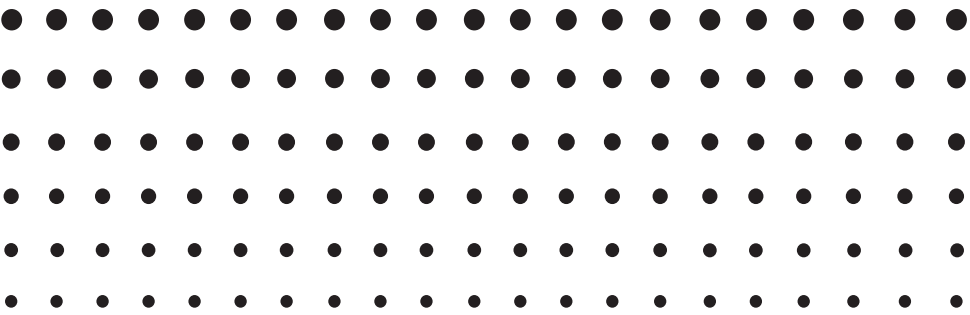

CASIO Worldwide Education Website

<http://edu.casio.com>

Manuals are available in multi languages at

<http://world.casio.com/manual/calc>

- The contents of this user's guide are subject to change without notice.
- No part of this user's guide may be reproduced in any form without the express written consent of the manufacturer.
- Be sure to keep all user documentation handy for future reference.

Contents

Getting Acquainted — Read This First!

Chapter 1 Basic Operation

1. Keys	1-1
2. Display	1-3
3. Inputting and Editing Calculations.....	1-7
4. Using the Math Input/Output Mode	1-13
5. Option (OPTN) Menu	1-27
6. Variable Data (VARS) Menu	1-28
7. Program (PRGM) Menu	1-31
8. Using the Setup Screen	1-32
9. Using Screen Capture.....	1-36
10. When you keep having problems... ..	1-37

Chapter 2 Manual Calculations

1. Basic Calculations.....	2-1
2. Special Functions.....	2-7
3. Specifying the Angle Unit and Display Format.....	2-12
4. Function Calculations.....	2-14
5. Numerical Calculations	2-25
6. Complex Number Calculations.....	2-35
7. Binary, Octal, Decimal, and Hexadecimal Calculations with Integers.....	2-39
8. Matrix Calculations.....	2-42
9. Vector Calculations	2-59
10. Metric Conversion Calculations.....	2-64

Chapter 3 List Function

1. Inputting and Editing a List.....	3-1
2. Manipulating List Data.....	3-7
3. Arithmetic Calculations Using Lists	3-13
4. Switching between List Files	3-17
5. Using CSV Files	3-18

Chapter 4 Equation Calculations

1. Simultaneous Linear Equations	4-1
2. High-order Equations from 2nd to 6th Degree	4-3
3. Solve Calculations.....	4-4

Chapter 5 Graphing

1. Sample Graphs	5-1
2. Controlling What Appears on a Graph Screen.....	5-5
3. Drawing a Graph	5-13
4. Saving and Recalling Graph Screen Contents.....	5-20
5. Drawing Two Graphs on the Same Screen.....	5-23
6. Manual Graphing.....	5-25
7. Using Tables	5-30
8. Modifying a Graph.....	5-36
9. Dynamic Graphing	5-40
10. Graphing a Recursion Formula	5-43
11. Graphing a Conic Section	5-48

12. Drawing Dots, Lines, and Text on the Graph Screen (Sketch)	5-50
13. Function Analysis	5-52
Chapter 6 Statistical Graphs and Calculations	
1. Before Performing Statistical Calculations	6-1
2. Calculating and Graphing Single-Variable Statistical Data	6-8
3. Calculating and Graphing Paired-Variable Statistical Data (Curve Fitting)	6-15
4. Performing Statistical Calculations.....	6-23
5. Tests	6-33
6. Confidence Interval	6-47
7. Distribution	6-50
8. Input and Output Terms of Tests, Confidence Interval, and Distribution	6-66
9. Statistic Formula	6-69
Chapter 7 Financial Calculation	
1. Before Performing Financial Calculations	7-1
2. Simple Interest	7-3
3. Compound Interest.....	7-4
4. Cash Flow (Investment Appraisal)	7-7
5. Amortization	7-9
6. Interest Rate Conversion	7-12
7. Cost, Selling Price, Margin.....	7-13
8. Day/Date Calculations.....	7-14
9. Depreciation	7-15
10. Bond Calculations	7-17
11. Financial Calculations Using Functions	7-20
Chapter 8 Programming	
1. Basic Programming Steps.....	8-1
2. Program Mode Function Keys.....	8-2
3. Editing Program Contents	8-4
4. File Management	8-6
5. Command Reference	8-11
6. Using Calculator Functions in Programs.....	8-28
7. Program Mode Command List	8-51
8. CASIO Scientific Function Calculator Special Commands \leftrightarrow Text Conversion Table	8-59
9. Program Library	8-66
Chapter 9 Spreadsheet	
1. Spreadsheet Basics and the Function Menu	9-1
2. Basic Spreadsheet Operations	9-3
3. Using Special Spreadsheet Mode Commands	9-19
4. Conditional Formatting.....	9-21
5. Drawing Statistical Graphs, and Performing Statistical and Regression Calculations.....	9-27
6. Spreadsheet Mode Memory.....	9-34
Chapter 10 eActivity	
1. eActivity Overview.....	10-1
2. eActivity Function Menus	10-2
3. eActivity File Operations	10-4
4. Inputting and Editing Data.....	10-6

Chapter 11 Memory Manager	
1. Using the Memory Manager.....	11-1
Chapter 12 System Manager	
1. Using the System Manager.....	12-1
2. System Settings	12-1
Chapter 13 Data Communication	
1. Performing Data Communication between the Calculator and a Personal Computer	13-3
2. Performing Data Communication between Two Calculators.....	13-10
3. Connecting the Calculator to a Projector	13-16
Chapter 14 Geometry	
1. Geometry Mode Overview	14-1
2. Drawing and Editing Objects.....	14-11
3. Controlling the Appearance of the Geometry Window	14-33
4. Using Text and Labels in a Screen Image	14-37
5. Using the Measurement Box.....	14-41
6. Working with Animations.....	14-56
Chapter 15 Picture Plot	
1. Picture Plot Function Menus	15-3
2. Managing Picture Plot Files	15-5
3. Using the Plot Function.....	15-7
4. Using the Plot List	15-13
5. Common Functions with the Graph Mode	15-18
Appendix	
1. Error Message Table	α-1
2. Input Ranges	α-14
E-CON3 Application	
1. E-CON3 Overview.....	ε-1
2. Using the Setup Wizard	ε-2
3. Using Advanced Setup.....	ε-8
4. Using a Custom Probe	ε-19
5. Using the MULTIMETER Mode.....	ε-23
6. Using Setup Memory.....	ε-24
7. Using Program Converter	ε-27
8. Starting a Sampling Operation.....	ε-30
9. Using Sample Data Memory	ε-33
10. Using the Graph Analysis Tools to Graph Data	ε-35
11. Graph Analysis Tool Graph Screen Operations.....	ε-39
12. Calling E-CON3 Functions from an eActivity	ε-50

■ About this User's Guide

• Math natural input and display



Under its initial default settings, the calculator is set up to use the “Math input/output mode”, which enables natural input and display of math expressions. This means you can input fractions, square roots, derivatives, and other expressions just as they are written. In the “Math input/output mode”, most calculation results also are displayed using natural display.

You also can select a “Linear input/output mode” if you like, for input and display of calculation expressions in a single line.







The examples shown in this User's Guide are mainly presented using the Math input/output mode. “<Linear input/output mode>” will be indicated for examples that use the Linear input/output mode.

- For information about switching between the Math input/output mode and Linear input/output mode, see the explanation of the “Input/Output” mode setting under “Using the Setup Screen” (page 1-32).
- For information about input and display using the Math input/output mode, see “Using the Math Input/Output Mode” (page 1-13).







• ($\sqrt{\quad}$)

The above indicates you should press  and then , which will input a $\sqrt{\quad}$ symbol. All multiple-key input operations are indicated like this. Key cap markings are shown, followed by the input character or command in parentheses.

• Equation

This indicates you should first press , use the cursor keys (, , , ) to select the **Equation** mode, and then press . Operations you need to perform to enter a mode from the Main Menu are indicated like this.

• Function Keys and Menus

- Many of the operations performed by this calculator can be executed by pressing function keys  through . The operation assigned to each function key changes according to the mode the calculator is in, and current operation assignments are indicated by function menus that appear at the bottom of the display.
- This User's Guide shows the current operation assigned to a function key in parentheses following the key cap for that key.  (Comp), for example, indicates that pressing  selects {Comp}, which is also indicated in the function menu.
- When () is indicated in the function menu for key , it means that pressing  displays the next page or previous page of menu options.

• Menu Titles

- Menu titles in this User's Guide include the key operation required to display the menu being explained. The key operation for a menu that is displayed by pressing **[OPTN]** and then {LIST} would be shown as: **[OPTN]-[LIST]**.
- **[F6]** (▷) key operations to change to another menu page are not shown in menu title key operations.

• Command List

The **Program** Mode Command List (page 8-51) provides a graphic flowchart of the various function key menus and shows how to maneuver to the menu of commands you need.

Example: The following operation displays Xfct: **[VARS]-[FACTOR]-[Xfct]**

■ Display Brightness Adjustment

Adjust the brightness whenever objects on the display appear dim or difficult to see.

1. Use the cursor keys (▲, ▼, ◀, ▶) to select the **System** icon and press **[EXE]**, then press **[F1]** (DISPLAY) to display the brightness adjustment screen.

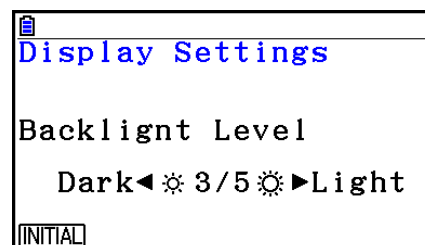

2. Adjust the brightness.
 - The ▶ cursor key makes display brightness lighter.
 - The ◀ cursor key makes display brightness darker.
 - **[F1]** (INITIAL) returns display brightness to its initial default.
3. To exit display brightness adjustment, press **[MENU]**.

■ Examination Mode

The Examination Mode puts some limits on calculator functions, which allows it to be used when taking an exam or test. Use the Examination Mode only when actually taking an exam or test.

Entering the Examination Mode affects calculator operation as described below.

- The following modes and functions are disabled: **eActivity** mode, **Memory** mode, **E-CON3** mode, **Program** mode, vector commands, program commands (▲ (output command), : (multi-statement command), ↵ (carriage return)), data transfer, add-in applications, add-in languages, storage memory access, user name editing, OS Update.
- User data (main memory) is backed up. The backed up data will be restored when you exit the Examination Mode. Any data created during an Examination Mode session will be deleted when the Examination Mode is exited.

• Entering the Examination Mode

1. Press **SHIFT** **AC/ON** (OFF) to turn off the calculator.
2. While holding down the **cos** and **7** keys, press the **AC/ON** key.
 - This displays the dialog box shown below.

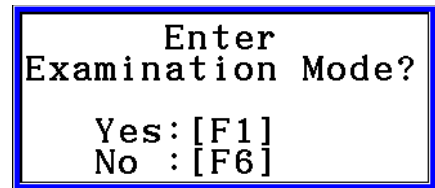

3. Press **F1** (Yes).
 - Read the message on the dialog box that appears.
4. Press **F2**.
 - This displays the dialog box shown below.

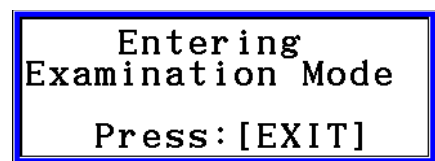

5. Press **EXIT**.

- Only the settings below are saved before entering the Examination Mode.
Input/Output, Frac Result, Angle, Complex Mode, Display, Q1Q3 Type, Language, Function menu language, Battery Type

• Calculator Operation in the Examination Mode

- Entering the Examination Mode causes the entire display screen to be surrounded by a green boundary. A flashing display icon (**R**) will also appear on the display. The flash rate of the icon slows down about 15 minutes after entering the Examination Mode.

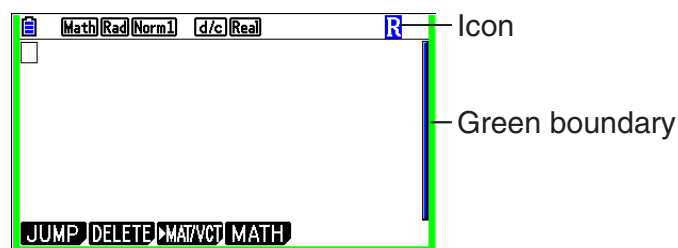

- In the Examination Mode, the Auto Power Off trigger setting is fixed at approximately 60 minutes.

- Pressing **[ALPHA] [←]** causes the dialog box shown below to appear. The dialog box shows the elapsed time in the Examination Mode.

Elapsed Time
2:59:27

Press: [EXIT]

You can restart the elapsed time count by performing one of the operations below.

- Press the RESTART button.
 - Remove the calculator's batteries.
 - Delete Main Memory data.
 - Re-enter the Examination Mode while already in the Examination Mode.
- The table below shows how certain operations affect the Examination Mode.

If you do this:	The calculator stays in Examination Mode.	Data input in Examination Mode is retained.
Turn power off and then back on again	Yes	Yes
Press the RESTART button	Yes	No
Remove the calculator's batteries	Yes	No
Delete Main Memory data	Yes	No

• Exiting the Examination Mode

There are three ways to exit the Examination Mode.

(1) Exiting the Examination Mode by Connecting to a Computer

1. Use the USB cable to connect the calculator that is in the Examination Mode to a computer.
2. When the "Select Connection Mode" dialog box appears on the calculator, press the calculator's **[F1]** key.
3. On the computer, open the calculator drive.
4. On the computer, copy or delete any file that is on the calculator drive.
5. Terminate the connection between the calculator and computer.
 - The dialog box shown below will appear when you exit the Examination Mode.

Exit
Examination Mode

Restart and
restore memories
Press: [EXIT]

(2) Exiting the Examination Mode by Allowing 12 Hours to Elapse

Approximately 12 hours after entering the Examination Mode, turning on the calculator will cause it to exit the Examination Mode automatically.

Important!

If you press the RESTART button or if you replace batteries before turning on the calculator, it will re-enter the Examination Mode when turned on, even if 12 hours have elapsed.

(3) Exiting the Examination Mode by Connecting to another Calculator

1. On the calculator that is in the Examination Mode (Calculator A), enter the **Link** mode and then press **F4** (CABLE) **F2** (3PIN).
2. Use the SB-62 cable to connect Calculator A to another calculator that is not in the Examination Mode (Calculator B).
3. On Calculator A, press **F2** (RECV).
4. On Calculator B*, enter the **Link** mode and then press **F3** (EXAM) **F1** (UNLOCK) **F1** (Yes).

- You could also transfer any data from Calculator B to Calculator A.

Example: To transfer setup data to Calculator A

1. On Calculator B, enter the **Link** mode and then press **F1** (TRANSMIT) **F1** (MAIN) **F1** (SELECT).
2. Use **▼** and **▲** to select "SETUP".
3. Press **F1** (SELECT) **F6** (TRANSMIT) **F1** (Yes).

* Calculator with Examination Mode function

- Exiting the Examination Mode will cause the green boundary and flashing icon (**R**) to disappear from the display.

• **Displaying Examination Mode Help**

You can display Examination Mode help in the **Link** mode.

F3 (EXAM) **F2** (ENTER) ... Displays help about entering the Examination Mode.

F3 (EXAM) **F3** (APP) ... Displays help about what modes and functions are disabled in the Examination Mode.

F3 (EXAM) **F4** (EXIT) ... Displays help about exiting the Examination Mode.

■ Key Markings

Many of the calculator's keys are used to perform more than one function. The functions marked on the keyboard are color coded to help you find the one you need quickly and easily.

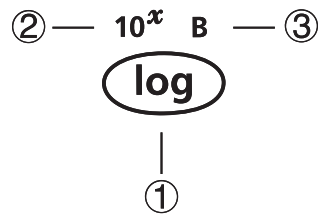

	Function	Key Operation
①	log	log
②	10^x	SHIFT log
③	B	ALPHA log

The following describes the color coding used for key markings.

Color	Key Operation
Yellow	Press SHIFT and then the key to perform the marked function.
Red	Press ALPHA and then the key to perform the marked function.

- ALPHA-LOCK ALPHA Alpha Lock

Normally, once you press ALPHA and then a key to input an alphabetic character, the keyboard reverts to its primary functions immediately.

If you press SHIFT and then ALPHA, the keyboard locks in alpha input until you press ALPHA again.

2. Display

■ Selecting Icons

This section describes how to select an icon in the Main Menu to enter the mode you want.

● To select an icon





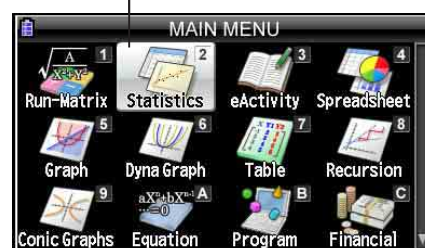

1. Press **[MENU]** to display the Main Menu.
2. Use the cursor keys (**◀**, **▶**, **▲**, **▼**) to move the highlighting to the icon you want.













Currently selected icon



3. Press **[EXE]** to display the initial screen of the mode whose icon you selected.
- You can also enter a mode without highlighting an icon in the Main Menu by inputting the number or letter marked in the upper right corner of the icon.

The following explains the meaning of each icon.

Icon	Mode Name	Description
	Run-Matrix	Use this mode for arithmetic calculations, function calculations, binary, octal, decimal, and hexadecimal calculations, matrix calculations, and vector calculations.
	Statistics	Use this mode to perform single-variable (standard deviation) and paired-variable (regression) statistical calculations, to perform tests, to analyze data and to draw statistical graphs.
	eActivity	eActivity lets you input text, math expressions, and other data in a notebook-like interface. Use this mode when you want to store text or formulas, or built-in application data in a file.
	Spreadsheet	Use this mode to perform spreadsheet calculations. Each file contains a 26-column × 999-line spreadsheet. In addition to the calculator's built-in commands and Spreadsheet mode commands, you can also perform statistical calculations and graph statistical data using the same procedures that you use in the Statistics mode.
	Graph	Use this mode to store graph functions and to draw graphs using the functions.
	Dyna Graph (Dynamic Graph)	Use this mode to store graph functions and to draw multiple versions of a graph by changing the values assigned to the variables in a function.

Icon	Mode Name	Description
 7 Table	Table	Use this mode to store functions, to generate a numeric table of different solutions as the values assigned to variables in a function change, and to draw graphs.
 8 Recursion	Recursion	Use this mode to store recursion formulas, to generate a numeric table of different solutions as the values assigned to variables in a function change, and to draw graphs.
 9 Conic Graphs	Conic Graphs	Use this mode to draw graphs of conic sections.
 A Equation	Equation	Use this mode to solve linear equations with two through six unknowns, and high-order equations from 2nd to 6th degree.
 B Program	Program	Use this mode to store programs in the program area and to run programs.
 C Financial	Financial	Use this mode to perform financial calculations and to draw cash flow and other types of graphs.
 D E-CON3	E-CON3	Use this mode to control the optionally available Data Logger.
 E Link	Link	Use this mode to transfer memory contents or back-up data to another unit or PC.
 F Memory	Memory	Use this mode to manage data stored in memory.
 G System	System	Use this mode to initialize memory, adjust display brightness, and to make other system settings.
 H Geometry	Geometry	Use this mode to draw and analyze geometric objects.
 I Picture Plot	Picture Plot*	Use this mode to plot points (that represent coordinates) on the screen and to perform various types of analysis based on the plotted data (coordinate values).
 J Conversion	Conversion	This icon appears when the “Metric Conversion” add-in application is installed. It is not a function mode icon. When “Metric Conversion” is installed, this icon is displayed on the CONVERT menu, which is part of the option (OPTN) menu. For more information about the option (OPTN) menu, see page 1-27. For information about using the CONVERT menu, see “Metric Conversion Calculations” (page 2-64).

* fx-CG20 AU Users: Install the Picture Plot add-in application.

■ About the Function Menu

Use the function keys (**F1** to **F6**) to access the menus and commands in the menu bar along the bottom of the display screen. You can tell whether a menu bar item is a menu or a command by its appearance.

■ Status Bar

The status bar is an area that displays messages and the current status of the calculator. It is always displayed at the top of the screen.

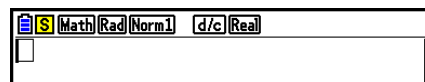

- Icons are used to indicate the information described below.

This icon:	Indicates this:
	The current battery level. The icons indicated (from left to right): Level 3, Level 2, Level 1, Dead. See “Low Battery Message” (page 1-38) for more information. Important! If the Level 1 icon () appears, immediately replace the batteries. For details about battery replacement, see the separate “Hardware User’s Guide”.
	Calculation in progress.
	SHIFT key was pressed and the calculator is standing by for the next key operation.
	ALPHA key was pressed and the calculator is standing by for the next key operation. The icon indicates the lower-case input mode (eActivity and Program modes only).
	Alpha Lock (page 1-2) is in effect.
	SHIFT B (CLIP) was pressed and the calculator is standing by for range specification (page 1-11).
	Setup “Input/Output” setting.
	Setup “Angle” setting.
	Setup “Display” setting.
	Setup “Frac Result” setting.
	Setup “Complex Mode” setting.

- For details about the Setup screen, see “Using the Setup Screen” (page 1-32).
- For information about other icons and messages that are specific to each application, see the chapters that cover each application.

■ About Display Screens

This calculator uses two types of display screens: a text screen and a graph screen. The text screen can show 21 columns and 8 lines of characters, with the bottom line used for the function key menu. The graph screen uses an area that measures 384 (W) × 216 (H) dots.

Text Screen

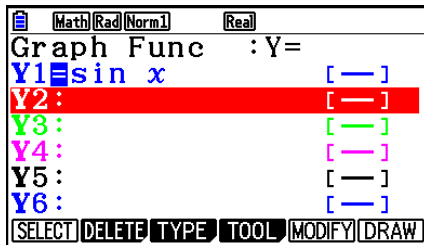

Graph Screen

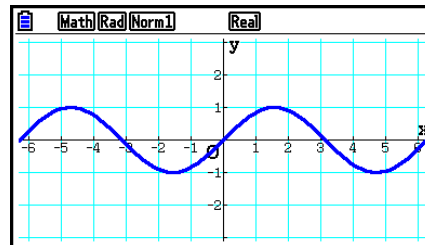

■ Normal Display

The calculator normally displays values up to 10 digits long. Values that exceed this limit are automatically converted to and displayed in exponential format.

• How to interpret exponential format

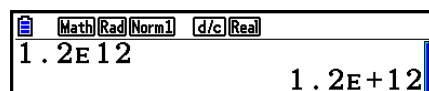

$1.2E+12$ indicates that the result is equivalent to 1.2×10^{12} . This means that you should move the decimal point in 1.2 twelve places to the right, because the exponent is positive. This results in the value 1,200,000,000,000.

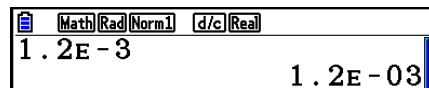

$1.2E-03$ indicates that the result is equivalent to 1.2×10^{-3} . This means that you should move the decimal point in 1.2 three places to the left, because the exponent is negative. This results in the value 0.0012.

You can specify one of two different ranges for automatic changeover to normal display.

Norm 1 10^{-2} (0.01) > $|x|$, $|x| \geq 10^{10}$

Norm 2 10^{-9} (0.000000001) > $|x|$, $|x| \geq 10^{10}$

All of the examples in this manual show calculation results using Norm 1.

See page 2-13 for details on switching between Norm 1 and Norm 2.

Special Display Formats

This calculator uses special display formats to indicate fractions, hexadecimal values, and degrees/minutes/seconds values.

- Fractions

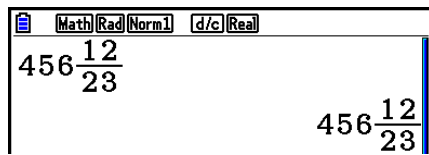

..... Indicates: $456 \frac{12}{23}$

- Hexadecimal Values



..... Indicates: $0ABCDEF1_{(16)}$, which equals $180150001_{(10)}$

- Degrees/Minutes/Seconds



..... Indicates: $12^\circ 34' 56.78''$

- In addition to the above, this calculator also uses other indicators or symbols, which are described in each applicable section of this manual as they come up.

3. Inputting and Editing Calculations

Inputting Calculations

When you are ready to input a calculation, first press **AC** to clear the display. Next, input your calculation formulas exactly as they are written, from left to right, and press **EXE** to obtain the result.

Example $2 + 3 - 4 + 10 =$

AC **2** **+** **3** **-** **4** **+** **1** **0** **EXE**

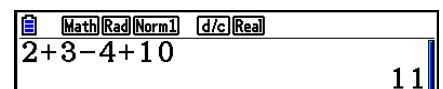

Editing Calculations

Use the **◀** and **▶** keys to move the cursor to the position you want to change, and then perform one of the operations described below. After you edit the calculation, you can execute it by pressing **EXE**. Or you can use **▶** to move to the end of the calculation and input more.

- You can select either insert or overwrite for input*¹. With overwrite, text you input replaces the text at the current cursor location. You can toggle between insert and overwrite by performing the operation: **SHIFT** **DEL** (INS). The cursor appears as “|” for insert and as “■” for overwrite.

*¹ Insert and overwrite switching is possible only when the Linear input/output mode (page 1-32) is selected.

• To change a step

Example To change cos60 to sin60

AC COS 6 0

◀◀◀

DEL

sin

Math Rad Norm1 d/c Real
cos 60

Math Rad Norm1 d/c Real
cos 60

Math Rad Norm1 d/c Real
60

Math Rad Norm1 d/c Real
sin 60

• To delete a step

Example To change $369 \times \times 2$ to 369×2

AC 3 6 9 X X 2

◀ DEL

Math Rad Norm1 d/c Real
369××2

Math Rad Norm1 d/c Real
369×2

In the insert mode, the DEL key operates as a backspace key.

• To insert a step

Example To change 2.36^2 to $\sin 2.36^2$

AC 2 . 3 6 x²

◀◀◀◀◀◀

sin

Math Rad Norm1 d/c Real
2.36²

Math Rad Norm1 d/c Real
2.36²

Math Rad Norm1 d/c Real
sin 2.36²

■ Parentheses Colors during Calculation Formula Input

Parentheses are color coded during input and editing of calculation formulas in order to make it easier to confirm the proper relationship between opening and closing parentheses.

The following rules are applied when assigning parentheses colors.

- When there are nested parentheses, colors are assigned in sequence from the outermost parentheses inward. Colors are assigned in the following sequence: blue, red, green, magenta, black. When there are more than five nesting levels, the color sequence is repeated starting from blue again.

Math Rad Norm1 d/c Real
(1+(2+(3+(4+(5+(6+(

- Inputting a closing parenthesis assigns it the same color as the corresponding opening parenthesis.

Calculator display: (1+(2+3(4+5)×2)|

- The parentheses of parenthetical expressions that are of the same level are the same color.

Calculator display: (1+2)(2+3)|

Calculator display: (2(2+3)(3+4))(3+2)|

Executing a calculation causes the color of all parentheses to become black.

Calculator display: (1+2)(2+3) 15

■ Using Replay Memory

The last calculation performed is always stored into replay memory. You can recall the contents of the replay memory by pressing ◀ or ▶.

If you press ▶, the calculation appears with the cursor at the beginning. Pressing ◀ causes the calculation to appear with the cursor at the end. You can make changes in the calculation as you wish and then execute it again.

- Replay memory is enabled in the Linear input/output mode only. In the Math input/output mode, the history function is used in place of replay memory. For details, see “History Function” (page 1-21).

Example 1 To perform the following two calculations

$$4.12 \times 6.4 = 26.368$$

$$4.12 \times 7.1 = 29.252$$

AC 4 . 1 2 × 6 . 4 EXE

Calculator display: 4.12 × 6.4 = 26.368

◀ ◀ ◀ ◀

Calculator display: 4.12 × 6.4

SHIFT DEL (INS)

Calculator display: 4.12 × .4

7 . 1

Calculator display: 4.12 × 7.1

EXE

Calculator display: 4.12 × 7.1 = 29.252

After you press $\boxed{\text{AC}}$, you can press \blacktriangle or \blacktriangledown to recall previous calculations, in sequence from the newest to the oldest (Multi-Replay Function). Once you recall a calculation, you can use \blacktriangleright and \blacktriangleleft to move the cursor around the calculation and make changes in it to create a new calculation.

Example 2

$\boxed{\text{AC}}$ $\boxed{1}$ $\boxed{2}$ $\boxed{3}$ $\boxed{+}$ $\boxed{4}$ $\boxed{5}$ $\boxed{6}$ $\boxed{\text{EXE}}$

$\boxed{2}$ $\boxed{3}$ $\boxed{4}$ $\boxed{-}$ $\boxed{5}$ $\boxed{6}$ $\boxed{7}$ $\boxed{\text{EXE}}$

$\boxed{\text{AC}}$

\blacktriangle (One calculation back)

\blacktriangle (Two calculations back)

Line	Rad	Norm1	d/c	Real
123+456				
234-567				579
				-333

Line	Rad	Norm1	d/c	Real
234-567				

Line	Rad	Norm1	d/c	Real
123+456				

- A calculation remains stored in replay memory until you perform another calculation.
- The contents of replay memory are not cleared when you press the $\boxed{\text{AC}}$ key, so you can recall a calculation and execute it even after pressing the $\boxed{\text{AC}}$ key.

■ Making Corrections in the Original Calculation

Example $14 \div 0 \times 2.3$ entered by mistake for $14 \div 10 \times 2.3$

$\boxed{\text{AC}}$ $\boxed{1}$ $\boxed{4}$ $\boxed{\div}$ $\boxed{0}$ $\boxed{\times}$ $\boxed{2}$ $\boxed{\cdot}$ $\boxed{3}$

$\boxed{\text{EXE}}$

Press $\boxed{\text{EXIT}}$.

Make necessary changes.

\blacktriangleleft $\boxed{1}$

Execute again.

$\boxed{\text{EXE}}$

Math	Rad	Norm1	d/c	Real
14÷0×2.3				

Math	Rad	Norm1	d/c	Real
14÷0×2.3				
Ma ERROR Press: [EXIT]				

Math	Rad	Norm1	d/c	Real
14÷0 × 2.3				

Cursor is positioned automatically at the location of the cause of the error.

Math	Rad	Norm1	d/c	Real
14÷10×2.3				

Math	Rad	Norm1	d/c	Real
14÷10×2.3				3.22

■ Using the Clipboard for Copy and Paste

You can copy (or cut) a function, command, or other input to the clipboard, and then paste the clipboard contents at another location.

Note

In the Math input/output mode, the copy (or cut) range you can specify is limited by the range of movement of the cursor. In the case of parentheses, you can select any range within a parenthetical expression or you can select the entire parenthetical expression.

● To specify the copy range

1. Move the cursor (|) to the beginning or end of the range of text you want to copy and then press **[SHIFT] [8]** (CLIP).

- This will cause  to appear in the status bar.

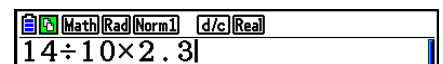

2. Use the cursor keys to move the cursor and highlight the range of text you want to copy.

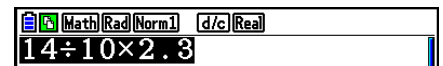

3. Press **[F1]** (COPY) to copy the highlighted text to the clipboard, and exit the copy range specification mode.

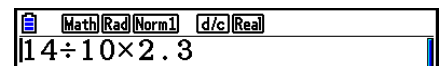

The selected characters are not changed when you copy them.

To cancel text highlighting without performing a copy operation, press **[EXIT]**.

● To cut the text

1. Move the cursor (|) to the beginning or end of the range of text you want to cut and then press **[SHIFT] [8]** (CLIP).

- This will cause  to appear in the status bar.

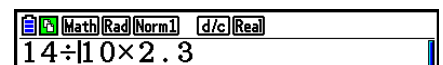

2. Use the cursor keys to move the cursor and highlight the range of text you want to cut.

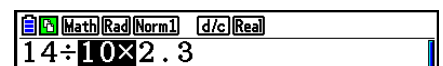

3. Press **[F2]** (CUT) to cut the highlighted text to the clipboard.

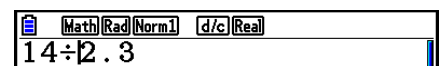

Cutting causes the original characters to be deleted.

• Pasting Text

Move the cursor to the location where you want to paste the text, and then press **[SHIFT] [9]** (PASTE). The contents of the clipboard are pasted at the cursor position.

[AC]

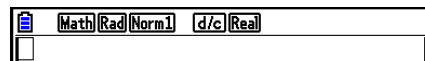

[SHIFT] [9] (PASTE)

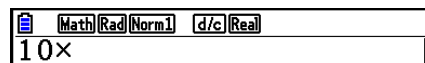

■ Catalog Function

The Catalog is an alphabetic list of all the commands available on this calculator. You can input a command by calling up the Catalog and then selecting the command you want.

• To use the Catalog to input a command

1. Press **[SHIFT] [4]** (CATALOG) to display an alphabetic Catalog of commands.
 - The screen that appears first is the last one you used for command input.
2. Press **[F6]** (CAT) to display the category list.
 - You can skip this step and go straight to step 5, if you want.

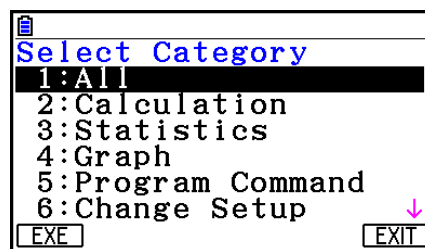

3. Use the cursor keys (**▲**, **▼**) to highlight the command category you want, and then press **[F1]** (EXE) or **[EXE]**.
 - This displays a list of commands in the category you selected.
4. Input the first letter of the command you want to input. This will display the first command that starts with that letter.
5. Use the cursor keys (**▲**, **▼**) to highlight the command you want to input, and then press **[F1]** (INPUT) or **[EXE]**.

Example To use the Catalog to input the Cash_IRR(command

[AC] [SHIFT] [4] (CATALOG) **[In] (C)** **▼** ~ **▼** **[EXE]**

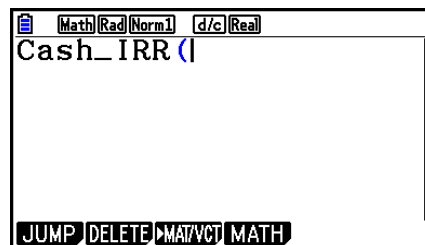

Pressing **[EXIT]** or **[SHIFT] [EXIT]** (QUIT) closes the Catalog.

4. Using the Math Input/Output Mode

Selecting “Math” for the “Input/Output” mode setting on the Setup screen (page 1-32) turns on the Math input/output mode, which allows natural input and display of certain functions, just as they appear in your textbook.

- The operations in this section all are performed in the Math input/output mode. The initial default setting for this calculator is the Math input/output mode. If you have changed to the Linear input/output mode, switch back to the Math input/output mode before performing the operations in this section. See “Using the Setup Screen” (page 1-32) for information about how to switch modes.
- In the Math input/output mode, all input is insert mode (not overwrite mode) input. Note that the SHIFT DEL (INS) operation (page 1-7) you use in the Linear input/output mode to switch to insert mode input performs a completely different function in the Math input/output mode. For more information, see “Using Values and Expressions as Arguments” (page 1-17).
- Unless specifically stated otherwise, all operations in this section are performed in the **Run-Matrix** mode.

■ Input Operations in the Math Input/Output Mode

• Math Input/Output Mode Functions and Symbols

The functions and symbols listed below can be used for natural input in the Math input/output mode. The “Bytes” column shows the number of bytes of memory that are used up by input in the Math input/output mode.

Function/Symbol	Key Operation	Bytes
Fraction (Improper)	$\frac{a}{b}c$	9
Mixed Fraction*1	SHIFT $\frac{a}{b}c$ ($\frac{a}{b} + \frac{c}{d}$)	14
Power	\wedge	4
Square	x^2	4
Negative Power (Reciprocal)	SHIFT \square (x^{-1})	5
$\sqrt{\quad}$	SHIFT x^2 ($\sqrt{\quad}$)	6
Cube Root	SHIFT \square ($\sqrt[3]{\quad}$)	9
Power Root	SHIFT \wedge ($\sqrt[x]{\quad}$)	9
e^x	SHIFT \ln (e^x)	6
10^x	SHIFT \log (10^x)	6
$\log(a,b)$	(Input from MATH menu*2)	7
Abs (Absolute Value)	(Input from MATH menu*2)	6
First Derivative	(Input from MATH menu*2)	7
Second Derivative	(Input from MATH menu*2)	7
Integral*3	(Input from MATH menu*2)	8
Σ Calculation*4	(Input from MATH menu*2)	11
Matrix, Vector	(Input from MATH menu*2)	14*5

Function/Symbol	Key Operation	Bytes
Parentheses	$\boxed{[}$ and $\boxed{]}$	1
Braces (Used during list input.)	$\boxed{\text{SHIFT}} \boxed{\times} (\{ \})$ and $\boxed{\text{SHIFT}} \boxed{\div} (\})$	1
Brackets (Used during matrix/vector input.)	$\boxed{\text{SHIFT}} \boxed{+} ([\])$ and $\boxed{\text{SHIFT}} \boxed{-} (\])$	1

- *1 Mixed fraction is supported in the Math input/output mode only.
- *2 For information about function input from the MATH function menu, see “Using the MATH Menu” described below.
- *3 Tolerance cannot be specified in the Math input/output mode. If you want to specify tolerance, use the Linear input/output mode.
- *4 For Σ calculation in the Math input/output mode, the pitch is always 1. If you want to specify a different pitch, use the Linear input/output mode.
- *5 This is the number of bytes for a 2×2 matrix.

● Using the MATH Menu

In the **Run-Matrix** mode, pressing $\boxed{\text{F4}}$ (MATH) displays the MATH menu. You can use this menu for natural input of matrices, derivatives, integrals, etc.

- **{MAT/VCT}** ... displays the MAT/VCT submenu, for natural input of matrices/vectors
 - **{2×2}** ... inputs a 2×2 matrix
 - **{3×3}** ... inputs a 3×3 matrix
 - **{m×n}** ... inputs a matrix/vector with m lines and n columns (up to 6×6)
 - **{2×1}** ... inputs a 2×1 vector
 - **{3×1}** ... inputs a 3×1 vector
 - **{1×2}** ... inputs a 1×2 vector
 - **{1×3}** ... inputs a 1×3 vector
- **{log_ab}** ... starts natural input of logarithm $\log_a b$
- **{Abs}** ... starts natural input of absolute value $|X|$
- **{d/dx}** ... starts natural input of first derivative $\frac{d}{dx} f(x)_{x=a}$
- **{d²/dx²}** ... starts natural input of second derivative $\frac{d^2}{dx^2} f(x)_{x=a}$
- **{∫dx}** ... starts natural input of integral $\int_a^b f(x) dx$
- **{Σ{}}** ... starts natural input of Σ calculation $\sum_{x=\alpha}^{\beta} f(x)$

• Math Input/Output Mode Input Examples

This section provides a number of different examples showing how the MATH function menu and other keys can be used during Math input/output mode natural input. Be sure to pay attention to the input cursor position as you input values and data.

Example 1 To input $2^3 + 1$

AC **2** **^**

Math **Rad** **Norm1** **d/c** **Real**
2[□]

3

Math **Rad** **Norm1** **d/c** **Real**
2³

▶

Math **Rad** **Norm1** **d/c** **Real**
2³|

+ **1**

Math **Rad** **Norm1** **d/c** **Real**
2³+1|

EXE

Math **Rad** **Norm1** **d/c** **Real**
2³+1 9
□

Example 2 To input $\left(1 + \frac{2}{5}\right)^2$

AC **(** **1** **+**

Math **Rad** **Norm1** **d/c** **Real**
(1+|

a^{b/c}

Math **Rad** **Norm1** **d/c** **Real**
(1+
□

2 **▼**

Math **Rad** **Norm1** **d/c** **Real**
(1+
□

5

Math **Rad** **Norm1** **d/c** **Real**
(1+
5|

▶

Math **Rad** **Norm1** **d/c** **Real**
(1+
5|

) **x²**

Math **Rad** **Norm1** **d/c** **Real**
(1+
5)²|

EXE

Math **Rad** **Norm1** **d/c** **Real**
(1+
5)² 49
25
□

Example 3 To input $1 + \int_0^1 x + 1 dx$

AC **1** **+** **F4** (MATH) **F6** (\triangleright) **F1** ($\int dx$)

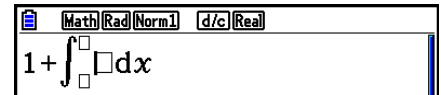

X,θ,1 **+** **1**

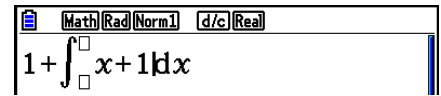

▶ **0**

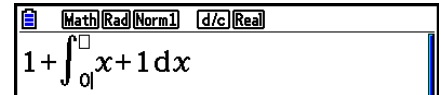

▲ **1**

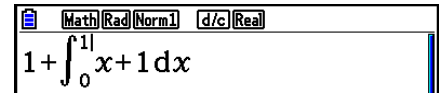

▶

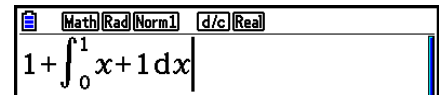

EXE

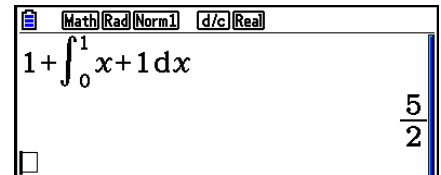

Example 4 To input $2 \times \begin{bmatrix} \frac{1}{2} & \sqrt{2} \\ \sqrt{2} & \frac{1}{2} \end{bmatrix}$

AC **2** **×** **F4** (MATH) **F1** (MAT/VCT) **F1** (2x2)

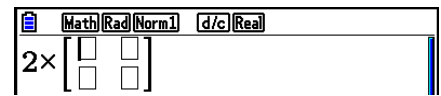

a% **1** **▼** **2**

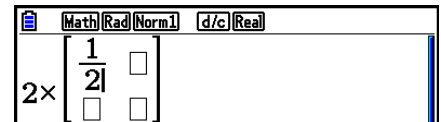

▶ **▶**

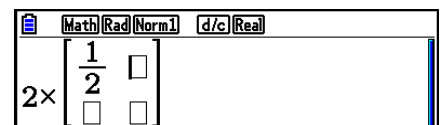

SHIFT **x²** ($\sqrt{\quad}$) **2** **▶**

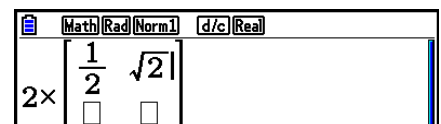

▶ **SHIFT** **x²** ($\sqrt{\quad}$) **2** **▶** **▶** **a%** **1** **▼** **2**

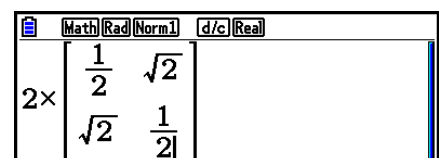

EXE

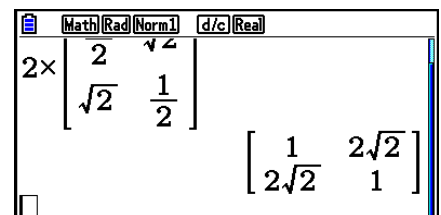

• **When the calculation does not fit within the display window**

Arrows appear at the left, right, top, or bottom edge of the display to let you know when there is more of the calculation off the screen in the corresponding direction.

When you see an arrow, you can use the cursor keys to scroll the screen contents and view the part you want.

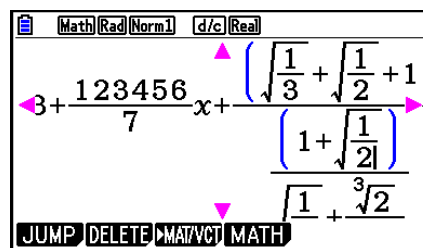

• **Math Input/Output Mode Input Restrictions**

Certain types of expressions can cause the vertical width of a calculation formula to be greater than one display line. The maximum allowable vertical width of a calculation formula is about two display screens. You cannot input any expression that exceeds this limitation.

• **Using Values and Expressions as Arguments**

A value or an expression that you have already input can be used as the argument of a function. After you have input “(2+3)”, for example, you can make it the argument of $\sqrt{\quad}$, resulting in $\sqrt{(2+3)}$.

Example

1. Move the cursor so it is located directly to the left of the part of the expression that you want to become the argument of the function you will insert.

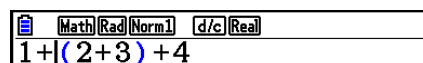

2. Press **SHIFT** **DEL** (INS).

- This changes the cursor to an insert cursor (I).

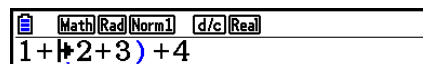

3. Press **SHIFT** **x²** ($\sqrt{\quad}$) to insert the $\sqrt{\quad}$ function.

- This inserts the $\sqrt{\quad}$ function and makes the parenthetical expression its argument.

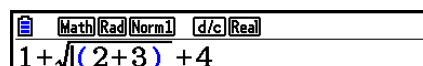

As shown above, the value or expression to the right of the cursor after **SHIFT** **DEL** (INS) are pressed becomes the argument of the function that is specified next. The range encompassed as the argument is everything up to the first open parenthesis to the right, if there is one, or everything up to the first function to the right ($\sin(30)$, $\log_2(4)$, etc.).

This capability can be used with the following functions.

Function	Key Operation	Original Expression	Expression After Insertion
Improper Fraction	$\frac{a}{b}c$	$1+ (2+3)+4$	$1+\frac{\square}{(2+3)}+4$
Power	\wedge	$1+2 (2+3)+4$	$1+2^{(2+3)}+4$
$\sqrt{\quad}$	$\text{SHIFT } \square^2 (\sqrt{\quad})$	$1+ (2+3)+4$	$1+\sqrt{ (2+3)}+4$
Cube Root	$\text{SHIFT } \square^3 ({}^3\sqrt{\quad})$		$1+{}^3\sqrt{ (2+3)}+4$
Power Root	$\text{SHIFT } \wedge ({}^x\sqrt{\quad})$		$1+\sqrt[x]{ (2+3)}+4$
e^x	$\text{SHIFT } \text{In} (e^x)$		$1+e^{(2+3)}+4$
10^x	$\text{SHIFT } \text{log} (10^x)$		$1+10^{(2+3)}+4$
$\log(a,b)$	$\text{F4 (MATH) F2} (\log_a b)$		$1+\log_{\square}((2+3)))+4$
Absolute Value	$\text{F4 (MATH) F3} (\text{Abs})$		$1+ 2+3 +4$
First Derivative	$\text{F4 (MATH) F4} (d/dx)$	$1+ (x+3)+4$	$1+\frac{d}{dx}((x+3)) _{x=\square}+4$
Second Derivative	$\text{F4 (MATH) F5} (d^2/dx^2)$		$1+\frac{d^2}{dx^2}((x+3)) _{x=\square}+4$
Integral	$\text{F4 (MATH) F6} (\triangleright)$ $\text{F1} (\int dx)$		$1+\int_{\square}^{\square} (x+3) dx+4$
Σ Calculation	$\text{F4 (MATH) F6} (\triangleright)$ $\text{F2} (\Sigma(\quad))$		$1+\sum_{\square=\square}^{\square} ((x+3)))+4$

- In the Linear input/output mode, pressing $\text{SHIFT } \text{DEL}$ (INS) will change to the insert mode. See page 1-7 for more information.

• Editing Calculations in the Math Input/Output Mode

The procedures for editing calculations in the Math input/output mode are basically the same as those for the Linear input/output mode. For more information, see “Editing Calculations” (page 1-7).

Note however, that the following points are different between the Math input/output mode and the Linear input/output mode.

- Overwrite mode input that is available in the Linear input/output mode is not supported by the Math input/output mode. In the Math input/output mode, input is always inserted at the current cursor location.
- In the Math input/output mode, pressing the DEL key always performs a backspace operation.

- Note the following cursor operations you can use while inputting a calculation with Math input/output mode.

To do this:	Press this key:
Move the cursor from the end of the calculation to the beginning	
Move the cursor from the beginning of the calculation to the end	

■ Using Undoing and Redoing Operations

You can use the following procedures during calculation expression input in the Math input/output mode (up until you press the **EXE** key) to undo the last key operation and to redo the key operation you have just undone.

- To undo the last key operation, press: **ALPHA DEL** (UNDO).
- To redo a key operation you have just undone, press: **ALPHA DEL** (UNDO) again.
- You also can use UNDO to cancel an **AC** key operation. After pressing **AC** to clear an expression you have input, pressing **ALPHA DEL** (UNDO) will restore what was on the display before you pressed **AC**.
- You also can use UNDO to cancel a cursor key operation. If you press during input and then press **ALPHA DEL** (UNDO), the cursor will return to where it was before you pressed .
- The UNDO operation is disabled while the keyboard is alpha-locked. Pressing **ALPHA DEL** (UNDO) while the keyboard is alpha-locked will perform the same delete operation as the **DEL** key alone.

Example

1 **+** $\frac{1}{\square}$ **1**

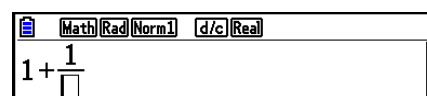

DEL

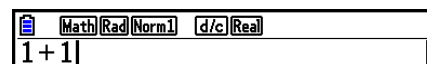

ALPHA DEL (UNDO)

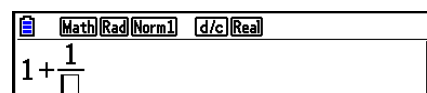

2

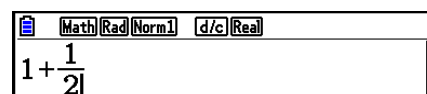

AC

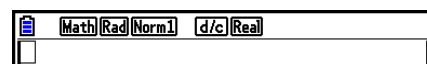

ALPHA DEL (UNDO)

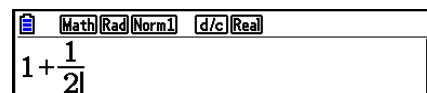

Math Input/Output Mode Calculation Result Display

Fractions, matrices, vectors, and lists produced by Math input/output mode calculations are displayed in natural format, just as they appear in your textbook.

Sample Calculation Result Displays

- Fractions are displayed either as improper fractions or mixed fractions, depending on the “Frac Result” setting on the Setup screen. For details, see “Using the Setup Screen” (page 1-32).
- Matrices are displayed in natural format, up to 6×6 . A matrix that has more than six rows or columns will be displayed on a MatAns screen, which is the same screen used in the Linear input/output mode.
- Vectors are displayed in natural format up to 1×6 , or 6×1 . A vector that has more than six rows or columns will be displayed on a VctAns screen, which is the same screen used in the Linear input/output mode.
- Lists are displayed in natural format for up to 20 elements. A list that has more than 20 elements will be displayed on a ListAns screen, which is the same screen used in the Linear input/output mode.
- Arrows appear at the left, right, top, or bottom edge of the display to let you know when there is more data off the screen in the corresponding direction.

You can use the cursor keys to scroll the screen and view the data you want.

- Pressing **F2** (DELETE) **F1** (DEL-LINE) while a calculation result is selected will delete both the result and the calculation that produced it.
- The multiplication sign cannot be omitted immediately before an improper fraction or mixed fraction. Be sure to always input a multiplication sign in this case.

Example: $2 \times \frac{2}{5}$ **2** **×** **2** **a/b/c** **5**

- A **^**, **x²**, or **SHIFT** **)** (x^{-1}) key operation cannot be followed immediately by another **^**, **x²**, or **SHIFT** **)** (x^{-1}) key operation. In this case, use parentheses to keep the key operations separate.

Example: $(3^2)^{-1}$ **(** **3** **x²** **)** **SHIFT** **)** (x^{-1})

History Function

The history function maintains a history of calculation expressions and results in the Math input/output mode. Up to 30 sets of calculation expressions and results are maintained.

1 + 2 = 3
 × 2 = 6

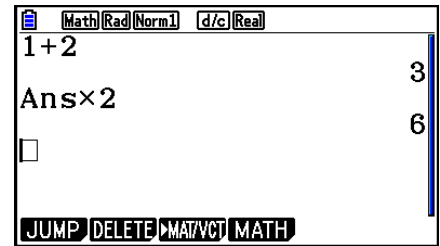

You can also edit the calculation expressions that are maintained by the history function and recalculate. This will recalculate all of the expressions starting from the edited expression.

Example To change “1+2” to “1+3” and recalculate

Perform the following operation following the sample shown above.

↑ ↑ ↑ ↓ DEL 3 =

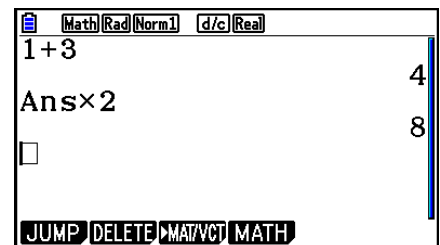

- You can get a rough idea of how many entries (calculation expressions and results) are contained in history by checking the length of the scroll bar. A shorter bar indicates a greater number of entries.

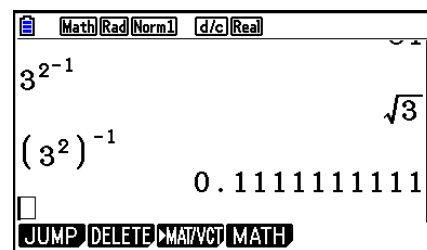
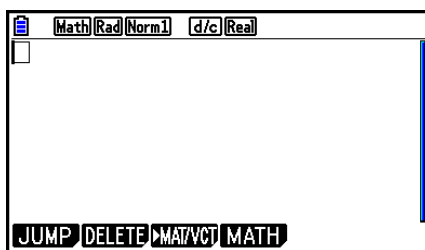

- The value stored in the answer memory is always dependent on the result produced by the last calculation performed. If history contents include operations that use the answer memory, editing a calculation may affect the answer memory value used in subsequent calculations.
 - If you have a series of calculations that use the answer memory to include the result of the previous calculation in the next calculation, editing a calculation will affect the results of all the other calculations that come after it.
 - When the first calculation of the history includes the answer memory contents, the answer memory value is “0” because there is no calculation before the first one in history.

■ Calculation Operations in the Math Input/Output Mode

This section introduces Math input/output mode calculation examples.

- For details about calculation operations, see “Chapter 2 Manual Calculations”.

● Performing Function Calculations Using Math Input/Output Mode

Example	Operation
$\frac{6}{4 \times 5} = \frac{3}{10}$	AC 6 a/b/c 4 X 5 EXE
$\cos\left(\frac{\pi}{3}\right) = \frac{1}{2}$ (Angle: Rad)	AC COS () SHIFT EXP (π) a/b/c 3) EXE
$\log_2 8 = 3$	AC F4 (MATH) F2 ($\log_a b$) 2) 8 EXE
$\sqrt[7]{123} = 1.988647795$	AC SHIFT \wedge ($^x\sqrt{\quad}$) 7) 123 EXE
$2 + 3 \times \sqrt[3]{64} - 4 = 10$	AC 2 + 3 X SHIFT \wedge ($^x\sqrt{\quad}$) 3) 64) - 4 EXE
$\left \log \frac{3}{4}\right = 0.1249387366$	AC F4 (MATH) F3 (Abs) log 3 a/b/c 4 EXE
$\frac{2}{5} + 3 \frac{1}{4} = \frac{73}{20}$	AC 2 a/b/c 5) + 3 SHIFT a/b/c (=) 1) 4 EXE
$1.5 + 2.3i = \frac{3}{2} + \frac{23}{10}i$	AC 1.5 + 2.3 SHIFT 0 (i) EXE F-D
$\frac{d}{dx}(x^3 + 4x^2 + x - 6)_{x=3} = 52$	AC F4 (MATH) F4 (d/dx) X,θ,T \wedge 3) + 4 X,θ,T x ² + X,θ,T - 6) 3 EXE
$\int_1^5 2x^2 + 3x + 4 dx = \frac{404}{3}$	AC F4 (MATH) F6 (∫) F1 (∫dx) 2 X,θ,T x ² + 3 X,θ,T + 4) 1) 5 EXE
$\sum_{k=2}^6 (k^2 - 3k + 5) = 55$	AC F4 (MATH) F6 (∫) F2 (Σ) ALPHA (K) x ² - 3 ALPHA (K) + 5) ALPHA (K)) 2) 6 EXE

■ Performing Matrix/Vector Calculations Using Math Input/Output Mode

• To specify the dimensions (size) of a matrix/vector

1. In the **Run-Matrix** mode, press **SHIFT** **MENU** (SET UP) **F1** (Math) **EXIT**.
2. Press **F4** (MATH) to display the MATH menu.
3. Press **F1** (MAT/VCT) to display the following menu.
 - **{2×2}** ... inputs a 2×2 matrix
 - **{3×3}** ... inputs a 3×3 matrix
 - **{m×n}** ... inputs an m -row \times n -column matrix or vector (up to 6×6)
 - **{2×1}** ... inputs a 2×1 vector
 - **{3×1}** ... inputs a 3×1 vector
 - **{1×2}** ... inputs a 1×2 vector
 - **{1×3}** ... inputs a 1×3 vector

Example To create a 2-row \times 3-column matrix

F3 ($m \times n$)

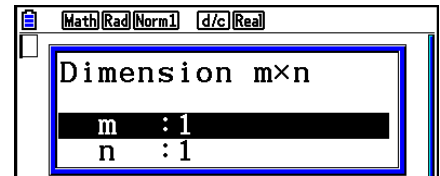

Specify the number of rows.

2 **EXE**

Specify the number of columns.

3 **EXE**

EXE

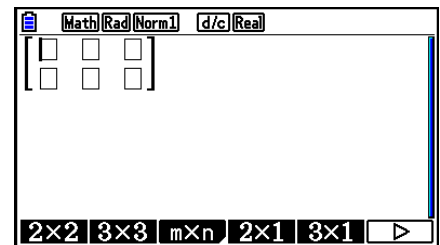

• To input cell values

Example To perform the calculation shown below

$$\begin{bmatrix} 1 & \frac{1}{2} & 33 \\ \frac{13}{4} & 5 & 6 \end{bmatrix} \times 8$$

The following operation is a continuation of the example calculation on the previous page.

1 \rightarrow 1 $\frac{a}{b}$ 2 \rightarrow 3 3 \rightarrow
 1 3 $\frac{a}{b}$ 4 \rightarrow 5 6 \rightarrow
 X 8 EXE

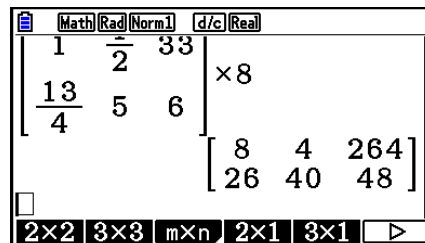

• To assign a matrix created using Math input/output mode to a specified matrix memory

Example To assign the calculation result to Mat J

SHIFT 2 (Mat) SHIFT (-) (Ans) \rightarrow
 SHIFT 2 (Mat) ALPHA (J) EXE

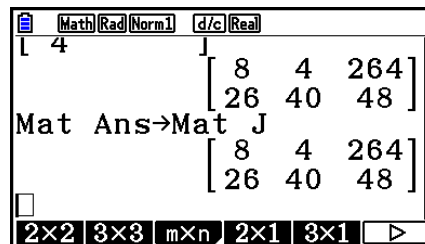

- Pressing the DEL key while the cursor is located at the top (upper left) of the matrix will delete the entire matrix.

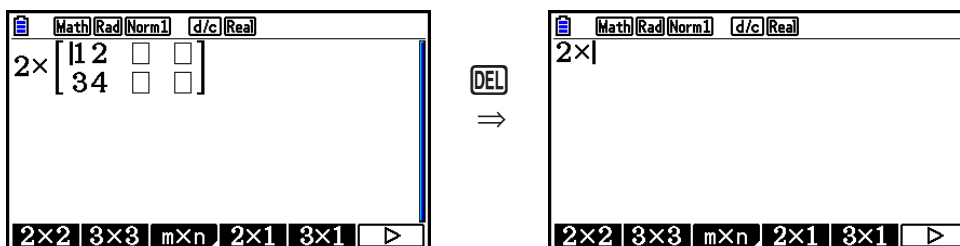

■ Using Graph Modes and the Equation Mode in the Math Input/Output Mode

Using the Math input/output mode with any of the modes below lets you input numeric expressions just as they are written in your textbook and view calculation results in natural display format.

Modes that support input of expressions as they are written in textbooks:

Run-Matrix, eActivity, Graph, Dyna Graph, Table, Recursion, Equation (SOLVER)

Modes that support natural display format:

Run-Matrix, eActivity, Equation

The following explanations show Math input/output mode operations in the **Graph**, **Dyna Graph**, **Table**, **Recursion** and **Equation** modes, and natural calculation result display in the **Equation** mode.

- See the sections that cover each calculation for details about its operation.
- See “Input Operations in the Math Input/Output Mode” (page 1-13) and “Calculation Operations in the Math Input/Output Mode” (page 1-22) for details about Math input/output mode input operations and calculation result displays in the **Run-Matrix** mode.
- **eActivity** mode input operations and result displays are the same as those in the **Run-Matrix** mode. For information about **eActivity** mode operations, see “Chapter 10 eActivity”.

● Math Input/Output Mode Input in the Graph Mode

You can use the Math input/output mode for graph expression input in the **Graph**, **Dyna Graph**, **Table**, and **Recursion** modes.

Example 1 In the **Graph** mode, input the function $y = \frac{x^2}{\sqrt{2}} - \frac{x}{\sqrt{2}} - 1$ and then graph it. Make sure that initial default settings are configured on the View Window.

(MENU) Graph (X,θ,T) x^2 (a%) (SHIFT) $x^2(\sqrt{\quad})$ (2)
 (▶) (▶) (←) (X,θ,T) (a%) (SHIFT) $x^2(\sqrt{\quad})$ (2) (▶) (▶)
 (←) (1) (EXE)

(F6) (DRAW)

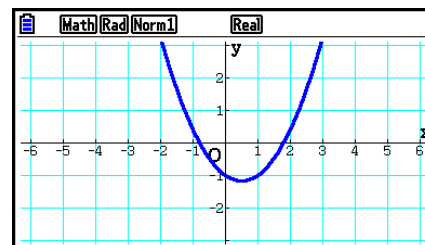
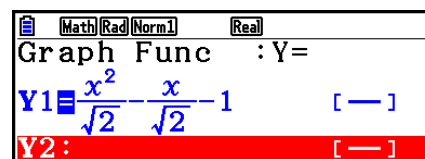

Example 2 In the Graph mode, input the function $y = \int_0^x \frac{1}{4}x^2 - \frac{1}{2}x - 1 dx$ and then graph it.

Make sure that initial default settings are configured on the View Window.

MENU Graph **OPTN** **F2** (CALC) **F3** ($\int dx$)
1 $\frac{a}{b}$ **4** \rightarrow **X,θ,T** x^2 **-** **1** $\frac{a}{b}$ **2** \rightarrow
X,θ,T **-** **1** \rightarrow **0** \rightarrow **X,θ,T** **EXE**

F6 (DRAW)

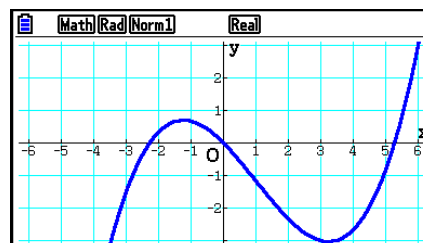
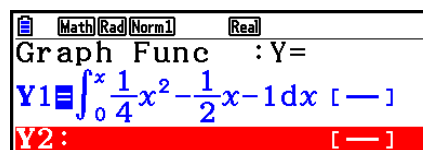

• Math Input/Output Mode Input and Result Display in the Equation Mode

You can use the Math input/output mode in the **Equation** mode for input and display as shown below.

- In the case of simultaneous equations (**F1**(SIMUL)) and high-order equations (**F2**(POLY)), solutions are output in natural display format (fractions, $\sqrt{\quad}$, π are displayed in natural format) whenever possible.
- In the case of Solver (**F3**(SOLVER)), you can use Math input/output mode natural input.

Example To solve the quadratic equation $x^2 + 3x + 5 = 0$ in the Equation mode

MENU Equation **SHIFT** **MENU** (SET UP)
 ∇ ∇ ∇ ∇ (Complex Mode)
F2 ($a+bi$) **EXIT**
F2 (POLY) **F1** (2) **1** **EXE** **3** **EXE** **5** **EXE** **EXE**

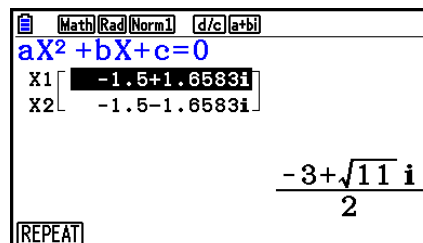

5. Option (OPTN) Menu

The option menu gives you access to scientific functions and features that are not marked on the calculator's keyboard. The contents of the option menu differ according to the mode you are in when you press the $\boxed{\text{OPTN}}$ key.

- The option menu does not appear if you press $\boxed{\text{OPTN}}$ while binary, octal, decimal, or hexadecimal is set as the default number system.
- For details about the commands included on the option (OPTN) menu, see the " $\boxed{\text{OPTN}}$ key" item in the "**Program Mode Command List**" (page 8-51).
- The meanings of the option menu items are described in the sections that cover each mode.

The following list shows the option menu that is displayed when the **Run-Matrix** or **Program** mode is selected.

- **{LIST}** ... {list function menu}
 - **{MAT/VCT}** ... {matrix/vector operation menu}
 - **{COMPLEX}** ... {complex number calculation menu}
 - **{CALC}** ... {functional analysis menu}
 - **{STAT}** ... {menu for paired-variable statistical estimated value, distribution, standard deviation, variance, and test functions}
 - **{CONVERT}** ... {metric conversion menu}*
 - **{HYPERBL}** ... {hyperbolic calculation menu}
 - **{PROB}** ... {probability/distribution calculation menu}
 - **{NUMERIC}** ... {numeric calculation menu}
 - **{ANGLE}** ... {menu for angle/coordinate conversion, sexagesimal input/conversion}
 - **{ENG-SYM}** ... {engineering symbol menu}
 - **{PICTURE}** ... {graph save/recall menu}
 - **{FUNCMEM}** ... {function memory menu}
 - **{LOGIC}** ... {logic operator menu}
 - **{CAPTURE}** ... {screen capture menu}
 - **{FINANCE}** ... {financial calculation menu}
 - The PICTURE, FUNCMEM and CAPTURE items are not displayed when "Math" is selected for the "Input/Output" mode setting on the Setup screen.
- * Metric conversion commands are supported only when the Metric Conversion add-in application is installed.

6. Variable Data (VARS) Menu

To recall variable data, press $\boxed{\text{VARS}}$ to display the variable data menu.

$\{\text{V-WIN}\}/\{\text{FACTOR}\}/\{\text{STAT}\}/\{\text{GRAPH}\}/\{\text{DYNA}\}/\{\text{TABLE}\}/\{\text{RECURSION}\}/\{\text{EQUATION}\}/\{\text{FINANCE}\}/\{\text{Str}\}$

- Note that the EQUATION and FINANCE items appear for function keys ($\boxed{\text{F3}}$ and $\boxed{\text{F4}}$) only when you access the variable data menu from the **Run-Matrix** or **Program** mode.
- The variable data menu does not appear if you press $\boxed{\text{VARS}}$ while binary, octal, decimal, or hexadecimal is set as the default number system.
- For details about the commands included on the variable data (VARS) menu, see the “ $\boxed{\text{VARS}}$ key” item in the “**Program** Mode Command List” (page 8-51).

• V-WIN — Recalling V-Window values

- $\{\text{X}\}/\{\text{Y}\}/\{\text{T},\theta\}$... {x-axis menu}/y-axis menu}/T, θ menu}
- $\{\text{R-X}\}/\{\text{R-Y}\}/\{\text{R-T},\theta\}$... {x-axis menu}/y-axis menu}/T, θ menu} for right side of Dual Graph
- $\{\text{min}\}/\{\text{max}\}/\{\text{scale}\}/\{\text{dot}\}/\{\text{pitch}\}$... {minimum value}/maximum value}/scale}/dot value*¹}/pitch}

*¹ The dot value indicates the display range (Xmax value – Xmin value) divided by the screen dot pitch. The dot value is normally calculated automatically from the minimum and maximum values. Changing the dot value causes the maximum to be calculated automatically.

• FACTOR — Recalling zoom factors

- $\{\text{Xfct}\}/\{\text{Yfct}\}$... {x-axis factor}/y-axis factor}

• STAT — Recalling statistical data

- $\{\text{X}\}$... {single-variable, paired-variable x-data}
 - $\{n\}/\{\bar{x}\}/\{\Sigma x\}/\{\Sigma x^2\}/\{\sigma x\}/\{s_x\}/\{\text{minX}\}/\{\text{maxX}\}$... {number of data}/mean}/sum}/sum of squares}/population standard deviation}/sample standard deviation}/minimum value}/maximum value}
- $\{\text{Y}\}$... {paired-variable y-data}
 - $\{\bar{y}\}/\{\Sigma y\}/\{\Sigma y^2\}/\{\Sigma xy\}/\{\sigma y\}/\{s_y\}/\{\text{minY}\}/\{\text{maxY}\}$... {mean}/sum}/sum of squares}/sum of products of x-data and y-data}/population standard deviation}/sample standard deviation}/minimum value}/maximum value}
- $\{\text{GRAPH}\}$... {graph data menu}
 - $\{a\}/\{b\}/\{c\}/\{d\}/\{e\}$... regression coefficient and polynomial coefficients
 - $\{r\}/\{r^2\}$... {correlation coefficient}/coefficient of determination}
 - $\{\text{MSe}\}$... {mean square error}
 - $\{\text{Q}_1\}/\{\text{Q}_3\}$... {first quartile}/third quartile}
 - $\{\text{Med}\}/\{\text{Mod}\}$... {median}/mode} of input data
 - $\{\text{Start}\}/\{\text{Pitch}\}$... histogram {start division}/pitch}

- **{PTS}** ... {summary point data menu}
 - $\{x_1\}/\{y_1\}/\{x_2\}/\{y_2\}/\{x_3\}/\{y_3\}$... coordinates of summary points
- **{INPUT}** ... {statistical calculation input values}
 - $\{n\}/\{\bar{x}\}/\{s_x\}/\{n_1\}/\{n_2\}/\{\bar{x}_1\}/\{\bar{x}_2\}/\{s_{x_1}\}/\{s_{x_2}\}/\{s_p\}$... {size of sample}/ {mean of sample}/ {sample standard deviation}/ {size of sample 1}/ {size of sample 2}/ {mean of sample 1}/ {mean of sample 2}/ {standard deviation of sample 1}/ {standard deviation of sample 2}/ {standard deviation of sample p }
- **{RESULT}** ... {statistical calculation output values}
 - **{TEST}** ... {test calculation results}
 - $\{p\}/\{z\}/\{t\}/\{\mathbf{Chi}\}/\{F\}/\{\hat{p}\}/\{\hat{p}_1\}/\{\hat{p}_2\}/\{df\}/\{se\}/\{r\}/\{r^2\}/\{pa\}/\{Fa\}/\{Adf\}/\{SSa\}/\{MSa\}/\{pb\}/\{Fb\}/\{Bdf\}/\{SSb\}/\{MSb\}/\{pab\}/\{Fab\}/\{ABdf\}/\{SSab\}/\{MSab\}/\{Edf\}/\{SSE\}/\{MSE\}$
 - ... { p -value}/ { z score}/ { t score}/ { χ^2 value}/ { F value}/ {estimated sample proportion}/ {estimated proportion of sample 1}/ {estimated proportion of sample 2}/ {degrees of freedom}/ {standard error}/ {correlation coefficient}/ {coefficient of determination}/ {factor A p -value}/ {factor A F value}/ {factor A degrees of freedom}/ {factor A sum of squares}/ {factor A mean squares}/ {factor B p -value}/ {factor B F value}/ {factor B degrees of freedom}/ {factor B sum of squares}/ {factor B mean squares}/ {factor AB p -value}/ {factor AB F value}/ {factor AB degrees of freedom}/ {factor AB sum of squares}/ {factor AB mean squares}/ {error degrees of freedom}/ {error sum of squares}/ {error mean squares}
 - **{INTR}** ... {confidence interval calculation results}
 - $\{\mathbf{Lower}\}/\{\mathbf{Upper}\}/\{\hat{p}\}/\{\hat{p}_1\}/\{\hat{p}_2\}/\{df\}$... {confidence interval lower limit}/ {confidence interval upper limit}/ {estimated sample proportion}/ {estimated proportion of sample 1}/ {estimated proportion of sample 2}/ {degrees of freedom}
 - **{DIST}** ... {distribution calculation results}
 - $\{p\}/\{\mathbf{xInv}\}/\{\mathbf{x1Inv}\}/\{\mathbf{x2Inv}\}/\{\mathbf{zLow}\}/\{\mathbf{zUp}\}/\{\mathbf{tLow}\}/\{\mathbf{tUp}\}$... {probability distribution or cumulative distribution calculation result (p -value)}/ {inverse Student- t , χ^2 , F , binomial, Poisson, geometric or hypergeometric cumulative distribution calculation result}/ {inverse normal cumulative distribution upper limit (right edge) or lower limit (left edge)}/ {inverse normal cumulative distribution upper limit (right edge)}/ {normal cumulative distribution lower limit (left edge)}/ {normal cumulative distribution upper limit (right edge)}/ {Student- t cumulative distribution lower limit (left edge)}/ {Student- t cumulative distribution upper limit (right edge)}
- **GRAPH — Recalling graph functions**
 - $\{\mathbf{Y}\}/\{r\}$... {rectangular coordinate function ($Y=f(x)$ type)}/ {polar coordinate function}
 - $\{\mathbf{Xt}\}/\{\mathbf{Yt}\}$... parametric graph function $\{Xt\}/\{Yt\}$
 - $\{\mathbf{X}\}$... {rectangular coordinate function ($X=f(y)$ type)}
 - Press these keys before inputting a value to specify a memory area.
- **DYNA — Recalling dynamic graph setup data**
 - $\{\mathbf{Start}\}/\{\mathbf{End}\}/\{\mathbf{Pitch}\}$... {coefficient range start value}/ {coefficient range end value}/ {coefficient value increment}

● **TABLE — Recalling table setup and content data**

- **{Start}/{End}/{Pitch}** ... {table range start value}/{table range end value}/{table value increment}
- **{Result*1}** ... {matrix of table contents}

*1 The Result item appears only when the TABLE menu is displayed in the **Run-Matrix** and **Program** modes.

● **RECURSION — Recalling recursion formula*1, table range, and table content data**

- **{FORMULA}** ... {recursion formula data menu}
 - **{a_n}/{a_{n+1}}/{a_{n+2}}/{b_n}/{b_{n+1}}/{b_{n+2}}/{C_n}/{C_{n+1}}/{C_{n+2}}** ... {a_n}/{a_{n+1}}/{a_{n+2}}/{b_n}/{b_{n+1}}/{b_{n+2}}/{C_n}/{C_{n+1}}/{C_{n+2}} expressions
- **{RANGE}** ... {table range data menu}
 - **{Start}/{End}** ... table range {start value}/{end value}
 - **{a₀}/{a₁}/{a₂}/{b₀}/{b₁}/{b₂}/{C₀}/{C₁}/{C₂}** ... {a₀}/{a₁}/{a₂}/{b₀}/{b₁}/{b₂}/{C₀}/{C₁}/{C₂} value
 - **{a_nStart}/{b_nStart}/{C_nStart}** ... origin of {a_n}/{b_n}/{C_n} recursion formula convergence/divergence graph (WEB graph)
- **{Result*2}** ... {matrix of table contents*3}

*1 An error occurs when there is no function or recursion formula numeric table in memory.

*2 “Result” is available only in the **Run-Matrix** and **Program** modes.

*3 Table contents are stored automatically in Matrix Answer Memory (MatAns).

● **EQUATION — Recalling equation coefficients and solutions*1 *2**

- **{SimRes}/{SimCoef}** ... matrix of {solutions*3}/{coefficients} for linear equations with two through six unknowns*4
- **{PlyRes}/{PlyCoef}** ... matrix of {solution}/{coefficients} for high-order equations from 2nd to 6th degree

*1 Coefficients and solutions are stored automatically in Matrix Answer Memory (MatAns).

*2 The following conditions cause an error.

- When there are no coefficients input for the equation
- When there are no solutions obtained for the equation

*3 When the “Infinitely Many Solutions” or “No Solution” message is displayed, the calculation result is Rref (reduced row echelon form).

*4 Coefficient and solution memory data for a linear equation cannot be recalled at the same time.

● **FINANCE — Recalling financial calculation data**

- **{n}/{I%}/{PV}/{PMT}/{FV}** ... {payment periods (installments)}/{annual interest rate}/{present value}/{payment}/{future value}
- **{P/Y}/{C/Y}** ... {installment periods per year}/{compounding periods per year}

● **Str — Str command**

- **{Str}** ... {string memory}

7. Program (PRGM) Menu

To display the program (PRGM) menu, first enter the **Run-Matrix** or **Program** mode from the Main Menu and then press $\boxed{\text{SHIFT}} \boxed{\text{VARS}}$ (PRGM). The following are the selections available in the program (PRGM) menu.

- The program (PRGM) menu items are not displayed when “Math” is selected for the “Input/Output” mode setting on the Setup screen.
- {**COMMAND**}{program command menu}
- {**CONTROL**}{program control command menu}
- {**JUMP**}{jump command menu}
- {**?**}{input command}
- {**▲**}{output command}
- {**CLEAR**}{clear command menu}
- {**DISPLAY**}{display command menu}
- {**RELATNL**}{conditional jump relational operator menu}
- {**I/O**}{I/O control/transfer command menu}
- {**:**}{multi-statement command}
- {**STR**}{string command}

The following function key menu appears if you press $\boxed{\text{SHIFT}} \boxed{\text{VARS}}$ (PRGM) in the **Run-Matrix** mode or the **Program** mode while binary, octal, decimal, or hexadecimal is set as the default number system.

- {**Prog**}{program recall}
- {**JUMP**}/{**?**}/{**▲**}/{**RELATNL**}/{**:**}

The functions assigned to the function keys are the same as those in the Comp mode.

For details on the commands that are available in the various menus you can access from the program menu, see “Chapter 8 Programming”.

8. Using the Setup Screen

The mode's Setup screen shows the current status of mode settings and lets you make any changes you want. The following procedure shows how to change a setup.

• To change a mode setup

1. Select the icon you want and press **[EXE]** to enter a mode and display its initial screen. Here we will enter the **Run-Matrix** mode.
2. Press **[SHIFT] [MENU]** (SET UP) to display the mode's Setup screen.
 - This Setup screen is just one possible example. Actual Setup screen contents will differ according to the mode you are in and that mode's current settings.

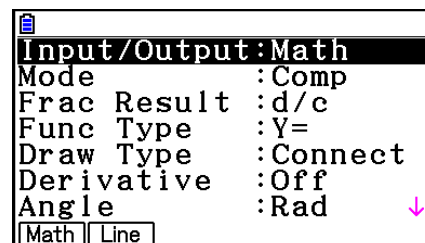

⋮

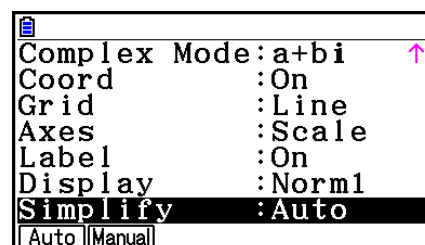

3. Use the **[▲]** and **[▼]** cursor keys to move the highlighting to the item whose setting you want to change.
4. Press the function key (**[F1]** to **[F6]**) that is marked with the setting you want to make.
5. After you are finished making any changes you want, press **[EXIT]** to exit the Setup screen.

■ Setup Screen Function Key Menus

This section details the settings you can make using the function keys in the Setup screen.  indicates default setting.

- The setting of each item with a frame around it is indicated by an icon in the status bar.

• **Input/Output** (input/output mode) **[Math] [Line]**

-  **[Math]**/**[Line]** ... {Math}/{Linear} input/output mode

• **Mode** (calculation/binary, octal, decimal, hexadecimal mode)

-  **[Comp]** ... {arithmetic calculation mode}
- **[Dec]**/**[Hex]**/**[Bin]**/**[Oct]** ... {decimal}/{hexadecimal}/{binary}/{octal}

• **Frac Result** (fraction result display format) **[d/c] [ab/c]**

-  **[d/c]**/**[ab/c]** ... {improper}/{mixed} fraction

- **Func Type (graph function type)**

Pressing one of the following function keys also switches the function of the $\boxed{X,\theta,T}$ key.

- $\{\underline{Y=}\}/\{\underline{r=}\}/\{\underline{\text{Parm}}\}/\{\underline{X=}\}$... {rectangular coordinate ($Y=f(x)$ type)}/{polar coordinate}/
{parametric}/{rectangular coordinate ($X=f(y)$ type)} graph
- $\{\underline{Y>}\}/\{\underline{Y<}\}/\{\underline{Y\geq}\}/\{\underline{Y\leq}\}$... $\{y>f(x)\}/\{y<f(x)\}/\{y\geq f(x)\}/\{y\leq f(x)\}$ inequality graph
- $\{\underline{X>}\}/\{\underline{X<}\}/\{\underline{X\geq}\}/\{\underline{X\leq}\}$... $\{x>f(y)\}/\{x<f(y)\}/\{x\geq f(y)\}/\{x\leq f(y)\}$ inequality graph

- **Draw Type (graph drawing method)**

- $\{\underline{\text{Connect}}\}/\{\underline{\text{Plot}}\}$... {connected points}/{unconnected points}

- **Derivative (derivative value display)**

- $\{\underline{\text{On}}\}/\{\underline{\text{Off}}\}$... {display on}/{display off} while Graph-to-Table, Table & Graph, and Trace are being used

- **Angle (default angle unit) $\boxed{\text{Rad}}$ $\boxed{\text{Deg}}$ $\boxed{\text{Gra}}$**

- $\{\underline{\text{Deg}}\}/\{\underline{\text{Rad}}\}/\{\underline{\text{Gra}}\}$... {degrees}/{radians}/{grads}

- **Complex Mode $\boxed{\text{Real}}$ $\boxed{a+bi}$ $\boxed{r\angle\theta}$**

- $\{\underline{\text{Real}}\}$... {calculation in real number range only}
- $\{\underline{a+bi}\}/\{\underline{r\angle\theta}\}$... {rectangular format}/{polar format} display of a complex calculation

- **Coord (graph pointer coordinate display)**

- $\{\underline{\text{On}}\}/\{\underline{\text{Off}}\}$... {display on}/{display off}

- **Grid (graph gridline display)**

- $\{\underline{\text{On}}\}/\{\underline{\text{Off}}\}/\{\underline{\text{Line}}\}$... {show grid as dots}/{hide grid}/{show grid as lines}

- **Axes (graph axis display)**

- $\{\underline{\text{On}}\}/\{\underline{\text{Off}}\}/\{\underline{\text{Scale}}\}$... {show axis}/{hide axis}/{show axis and scale}

- **Label (graph axis label display)**

- $\{\underline{\text{On}}\}/\{\underline{\text{Off}}\}$... {display on}/{display off}

- **Display (display format) $\boxed{\text{Fix2}}$ $\boxed{\text{Sci3}}$ $\boxed{\text{Norm1}}$**

- $\{\underline{\text{Fix}}\}/\{\underline{\text{Sci}}\}/\{\underline{\text{Norm}}\}/\{\underline{\text{Eng}}\}$... {fixed number of decimal places specification}/{number of significant digits specification}/{normal display setting}/{engineering mode}
- When the Engineering mode is on, “/E” is appended after the status bar icon, such as $\boxed{\text{Norm1/E}}$.

- **Stat Wind (statistical graph V-Window setting method)**

- $\{\underline{\text{Auto}}\}/\{\underline{\text{Manual}}\}$... {automatic}/{manual}

- **Resid List (residual calculation)**

- $\{\underline{\text{None}}\}/\{\underline{\text{LIST}}\}$... {no calculation}/{list specification for the calculated residual data}

- **List File (list file display settings)**
 - **{FILE}** ... {settings of list file on the display}
- **Sub Name (list naming)**
 - **{On}/{Off}** ... {display on}/{display off}
- **Graph Func (function display during graph drawing and trace)**
 - **{On}/{Off}** ... {display on}/{display off}
- **Dual Screen (dual screen mode status)**
 - **{G+G}/{GtoT}/{Off}** ... {graphing on both sides of dual screen}/{graph on one side and numeric table on the other side of dual screen}/{dual screen off}
- **Simul Graph (simultaneous graphing mode)**
 - **{On}/{Off}** ... {simultaneous graphing on (all graphs drawn simultaneously)}/{simultaneous graphing off (graphs drawn in area numeric sequence)}
- **Background (background image display)**
 - **{None}/{PICT n}/{OPEN}**... {no background}/{specify picture memory image as the background}/{specify an image as the background}
- **Plot/LineCol (plot and line color)**
 - **{Black}/{Blue}/{Red}/{Magenta}/{Green}/{Cyan}/{Yellow}**... Specifies a color for plots and graph lines.
- **Sketch Line (overlaid line type)**
 - **{—}/{—}/{.....}/{.....}/{—}** ... {normal}/{thick}/{broken}/{dotted}/{thin}
- **Dynamic Type (dynamic graph type)**
 - **{Cont}/{Stop}** ... {non-stop (continuous)}/{automatic stop after 10 draws}
- **Locus (dynamic graph locus mode)**
 - **{On}/{Off}** ... {locus drawn}/{locus not drawn}
- **Y=Draw Speed (dynamic graph draw speed)**
 - **{Norm}/{High}** ... {normal}/{high-speed}
- **Variable (table generation and graph draw settings)**
 - **{RANG}/{LIST}** ... {use table range}/{use list data}
- **ΣDisplay (Σ value display in recursion table)**
 - **{On}/{Off}** ... {display on}/{display off}

- **Slope (display of derivative at current pointer location in conic section graph)**
 - **{On}/{Off}** ... {display on}/{display off}
- **Payment (payment period setting) Bgn→ →End**
 - **{BEGIN}/{END}** ... {beginning}/{end} setting of payment period
- **Date Mode (number of days per year setting) 365 360**
 - **{365}/{360}** ... interest calculations using {365}/{360} days per year
- **Periods/YR. (payment interval specification) Annu Semi**
 - **{Annual}/{Semi}** ... {annual}/{semiannual}
- **Graph Color**
 - **{Black}/{Blue}/{Red}/{Magenta}/{Green}/{Cyan}/{Yellow}** ... Specifies a single line color for graphing in the **Financial** mode.
- **Ineq Type (inequality fill specification)**
 - **{Intsect}/{Union}** ... When graphing multiple inequalities, {fill areas where all inequality conditions are satisfied}/{fill areas where each inequality condition is satisfied}
- **Simplify (calculation result auto/manual reduction specification)**
 - **{Auto}/{Manual}** ... {auto reduce and display}/{display without reduction}
- **Q1Q3 Type (Q₁/Q₃ calculation formulas)**
 - **{Std}/{OnData}** ... {divide total population on its center point between upper and lower groups, with the median of the lower group Q₁ and the median of the upper group Q₃}/ {make the value of element whose cumulative frequency ratio is greater than 1/4 and nearest to 1/4 Q₁ and the value of element whose cumulative frequency ratio is greater than 3/4 and nearest to 3/4 Q₃}
- **Auto Calc (spreadsheet auto calc)**
 - **{On}/{Off}** ... {execute}/{not execute} the formulas automatically
- **Show Cell (spreadsheet cell display mode)**
 - **{Form}/{Val}** ... {formula}^{*1}/{value}
- **Move (spreadsheet cell cursor direction)^{*2}**
 - **{Low}/{Right}** ... {move down}/{move right}

*1 Selecting “Form” (formula) causes a formula in the cell to be displayed as a formula. The “Form” does not affect any non-formula data in the cell.

*2 Specifies the direction the cell cursor moves when you press the **EXE** key to register cell input, when the Sequence command generates a number table, and when you recall data from List memory.

9. Using Screen Capture

Any time while operating the calculator, you can capture an image of the current screen and save it in capture memory.

• To capture a screen image

1. Operate the calculator and display the screen you want to capture.
2. Press **SHIFT** **7** (CAPTURE).
 - This displays a memory area selection dialog box.

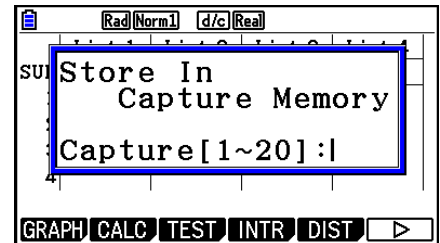

3. Input a value from 1 to 20 and then press **EXE**.
 - This will capture the screen image and save it in capture memory area named "Capt *n*" (*n* = the value you input).
- You cannot capture the screen image of a message indicating that an operation or data communication is in progress.
- A Memory ERROR will occur if there is not enough room in main memory to store the screen capture.

• To recall a screen image from capture memory

This operation is possible only while the Linear input/output mode is selected.

1. In the **Run-Matrix** mode, press **OPTN** **F6** (▷) **F6** (▷) **F5** (CAPTURE) **F1** (Recall).

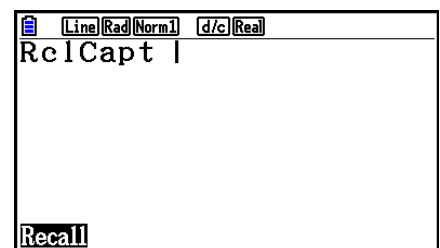

2. Enter a capture memory number in the range of 1 to 20, and then press **EXE**.
 - This displays the image stored in the capture memory you specified.
 3. To exit the image display and return to the screen you started from in step 1, press **EXIT**.
- You can also use the RclCapt command in a program to recall a screen image from capture memory.

10. When you keep having problems...

If you keep having problems when you are trying to perform operations, try the following before assuming that there is something wrong with the calculator.

■ Getting the Calculator Back to its Original Mode Settings

1. From the Main Menu, enter the **System** mode.
2. Press **F5** (RESET).
3. Press **F1** (SETUP), and then press **F1** (Yes).
4. Press **EXIT** **MENU** to return to the Main Menu.

Now enter the correct mode and perform your calculation again, monitoring the results on the display.

■ Restart and Reset

● Restart

Should the calculator start to act abnormally, you can restart it by pressing the RESTART button. Note, however, that you should only use the RESTART button only as a last resort. Normally, pressing the RESTART button reboots the calculator's operating system, so programs, graph functions and other data in calculator memory is retained.

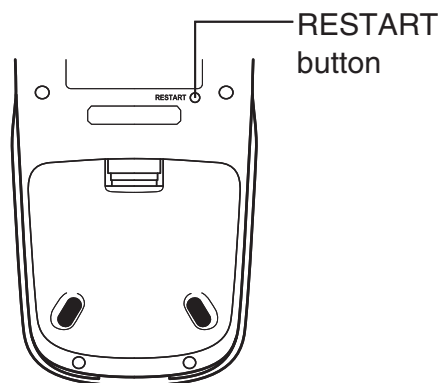

Important!

The calculator backs up user data (main memory) when you turn power off and loads the backed up data when you turn power back on.

When you press the RESTART button, the calculator restarts and loads backed up data. This means that if you press the RESTART button after you edit a program, graph function, or other data, any data that has not been backed up will be lost.

Note

Pressing the RESTART button to restart the calculator will cause the Battery Settings screen to appear on the display. For details about the settings on this screen, see "Battery Settings" (page 12-6).

● Reset

Use reset when you want to delete all data currently in calculator memory and return all mode settings to their initial defaults.

Before performing the reset operation, first make a written copy of all important data. For details, see “Reset” (page 12-4).

■ Low Battery Message

If the following message appears on the display, immediately turn off the calculator and replace batteries as instructed.

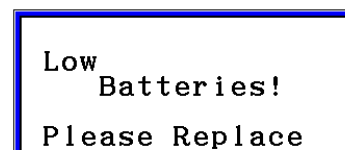

Low
Batteries!
Please Replace

If you continue using the calculator without replacing batteries, power will automatically turn off to protect memory contents. Once this happens, you will not be able to turn power back on, and there is the danger that memory contents will be corrupted or lost entirely.

- You will not be able to perform data communication operations after the low battery message appears.

■ Image File Compatibility

An image file (g3p/g3b) saved (or updated) on the fx-CG20/fx-CG20 AU will not be compatible with the fx-CG10.

- “To capture a screen image” (page 1-36)
- “To update the background image V-Window settings with current V-Window settings” (page 5-11)
- “Adjusting the Lightness (Fade I/O) of the Background Image” (page 5-12)
- “Saving Graph Screen Contents as an Image (g3p File)” (page 5-21)
- “Saving Current Screen Contents as an Image (g3p File) in the **Geometry Mode**” (page 14-9)
- “Saving a File” (page 15-5)
- “**OPTN** **F1** (PICTURE)” under “Graph Screen Key Operations” (page 8-39)
- Other image files saved from the graph screen of any mode (**Statistics**, **Spreadsheet**, **Financial**, etc.)

Note

- The fx-CG10 will not be able to import image files saved using the above procedures on the fx-CG20/fx-CG20 AU.
- The fx-CG20/fx-CG20 AU will be able to read image files saved using the above procedures on the fx-CG10.
- eActivity files that contain inserted images that were stored (or updated) on the fx-CG20/fx-CG20 AU cannot be opened with the fx-CG10.
- If the message “Provided by CASIO” appears at the bottom of the detail screen of an image file or eActivity file that was displayed using the operation under “Viewing Detailed Information about a File in Storage Memory” (page 11-6), that file can be opened on both the fx-CG10 and the fx-CG20/fx-CG20 AU.

Chapter 2 Manual Calculations

1. Basic Calculations

■ Arithmetic Calculations

- Enter arithmetic calculations as they are written, from left to right.
- Use the \ominus key to input the minus sign before a negative value.
- Calculations are performed internally with a 15-digit mantissa. The result is rounded to a 10-digit mantissa before it is displayed.
- For mixed arithmetic calculations, multiplication and division are given priority over addition and subtraction.

Example	Operation
$56 \times (-12) \div (-2.5) = 268.8$	56 \times \ominus 12 \div \ominus 2.5 EXE
$(2 + 3) \times 10^2 = 500$	$($ 2 $+$ 3 $)$ \times 1 EXP 2 EXE
$2 + 3 \times (4 + 5) = 29$	2 $+$ 3 \times $($ 4 $+$ 5 EXE ^{*1}
$\frac{6}{4 \times 5} = \frac{3}{10} (0.3)$	$\frac{a}{b}$ 6 \div 4 \times 5 EXE <Linear input/output mode> 6 \div $($ 4 \times 5 $)$ EXE

*1 Final closed parentheses (immediately before operation of the EXE key) may be omitted, no matter how many are required.

■ Number of Decimal Places, Number of Significant Digits, Normal Display Range

[SET UP]- [Display]- [Fix]/[Sci]/[Norm]

- Even after you specify the number of decimal places or the number of significant digits, internal calculations are still performed using a 15-digit mantissa, and displayed values are stored with a 10-digit mantissa. Use Rnd of the Numeric Calculation Menu (NUMERIC) (page 2-14) to round the displayed value off to the number of decimal place and significant digit settings.
- Number of decimal place (Fix) and significant digit (Sci) settings normally remain in effect until you change them or until you change the normal display range (Norm) setting.

Example 1 $100 \div 6 = 16.66666666\dots$

Condition	Operation	Display
	$100 \div 6$ [EXE]	16.66666667
4 decimal places	[SHIFT] [MENU] (SET UP) [▲] [▲] [F1] (Fix) [4] [EXE] [EXIT] [EXE]	16.6667 ^{*1}
5 significant digits	[SHIFT] [MENU] (SET UP) [▲] [▲] [F2] (Sci) [5] [EXE] [EXIT] [EXE]	1.6667 ^{*1} _{E+01}
Cancels specification	[SHIFT] [MENU] (SET UP) [▲] [▲] [F3] (Norm) [EXIT] [EXE]	16.66666667

*1 Displayed values are rounded off to the place you specify.

Example 2 $200 \div 7 \times 14 = 400$

Condition	Operation	Display
	$200 \div 7$ [X] 14 [EXE]	400
3 decimal places	[SHIFT] [MENU] (SET UP) [▲] [▲] [F1] (Fix) [3] [EXE] [EXIT] [EXE]	400.000
Calculation continues using display capacity of 10 digits	$200 \div 7$ [EXE] [X] 14 [EXE]	28.571 Ans × ■ 400.000

- If the same calculation is performed using the specified number of digits:

	$200 \div 7$ [EXE]	28.571
The value stored internally is rounded off to the number of decimal places specified on the Setup screen.	[OPTN] [F6] (>) [F4] (NUMERIC) [F4] (Rnd) [EXE] [X]	28.571 Ans × ■
	14 [EXE]	399.994
You can also specify the number of decimal places for rounding of internal values for a specific calculation. (Example: To specify rounding to two decimal places)	$200 \div 7$ [EXE]	28.571
	[F6] (>) [F1] (RndFix) [SHIFT] [(-)] (Ans) [2] [)] [EXE] [X]	RndFix(Ans,2) 28.570 Ans × ■
	14 [EXE]	399.980

- You cannot use a first derivative, second derivative, integration, Σ , maximum/minimum value, Solve, RndFix or $\log_a b$ calculation expression inside of a RndFix calculation term.

■ Calculation Priority Sequence

This calculator employs true algebraic logic to calculate the parts of a formula in the following order:

① Type A functions

- Coordinate transformation Pol (x, y), Rec (r, θ)
- Functions that include parentheses (such as derivatives, integrations, Σ , etc.)
 $d/dx, d^2/dx^2, \int dx, \Sigma, \text{Solve, SolveN, FMin, FMax, List} \rightarrow \text{Mat, Fill, Seq, SortA, SortD, Min, Max, Median, Mean, Augment, Mat} \rightarrow \text{List, DotP, CrossP, Angle, UnitV, Norm, P(, Q(, R(, t(, RndFix, log}_a b$
- Composite functions*¹, List, Mat, Vct, fn, **Yn, rn, Xtn, Ytn, Xn**

② Type B functions

With these functions, the value is entered and then the function key is pressed.

$x^2, x^{-1}, x!, ' ', \text{ENG symbols, angle unit } ^\circ, ^\circ, ^\circ$

③ Power/root $^{\wedge}(x^y), \sqrt[x]{}$

④ Fractions a^b/c

⑤ Implied multiplication format in front of π , memory name, or variable name.

$2\pi, 5A, Xmin, F \text{ Start, etc.}$

⑥ Type C functions

With these functions, the function key is pressed and then the value is entered.

$\sqrt{}, \sqrt[3]{}, \log, \ln, e^x, 10^x, \sin, \cos, \tan, \sin^{-1}, \cos^{-1}, \tan^{-1}, \sinh, \cosh, \tanh, \sinh^{-1}, \cosh^{-1}, \tanh^{-1}, (-), d, h, b, o, \text{Neg, Not, Det, Trn, Dim, Identity, Ref, Rref, Sum, Prod, Cuml, Percent, } \Delta \text{List, Abs, Int, Frac, Intg, Arg, Conjg, ReP, ImP}$

⑦ Implied multiplication format in front of Type A functions, Type C functions, and parenthesis.

$2\sqrt{3}, A \log 2, \text{ etc.}$

⑧ Permutation, combination, complex number operator in polar form nPr, nCr, \angle

⑨ Metric conversion commands*²

⑩ $\times, \div, \text{Int}\div, \text{Rmdr}$

⑪ $+, -$

⑫ Relational operators $=, \neq, >, <, \geq, \leq$

⑬ And (logical operator), and (bitwise operator)

⑭ Or, Xor (logical operator), or, xor, xnor (bitwise operator)

*¹ You can combine the contents of multiple function memory (fn) locations or graph memory (**Yn, rn, Xtn, Ytn, Xn**) locations into composite functions. Specifying fn1(fn2), for example, results in the composite function fn1 \circ fn2 (see page 5-14). A composite function can consist of up to five functions.

*² Metric conversion commands are supported only when the Metric Conversion add-in application is installed.

Example $2 + 3 \times (\log \sin 2\pi^2 + 6.8) = 22.07101691$ (angle unit = Rad)

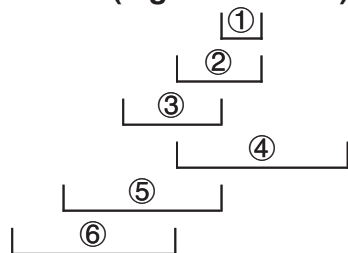

- When functions with the same priority are used in series, execution is performed from right to left.

$$e^{x \ln \sqrt{120}} \rightarrow e^{x \{ \ln(\sqrt{120}) \}}$$

Otherwise, execution is from left to right.

- Compound functions are executed from right to left.
- Anything contained within parentheses receives highest priority.

■ Calculation Result Irrational Number Display

You can configure the calculator to display calculation results in irrational number format (including $\sqrt{\quad}$ or π) by selecting “Math” for the “Input/Output” mode setting on the Setup screen.

Example $\sqrt{2} + \sqrt{8} = 3\sqrt{2}$ (Input/Output: Math)

$\text{[SHIFT] [x}^2\text{] } (\sqrt{\quad}) \text{ [2] [▶] [+] [SHIFT] [x}^2\text{] } (\sqrt{\quad}) \text{ [8] [EXE]}$

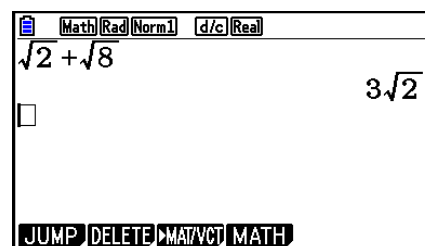

● Calculation Result Display Range with $\sqrt{\quad}$

Display of a calculation result in $\sqrt{\quad}$ format is supported for result with $\sqrt{\quad}$ in up to two terms. Calculation results in $\sqrt{\quad}$ format take one of the following forms.

$$\pm a\sqrt{b}, \pm d \pm a\sqrt{b}, \pm \frac{a\sqrt{b}}{c} \pm \frac{d\sqrt{e}}{f}$$

- The following are the ranges for each of the coefficients (a, b, c, d, e, f) can be displayed in the $\sqrt{\quad}$ calculation result format.

$$1 \leq a < 100, 1 < b < 1000, 1 \leq c < 100$$

$$0 \leq d < 100, 0 \leq e < 1000, 1 \leq f < 100$$

- In the cases shown below, a calculation result may be able to be displayed in $\sqrt{\quad}$ format even if their coefficients (a, c, d) are outside the above ranges.

A $\sqrt{\quad}$ format calculation result uses a common denominator.

$$\frac{a\sqrt{b}}{c} + \frac{d\sqrt{e}}{f} \rightarrow \frac{a'\sqrt{b} + d'\sqrt{e}}{c'} \quad *c' \text{ is the least common multiple of } c \text{ and } f.$$

Since the calculation result uses a common denominator, calculation result still may be displayed using the $\sqrt{\quad}$ format even when coefficients (a' , c' , d') are outside the corresponding range of coefficients (a , c , d).

Example: $\frac{\sqrt{3}}{11} + \frac{\sqrt{2}}{10} = \frac{10\sqrt{3} + 11\sqrt{2}}{110}$

Calculation Examples

This calculation:	Produces this type of display:
$2 \times (3 - 2\sqrt{5}) = 6 - 4\sqrt{5}$	$\sqrt{\quad}$ format
$35\sqrt{2} \times 3 = 148.492424 (= \underline{105}\sqrt{2})^{*1}$	Decimal format
$\frac{\underline{150}\sqrt{2}}{25} = 8.485281374^{*1}$	
$23 \times (5 - 2\sqrt{3}) = 35.32566285 (= \underline{115} - 46\sqrt{3})^{*1}$	Decimal format
$\sqrt{2} + \sqrt{3} + \sqrt{8} = \sqrt{3} + 3\sqrt{2}$	$\sqrt{\quad}$ format
$\underline{\sqrt{2} + \sqrt{3} + \sqrt{6}} = 5.595754113^{*2}$	Decimal format

*1 Decimal format because values are outside of range.

*2 Decimal format because calculation result has three terms.

- The calculation result is displayed using decimal format even if an intermediate result goes greater than two terms.

Example: $(1 + \sqrt{2} + \sqrt{3})(1 - \sqrt{2} - \sqrt{3}) = -4 - 2\sqrt{6}$
 $= -8.898979486$

- If the calculation formula has a $\sqrt{\quad}$ term and a term that cannot be displayed as a fraction, the calculation result will be displayed in decimal format.

Example: $\log 3 + \sqrt{2} = 1.891334817$

• Calculation Result Display Range with π

A calculation results is displayed using π format in the following cases.

- When the calculation result can be displayed in the form $n\pi$

n is an integer up to $|10^6|$.

- When the calculation result can be displayed in the form $a\frac{b}{c}\pi$ or $\frac{b}{c}\pi$

However, {number of a digits + number of b digits + number of c digits} must be 8 or less

when the above $a\frac{b}{c}$ or $\frac{b}{c}$ is reduced.*1*2 Also, the maximum number of allowable c digits is three.*2

*1 When $c < b$, the number of a , b , and c digits are counted when the fraction is converted from an improper fraction ($\frac{b}{c}$) to a mixed fraction ($a\frac{b}{c}$).

*2 When "Manual" is specified for the Setup screen "Simplify" setting, the calculation result may be displayed in decimal format, even if these conditions are met.

Calculation Examples

This calculation:	Produces this type of display:
$78\pi \times 2 = 156\pi$	π format
$123456\pi \times 9 = 3490636.164 (= \underbrace{11111104}_{\text{wavy}} \pi)^{*3}$	Decimal format
$105 \frac{568}{824} \pi = 105 \frac{71}{103} \pi$	π format
$2 \frac{258}{3238} \pi = \underbrace{6.533503684}_{\text{wavy}} \left(2 \frac{129}{1619} \pi\right)^{*4}$	Decimal format

*3 Decimal format because calculation result integer part is $|10^6|$ or greater.

*4 Decimal format because number of denominator digits is four or greater for the $a \frac{b}{c} \pi$ form.

■ Multiplication Operations without a Multiplication Sign

You can omit the multiplication sign (\times) in any of the following operations.

- Before Type A functions (① on page 2-3) and Type C functions (⑥ on page 2-3), except for negative signs

Example 1 $2\sin 30$, $10\log 1.2$, $2\sqrt{3}$, $2\text{Pol}(5, 12)$, etc.

- Before constants, variable names, memory names

Example 2 2π , $2AB$, 3Ans , $3Y_1$, etc.

- Before an open parenthesis

Example 3 $3(5 + 6)$, $(A + 1)(B - 1)$, etc.

If you execute a calculation that includes both division and multiplication operations in which a multiplication sign has been omitted, parentheses will be inserted automatically as shown in the examples below.

- When a multiplication sign is omitted immediately before an open parenthesis or after a closed parenthesis.

Example 1 $6 \div 2(1 + 2) \rightarrow 6 \div (2(1 + 2))$
 $6 \div A(1 + 2) \rightarrow 6 \div (A(1 + 2))$
 $1 \div (2 + 3)\sin 30 \rightarrow 1 \div ((2 + 3)\sin 30)$

- When a multiplication sign is omitted immediately before a variable, a constant, etc.

Example 2 $6 \div 2\pi \rightarrow 6 \div (2\pi)$
 $2 \div 2\sqrt{2} \rightarrow 2 \div (2\sqrt{2})$
 $4\pi \div 2\pi \rightarrow 4\pi \div (2\pi)$

If you execute a calculation in which a multiplication sign has been omitted immediately before a fraction (including mixed fractions), parentheses will be inserted automatically as shown in the examples below.

Example $(2 \times \frac{1}{3}): 2\frac{1}{3} \rightarrow 2\left(\frac{1}{3}\right)$

Example $(\sin 2 \times \frac{4}{5}): \sin 2\frac{4}{5} \rightarrow \sin 2\left(\frac{4}{5}\right)$

■ Overflow and Errors

Exceeding a specified input or calculation range, or attempting an illegal input causes an error message to appear on the display. Further operation of the calculator is impossible while an error message is displayed. For details, see the “Error Message Table” on page α -1.

- Most of the calculator’s keys are inoperative while an error message is displayed. Press **EXIT** to clear the error and return to normal operation.

■ Memory Capacity

Each time you press a key, either one byte or two bytes is used. Some of the functions that require one byte are: **1**, **2**, **3**, sin, cos, tan, log, ln, $\sqrt{\quad}$, and π .

Some of the functions that take up two bytes are d/dx(, Mat, Vct, Xmin, If, For, Return, DrawGraph, SortA(, PxlOn, Sum, and a_{n+1} .

- The required number of bytes to input functions and commands is different in the Linear input/output mode and the Math input/output mode. For details about the number of bytes required for each function in the Math input/output mode, see page 1-13.

2. Special Functions

■ Calculations Using Variables

Example	Operation	Display
	$193.2 \rightarrow$ ALPHA X,θ,T (A) EXE	193.2
$193.2 \div 23 = 8.4$	ALPHA X,θ,T (A) ÷ 23 EXE	8.4
$193.2 \div 28 = 6.9$	ALPHA X,θ,T (A) ÷ 28 EXE	6.9

■ Memory

● Variables (Alpha Memory)

This calculator comes with 28 variables as standard. You can use variables to store values you want to use inside of calculations. Variables are identified by single-letter names, which are made up of the 26 letters of the alphabet, plus r and θ . The maximum size of values that you can assign to variables is 15 digits for the mantissa and 2 digits for the exponent.

- Variable contents are retained even when you turn power off.

• **To assign a value to a variable**

[value] \rightarrow [variable name] EXE

Example 1 To assign 123 to variable A

AC 1 2 3 \rightarrow ALPHA X,θ,T (A) EXE

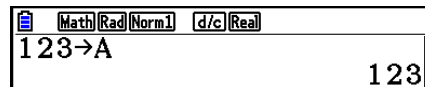

Example 2 To add 456 to variable A and store the result in variable B

AC ALPHA X,θ,T (A) $+$ 4 5 6 \rightarrow
 ALPHA \log (B) EXE

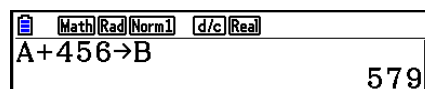

- You can input an X variable by pressing ALPHA $+$ (X) or X,θ,T . Pressing ALPHA $+$ (X) will input X, while pressing X,θ,T will input x. Values assigned to X and x are stored in the same memory area.

Example 3 Assign 10 to x and then assign 5 to X. Next, check what is assigned to x.

AC 1 0 \rightarrow X,θ,T EXE
 5 \rightarrow ALPHA $+$ (X) EXE
 X,θ,T EXE

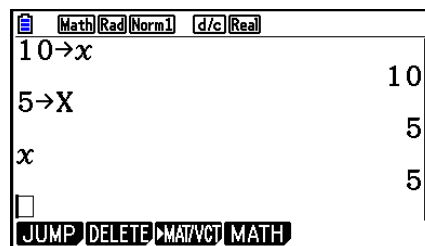

• **To assign the same value to more than one variable**

[value] \rightarrow [first variable name] ~ [last variable name] EXE

- You cannot use “r” or “θ” as a variable name.

Example To assign a value of 10 to variables A through F

AC 1 0 \rightarrow ALPHA X,θ,T (A)
 SHIFT 4 (CATALOG) \square
 \blacktriangledown \blacktriangledown \blacktriangledown ... \blacktriangledown (22 times)
 F1 (INPUT) ALPHA \tan (F) EXE

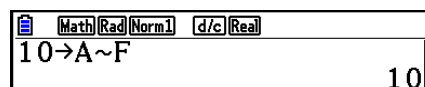

• **String Memory**

You can store up to 20 strings (named Str 1 to Str 20) in string memory. Stored strings can be output to the display or used inside functions and commands that support the use of strings as arguments.

For details about string operations, see “Strings” (page 8-25).

• **To recall a function**

Example **To recall the contents of function memory number 1**

AC OPTN F6 (▷) F6 (▷) F3 (FUNCMEM)
 F2 (RECALL) 1 EXE

Line	Rad	Norm1	d/c	Real
(A+B) (A-B)				

- The recalled function appears at the current location of the cursor on the display.

• **To recall a function as a variable**

AC 3 → ALPHA X,θ,T (A) EXE
 1 → ALPHA log (B) EXE
 OPTN F6 (▷) F6 (▷) F3 (FUNCMEM) F3 (fn)
 1 + 2 EXE

Line	Rad	Norm1	d/c	Real
3→A				
				3
1→B				
				1
f _n 1+2				
				10

• **To display a list of available functions**

OPTN F6 (▷) F6 (▷) F3 (FUNCMEM)
 F4 (SEE)

== Function Memory ==				
f ₁ : (A+B) (A-B)				
f ₂ :				
f ₃ :				
f ₄ :				
f ₅ :				
f ₆ :				

• **To delete a function**

Example **To delete the contents of function memory number 1**

AC
 OPTN F6 (▷) F6 (▷) F3 (FUNCMEM)
 F1 (STORE) 1 EXE

Line	Rad	Norm1	d/c	Real

== Function Memory ==				
f ₁ :				

- Executing the store operation while the display is blank deletes the function in the function memory you specify.

■ Answer Function

The Answer Function automatically stores the last result you calculated by pressing $\boxed{\text{EXE}}$ (unless the $\boxed{\text{EXE}}$ key operation results in an error). The result is stored in the answer memory.

- The largest value that the answer memory can hold is 15 digits for the mantissa and 2 digits for the exponent.
- Answer memory contents are not cleared when you press the $\boxed{\text{AC}}$ key or when you switch power off.

• To use the contents of the answer memory in a calculation

Example $123 + 456 = 579$
 $789 - 579 = 210$

$\boxed{\text{AC}}$ $\boxed{1}$ $\boxed{2}$ $\boxed{3}$ $\boxed{+}$ $\boxed{4}$ $\boxed{5}$ $\boxed{6}$ $\boxed{\text{EXE}}$
 $\boxed{7}$ $\boxed{8}$ $\boxed{9}$ $\boxed{-}$ $\boxed{\text{SHIFT}}$ $\boxed{\leftarrow}$ (Ans) $\boxed{\text{EXE}}$

\mathcal{M}	Math	Rad	Norm1	d/c	Real
	123+456				579
	789-Ans				210

- Performing an operation that assigns a value to an Alpha memory (such as $\boxed{5}$ $\boxed{\rightarrow}$ $\boxed{\text{ALPHA}}$ $\boxed{\log}$ (B) $\boxed{\text{EXE}}$), answer memory contents are updated in the Math input/output mode but not in the Linear input/output mode.

■ Performing Continuous Calculations

Answer memory also lets you use the result of one calculation as one of the arguments in the next calculation.

Example $1 \div 3 =$
 $1 \div 3 \times 3 =$

$\boxed{\text{AC}}$ $\boxed{1}$ $\boxed{\div}$ $\boxed{3}$ $\boxed{\text{EXE}}$
 (Continuing) $\boxed{\times}$ $\boxed{3}$ $\boxed{\text{EXE}}$

\mathcal{M}	Math	Rad	Norm1	d/c	Real
	1÷3				0.3333333333
	Ans×3				1

Continuous calculations can also be used with Type B functions (x^2 , x^{-1} , $x!$, on page 2-3), $+$, $-$, $\wedge(x^y)$, $\sqrt[x]{\quad}$, $^{\circ}$, etc.

3. Specifying the Angle Unit and Display Format

Before performing a calculation, you should use the Setup screen to specify the angle unit and display format.

■ Setting the Angle Unit

[SET UP]- [Angle]

1. On the Setup screen, highlight “Angle”.
2. Press the function key for the angle unit you want to specify, then press [EXIT].

- {Deg}/{Rad}/{Gra} ... {degrees}/{radians}/{grads}
- The relationship between degrees, grads, and radians is shown below.

$$360^\circ = 2\pi \text{ radians} = 400 \text{ grads}$$

$$90^\circ = \pi/2 \text{ radians} = 100 \text{ grads}$$

■ Setting the Display Format

[SET UP]- [Display]

1. On the Setup screen, highlight “Display”.
2. Press the function key for the item you want to set, then press [EXIT].
 - {Fix}/{Sci}/{Norm}/{Eng} ... {fixed number of decimal places specification}/
{number of significant digits specification}/{normal display}/{Engineering mode}

• To specify the number of decimal places (Fix)

Example To specify two decimal places

[F1] (Fix) 2 [EXE]

|Display :Fix2|

Press the number key that corresponds to the number of decimal places you want to specify ($n = 0$ to 9).

- Displayed values are rounded off to the number of decimal places you specify.

- **To specify the number of significant digits (Sci)**

Example **To specify three significant digits**

F2 (Sci) **3** **EXE**

Display **:Sci3**

Press the number key that corresponds to the number of significant digits you want to specify ($n = 0$ to 9). Specifying 0 makes the number of significant digits 10 .

- Displayed values are rounded off to the number of significant digits you specify.

- **To specify the normal display (Norm 1/Norm 2)**

Press **F3** (Norm) to switch between Norm 1 and Norm 2.

Norm 1: 10^{-2} (0.01) $> |x|$, $|x| \geq 10^{10}$

Norm 2: 10^{-9} (0.000000001) $> |x|$, $|x| \geq 10^{10}$

- **To specify the engineering notation display (Eng mode)**

Press **F4** (Eng) to switch between engineering notation and standard notation. The indicator “/E” is on the display while engineering notation is in effect.

You can use the following symbols to convert values to engineering notation, such as $2,000$ ($= 2 \times 10^3$) \rightarrow $2k$.

E (Exa)	$\times 10^{18}$	m (milli)	$\times 10^{-3}$
P (Peta)	$\times 10^{15}$	μ (micro)	$\times 10^{-6}$
T (Tera)	$\times 10^{12}$	n (nano)	$\times 10^{-9}$
G (Giga)	$\times 10^9$	p (pico)	$\times 10^{-12}$
M (Mega)	$\times 10^6$	f (femto)	$\times 10^{-15}$
k (kilo)	$\times 10^3$		

- The engineering symbol that makes the mantissa a value from 1 to 1000 is automatically selected by the calculator when engineering notation is in effect.

4. Function Calculations

■ Function Menus

This calculator includes five function menus that give you access to scientific functions not printed on the key panel.

- The contents of the function menu differ according to the mode you entered from the Main Menu before you pressed the **[OPTN]** key. The following examples show function menus that appear in the **Run-Matrix** or **Program** mode.

● Hyperbolic Calculations (HYPERBL) [OPTN]-[HYPERBL]

- **{sinh}{cosh}{tanh}** ... hyperbolic {sine}{cosine}{tangent}
- **{sinh⁻¹}{cosh⁻¹}{tanh⁻¹}** ... inverse hyperbolic {sine}{cosine}{tangent}

● Probability/Distribution Calculations (PROB) [OPTN]-[PROB]

- **{x!}** ... press after inputting a value to obtain the factorial of the value
- **{nPr}{nCr}** ... {permutation}{combination}
- **{RAND}** ... {random number generation}
- **{Ran#}{Int}{Norm}{Bin}{List}{Samp}** ... {random number generation (0 to 1)}/{random integer generation}/{random number generation in accordance with normal distribution based on mean μ and standard deviation σ }/{random number generation in accordance with binomial distribution based on number of trials n and probability p }/{random number generation (0 to 1) and storage of result in ListAns}/{random extraction of list data elements and storage of result in ListAns}
- **{P}{Q}{R}** ... normal probability { $P(t)$ }{ $Q(t)$ }{ $R(t)$ }
- **{t}** ... {value of normalized variate $t(x)$ }

● Numeric Calculations (NUMERIC) [OPTN]-[NUMERIC]

- **{Abs}** ... select this item and input a value to obtain the absolute value of the value
- **{Int}{Frac}** ... select the item and input a value to extract the {integer}{fraction} part.
- **{Rnd}** ... rounds off the value used for internal calculations to 10 significant digits (to match the value in the answer memory), or to the number of decimal places (Fix) and number of significant digits (Sci) specified by you
- **{Intg}** ... select this item and input a value to obtain the largest integer that is not greater than the value
- **{RndFix}** ... rounds off the value used for internal calculations to specified digits (0 to 9) (see page 2-2)
- **{GCD}** ... {greatest common divisor for two values}
- **{LCM}** ... {least common multiple for two values}
- **{MOD}** ... {remainder of division (remainder output when n is divided by m)}
- **{MOD_Exp}** ... {remainder when division is performed on a power value (remainder output when n is raised to p power and then divided by m)}

• Angle Units, Coordinate Conversion, Sexagesimal Operations (ANGLE) [OPTN]-[ANGLE]

- {°}/{r}/{g} ... {degrees}/{radians}/{grads} for a specific input value
- {° ' ''} ... specifies degrees (hours), minutes, seconds when inputting a degrees/minutes/seconds value
- $\overleftarrow{\text{° ' ''}}$... converts decimal value to degrees/minutes/seconds value
 - The $\overleftarrow{\text{° ' ''}}$ menu operation is available only when there is a calculation result on the display.
- {Pol()}/{Rec()} ... {rectangular-to-polar}/{polar-to-rectangular} coordinate conversion
- {►DMS} ... converts decimal value to sexagesimal value

• Engineering Symbol (ENG-SYM) [OPTN]-[ENG-SYM]

- {m}/{μ}/{n}/{p}/{f} ... {milli (10⁻³)}/{micro (10⁻⁶)}/{nano (10⁻⁹)}/{pico (10⁻¹²)}/{femto (10⁻¹⁵)}
- {k}/{M}/{G}/{T}/{P}/{E} ... {kilo (10³)}/{mega (10⁶)}/{giga (10⁹)}/{tera (10¹²)}/{peta (10¹⁵)}/{exa (10¹⁸)}
- {ENG}/{ENG} ... shifts the decimal place of the displayed value three digits to the {left}/{right} and {decreases}/{increases} the exponent by three.

When you are using engineering notation, the engineering symbol is also changed accordingly.

 - The {ENG} and {ENG} menu operations are available only when there is a calculation result on the display.

■ Angle Units

- Be sure to specify Comp for Mode in the Setup screen.

Example	Operation
To convert 4.25 rad to degrees: 243.5070629	SHIFT MENU (SET UP) ▼ ▼ ▼ ▼ ▼ F1 (Deg) EXIT 4.25 OPTN F6 (▷) F5 (ANGLE) F2 (r) EXE
47.3° + 82.5rad = 4774.20181°	47.3 + 82.5 OPTN F6 (▷) F5 (ANGLE) F2 (r) EXE
2°20'30" + 39°30" = 3°00'00"	2 OPTN F6 (▷) F5 (ANGLE) F4 (° ' ") 20 F4 (° ' ") 30 F4 (° ' ") + 0 F4 (° ' ") 39 F4 (° ' ") 30 F4 (° ' ") EXE F5 ($\overleftarrow{\text{° ' ''}}$)
2.255° = 2°15'18"	2.255 OPTN F6 (▷) F5 (ANGLE) F6 (▷) F3 (►DMS) EXE

■ Trigonometric and Inverse Trigonometric Functions

- Be sure to set the angle unit before performing trigonometric function and inverse trigonometric function calculations.

$$(90^\circ = \frac{\pi}{2} \text{ radians} = 100 \text{ grads})$$

- Be sure to specify Comp for Mode in the Setup screen.

Example	Operation
$\cos\left(\frac{\pi}{3} \text{ rad}\right) = \frac{1}{2} \text{ (0.5)}$	$\text{[SHIFT] [MENU] (SET UP) [v] [v] [v] [v] [v] [v] [F2] (Rad) [EXIT]}$ $\text{[COS] [α] [SHIFT] [EXP] (π) [v] 3 [EXE]}$ <Linear input/output mode> $\text{[COS] [C] [SHIFT] [EXP] (π) [÷] 3 [)] [EXE]}$
$2 \cdot \sin 45^\circ \times \cos 65^\circ = 0.5976724775$	$\text{[SHIFT] [MENU] (SET UP) [v] [v] [v] [v] [v] [v] [F1] (Deg) [EXIT]}$ $2 \text{ [X] [sin] 45 \text{ [X] [cos] 65 [EXE]}^{*1}$
$\sin^{-1}0.5 = 30^\circ$ (x when $\sin x = 0.5$)	$\text{[SHIFT] [sin] (sin}^{-1}\text{) 0.5}^{*2} \text{ [EXE]}$

*1 [X] can be omitted.

*2 Input of leading zero is not necessary.

■ Logarithmic and Exponential Functions

- Be sure to specify Comp for Mode in the Setup screen.

Example	Operation
$\log 1.23 \text{ (log}_{10}\text{1.23)} = 0.08990511144$	[log] 1.23 [EXE]
$\log_2 8 = 3$	$\text{[F4] (MATH) [F2] (log}_{ab}\text{) 2 [▶] 8 [EXE]}$ <Linear input/output mode> $\text{[OPTN] [F4] (CALC) [F6] (▷) [F4] (log}_{ab}\text{) 2 [▶] 8 [)] [EXE]}$
$(-3)^4 = (-3) \times (-3) \times (-3) \times (-3) = 81$	$\text{[C] [(-)] 3 [)] [^] 4 [EXE]}$
$\sqrt[7]{123} \text{ (= } 123^{\frac{1}{7}}\text{)} = 1.988647795$	$\text{[SHIFT] [^] (x\sqrt{}) 7 [▶] 123 [EXE]}$ <Linear input/output mode> $7 \text{ [SHIFT] [^] (x\sqrt{}) 123 [EXE]}$

- The Linear input/output mode and Math input/output mode produce different results when two or more powers are input in series, like: 2 [^] 3 [^] 2 .

Linear input/output mode: $2^3^2 = 64$ **Math input/output mode:** $2^{3^2} = 512$

This is because the Math input/output mode internally treats the above input as: $2^{(3^2)}$.

Hyperbolic and Inverse Hyperbolic Functions

- Be sure to specify Comp for Mode in the Setup screen.

Example	Operation
$\sinh 3.6 = 18.28545536$	$\text{OPTN } \text{F6} (\triangleright) \text{F2} (\text{HYPERBL}) \text{F1} (\sinh) 3.6 \text{EXE}$
$\cosh^{-1} \left(\frac{20}{15} \right) = 0.7953654612$	$\text{OPTN } \text{F6} (\triangleright) \text{F2} (\text{HYPERBL}) \text{F5} (\cosh^{-1}) \text{a2} 20 \blacktriangledown 15 \text{EXE}$ <Linear input/output mode> $\text{OPTN } \text{F6} (\triangleright) \text{F2} (\text{HYPERBL}) \text{F5} (\cosh^{-1}) \text{C} 20$ $\text{a} 15 \text{D} \text{EXE}$

Other Functions

- Be sure to specify Comp for Mode in the Setup screen.

Example	Operation
$\sqrt{2} + \sqrt{5} = 3.65028154$	$\text{SHIFT } \text{x}^2 (\sqrt{}) 2 \blacktriangleright + \text{SHIFT } \text{x}^2 (\sqrt{}) 5 \text{EXE} \text{F-D}$ <Linear input/output mode> $\text{SHIFT } \text{x}^2 (\sqrt{}) 2 + \text{SHIFT } \text{x}^2 (\sqrt{}) 5 \text{EXE}$
$(-3)^2 = (-3) \times (-3) = 9$	$\text{C} (\leftarrow) 3 \text{D} \text{x}^2 \text{EXE}$
$8! (= 1 \times 2 \times 3 \times \dots \times 8) = 40320$	$8 \text{OPTN } \text{F6} (\triangleright) \text{F3} (\text{PROB}) \text{F1} (x!) \text{EXE}$
What is the integer part of -3.5 ? - 3	$\text{OPTN } \text{F6} (\triangleright) \text{F4} (\text{NUMERIC}) \text{F2} (\text{Int}) (\leftarrow) 3.5 \text{EXE}$

Random Number Generation (RAND)

• Random Number Generation (0 to 1) (Ran#, RanList#)

Ran# and RanList# generate 10 digit random numbers randomly or sequentially from 0 to 1. Ran# returns a single random number, while RanList# returns multiple random numbers in list form. The following shows the syntaxes of Ran# and RanList#.

Ran# [a] $1 \leq a \leq 9$

RanList# (n [,a]) $1 \leq n \leq 999$

- n is the number of trials. RanList# generates the number of random numbers that corresponds to n and displays them on the ListAns screen. A value must be input for n .
- “ a ” is the randomization sequence. Random numbers are returned if nothing is input for “ a ”. Entering an integer of 1 through 9 for a will return the corresponding sequential random number.
- Executing the function Ran# 0 initializes the sequences of both Ran# and RanList#. The sequence also is initialized when a sequential random number is generated with a different sequence of the previous execution using Ran# or RanList#, or when generating a random number.

Ran# Examples

Example	Operation
Ran# (Generates a random number.)	OPTN F6 (\triangleright) F3 (PROB) F4 (RAND) F1 (Ran#) EXE
(Each press of EXE generates a new random number.)	EXE EXE
Ran# 1 (Generates the first random number in sequence 1.)	OPTN F6 (\triangleright) F3 (PROB) F4 (RAND) F1 (Ran#) 1 EXE
(Generates the second random number in sequence 1.)	EXE
Ran# 0 (Initializes the sequence.)	F1 (Ran#) 0 EXE
Ran# 1 (Generates the first random number in sequence 1.)	F1 (Ran#) 1 EXE

RanList# Examples

Example	Operation
RanList# (4) (Generates four random numbers and displays the result on the ListAns screen.)	OPTN F6 (\triangleright) F3 (PROB) F4 (RAND) F5 (List) 4 EXE
RanList# (3, 1) (Generates from the first to the third random numbers of sequence 1 and displays the result on the ListAns screen.)	OPTN F6 (\triangleright) F3 (PROB) F4 (RAND) F5 (List) 3 1 EXE
(Next, generates from the fourth to the sixth random number of sequence 1 and displays the result on the ListAns screen.)	EXE
Ran# 0 (Initializes the sequence.)	F1 (Ran#) 0 EXE
RanList# (3, 1) (Re-generates from the first to the third random numbers of sequence 1 and displays the result on the ListAns screen.)	F5 (List) 3 1 EXE

• Random Integer Generation (RanInt#)

RanInt# generates random integers that fall between two specified integers.

RanInt# (A, B [,n]) $A < B$ $|A|, |B| < 1E10$ $B - A < 1E10$ $1 \leq n \leq 999$

- A is the start value and B is the end value. Omitting a value for *n* returns a generated random number as-is. Specifying a value for *n* returns the specified number of random values in list form.

Example	Operation
RanInt# (1, 5) (Generates one random integer from 1 and 5.)	OPTN F6 (\triangleright) F3 (PROB) F4 (RAND) F2 (Int) 1 \triangleright 5 \triangleright EXE
RanInt# (1, 10, 5) (Generates five random integers from 1 to 10 and displays the result on the ListAns screen.)	OPTN F6 (\triangleright) F3 (PROB) F4 (RAND) F2 (Int) 1 \triangleright 10 \triangleright 5 \triangleright EXE

• Random Number Generation in Accordance with Normal Distribution (RanNorm#)

This function generates a 10-digit random number in accordance with normal distribution based on a specified mean μ and standard deviation σ values.

RanNorm# (σ, μ [,n]) $\sigma > 0$ $1 \leq n \leq 999$

- Omitting a value for *n* returns a generated random number as-is. Specifying a value for *n* returns the specified number of random values in list form.

Example	Operation
RanNorm# (8, 68) (Randomly produces a body length value obtained in accordance with the normal distribution of a group of infants less than one year old with a mean body length of 68cm and standard deviation of 8.)	OPTN F6 (\triangleright) F3 (PROB) F4 (RAND) F3 (Norm) 8 \triangleright 68 \triangleright EXE
RanNorm# (8, 68, 5) (Randomly produces the body lengths of five infants in the above example, and displays them in a list.)	OPTN F6 (\triangleright) F3 (PROB) F4 (RAND) F3 (Norm) 8 \triangleright 68 \triangleright 5 \triangleright EXE

• Random Number Generation in Accordance with Binomial Distribution (RanBin#)

This function generates random integers in accordance with binomial distribution based on values specified for the number of trials n and probability p .

RanBin# ($n, p [,m]$) $1 \leq n \leq 100000$ $1 \leq m \leq 999$ $0 \leq p \leq 1$

- Omitting a value for m returns a generated random number as-is. Specifying a value for m returns the specified number of random values in list form.

Example	Operation
RanBin# (5, 0.5) (Randomly produces the number of heads that can be expected in accordance with binomial distribution for five coin tosses where the probability of heads is 0.5.)	OPTN F6 (\triangleright) F3 (PROB) F4 (RAND) F4 (Bin) 5 \triangleright 0.5 \triangleright EXE
RanBin# (5, 0.5, 3) (Performs the same coin toss sequence described above three times and displays the results in a list.)	OPTN F6 (\triangleright) F3 (PROB) F4 (RAND) F4 (Bin) 5 \triangleright 0.5 \triangleright 3 \triangleright EXE

• Random Extraction of List Data Elements (RanSamp#)

This function randomly extracts elements from list data and returns the results in list format.

RanSamp# (List X, $n [,m]$)

List X ... Any list data (List 1 to List 26, Ans, {list format data}, sub-name)

n ... Number of tries (When $m = 1$, the number of elements is $1 \leq n \leq$ List X. When $m = 0$, $1 \leq n \leq 999$.)

m ... $m = 1$ or 0 (When $m = 1$, each element is extracted only once. When $m = 0$, each element can be extracted multiple times.)

- $m = 0$ is used when the m setting is omitted.

Example	Operation
List 1 = {1, 2, 3, 4, 5, 6, 7, 8, 9, 10} RanSamp# (List 1, 3, 1) (Randomly extracts three elements from List 1 and displays the result on the ListAns screen.)	SHIFT X ({}) 1 \triangleright 2 \triangleright 3 \triangleright 4 \triangleright 5 \triangleright 6 \triangleright 7 \triangleright 8 \triangleright 9 \triangleright 10 SHIFT \div ({}) \rightarrow SHIFT 1 (List) 1 EXE OPTN F6 (\triangleright) F3 (PROB) F4 (RAND) F6 (Samp) SHIFT 1 (List) 1 \triangleright 3 \triangleright 1 \triangleright EXE
List 2 = {1, 3, 6, 7} RanSamp# (List 2, 10) (Randomly extracts 10 elements from List 2 and displays the result on the ListAns screen. Elements are extracted repeatedly.)	SHIFT X ({}) 1 \triangleright 3 \triangleright 6 \triangleright 7 SHIFT \div ({}) \rightarrow SHIFT 1 (List) 2 EXE OPTN F6 (\triangleright) F3 (PROB) F4 (RAND) F6 (Samp) SHIFT 1 (List) 2 \triangleright 10 \triangleright EXE

Coordinate Conversion

• Rectangular Coordinates

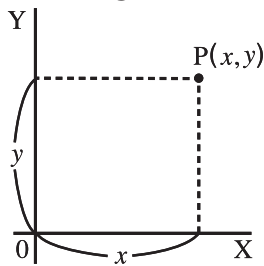

• Polar Coordinates

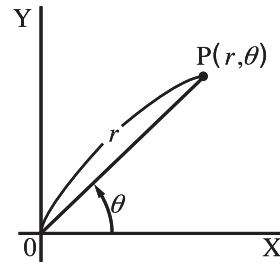

Pol
←
Rec

- With polar coordinates, θ can be calculated and displayed within a range of $-180^\circ < \theta \leq 180^\circ$ (radians and grads have same range).
- Be sure to specify Comp for Mode in the Setup screen.

Example	Operation
Calculate r and θ° when $x = 14$ and $y = 20.7$	SHIFT MENU (SET UP) ▼ ▼ ▼ ▼ ▼ ▼ F1 (Deg) EXIT OPTN F6 (\triangleright) F5 (ANGLE) F6 (\triangleright) F1 (Pol() 14 ▢ 20.7 ▢ EXE
1 $\left[\begin{array}{l} 24.989 \\ 55.928 \end{array} \right] \rightarrow 24.98979792 (r)$ 2 $\rightarrow 55.92839019 (\theta)$	
Calculate x and y when $r = 25$ and $\theta = 56^\circ$	F2 (Rec()) 25 ▢ 56 ▢ EXE
1 $\left[\begin{array}{l} 13.979 \\ 20.725 \end{array} \right] \rightarrow 13.97982259 (x)$ 2 $\rightarrow 20.72593931 (y)$	

Permutation and Combination

• Permutation

$${}_n P_r = \frac{n!}{(n-r)!}$$

• Combination

$${}_n C_r = \frac{n!}{r!(n-r)!}$$

- Be sure to specify Comp for Mode in the Setup screen.

Example 1 To calculate the possible number of different arrangements using 4 items selected from among 10 items

Formula	Operation
${}_{10}P_4 = 5040$	10 OPTN F6 (\triangleright) F3 (PROB) F2 (${}_n P_r$) 4 EXE

Example 2 To calculate the possible number of different combinations of 4 items that can be selected from among 10 items

Formula	Operation
${}_{10}C_4 = 210$	10 OPTN F6 (\triangleright) F3 (PROB) F3 (${}_n C_r$) 4 EXE

■ Greatest Common Divisor (GCD), Least Common Multiple (LCM)

Example	Operation
To determine the greatest common divisor of 28 and 35 (GCD (28, 35) = 7)	OPTN F6 (\triangleright) F4 (NUMERIC) F6 (\triangleright) F2 (GCD) 28 35 EXE
To determine the least common multiple of 9 and 15 (LCM (9, 15) = 45)	OPTN F6 (\triangleright) F4 (NUMERIC) F6 (\triangleright) F3 (LCM) 9 15 EXE

■ Division Remainder (MOD), Remainder of Exponential Division (MOD_Exp)

Example	Operation
To determine the remainder when 137 is divided by 7 (MOD (137, 7) = 4)	OPTN F6 (\triangleright) F4 (NUMERIC) F6 (\triangleright) F4 (MOD) 137 7 EXE
To determine the remainder when 5^3 is divided by 3 (MOD_Exp (5, 3, 3) = 2)	OPTN F6 (\triangleright) F4 (NUMERIC) F6 (\triangleright) F5 (MOD_Exp) 5 3 3 EXE

Fractions

- In the Math input/output mode, the fraction input method is different from that described below. For fraction input operations in the Math input/output mode, see page 1-13.
- Be sure to specify Comp for Mode in the Setup screen.

Example	Operation
$\frac{2}{5} + 3\frac{1}{4} = \frac{73}{20}$ <p style="text-align: center;">= 3.65 (Conversion to decimal)*¹</p>	$\boxed{\frac{a}{b}} \boxed{2} \boxed{\nabla} \boxed{5} \boxed{\blacktriangleright} \boxed{+} \boxed{\text{SHIFT}} \boxed{\frac{a}{b}} \boxed{(\frac{\square}{\square})} \boxed{3} \boxed{\blacktriangleright} \boxed{1} \boxed{\nabla} \boxed{4} \boxed{\text{EXE}}$ <Linear input/output mode> $\boxed{2} \boxed{\frac{a}{b}} \boxed{5} \boxed{+} \boxed{3} \boxed{\frac{a}{b}} \boxed{1} \boxed{\frac{a}{b}} \boxed{4} \boxed{\text{EXE}}$ $\boxed{\text{F-D}}$
$\frac{1}{2578} + \frac{1}{4572} = 6.066202547 \times 10^{-4} \text{ }^{*2}$	$\boxed{\frac{a}{b}} \boxed{1} \boxed{\nabla} \boxed{2578} \boxed{\blacktriangleright} \boxed{+} \boxed{\frac{a}{b}} \boxed{1} \boxed{\nabla} \boxed{4572} \boxed{\text{EXE}}$ <Linear input/output mode> $\boxed{1} \boxed{\frac{a}{b}} \boxed{2578} \boxed{+} \boxed{1} \boxed{\frac{a}{b}} \boxed{4572} \boxed{\text{EXE}}$
$\frac{1}{2} \times 0.5 = 0.25 \text{ }^{*3}$	$\boxed{\frac{a}{b}} \boxed{1} \boxed{\nabla} \boxed{2} \boxed{\blacktriangleright} \boxed{\times} \boxed{.5} \boxed{\text{EXE}}$ <Linear input/output mode> $\boxed{1} \boxed{\frac{a}{b}} \boxed{2} \boxed{\times} \boxed{.5} \boxed{\text{EXE}}$

*¹ Fractions can be converted to decimal values and vice versa.

*² When the total number of characters, including integer, numerator, denominator and delimiter marks exceeds 10, the fraction is automatically displayed in decimal format.

*³ Calculations containing both fractions and decimals are calculated in decimal format.

- Pressing the $\boxed{\text{SHIFT}} \boxed{\text{F-D}}$ ($a\frac{b}{c} \leftrightarrow \frac{d}{c}$) key toggles the display fraction between mixed fraction and improper fraction format.

Engineering Notation Calculations

Input engineering symbols using the engineering notation menu.

- Be sure to specify Comp for Mode in the Setup screen.

Example	Operation
$999\text{k (kilo)} + 25\text{k (kilo)}$ $= 1.024\text{M (mega)}$	$\boxed{\text{SHIFT}} \boxed{\text{MENU}} \boxed{(\text{SET UP})} \boxed{\blacktriangle} \boxed{\blacktriangle} \boxed{\text{F4}} \boxed{(\text{Eng})} \boxed{\text{EXIT}} \boxed{999} \boxed{\text{OPTN}} \boxed{\text{F6}} \boxed{(\triangleright)} \boxed{\text{F6}} \boxed{(\triangleright)}$ $\boxed{\text{F1}} \boxed{(\text{ENG-SYM})} \boxed{\text{F6}} \boxed{(\triangleright)} \boxed{\text{F1}} \boxed{(\text{k})} \boxed{+} \boxed{25} \boxed{\text{F1}} \boxed{(\text{k})} \boxed{\text{EXE}}$
$9 \div 10 = 0.9 = 900\text{m (milli)}$ $= 0.9$ $= 0.0009\text{k (kilo)}$ $= 0.9$ $= 900\text{m}$	$\boxed{9} \boxed{\div} \boxed{10} \boxed{\text{EXE}}$ $\boxed{\text{OPTN}} \boxed{\text{F6}} \boxed{(\triangleright)} \boxed{\text{F6}} \boxed{(\triangleright)} \boxed{\text{F1}} \boxed{(\text{ENG-SYM})} \boxed{\text{F6}} \boxed{(\triangleright)} \boxed{\text{F6}} \boxed{(\triangleright)} \boxed{\text{F3}} \boxed{(\overleftarrow{\text{ENG}})} \text{ }^{*1}$ $\boxed{\text{F3}} \boxed{(\overleftarrow{\text{ENG}})} \text{ }^{*1}$ $\boxed{\text{F2}} \boxed{(\text{ENG})} \text{ }^{*2}$ $\boxed{\text{F2}} \boxed{(\text{ENG})} \text{ }^{*2}$

*¹ Converts the displayed value to the next higher engineering unit, by shifting the decimal point three places to the right.

*² Converts the displayed value to the next lower engineering unit, by shifting the decimal point three places to the left.

■ Logical Operators (AND, OR, NOT, XOR)

[OPTN]-[LOGIC]

The logical operator menu provides a selection of logical operators.

- {And}/{Or}/{Not}/{Xor} ... {logical AND}/{logical OR}/{logical NOT}/{logical XOR}
- Be sure to specify Comp for Mode in the Setup screen.

Example **What is the logical AND of A and B when A = 3 and B = 2?**
A AND B = 1

Operation	Display
3 \rightarrow [ALPHA] [X,θ,T] (A) [EXE] 2 \rightarrow [ALPHA] [log] (B) [EXE] [ALPHA] [X,θ,T] (A) [OPTN] [F6] (▷) [F6] (▷) [F4] (LOGIC) [F1] (And) [ALPHA] [log] (B) [EXE]	1

● About Logical Operations

- A logical operation always produces either 0 or 1 as its result.
- The following table shows all of possible results that can be produced by AND, OR and XOR operations.

Value or Expression A	Value or Expression B	A AND B	A OR B	A XOR B
A ≠ 0	B ≠ 0	1	1	0
A ≠ 0	B = 0	0	1	1
A = 0	B ≠ 0	0	1	1
A = 0	B = 0	0	0	0

- The following table shows the results produced by the NOT operation.

Value or Expression A	NOT A
A ≠ 0	0
A = 0	1

5. Numerical Calculations

The following explains the numerical calculation operations included in the function menu displayed when **[OPTN]** **[F4]** (CALC) is pressed. The following calculations can be performed.

- **[Int÷]**/**[Rmdr]**/**[Simp]** ... {quotient}/ {remainder}/ {simplification}
- **[Solve]**/**[d/dx]**/**[d²/dx²]**/**[dx]**/**[SolveN]** ... {equality solution}/ {first derivative}/ {second derivative}/ {integration}/ {f(x) function solution}
- **[FMin]**/**[FMax]**/**[Σ]**/**[log_ab]** ... {minimum value}/ {maximum value}/ {summation}/ {logarithm log_ab}

■ Quotient of Integer ÷ Integer

[OPTN]-**[CALC]**-**[Int÷]**

The “Int÷” function can be used to determine the quotient when one integer is divided by another integer.

Example **To calculate the quotient of 107 ÷ 7**

[AC] **[1]** **[0]** **[7]** **[OPTN]** **[F4]** (CALC) **[F6]** (▷)
[F6] (▷) **[F1]** (Int÷) **[7]**
[EXE]

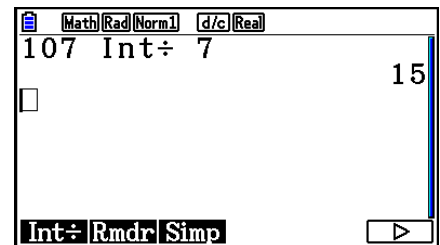

■ Remainder of Integer ÷ Integer

[OPTN]-**[CALC]**-**[Rmdr]**

The “Rmdr” function can be used to determine the remainder when one integer is divided by another integer.

Example **To calculate the remainder of 107 ÷ 7**

[AC] **[1]** **[0]** **[7]** **[OPTN]** **[F4]** (CALC) **[F6]** (▷)
[F6] (▷) **[F2]** (Rmdr) **[7]**
[EXE]

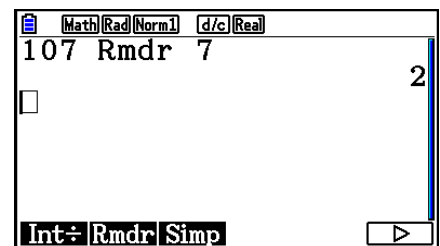

■ Simplification

[OPTN]-[CALC]-[Simp]

The “►Simp” function can be used to simplify fractions manually. The following operations can be used to perform simplification when an unsimplified calculation result is on the display.

- **{Simp} [EXE]** ... This function automatically simplifies the displayed calculation result using the smallest prime number available. The prime number used and the simplified result are shown on the display.
- **{Simp} n [EXE]** ... This function performs simplification according to the specified divisor n .

Under initial default settings, this calculator automatically simplifies fraction calculation results before displaying them. Before performing the following examples, use the Setup screen to change the “Simplify” setting from “Auto” to “Manual” (page 1-35).

- When “ $a+bi$ ” or “ $r\angle\theta$ ” is specified for the Setup screen “Complex Mode” setting, fraction calculation results always are simplified before being displayed, even if the “Simplify” setting is “Manual”.
- If you want to simplify fractions manually (Simplify: Manual), make sure that the “Real” is selected for the “Complex Mode” setting.

Example 1 To simplify $\frac{15}{60}$ $\left(\frac{15}{60} = \frac{5}{20} = \frac{1}{4}\right)$

[AC] [α₂] [1] [5] [▼] [6] [0] [EXE]

[OPTN] [F4] (CALC) [F6] (▷) [F6] (▷) [F3] (Simp) [EXE]

[F3] (Simp) [EXE]

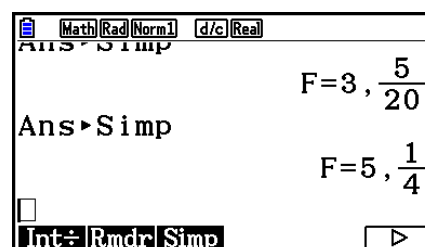
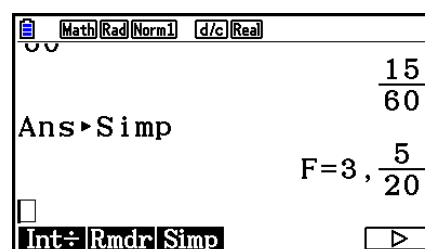

The “F=” value is the divisor.

Example 2 To simplify $\frac{27}{63}$ specifying a divisor of 9 $\left(\frac{27}{63} = \frac{3}{7}\right)$

AC $\frac{a}{b}$ 2 7 ∇ 6 3 EXE
 OPTN F4 (CALC) F6 (\triangleright) F6 (\triangleright) F3 (Simp) 9
 EXE

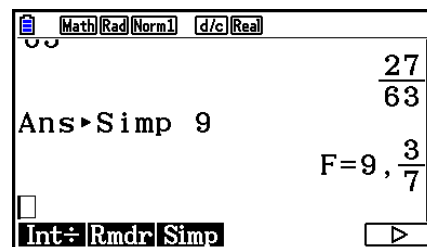

- An error occurs if simplification cannot be performed using the specified divisor.
- Executing \blacktriangleright Simp while a value that cannot be simplified is displayed will return the original value, without displaying “F=”.

■ Solve Calculations

[OPTN]-[CALC]-[Solve]

The following is the syntax for using the Solve function in a program.

Solve($f(x)$, n , a , b) (a : lower limit, b : upper limit, n : initial estimated value)

There are two different input methods that can be used for Solve calculations: direct assignment and variable table input.

With the direct assignment method, you assign values directly to variables. This type of input is identical to that used with the Solve command used in the **Program** mode.

Variable table input is used with the Solve function in the **Equation** mode. This input method is recommended for most normal Solve function input.

An error (Time Out) occurs when there is no convergence of the solution.

For information about Solve calculations, see page 4-4.

- You cannot use a second derivative, Σ , maximum/minimum value or Solve calculation expression inside of any of the above functions.
- Pressing $\overline{\text{AC}}$ during calculation of Solve (while the cursor is not shown on the display) interrupts the calculation.

■ Solving an $f(x)$ Function

[OPTN]-[CALC]-[SolveN]

You can use SolveN to solve an $f(x)$ function using numerical analysis. The following is the input syntax.

SolveN (left side [=right side] [,variable] [, lower limit, upper limit])

- The right side, variable, lower limit and upper limit all can be omitted.
- “left side[=right side]” is the expression to be solved. Supported variables are A through Z, r , and θ . When the right side is omitted, solution is perform using right side = 0.
- The variable specifies the variable within the expression to be solved for (A through Z, r , θ). Omitting a variable specification cause X to be used as the variable.

- The lower limit and upper limit specify the range of the solution. You can input a value or an expression as the range.
- The following functions cannot be used within any of the arguments.
Solve(, d^2/dx^2 (, FMin(, FMax(, Σ (

Up to 10 calculation results can be displayed simultaneously in ListAns format.

- The message “No Solution” is displayed if no solution exists.
- The message “More solutions may exist.” is displayed when there may be solutions other than those displayed by SolveN.

Example To solve $x^2 - 5x - 6 = 0$

[OPTN] [F4] (CALC) [F5] (SolveN)
[X,θ,T] [x²] [=] [5] [X,θ,T] [=] [6] [)] [EXE]

[EXIT]

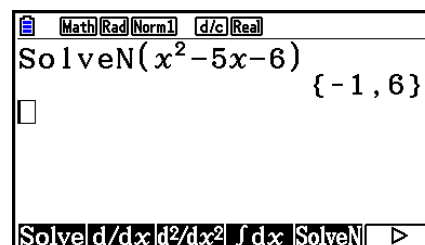
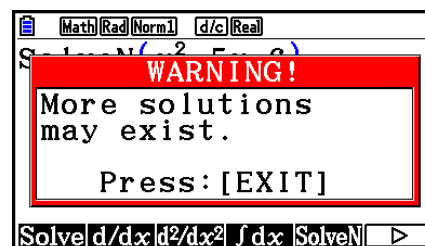

■ First Derivative Calculations

[OPTN]-[CALC]-[d/dx]

To perform first derivative calculations, first display the function analysis menu, and then input the values using the syntax below.

<Math input/output mode>

[OPTN] [F4] (CALC) [F2] (d/dx) $f(x)$ [▶] a

or

[F4] (MATH) [F4] (d/dx) $f(x)$ [▶] a

<Linear input/output mode>

[OPTN] [F4] (CALC) [F2] (d/dx) $f(x)$ [◀] a [)]

a is the point for which you want to determine the first derivative.

$$d/dx (f(x), a) \Rightarrow \frac{d}{dx} f(a)$$

The derivative is defined as:

$$f'(a) = \lim_{\Delta x \rightarrow 0} \frac{f(a + \Delta x) - f(a)}{\Delta x}$$

In this definition, *infinitesimal* is replaced by a *sufficiently small* Δx , with the value in the neighborhood of $f'(a)$ calculated as:

$$f'(a) \doteq \frac{f(a + \Delta x) - f(a)}{\Delta x}$$

Example To determine the derivative at $x = 3$ for the function $y = x^3 + 4x^2 + x - 6$

Input the function $f(x)$.

AC **OPTN** **F4** (CALC) **F2** (d/dx) **X,θ,T** **^** **3** **▶** **+** **4** **X,θ,T** **x²** **+** **X,θ,T** **-** **6** **▶**

Input point $x = a$ for which you want to determine the derivative.

3 **EXE**

The calculator display shows the derivative calculation: $\frac{d}{dx}(x^3 + 4x^2 + x - 6)|_{x=3}$ with the result 52. The mode indicators at the top are Math, Rad, Norm, and d/c/Real.

Using First Derivative Calculation in a Graph Function

- You can omit input of the value a in the syntax on page 2-28 by using the following format for the first derivative graph: $Y2 = d/dx (Y1)$. In this case, the value of the X variable is used instead of the value a .

First Derivative Calculation Precautions

- In the function $f(x)$, only X can be used as a variable in expressions. Other variables (A through Z excluding X, r , θ) are treated as constants, and the value currently assigned to that variable is applied during the calculation.
- Pressing **AC** during calculation of a first derivative (while the cursor is not shown on the display) interrupts the calculation.
- Inaccurate results and errors can be caused by the following:
 - discontinuous points in x values
 - extreme changes in x values
 - inclusion of the local maximum point and local minimum point in x values
 - inclusion of the inflection point in x values
 - inclusion of undifferentiable points in x values
 - first derivative calculation results approaching zero
- Always use radians (Rad mode) as the angle unit when performing trigonometric first derivatives.
- You cannot use a first derivative, second derivative, integration, Σ , maximum/minimum value, Solve or RndFix calculation expression inside a first derivative calculation term.

■ Second Derivative Calculations

[OPTN]-[CALC]-[d²/dx²]

After displaying the function analysis menu, you can input second derivatives using the following syntax.

<Math input/output mode>

[OPTN] [F4] (CALC) [F3] (d²/dx²) f(x) ► a

or

[F4] (MATH) [F5] (d²/dx²) f(x) ► a

<Linear input/output mode>

[OPTN] [F4] (CALC) [F3] (d²/dx²) f(x) ◀ a □

a is the point for which you want to determine the second derivative.

$$\frac{d^2}{dx^2}(f(x), a) \Rightarrow \frac{d^2}{dx^2}f(a)$$

Second derivative calculations produce an approximate derivative value using the following second derivative formula, which is based on Newton's polynomial interpretation.

$$f''(a) = \frac{2f(a+3h) - 27f(a+2h) + 270f(a+h) - 490f(a) + 270f(a-h) - 27f(a-2h) + 2f(a-3h)}{180h^2}$$

In this expression, values for "sufficiently small increments of h " are used to obtain a value that approximates $f''(a)$.

Example **To determine the second derivative at $x = 3$ for the function**
 $y = x^3 + 4x^2 + x - 6$

Input the function $f(x)$.

[AC] [OPTN] [F4] (CALC) [F3] (d²/dx²) [X,θ,T] [^] [3] ► [÷] [4] [X,θ,T] [x²] [÷] [X,θ,T] [-] [6] ►

Input 3 as point a , which is the derivative point.

[3] [EXE]

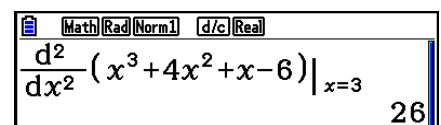

Math [Rad] [Norm] [d/c] [Real]
 $\frac{d^2}{dx^2}(x^3+4x^2+x-6)|_{x=3}$
26

Using Second Derivative Calculation in a Graph Function

You can omit input of the value a in the syntax above by using the following format for the second derivative graph: Y2 = d²/dx²(Y1). In this case, the value of the X variable is used instead of the value a .

Second Derivative Calculation Precautions

The precautions that apply for first derivative also apply when using a second derivative calculation (see page 2-29).

Integration Calculations

[OPTN]-[CALC]-[$\int dx$]

To perform integration calculations, first display the function analysis menu and then input the values using the syntax below.

<Math input/output mode>

[OPTN] [F4] (CALC) [F4] ($\int dx$) $f(x)$ [▶] a [▲] b

or

[F4] (MATH) [F6] (\int) [F1] ($\int dx$) $f(x)$ [▶] a [▲] b

<Linear input/output mode>

[OPTN] [F4] (CALC) [F4] ($\int dx$) $f(x)$ [▶] a [▶] b [▶] tol [◻]

(a : lower limit, b : upper limit, tol : tolerance)

$$\int (f(x), a, b, tol) \Rightarrow \int_a^b f(x) dx$$

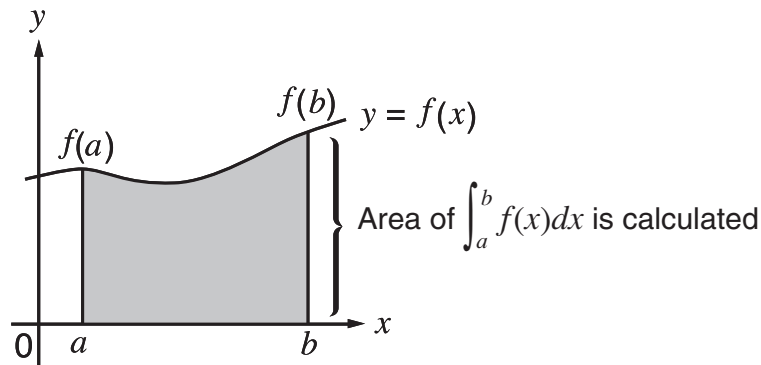

As shown in the illustration above, integration calculations are performed by calculating integral values from a through b for the function $y = f(x)$ where $a \leq x \leq b$, and $f(x) \geq 0$. This in effect calculates the surface area of the shaded area in the illustration.

Example 1 To perform the integration calculation for the function shown below, with a tolerance of “ tol ” = $1E-4$

$$\int_1^5 (2x^2 + 3x + 4) dx$$

• Math input/output mode

[OPTN] [F4] (CALC) [F4] ($\int dx$) [2] [x, θ, T] [x^2] [+]
[3] [x, θ, T] [+] [4] [▶] [1] [▲] [5] [EXE]

• Linear input/output mode

Input the function $f(x)$.

[AC] [OPTN] [F4] (CALC) [F4] ($\int dx$) [2] [x, θ, T] [x^2] [+] [3] [x, θ, T] [+] [4] [▶]

Input the lower limit, upper limit, and the tolerance value.

[1] [▶] [5] [▶] [1] [EXP] [(-)] [4] [▶] [EXE]

Example 2 When the angle unit setting is degrees, trigonometric function integration calculation is performed using radians (Angle unit = Deg)

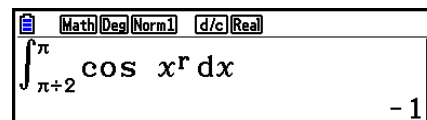

Examples Calculation Result Display

Note the following points to ensure correct integration values.

- (1) When cyclical functions for integration values become positive or negative for different divisions, perform the calculation for single cycles, or divide between negative and positive, and then add the results together.

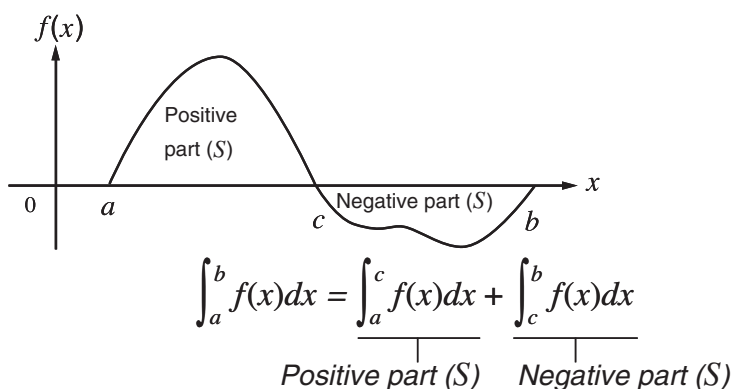

- (2) When minute fluctuations in integration divisions produce large fluctuations in integration values, calculate the integration divisions separately (divide the large fluctuation areas into smaller divisions), and then add the results together.

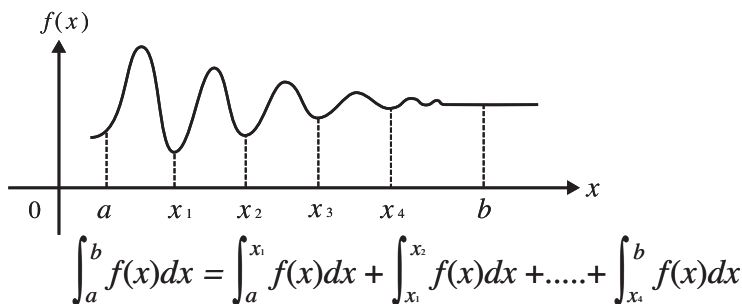

- Pressing **AC** during calculation of an integral (while the cursor is not shown on the display) interrupts the calculation.
- Always use radians (Rad mode) as the angle unit when performing trigonometric integrations.
- An error (Time Out) occurs whenever no solution that satisfies the tolerance value can be obtained.

Integration Calculation Precautions

- In the function $f(x)$, only X can be used as a variable in expressions. Other variables (A through Z excluding X, r, θ) are treated as constants, and the value currently assigned to that variable is applied during the calculation.
- Input of “tol” and closing parenthesis can be omitted. If you omit “tol,” the calculator automatically uses a default value of $1E-5$.
- Integration calculations can take a long time to complete.
- You cannot use a first derivative, second derivative, integration, Σ , maximum/minimum value, Solve or RndFix calculation expression inside of an integration calculation term.
- In the Math input/output mode, the tolerance value is fixed at $1E-5$ and cannot be changed.

■ Σ Calculations

[OPTN]-[CALC]-[Σ]

To perform Σ calculations, first display the function analysis menu, and then input the values using the syntax below.

<Math input/output mode>

[OPTN] [F4] (CALC) [F6] (\triangleright) [F3] (Σ () a_k \triangleright k \triangleright α \triangleright β)

or

[F4] (MATH) [F6] (\triangleright) [F2] (Σ () a_k \triangleright k \triangleright α \triangleright β)

<Linear input/output mode>

[OPTN] [F4] (CALC) [F6] (\triangleright) [F3] (Σ () a_k \triangleright k \triangleright α \triangleright β \triangleright n \triangleright)

$$\Sigma(a_k, k, \alpha, \beta, n) = \sum_{k=\alpha}^{\beta} a_k = a_{\alpha} + a_{\alpha+1} + \dots + a_{\beta}$$

(n : distance between partitions)

Example **To calculate the following:**

$$\sum_{k=2}^6 (k^2 - 3k + 5)$$

Use $n = 1$ as the distance between partitions.

[AC] [OPTN] [F4] (CALC) [F6] (\triangleright) [F3] (Σ () [ALPHA] \triangleright (K) \triangleright x^2 \triangleright $=$ \triangleright 3 [ALPHA] \triangleright (K) \triangleright $+$ \triangleright 5 \triangleright [ALPHA] \triangleright (K) \triangleright \triangleright 2 \triangleright \triangleright 6 [EXE]

Σ Calculation Precautions

- The value of the specified variable changes during a Σ calculation. Be sure to keep separate written records of the specified variable values you might need later before you perform the calculation.
- You can use only one variable in the function for input sequence a_k .

Press **OPTN** **F3** (COMPLEX) to display the complex calculation number menu, which contains the following items.

- **i** ... {imaginary unit i input}
- **{Abs}/****{Arg}** ... obtains {absolute value}/argument
- **{Conjg}** ... {obtains conjugate}
- **{ReP}/****{ImP}** ... {real}/imaginary part extraction
- **$\blacktriangleright r\angle\theta$** / **$\blacktriangleright a+bi$** ... converts the result to {polar}/rectangular form
- You can also use **SHIFT** **0** (i) in place of **OPTN** **F3** (COMPLEX) **F1** (i).
- Solutions obtained by the Real, $a+bi$ and $r\angle\theta$ modes are different for power root ($x\sqrt{\quad}$) calculations when $x < 0$ and $y = m/n$ when n is an odd number.

Example: $3^x\sqrt{\quad} (-8) = -2$ (Real)
 $= 1 + 1.732050808i$ ($a+bi$)
 $= 2\angle 60$ ($r\angle\theta$, Deg mode)

- To input the “ \angle ” operator into the polar coordinate expression ($r\angle\theta$), press **SHIFT** **X,θ,T** (\angle).

Arithmetic Operations

[OPTN]-[COMPLEX]-[i]

Arithmetic operations are the same as those you use for manual calculations. You can even use parentheses and memory.

Example $(1 + 2i) + (2 + 3i)$

AC **OPTN** **F3** (COMPLEX)
(**1** **+** **)** **F1** (i) **(**
+ **(** **2** **+** **)** **F1** (i) **)** **EXE**

Math **Rad** **Norm1** **d/c** **Real**
 $(1+2i) + (2+3i)$ $3+5i$

Reciprocals, Square Roots, and Squares

Example $\sqrt{3+i}$

AC **OPTN** **F3** (COMPLEX)
SHIFT **x²** ($\sqrt{\quad}$) **(** **3** **+** **)** **F1** (i) **)** **EXE**

Math **Rad** **Norm1** **d/c** **Real**
 $\sqrt{3+i}$
 1.755317302
 $+0.2848487846i$

Complex Number Format Using Polar Form

Example $2\angle 30 \times 3\angle 45 = 6\angle 75$

[SHIFT] [MENU] (SET UP) [▼] [▼] [▼] [▼] [▼] [▼]
 [F1] (Deg) [▼] [F3] ($r\angle\theta$) [EXIT]
 [AC] [2] [SHIFT] [X,θ,T] (∠) [3] [0] [X] [3]
 [SHIFT] [X,θ,T] (∠) [4] [5] [EXE]

Math	Deg	Norm1	d/c	r∠θ
2∠30×3∠45				6∠75

Absolute Value and Argument

[OPTN]-[COMPLEX]-[Abs]/[Arg]

The unit regards a complex number in the form $a + bi$ as a coordinate on a Gaussian plane, and calculates absolute value $|Z|$ and argument (arg).

Example To calculate absolute value (r) and argument (θ) for the complex number $3 + 4i$, with the angle unit set for degrees

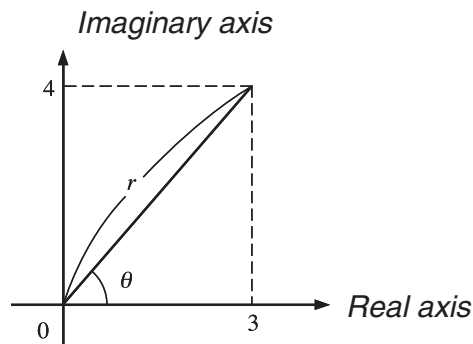

[AC] [OPTN] [F3] (COMPLEX) [F2] (Abs)
 [3] [+] [4] [F1] (i) [EXE]
 (Calculation of absolute value)

Math	Deg	Norm1	d/c	a+bi
3+4i				5

[AC] [OPTN] [F3] (COMPLEX) [F3] (Arg)
 [(] [3] [+] [4] [F1] (i) [)] [EXE]
 (Calculation of argument)

Math	Deg	Norm1	d/c	a+bi
Arg (3+4i)				53.13010235

- The result of the argument calculation differs in accordance with the current angle unit setting (degrees, radians, grads).

■ Conjugate Complex Numbers

[OPTN]-[COMPLEX]-[Conjg]

A complex number of the form $a + bi$ becomes a conjugate complex number of the form $a - bi$.

Example To calculate the conjugate complex number for the complex number $2 + 4i$

AC OPTN F3 (COMPLEX) F4 (Conjg)
 () 2 + 4 F1 (i)) EXE

Math Deg Norm1 d/c |a+bi|
 Conjg (2+4i) 2-4i

■ Extraction of Real and Imaginary Parts

[OPTN]-[COMPLEX]-[ReP]/[ImP]

Use the following procedure to extract the real part a and the imaginary part b from a complex number of the form $a + bi$.

Example To extract the real and imaginary parts of the complex number $2 + 5i$

AC OPTN F3 (COMPLEX) F6 (▷) F1 (ReP)
 () 2 + 5 F6 (▷) F1 (i)) EXE
 (Real part extraction)

Math Deg Norm1 d/c |a+bi|
 ReP (2+5i) 2

AC OPTN F3 (COMPLEX) F6 (▷) F2 (ImP)
 () 2 + 5 F6 (▷) F1 (i)) EXE
 (Imaginary part extraction)

Math Deg Norm1 d/c |a+bi|
 ImP (2+5i) 5

■ Polar and Rectangular Form Transformation

[OPTN]-[COMPLEX]-[▷r∠θ]/[▷a+bi]

Use the following procedure to transform a complex number displayed in rectangular form to polar form, and vice versa.

Example To transform the rectangular form of complex number $1 + \sqrt{3}i$ to its polar form

SHIFT MENU (SET UP) ▼ ▼ ▼ ▼ ▼ ▼
 F1 (Deg) ▼ F2 (a+bi) EXIT
 AC 1 + () SHIFT x² (√) 3 ()
 OPTN F3 (COMPLEX) F1 (i) F6 (▷)
 F3 (▷r∠θ) EXE

Math Deg Norm1 d/c |a+bi|
 1+(√3)i ▷r∠θ 2∠60

AC 2 SHIFT X.θI (∠) 6 0
 OPTN F3 (COMPLEX) F6 (▷) F4 (▷a+bi) EXE

Math Deg Norm1 d/c |a+bi|
 2∠60 ▷a+bi 1+√3i

7. Binary, Octal, Decimal, and Hexadecimal Calculations with Integers

You can use the **Run-Matrix** mode and binary, octal, decimal, and hexadecimal settings to perform calculations that involve binary, octal, decimal and hexadecimal values. You can also convert between number systems and perform bitwise operations.

- You cannot use scientific functions in binary, octal, decimal, and hexadecimal calculations.
- You can use only integers in binary, octal, decimal, and hexadecimal calculations, which means that fractional values are not allowed. If you input a value that includes a decimal part, the calculator automatically cuts off the decimal part.
- If you attempt to enter a value that is invalid for the number system (binary, octal, decimal, hexadecimal) you are using, the calculator displays an error message. The following shows the numerals that can be used in each number system.

Binary: 0, 1

Octal: 0, 1, 2, 3, 4, 5, 6, 7

Decimal: 0, 1, 2, 3, 4, 5, 6, 7, 8, 9

Hexadecimal: 0, 1, 2, 3, 4, 5, 6, 7, 8, 9, A, B, C, D, E, F

- Negative binary, octal, and hexadecimal values are produced using the two's complement of the original value.
- The following are the display capacities for each of the number systems.

Number System	Binary	Octal	Decimal	Hexadecimal
Display Capacity	16 digits	11 digits	10 digits	8 digits

- The alphabetic characters used in the hexadecimal number appear differently on the display to distinguish them from text characters.

Normal Text	A	B	C	D	E	F
Hexadecimal Values	A	B	C	D	E	F
Keys						

- The following are the calculation ranges for each of the number systems.

Binary Values

Positive: $0 \leq x \leq 1111111111111111$

Negative: $1000000000000000 \leq x \leq 1111111111111111$

Octal Values

Positive: $0 \leq x \leq 177777777777$

Negative: $20000000000 \leq x \leq 377777777777$

Decimal Values

Positive: $0 \leq x \leq 2147483647$

Negative: $-2147483648 \leq x \leq -1$

Hexadecimal Values

Positive: $0 \leq x \leq 7FFFFFFF$

Negative: $80000000 \leq x \leq FFFFFFFF$

• Negative Values

Example To determine the negative of 110010_2

SHIFT **MENU** (SET UP)

Move the highlighting to “Mode”, and then press **F4** (Bin) **EXIT**.

AC **F2** (LOGIC) **F1** (Neg)

1 **1** **0** **0** **1** **0** **EXE**

Bin
Neg 110010 1111111111001110

- Negative binary, octal, and hexadecimal values are produced by taking the binary two’s complement and then returning the result to the original number base. With the decimal number base, negative values are displayed with a minus sign.

• Bitwise Operations

Example To input and execute “ 120_{16} and AD_{16} ”

SHIFT **MENU** (SET UP)

Move the highlighting to “Mode”, and then press **F3** (Hex) **EXIT**.

AC **1** **2** **0** **F2** (LOGIC)

F3 (and) **A** **D** **EXE**

Hex
120andAD 00000020

■ Number System Transformation

Press **F3** (DISPLAY) to display a menu of number system transformation functions.

- {►Dec}/{►Hex}/{►Bin}/{►Oct} ... transformation of displayed value to its {decimal}/{hexadecimal}/{binary}/{octal} equivalent

• To convert a displayed value from one number system to another

Example To convert 22_{10} (default number system) to its binary or octal value

AC **SHIFT** **MENU** (SET UP)

Move the highlighting to “Mode”, and then press **F2** (Dec) **EXIT**.

F1 (d~o) **F1** (d) **2** **2** **EXE**

Dec
d22 22

EXIT **F3** (DISPLAY) **F3** (►Bin) **EXE**

Bin
Ans►Bin 000000000010110

F4 (►Oct) **EXE**

Oct
Ans►Oct 0000000026

8. Matrix Calculations

From the Main Menu, enter the **Run-Matrix** mode, and press **F3** (▶MAT/VCT) to perform Matrix calculations.

26 matrix memories (Mat A through Mat Z) plus a Matrix Answer Memory (MatAns), make it possible to perform the following matrix operations.

- Addition, subtraction, multiplication
- Scalar multiplication calculations
- Determinant calculations
- Matrix transposition
- Matrix inversion
- Matrix squaring
- Raising a matrix to a specific power
- Absolute value, integer part extraction, fractional part extraction, maximum integer calculations
- Inputting complex numbers in matrix elements and using complex number related functions
- Matrix modification using matrix commands

The maximum number of rows that can be specified for a matrix is 999, and the maximum number of columns is 999.

Important!

- You can input either an upper-case X (**ALPHA** **+** (X)) or lower-case x (**X,θ,T**) for matrix memory “Mat X”. Both “Mat X” and “Mat x” refer to the same memory area.

About Matrix Answer Memory (MatAns)

The calculator automatically stores matrix calculation results in Matrix Answer Memory. Note the following points about Matrix Answer Memory.

- Whenever you perform a matrix calculation, the current Matrix Answer Memory contents are replaced by the new result. The previous contents are deleted and cannot be recovered.
- Inputting values into a matrix does not affect Matrix Answer Memory contents.
- When a matrix calculation result is m (rows) \times 1 (column) or 1 (row) \times n (columns), the calculation result is also stored in Vector Answer Memory (VctAns).

■ Inputting and Editing Matrices

Pressing **F3** (▶MAT/VCT) displays the Matrix Editor screen. Use the Matrix Editor to input and edit matrices.

$m \times n$... m (row) \times n (column) matrix
None... no matrix preset

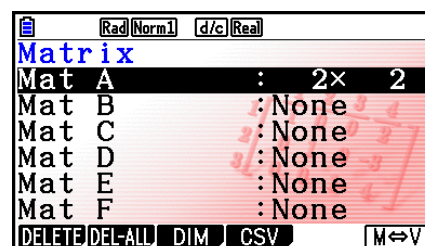

- {DELETE}/{DEL-ALL} ... deletes {a specific matrix}/{all matrices}
- {DIM} ... specifies the matrix dimensions (number of cells)
- {CSV} ... stores a matrix as a CSV file and imports the contents of CSV file into one of the matrix memories (Mat A through Mat Z, and MatAns) (page 2-48)
- {M↔V} ... displays the Vector Editor screen (page 2-60)

• Creating a Matrix

To create a matrix, you must first define its dimensions (size) in the Matrix Editor. Then you can input values into the matrix.

• To specify the dimensions (size) of a matrix

Example To create a 2-row × 3-column matrix in the area named Mat B

Highlight Mat B.



F3 (DIM) (This step can be omitted.)

Specify the number of rows.

2 **EXE**

Specify the number of columns.

3 **EXE**

EXE

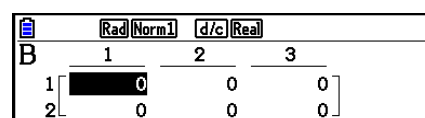
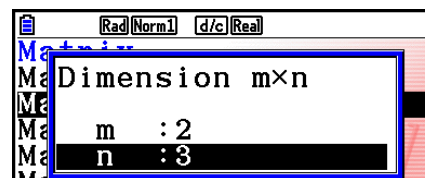
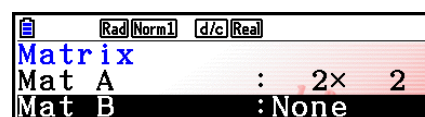

- All of the cells of a new matrix contain the value 0.
- Changing the dimensions of a matrix deletes its current contents.
- If “Memory ERROR” remains next to the matrix area name after you input the dimensions, it means there is not enough free memory to create the matrix you want.

• To input cell values

Example To input the following data into Matrix B:

$$\begin{bmatrix} 1 & 2 & 3 \\ 4 & 5 & 6 \end{bmatrix}$$

The following operation is a continuation of the example calculation on the previous page.

1 **EXE** **2** **EXE** **3** **EXE**

4 **EXE** **5** **EXE** **6** **EXE**

(Data is input into the highlighted cell. Each time you press **EXE**, the highlighting moves to the next cell to the right.)

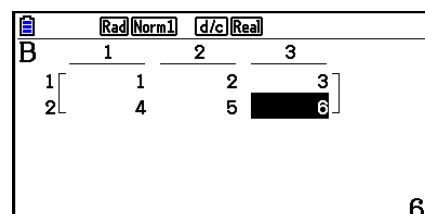

6

- Displayed cell values show positive integers up to six digits, and negative integers up to five digits (one digit used for the negative sign). Exponential values are shown with up to two digits for the exponent. Fractional values are not displayed.

• Deleting Matrices

You can delete either a specific matrix or all matrices in memory.

• To delete a specific matrix

1. While the Matrix Editor is on the display, use \blacktriangle and \blacktriangledown to highlight the matrix you want to delete.
2. Press $\boxed{\text{F1}}$ (DELETE).
3. Press $\boxed{\text{F1}}$ (Yes) to delete the matrix or $\boxed{\text{F6}}$ (No) to abort the operation without deleting anything.

• To delete all matrices

1. While the Matrix Editor is on the display, press $\boxed{\text{F2}}$ (DEL-ALL).
2. Press $\boxed{\text{F1}}$ (Yes) to delete all matrices in memory or $\boxed{\text{F6}}$ (No) to abort the operation without deleting anything.

■ Matrix Cell Operations

Use the following procedure to prepare a matrix for cell operations.

1. While the Matrix Editor is on the display, use \blacktriangle and \blacktriangledown to highlight the name of the matrix you want to use.
 You can jump to a specific matrix by inputting the letter that corresponds to the matrix name. Inputting $\boxed{\text{ALPHA}} \boxed{\text{8}}$ (N), for example, jumps to Mat N.
 Pressing $\boxed{\text{SHIFT}} \boxed{\text{←}}$ (Ans) jumps to the matrix current memory.
2. Press $\boxed{\text{EXE}}$ and the function menu with the following items appears.
 - **{ROW-OP}** ... {row operation menu}
 - **{ROW}**
 - **{DELETE}**/**{INSERT}**/**{ADD}** ... row {delete}/**{insert}**/**{add}**
 - **{COLUMN}**
 - **{DELETE}**/**{INSERT}**/**{ADD}** ... column {delete}/**{insert}**/**{add}**
 - **{EDIT}** ... {cell editing screen}

All of the following examples use Matrix A.

• Row Calculations

The following menu appears whenever you press **F1** (ROW-OP) while a recalled matrix is on the display.

- **{SWAP}** ... {row swap}
- **{*Row}** ... {product of specified row and scalar}
- **{*Row+}** ... {addition of one row and the product of a specified row with a scalar}
- **{Row+}** ... {addition of specified row to another row}

• To swap two rows

Example To swap rows two and three of the following matrix:

All of the operation examples are performed using the following matrix.

$$\text{Matrix A} = \begin{bmatrix} 1 & 2 \\ 3 & 4 \\ 5 & 6 \end{bmatrix}$$

F1 (ROW-OP) **F1** (SWAP)

Input the number of the rows you want to swap.

2 **EXE** **3** **EXE** **EXE**

	Rad	Norm1	d/c	Real
A	1	2		
1	1	2		
2	5	6		
3	3	4		

• To calculate the scalar multiplication of a row

Example To calculate the product of row 2 and the scalar 4

F1 (ROW-OP) **F2** (*Row)

Input multiplier value.*

4 **EXE**

Specify row number.

2 **EXE** **EXE**

	Rad	Norm1	d/c	Real
A	1	2		
1	1	2		
2	12	16		
3	5	6		

* A complex number also can be input as multiplier value (k).

• **To calculate the scalar multiplication of a row and add the result to another row**

Example **To calculate the product of row 2 and the scalar 4, then add the result to row 3**

F1 (ROW-OP) **F3** (*Row+)

Input multiplier value.*

4 **EXE**

Specify number of row whose product should be calculated.

2 **EXE**

Specify number of row where result should be added.

3 **EXE** **EXE**

	Rad	Norm1	d/c	Real
A	1	2		
1	1	2		
2	3	4		
3	17	22		

* A complex number also can be input as multiplier value (k).

• **To add two rows together**

Example **To add row 2 to row 3**

F1 (ROW-OP) **F4** (Row+)

Specify number of row to be added.

2 **EXE**

Specify number of row to be added to.

3 **EXE** **EXE**

	Rad	Norm1	d/c	Real
A	1	2		
1	1	2		
2	3	4		
3	8	10		

• **Row Operations**

- **{DELETE}** ... {delete row}
- **{INSERT}** ... {insert row}
- **{ADD}** ... {add row}

• **To delete a row**

Example **To delete row 2**

F2 (ROW) **▼**

	Rad	Norm1	d/c	Real
A	1	2		
1	1	2		
2	3	4		
3	5	6		

F1 (DELETE)

	Rad	Norm1	d/c	Real
A	1	2		
1	1	2		
2	5	6		

• **To insert a row**

Example **To insert a new row between rows one and two**

F2 (ROW) ▼
F2 (INSERT)

	Rad(Norm)	d/c(Real)
A	1	2
1	1	2
2	0	0
3	3	4
4	5	6

• **To add a row**

Example **To add a new row below row 3**

F2 (ROW) ▼ ▼
F3 (ADD)

	Rad(Norm)	d/c(Real)
A	1	2
1	1	2
2	3	4
3	5	6
4	0	0

• **Column Operations**

- {DELETE} ... {delete column}
- {INSERT} ... {insert column}
- {ADD} ... {add column}

• **To delete a column**

Example **To delete column 2**

F3 (COLUMN) ►
F1 (DELETE)

	Rad(Norm)	d/c(Real)
A	1	
1	1	
2	3	
3	5	

■ Transferring Data between Matrices and CSV Files

You can import the contents of a CSV file stored with this calculator or transferred from a computer into one of the matrix memories (Mat A through Mat Z, and MatAns). You also can save the contents of one of the matrix memories (Mat A through Mat Z, and MatAns) as a CSV file.

● To import the contents of a CSV file to a matrix memory

1. Prepare the CSV file you want to import.
 - See “Import CSV File Requirements” (page 3-18).
2. While the Matrix Editor is on the display, use \blacktriangle and \blacktriangledown to highlight the name of the matrix to which you want to import the CSV file contents.
 - If the matrix you select already contains data, performing the following steps will overwrite its current contents with the newly imported CSV file data.
3. Press $\boxed{F4}$ (CSV) $\boxed{F1}$ (LOAD).
4. On the select file dialog box that appears, use \blacktriangle and \blacktriangledown to move the highlighting to the file you want to import and then press \boxed{EXE} .
 - This imports the contents of the CSV file you specified to the matrix memory.

Important!

Attempting to import the following types of CSV files will result in an error.

- A CSV file that includes data that cannot be converted. In this case, an error message will appear showing the location in the CSV file (Example: row 2, column 3) where the data that cannot be converted is located.
- A CSV file with more than 999 columns or 999 rows. In this case, an “Invalid Data Size” error will occur.

● To save matrix contents as a CSV file

1. While the Matrix Editor is on the display, use \blacktriangle and \blacktriangledown to highlight the name of the matrix whose contents you want to save as a CSV file.
2. Press $\boxed{F4}$ (CSV) $\boxed{F2}$ (SAVE • AS).
 - This displays a folder selection screen.
3. Select the folder where you want to save the CSV file.
 - To store the CSV file in the root directory, highlight “ROOT”.
 - To store the CSV file in a folder, use \blacktriangle and \blacktriangledown to move the highlighting to the desired folder and then press $\boxed{F1}$ (OPEN).
4. Press $\boxed{F1}$ (SAVE • AS).
5. Input up to eight characters for the file name and then press \boxed{EXE} .

Important!

- When saving matrix data to a CSV file, some data is converted as described below.
 - Complex number data: Only the real number part is extracted.
 - Fraction data: Converted to calculation line format (Example: $2\frac{3}{4} \rightarrow =2+3/4$)
 - $\sqrt{\quad}$ and π data: Converted to a decimal value (Example: $\sqrt{3} \rightarrow 1.732050808$)

• To specify the CSV file delimiter symbol and decimal point

While the Matrix Editor is on the display, press **F4** (CSV) **F3** (SET) to display the CSV format setting screen. Next, perform the procedure from step 3 under “Specifying the CSV File Delimiter Symbol and Decimal Point” (page 3-20).

■ Modifying Matrices Using Matrix Commands

[OPTN]-[MAT/VCT]

• To display the matrix commands

1. From the Main Menu, enter the **Run-Matrix** mode.
2. Press **OPTN** to display the option menu.
3. Press **F2** (MAT/VCT) to display the matrix command menu.

The following describes only the matrix command menu items that are used for creating matrices and inputting matrix data.

- **{Mat}** ... {Mat command (matrix specification)}
 - **{Mat→Lst}** ... {Mat→List command (assign contents of selected column to a list)}
 - **{Augment}** ... {Augment command (link two matrices)}
 - **{Identity}** ... {Identity command (identity matrix input)}
 - **{Dim}** ... {Dim command (dimension check)}
 - **{Fill{}}** ... {Fill command (identical cell values)}
-
- You can also use **SHIFT** **2** (Mat) in place of **OPTN** **F2** (MAT/VCT) **F1** (Mat).

• Matrix Data Input Format

[OPTN]-[MAT/VCT]-[Mat]

The following shows the format you should use when inputting data to create a matrix using the Mat command.

$$\begin{bmatrix} a_{11} & a_{12} & \dots & a_{1n} \\ a_{21} & a_{22} & \dots & a_{2n} \\ \vdots & \vdots & & \vdots \\ a_{m1} & a_{m2} & \dots & a_{mn} \end{bmatrix} = [[a_{11}, a_{12}, \dots, a_{1n}] [a_{21}, a_{22}, \dots, a_{2n}] \dots [a_{m1}, a_{m2}, \dots, a_{mn}]]$$

→ Mat [letter A through Z]

Example To input the following data as Matrix A: $\begin{bmatrix} 1 & 3 & 5 \\ 2 & 4 & 6 \end{bmatrix}$

[SHIFT] [+] ([) [SHIFT] [+] ([) 1 , 3 , 5
 [SHIFT] [-] (]) [SHIFT] [+] ([) 2 , 4 , 6
 [SHIFT] [-] (]) [SHIFT] [-] (]) → [OPTN] [F2] (MAT/VCT)
 [F1] (Mat) [ALPHA] [X,θ,T] (A)
 [EXE]

Math [Rad] [Norm1] [d/c] [Real]
 [3,5][2,4,6]]→Mat A|

Math [Rad] [Norm1] [d/c] [Real]
 [[1,3,5][2,4,6]]→Mat A|
 [1 3 5]
 [2 4 6]

- The maximum value of both m and n is 999.
- An error occurs if memory becomes full as you are inputting data.
- You can also use the above format inside a program that inputs matrix data.

• To input an identity matrix

[OPTN]-[MAT/VCT]-[Identity]

Use the Identity command to create an identity matrix.

Example To create a 3×3 identity matrix as Matrix A

[OPTN] [F2] (MAT/VCT) [F6] (▷) [F1] (Identity)
 3 → [F6] (▷) [F1] (Mat) [ALPHA] [X,θ,T] (A) [EXE]
 └─ Number of rows/columns

Math [Rad] [Norm1] [d/c] [Real]
 Identity 3→Mat A|
 [1 0 0]
 [0 1 0]
 [0 0 1]

- **To check the dimensions of a matrix**

[OPTN]-[MAT/VCT]-[Dim]

Use the Dim command to check the dimensions of an existing matrix.

Example 1 To check the dimensions of Matrix A

[OPTN] [F2] (MAT/VCT) [F6] (▷) [F2] (Dim)
[F6] (▷) [F1] (Mat) [ALPHA] [X,θ,T] (A) [EXE]

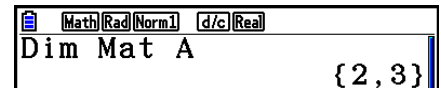

The display shows that Matrix A consists of two rows and three columns.

Since the result of the Dim command is list type data, it is stored in ListAns Memory.

You can also use {Dim} to specify the dimensions of the matrix.

Example 2 To specify dimensions of 2 rows and 3 columns for Matrix B

[SHIFT] [X] ({) [2] [] [3] [SHIFT] [÷] (}) [→]
[OPTN] [F2] (MAT/VCT) [F6] (▷) [F2] (Dim)
[F6] (▷) [F1] (Mat) [ALPHA] [log] (B) [EXE]

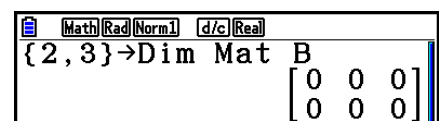

- The “Dim” command can be used to check and configure vector dimension settings.

- **Modifying Matrices Using Matrix Commands**

You can also use matrix commands to assign values to and recall values from an existing matrix, to fill in all cells of an existing matrix with the same value, to combine two matrices into a single matrix, and to assign the contents of a matrix column to a list.

- **To assign values to and recall values from an existing matrix**

[OPTN]-[MAT/VCT]-[Mat]

Use the following format with the Mat command to specify a cell for value assignment and recall.

Mat X [m, n]

X = matrix name (A through Z, or Ans)

m = row number

n = column number

Example 1 To assign 10 to the cell at row 1, column 2 of the following matrix:

$$\text{Matrix A} = \begin{bmatrix} 1 & 2 \\ 3 & 4 \\ 5 & 6 \end{bmatrix}$$

1 **0** \rightarrow **OPTN** **F2** (MAT/VCT) **F1** (Mat)
ALPHA **X,θ,T** (A) **SHIFT** **+** ([) **1** **,** **2**
SHIFT **=** (]) **EXE**

Math Rad Norm1 d/c Real
 10→Mat A[1,2] 10

- The “Vct” command can be used to assign values to existing vectors.

Example 2 Multiply the value in the cell at row 2, column 2 of the above matrix by 5

OPTN **F2** (MAT/VCT) **F1** (Mat)
ALPHA **X,θ,T** (A) **SHIFT** **+** ([) **2** **,** **2**
SHIFT **=** (]) **×** **5** **EXE**

Math Rad Norm1 d/c Real
 Mat A[2,2]×5 20

- The “Vct” command can be used to recall values from existing vectors.

• **To fill a matrix with identical values and to combine two matrices into a single matrix** **[OPTN]-[MAT/VCT]-[Fill()]/[Augment]**

Use the Fill(command to fill all the cells of an existing matrix with an identical value and the Augment command to combine two existing matrices into a single matrix.

Example 1 To fill all of the cells of Matrix A with the value 3

OPTN **F2** (MAT/VCT) **F6** (▷) **F3** (Fill()
3 **,** **F6** (▷) **F1** (Mat) **ALPHA** **X,θ,T** (A) **)** **EXE**

Math Rad Norm1 d/c Real
 Fill(3,Mat A) $\begin{bmatrix} 3 & 3 \\ 3 & 3 \\ 3 & 3 \end{bmatrix}$

- The “Fill” command can be used to write the same value into all vector elements.

Example 2 To combine the following two matrices:

$$\text{Matrix A} = \begin{bmatrix} 1 \\ 2 \end{bmatrix} \quad \text{Matrix B} = \begin{bmatrix} 3 \\ 4 \end{bmatrix}$$

OPTN **F2** (MAT/VCT) **F5** (Augment)
F1 (Mat) **ALPHA** **X,θ,T** (A) **,**
F1 (Mat) **ALPHA** **log** (B) **)** **EXE**

Math Rad Norm1 d/c Real
 Augment(Mat A,Mat B) $\begin{bmatrix} 1 & 3 \\ 2 & 4 \end{bmatrix}$

- The two matrices you combine must have the same number of rows. An error occurs if you try to combine two matrices that have different number of rows.
- You can use Matrix Answer Memory to assign the results of the above matrix input and edit operations to a matrix variable. To do so, use the following syntax.
 Augment (Mat α , Mat β) \rightarrow Mat γ
 In the above, α , β , and γ are any variable names A through Z.
 The above does not affect the contents of Matrix Answer Memory.
- The “Augment” command can be used to merge two vectors into a single matrix.

• To assign the contents of a matrix column to a list

[OPTN]-[MAT/VCT]-[Mat→Lst]

Use the following format with the Mat→List command to specify a column and a list.

Mat→List (Mat X, m) → List n

X = matrix name (A through Z)

m = column number

n = list number

Example To assign the contents of column 2 of the following matrix to list 1:

$$\text{Matrix A} = \begin{bmatrix} 1 & 2 \\ 3 & 4 \\ 5 & 6 \end{bmatrix}$$

[OPTN] [F2] (MAT/VCT) [F2] (Mat→Lst)
[F1] (Mat) [ALPHA] [X,θ,T] (A) [▸] [2] [▢]
[→] [OPTN] [F1] (LIST) [F1] (List) [1] [EXE]
[F1] (List) [1] [EXE]

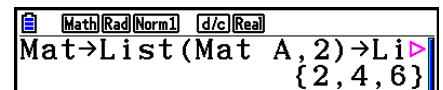

Math Rad Norm1 d/c Real
Mat→List(Mat A, 2)→List 1
{2, 4, 6}

■ Matrix Calculations

[OPTN]-[MAT/VCT]

Use the matrix command menu to perform matrix calculation operations.

• To display the matrix commands

1. From the Main Menu, enter the **Run-Matrix** mode.
2. Press [OPTN] to display the option menu.
3. Press [F2] (MAT/VCT) to display the matrix command menu.

The following describes only the matrix commands that are used for matrix arithmetic operations.

- {**Mat**} ... {Mat command (matrix specification)}
- {**Det**} ... {Det command (determinant command)}
- {**Trn**} ... {Trn command (transpose matrix command)}
- {**Identity**} ... {Identity command (identity matrix input)}
- {**Ref**} ... {Ref command (row echelon form command)}
- {**Rref**} ... {Rref command (reduced row echelon form command)}

All of the following examples assume that matrix data is already stored in memory.

• Matrix Arithmetic Operations

[OPTN]-[MAT/VCT]-[Mat]/[Identity]

Example 1 To add the following two matrices (Matrix A + Matrix B):

$$\text{Matrix A} = \begin{bmatrix} 1 & 1 \\ 2 & 1 \end{bmatrix} \quad \text{Matrix B} = \begin{bmatrix} 2 & 3 \\ 2 & 1 \end{bmatrix}$$

[OPTN] [F2] (MAT/VCT) [F1] (Mat) [ALPHA] [X,θ,T] (A) [+]
[F1] (Mat) [ALPHA] [log] (B) [EXE]

Example 2 To multiply the two matrices in Example 1 (Matrix A × Matrix B)

[OPTN] [F2] (MAT/VCT) [F1] (Mat) [ALPHA] [X,θ,T] (A) [X]
[F1] (Mat) [ALPHA] [log] (B) [EXE]

- The two matrices must have the same dimensions in order to be added or subtracted. An error occurs if you try to add or subtract matrices of different dimensions.
- For multiplication (Matrix 1 × Matrix 2), the number of columns in Matrix 1 must match the number of rows in Matrix 2. Otherwise, an error occurs.

• Determinant

[OPTN]-[MAT/VCT]-[Det]

Example Obtain the determinant for the following matrix:

$$\text{Matrix A} = \begin{bmatrix} 1 & 2 & 3 \\ 4 & 5 & 6 \\ -1 & -2 & 0 \end{bmatrix}$$

[OPTN] [F2] (MAT/VCT) [F3] (Det) [F1] (Mat)
[ALPHA] [X,θ,T] (A) [EXE]

- Determinants can be obtained only for square matrices (same number of rows and columns). Trying to obtain a determinant for a matrix that is not square produces an error.
- The determinant of a 2 × 2 matrix is calculated as shown below.

$$|A| = \begin{vmatrix} a_{11} & a_{12} \\ a_{21} & a_{22} \end{vmatrix} = a_{11}a_{22} - a_{12}a_{21}$$

- The determinant of a 3 × 3 matrix is calculated as shown below.

$$|A| = \begin{vmatrix} a_{11} & a_{12} & a_{13} \\ a_{21} & a_{22} & a_{23} \\ a_{31} & a_{32} & a_{33} \end{vmatrix} = a_{11}a_{22}a_{33} + a_{12}a_{23}a_{31} + a_{13}a_{21}a_{32} - a_{11}a_{23}a_{32} - a_{12}a_{21}a_{33} - a_{13}a_{22}a_{31}$$

• Matrix Transposition

[OPTN]-[MAT/VCT]-[Trn]

A matrix is transposed when its rows become columns and its columns become rows.

Example To transpose the following matrix:

$$\text{Matrix A} = \begin{bmatrix} 1 & 2 \\ 3 & 4 \\ 5 & 6 \end{bmatrix}$$

[OPTN] [F2] (MAT/VCT) [F4] (Trn) [F1] (Mat)
[ALPHA] [X,θ,T] (A) [EXE]

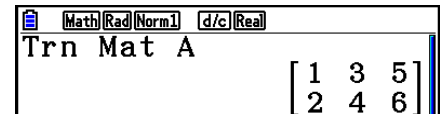

Trn Mat A

$$\begin{bmatrix} 1 & 3 & 5 \\ 2 & 4 & 6 \end{bmatrix}$$

- The “Trn” command can be used with a vector as well. It converts a $1\text{-row} \times n\text{-column}$ vector to an $n\text{-row} \times 1\text{-column}$ vector, or an $m\text{-row} \times 1\text{-column}$ vector to a $1\text{-row} \times m\text{-column}$ vector.

• Row Echelon Form

[OPTN]-[MAT/VCT]-[Ref]

This command uses the Gaussian elimination algorithm to find the row echelon form of a matrix.

Example To find the row echelon form of the following matrix:

$$\text{Matrix A} = \begin{bmatrix} 1 & 2 & 3 \\ 4 & 5 & 6 \end{bmatrix}$$

[OPTN] [F2] (MAT/VCT) [F6] (▷) [F4] (Ref)
[F6] (▷) [F1] (Mat) [ALPHA] [X,θ,T] (A) [EXE]

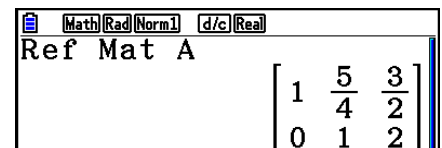

Ref Mat A

$$\begin{bmatrix} 1 & \frac{5}{4} & \frac{3}{2} \\ 0 & 1 & 2 \end{bmatrix}$$

• Reduced Row Echelon Form

[OPTN]-[MAT/VCT]-[Rref]

This command finds the reduced row echelon form of a matrix.

Example To find the reduced row echelon form of the following matrix:

$$\text{Matrix A} = \begin{bmatrix} 2 & -1 & 3 & 19 \\ 1 & 1 & -5 & -21 \\ 0 & 4 & 3 & 0 \end{bmatrix}$$

[OPTN] [F2] (MAT/VCT) [F6] (▷) [F5] (Rref)
[F6] (▷) [F1] (Mat) [ALPHA] [X,θ,T] (A) [EXE]

- The row echelon form and reduced row echelon form operation may not produce accurate results due to dropped digits.

• Matrix Inversion

[x⁻¹]

Example To invert the following matrix:

$$\text{Matrix A} = \begin{bmatrix} 1 & 2 \\ 3 & 4 \end{bmatrix}$$

[OPTN] [F2] (MAT/VCT) [F1] (Mat)
[ALPHA] [X,θ,T] (A) [SHIFT] [x⁻¹] [EXE]

- Only square matrices (same number of rows and columns) can be inverted. Trying to invert a matrix that is not square produces an error.
- A matrix with a determinant of zero cannot be inverted. Trying to invert a matrix with determinant of zero produces an error.
- Calculation precision is affected for matrices whose determinant is near zero.
- A matrix being inverted must satisfy the conditions shown below.

$$\mathbf{A A^{-1} = A^{-1} A = E = \begin{bmatrix} 1 & 0 \\ 0 & 1 \end{bmatrix}}$$

The following shows the formula used to invert Matrix A into inverse matrix A⁻¹.

$$\mathbf{A = \begin{bmatrix} a & b \\ c & d \end{bmatrix}}$$

$$\mathbf{A^{-1} = \frac{1}{ad - bc} \begin{bmatrix} d & -b \\ -c & a \end{bmatrix}}$$

Note that $ad - bc \neq 0$.

• Squaring a Matrix

[x²]

Example To square the following matrix:

$$\text{Matrix A} = \begin{bmatrix} 1 & 2 \\ 3 & 4 \end{bmatrix}$$

OPTN F2 (MAT/VCT) F1 (Mat) ALPHA X,θ,T (A)
x² EXE

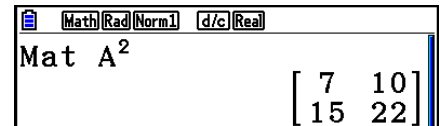

Math Rad Norm1 d/c Real
Mat A²
 $\begin{bmatrix} 7 & 10 \\ 15 & 22 \end{bmatrix}$

• Raising a Matrix to a Power

[^]

Example To raise the following matrix to the third power:

$$\text{Matrix A} = \begin{bmatrix} 1 & 2 \\ 3 & 4 \end{bmatrix}$$

OPTN F2 (MAT/VCT) F1 (Mat) ALPHA X,θ,T (A)
^ 3 EXE

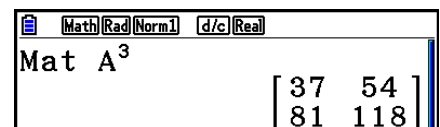

Math Rad Norm1 d/c Real
Mat A³
 $\begin{bmatrix} 37 & 54 \\ 81 & 118 \end{bmatrix}$

- For matrix power calculations, calculation is possible up to a power of 32766.

• Determining the Absolute Value, Integer Part, Fraction Part, and Maximum Integer of a Matrix

[OPTN]-[NUMERIC]-[Abs]/[Frac]/[Int]/[Intg]

Example To determine the absolute value of the following matrix:

$$\text{Matrix A} = \begin{bmatrix} 1 & -2 \\ -3 & 4 \end{bmatrix}$$

OPTN F6 (▷) F4 (NUMERIC) F1 (Abs)
OPTN F2 (MAT/VCT) F1 (Mat) ALPHA X,θ,T (A) EXE

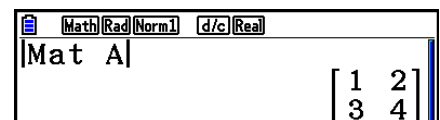

Math Rad Norm1 d/c Real
|Mat A|
 $\begin{bmatrix} 1 & 2 \\ 3 & 4 \end{bmatrix}$

- The “Abs” command can be used to obtain the absolute value of a vector element.

• Complex Number Calculations with a Matrix

Example To determine the absolute value of a matrix with the following complex number elements:

$$\text{Matrix D} = \begin{bmatrix} -1 + i & 1 + i \\ 1 + i & -2 + 2i \end{bmatrix}$$

OPTN F6 (▷) F4 (NUMERIC) F1 (Abs)
OPTN F2 (MAT/VCT) F1 (Mat) ALPHA sin (D) EXE

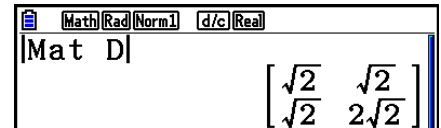

- The following complex number functions are supported in matrices and vectors.
i, Abs, Arg, Conj, ReP, ImP

Matrix Calculation Precautions

- Determinants and inverse matrices are subject to error due to dropped digits.
- Matrix operations are performed individually on each cell, so calculations may require considerable time to complete.
- The calculation precision of displayed results for matrix calculations is ± 1 at the least significant digit.
- If a matrix calculation result is too large to fit into Matrix Answer Memory, an error occurs.
- You can use the following operation to transfer Matrix Answer Memory contents to another matrix.

MatAns \rightarrow Mat α

In the above, α is any variable name A through Z. The above does not affect the contents of Matrix Answer Memory.

9. Vector Calculations

To perform vector calculations, use the Main Menu to enter the **Run-Matrix** mode, and then press **F3** (▶MAT/VCT) **F6** (M↔V).

A vector is defined as a matrix that is either of the two following forms: m (rows) \times 1 (column) or 1 (row) \times n (columns).

The maximum allowable value that can be specified for both m and n is 999.

You can use the 26 vector memories (Vct A through Vct Z) plus a Vector Answer Memory (VctAns) to perform the vector calculations listed below.

- Addition, subtraction, multiplication
- Scalar multiple calculations
- Dot product calculations
- Cross product calculations
- Determination of the vector norm (size)
- Determination of the angle formed by two vectors
- Determination of the unit vector

Important!

- You can input either an upper-case X (**ALPHA** **+** (X)) or lower-case x (**X.θ.1**) for vector memory "Vct X". Both "Vct X" and "Vct x " refer to the same memory area.

About Vector Answer Memory (VctAns)

The calculator automatically stores vector calculation results in Vector Answer Memory. Note the following precautions about Vector Answer Memory.

- Whenever you perform a vector calculation, the current Vector Answer Memory contents are replaced by the new result. The previous contents are deleted and cannot be recovered.
- Inputting values into a vector does not affect Vector Answer Memory contents.
- Vector calculation results are also stored in Matrix Answer Memory (MatAns).

Inputting and Editing a Vector

Pressing **F3** (▶MAT/VCT) **F6** (M↔V) displays the Vector Editor screen. Use the Vector Editor to input and edit vectors.

$m \times n$... m (row) \times n (column) vector
None ... no vector preset

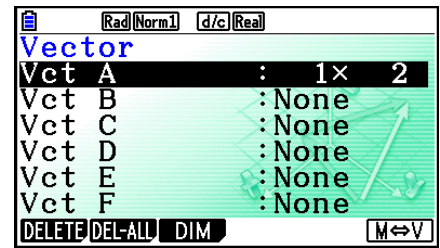

- **{DELETE}/[DEL-ALL]** ... deletes {a specific vector}/all vectors
- **{DIM}** ... specifies the vector dimensions (m rows \times 1 column or 1 row \times n columns)
- **{M↔V}** ... displays the Matrix Editor screen (page 2-42)

Vector input and editing, and vector cell (element) operations are the same as matrix calculation operations. For more information, see “Inputting and Editing Matrices” (page 2-42) and “Matrix Cell Operations” (page 2-44). Note, however, that vector calculations differ from matrix calculations as described below.

- On the vector memory element input screen, there is no **F1** (ROW-OP) in the function menu.
- For vector editing, the dimension always limited to m rows \times 1 column or 1 row \times n columns.

Vector Calculations

[OPTN]-[MAT/VCT]

Use the vector command menu to perform vector calculations.

To display vector commands

1. From the Main Menu, enter the **Run-Matrix** mode.
2. Press **[OPTN]** to display the option menu.
3. Press **F2** (MAT/VCT) **F6** (▶) **F6** (▶) to display the vector command menu.
 - **{Vct}** ... {Vct command (vector specification)}
 - **{DotP{}}** ... {DotP command (dot product command)}
 - **{CrossP{}}** ... {CrossP command (cross product command)}
 - **{Angle{}}** ... {Angle command (calculate the angle formed by two vectors)}
 - **{UnitV{}}** ... {UnitV command (calculate the unit vector)}
 - **{Norm{}}** ... {Norm command (calculate the vector norm (size))}

Vector Calculation Precautions

- When calculating a dot product, cross product, and angle formed by two vectors, the dimensions of the two vectors must be the same. Also, a cross product’s dimensions must be 1×2 , 1×3 , 2×1 , or 3×1 .
- Vector calculations are performed independently for each element, so it may take some time before calculations results are displayed.

- The calculation precision of displayed results for vector calculations is ± 1 at the least significant digit.
- If a vector calculation result is too large to fit into Vector Answer Memory, an error occurs.
- You can use the following operation to transfer Vector Answer Memory contents to another vector.

VctAns \rightarrow Vct α

In the above, α is any variable name A through Z. The above does not affect the contents of Vector Answer Memory.

- Vector memory and matrix memory are compatible with each other, so vector memory contents can be assigned to matrix memory, if you want.

Vct $\alpha \rightarrow$ Mat β

In the above, α and β are any variable names A through Z.

• Vector Data Input Format

[OPTN]-[MAT/VCT]-[Vct]

The following shows the format you should use when inputting data to create a vector using the Vct command.

$$\begin{bmatrix} a_{11} \\ a_{21} \\ \vdots \\ a_{m1} \end{bmatrix} \rightarrow \text{Vct [A to Z]} \qquad [a_{11} \ a_{12} \ \dots \ a_{1n}] \rightarrow \text{Vct [A to Z]}$$

Example To input the following data to Vct A: [1 2 3]

SHIFT + ([) SHIFT + ([) 1 , 2 , 3

SHIFT - (]) SHIFT - (]) \rightarrow

OPTN F2 (MAT/VCT) F6 (\triangleright) F6 (\triangleright) F1 (Vct)

ALPHA X,θ,T (A) EXE

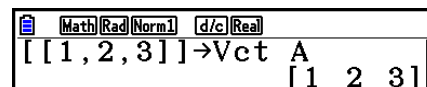

Math Rad Norm1 d/c Real
[[1,2,3]] \rightarrow Vct A
[1 2 3]

- The maximum value of both m and n is 999.
- An error occurs if memory becomes full as you are inputting data.
- You can also use the above format inside a program that inputs vector data.

All of the following examples assume that vector data is already stored in memory.

• Vector Addition, Subtraction, and Multiplication

[OPTN]-[MAT/VCT]-[Vct]

Example 1 To determine the sum of the two vectors shown below (Vct A + Vct B):

$$\text{Vct A} = [1 \ 2] \quad \text{Vct B} = [3 \ 4]$$

[OPTN] [F2] (MAT/VCT) [F6] (▷) [F6] (▷) [F1] (Vct)
 [ALPHA] [X,θ,T] (A) [+] [F1] (Vct) [ALPHA] [log] (B) [EXE]

Math	Rad	Norm1	d/c	Real
Vct A+Vct B				[4 6]

Example 2 To determine the product of the two vectors shown below (Vct A × Vct B):

$$\text{Vct A} = [1 \ 2] \quad \text{Vct B} = \begin{bmatrix} 3 \\ 4 \end{bmatrix}$$

[OPTN] [F2] (MAT/VCT) [F6] (▷) [F6] (▷) [F1] (Vct)
 [ALPHA] [X,θ,T] (A) [×] [F1] (Vct) [ALPHA] [log] (B) [EXE]

Math	Rad	Norm1	d/c	Real
Vct A×Vct B				[11]

Example 3 To determine the product of the matrix and vector shown below (Mat A × Vct B):

$$\text{Mat A} = \begin{bmatrix} 1 & 2 \\ 2 & 1 \end{bmatrix} \quad \text{Vct B} = \begin{bmatrix} 1 \\ 2 \end{bmatrix}$$

[OPTN] [F2] (MAT/VCT) [F1] (Mat)
 [ALPHA] [X,θ,T] (A) [×] [F6] (▷) [F6] (▷)
 [F1] (Vct) [ALPHA] [log] (B) [EXE]

Math	Rad	Norm1	d/c	Real
Mat A×Vct B				$\begin{bmatrix} 5 \\ 4 \end{bmatrix}$

- When performing addition or subtraction of two vectors, they both must have the same dimensions.
- When multiplying Vct A ($1 \times n$) and Vct B ($m \times 1$), n and m must be the same.

• Dot Product

[OPTN]-[MAT/VCT]-[DotP]

Example To determine the dot product of the two vectors below

$$\text{Vct A} = [1 \ 2] \quad \text{Vct B} = [3 \ 4]$$

[OPTN] [F2] (MAT/VCT) [F6] (▷) [F6] (▷)
 [F2] (DotP () [F1] (Vct) [ALPHA] [X,θ,T] (A) [↵]
 [F1] (Vct) [ALPHA] [log] (B) [↵] [EXE]

Math	Rad	Norm1	d/c	Real
DotP (Vct A, Vct B)				11

• **Cross Product**

[OPTN]-[MAT/VCT]-[CrossP]

Example To determine the cross product of the two vectors below

Vct A = [1 2] Vct B = [3 4]

[OPTN] [F2] (MAT/VCT) [F6] (▷) [F6] (▷)
 [F3] (CrossP() [F1] (Vct) [ALPHA] [X,θ,T] (A) []
 [F1] (Vct) [ALPHA] [log] (B) [] [EXE]

[Math] [Rad] [Norm] [d/c] [Real]
 CrossP(Vct A,Vct B)
 [0 0 -2]

• **Angle Formed by Two Vectors**

[OPTN]-[MAT/VCT]-[Angle]

Example To determine the angle formed by two vectors

Vct A = [1 2] Vct B = [3 4]

[OPTN] [F2] (MAT/VCT) [F6] (▷) [F6] (▷)
 [F4] (Angle() [F1] (Vct) [ALPHA] [X,θ,T] (A) []
 [F1] (Vct) [ALPHA] [log] (B) [] [EXE]

[Math] [Rad] [Norm] [d/c] [Real]
 Angle(Vct A,Vct B)
 0.1798534998

• **Unit Vector**

[OPTN]-[MAT/VCT]-[UnitV]

Example Determine the unit vector of the vector below

Vct A = [5 5]

[OPTN] [F2] (MAT/VCT) [F6] (▷) [F6] (▷)
 [F5] (UnitV() [F1] (Vct) [ALPHA] [X,θ,T] (A) [] [EXE]

[Math] [Rad] [Norm] [d/c] [Real]
 UnitV(Vct A)
 [$\frac{\sqrt{2}}{2}$ $\frac{\sqrt{2}}{2}$]

• **Vector Norm (Size)**

[OPTN]-[MAT/VCT]-[Norm]

Example To determine the vector norm (size)

Vct A = [1 3]

[OPTN] [F2] (MAT/VCT) [F6] (▷) [F6] (▷) [F6] (▷)
 [F1] (Norm() [F6] (▷) [F6] (▷) [F6] (▷)
 [F1] (Vct) [ALPHA] [X,θ,T] (A) [] [EXE]

[Math] [Rad] [Norm] [d/c] [Real]
 Norm(Vct A)
 $\sqrt{10}$

- You can use the “Norm” command to calculate the norm of a matrix.

10. Metric Conversion Calculations

You can convert values from one unit of measurement to another. Measurement units are classified according to the following 11 categories. The indicators in the “Display Name” column show the text that appears in the calculator’s function menu.

Important!

Metric conversion commands are supported only when the Metric Conversion add-in application is installed.

Display Name	Category	Display Name	Category	Display Name	Category
LENGTH	Length	TMPR	Temperature	PRESSURE	Pressure
AREA	Area	VELOCITY	Velocity	ENERGY	Energy/Work
VOLUME	Volume	MASS	Mass	POWER	Power
TIME	Time	FORCE	Force/Weight		

You can convert from any unit in a category to any other unit in the same category.

- Attempting to convert from a unit in one category (such as “AREA”) to a unit in another category (such as “TIME”) results in a Conversion ERROR.
- See the “Unit Conversion Command List” (page 2-66) for information about the units included in each category.

■ Performing a Unit Conversion Calculation

[OPTN]-[CONVERT]

Input the value you are converting from and the conversion commands using the syntax shown below to perform a unit conversion calculation.

{value converting from}{conversion command 1} ► {conversion command 2}

- Use {conversion command 1} to specify the unit being converted from and {conversion command 2} to specify the unit being converted to.
- ► is a command that links the two conversion commands. This command is always available at **F1**(►) of the Conversion menu.
- Real numbers or a list that contains real number elements only can be used as the value being converted from. When values being converted from are input into a list (or when list memory is specified), conversion calculation is performed for each element in the list and calculation results are returned in list format (ListAns screen).
- A complex number cannot be used as a value to be converted from. An error occurs if even a single element of a list being used as the value being converted from contains a complex number.

Example 1 To convert 50cm to inches

AC **5** **0** **OPTN** **F6** (►) **F1** (CONVERT)
F2 (LENGTH) **5** (cm) **F1** (►)
F2 (LENGTH) ► **2** (in) **EXE**

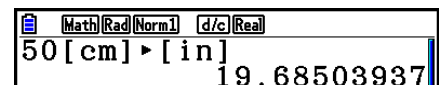

Math Rad Norm d/c Real
50 [cm] ► [in]
19.68503937

Example 2 To convert {175, 162} square meters to hectares

AC **SHIFT** **×** ({} **1** **7** **5** , **1** **6** **2**
SHIFT **÷** (})
OPTN **F6** (►) **F1** (CONVERT) **F3** (AREA)
2 (m²) **F1** (►) **F3** (AREA) **3** (ha) **EXE**

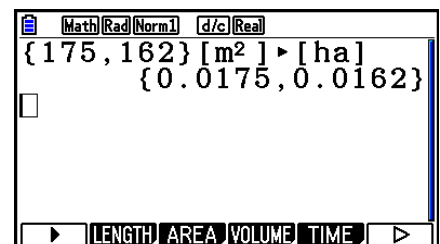

Math Rad Norm d/c Real
{175, 162} [m²] ► [ha]
{0.0175, 0.0162}

► LENGTH AREA VOLUME TIME ►

■ Unit Conversion Command List

Cat.	Display Name	Unit	Cat.	Display Name	Unit
Length	fm	fermi	Volume	cm ³	cubic centimeter
	Å	angstrom		mL	milliliter
	μm	micrometer		L	liter
	mm	millimeter		m ³	cubic meter
	cm	centimeter		in ³	cubic inch
	m	meter		ft ³	cubic foot
	km	kilometer		fl_oz(UK)	ounce
	AU	astronomical unit		fl_oz(US)	fluid ounce (U.S.)
	l.y.	light year		gal(US)	gallon
	pc	parsec		gal(UK)	UK gallon
	Mil	1/1000 inch		pt	pint
	in	inch		qt	quart
	ft	foot		tsp	teaspoon
	yd	yard		tbsp	tablespoon
	fath	fathom		cup	cup
	rd	rod		ns	nanosecond
	mile	mile		μs	microsecond
	n mile	nautical mile		ms	millisecond
	Area	cm ²		square centimeter	Time
m ²		square meter	min	minute	
ha		hectare	h	hour	
km ²		square kilometer	day	day	
in ²		square inch	week	week	
ft ²		square foot	yr	year	
yd ²		square yard	s-yr	sidereal year	
acre		acre	t-yr	tropical year	
mile ²		square mile			

Cat.	Display Name	Unit	Cat.	Display Name	Unit
Temperature	°C	degrees Celsius	Pressure	Pa	Pascal
	K	Kelvin		kPa	Kilo Pascal
	°F	degrees Fahrenheit		mmH ₂ O	millimeter of water
	°R	degrees Rankine		mmHg	millimeter of Mercury
Velocity	m/s	meter per second		atm	atmosphere
	km/h	kilometer per hour		inH ₂ O	inch of water
	knot	knot		inHg	inch of Mercury
	ft/s	foot per second		lbf/in ²	pound per square inch
	mile/h	mile per hour		bar	bar
Mass	u	atomic mass unit		kgf/cm ²	kilogram force per square centimeter
	mg	milligram		Energy/Work	eV
	g	gram	J		Joule
	kg	kilogram	cal _{th}		calorie _{th}
	mton	metric ton	cal ₁₅		calorie (15°C)
	oz	avoirdupois ounce	cal _{IT}		calorie _{IT}
	lb	pound mass	kcal _{th}		kilocalorie _{th}
	slug	slug	kcal ₁₅		kilocalorie (15°C)
	ton(short)	ton, short (2000lbm)	kcal _{IT}		kilocalorie _{IT}
	ton(long)	ton, long (2240lbm)	l-atm		liter atmosphere
	Force/Weight	N	newton		kW•h
lbf		pound of force	ft•lbf		foot-pound
tonf		ton of force	Btu		British thermal unit
dyne		dyne	erg		erg
kgf		kilogram of force	kgf•m		kilogram force meter
Power	W	watt	Power		W
				cal _{th} /s	calorie per second
				hp	horsepower
				ft•lbf/s	foot-pound per second
				Btu/min	British thermal unit per minute

Source: NIST Special Publication 811 (2008)

Chapter 3 List Function

A list is a storage place for multiple data items.

This calculator lets you store up to 26 lists in a single file, and you can store up to six files in memory. Stored lists can be used in arithmetic and statistical calculations, and for graphing.

Element number	Display range				Cell	Column	List name	Sub name
	List 1	List 2	List 3	List 4	List 5	List 26		
SUB								
1	56	1	107	3.5	4	0		
2	37	2	75	6	0	0		
3	21	4	122	2.1	0	0		
4	69	8	87	4.4	2	0		
5	40	16	298	3	0	0		
6	48	32	48	6.8	3	0		
7	93	64	338	2	9	0		
8	30	128	49	8.7	0	0		Row
⋮	⋮	⋮	⋮	⋮	⋮	⋮		
⋮	⋮	⋮	⋮	⋮	⋮	⋮		
⋮	⋮	⋮	⋮	⋮	⋮	⋮		



1. Inputting and Editing a List

When you enter the **Statistics** mode, the “List Editor” will appear first. You can use the List Editor to input data into a list and to perform a variety of other list data operations.

• To input values one-by-one

Use the cursor keys to move the highlighting to the list name, sub name or cell you want to select. Note that does not move the highlighting to a cell that does not contain a value.

	List 1	List 2	List 3	List 4
SUB				
1	56	107	0	3.5
2	37	75	0	6
3	21	122	0	2.1
4	69	87	0	4.4
				56

GRAPH CALC TEST INTR DIST

The screen automatically scrolls when the highlighting is located at either edge of the screen.

The following example is performed starting with the highlighting located at Cell 1 of List 1.

1. Input a value and press to store it in the list.

- The highlighting automatically moves down to the next cell for input.

	List 1	List 2	List 3	List 4
SUB				
1	3			
2				
3				
4				

2. Input the value 4 in the second cell, and then input the result of $2 + 3$ in the next cell.

4 **EXE** **2** **+** **3** **EXE**

	List 1	List 2	List 3	List 4
SUB				
1	3			
2	4			
3	5			
4				

- You can also input the result of an expression or a complex number into a cell.
- You can input values up to 999 cells in a single list.

• To batch input a series of values

1. Use the cursor keys to move the highlighting to another list.

	List 1	List 2	List 3	List 4
SUB				
1	3			

2. Press **SHIFT** **X** ({), and then input the values you want, pressing **▸** between each one. Press **SHIFT** **÷** (}) after inputting the final value.

SHIFT **X** ({) **6** **▸** **7** **▸** **8** **SHIFT** **÷** (})

	List 1	List 2	List 3	List 4
SUB				
1	3			
2	4			
3	5			
4				

{ 6 , 7 , 8 }

3. Press **EXE** to store all of the values in your list.

EXE

	List 1	List 2	List 3	List 4
SUB				
1	3	6		
2	4	7		
3	5	8		
4				

6

GRAPH CALC TEST INTR DIST ▶

- Remember that a comma separates values, so you should not input a comma after the final value of the set you are inputting.

Right: {34, 53, 78}

Wrong: {34, 53, 78,}

You can also use list names inside of a mathematical expression to input values into another cell. The following example shows how to add the values in each row in List 1 and List 2, and input the result into List 3.

1. Use the cursor keys to move the highlighting to the name of the list where you want the calculation results to be input.

	List 1	List 2	List 3	List 4
SUB				
1	3	6		

2. Press **OPTN** and input the expression.

OPTN **F1** (LIST) **F1** (List) **1** **+**

OPTN **F1** (LIST) **F1** (List) **2** **EXE**

	List 1	List 2	List 3	List 4
SUB				
1	3	6	9	
2	4	7	11	
3	5	8	13	
4				

- You can also use **SHIFT** **1** (List) in place of **OPTN** **F1** (LIST) **F1** (List).

■ Editing List Values

• To change a cell value

Use the cursor keys to move the highlighting to the cell whose value you want to change. Input the new value and press **EXE** to replace the old data with the new one.

• To edit the contents of a cell

1. Use the cursor keys to move the highlighting to the cell whose contents you want to edit.
2. Press **F6** (▷) **F2** (EDIT).
3. Make any changes in the data you want.

• To delete a cell

1. Use the cursor keys to move the highlighting to the cell you want to delete.
 2. Press **F6** (▷) **F3** (DELETE) to delete the selected cell and cause everything below it to be shifted up.
- The cell delete operation does not affect cells in other lists. If the data in the list whose cell you delete is somehow related to the data in neighboring lists, deleting a cell can cause related values to become misaligned.

• To delete all cells in a list

Use the following procedure to delete all the data in a list.

1. Use the cursor key to move the highlighting to any cell of the list whose data you want to delete.
2. Pressing **F6** (▷) **F4** (DEL-ALL) causes a confirmation message to appear.
3. Press **F1** (Yes) to delete all the cells in the selected list or **F6** (No) to abort the delete operation without deleting anything.

• To insert a new cell

1. Use the cursor keys to move the highlighting to the location where you want to insert the new cell.
 2. Press **F6** (\triangleright) **F5** (INSERT) to insert a new cell, which contains a value of 0, causing everything below it to be shifted down.
- The cell insert operation does not affect cells in other lists. If the data in the list where you insert a cell is somehow related to the data in neighboring lists, inserting a cell can cause related values to become misaligned.
-

■ Naming a List

You can assign List 1 through List 26 “sub names” of up to eight bytes each.

• To name a list

1. On the Setup screen, highlight “Sub Name” and then press **F1** (On) **EXIT**.
2. Use the cursor keys to move the highlighting to the SUB cell of the list you want to name.

	List 1	List 2	List 3	List 4
SUB				
1				
2				
3				
4				

At the bottom of the screen are buttons: GRAPH, CALC, TEST, INTR, DIST, and a right arrow.

3. Type in the name and then press **EXE**.
 - To type in a name using alpha characters, press **SHIFT** **ALPHA** to enter the ALPHA-LOCK mode.

Example: YEAR

2 (Y) **COS** (E) **X,θ,T** (A) **6** (R) **EXE**

	List 1	List 2	List 3	List 4
SUB	YEAR			
1	0			
2				
3				
4				

At the bottom of the screen are buttons: GRAPH, CALC, TEST, INTR, DIST, and a right arrow.

- The following operation displays a sub name in the **Run-Matrix** mode.

[SHIFT] [MENU] (SET UP) [F2] (Line) [EXIT]
 [SHIFT] [1] (List) n [SHIFT] [+ ([) 0 [SHIFT] [- (]) [EXE]
 (n = list number from 1 to 26)

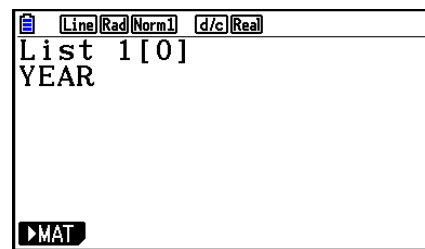

- Though you can input up to 8 bytes for the sub name, only the characters that can fit within the List Editor cell will be displayed.
- The List Editor SUB cell is not displayed when “Off” is selected for “Sub Name” on the Setup screen.

■ Changing the Data Color

You can change the color of data input into an individual cell or for all of the data input in a particular list.

• To change the data color in a specific cell

- Use the cursor keys to move the highlighting to the cell whose character color you want to change.

- Be sure to select a cell that already contains input data. You will not be able to perform the next step if you select a cell that does not contain any input data.

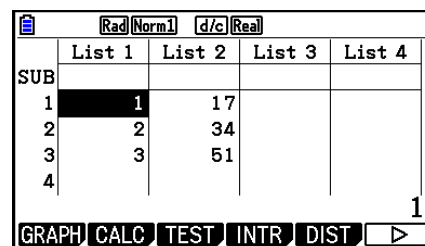

- Press [SHIFT] [5] (FORMAT) to display the color selection dialog box.

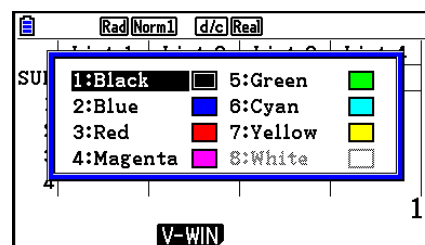

- Use the cursor keys to move the highlighting to the desired color and then press [EXE].

- You also can select an option by pressing the number key that corresponds to the number to the left of the desired option.

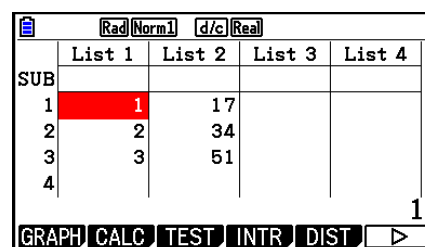

• To change the color of all the data in a particular list

1. Use the cursor keys to move the highlighting to the list name of the list whose character color you want to change.
 - Be sure to select a list that already contains input data. You will not be able to perform the next step if you select a list that does not contain any input data.

The screenshot shows the TI-84 Plus list editor interface. At the top, there are mode indicators: 'Rad' (selected), '(Norm1)', 'd/c', and '(Real)'. Below this is a table with four columns: 'List 1', 'List 2', 'List 3', and 'List 4'. The 'List 2' column is highlighted in black. The table contains the following data:

SUB	SEQ	POINT		
1	1	17		
2	2	34		
3	3	51		
4				

At the bottom of the screen, there is a menu bar with the following options: 'GRAPH', 'CALC', 'TEST', 'INTR', 'DIST', and a right arrow.

2. Press **SHIFT** **5** (FORMAT) to display the color selection dialog box.
3. Use the cursor keys to move the highlighting to the desired color and then press **EXE**.

- Changing the character color affects only cells that already contain input data. After performing this operation, any data input into any cell that did not previously contain data will be the default color (black). Note that this operation does not change the color of the sub name.

The screenshot shows the TI-84 Plus list editor interface, similar to the previous one. The 'List 2' column is highlighted in black. The data in the 'POINT' column (17, 34, 51) is now displayed in red. The rest of the interface, including the mode indicators and the bottom menu bar, is the same as in the previous screenshot.

■ Sorting List Values

You can sort lists into either ascending or descending order. The highlighting can be located in any cell of the list.

• To sort a single list

Ascending order

1. While the lists are on the screen, press **F6** (\triangleright) **F1** (TOOL) **F1** (SORTASC).
2. The prompt “How Many Lists?:” appears to ask how many lists you want to sort. Here we will input 1 to indicate we want to sort only one list.

1 **EXE**

3. In response to the “Select List List No:” prompt, input the number of the list you want to sort.

1 **EXE**

Descending order

Use the same procedure as that for the ascending order sort. The only difference is that you should press **F2** (SORTDES) in place of **F1** (SORTASC).

• To sort multiple lists

You can link multiple lists together for a sort so that all of their cells are rearranged in accordance with the sorting of a base list. The base list is sorted into either ascending order or descending order, while the cells of the linked lists are arranged so that the relative relationship of all the rows is maintained.

Ascending order

1. While the lists are on the screen, press **F6**(▷)**F1**(TOOL)**F1**(SORTASC).
2. The prompt “How Many Lists?:” appears to ask how many lists you want to sort. Here we will sort one base list linked to one other list, so we should input 2.

2 **EXE**

3. In response to the “Select Base List List No:” prompt, input the number of the list you want to sort into ascending order. Here we will specify List 1.

1 **EXE**

4. In response to the “Select Second List List No:” prompt, input the number of the list you want to link to the base list. Here we will specify List 2.

2 **EXE**

Descending order

Use the same procedure as that for the ascending order sort. The only difference is that you should press **F2**(SORTDES) in place of **F1**(SORTASC).

- You can specify a value from 1 to 6 as the number of lists for sorting.
- If you specify a list more than once for a single sort operation, an error occurs.
An error also occurs if lists specified for sorting do not have the same number of values (rows).

2. Manipulating List Data

List data can be used in arithmetic and function calculations. In addition, various list data manipulation functions make manipulation of list data quick and easy.

You can use list data manipulation functions in the **Run-Matrix**, **Statistics**, **Table**, **Equation** and **Program** modes.

■ Accessing the List Data Manipulation Function Menu

All of the following examples are performed after entering the **Run-Matrix** mode.

Press $\boxed{\text{OPTN}}$ and then $\boxed{\text{F1}}$ (LIST) to display the list data manipulation menu, which contains the following items.

- {List}/{Lst→Mat}/{Dim}/{Fill}/{Seq}/{Min}/{Max}/{Mean}/{Med}/{Augment}/{Sum}/{Prod}/{Cuml}/{%}/{ΔList}

Note that all closing parentheses at the end of the following operations can be omitted.

• To transfer list contents to Matrix Answer Memory [OPTN]-[LIST]-[Lst→Mat]

$\boxed{\text{OPTN}}$ $\boxed{\text{F1}}$ (LIST) $\boxed{\text{F2}}$ (Lst→Mat) $\boxed{\text{F1}}$ (List) <list number 1 - 26> $\boxed{\rightarrow}$ $\boxed{\text{F1}}$ (List) <list number 1 - 26> ...
 $\boxed{\rightarrow}$ $\boxed{\text{F1}}$ (List) <list number 1 - 26> $\boxed{\rightarrow}$ $\boxed{\text{EXE}}$

- You can skip input $\boxed{\text{F1}}$ (List) in the part of the above operation.
- All the lists must contain the same number of data items. If they don't, an error occurs.

Example: List → Mat (1, 2) $\boxed{\text{EXE}}$

Example **To transfer the contents of List 1 (2, 3, 6, 5, 4) to column 1, and the contents of List 2 (11, 12, 13, 14, 15) to column 2 of Matrix Answer Memory**

$\boxed{\text{AC}}$ $\boxed{\text{OPTN}}$ $\boxed{\text{F1}}$ (LIST) $\boxed{\text{F2}}$ (Lst→Mat)
 $\boxed{\text{F1}}$ (List) $\boxed{1}$ $\boxed{\rightarrow}$ $\boxed{\text{F1}}$ (List) $\boxed{2}$ $\boxed{\rightarrow}$ $\boxed{\text{EXE}}$

Math	Rad	Norm1	d/c	Real
LIST → Mat (LIST 1, LIST 2)				
	2	11		
	3	12		
	6	13		
	5	14		
	4	15		

• To count the number of data items in a list [OPTN]-[LIST]-[Dim]

$\boxed{\text{OPTN}}$ $\boxed{\text{F1}}$ (LIST) $\boxed{\text{F3}}$ (Dim) $\boxed{\text{F1}}$ (List) <list number 1 - 26> $\boxed{\text{EXE}}$

- The number of cells a list contains is its “dimension.”

Example **To count the number of values in List 1 (36, 16, 58, 46, 56)**

$\boxed{\text{AC}}$ $\boxed{\text{OPTN}}$ $\boxed{\text{F1}}$ (LIST) $\boxed{\text{F3}}$ (Dim)
 $\boxed{\text{F1}}$ (List) $\boxed{1}$ $\boxed{\text{EXE}}$

Math	Rad	Norm1	d/c	Real
Dim List 1				
				5

• **To create a list by specifying the number of data items** [OPTN]-[LIST]-[Dim]

Use the following procedure to specify the number of data in the assignment statement and create a list.

<number of data n > \rightarrow [OPTN] [F1] (LIST) [F3] (Dim) [F1] (List) <list number 1 - 26> [EXE] ($n = 1 - 999$)

Example To create five data items (each of which contains 0) in List 1

[AC] [5] \rightarrow [OPTN] [F1] (LIST) [F3] (Dim)
[F1] (List) [1] [EXE]

You can view the newly created list by entering the **Statistics** mode.

	Rad(Norm1)	d/c(Real)		
	List 1	List 2	List 3	List 4
SUB				
1	0			
2	0			
3	0			
4	0			

• **To replace all data items with the same value** [OPTN]-[LIST]-[Fill()]

[OPTN] [F1] (LIST) [F4] (Fill() <value> \rightarrow [F1] (List) <list number 1 - 26> [EXE]

Example To replace all data items in List 1 with the number 3

[AC] [OPTN] [F1] (LIST) [F4] (Fill()
[3] \rightarrow [F1] (List) [1] [EXE]

The following shows the new contents of List 1.

[Math] [Rad] [Norm1] [d/c] [Real]
Fill(3, List 1)
{3, 3, 3, 3, 3}

	Rad(Norm1)	d/c(Real)		
	List 1	List 2	List 3	List 4
SUB				
1	3			
2	3			
3	3			
4	3			

• **To generate a sequence of numbers** [OPTN]-[LIST]-[Seq]

[OPTN] [F1] (LIST) [F5] (Seq) <expression> \rightarrow <variable name> \rightarrow <start value> \rightarrow <end value>
 \rightarrow <increment> [EXE]

• The result of this operation is stored in ListAns Memory.

Example To input the number sequence $1^2, 6^2, 11^2$, into a list, using the function $f(x) = X^2$. Use a starting value of 1, an ending value of 11, and an increment of 5.

[AC] [OPTN] [F1] (LIST) [F5] (Seq) [X,θ,T] [x²] \rightarrow
[X,θ,T] \rightarrow [1] \rightarrow [1] \rightarrow [5] [EXE]

[Math] [Rad] [Norm1] [d/c] [Real]
Seq(x², x, 1, 11, 5)
{1, 36, 121}

Specifying an ending value of 12, 13, 14, or 15 produces the same result as shown above since they are less than the value produced by the next increment (16).

• To find the minimum value in a list

[OPTN]-[LIST]-[Min]

[OPTN] [F1] (LIST) [F6] (▷) [F1] (Min) [F6] (▷) [F6] (▷) [F1] (List) <list number 1 - 26> [] [EXE]

Example To find the minimum value in List 1 (36, 16, 58, 46, 56)

[AC] [OPTN] [F1] (LIST) [F6] (▷) [F1] (Min)
[F6] (▷) [F6] (▷) [F1] (List) [1] [] [EXE]

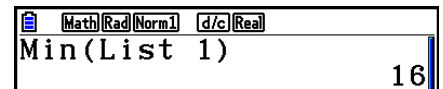

Math Rad Norm1 d/c Real
Min(List 1) 16

• To find which of two lists contains the greatest value

[OPTN]-[LIST]-[Max]

[OPTN] [F1] (LIST) [F6] (▷) [F2] (Max) [F6] (▷) [F6] (▷) [F1] (List) <list number 1 - 26> [] [F1] (List)
<list number 1 - 26> [] [EXE]

- The two lists must contain the same number of data items. If they don't, an error occurs.
- The result of this operation is stored in ListAns Memory.

Example To find whether List 1 (75, 16, 98, 46, 56) or List 2 (35, 59, 58, 72, 67) contains the greatest value

[OPTN] [F1] (LIST) [F6] (▷) [F2] (Max)
[F6] (▷) [F6] (▷) [F1] (List) [1] [] [F1] (List) [2] [] [EXE]

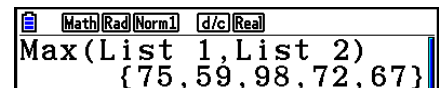

Math Rad Norm1 d/c Real
Max(List 1, List 2)
{75, 59, 98, 72, 67}

• To calculate the mean of data items

[OPTN]-[LIST]-[Mean]

[OPTN] [F1] (LIST) [F6] (▷) [F3] (Mean) [F6] (▷) [F6] (▷) [F1] (List) <list number 1 - 26> [] [EXE]

Example To calculate the mean of data items in List 1 (36, 16, 58, 46, 56)

[AC] [OPTN] [F1] (LIST) [F6] (▷) [F3] (Mean)
[F6] (▷) [F6] (▷) [F1] (List) [1] [] [EXE]

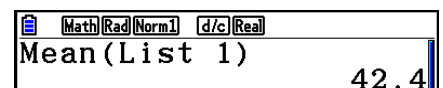

Math Rad Norm1 d/c Real
Mean(List 1) 42.4

• To calculate the median of data items of specified frequency

[OPTN]-[LIST]-[Med]

This procedure uses two lists: one that contains values and one that indicates the frequency (number of occurrences) of each value. The frequency of the data in Cell 1 of the first list is indicated by the value in Cell 1 of the second list, etc.

- The two lists must contain the same number of data items. If they don't, an error occurs.

[OPTN] [F1] (LIST) [F6] (▷) [F4] (Med) [F6] (▷) [F6] (▷) [F1] (List) <list number 1 - 26 (data)> [] [F1] (List)
<list number 1 - 26 (frequency)> [] [EXE]

Example To calculate the median of values in List 1 (36, 16, 58, 46, 56), whose frequency is indicated by List 2 (75, 89, 98, 98, 72, 67)

AC OPTN F1 (LIST) F6 (▷) F4 (Med)
 F6 (▷) F6 (▷) F1 (List) 1 ,
 F1 (List) 2) EXE

Math	Rad	Norm1	d/c	Real
Median(List 1, List 2				▶
				46

• **To combine lists** [OPTN]-[LIST]-[Augment]

• You can combine two different lists into a single list. The result of a list combination operation is stored in ListAns memory.

OPTN F1 (LIST) F6 (▷) F5 (Augment) F6 (▷) F6 (▷) F1 (List) <list number 1 - 26> , F1 (List) <list number 1 - 26>) EXE

Example To combine the List 1 (-3, -2) and List 2 (1, 9, 10)

AC OPTN F1 (LIST) F6 (▷) F5 (Augment)
 F6 (▷) F6 (▷) F1 (List) 1 ,
 F1 (List) 2) EXE

Math	Rad	Norm1	d/c	Real
Augment(List 1, List				▶
				{-3, -2, 1, 9, 10}

• **To calculate the sum of data items in a list** [OPTN]-[LIST]-[Sum]

OPTN F1 (LIST) F6 (▷) F6 (▷) F1 (Sum) F6 (▷) F1 (List) <list number 1 - 26> EXE

Example To calculate the sum of data items in List 1 (36, 16, 58, 46, 56)

AC OPTN F1 (LIST) F6 (▷) F6 (▷) F1 (Sum)
 F6 (▷) F1 (List) 1 EXE

Math	Rad	Norm1	d/c	Real
Sum List 1				
				212

• **To calculate the product of values in a list** [OPTN]-[LIST]-[Prod]

OPTN F1 (LIST) F6 (▷) F6 (▷) F2 (Prod) F6 (▷) F1 (List) <list number 1 - 26> EXE

Example To calculate the product of values in List 1 (2, 3, 6, 5, 4)

AC OPTN F1 (LIST) F6 (▷) F6 (▷) F2 (Prod)
 F6 (▷) F1 (List) 1 EXE

Math	Rad	Norm1	d/c	Real
Prod List 1				
				720

• To calculate the cumulative frequency of each data item [OPTN]-[LIST]-[CumI]

[OPTN] [F1] (LIST) [F6] (▷) [F6] (▷) [F3] (CumI) [F6] (▷) [F1] (List) <list number 1 - 26> [EXE]

- The result of this operation is stored in ListAns Memory.

Example To calculate the cumulative frequency of each data item in List 1
(2, 3, 6, 5, 4)

[AC] [OPTN] [F1] (LIST) [F6] (▷) [F6] (▷) [F3] (CumI)

[F6] (▷) [F1] (List) [1] [EXE]

- ① $2+3=$
- ② $2+3+6=$
- ③ $2+3+6+5=$
- ④ $2+3+6+5+4=$

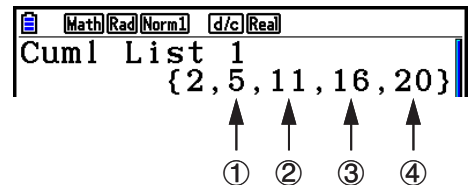

• To calculate the percentage represented by each data item [OPTN]-[LIST]-[%]

[OPTN] [F1] (LIST) [F6] (▷) [F6] (▷) [F4] (%) [F6] (▷) [F1] (List) <list number 1 - 26> [EXE]

- The above operation calculates what percentage of the list total is represented by each data item.
- The result of this operation is stored in ListAns Memory.

Example To calculate the percentage represented by each data item in List 1
(2, 3, 6, 5, 4)

[AC] [OPTN] [F1] (LIST) [F6] (▷) [F6] (▷) [F4] (%)

[F6] (▷) [F1] (List) [1] [EXE]

- ① $2/(2+3+6+5+4) \times 100 =$
- ② $3/(2+3+6+5+4) \times 100 =$
- ③ $6/(2+3+6+5+4) \times 100 =$
- ④ $5/(2+3+6+5+4) \times 100 =$
- ⑤ $4/(2+3+6+5+4) \times 100 =$

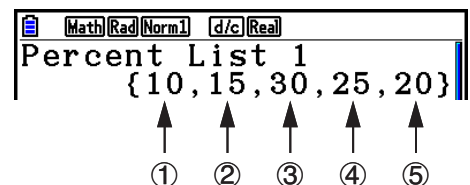

• To calculate the differences between neighboring data inside a list

[OPTN]-[LIST]-[ΔList]

[OPTN] [F1] (LIST) [F6] (▷) [F6] (▷) [F5] (ΔList) <list number 1 - 26> [EXE]

- The result of this operation is stored in ListAns Memory.

Example To calculate the difference between the data items in List 1 (1, 3, 8, 5, 4)

[AC] [OPTN] [F1] (LIST) [F6] (▷) [F6] (▷) [F5] (ΔList)

[1] [EXE]

- ① 3 - 1 =
- ② 8 - 3 =
- ③ 5 - 8 =
- ④ 4 - 5 =

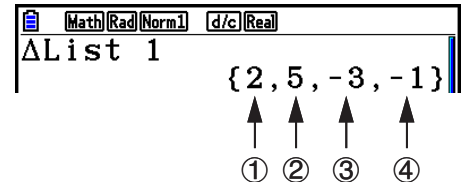

- You can specify the storage location in list memory for a calculation result produced by a list calculation whose result is stored in ListAns memory. For example, specifying “ΔList 1 → List 2” will store the result of ΔList 1 in List 2.
- The number of cells in the new ΔList is one less than the number of cells in the original list.
- An error occurs if you execute ΔList for a list that has no data or only one data item.

3. Arithmetic Calculations Using Lists

You can perform arithmetic calculations using two lists or one list and a numeric value.

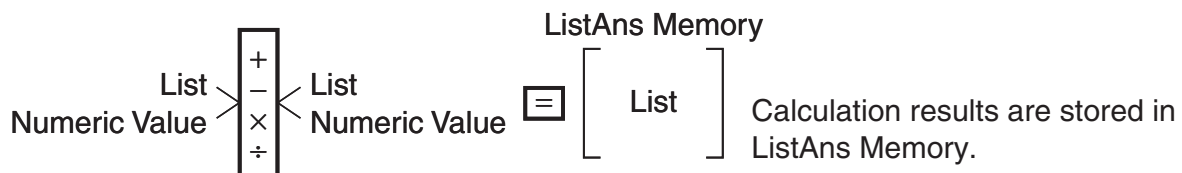

■ Error Messages

- A calculation involving two lists performs the operation between corresponding cells. Because of this, an error occurs if the two lists do not have the same number of values (which means they have different “dimensions”).
- An error occurs whenever an operation involving any two cells generates a mathematical error.

■ Inputting a List into a Calculation

There are three methods you can use to input a list into a calculation.

- Specification of the list number of a list created with List Editor.
- Specification of the sub name of a list created with List Editor.
- Direct input of a list of values.

● To specify the list number of a list created with List Editor

1. In the **Run-Matrix** mode, perform the following key operation.

AC **OPTN** **F1** (LIST) **F1** (List)

- Enter the “List” command.
2. Enter the list number (integer from 1 to 26) you want to specify.

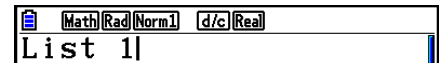

Calculator screen showing the Run-Matrix mode menu with 'List 1' selected. The menu options are Math, Rad, Norm1, d/c, and Real.

● To specify the sub name of a list created with List Editor

1. In the **Run-Matrix** mode, perform the following key operation.

AC **OPTN** **F1** (LIST) **F1** (List)

- Enter the “List” command.
2. Enter the sub name of the list you want to specify, enclosed in double quotes (" ").

Example: "QTY"

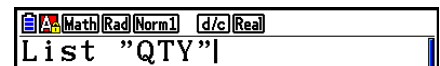

Calculator screen showing the Run-Matrix mode menu with 'List "QTY"' selected. The menu options are Math, Rad, Norm1, d/c, and Real.

● To directly input a list of values

You can also directly input a list of values using {, }, and **↵**.

Example To input the list: 56, 82, 64

SHIFT **⌫** ({) **5** **6** **↵** **8** **2** **↵**
6 **4** **SHIFT** **⌫** (})

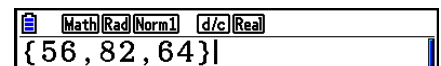

Calculator screen showing the Run-Matrix mode menu with '{56, 82, 64}' selected. The menu options are Math, Rad, Norm1, d/c, and Real.

• To assign the contents of one list to another list

Use \rightarrow to assign the contents of one list to another list.

Example To assign the contents of List 3 (41, 65, 22) to List 1

OPTN F1 (LIST) F1 (List) 3 \rightarrow F1 (List) 1 EXE

In place of F1 (LIST) F1 (List) 3 operation in the above procedure, you could input SHIFT X ({) 4 1 2 6 5 2 2 SHIFT $\text{}$ (}).

• To recall the value in a specific list cell

You can recall the value in a specific list cell and use it in a calculation. Specify the cell number by enclosing it inside square brackets.

Example To calculate the sine of the value stored in Cell 3 of List 2

sin OPTN F1 (LIST) F1 (List) 2 SHIFT + ([) 3 SHIFT - (]) EXE

• To input a value into a specific list cell

You can input a value into a specific list cell inside a list. When you do, the value that was previously stored in the cell is replaced with the new value you input.

Example To input the value 25 into Cell 2 of List 3

2 5 \rightarrow OPTN F1 (LIST) F1 (List) 3 SHIFT + ([) 2 SHIFT - (]) EXE

■ Recalling List Contents

Example To recall the contents of List 1

OPTN F1 (LIST) F1 (List) 1 EXE

- The above operation displays the contents of the list you specify and also stores them in ListAns Memory. You can then use the ListAns Memory contents in a calculation.

• To use list contents in ListAns Memory in a calculation

Example To multiply the list contents in ListAns Memory by 36

OPTN F1 (LIST) F1 (List) SHIFT (-) (Ans) X 3 6 EXE

- The operation OPTN F1 (LIST) F1 (List) SHIFT (-) (Ans) recalls ListAns Memory contents.
- This operation replaces current ListAns Memory contents with the result of the above calculation.

■ Graphing a Function Using a List

When using the graphing functions of this calculator, you can input a function such as $Y1 = \text{List 1} \times X$. If List 1 contains the values 1, 2, 3, this function will produce three graphs: $Y = X$, $Y = 2X$, $Y = 3X$.

There are certain limitations on using lists with graphing functions.

■ Inputting Scientific Calculations into a List

You can use the numeric table generation functions in the **Table** mode to input values that result from certain scientific function calculations into a list. To do this, first generate a table and then use the list copy function to copy the values from the table to the list.

Example To use the Table mode to create a number table for the formula ($Y1 = x^2 - 1$), and then copy the table to List 1 in the Statistics mode

1. In the **Table** mode, input the formula $Y1 = x^2 - 1$.
2. Create the number table.

X	Y1
1	0
2	3
3	8
4	15

3. Use \blacktriangleright to move the highlighting to the Y1 column.
4. Press OPTN F1 (LISTMEM).

5. Press 1 EXE .
6. Enter the **Statistics** mode to confirm that **Table** mode column Y1 has been copied to List 1.

	List 1	List 2	List 3	List 4
SUB				
1	0			
2	3			
3	8			
4	15			

■ Performing Scientific Function Calculations Using a List

Lists can be used just as numeric values are in scientific function calculations. When the calculation produces a list as a result, the list is stored in ListAns Memory.

Example **To use List 3 (41, 65, 22) to perform sin (List 3)**

Use radians as the angle unit.

$\boxed{\sin}$ $\boxed{\text{OPTN}}$ $\boxed{\text{F1}}$ (LIST) $\boxed{\text{F1}}$ (List) $\boxed{3}$ $\boxed{\text{EXE}}$

4. Switching between List Files

You can store up to 26 lists (List 1 to List 26) in each file (File 1 to File 6). A simple operation lets you switch between list files.

• To switch between list files

1. From the Main Menu, enter the **Statistics** mode.

Press $\boxed{\text{SHIFT}}$ $\boxed{\text{MENU}}$ (SET UP) to display the **Statistics** mode Setup screen.

2. Use \blacktriangledown to highlight “List File”.

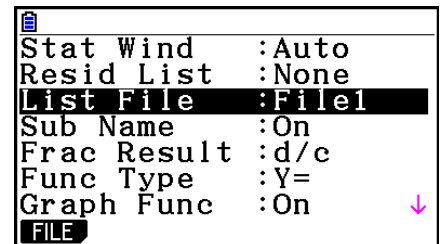

3. Press $\boxed{\text{F1}}$ (FILE) and then input the number of the list file you want to use.

Example **To select File 3**

$\boxed{\text{F1}}$ (FILE) $\boxed{3}$

$\boxed{\text{EXE}}$

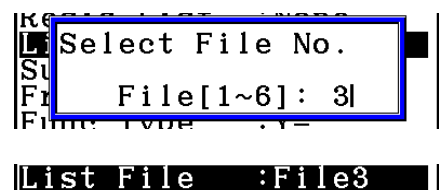

All subsequent list operations are applied to the lists contained in the file you select (List File 3 in the above example).

5. Using CSV Files

You can import the contents of a CSV file stored with this calculator or transferred from a computer into the List Editor. You also can save the contents of all the list data in the List Editor as a CSV file. These operations are performed using the CSV function menu, which appears when you press **F6**(▷)**F6**(▷)**F1**(CSV) while the List Editor is on the display.

LOAD **SAVE-AS** **SET**

■ Import CSV File Requirements

A CSV file that has been output from the List Editor, Matrix Editor (page 2-42), or Spreadsheet (page 9-4), or a CSV file transferred from a computer to storage memory can be used for import. The following types of CSV files are supported for import.

- A CSV file that uses the comma (,) or semi-colon (;) as its delimiter, and the period (.) or comma (,) as its decimal point. A CSV file that uses the tab as its delimiter is not supported.
- CR, LF and CRLF are supported for the line break code.
- When importing a CSV file to the calculator, if the data in Line 1 of each column of the file (or Line 1 of Column 1 of the file) contains double quotation marks (") or a single quotation mark ('), Line 1 of all of the columns of the CSV file will be ignored, and data will be input starting from Line 2.

For information about transferring files from a computer to the calculator, see “Chapter 13 Data Communication”.

■ Transferring Data between Lists and CSV Files

• To import the contents of a CSV file to the List Editor

1. Prepare the CSV file you want to import.
 - See “Import CSV File Requirements” described above.
2. While the List Editor is on the display, press **F6**(▷)**F6**(▷)**F1**(CSV) to display the CSV function menu.
3. What you should do next depends on the type of CSV file import operation you want to perform.

To start import from a specific row:	To overwrite the entire contents of the List Editor:
Use the cursor keys to move the highlighting to the row from which you want to start importing data and then press F1 (LOAD) F1 (LIST).	Press F1 (LOAD) F2 (FILE).

4. On the select file dialog box that appears, use ▲ and ▼ to move the highlighting to the file you want to import and then press **EXE**.
- This imports the contents of the CSV file you specified to the List Editor.
 - If you pressed **F1**(LOAD)**F1**(LIST) in step 3, import starts from the row where the highlighted cell is located, overwriting List Editor rows only with the same number of rows contained in the CSV file.

Examples

List Editor Original Content

List 1	List 2	List 3	List 4	List 5
1	1	1	1	1
2	2	2	2	2
3	3	3	3	3
4	4	4	4	4

Highlighting

Import CSV File Data

20	20	20
30	30	30
40	40	40

List Editor Content following Import

List 1	List 2	List 3	List 4	List 5
1	20	20	20	1
2	30	30	30	2
3	40	40	40	3
4				4

Important!

Attempting to import the following types of CSV files will result in an error.

- A CSV file that includes data that cannot be converted. In this case, an error message will appear showing the location in the CSV file (Example: row 2, column 3) where the data that cannot be converted is located.
- A CSV file with more than 26 columns or 999 rows. In this case, an “Invalid Data Size” error will occur.

• To save the contents of all the list data in the List Editor as a single CSV file

1. While the List Editor is on the display, press **F6**(▷)**F6**(▷)**F1**(CSV) to display the CSV function menu.
2. Press **F2**(SAVE•AS).
 - This displays a folder selection screen.
3. Select the folder where you want to save the CSV file.
 - To store the CSV file in the root directory, highlight “ROOT”.
 - To store the CSV file in a folder, use ▲ and ▼ to move the highlighting to the desired folder and then press **F1**(OPEN).
4. Press **F1**(SAVE•AS).
5. Input up to eight characters for the file name and then press **EXE**.

Important!

- The sub name line of the List Editor is not saved in the CSV file.
- When saving list data to a CSV file, some data is converted as described below.
 - Complex number data: Only the real number part is extracted.
 - Fraction data: Converted to calculation line format (Example: $2\downarrow 3\downarrow 4 \rightarrow =2+3/4$)
 - $\sqrt{\quad}$ and π data: Converted to a decimal value (Example: $\sqrt{3} \rightarrow 1.732050808$)

■ Specifying the CSV File Delimiter Symbol and Decimal Point

When importing a CSV file that has been transferred from a computer to the calculator, specify the delimiter symbol and decimal point in accordance with the settings you specified on the application when outputting the CSV file. The comma (,) or semi-colon (;) can be specified for the delimiter, while the period (.) or comma (,) can be specified as the decimal point.

• To specify the CSV file delimiter symbol and decimal point

1. While the List Editor is on the display, press **F6**(▷)**F6**(▷)**F1**(CSV) to display the CSV function menu.
2. Press **F3**(SET).
 - This displays the CSV format setting screen.
3. Use the ▲ and ▼ keys to move the highlighting to “CSV Separator” and then press **F1**(,) or **F2**(;).
4. Use the ▲ and ▼ keys to move the highlighting to “CSV Decimal Symbol” and then press **F1**(.) or **F2**(,).
 - If you specified **F1**(,) in step 3, you will not be able to specify **F2**(,) here.
5. After the setting is the way you want, press **EXIT**.

Chapter 4 Equation Calculations

From the Main Menu, enter the **Equation** mode.

- {SIMUL} ... {linear equation with 2 to 6 unknowns}
- {POLY} ... {degree 2 to 6 equation}
- {SOLVER} ... {Solve calculation}

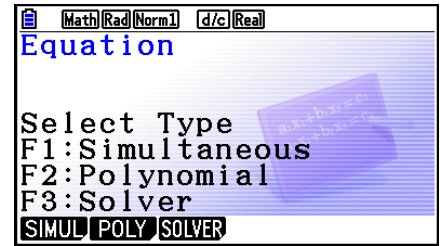

1. Simultaneous Linear Equations

You can solve simultaneous linear equations with two to six unknowns.

- Simultaneous Linear Equation with Two Unknowns:

$$a_1x + b_1y = c_1$$

$$a_2x + b_2y = c_2$$

- Simultaneous Linear Equation with Three Unknowns:

$$a_1x + b_1y + c_1z = d_1$$

$$a_2x + b_2y + c_2z = d_2$$

$$a_3x + b_3y + c_3z = d_3$$

⋮

1. From the Main Menu, enter the **Equation** mode.
2. Select the SIMUL (Simultaneous) mode, and specify the number of unknowns (variables). You can specify from 2 to 6 unknowns.
3. Sequentially input the coefficients.
 - The cell that is currently selected for input is highlighted. Each time you input a coefficient, the highlighting shifts in the sequence:
 $a_1 \rightarrow b_1 \rightarrow c_1 \rightarrow \dots \rightarrow a_n \rightarrow b_n \rightarrow c_n$ ($n = 2$ to 6)
 - You can also input fractions and values assigned to variables as coefficients.
 - You can cancel the value you are inputting for the current coefficient by pressing **EXIT** at any time before you press **EXE** to store the coefficient value. This returns to the coefficient to what it was before you input anything. You can then input another value if you want.
 - To change the value of a coefficient that you already stored by pressing **EXE**, move the cursor to the coefficient you want to edit. Next, input the value you want to change to.
 - Pressing **F3** (CLEAR) clears all coefficients to zero.
4. Solve the equations.

Example To solve the following simultaneous linear equations for x , y , and z

$$\begin{aligned} 4x + y - 2z &= -1 \\ x + 6y + 3z &= 1 \\ -5x + 4y + z &= -7 \end{aligned}$$

- ① **MENU** Equation
- ② **F1** (SIMUL)
- F2** (3)
- ③ **4** **EXE** **1** **EXE** **(-)** **2** **EXE** **(-)** **1** **EXE**
1 **EXE** **6** **EXE** **3** **EXE** **1** **EXE**
(-) **5** **EXE** **4** **EXE** **1** **EXE** **(-)** **7** **EXE**
- ④ **F1** (SOLVE)

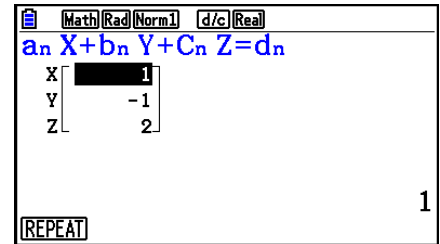
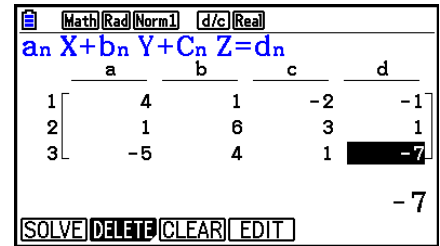

- Internal calculations are performed using a 15-digit mantissa, but results are displayed using a 10-digit mantissa and a 2-digit exponent.
- Simultaneous linear equations are solved by inverting the matrix containing the coefficients of the equations. For example, the following shows the solution (x, y, z) of a simultaneous linear equation with three unknowns.

$$\begin{bmatrix} x \\ y \\ z \end{bmatrix} = \begin{bmatrix} a_1 & b_1 & c_1 \\ a_2 & b_2 & c_2 \\ a_3 & b_3 & c_3 \end{bmatrix}^{-1} \begin{bmatrix} d_1 \\ d_2 \\ d_3 \end{bmatrix}$$

Because of this, precision is reduced as the value of the determinant approaches zero. Also, simultaneous equations with three or more unknowns may take a very long time to solve.

- The message “No Solution” appears if there is no solution. The message “Ma ERROR” appears if a solution could not be found.
- The message “Infinitely Many Solutions” appears along with the formula if there are an infinite number of solutions.

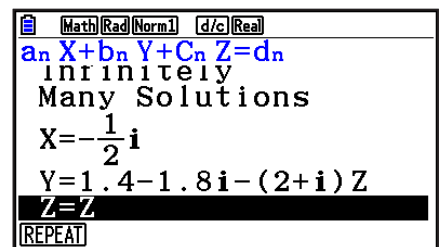

- After calculation is complete, you can press **F1** (REPEAT), change coefficient values, and then re-calculate.

2. High-order Equations from 2nd to 6th Degree

Your calculator can be used to solve high-order equations from 2nd to 6th degree.

- Quadratic Equation: $ax^2 + bx + c = 0$ ($a \neq 0$)
- Cubic Equation: $ax^3 + bx^2 + cx + d = 0$ ($a \neq 0$)
- Quartic Equation: $ax^4 + bx^3 + cx^2 + dx + e = 0$ ($a \neq 0$)
- \vdots

1. From the Main Menu, enter the **Equation** mode.

2. Select the POLY (Polynomial) mode, and specify the degree of the equation.

You can specify a degree 2 to 6.

3. Sequentially input the coefficients.

- The cell that is currently selected for input is highlighted. Each time you input a coefficient, the highlighting shifts in the sequence:

$$a \rightarrow b \rightarrow c \rightarrow \dots$$

- You can also input fractions and values assigned to variables as coefficients.
- You can cancel the value you are inputting for the current coefficient by pressing **EXIT** at any time before you press **EXE** to store the coefficient value. This returns to the coefficient to what it was before you input anything. You can then input another value if you want.
- To change the value of a coefficient that you already stored by pressing **EXE**, move the cursor to the coefficient you want to edit. Next, input the value you want to change to.
- Pressing **F3** (CLEAR) clears all coefficients to zero.

4. Solve the equations.

Example To solve the cubic equation (Angle unit = Rad)

$$x^3 - 2x^2 - x + 2 = 0$$

- ① **MENU** Equation
- ② **F2** (POLY)
F2 (3)
- ③ **1** **EXE** **(-)** **2** **EXE** **(-)** **1** **EXE** **2** **EXE**
- ④ **F1** (SOLVE)

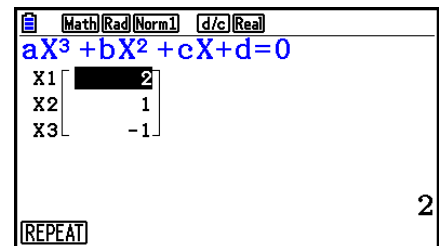

Multiple Solutions (Example: $x^3 + 3x^2 + 3x + 1 = 0$)

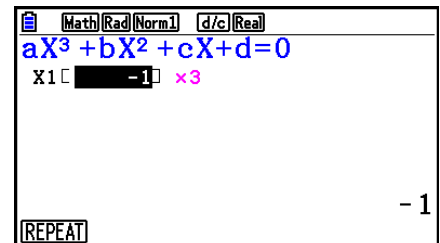

Complex Number Solution (Example: $x^3 + 2x^2 + 3x + 2 = 0$)

Complex Mode: Real (page 1-33)

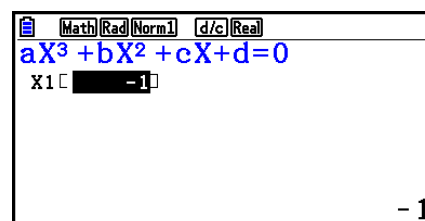

Complex Mode: $a + bi$

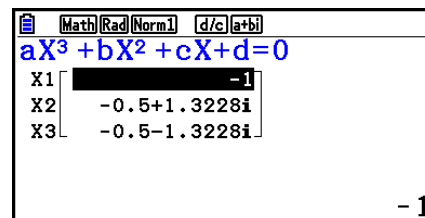

Complex Mode: $r \angle \theta$

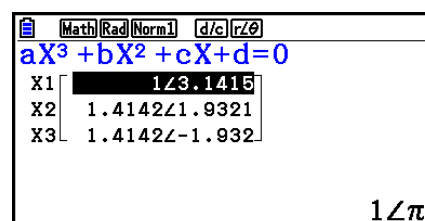

- Internal calculations are performed using a 15-digit mantissa, but results are displayed using a 10-digit mantissa and a 2-digit exponent.
- It may take considerable time for the calculation result of a high-order equation of 3rd degree or higher to appear on the display.
- An error occurs if the calculator is unable to find a solution.
- High-order equation calculations may not produce accurate results when the equation has multiple solutions.
- After calculation is complete, you can press **F1** (REPEAT), change coefficient values, and then re-calculate.

3. Solve Calculations

The Solve calculation mode lets you determine the value of any variable in a formula without having to solve the equation.

Important!

- You can input either an upper-case X (**ALPHA** **+** (X)) or lower-case x (**X,θ,T**) for variable X. Both “X” and “x” refer to the same variable.

1. From the Main Menu, enter the **Equation** mode.
2. Select the SOLVER mode, and input the equation as it is written.
 - If you do not input an equals sign, the calculator assumes that the expression is to the left of the equals sign, and there is a zero to the right.
 - An error occurs if you input more than one equals sign.

3. In the table of variables that appears on the display, input values for each variable.
 - You can also specify values for Upper and Lower to define the upper and lower limits of the range of solutions.
 - An error occurs if the solution falls outside the range you specify.
4. Select the variable for which you want to solve to obtain the solution.

“Lft” and “Rgt” indicate the left and right sides that are calculated using the solution.*1

*1 Solutions are approximated using Newton’s method. Lft and Rgt values are displayed for confirmation, because Newton’s method may produce results that are the real solution. The closer the difference between the Lft and Rgt values is to zero, the lower degree of error in the result.

Example **An object thrown into the air at initial velocity V takes time T to reach height H. Use the following formula to solve for initial velocity V when H = 14 (meters), T = 2 (seconds) and gravitational acceleration is G = 9.8 (m/s²).**
 $H = VT - 1/2 GT^2$

- ① **MENU** Equation
- ② **F3** (SOLVER)

ALPHA **F-D** (H) **SHIFT** **=** **ALPHA** **2** (V) **ALPHA** **÷** (T) **=**
(**1** **÷** **2** **)** **ALPHA** **a^{b/c}** (G) **ALPHA** **÷** (T) **x²** **EXE**
- ③ **1** **4** **EXE** (H = 14)
0 **EXE** (V = 0)
2 **EXE** (T = 2)
9 **.** **8** **EXE** (G = 9.8)
- ④ Press **▲** **▲** **▲** to highlight V = 0, and then press **F6** (SOLVE).

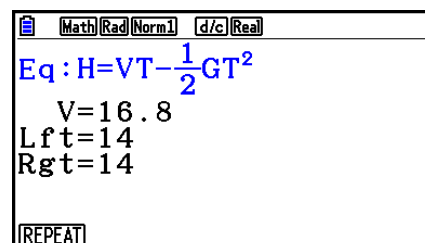
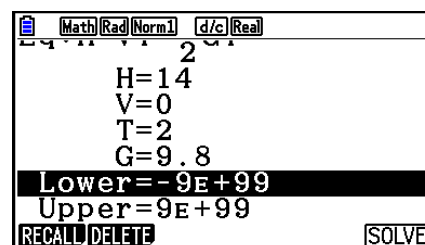

- The message “Retry” appears on the display when the calculator judges that convergence is not sufficient for the displayed results.
- A Solve operation will produce a single solution. Use POLY when you want to obtain multiple solutions for a high-order equation (such as $ax^2 + bx + c = 0$).

Chapter 5 Graphing

Select the icon in the Main Menu that suits the type of graph you want to draw or the type of table you want to generate.

- **Graph** ... General function graphing
- **Run-Matrix** ... Manual graphing (pages 5-25 to 5-29)
- **Table** ... Number table generation (pages 5-30 to 5-35)
- **Dyna Graph** ... Dynamic graphing (pages 5-40 to 5-43)
- **Recursion** ... Recursion graphing or number table generation (pages 5-43 to 5-48)
- **Conic Graphs** ... Conic section graphing (pages 5-48 and 5-49)

1. Sample Graphs

■ Graph Relation List Screen and Graph Color

A graph relation list screen (table relation list screen) like the one shown below appears first whenever you enter the **Graph**, **Dyna Graph**, or **Table** mode. You can use this screen to register functions to be used for drawing graphs and creating number tables.

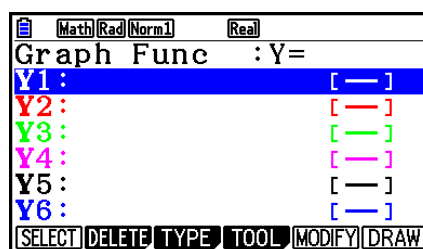

(Example: **Graph** mode)

Each line of the graph relation list screen is preset with a color, which represents the line color used when each function is graphed. When you draw a graph, it is drawn using the same color as the line where its function is registered.

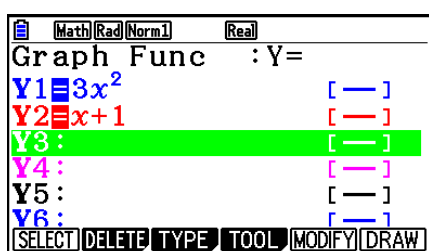

Graph relation list screen

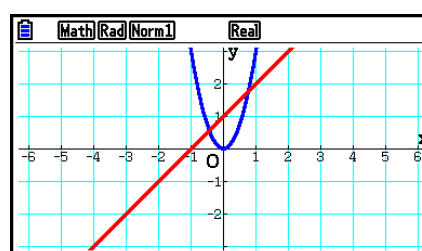

Graph screen

In the case of the **Table** mode, a number table is created in the same color as the line where its function is registered.

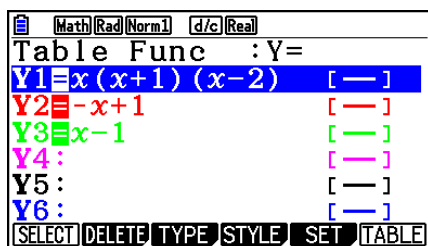

Table relation list screen



X	Y1	Y2	Y3
1	-2	0	0
2	0	-1	1
3	12	-2	2
4	40	-3	3

Table screen

- You can change the color used to draw the graph and the number table character color. For details, see “Changing Graph Properties” (page 5-15).

■ How to draw a simple graph (1)

To draw a graph, simply input the applicable function.

- From the Main Menu, enter the **Graph** mode.
- Input the function you want to graph.
Here you would use the V-Window to specify the range and other parameters of the graph.
See page 5-5.
- Draw the graph.

Example To graph $y = 3x^2$

- MENU** Graph
- 3** **X,θ,T** **x²** **EXE**
- F6** (DRAW) (or **EXE**)

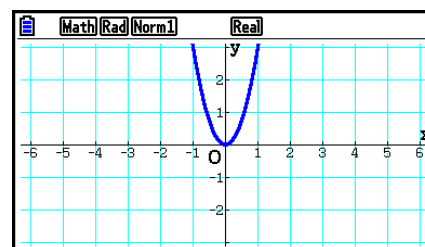

- Press **AC** to return to the screen in step 2 (graph relation list). After drawing a graph, you can toggle between the graph relation list and graph screen by pressing **SHIFT** **F6** (**G↔T**).

■ How to draw a simple graph (2)

You can store up to 20 functions in memory and then select the one you want for graphing.

1. From the Main Menu, enter the **Graph** mode.
2. Specify the function type and input the function whose graph you want to draw.
You can use the **Graph** mode to draw a graph for the following types of expressions: rectangular coordinate expression ($Y=f(x)$), polar coordinate expression, parametric function, rectangular coordinate expression ($X=f(y)$), inequality.

- F3**(TYPE) **F1**(Y=) ... rectangular coordinates ($Y=f(x)$ type)
- F2**(r=) ... polar coordinates
- F3**(Param) ... parametric function
- F4**(X=) ... rectangular coordinates ($X=f(y)$ type)
- F5**(CONVERT) **F1**(▶Y=) to **F5**(▶Y≤)
- F6**(▷) **F1**(▶X=) to **F5**(▶X≤) ... changes the function type
- F6**(▷) **F1**(Y>) to **F4**(Y≤) ... Y inequality on left side
- F6**(▷) **F6**(▷) **F1**(X>) to **F4**(X≤) ... X inequality on left side

Repeat this step as many times as required to input all of the functions you want.

Next you should specify which of the functions among those that are stored in memory you want to graph (see page 5-13).

3. Draw the graph.

- You can use the function menu that appears when you press **F4**(TOOL) **F1**(STYLE) in step 2 of the above procedure to select one of the following line styles for each graph.
 - F1**(—) ... Normal (initial default)
 - F2**(—) ... Thick (twice the thickness of Normal)
 - F3**(.....) ... Broken (thick broken)
 - F4**(.....) ... Dot (dotted)
 - F5**(—) ... Thin (one third the thickness of Normal)
- When simultaneously graphing multiple inequalities, you can use the “Ineq Type” setting on the Setup screen to specify either of two fill ranges.
 - F1**(Intsect) ... Fills areas only where the conditions of all of the graphed inequalities are satisfied.

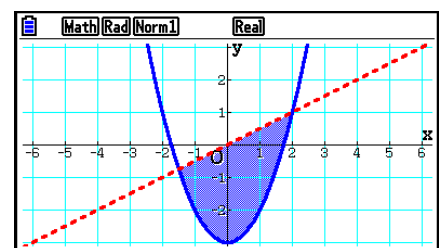

F2 (Union) Fills all areas where the conditions of the graphed inequalities are satisfied. This is the initial default.

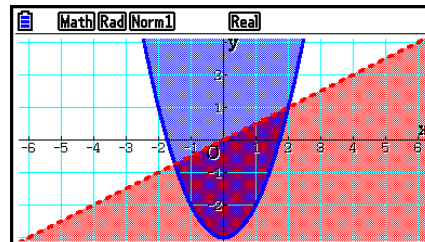

- Pressing **SHIFT** **5** (FORMAT) while the graph relation list screen or graph screen displays a dialog box that you can use to change the graph line style and graph line color. For details, see “Changing Graph Properties” (page 5-15).

Example 1 Input the functions shown below and draw their graphs.

$$Y1 = 2x^2 - 3, r2 = 3\sin 2\theta$$

- MENU** Graph
- F3** (TYPE) **F1** (Y=) **2** **X,θ,T** **x²** **=** **3** **EXE**
F3 (TYPE) **F2** (r=) **3** **sin** **2** **X,θ,T** **EXE**
- F6** (DRAW)

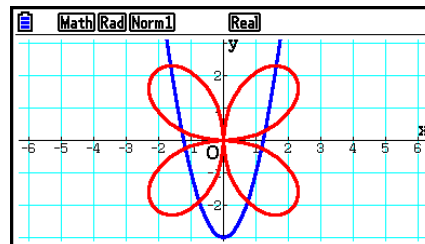

Example 2 To graph a trigonometric function using radians when the angle unit setting is degrees (Angle unit = Deg)

$$Y1 = \sin x^r$$

- MENU** Graph
- sin** **X,θ,T** **OPTN** **F6** (\triangleright) **F5** (ANGLE) **F2** (r) **EXE**
- F6** (DRAW)

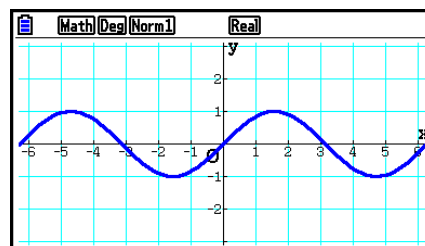

2. Controlling What Appears on a Graph Screen

■ V-Window (View Window) Settings

Use the View Window to specify the range of the x - and y -axes, and to set the spacing between the increments on each axis. You should always set the V-Window parameters you want to use before graphing.

• To configure V-Window settings

1. From the Main Menu, enter the **Graph** mode.
2. Press **[SHIFT]** **[F3]** (V-WIN) to display the V-Window setting screen.

Rectangular coordinate parameter

- Xmin/Xmax ... Minimum/maximum x -axis value
- Xscale ... Spacing of x -axis increments
- Xdot ... Value that corresponds to one x -axis dot
- Ymin/Ymax ... Minimum/maximum y -axis value
- Yscale ... Spacing of y -axis increments

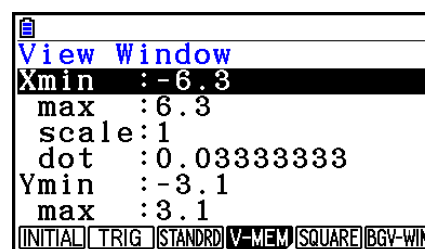

Polar coordinate parameter

- T θ min/T θ max ... Minimum/maximum T , θ values
- T θ ptch ... T , θ pitch

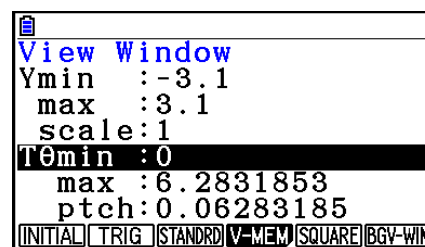

3. Press **[▼]** to move the highlighting and input an appropriate value for each parameter, pressing **[EXE]** after each.
 - **{INITIAL}**/**{TRIG}**/**{STANDRD}** ... V-Window {initial settings}/{initial settings using specified angle unit}/{standard settings}
 - **{V-MEM}**
 - **{STORE}**/**{RECALL}** ... V-Window setting {store}/{recall}
 - **{SQUARE}**
 - **{Y-BASE}**/**{X-BASE}** ... {fix y -axis setting and change x -axis setting}/{fix x -axis setting and change y -axis setting} so y -axis and x -axis scales are displayed as a 1-to-1 relationship
 - **{BGV-WIN}** ... Overwrites current V-Window settings with the V-Window settings saved in the background image file. This menu item appears only while a graph background image is open.
4. After settings are the way you want them, press **[EXIT]** or **[SHIFT]** **[EXIT]** (QUIT) to exit the V-Window setting screen.
 - Pressing **[EXE]** without inputting anything while **[◀]** is on the display exits the V-Window setting screen.

● V-Window Setting Precautions

- Inputting zero for $T\theta_{ptch}$ causes an error.
- Any illegal input (out of range value, negative sign without a value, etc.) causes an error.
- When $T\theta_{max}$ is less than $T\theta_{min}$, $T\theta_{ptch}$ becomes negative.
- You can input expressions (such as 2π) as V-Window parameters.
- When the V-Window setting produces an axis that does not fit on the display, the scale of the axis is indicated on the edge of the display closest to the origin.
- Changing the V-Window settings clears the graph currently on the display and replaces it with the new axes only.
- Changing the Xmin or Xmax value causes the Xdot value to be adjusted automatically. Changing the Xdot value causes the Xmax value to be adjusted automatically.
- A polar coordinate ($r =$) or parametric graph will appear coarse if the settings you make in the V-Window cause the $T\theta_{ptch}$ value to be too large, relative to the differential between the $T\theta_{min}$ and $T\theta_{max}$ settings. If the settings you make cause the $T\theta_{ptch}$ value to be too small relative to the differential between the $T\theta_{min}$ and $T\theta_{max}$ settings, on the other hand, the graph will take a very long time to draw.
- The following is the input range for V-Window parameters.
-9.999999999E 97 to 9.999999999E 97

■ V-Window Memory

You can store up to six sets of V-Window settings in V-Window memory for recall when you need them.

● To store V-Window settings

1. From the Main Menu, enter the **Graph** mode.
2. Press **SHIFT** **F3** (V-WIN) to display the V-Window setting screen, and input the values you want.
3. Press **F4** (V-MEM) **F1** (STORE) to display the pop-up window.
4. Press a number key to specify the V-Window memory where you want to save the settings, and then press **EXE**. Pressing **1** **EXE** stores the settings in V-Window Memory 1 (V-Win1).

• To recall V-Window memory settings

1. From the Main Menu, enter the **Graph** mode.
2. Press $\boxed{\text{SHIFT}} \boxed{\text{F3}}$ (V-WIN) to display the V-Window setting screen.
3. Press $\boxed{\text{F4}}$ (V-MEM) $\boxed{\text{F2}}$ (RECALL) to display the pop-up window.
4. Press a number key to specify the V-Window memory number for the settings you want to recall, and then press $\boxed{\text{EXE}}$. Pressing $\boxed{1} \boxed{\text{EXE}}$ recalls the settings in V-Window Memory 1 (V-Win1).

■ Specifying the Graph Range

You can define a range (start point, end point) for a function before graphing it.

1. From the Main Menu, enter the **Graph** mode.
2. Configure V-Window settings.
3. Specify the function type and input the function. The following is the syntax for function input.

Function $\boxed{\text{,}}$ $\boxed{\text{SHIFT}} \boxed{+}$ ([) Start Point $\boxed{\text{,}}$ End Point $\boxed{\text{SHIFT}} \boxed{-}$ (])

4. Draw the graph.

Example **Graph $y = x^2 + 3x - 2$ within the range $-2 \leq x \leq 4$.**

Use the following V-Window settings.

Xmin = -3, Xmax = 5, Xscale = 1

Ymin = -10, Ymax = 30, Yscale = 5

- ① $\boxed{\text{MENU}}$ Graph
- ② $\boxed{\text{SHIFT}} \boxed{\text{F3}}$ (V-WIN) $\boxed{\leftarrow}$ $\boxed{3}$ $\boxed{\text{EXE}}$ $\boxed{5}$ $\boxed{\text{EXE}}$ $\boxed{1}$ $\boxed{\text{EXE}}$ $\boxed{\triangledown}$
 $\boxed{\leftarrow}$ $\boxed{1}$ $\boxed{0}$ $\boxed{\text{EXE}}$ $\boxed{3}$ $\boxed{0}$ $\boxed{\text{EXE}}$ $\boxed{5}$ $\boxed{\text{EXE}}$ $\boxed{\text{EXIT}}$
- ③ $\boxed{\text{F3}}$ (TYPE) $\boxed{\text{F1}}$ (Y=) $\boxed{\text{X},\theta,T}$ $\boxed{x^2}$ $\boxed{+}$ $\boxed{3}$ X,θ,T $\boxed{-}$ $\boxed{2}$ $\boxed{\text{,}}$
 $\boxed{\text{SHIFT}} \boxed{+}$ ([) $\boxed{\leftarrow}$ $\boxed{2}$ $\boxed{\text{,}}$ $\boxed{4}$ $\boxed{\text{SHIFT}} \boxed{-}$ (]) $\boxed{\text{EXE}}$
- ④ $\boxed{\text{F6}}$ (DRAW)

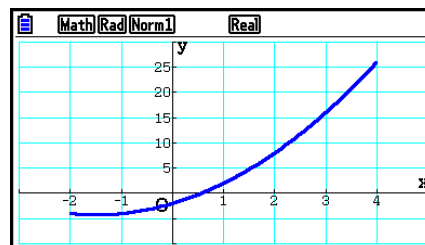

- You can specify a range when graphing rectangular expressions, polar expressions, parametric functions, and inequalities.

■ Zoom

This function lets you enlarge and reduce the graph on the screen.

1. Draw the graph.
2. Specify the zoom type.

SHIFT **F2** (ZOOM) **F1** (BOX) ... Box zoom

Draw a box around a display area, and that area is enlarged to fill the entire screen.

F2 (FACTOR) ... Factor zoom

Specifies the x -axis and y -axis zoom factors for factor zoom.

F3 (IN)/**F4** (OUT) ... Factor zoom

The graph is enlarged or reduced in accordance with the factor you specify, centered on the current pointer location.

F5 (AUTO) ... Auto zoom

V-Window y -axis settings are automatically adjusted so the graph fills the screen along the y -axis.

F6 (\triangleright) **F1** (ORIGINAL) ... Original size

Returns the graph to its original size following a zoom operation.

F6 (\triangleright) **F2** (SQUARE) ... Graph correction

V-Window x -axis values are corrected so they are identical to the y -axis values.

F6 (\triangleright) **F3** (ROUND) ... Coordinate rounding

Rounds the coordinate values at the current pointer location.

F6 (\triangleright) **F4** (INTEGER) ... Integer

Each dot is given a width of 1, which makes coordinate values integers.

F6 (\triangleright) **F5** (PREVIOUS) ... Previous

V-Window parameters are returned to what they were prior to the last zoom operation.

Box zoom range specification

3. Use the cursor keys to move the pointer () in the center of the screen to the location where you want one corner of the box to be, and then press **EXE**.
4. Use the cursor keys to move the pointer. This causes a box to appear on the screen. Move the cursor until the area you want to enlarge is enclosed in the box, and then press **EXE** to enlarge it.

Example Graph $y = (x + 5)(x + 4)(x + 3)$, and then perform a box zoom.

Use the following V-Window settings.

Xmin = -8, Xmax = 8, Xscale = 2

Ymin = -4, Ymax = 2, Yscale = 1

- ① **MENU** Graph
SHIFT **F3** (V-WIN) **(←)** **8** **EXE** **8** **EXE** **2** **EXE** **(↓)**
(←) **4** **EXE** **2** **EXE** **1** **EXE** **EXIT**
F3 (TYPE) **F1** (Y=) **()** **X,θ,T** **+** **5** **)** **()** **X,θ,T** **+** **4** **)**
() **X,θ,T** **+** **3** **)** **EXE**
F6 (DRAW)
- ② **SHIFT** **F2** (ZOOM) **F1** (BOX)
- ③ **(←)** ~ **(←)** **EXE**
- ④ **(←)** ~ **(←)**, **(↑)** ~ **(↑)** **EXE**

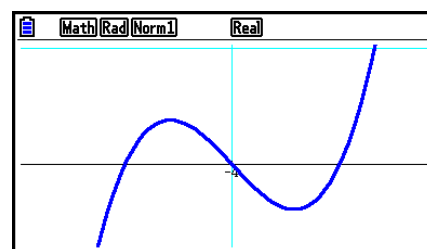
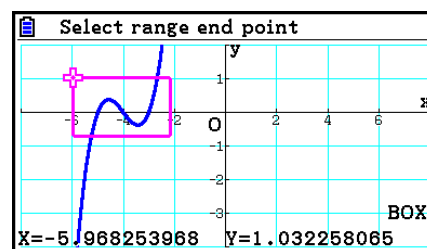

- You must specify two different points for box zoom, and the two points cannot be on a straight line vertically or horizontally from each other.

Zoom In/Zoom Out Using Key Operations

You can use the **(+)** and **(-)** keys while the graph screen is on the display to zoom in and out on the center of the graph screen. The zoom operations are performed in accordance with the factor value specified with **SHIFT** **F2** (ZOOM) **F2** (FACTOR).

Using Pan to Shift the Graph Screen

You can use pan to grab a location on the graph screen and drag the screen image up, down, left, and right. The pan operation can be used in the **Graph**, **Conic Graphs**, **Table**, and **Recursion** modes. Note, however, that it cannot be used while the “Dual Screen” setting on the Setup screen is “G+G” or “GtoT”.

• To pan the screen

1. While the graph screen is on the display, press **OPTN** **F2** (PAN).
 - This enters the Pan mode and displays a pointer (👉) in the center of the screen.
2. Move the pointer to the location on the screen you want to grab and then press **EXE**.
 - This causes the pointer to change from 👉 to 🖐️.
3. Use the cursor keys to shift the screen in the direction you want. When you are finished shifting the screen, press **EXE**.
 - Pressing **EXE** executes the graph drawing operation and changes the shape of the pointer from 🖐️ to 👈.
 - In the Pan mode, each press of **EXE** toggles the shape of the pointer between 👈 and 🖐️. While the 👈 pointer is on the display, you can use the cursor keys to move it to another location on the screen. Pressing the cursor keys while the 🖐️ pointer is on the display will shift (pan) the screen contents.
4. To exit the Pan mode, press **EXIT**.

■ Displaying a Graph Background Image

You can configure the calculator so a particular image is always displayed as the graph background image. Use the “Background” setting on the Setup screen to specify the background image. The following describes the types of files that can be used as the background image.

- A file saved using the procedure under “Saving Graph Screen Contents as an Image (g3p File)” (page 5-21)
- A file described under “Managing Picture Plot Files” (page 15-5)

• To select the graph background image

1. From the Main Menu, enter the **Graph** mode.
2. Press **SHIFT** **MENU** (SET UP) to display the Setup screen.
3. Use **▲** and **▼** to move the highlighting to “Background” and then press **F2** (PICT n), **F3** (OPEN), or **F1** (None).
 - If you do not want to display a background image on the graph screen, press **F1** (None) and then advance to step 6.
 - To display a list of g3p files stored in the PICT folder in storage memory, press **F2** (PICT n).
 - To display a list of g3p files stored in the PICT folder in the storage memory root directory, press **F3** (OPEN). In this case, use **▲** and **▼** if required to move the highlighting to the folder that contains the image you want to use and then press **F1** (OPEN).
4. Use **▲** and **▼** to move the highlighting to the file you want to use and then press **F1** (OPEN).

5. When the “V-Window values for specified background will be loaded. OK?” confirmation dialog box appears, press **F1** (Yes) to apply the V-Window settings saved with the g3p file or **F6** (No) to retain the current V-Window settings.
 - Pressing **F1** (Yes) overwrites all V-Window setting values except $T\theta_{min}$, $T\theta_{max}$, and $T\theta_{ptch}$ with the values stored with the g3p file.
6. To exit the Setup screen, press **EXIT**.

• **To overwrite current V-Window settings with the settings saved with the background image**

1. In the **Graph** mode, press **SHIFT F3** (V-WIN) to display the V-Window screen.
2. Press **F6** (BGV-WIN).
 - This will overwrite all V-Window setting values except $T\theta_{min}$, $T\theta_{max}$, and $T\theta_{ptch}$ with the values stored with the background file.
3. To exit the V-Window screen, press **EXIT**.

• **To update the background image V-Window settings with current V-Window settings**

1. While the graph screen is on the display, press **OPTN F4** (BGV-WIN).
2. Press **F1** (SAVE).
 - This will cause the “OK to refresh background V-Window?” confirmation message to appear.
3. Press **F1** (Yes) to update the V-Window settings of the background file, or **F6** (No) to cancel updating.

• **To save the background image to a file with current V-Window settings**

1. While the graph screen is on the display, press **OPTN F4** (BGV-WIN).
2. Press **F2** (SAVE • AS).
 - This will cause the message “OK to refresh background V-Window?” to appear. To clear this message and cancel this operation, press **F6** (No).
3. Press **F1** (Yes).
4. Specify the folder you want.
 - Highlight ROOT to save the file to the root directory.
 - To save the file in a specific folder, use **▲** and **▼** to move the highlighting to the desired folder and then press **F1** (OPEN).
5. Press **F1** (SAVE • AS).

6. On the File Name dialog box that appears, enter a name up to eight characters long and then press **EXE**.
 - This saves the background image under the name you specify. It also changes the image specified for the “Background” item on the Setup screen to the newly saved background image.

■ Adjusting the Lightness (Fade I/O) of the Background Image

You can adjust the lightness of the graph screen background image specified by the “Background” setting on the Setup screen within a range of 0% (as-is) to 100% (all white). A higher setting value makes the image lighter, and a setting of 100% displays an all white background.

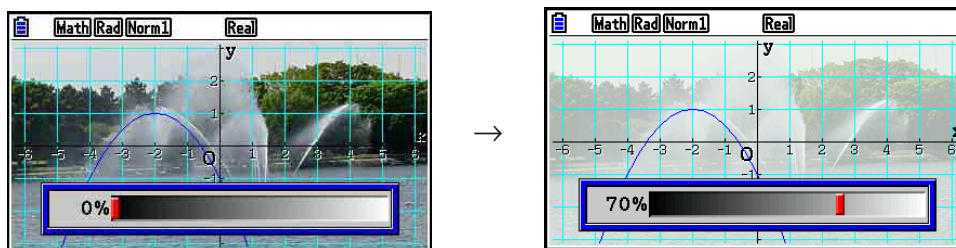

You can use this setting to adjust the background image to a level that makes the graph easier to see.

- Note that the lightness setting can be adjusted only when the background image is a 16-bit image data.
- After you adjust the lightness level, the setting is stored with the background image.

• To adjust the lightness (Fade I/O) of the background image

1. While the graph screen is on the display, press **OPTN** **F3** (Fadel/O). If you are in the **Dyna Graph** mode, press **OPTN** **F1** (Fadel/O).
 - This causes a slider for adjusting image lightness to appear on the display.
2. Use **◀** and **▶** to adjust the lightness value.
 - Each press of **◀** or **▶** changes the setting value in steps of 5%.
 - You can also input values directly, if you want. To specify a lightness value of 20%, for example, press **2** **0** **EXE**.
3. After the setting is the way you want, press **EXIT**.

3. Drawing a Graph

You can store up to 20 functions in memory. Functions in memory can be edited, recalled, and graphed.

■ Specifying the Graph Type

Before you can store a graph function in memory, you must first specify its graph type.

1. While the graph relation list is on the display, press **F3** (TYPE) to display the graph type menu, which contains the following items.

- **{Y=}**/**{r=}**/**{Param}**/**{X=}** ... {rectangular coordinate ($Y=f(x)$ type)}/{polar coordinate}/
 {parametric}/{rectangular coordinate ($X=f(y)$ type)} graph
- **{Y>}**/**{Y<}**/**{Y≥}**/**{Y≤}** ... $\{Y>f(x)\}$ / $\{Y<f(x)\}$ / $\{Y≥f(x)\}$ / $\{Y≤f(x)\}$ inequality graph
- **{X>}**/**{X<}**/**{X≥}**/**{X≤}** ... $\{X>f(y)\}$ / $\{X<f(y)\}$ / $\{X≥f(y)\}$ / $\{X≤f(y)\}$ inequality graph
- **{CONVERT}**
 - **{▶Y=}**/**{▶Y>}**/**{▶Y<}**/**{▶Y≥}**/**{▶Y≤}**/**{▶X=}**/**{▶X>}**/**{▶X<}**/**{▶X≥}**/**{▶X≤}**
 ... {changes the function type of the selected expression}

2. Press the function key that corresponds to the graph type you want to specify.

■ Storing Graph Functions

• To store a rectangular coordinate function (Y=)

Example To store the following expression in memory area Y1: $y = 2x^2 - 5$

F3 (TYPE) **F1** (Y=) (Specifies rectangular coordinate expression.)

2 **x,θ,T** **x²** **=** **5** (Inputs expression.)

EXE (Stores expression.)

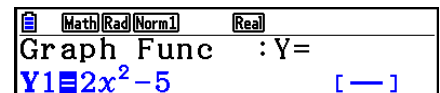

- A function cannot be stored into a memory area that already contains a function of a different type from the one you are trying to store. Select a memory area that contains a function that is the same type as the one you are storing, or delete the function in the memory area to which you are trying to store.

- To store a parametric function

Example To store the following expressions in memory areas Xt3 and Yt3:

$$x = 3 \sin T$$

$$y = 3 \cos T$$

F3 (TYPE) **F3** (Param) (Specifies parametric expression.)

3 **sin** **X,θ,T** **EXE** (Inputs and stores x expression.)

3 **cos** **X,θ,T** **EXE** (Inputs and stores y expression.)

- To create a composite function

Example To use relations in Y1 and Y2 to create composite functions for Y3 and Y4

$$Y1 = \sqrt{x+1}, Y2 = x^2 + 3$$

Assign $Y1 \circ Y2$ to Y3, and $Y2 \circ Y1$ to Y4.

$$(Y1 \circ Y2 = \sqrt{(x^2 + 3) + 1}) = \sqrt{x^2 + 4} \quad Y2 \circ Y1 = (\sqrt{x+1})^2 + 3 = x + 4 \quad (x \geq -1)$$

Input relations into Y3 and Y4.

F3 (TYPE) **F1** (Y=) **VAR** **F4** (GRAPH)

F1 (Y) **1** **(** **F1** (Y) **2** **)** **EXE**

VAR **F4** (GRAPH) **F1** (Y) **2**

(**F1** (Y) **1** **)** **EXE**

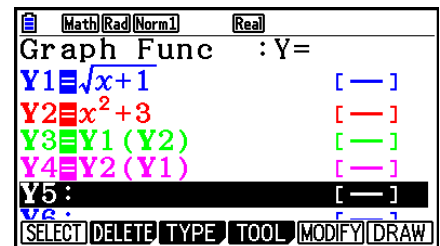

- A composite function can consist of up to five functions.

• To assign values to the coefficients and variables of a graph function

Example To assign the values -1, 0, and 1 to variable A in $Y = AX^2 - 1$, and draw a graph for each value

F3 (TYPE) **F1** (Y=)
ALPHA **X,θ,T** (A) **X,θ,T** x^2 **=** **1** **EXE**
VAR **F4** (GRAPH) **F1** (Y) **1** **C** **ALPHA** **X,θ,T** (A)
SHIFT **⊙** (=) **(←)** **1** **)** **EXE**
VAR **F4** (GRAPH) **F1** (Y) **1** **C** **ALPHA** **X,θ,T** (A)
SHIFT **⊙** (=) **0** **)** **EXE**
VAR **F4** (GRAPH) **F1** (Y) **1** **C** **ALPHA** **X,θ,T** (A)
SHIFT **⊙** (=) **1** **)** **EXE**
▲ **▲** **▲** **▲** **F1** (SELECT)
F6 (DRAW)

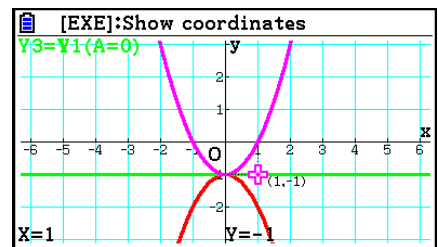
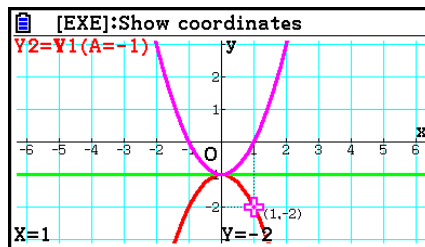
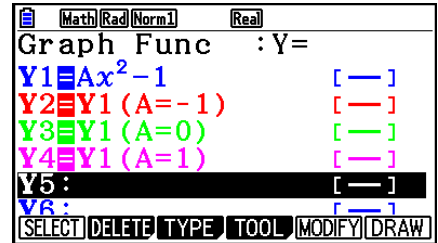

The above screens are produced using the Trace function. See “Function Analysis” (page 5-52) for more information.

■ Changing Graph Properties

• To change graph properties from the graph relation list screen

1. On the graph relation list screen, use **▲** and **▼** to highlight the relation whose graph properties you want to change.
2. Press **SHIFT** **5** (FORMAT) to display the format dialog box.

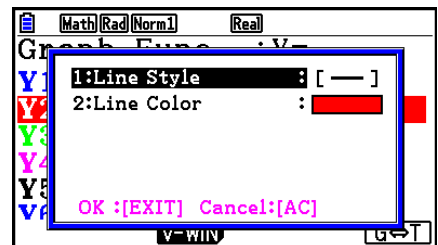

3. Use \blacktriangle and \blacktriangledown to move the highlighting to “Line Style” and then press $\boxed{\text{EXE}}$.

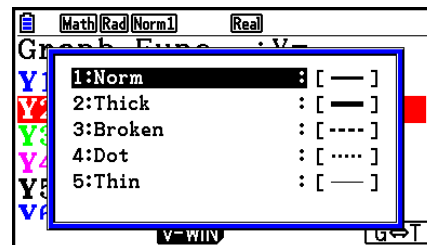

4. On the list of line styles that appears, use \blacktriangle and \blacktriangledown to move the highlighting to the desired style and then press $\boxed{\text{EXE}}$.
- You also can select an option by pressing the number key that corresponds to the number to the left of the desired option.

5. Use \blacktriangle and \blacktriangledown to move the highlighting to “Line Color” and then press $\boxed{\text{EXE}}$.

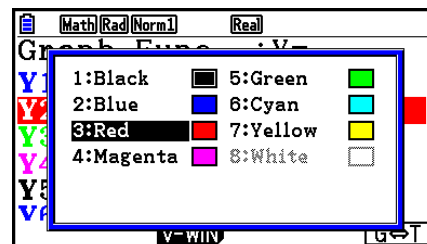

6. On the list of colors that appears, use \blacktriangle and \blacktriangledown to move the highlighting to the desired color and then press $\boxed{\text{EXE}}$.
- You also can select an option by pressing the number key that corresponds to the number to the left of the desired option.

7. After the setting is the way you want, press $\boxed{\text{EXIT}}$.

• To change graph properties from the graph screen

- While the graph screen is on the display, press $\boxed{\text{SHIFT}} \boxed{5}$ (FORMAT).
 - If there are multiple graphs on the graph screen, one of them will start flashing. The flashing graph is the one that is currently selected.
 - If there are multiple graphs on the graph screen, perform step 2, below. If there is only one graph on the screen, skip step 2 and go directly to step 3.
- Use \blacktriangle and \blacktriangledown to move the flashing to the graph whose properties you want to change and then press $\boxed{\text{EXE}}$.
- Use the format dialog box that appears to configure the Line Style and Line Color as you like.
 - For the remainder of this procedure, perform the steps from step 3 under “To change graph properties from the graph relation list screen”.
 - Pressing $\boxed{\text{EXIT}}$ will redraw a graph in accordance with your changes.

● To change the line style of a graph function

1. On the graph relation list screen, use \blacktriangle and \blacktriangledown to highlight the relation whose line style you want to change.
2. Press $\boxed{F4}$ (TOOL) $\boxed{F1}$ (STYLE).
3. Select the line style.

Example To change the line style of $y = 2x^2 - 3$, which is stored in area Y1, to “Broken”

$\boxed{F4}$ (TOOL) $\boxed{F1}$ (STYLE) $\boxed{F3}$ (.....) (Selects “Broken”.)

■ Editing and Deleting Functions

● To edit a function in memory

Example To change the expression in memory area Y1 from $y = 2x^2 - 5$ to $y = 2x^2 - 3$

\blacktriangleright (Displays cursor.)

\blacktriangleright \blacktriangleright \blacktriangleright \blacktriangleright \blacktriangleright \boxed{DEL} $\boxed{3}$ (Changes contents.)

\boxed{EXE} (Stores new graph function.)

● To change the type of a function ^{*1}

1. While the graph relation list is on the display, press \blacktriangle or \blacktriangledown to move the highlighting to the area that contains the function whose type you want to change.
2. Press $\boxed{F3}$ (TYPE) $\boxed{F5}$ (CONVERT).
3. Select the function type you want to change to.

Example To change the function in memory area Y1 from $y = 2x^2 - 3$ to $y < 2x^2 - 3$

$\boxed{F3}$ (TYPE) $\boxed{F5}$ (CONVERT) $\boxed{F3}$ (\blacktriangleright Y<) (Changes the function type to “Y<”.)

*1 The function type can be changed for rectangular coordinate functions and inequalities only.

• To delete a function

1. While the graph relation list is on the display, press \blacktriangle or \blacktriangledown to move the highlighting to the area that contains the function you want to delete.
2. Press F2 (DELETE) or DEL .
3. Press F1 (Yes) to delete the function or F6 (No) to abort the procedure without deleting anything.
 - Using the above procedure to delete one line of a parametric function (such as $Xt2$) also will delete the applicable paired line ($Yt2$, in the case of $Xt2$).

■ Selecting Functions for Graphing

• To specify the draw/non-draw status of a graph

1. On the graph relation list, use \blacktriangle and \blacktriangledown to highlight the relation you do not want to graph.
2. Press F1 (SELECT).
 - Each press of F1 (SELECT) toggles graphing on and off.
3. Press F6 (DRAW).

Example **To select the following functions for drawing:**

$$Y1 = 2x^2 - 5, r2 = 5 \sin 3\theta$$

Use the following V-Window settings.

$$X_{\min} = -5, \quad X_{\max} = 5, \quad X_{\text{scale}} = 1$$

$$Y_{\min} = -5, \quad Y_{\max} = 5, \quad Y_{\text{scale}} = 1$$

$$T_{\theta\min} = 0, \quad T_{\theta\max} = \pi, \quad T_{\theta\text{ptch}} = 2\pi / 60$$

\blacktriangledown \blacktriangle (Select a memory area that contains a function for which you want to specify non-draw.)

F1 (SELECT) (Specifies non-draw.)

F6 (DRAW) or EXE (Draws the graphs.)

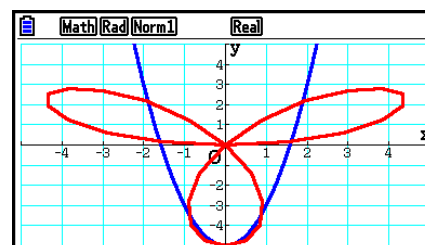

■ Displaying and Hiding Graph Axes and Label on the Graph Screen

You can use the Setup screen settings to alter the appearance of the graph screen as shown below.

- Grid: On (Axes: On, Label: Off)

This setting causes dots to appear at the grid intersects on the display.

Changing the V-Window Xscale or Yscale settings to 0 while “On” is specified for the Grid setting will cause the dots to disappear from the display.

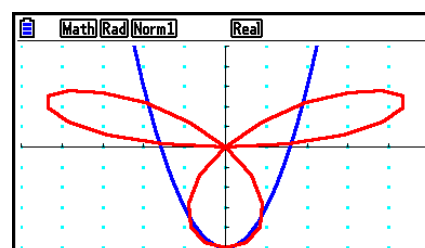

- Grid: Line (Axes: On, Label: Off)

This setting causes scale lines to be displayed for the x -axis and y -axis.

Changing the V-Window Xscale setting to 0 while “Line” is specified for the Grid setting will cause the vertical lines to disappear from the display. Changing the V-Window Yscale setting to 0 will cause the horizontal lines to disappear.

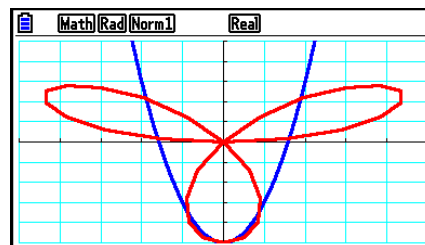

- Axes: Off (Label: Off, Grid: Off)

This setting clears the axis lines from the display.

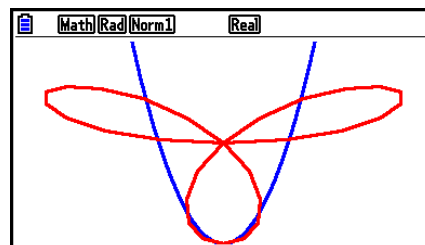

- Axes: Scale (Label: Off, Grid: Off)

This setting causes scale lines to be displayed for the x -axis and y -axis.

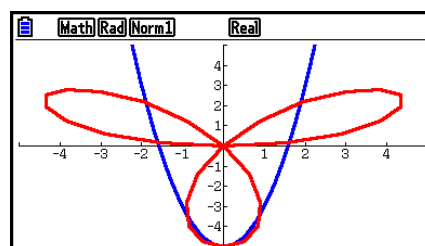

- Label: On (Axes: On, Grid: Off)

This setting display x -axis, y -axis, and origin (O) labels.

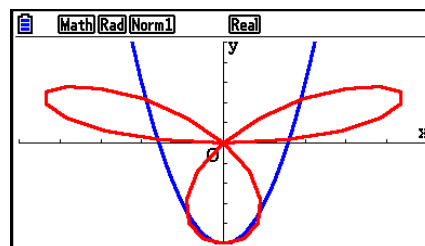

- Even if the Grid setting is “On” or “Line”, grid lines will not be displayed if the V-Window settings are configured in a way that the grids are too close to each other.

■ Graph Memory

Graph memory lets you store up to 20 sets of graph function data and recall it later when you need it.

A single save operation saves the following data in graph memory.

- All graph functions in the currently displayed graph relation list (up to 20)
- Graph types
- Function graph line style and color information
- Draw/non-draw status
- V-Window settings (1 set)

• To store graph functions in graph memory

1. Press **F4**(TOOL) **F2**(GPH-MEM) **F1**(STORE) to display the pop-up window.
2. Press a number key to specify the graph memory where you want to save the graph function, and then press **EXE**. Pressing **1** **EXE** stores the graph function to Graph Memory 1 (G-Mem1).
 - There are 20 graph memories numbered G-Mem1 to G-Mem20.
 - Storing a function in a memory area that already contains a function replaces the existing function with the new one.
 - If the data exceeds the calculator's remaining memory capacity, an error occurs.

• To recall a graph function

1. Press **F4**(TOOL) **F2**(GPH-MEM) **F2**(RECALL) to display the pop-up window.
2. Press a number key to specify the graph memory for the function you want to recall, and then press **EXE**. Pressing **1** **EXE** recalls the graph function in Graph Memory 1 (G-Mem1).
 - Recalling data from graph memory causes any data currently on the graph relation list to be deleted.

4. Saving and Recalling Graph Screen Contents

You can save the contents of the graph screen to a file. The format of the file is g3p, which is a proprietary format unique to this calculator. Performing the save operation in this section saves the following information.

- A bitmap image of the graph
- A bitmap image of the graph background (including axes, grid, axes labels, background image)
 - The background image includes the lightness setting, so it is saved as it appears on the graph screen.
 - The function menu and status bar are not included in the background image.
- V-Window settings (excluding $T\theta_{min}$, $T\theta_{max}$, $T\theta_{ptch}$ values)

Saved images can be recalled to a graph screen and overlaid onto another graph, or recalled from and used in another application.

■ Saving Graph Screen Contents as an Image (g3p File)

There are two methods that can be used to save a g3p file.

- **Saving to Picture Memory**

This method lets you assign a number from 1 to 20 to an image when you save it. It stores the image in the storage memory's PICT folder as a file with a name from Pict01.g3p through Pict20.g3p.

- **Saving under an Assigned Name**

This method saves the image in the folder you want in storage memory. You can assign a file name up to eight characters long.

Important!

- A dual graph screen or any other type of graph that uses a split screen cannot be saved in picture memory.

● **To save a graph screen image to Picture Memory**

1. While the graph screen is on the display, press **[OPTN]** **[F1]** (PICTURE) **[F1]** (STORE) **[F1]** (1-20).
2. On the Store In Picture Memory screen that appears, enter a value from 1 to 20 and then press **[EXE]**.
 - There are 20 picture memories numbered Pict 1 to Pict 20.
 - Storing an image in a memory area that already contains an image replaces the existing image with the new one.

● **To store a graph screen image under a file name**

1. While the graph screen is on the display, press **[OPTN]** **[F1]** (PICTURE) **[F1]** (STORE) **[F2]** (SAVE • AS).
 - This displays a folder selection screen.
2. Select the folder where you want to save the image.
 - To store the image in the root directory, highlight "ROOT".

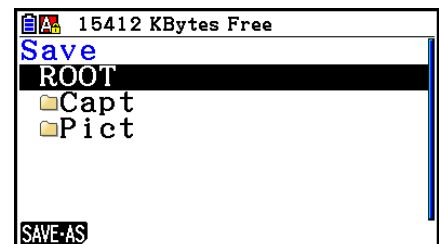

- To store the image in a folder, use ▲ and ▼ to move the highlighting to the desired folder and then press **F1** (OPEN).

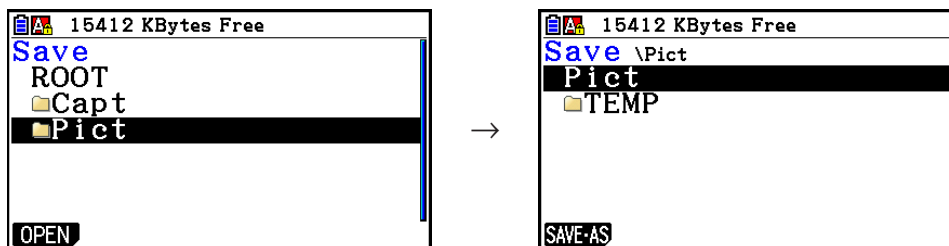

3. Press **F1** (SAVE • AS).
4. On the File Name dialog box that appears, enter a name up to eight characters long and then press **EXE**.

■ Recalling an Image (g3p File) to a Graph Screen

There are two methods that can be used to recall an image (g3p file) to a graph screen.

- Recalling an image from picture memory (Pict01.g3p to Pict20.g3p)
- Recalling an image from a folder in storage memory

Note

- Recalling an image causes it to be placed immediately behind the graph (above the current background image) on the graph screen.
- To clear a recalled image, display the graph screen and then press **SHIFT F4** (SKETCH) **F1** (ClS).

• To recall an image stored in Picture Memory

1. While the graph screen is on the display, press **OPTN F1** (PICTURE) **F2** (RECALL) **F1** (1-20).
2. On the Recall From Picture Memory screen that appears, enter a value from 1 to 20 and then press **EXE**.

• To recall a g3p file stored in Storage Memory

1. While the graph screen is on the display, press **OPTN F1** (PICTURE) **F2** (RECALL) **F2** (OPEN).
 - Use ▲ and ▼ if required to move the highlighting to the folder that contains the image file you want to recall and then press **F1** (OPEN).
2. Use ▲ and ▼ to move the highlighting to the file you want to recall and then press **F1** (OPEN).

5. Drawing Two Graphs on the Same Screen

■ Copying the Graph to the Sub-screen

Dual Graph lets you split the screen into two parts. Then you can graph two different functions in each for comparison, or draw a normal size graph on one side and its enlarged version on the other side. This makes Dual Graph a powerful graph analysis tool.

With Dual Graph, the left side of the screen is called the “main screen”, while the right side is called the “sub-screen”.

- **Main Screen**

The graph in the main screen is actually drawn from a function.

- **Sub-screen**

The graph on the sub-screen is produced by copying or zooming the main screen graph. You can even make different V-Window settings for the sub-screen and main screen.

- **To copy the graph to the sub-screen**

1. From the Main Menu, enter the **Graph** mode.
2. On the Setup screen, select “G + G” for “Dual Screen”.
3. Configure V-Window settings for the main screen.

Press **F6** (RIGHT) to display the sub-graph settings screen. Pressing **F6** (LEFT) returns to the main screen setting screen.

4. Store the function, and draw the graph in the main screen.
5. Perform the Dual Graph operation you want.

OPTN **F1** (COPY) ... Duplicates the main screen graph in the sub-screen

OPTN **F2** (SWAP) ... Swaps the main screen contents and sub-screen contents

- Indicators appear to the right of the formulas in the graph relation list to tell where graphs are drawn with Dual Graph.

The screenshot shows a calculator screen with the following text:

```
Math Rad Norm1 Real
Graph+Graph : Y=
Y1=x(x+2)(x-2) [—] R
Y2=2x^2-3 [—] B
```

Two lines of text with arrows pointing to the right of the equations:

- Indicates sub-screen graph (on right side of display)
- Indicates graph drawn on both sides of display

Performing a draw operation with the function marked “**R**” in the above example screen causes the graph to be drawn on the right side on the display. The function marked “**B**” is drawn on both sides of the graph.

Pressing **F1** (SELECT) while one of the functions marked “**R**” or “**B**” is highlighted would cause its “**R**” or “**B**” indicator to be cleared. A function without an indicator is drawn as the main screen graph (on the left side of the display).

- The graph properties operation can be performed only for the graph that is on the left side of the Dual Graph graph screen.
- If you change the graph properties of an expression marked with “**B**” on the graph relation list screen and then draw the graph, the changes will be applied to both graphs.
- You cannot change the graph properties of an expression marked with “**R**” on the graph relation list screen.
- For details about how to change graph properties, see “Changing Graph Properties” (page 5-15).

Example Graph $y = x(x + 1)(x - 1)$ in the main screen and sub-screen.

Use the following V-Window settings.

(Main Screen) **Xmin = -2, Xmax = 2, Xscale = 0.5**

Ymin = -2, Ymax = 2, Yscale = 1

(Sub-screen) **Xmin = -4, Xmax = 4, Xscale = 1**

Ymin = -3, Ymax = 3, Yscale = 1

- ① **MENU** Graph
- ② **SHIFT** **MENU** (SET UP) **▼** **▼** **▼** **▼** **F1** (G + G) **EXIT**
- ③ **SHIFT** **F3** (V-WIN) **(←)** **2** **EXE** **2** **EXE** **0** **.** **5** **EXE** **▼**
(←) **2** **EXE** **2** **EXE** **1** **EXE**
F6 (RIGHT) **(←)** **4** **EXE** **4** **EXE** **1** **EXE** **▼**
(←) **3** **EXE** **3** **EXE** **1** **EXE** **EXIT**
- ④ **F3** (TYPE) **F1** (Y=) **X,θ,T** **(←)** **X,θ,T** **+** **1** **)** **(←)**
X,θ,T **=** **1** **)** **EXE**
F6 (DRAW)
- ⑤ **OPTN** **F1** (COPY)

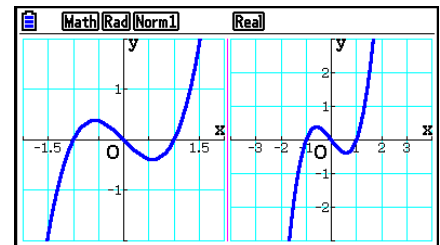

- Pressing **AC** while a graph is on the display will return to the screen in step 4.

6. Manual Graphing

■ Rectangular Coordinate Graph

Inputting the Graph command in the **Run-Matrix** mode enables drawing of rectangular coordinate graphs.

1. From the Main Menu, enter the **Run-Matrix** mode.
2. On the Setup screen, change “Input/Output” setting to “Linear”.
3. Configure V-Window settings.
4. Input the commands for drawing the rectangular coordinate graph.
5. Input the function.

Example **Graph $y = 2x^2 + 3x - 4$.**

Use the following V-Window settings.

Xmin = -5, Xmax = 5, Xscale = 2

Ymin = -10, Ymax = 10, Yscale = 5

- ① **MENU** Run-Matrix
- ② **SHIFT** **MENU** (SET UP) **F2** (Line) **EXIT**
- ③ **SHIFT** **F3** (V-WIN) **(←)** **5** **EXE** **5** **EXE** **2** **EXE** **(↓)**
(←) **1** **0** **EXE** **1** **0** **EXE** **5** **EXE** **EXIT**
- ④ **SHIFT** **F4** (SKETCH) **F1** (CIs) **EXE**
F5 (GRAPH) **F1** (Y=)
- ⑤ **2** **X,θ,T** **x²** **+** **3** **X,θ,T** **-** **4** **EXE**

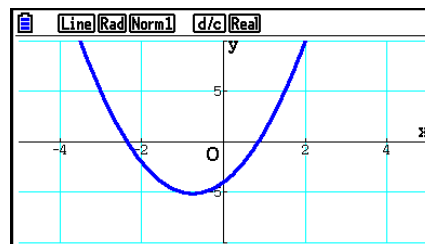

- Certain functions can be graphed easily using built-in function graphs.
- You can draw graphs of the following built-in scientific functions.

Rectangular Coordinate Graph

• $\sin x$	• $\cos x$	• $\tan x$	• $\sin^{-1} x$
• $\cos^{-1} x$	• $\tan^{-1} x$	• $\sinh x$	• $\cosh x$
• $\tanh x$	• $\sinh^{-1} x$	• $\cosh^{-1} x$	• $\tanh^{-1} x$
• \sqrt{x}	• x^2	• $\log x$	• $\ln x$
• 10^x	• e^x	• x^{-1}	• $\sqrt[3]{x}$
• $\frac{d}{dx}(x)$	• $\frac{d^2}{dx^2}(x)$	• $\int(x)dx$	

Polar Coordinate Graph

• $\sin \theta$	• $\cos \theta$	• $\tan \theta$	• $\sin^{-1} \theta$
• $\cos^{-1} \theta$	• $\tan^{-1} \theta$	• $\sinh \theta$	• $\cosh \theta$
• $\tanh \theta$	• $\sinh^{-1} \theta$	• $\cosh^{-1} \theta$	• $\tanh^{-1} \theta$
• $\sqrt{\theta}$	• θ^2	• $\log \theta$	• $\ln \theta$
• 10^θ	• e^θ	• θ^{-1}	• $\sqrt[3]{\theta}$

- Input for x and θ variables is not required for a built-in function.
- When inputting a built-in function, other operators or values cannot be input.

- You cannot change the line color or line style for graphs drawn using the above operation.
- The value of only one of the variables in the expression can change.
- Any of the following cannot be used for the variable name: X, Y, r, θ , T.
- You cannot assign a variable to the variable inside the function.
- When Simul Graph is turned on, all of the graphs for the specified variable values are drawn simultaneously.
- Overwrite can be used when graphing rectangular expressions, polar expressions, parametric functions, and inequalities.

■ Using a List to Simultaneously Draw Multiple Graphs (List Graph)

You can use a list to simultaneously draw multiple graphs by substituting list data for a coefficient within an expression registered on the graph relation list screen.

Example: List 1 = {1,2,3}, List 2 = {4,5,6}

- Registering and graphing the expression $Y1 = (\text{List 1})X^2$ will simultaneously draw graphs for the following three expressions:

$$Y = X^2, Y = 2X^2, Y = 3X^2$$

- Registering and graphing the expression $Y1 = (\text{List 1})X^2 - (\text{List 2})$ will simultaneously draw graphs for the following three expressions:

$$Y = X^2 - 4, Y = 2X^2 - 5, Y = 3X^2 - 6$$

Important!

If you want to use multiple lists within a registered expression, all of the lists must have the same number of elements. A Dimension ERROR will occur if a list that does not have the same number of elements as the other lists is included.

● **To use a list to simultaneously draw multiple graphs**

1. Use the List Editor (Chapter 3) to register the list(s) you want to use.
2. From the Main Menu, enter the **Graph** mode.
3. On the Setup screen, change the “Dual Screen” setting to “Off”.
4. Configure V-Window settings.
5. Register an expression with a coefficient that uses the list(s) data.
6. Draw the graph.

Example Register {3, 1, -1} in List 1, and then graph $y = (\text{List } 1)x^2 - 3$.

Use the following V-Window settings.

Xmin = -5, Xmax = 5, Xscale = 1

Ymin = -10, Ymax = 10, Yscale = 2

- ① **MENU** Statistics
3 **EXE** **1** **EXE** **(←)** **1** **EXE**
- ② **MENU** Graph
- ③ **SHIFT** **MENU** (SET UP) **▼** **▼** **▼** **▼** **F3** (Off) **EXIT**
- ④ **SHIFT** **F3** (V-WIN) **(←)** **5** **EXE** **5** **EXE** **1** **EXE** **▼** **(←)** **1** **0**
EXE **1** **0** **EXE** **2** **EXE** **EXIT**
- ⑤ **F3** (TYPE) **F1** (Y=) **SHIFT** **1** (List) **1** **X,θ,T** **x²** **=** **3** **EXE**
- ⑥ **F6** (DRAW)

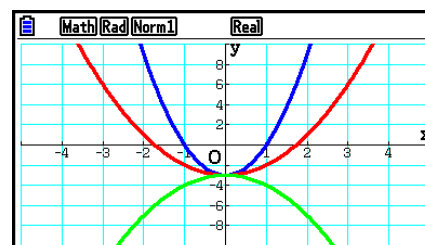

- When multiple graphs are drawn simultaneously with the above operation, they are drawn using five different colors in the following sequence: blue, red, green, magenta, black. The first graph is drawn using the color specified for an expression that is registered on the graph relation list screen, followed by the next color in the above sequence. Due to display readability considerations, if cyan or yellow is specified for the expression, the default color for the graph relation list screen line where the expression is registered will be used instead.
- You cannot change the line color or line style for graphs drawn using the above operation.
- When Simul Graph is turned on, all of the graphs are drawn simultaneously.

■ Using Copy and Paste to Graph a Function

You can graph a function by copying it to the clipboard, and then pasting it into the graph screen.

There are two types of functions you can paste into the graph screen.

Type 1 (Y= expression)

A function with the Y variable to the left of the equal sign is graphed as Y= expression.

Example: To paste Y=X and graph it

- Any spaces to the left of Y are ignored.

Type 2 (expression)

Pasting this type of expression graphs Y= expression.

Example: To paste X and graph Y=X

- Any spaces to the left of the expression are ignored.

• To graph a function using copy and paste

1. Copy the function you want to graph to the clipboard.
2. From the Main Menu, enter the **Graph** mode.
3. On the Setup screen, change the “Dual Screen” setting to “Off”.
4. Configure V-Window settings.
5. Draw the graph.
6. Paste the expression.

Example **While the graph of $y = 2x^2 + 3x - 4$ is currently displayed, to paste the previously copied function $Y=X$ from the clipboard**

Use the following V-Window settings.

Xmin = -5, Xmax = 5, Xscale = 2

Ymin = -10, Ymax = 10, Yscale = 5

- ① **MENU** Run-Matrix
ALPHA **=** (Y) **SHIFT** **□** (=) **X,θ,T**
SHIFT **8** (CLIP) **◀** **◀** **◀** **F1** (COPY)
- ② **MENU** Graph
- ③ **SHIFT** **MENU** (SET UP) **▼** **▼** **▼** **▼** **F3** (Off) **EXIT**
- ④ **SHIFT** **F3** (V-WIN) **(-)** **5** **EXE** **5** **EXE** **2** **EXE** **▼**
(-) **1** **0** **EXE** **1** **0** **EXE** **5** **EXE** **EXIT**
- ⑤ **F3** (TYPE) **F1** (Y=) **2** **X,θ,T** **x²** **+** **3** **X,θ,T** **-** **4** **EXE**
F6 (DRAW)
- ⑥ **SHIFT** **9** (PASTE)

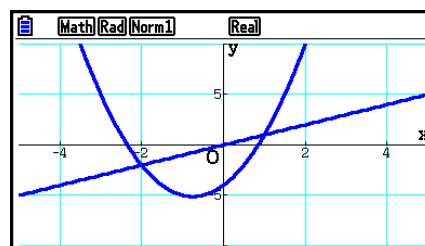

- A graph drawn as the result of a paste operation is drawn with blue line color and normal line style. You can change the line color and line style on the graph screen only. For details, see “Changing Graph Properties” (page 5-15).
- Paste is supported only when “Off” is selected for the “Dual Screen” setting on the Setup screen.
- Though there is no limit on the number of graphs you can draw by pasting a function, the total number of graphs supported by trace and other functions is 30 (number of graphs drawn using expression number 1 to 20, plus graphs drawn using pasted functions).
- For the graph of a pasted function, the graph expression that appears when using trace or other functions is displayed in the format: $Y = \text{expression}$.
- Re-executing a draw without clearing graph screen memory will redraw all the graphs, including those produced by pasting functions.

7. Using Tables

From the Main Menu, enter the **Table** mode.

■ Storing a Function and Generating a Number Table

• To store a function

Example To store the function $y = 3x^2 - 2$ in memory area Y1

Use \blacktriangle and \blacktriangledown to move the highlighting in the table relation list to the memory area where you want to store the function. Next, input the function and press $\boxed{\text{EXE}}$ to store it.

• Variable Specifications

There are two methods you can use to specify value for the variable x when generating a numeric table.

• Table range method

With this method, you specify the conditions for the change in value of the variable.

• List

With this method, the data in the list you specify is substituted for the x -variable to generate a number table.

• To generate a table using a table range

Example To generate a table as the value of variable x changes from -3 to 3 , in increments of 1

$\boxed{\text{MENU}}$ Table
 $\boxed{\text{F5}}$ (SET)
 $\boxed{\leftarrow}$ $\boxed{3}$ $\boxed{\text{EXE}}$ $\boxed{3}$ $\boxed{\text{EXE}}$ $\boxed{1}$ $\boxed{\text{EXE}}$

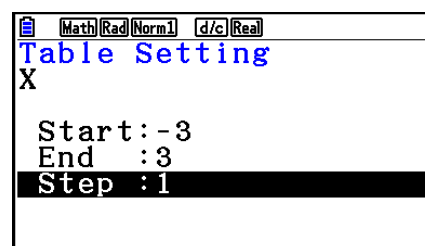

The numeric table range defines the conditions under which the value of variable x changes during function calculation.

Start Variable x start value

End Variable x end value

Step Variable x value change (interval)

After specifying the table range, press $\boxed{\text{EXIT}}$ to return to the table relation list.

• To generate a table using a list

1. While the table relation list is on the screen, display the Setup screen.
2. Highlight “Variable” and then press **[F2]** (LIST) to display the pop-up window.
3. Select the list whose values you want to assign for the x -variable.
 - To select List 6, for example, press **[6]** **[EXE]**. This causes the setting of the Variable item of the Setup screen to change to List 6.
4. After specifying the list you want to use, press **[EXIT]** to return to the previous screen.

• To change the number table character color from the table relation list screen

The procedure for changing the number table character color from the table relation list screen is identical to the procedure for changing the graph line color from the graph relation list screen.

For details, see “To change graph properties from the graph relation list screen” (page 5-15).

• Generating a Table

Example **To generate a table of values for the functions stored in memory areas Y1 and Y3 of the table relation list**

Use **[▲]** and **[▼]** to move the highlighting to the function you want to select for table generation and press **[F1]** (SELECT) to select it.

The “=” sign of selected functions is highlighted on the screen. To deselect a function, move the cursor to it and press **[F1]** (SELECT) again.

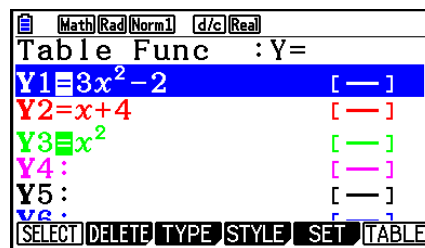

Press **[F6]** (TABLE) to generate a number table using the functions you selected. The value of variable x changes according to the range or the contents of the list you specified.

The example screen shown here shows the results based on the contents of List 6 ($-3, -2, -1, 0, 1, 2, 3$).

The screenshot shows the generated table with columns for x, Y1, and Y3. The x values are -3, -2, -1, and 0. The Y1 values are 25, 10, 1, and -2. The Y3 values are 9, 4, 1, and 0. The bottom menu includes FORMULA, DELETE, ROW, EDIT, GPH-CON, and GPH-PLT.

x	Y1	Y3
-3	25	9
-2	10	4
-1	1	1
0	-2	0

Each cell can contain up to six digits, including negative sign.

• To generate a differential number table

Changing the setting of Setup screen's "Derivative" item to "On" causes a number table that includes the derivative to be displayed whenever you generate a number table.

Locating the cursor at a differential coefficient displays "dY/dX" in the top line, which indicates differential.

X	Y1	Y'1	Y3
-3	25	-18	9
-2	10	-12	4
-1	1	-6	1
0	-2	0	0

- 18

FORMULA DELETE ROW EDIT GPH-CON GPH-PLT

- An error occurs if a graph for which a range is specified or an overwrite graph is included among the graph expressions.

• Specifying the Function Type

You can specify a function as being one of three types.

- Rectangular coordinate (Y=)
- Polar coordinate (r=)
- Parametric (Param)

1. Press **F3** (TYPE) while the relation list is on the screen.

2. Press the number key that corresponds to the function type you want to specify.

- The number table is generated only for the function type specified on the relation list (Table Func). You cannot generate a number table for a mixture of different function types.

■ Editing Tables

You can use the table menu to perform any of the following operations once you generate a table.

- Change the values of variable x
- Edit (delete, insert, and append) rows
- Delete a table
- Draw a connect type graph
- Draw a plot type graph
- **{FORMULA}** ... {return to table relation list}
- **{DELETE}** ... {delete table}
- **{ROW}**
 - **{DELETE}**/**{INSERT}**/**{ADD}** ... {delete}/**{insert}**/**{add}** row
- **{EDIT}** ... {change the values of variable x }
- **{GPH-CON}**/**{GPH-PLT}** ... {connected type}/**{draw plot type}** graph draw
- If you try to replace a value with an illegal operation (such as division by zero), an error occurs and the original value remains unchanged.
- You cannot directly change any values in the other (non- x) columns of the table.

■ Copying a Table Column to a List

A simple operation lets you copy the contents of a numeric table column into a list.

Use ◀ and ▶ to move the cursor to the column you want to copy. The cursor can be in any row.

• To copy a table to a list

Example To copy the contents of Column x into List 1

OPTN F1 (LISTMEM)

Input the number of the list you want to copy and then press EXE.

1 EXE

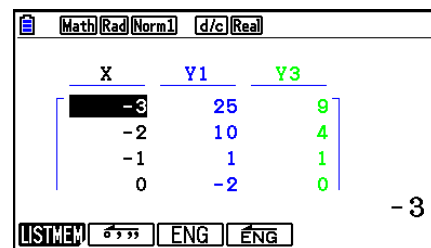
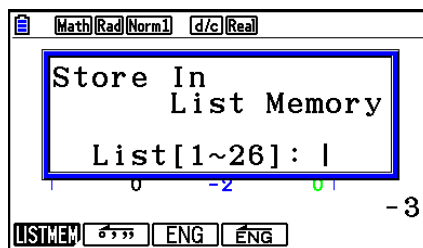

- The color of the text in the list where you perform the paste operation will be black.
-

■ Drawing a Graph from a Number Table

Use the following procedure to generate a number table and then draw a graph based on the values in the table.

1. From the Main Menu, enter the **Table** mode.
2. Configure V-Window settings.
3. Store the functions.
4. Specify the table range.
5. Generate the table.
6. Select the graph type and draw it.

F5 (GPH-CON) ... line graph

F6 (GPH-PLT) ... plot type graph

- After drawing the graph, pressing SHIFT F6 (G↔T) or AC returns to the number table screen.

Example Store the two functions below, generate a number table, and then draw a line graph. Specify a range of -3 to 3 , and an increment of 1 .

$$Y1 = 3x^2 - 2, \quad Y2 = x^2$$

Use the following V-Window settings.

$$Xmin = 0, \quad Xmax = 6, \quad Xscale = 1$$

$$Ymin = -2, \quad Ymax = 10, \quad Yscale = 2$$

- ① **MENU** Table
- ② **SHIFT** **F3** (V-WIN) **0** **EXE** **6** **EXE** **1** **EXE** **▼**
(←) **2** **EXE** **1** **0** **EXE** **2** **EXE** **EXIT**
- ③ **F3** (TYPE) **F1** (Y=) **3** **X,θ,T** **x²** **-** **2** **EXE**
X,θ,T **x²** **EXE**
- ④ **F5** (SET) **(←)** **3** **EXE** **3** **EXE** **1** **EXE** **EXIT**
- ⑤ **F6** (TABLE)
- ⑥ **F5** (GPH-CON)



- You can use Trace, Zoom, or Sketch after drawing a graph.
- You can use the graph screen to change the properties of a graph after you draw using a number table. For details, see “To change graph properties from the graph screen” (page 5-16).

■ Simultaneously Displaying a Number Table and Graph

Specifying “T+G” for “Dual Screen” on the Setup screen makes it possible to display a number table and graph at the same time.

1. From the Main Menu, enter the **Table** mode.
2. Configure V-Window settings.
3. On the Setup screen, select “T+G” for “Dual Screen”.
4. Input the function.
5. Specify the table range.
6. The number table is displayed in the sub-screen on the right.
7. Specify the graph type and draw the graph.

F5 (GPH-CON) ... line graph

F6 (GPH-PLT) ... plot type graph

Example Store the function $Y1 = 3x^2 - 2$ and simultaneously display its number table and line graph. Use a table range of -3 to 3 with an increment of 1 .

Use the following V-Window settings.

Xmin = 0, Xmax = 6, Xscale = 1

Ymin = -2, Ymax = 10, Yscale = 2

- ① **MENU** Table
- ② **SHIFT** **F3** (V-WIN) **0** **EXE** **6** **EXE** **1** **EXE** **↵**
↵ **2** **EXE** **1** **0** **EXE** **2** **EXE** **EXIT**
- ③ **SHIFT** **MENU** (SET UP) **↵** **↵** **↵** **F1** (T+G) **EXIT**
- ④ **F3** (TYPE) **F1** (Y=) **3** **X,θ,T** **x²** **=** **2** **EXE**
- ⑤ **F5** (SET)
↵ **3** **EXE** **3** **EXE** **1** **EXE** **EXIT**
- ⑥ **F6** (TABLE)
- ⑦ **F5** (GPH-CON)

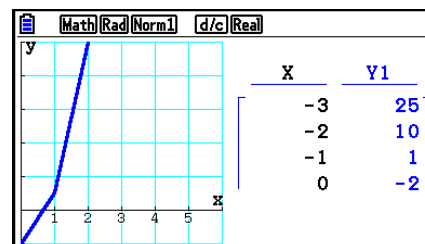

- The Setup screen's "Dual Screen" setting is applied in the **Table** mode and the **Recursion** mode.
- You can make the number table active by pressing **OPTN** **F1** (CHANGE) or **AC**.

8. Modifying a Graph

A Modify function lets you modify the value of a variable in a graph expression (for example, the value of A in $Y = AX^2$) from the graph screen and view how the change affects the graph.

■ Modify Function Overview

The Modify function can be used in the **Graph** mode and **Conic Graphs** mode. To execute the Modify function in the **Graph** mode, display the graph relation list screen and press **F5** (MODIFY). In the **Conic Graphs** mode, display the coefficients input screen and press **F1** (MODIFY).

The following shows an example of the graph screen while the Modify function is running.

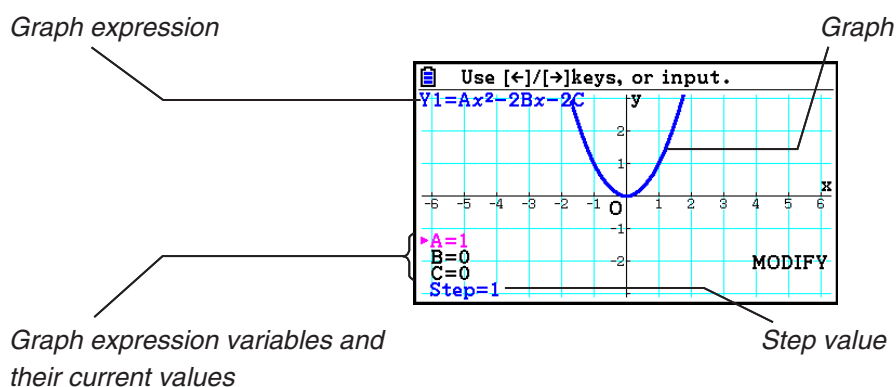

- The graph expression variables and their current values, and a step value are displayed in the lower left corner of the screen while the Modify function is running. The variable (or step value) that you can modify is displayed in magenta.
- Use ◀ and ▶ to modify the value of the magenta colored variable. Each press of ◀ or ▶ changes the magenta value by the amount specified by the step value.

Important!

- You can use the Modify function to modify only one graph expression, and the graph expression being modified can contain at least one and no more than five variables. If these conditions are not satisfied, attempting to execute the Modify function will cause an error. When there are multiple expressions graphed and only one of them includes variables, you can execute the Modify function to simultaneously graph the expression that contains the variables and the expressions that do not contain any variables.
- Note that the Modify function cannot be executed in the case when there is more than one expression containing variables.

■ Modify Function Operations

• To modify a graph in the Graph mode

1. From the Main Menu, enter the **Graph** mode.
2. On the Setup screen, change the “Dual Screen” setting to “Off”.
3. Configure V-Window settings.
4. Specify the function type and enter a function that contains variables.
 - In addition to manual input, you also can input expression containing variables using the built-in function type list that appears when you press **F4** (TOOL) **F3** (BUILT-IN). The content of the built-in function type list is the same as that in the **Dyna Graph** mode (page 5-40).
5. Press **F5** (MODIFY) to execute the Modify function.
 - This will draw the graph function you entered in step 4.
6. Use **▲** and **▼** to select Step (which will change its color to magenta) and then use the number keys to enter a step value.
7. Use **▲** and **▼** to select the variable you want to modify.
8. Use **◀** and **▶** to change the selected variable value by the unit specified by the step setting.
 - You also can enter the variable value directly.
9. To exit the Modify operation, press **EXIT**.

Example To register the graph expression $y = x^2 - Ax$ (A initial value = 0) and specify a step of 0.5, and then observe changes in the graph as the value of A changes from 0.5 to 2. Next, enter a value of -2 for the value of A and observe how the graph changes. Use initialized (INITIAL) V-Window settings.

- ① **MENU** Graph
- ② **SHIFT** **MENU** (SET UP) **▼** **▼** **▼** **▼** **F3** (Off) **EXIT**
- ③ **SHIFT** **F3** (V-WIN) **F1** (INITIAL) **EXIT**
- ④ **F3** (TYPE) **F1** (Y=) **X,θ,T** **x²** **=** **ALPHA** **X,θ,T** (A) **X,θ,T** **EXE**
- ⑤ **F5** (MODIFY)
- ⑥ **▼** **0** **.** **5** **EXE**
- ⑦ **▲**
- ⑧ **▶** **▶** **▶** **▶**

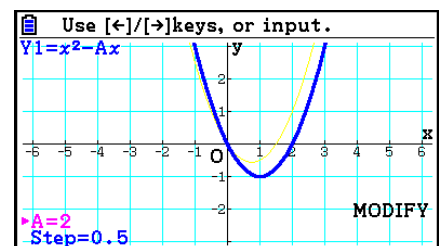
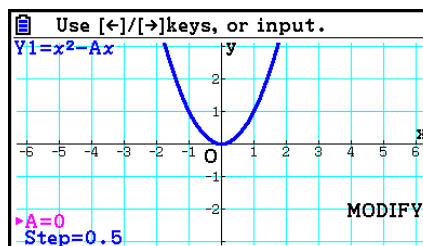

9 (←) 2 EXE

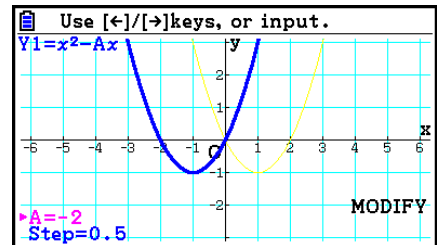

10 EXIT

• To modify a graph in the Conic Graphs mode

Example In the Conic Graphs mode, register the parametric equation $X = H + T$; $Y = K + AT^2$ and the initial values $A=2$, $H=0$, $K=0$. Next, use the Modify function to change H to -1 and then change K to -1 , and observe the changes in the graph.

1. From the Main Menu, enter the **Conic Graphs** mode.
2. Press **F3** (PARAM) to display the parametric equation list.
3. Use **▼** to move the highlighting to $X = H + T$; $Y = K + AT^2$ and then press **EXE**.
 - This will display a coefficients input screen.

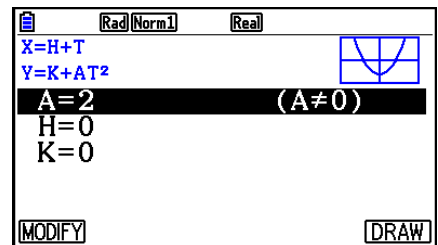

4. Perform the following key operation to input $A=2$, $H=0$, $K=0$.

2 EXE 0 EXE 0 EXE

5. Press **F1** (MODIFY) to execute the Modify function.

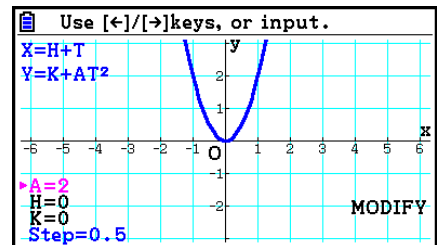

6. Press **▼**. Check to make sure that the $H=0$ line is magenta colored and then press **(←) 1 EXE**.

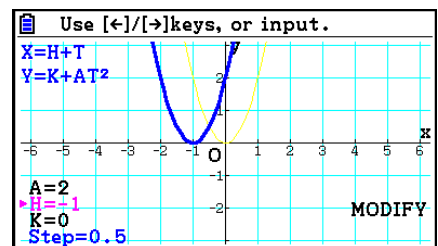

7. Press \blacktriangledown . Check to make sure that the $K=0$ line is magenta colored and then press \leftarrow **1** **EXE**.

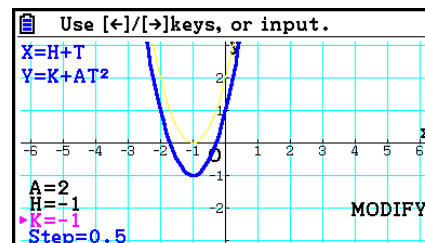

8. To exit the Modify operation, press **EXIT**.

■ Copying a Graph Expression to the Graph Relation List while the Modify Function is Running

You can use the following procedure to copy the expression (including its currently assigned coefficient values) used to draw a graph with the Modify function.

1. While the graph to be copied is displayed and Modify function is running, press **OPTN** **F1** (COPY).
 - This displays the graph relation list screen.
2. Use \blacktriangle and \blacktriangledown to move the highlighting to the area to which you want to copy the graph expression.
3. Press **EXE**.
 - This copies the expression and returns to the graph screen.
 - You can view the copied expression by pressing **EXIT** twice and displaying the graph relation list screen.

Important!

- If you select an area that already contains an expression in step 2 of the above procedure, pressing **EXE** in step 3 will overwrite the existing expression with the new one.
- Selecting the area where an expression that is being used for graphing (one whose "=" symbol is highlighted) in step 2 of the above procedure and pressing **EXE** in step 3 will cause the message "Expression in use" to appear. No copy operation is performed in this case.

9. Dynamic Graphing

■ Using Dynamic Graph

Dynamic Graph lets you define a range of values for the coefficients in a function, and then observe how a graph is affected by changes in the value of a coefficient. It helps to see how the coefficients and terms that make up a function influence the shape and position of a graph.

1. From the Main Menu, enter the **Dyna Graph** mode.

2. Configure V-Window settings.

3. On the Setup screen, specify the Dynamic Type.

F1(Cont) ... Continuous

F2(Stop) ... Automatic stop after 10 draws

4. Use the cursor keys to select the function type on the built-in function type list.*¹

5. If required, press **SHIFT** **F5**(FORMAT) and use the dialog box that appears to specify the graph color.

6. Input values for coefficients, and specify which coefficient will be the dynamic variable.*²

7. Specify the start value, end value, and increment.

8. Specify the drawing speed.

F3(SPEED) **F1**(III).... Pause after each draw (Stop&Go)*³

F2(>) Half normal speed (Slow)

F3(▶) Normal speed (Normal)

F4(>>)..... Twice normal speed (Fast)

9. Draw the Dynamic Graph.

*¹ The following are the seven built-in function types.

• $Y = Ax + B$

• $Y = A(x - B)^2 + C$

• $Y = Ax^2 + Bx + C$

• $Y = Ax^3 + Bx^2 + Cx + D$

• $Y = A \sin(Bx + C)$

• $Y = A \cos(Bx + C)$

• $Y = A \tan(Bx + C)$

After you press **F3**(TYPE) and select the function type you want, you can then input the actual function.

*² You could also press **EXE** here and display the parameter setting menu.

*³ When “Stop&Go” is selected as the drawing speed, starting a Dynamic Graph draw operation will cause drawing of the graph with the initial variable values to stop. Each press of **EXE** sequentially displays the graph of the next variable value. Also, you can scroll to the graph of the next variable value by pressing **▶** (or **+**) or to the graph of the previous variable value by pressing **◀** (or **-**). To exit the Dynamic Graph draw operation, press **EXIT**.

• The message “Too Many Functions” appears when more than one function is selected for Dynamic Graphing.

Example Use Dynamic Graph to graph $y = A(x - 1)^2 - 1$, in which the value of coefficient A changes from 2 through 5 in increments of 1. The graph is drawn 10 times.

- ① **MENU** Dyna Graph
- ② **SHIFT** **F3** (V-WIN) **F1** (INITIAL) **EXIT**
- ③ **SHIFT** **MENU** (SET UP) **▼** **F2** (Stop) **EXIT**
- ④ **F5** (BUILT-IN) **▼** **F1** (SELECT)
- ⑤ **SHIFT** **5** (FORMAT) **1** (Black)
- ⑥ **F4** (VAR) **2** **EXE** **1** **EXE** **(←)** **1** **EXE**
- ⑦ **F2** (SET) **2** **EXE** **5** **EXE** **1** **EXE** **EXIT**
- ⑧ **F3** (SPEED) **F3** (▶) **EXIT**
- ⑨ **F6** (DYNA)

Repeats from ① through ④.

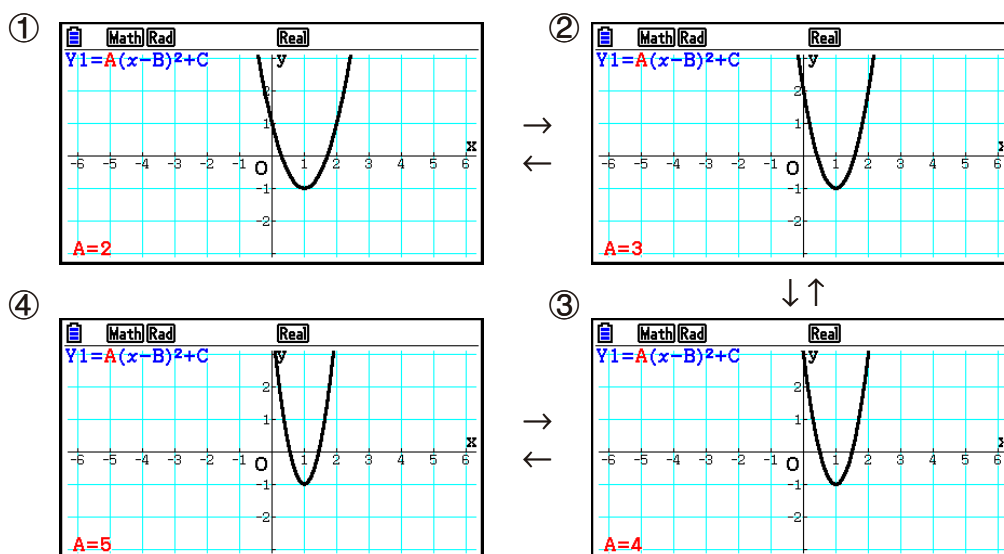

■ Drawing a Dynamic Graph Locus

Turning on the Dynamic Graph locus setting on the Setup screen lets you overlay a graph drawn by changing the coefficient values.

1. From the Main Menu, enter the **Dyna Graph** mode.
2. Configure V-Window settings.
3. On the Setup screen, select “On” for “Locus”.
4. Use the cursor keys to select the function type on the built-in function type list.
5. Input values for coefficients, and specify which coefficient will be the dynamic variable.
6. Specify the start value, end value, and increment.
7. Specify “Normal” for the draw speed.
8. Draw the Dynamic Graph.

Example Use Dynamic Graph to graph $y = Ax$, in which the value of coefficient A changes from 1 through 4 in increments of 1. The Graph is drawn 10 times.

- ① **MENU** Dyna Graph
- ② **SHIFT** **F3** (V-WIN) **F1** (INITIAL) **EXIT**
- ③ **SHIFT** **MENU** (SET UP) **▼** **▼** **F1** (On) **EXIT**
- ④ **F5** (BUILT-IN) **F1** (SELECT)
- ⑤ **F4** (VAR) **1** **EXE** **0** **EXE**
- ⑥ **F2** (SET) **1** **EXE** **4** **EXE** **1** **EXE** **EXIT**
- ⑦ **F3** (SPEED) **F3** (▶) **EXIT**
- ⑧ **F6** (DYNA)

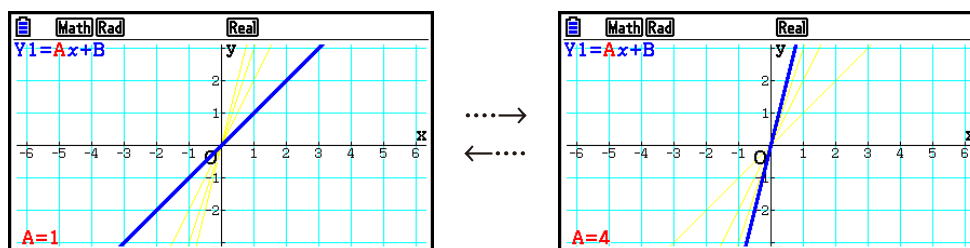

■ Graph Calculation DOT Switching Function

Use this function to specify drawing of all the dots on the Dynamic Graph x -axis, or every other dot. This setting is value for “Dynamic Func Y=” graphic only.

1. Press **SHIFT** **MENU** (SET UP) to display the Setup screen.
2. Press **▼** **▼** **▼** to select “Y=Draw Speed”.
3. Select the graphing method.
 - F1** (Norm) ... Draws all x -axis dots. (initial default)
 - F2** (High) ... Draws every other x -axis dot. (faster drawing than Normal)
4. Press **EXIT**.

■ Using Dynamic Graph Memory

You can store Dynamic Graph conditions data in Dynamic Graph memory for later recall when you need it. This lets you save time, because you can recall the data and immediately begin a Dynamic Graph draw operation. Note that you can store one set of data in memory at any one time.

• To save data in Dynamic Graph memory

1. While a Dynamic Graph draw operation is being performed, press **[AC]** to change to the speed adjustment menu.
2. Press **[F5]** (STORE). In response to the confirmation dialog that appears, press **[F1]** (Yes) to save the data.

• To recall data from Dynamic Graph memory

1. Display the Dynamic Graph relation list.
2. Pressing **[F6]** (RECALL) recalls Dynamic Graph memory contents and draws the graph.

10. Graphing a Recursion Formula

■ Generating a Number Table from a Recursion Formula

You can input up to three of the following types of recursion formulas and generate a number table.

- General term of sequence $\{a_n\}$, composed of a_n, n
- Linear two-term recursion composed of a_{n+1}, a_n, n
- Linear three-term recursion composed of a_{n+2}, a_{n+1}, a_n, n

1. From the Main Menu, enter the **Recursion** mode.
2. Specify the recursion type.

- [F3]** (TYPE) **[F1]** (a_n) ... {general term of sequence a_n }
- [F2]** (a_{n+1}) ... {linear two-term recursion}
- [F3]** (a_{n+2}) ... {linear three-term recursion}

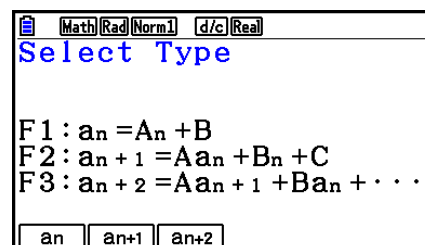

3. Input the recursion formula.
4. Specify the table range. Specify a start point and end point for n . If necessary, specify a value for the initial term, and a pointer start point value if you plan to graph the formula.
5. Display the recursion formula number table.

Example Generate a number table from recursion between three terms as expressed by $a_{n+2} = a_{n+1} + a_n$, with initial terms of $a_1 = 1, a_2 = 1$ (Fibonacci sequence), as n changes in value from 1 to 6.

- ① **MENU** Recursion
- ② **F3** (TYPE) **F3** (a_{n+2})
- ③ **F4** ($n.a_n \dots$) **F3** (a_{n+1}) **+** **F2** (a_n) **EXE**
- ④ **F5** (SET) **F2** (a_1) **1** **EXE** **6** **EXE** **1** **EXE** **1** **EXE** **EXIT**
- ⑤ **F6** (TABLE)

$n+2$	a_{n+2}
1	1
2	1
3	2
4	3

* The first two values correspond to $a_1 = 1$ and $a_2 = 1$.

- Pressing **F1** (FORMULA) will return to the screen for storing recursion formulas.
- Specifying “On” for the “ Σ Display” of the Setup screen causes the sum of each term to be included in the table.

■ Graphing a Recursion Formula

After generating a number table from a recursion formula, you can graph the values on a line graph or plot type graph.

1. From the Main Menu, enter the **Recursion** mode.
2. Configure V-Window settings.
3. Specify the recursion formula type and input the formula.
4. Specify the table range, and start and ending values for n . If necessary, specify the initial term value and pointer start point.
5. Select the line style for the graph.
6. Display the recursion formula number table.
7. Specify the graph type and draw the graph.

F5 (GPH-CON) ... line graph

F6 (GPH-PLT) ... plot type graph

Example Generate a number table from recursion between two terms as expressed by $a_{n+1} = 2a_n + 1$, with an initial term of $a_1 = 1$, as n changes in value from 1 to 6. Use the table values to draw a line graph.

Use the following V-Window settings.

Xmin = 0, Xmax = 6, Xscale = 1

Ymin = -15, Ymax = 65, Yscale = 5

- ① **MENU** Recursion
- ② **SHIFT** **F3** (V-WIN) **0** **EXE** **6** **EXE** **1** **EXE** **▼**
(-) **1** **5** **EXE** **6** **5** **EXE** **5** **EXE** **EXIT**
- ③ **F3** (TYPE) **F2** (a_{n+1}) **2** **F2** (a_n) **+** **1** **EXE**
- ④ **F5** (SET) **F2** (a_1) **1** **EXE** **6** **EXE** **1** **EXE** **EXIT**
- ⑤ **F1** (SEL+S) **▲** **F2** (—) **EXIT**
- ⑥ **F6** (TABLE)
- ⑦ **F5** (GPH-CON)

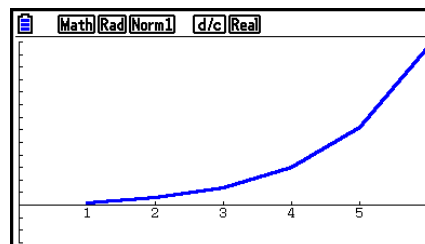

- You can change the graph line color and line style from the recursion formula screen and from the graph screen. To change from the recursion formula screen, see “To change graph properties from the graph relation list screen” (page 5-15). To change from the graph screen, see “To change graph properties from the graph screen” (page 5-16).
- After drawing a graph, you can use Trace, Zoom, and Sketch.
- Press **AC** to return to the number table screen. After drawing a graph, you can toggle between the number table screen and graph screen by pressing **SHIFT** **F6** ($G \leftrightarrow T$).

■ Graphing a Phase Plot from Two Numeric Sequences

You can draw the phase plot for numeric sequences generated by two expressions input in the **Recursion** mode with one value on the horizontal axis and the other value on the vertical axis. For a_n (a_{n+1} , a_{n+2}), b_n (b_{n+1} , b_{n+2}), c_n (c_{n+1} , c_{n+2}), the numeric sequence of the alphabetically first expression is on the horizontal axis while the following numeric sequence is on the vertical axis.

1. From the Main Menu, enter the **Recursion** mode.
2. Configure V-Window settings.
3. Enter two recursion formulas and select both of them for table generation.
4. Configure table generation settings.
Specify the start and end values for variable n and the initial term for each recursion formula.
5. Display the recursion formula number table.
6. Draw the phase plot.

Example To input the two sequence formulas for regression between two terms $a_{n+1} = 0.9a_n$ and $b_{n+1} = b_n + 0.1n - 0.2$, and specify initial terms $a_1 = 1$ and $b_1 = 1$ for each. Generate a number table as the value of the n variable goes from 1 to 10 and use it to draw a phase plot.

Use the following V-Window settings.

Xmin = 0, Xmax = 2, Xscale = 1
Ymin = 0, Ymax = 4, Yscale = 1

- ① **MENU** Recursion
- ② **SHIFT** **F3** (V-WIN) **0** **EXE** **2** **EXE** **1** **EXE** **▼**
0 **EXE** **4** **EXE** **1** **EXE** **EXIT**
- ③ **F3** (TYPE) **F2** (a_{n+1}) **0** **◦** **9** **F2** (a_n) **EXE**
F4 ($n.a_n \dots$) **F3** (b_n) **+** **0** **◦** **1** **F1** (n) **-** **0** **◦** **2** **EXE**
- ④ **F5** (SET) **F2** (a_1) **1** **EXE** **1** **0** **EXE** **1** **EXE** **1** **EXE** **1** **EXE** **EXIT**
- ⑤ **F6** (TABLE)

n+1	a_{n+1}	b_{n+1}
1	1	1
2	0.9	0.9
3	0.81	0.9
4	0.729	1

1

FORMULA DELETE PHASE WEB-GPH GPH-CON GPH-PLT

- ⑥ **F3** (PHASE)

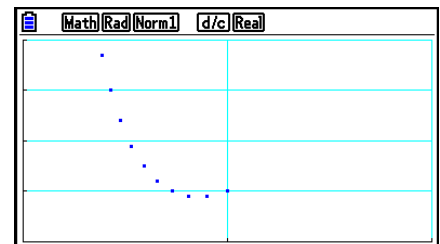

- The color used for phase plotting is the color assigned to the initial expression. When phase plotting from expression a_n and expression b_n , for example, the color will be that of expression a_n .
- If you enter three expressions on the **Recursion** mode screen and select all of them for table creation, you will need to specify which two of the three expressions you want to use to draw the phase plot. To do so, use the function menu that appears when you press **F3** (PHASE) on the table screen.

- F1** ($a \cdot b$)..... Graph using a_n (a_{n+1}, a_{n+2}) and b_n (b_{n+1}, b_{n+2}).
- F2** ($b \cdot c$)..... Graph using b_n (b_{n+1}, b_{n+2}) and c_n (c_{n+1}, c_{n+2}).
- F3** ($a \cdot c$)..... Graph using a_n (a_{n+1}, a_{n+2}) and c_n (c_{n+1}, c_{n+2}).

n+1	a_{n+1}	b_{n+1}	c_{n+1}
1	1	1	0
2	0.9	0.9	0
3	0.81	0.9	0
4	0.729	1	0

1

a·b b·c a·c

- Specifying “On” for the “ Σ Display” of the Setup screen causes the sum of each term to be included in the table. At this time you can select use of the two numeric sequences as-is to draw the plot graph, or use of the sums of each of the two numeric sequences. To do so, use the function menu that appears when you press **F3** (PHASE) on the table screen.

- F1** (a_n) Use numeric sequence for graphing.
- F6** (Σa_n)..... Use numeric sequence sums for graphing.

n+1	a_{n+1}	Σa_{n+1}	b_{n+1}
1	1	1	1
2	0.9	1.9	0.9
3	0.81	2.71	0.9
4	0.729	3.439	1

1

a_n Σa_n

- When “On” is selected “ΣDisplay” on the Setup screen and all three of the expressions you input in the **Recursion** mode are selected for table creation, use the function menu that appears when you press **F3** (PHASE) on the table screen to specify which two of the expressions you want to use, and to specify whether you want to use numeric sequence data or numeric sequence sum data.

- F1** ($a \cdot b$) Graph using number sequences a_n (a_{n+1}, a_{n+2}) and b_n (b_{n+1}, b_{n+2})
- F2** ($b \cdot c$) Graph using number sequences b_n (b_{n+1}, b_{n+2}) and c_n (c_{n+1}, c_{n+2})
- F3** ($a \cdot c$) Graph using number sequences a_n (a_{n+1}, a_{n+2}) and c_n (c_{n+1}, c_{n+2})
- F4** ($\Sigma a \cdot b$) Graph using the sums of number sequences a_n (a_{n+1}, a_{n+2}) and b_n (b_{n+1}, b_{n+2})
- F5** ($\Sigma b \cdot c$) Graph using the sums of number sequences b_n (b_{n+1}, b_{n+2}) and c_n (c_{n+1}, c_{n+2})
- F6** ($\Sigma a \cdot c$) Graph using the sums of number sequences a_n (a_{n+1}, a_{n+2}) and c_n (c_{n+1}, c_{n+2})

Select Type			
n+1	a _{n+1}	Σa _{n+1}	b _{n+1}
1	1	1	1
2	0.9	1.9	0.9
3	0.81	2.71	0.9
4	0.729	3.439	1
			1

a·b b·c a·c Σa·b Σb·c Σa·c

■ WEB Graph (Convergence, Divergence)

$y = f(x)$ is graphed by presuming $a_{n+1} = y$, $a_n = x$ for linear two-term recursion $a_{n+1} = f(a_n)$ composed of a_{n+1}, a_n . Next, it can be determined whether the function is convergent or divergent.

1. From the Main Menu, enter the **Recursion** mode.
2. Configure V-Window settings.
3. Select 2-term recursion as the recursion formula type, and input the formula.
4. Specify the table range, n start and end points, initial term value, and pointer start point.
5. Display the recursion formula number table.
6. Draw the graph.
7. Press **EXE**, and the pointer appears at the start point you specified.
Press **EXE** several times.

If convergence exists, lines that resemble a spider web are drawn on the display. Failure of the web lines to appear indicates either divergence or that the graph is outside the boundaries of the display screen. When this happens, change to larger V-Window values and try again.

You can use **▲** **▼** to select the graph.

Example To draw the WEB graph for the recursion formula $a_{n+1} = -3(a_n)^2 + 3a_n$, $b_{n+1} = 3b_n + 0.2$, and check for divergence or convergence. Use the following table range: Start = 0, End = 6, $a_0 = 0.01$, $a_n\text{Str} = 0.01$, $b_0 = 0.11$, $b_n\text{Str} = 0.11$

- ① **MENU** Recursion
- ② **SHIFT** **F3** (V-WIN) **0** **EXE** **1** **EXE** **1** **EXE** **▼**
0 **EXE** **1** **EXE** **1** **EXE** **EXIT**
- ③ **F3** (TYPE) **F2** (a_{n+1}) **(←)** **3** **F2** (a_n) **x²** **+** **3** **F2** (a_n) **EXE**
3 **F3** (b_n) **+** **0** **.** **2** **EXE**
- ④ **F5** (SET) **F1** (a_0)
0 **EXE** **6** **EXE** **0** **.** **0** **1** **EXE** **0** **.** **1** **1** **EXE** **▼**
0 **.** **0** **1** **EXE** **0** **.** **1** **1** **EXE** **EXIT**
- ⑤ **F6** (TABLE)
- ⑥ **F4** (WEB-GPH)
- ⑦ **EXE** ~ **EXE** (a_n is convergence)
▼ **EXE** ~ **EXE** (b_n is divergence)

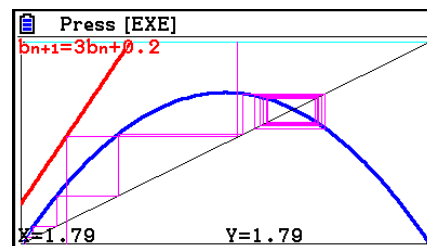

- To change the graph line style, press **F1** (SEL+S) after step 4.
- With WEB Graph, you can specify the line type for a $y = f(x)$ graph. The line type setting is valid only when “Connect” is selected for “Draw Type” on the Setup screen.

11. Graphing a Conic Section

■ Graphing a Conic Section

You can use the **Conic Graphs** mode to graph parabolas, circles, ellipses, and hyperbolas. You can input a rectangular coordinate function, polar coordinate function, or parametric function for graphing.

1. From the Main Menu, enter the **Conic Graphs** mode.
2. Select the function type.

F1 (RECT).... {rectangular coordinate}

F2 (POL).... {polar coordinate}

F3 (PARAM).... {parametric}

3. Select the pattern of the function in accordance with the type of graph you want to draw.

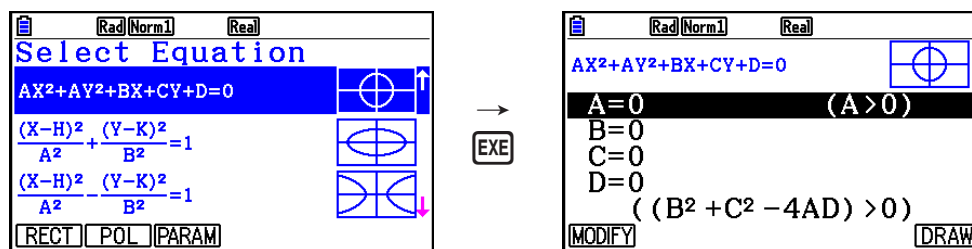

4. Enter the coefficients of the function and draw the graph.

Example To input the rectangular coordinate function $x = 2y^2 + y - 1$ and graph a parabola open on the right, and then input the polar coordinate function $r = 4\cos\theta$ and draw a circle graph.

- ① **[MENU]** Conic Graphs
- ② **[F1]** (RECT) **[▼]** ($X=AY^2+BY+C$) **[EXE]**
- ③ **[2]** **[EXE]** **[1]** **[EXE]** **[(-)]** **[1]** **[EXE]** **[F6]** (DRAW)
- ④ **[EXIT]** **[EXIT]**
- ⑤ **[F2]** (POL) **[▼]** **[▼]** **[▼]** **[▼]** ($R=2A\cos\theta$) **[EXE]**
- ⑥ **[2]** **[EXE]** **[F6]** (DRAW)

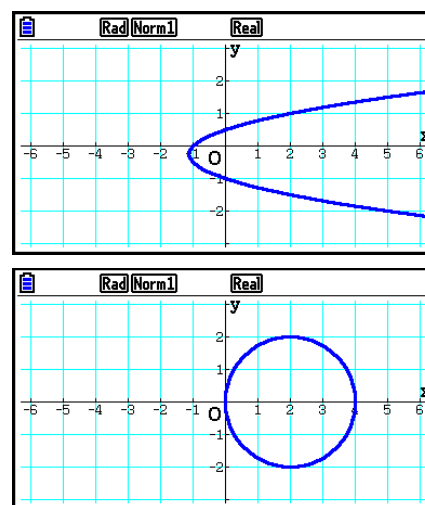

- In the **Conic Graphs** mode, you can press **[F1]** (MODIFY) in place of **[F6]** (DRAW) while the coefficients input screen is displayed and modify the value of the coefficients on the graph screen, and observe changes in the graph due to the modifications. For details, see "Modifying a Graph" (page 5-36).
- In the **Conic Graphs** mode, you can press **[SHIFT]** **[5]** (FORMAT) while any screen is displayed to display a dialog box for changing the graph color.

12. Drawing Dots, Lines, and Text on the Graph Screen (Sketch)

The sketch function lets you draw points and lines inside of graphs. You can select one of five different line styles and seven colors for drawing with the sketch function.

• To draw dots, lines, and text on the graph screen

1. From the Main Menu, enter the **Graph** mode.
2. Configure V-Window settings.
3. On the Setup screen, configure the following settings as required.
 - Sketch Line ... Initial default line style when drawing a line
 - Plot/LineCol ... Initial default color when drawing a plot, line, or text
4. Input the function of the graph.
5. Draw the graph.
6. Select the sketch function you want to use.*¹
 - SHIFT** **F4** (SKETCH) **F1** (Cls) ... Screen clear
 - F2** (Tangent) ... Tangent line
 - F3** (Norm) ... Line normal to a curve
 - F4** (Inverse) ... Inverse function*²
 - F6** (\triangleright) **F1** (PLOT)
 - {Plot}/{PlotOn}/{PlotOff}/{PlotChg} ... Point {Plot}/{On}/{Off}/{Change}
 - F6** (\triangleright) **F2** (LINE)
 - {Line}/{F-Line} ... {connects 2 points plotted by **F6** (\triangleright) **F1** (PLOT) with a line}/{for drawing a line between any 2 points}
 - F6** (\triangleright) **F3** (Circle) ... Circle
 - F6** (\triangleright) **F4** (Vertical) ... Vertical line
 - F6** (\triangleright) **F5** (Horz) ... Horizontal line
 - F6** (\triangleright) **F6** (\triangleright) **F1** (PEN) ... Freehand
 - F6** (\triangleright) **F6** (\triangleright) **F2** (Text) ... Text input
7. Press **SHIFT** **5** (FORMAT) to display the format dialog box, and then configure color and line style settings.
 - You can specify the line color while Tangent, Norm, Line, F-Line, Circle, Vertical, Horz, or PEN is selected.
 - You can specify the line color while Plot, PlotOn, PlotChg, or Text is selected.
 - To close the format dialog box, press **EXIT**.

8. Use the cursor keys to move the pointer (⊕) to the location where you want to draw, and press **EXE**.^{*3}

*1 The above shows the function menu that appears in the **Graph** mode. Menu items may differ somewhat in other modes.

*2 In the case of an inverse function graph, drawing starts immediately after you select this option. The line style and color setting selected for the Setup screen “Sketch Line” and “Plot/LineCol” settings are always applied for an inverse function graph.

*3 Some sketch functions require specification of two points. After you press **EXE** to specify the first point, use the cursor keys to move the pointer to the location of the second point and press **EXE**.

Example **Draw a line that is tangent to point (2, 0) on the graph for $y = x(x + 2)(x - 2)$.**

- ① **MENU** Graph
- ② **SHIFT** **F3** (V-WIN) **F1** (INITIAL) **EXIT**
- ③ **SHIFT** **MENU** (SET UP) **▼** **▼** **▼** **▼** **▼** **▼** **▼** **F1** (COLOR) **1** (Black)
▼ **F1** (—) **EXIT**
- ④ **F3** (TYPE) **F1** (Y=) **X,θ,T** **(** **X,θ,T** **+** **2** **)** **(** **X,θ,T**
= **2** **)** **EXE**
- ⑤ **F6** (DRAW)
- ⑥ **SHIFT** **F4** (SKETCH) **F2** (Tangent)
- ⑦ **SHIFT** **5** (FORMAT) **1** (Line Style) **5** (Thin)
2 (Line Color) **3** (Red) **EXIT**
- ⑧ **▶** ~ **▶** **EXE** ^{*1}

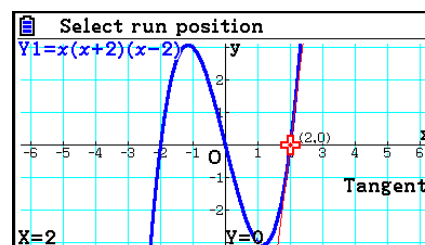

*1 You can draw a tangent line in succession by moving the ⊕ pointer and pressing **EXE**.

13. Function Analysis

■ Reading Coordinates on a Graph Line

Trace lets you move a pointer along a graph and read out coordinates on the display.

1. From the Main Menu, enter the **Graph** mode.
2. Draw the graph.
3. Press **[SHIFT] [F1]** (TRACE), and a pointer appears in the center of the graph.*1
4. Use **[◀]** and **[▶]** to move the pointer along the graph to the point at which you want to display the coordinates.

When there are multiple graphs on the display, press **[▲]** and **[▼]** to move between them along the x -axis of the current pointer location.

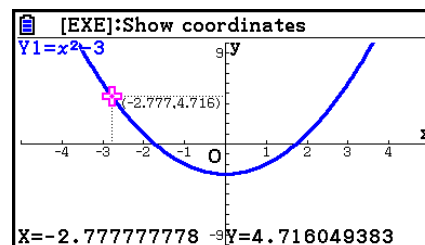

- At this time, pointer coordinate values appear at the bottom of the screen and to the right (or left) of the pointer. Also, supplementary lines appear from the pointer to the x -axis and y -axis.
 - You can hide the supplementary lines by pressing **[SHIFT] [▼]**. To redisplay hidden lines, press **[SHIFT] [▲]**.
5. You can also move the pointer by pressing **[X,θ,T]** to display the pop-up window, and then inputting an x value.

The pop-up window appears even when you input an x value directly.

To exit a trace operation, press **[SHIFT] [F1]** (TRACE).

*1 The pointer is not visible on the graph when it is located at a point outside the graph display area or when an error of no value occurs.

- You can turn off display of the coordinates at the pointer location by specifying “Off” for the “Coord” item on the Setup screen.
- The following shows how coordinates are displayed for each function type.

Polar Coordinate Graph

$r=1.840622763$	$\theta=0.3769911184$
-----------------	-----------------------

Parametric Graph

$T=0.9424777961$	
$X=4.854101966$	$Y=3.526711514$

Inequality Graph

$(Y \geq, Y \leq, X \geq, X \leq)$	$x=2$	$y=4$
------------------------------------	-------	-------

$(Y >, Y <, X >, X <)$	$x:2$	$y:4$
------------------------	-------	-------

- Pressing $\boxed{\text{EXE}}$ while the \oplus pointer is on a graph (during Trace, G-Solve, etc.) will place a dot at the pointer location along with a label which shows the coordinates at the dot location. Pressing $\boxed{\text{ALPHA}} \boxed{\text{DEL}}$ removes the last dot and coordinate label that was created.

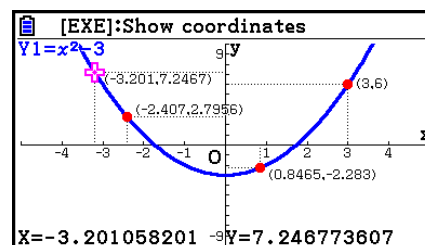

- Dots created with the above operation will appear as \bullet for coordinate values that are included in the graph expression, and \circ for values that are not. For example, a dot at coordinates (2,1) on the graph $Y=2X$ will be \bullet , while a dot at coordinates (2,1) on the graph $Y>2X$ will be \circ .

■ Displaying the Derivative

In addition to using Trace to display coordinates, you can also display the derivative at the current pointer location.

- From the Main Menu, enter the **Graph** mode.
- On the Setup screen, specify “On” for “Derivative”.
- Draw the graph.
- Press $\boxed{\text{SHIFT}} \boxed{\text{F1}}$ (TRACE), and the pointer appears at the center of the graph. The current coordinates and the derivative also appear on the display at this time.

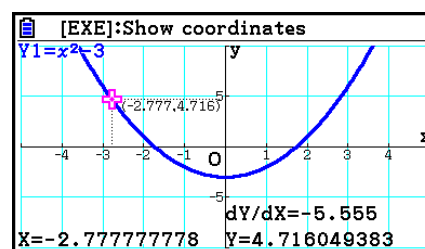

■ Graph to Table

You can use trace to read the coordinates of a graph and store them in a number table. You can also use Dual Graph to simultaneously store the graph and number table, making this an important graph analysis tool.

- From the Main Menu, enter the **Graph** mode.
- On the Setup screen, specify “GtoT” for “Dual Screen”.
- Configure V-Window settings.
- Save the function and draw the graph on the main (left) screen.
- Activate Trace. When there are multiple graphs on the display, press \blacktriangle and \blacktriangledown to select the graph you want.

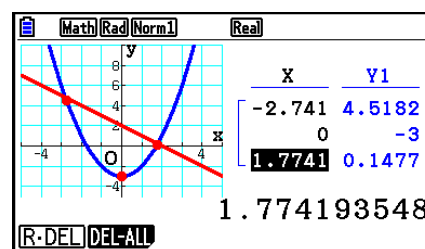

- Use \blacktriangleleft and \blacktriangleright to move the pointer and press $\boxed{\text{EXE}}$ to store coordinates into the number table. Repeat this step to store as many values as you want.
 - Each press of $\boxed{\text{EXE}}$ places a dot on the graph at the current pointer location.
- Press $\boxed{\text{OPTN}} \boxed{\text{F1}}$ (CHANGE) to make the number table active.

Coordinate Rounding

This function rounds off coordinate values displayed by Trace.

1. From the Main Menu, enter the **Graph** mode.
2. Draw the graph.
3. Press **SHIFT** **F2** (ZOOM) **F6** (\triangleright) **F3** (ROUND). This causes the V-Window settings to be changed automatically in accordance with the Rnd value.
4. Press **SHIFT** **F1** (TRACE), and then use the cursor keys to move the pointer along the graph. The coordinates that now appear are rounded.

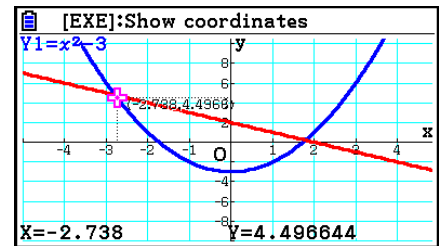

Analyzing Graphs (G-SOLVE Menu)

Pressing **SHIFT** **F5** (G-SOLVE) displays a function menu that contains functions you can use to analyze the currently displayed graph and obtain the following information.

SHIFT **F5** (G-SOLVE) **F1** (ROOT) ... Root of the graph

F2 (MAX) ... Maximum value of the graph

F3 (MIN) ... Minimum value of the graph

F4 (Y-ICEPT) ... y -intercept of the graph

F5 (INTSECT) ... Intersection of two graphs

F6 (\triangleright) **F1** (Y-CAL) ... y -coordinate for a given x -coordinate

F6 (\triangleright) **F2** (X-CAL) ... x -coordinate for a given y -coordinate

F6 (\triangleright) **F3** ($\int dx$) **F1** ($\int dx$) ... Integration value for a specified range

F6 (\triangleright) **F3** ($\int dx$) **F2** (ROOT) ... Integration value between the two or more of the graph's roots

F6 (\triangleright) **F3** ($\int dx$) **F3** (INTSECT) ... Integration value between the two or more intersections of two graphs

F6 (\triangleright) **F3** ($\int dx$) **F4** (MIXED) ... Integration value between a graph root, a point of intersection of two graphs, or any x -coordinate

- Either of the following can cause poor accuracy or even make it impossible to obtain solutions.
 - When the graph of the solution obtained is a point of tangency with the x -axis
 - When a solution is an inflection point

• To calculate the root of a graph

1. Draw a graph.
2. Press **[SHIFT]** **[F5]** (G-SOLVE) **[F1]** (ROOT).
3. If there are multiple graphs on the graph screen, one of them will start flashing. Use **[▲]** and **[▼]** to move the flashing to the graph you want to analyze.
4. To select the flashing graph, press **[EXE]**. This displays the value produced by the analysis.

Example **Graph the function shown below, and then calculate the roots.**

$$Y1 = x^3 - 4x$$

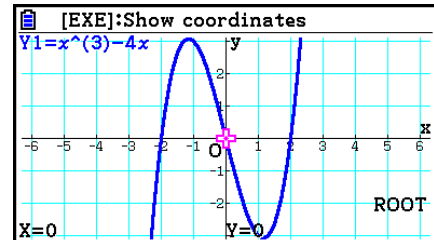
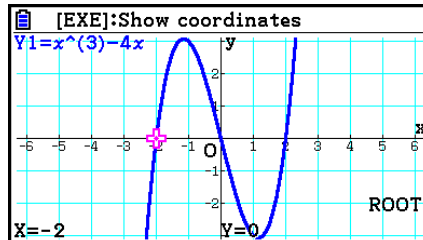

- When an analysis produces multiple values, press **[▶]** to calculate the next value. Pressing **[◀]** returns to the previous value.
- When "On" is selected for the Derivative setting on the Setup screen, the derivative will be displayed along with the root when you calculate the root of a graph using the above procedure.

• To calculate the point of intersection of two graphs

1. Draw the graphs.
2. Press **[SHIFT]** **[F5]** (G-SOLVE) **[F5]** (INTSECT). If there are three or more graphs on the graph screen, one of them will start flashing.
3. Use **[▲]** and **[▼]** to move the flashing to one of the graphs whose point of intersection you want to determine and then press **[EXE]**.
4. Use **[▲]** and **[▼]** to move the flashing to the other graph whose point of intersection you want to determine and then press **[EXE]**.
5. Press **[EXE]** to determine the point of intersection for the two graphs.

When an analysis produces multiple values, press **[▶]** to calculate the next value. Pressing **[◀]** returns to the previous value.

Example Graph the two functions shown below, and determine the point of intersection between Y1 and Y2.

$$Y1 = x + 1, Y2 = x^2$$

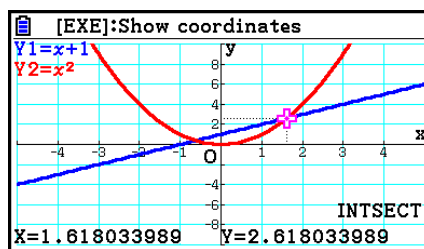
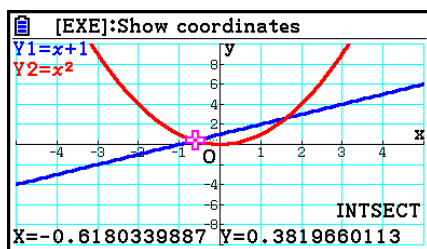

- You can calculate the point of intersection for rectangular coordinate graphs ($Y=f(x)$ type) and inequality graphs ($Y>f(x)$, $Y<f(x)$, $Y\geq f(x)$ or $Y\leq f(x)$) only.
- Either of the following can cause poor accuracy or even make it impossible to obtain solutions.
 - When a solution is a point of tangency between two graphs
 - When a solution is an inflection point

• To determine the coordinates for given points

1. Draw the graph.
2. Select the function you want to perform.

[SHIFT] **[F5]** (G-SOLVE) **[F6]** (\triangleright) **[F1]** (Y-CAL) ... y -coordinate for given x
[F6] (\triangleright) **[F2]** (X-CAL) ... x -coordinate for given y

3. If there are multiple graphs on the graph screen, one of them will start flashing. Use \blacktriangle and \blacktriangledown to move the flashing to the graph you want to select and then press **[EXE]**.
4. Input the given x -coordinate value or y -coordinate value.
 Press **[EXE]** to calculate the corresponding y -coordinate value or x -coordinate value.

Example Graph the two functions shown below and then determine the y -coordinate for $x = 0.5$ and the x -coordinate for $y = 2.2$ on graph Y2.

$$Y1 = x + 1, Y2 = x(x + 2)(x - 2)$$

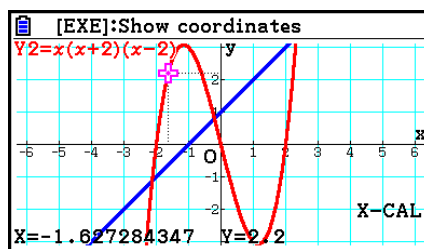
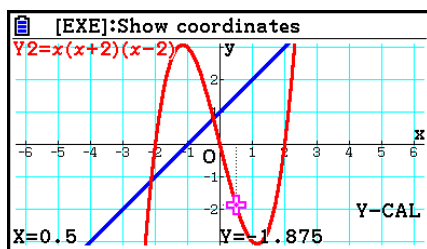

- When there are multiple results for the above procedure, press \blacktriangleright to calculate the next value. Pressing \blacktriangleleft returns to the previous value.
- The X-CAL value cannot be obtained for a parametric function graph.

• To calculate the integral value for a given range

Use the following procedure to obtain integration values for a given range.

1. Draw the graph.
2. Press **SHIFT** **F5** (G-SOLVE) **F6** (\triangleright) **F3** ($\int dx$) **F1** ($\int dx$). If there are multiple graphs on the graph screen, one of them will start flashing.
3. Use \blacktriangle and \blacktriangledown to move the flashing to the graph you want to select and then press **EXE**.
4. Use \blacktriangleleft and \blacktriangleright to move the lower limit pointer to the location you want, and then press **EXE**.
5. Use \blacktriangleright to move the upper limit pointer to the location you want.
 - This displays the calculated integral value at the current pointer location. The integration value changes in accordance with the movement of the pointer.
6. Press **EXE** to fill the integral range.

Example **Graph the function shown below, and then determine the integral value at $(-2, 0)$.**

$$Y1 = x(x + 2)(x - 2)$$

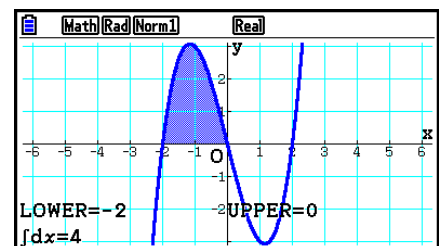

- You can also specify the lower limit and upper limit by inputting them on the 10-key pad.
- When setting the range, make sure that the lower limit is less than the upper limit.
- Integral values can be calculated for rectangular coordinate graphs only.

• To obtain the integration value and area value between two or more roots of a graph

1. Draw a graph.
2. Press **SHIFT** **F5** (G-SOLVE) **F6** (\triangleright) **F3** ($\int dx$) **F2** (ROOT).
 - The pointer will appear at the leftmost root currently on the graph screen.
 - If there is no root on the display, the message "Not Found" will appear. In this case, press **EXIT**.
3. Use \blacktriangleleft and \blacktriangleright to move the pointer to the root you want to use as the lowermost side of the integration region, and then press **EXE**.
4. Use \blacktriangleright to move the pointer to the root you want to use as the uppermost side of the integration region, and then press **EXE**.
 - If there is only one root on the display, the message "Not Found" will appear. In this case, press **EXIT**.
5. Press **EXE** to calculate the integral value and area value.

Example To graph $Y = \sin X$, and then determine the graph integration value and area value for the region between the root of the minus value nearest the origin and the root of the plus value nearest the origin

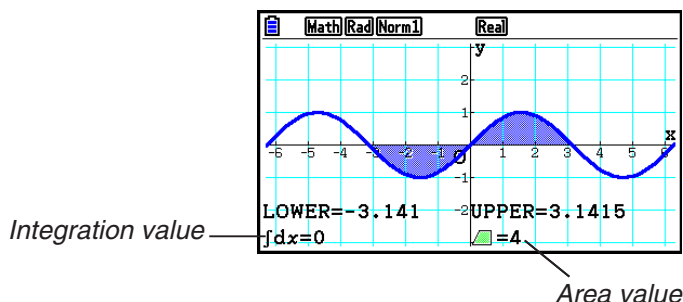

- If there are 21 or more roots between the two roots you specify, an error will occur.
- Integral values and area values can be calculated for rectangular coordinate graphs only.

• To obtain the integration value and area value between two or more intersection points of two graphs

1. Draw two graphs.
2. Press **SHIFT** **F5** (G-SOLVE) **F6** (\triangleright) **F3** ($\int dx$) **F3** (INTSECT).
 - The pointer will appear at the leftmost intersection currently on the graph screen.
 - If there is no intersection point on the display, the message “Not Found” will appear. In this case, press **EXIT**.
3. Use **◀** and **▶** to move the pointer to the intersection point you want to use as the lowermost side of the integration region, and then press **EXE**.
4. Use **▶** to move the pointer to the intersection point you want to use as the uppermost side of the integration region.
 - If there is only one intersection point on the display, the message “Not Found” will appear. In this case, press **EXIT**.
5. Press **EXE** to calculate the integral value and area value.

Example To graph $Y = \sin X$ and $Y = \sin(X - \frac{\pi}{2})$, and then determine the integration value and area value between two points of intersection you specify

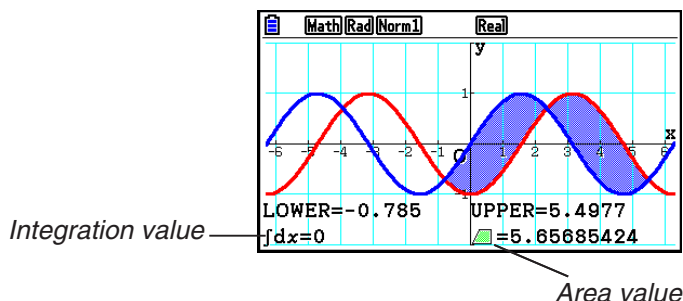

- If there are 21 or more intersections between the two points of intersection you specify, an error will occur.
- Integral values and area values can be calculated for rectangular coordinate graphs only.

• **To determine the integration value and area between the roots of a graph and the point of intersection of two graphs**

1. Draw the graphs.
2. Press **SHIFT** **F5** (G-SOLVE) **F6** (\triangleright) **F3** ($\int dx$) **4** (MIXED).
 - If there are three or more graphs on the graph screen, one of them will be flashing. Use **▲** and **▼** to move the flashing to the graph whose integrated value you want to determine and then press **EXE**. Move the flashing again to one of the other graphs and then press **EXE**.
3. Use **◀** and **▶** to move the pointer to the lowermost side of the integration region, and then press **EXE**.
4. Use **◀** and **▶** to move the pointer to the uppermost side of the integration region, and then press **EXE**.
5. Press **EXE** to calculate the integrated value and the area value.

Example **To graph $Y1 = X^3 + 7X^2 + 2X - 15$ and $Y2 = 5X + 20$, specify the intersect of the graph, and the root of graph $Y2$, and determine the integration value and area value**

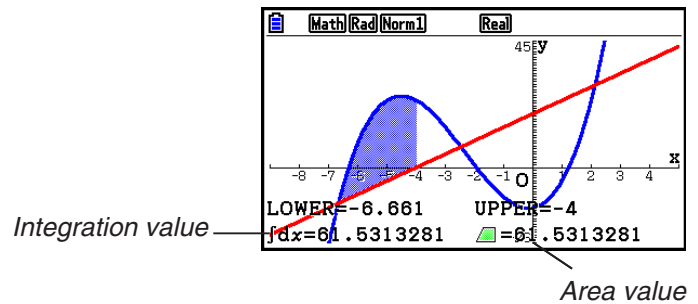

- The number keys can also be used to specify any x -coordinates as the lowermost site and uppermost side of the integration region.

■ Conic Section Graph Analysis

You can determine approximations of the following analytical results using conic section graphs.

1. From the Main Menu, enter the **Conic Graphs** mode.
2. Select the function type.
 - F1** (RECT).... {rectangular coordinate}
 - F2** (POL).... {polar coordinate}
 - F3** (PARAM).... {parametric}
3. Use **▲** and **▼** to select the conic section you want to analyze.
4. Input the conic section constants.
5. Draw the graph.

After graphing a conic section, press $\boxed{\text{SHIFT}} \boxed{\text{F5}}$ (G-SOLVE) to display the following graph analysis menus.

- **Parabolic Graph Analysis**

- {FOCUS}/{VERTEX}/{LENGTH}/{e} ... {focus}/{vertex}/{length of latus rectum}/{eccentricity}
- {DIRECTX}/{SYMMETRY} ... {directrix}/{axis of symmetry}
- {X-ICEPT}/{Y-ICEPT} ... {x-intercept}/{y-intercept}

- **Circular Graph Analysis**

- {CENTER}/{RADIUS} ... {center}/{radius}
- {X-ICEPT}/{Y-ICEPT} ... {x-intercept}/{y-intercept}

- **Elliptical Graph Analysis**

- {FOCUS}/{VERTEX}/{CENTER}/{e} ... {focus}/{vertex}/{center}/{eccentricity}
- {X-ICEPT}/{Y-ICEPT} ... {x-intercept}/{y-intercept}

- **Hyperbolic Graph Analysis**

- {FOCUS}/{VERTEX}/{CENTER}/{e} ... {focus}/{vertex}/{center}/{eccentricity}
- {ASYMPT} ... {asymptote}
- {X-ICEPT}/{Y-ICEPT} ... {x-intercept}/{y-intercept}

- **To calculate the focus and length of latus rectum**

Example To determine the focus and length of latus rectum for the parabola $X = (Y - 2)^2 + 3$

Use the following V-Window settings.

Xmin = -1, Xmax = 10, Xscale = 1

Ymin = -5, Ymax = 5, Yscale = 1

$\boxed{\text{MENU}}$ Conic Graphs

$\boxed{\text{EXE}}$

$\boxed{1} \boxed{\text{EXE}} \boxed{2} \boxed{\text{EXE}} \boxed{3} \boxed{\text{EXE}} \boxed{\text{F6}}$ (DRAW)

$\boxed{\text{SHIFT}} \boxed{\text{F5}}$ (G-SOLVE)

$\boxed{\text{F1}}$ (FOCUS)

(Calculates the focus.)

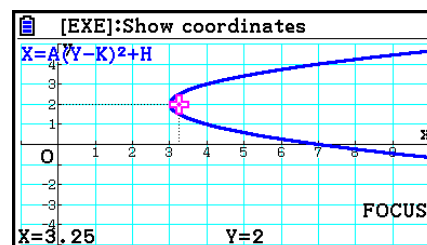

$\boxed{\text{SHIFT}} \boxed{\text{F5}}$ (G-SOLVE)

$\boxed{\text{F5}}$ (LENGTH)

(Calculates the length of latus rectum.)

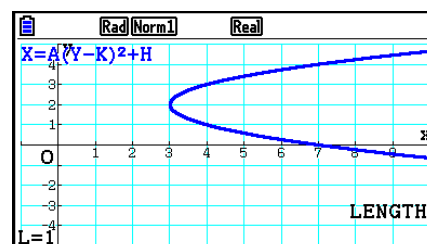

- When calculating two foci for an ellipse or hyperbolic graph, press \blacktriangleright to calculate the second focus. Pressing \blacktriangleleft returns to the first focus.
- When calculating two vertices for a hyperbolic graph, press \blacktriangleright to calculate the second vertex. Pressing \blacktriangleleft returns to the first vertex.
- Pressing \blacktriangleright when calculating the vertices of an ellipse will calculate the next value. Pressing \blacktriangleleft will scroll back through previous values. An ellipse has four vertices.

• **To calculate the center**

Example **To determine the center for the circle**

$$(X + 2)^2 + (Y + 1)^2 = 2^2$$

$\boxed{\text{MENU}}$ Conic Graphs

\blacktriangledown \blacktriangledown \blacktriangledown \blacktriangledown $\boxed{\text{EXE}}$

$\boxed{\leftarrow}$ $\boxed{2}$ $\boxed{\text{EXE}}$ $\boxed{\leftarrow}$ $\boxed{1}$ $\boxed{\text{EXE}}$ $\boxed{2}$ $\boxed{\text{EXE}}$ $\boxed{\text{F6}}$ (DRAW)

$\boxed{\text{SHIFT}}$ $\boxed{\text{F5}}$ (G-SOLVE)

$\boxed{\text{F1}}$ (CENTER)

(Calculates the center.)

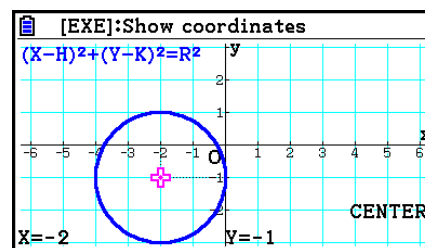

Chapter 6 Statistical Graphs and Calculations

Important!

This chapter contains a number of graph screen shots. In each case, new data values were input in order to highlight the particular characteristics of the graph being drawn. Note that when you try to draw a similar graph, the unit uses data values that you have input using the List function. Because of this, the graphs that appear on the screen when you perform a graphing operation will probably differ somewhat from those shown in this manual.

1. Before Performing Statistical Calculations

Entering the **Statistics** mode from the Main Menu displays the List Editor screen.

You can use the List Editor screen to input statistical data and perform statistical calculations.

Use \blacktriangle , \blacktriangledown , \blacktriangleleft and \blacktriangleright to move the highlighting around the lists.

Once you input data, you can use it to produce a graph and check for tendencies. You can also use a variety of different regression calculations to analyze the data.

- For information about using the List Editor, see “Chapter 3 List Function”.

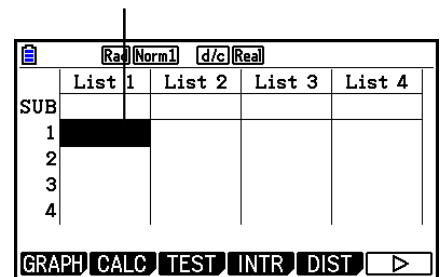

■ Statistical Graph Parameters

You can specify the graph draw/non-draw status, the graph type, and other general settings for each of the graphs in the graph menu (GRAPH1, GRAPH2, GRAPH3).

While the List Editor is on the display, press $\boxed{F1}$ (GRAPH) to display the graph menu, which contains the following items.

- **{GRAPH1}/{GRAPH2}/{GRAPH3}** ... graph {1}/{2}/{3} drawing*¹
- **{SELECT}** ... {simultaneous graph (GRAPH1, GRAPH2, GRAPH3) selection}
You can specify the multiple graphs.
- **{SET}** ... {graph settings (graph type, list assignments)}

*¹ The initial default graph type setting for all the graphs (Graph 1 through Graph 3) is scatter diagram, but you can change to one of a number of other graph types.

This section describes how to use the general graph settings screen to make the following settings for each graph (GRAPH1, GRAPH2, GRAPH3).

- **Graph Type**

The initial default graph type setting for all the graphs is scatter graph. You can select one of a variety of other statistical graph types for each graph.

- **XList, YList**

The initial default statistical data is List 1 for single-variable data, and List 1 and List 2 for paired-variable data. You can specify which statistical data list you want to use for x -data and y -data.

- **Frequency**

This setting specifies a list that contains frequency data.

In statistics, “frequency” means the number of times a data item (or set of data items) occurs. Frequencies are used in “frequency distribution tables,” which list each unique data item in one column, with the frequency (number of occurrences) in the column to the right. With this calculator, the data column and frequency column are separate lists. This setting specifies the list (List 1, List 2, etc.) to be used for the frequency column when drawing a statistical graph. The initial default setting for this item is 1, which indicates that the frequency of all data items is 1 (one occurrence).

Important!

- The values contained in a frequency list should be 0 or positive values only. Even a single negative value will cause an error (Out of Domain).
- Statistical data with a frequency of 0 is not used for calculation of minimum and maximum values.

- **Mark Type**

This setting lets you specify the shape of the plot points on the graph.

- **Color Link**

This setting specifies whether the color specified on the List Editor for the statistical data list(s) to be used for graphing should be applied as the graph color(s). The initial default value is “Off” (color specified with the List Editor not applied to the graph).

- **Graph Color**

Specifies the graph color when “Off” is selected for the Color Link setting. Depending on the graph type, setting items for specifying the color of each part of a graph may appear in place of this item. In the case of a pie chart, for example, Pie Area and Pie Border color settings will appear.

• **To display the general graph settings screen**

Pressing **[F1]** (GRAPH) **[F6]** (SET) displays the general graph settings screen.

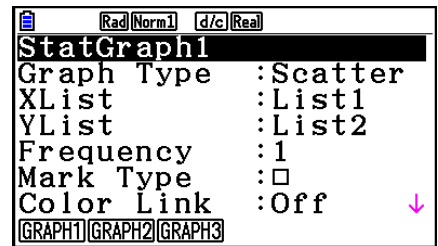

• **StatGraph (statistical graph specification)**

- {**GRAPH1**}/{**GRAPH2**}/{**GRAPH3**} ... graph {1}/{2}/{3}

• **Graph Type (graph type specification)**

- {**Scatter**}/{**xyLine**}/{**NPPlot**}/{**Pie**} ... {scatter diagram}/{*xy* line graph}/{normal probability plot}/{pie chart}
- {**Hist**}/{**MedBox**}/{**Bar**}/{**N-Dist**}/{**Broken**} ... {histogram}/{med-box graph}/{bar graph}/{normal distribution curve}/{broken line graph}
- {**X**}/{**Med**}/{**X²**}/{**X³**}/{**X⁴**} ... {linear regression graph}/{Med-Med graph}/{quadratic regression graph}/{cubic regression graph}/{quartic regression graph}
- {**Log**}/{**ae^{bx}**}/{**ab^x**}/{**Power**}/{**Sin**}/{**Logistic**} ... {logarithmic regression graph}/{exponential regression graph (*ae^{bx}*)}{exponential regression graph (*ab^x*)}{power regression graph}/{sinusoidal regression graph}/{logistic regression graph}

• **XList (x-axis data list)/YList (y-axis data list)**

- {**LIST**} ... {List 1 to 26}

• **Frequency (number of times a value occurs)**

- {**1**} ... {1-to-1 plot}
- {**LIST**} ... {List 1 to 26}

• **Mark Type (plot mark type)**

- {**□**}/{**⊗**}/{**■**} ... scatter diagram plot points

• **Color Link**

The options that appear for this setting depend on the graph type.

For this graph type:	Selecting this:	Causes this to happen:
Scatter, <i>xyLine</i>	X&Y	Colors specified for both the XList and YList data are reflected in the graph. <ul style="list-style-type: none"> • When the same lines of the XList and YList are the same color, plot marks and line will be drawn in the graph using that color. • When the same lines of the XList and YList are different colors, the graph plot marks are shown as ⊙ and lines are drawn in black.
	OnlyX	The color specified only for the XList data is reflected in the graph.
	OnlyY	The color specified only for the YList data is reflected in the graph.
	Off	List data color specifications are ignored.

For this graph type:	Selecting this:	Causes this to happen:
NPPlot, Pie, Bar	On	The color specified for the list data is reflected in the graph.
	Off	List data color specifications are ignored.
Hist, Broken	X&Freq	<p>Colors specified for both the XList and Frequency data list are reflected in the graph.</p> <ul style="list-style-type: none"> When the same lines of the XList and Frequency data list are the same color, the graph is drawn using that color. When the same lines of the XList and Frequency data list are the different colors, plot marks and lines are represented as described below. <p>Hist: Graph is shaded with the applicable color.</p> <p>Broken: Graph plot marks are shown as  and lines are drawn in black.</p>
	OnlyX	The color specified for only the XList data is reflected in the graph.
	Off	List data color specifications are ignored.

Example: Scatter graph when “OnlyX” is selected for the Color Link setting

	List 1	List 2	List 3	List 4
SUB				
1	1	2.1		2
2	2	5.3		3
3	3	8.2		2
4	4	11.1		0

List Editor display
(XList:List 1, YList:List 2)

⇒

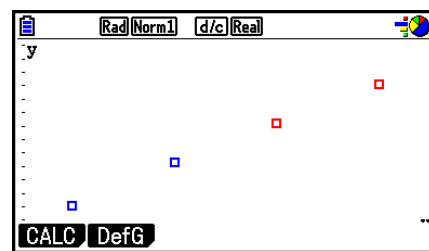

Color Link: OnlyX
(scatter graph)

• Graph Color

- {Black}/{Blue}/{Red}/{Magenta}/{Green}/{Cyan}/{Yellow} ... Specifies a single color as the graph color

Example: Scatter graph when {Red} is specified for Graph Color

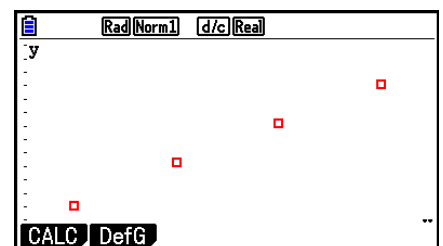

- **{Auto}** ... Cycles the color used for graph drawing in the following sequence for each data item (or data pair): blue, red, green, magenta, black. Cycle is repeated after all five colors are used. For some graphs, different parts of the graph (points, lines, etc.) are automatically drawn using different colors. {Auto} can be selected only when the graph type is Scatter, xyLine, NPPlot, or Broken.

Example: Scatter graph when {Auto} is specified for Graph Color

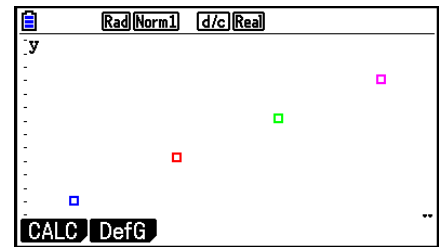

- The Graph Color setting is always “Link” whenever anything other than “Off” is selected for the Color Link setting.

When “Pie” (pie chart) is selected as the Graph Type:

- **Data (Specifies the list to be used as graph data.)**

- **{LIST}** ... {List 1 to List 26}

- **Display (pie chart value display setting)**

- **{%}/{Data}** ... For each data element {display as percentage}/{display as value}

- **% Sto Mem (Specifies storage of percentage values to a list.)**

- **{None}/{List}** ... For percentage values: {Do not store to list}/{Specify List 1 to 26 and store}

- **Pie Area (Specifies the fill color of a pie chart.)**

- **Area Color**

- **{Black}/{Blue}/{Red}/{Magenta}/{Green}/{Cyan}/{Yellow}** ... Specifies a single fill color for each data item.
- **{Auto}** ... Automatically cycles the fill color in the following sequence for each data item: blue, red, green, magenta, cyan, yellow. Cycle is repeated after all six colors are used.

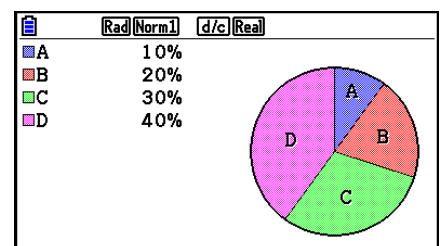

- **Paint Style**

- **{Normal}/{Lighter}** ... {normal fill density}/{lighter fill density}

- The Area Color setting is always “Link” and the Paint Style setting is always “Lighter” whenever anything other than “Off” is selected for the Color Link setting.

- **Pie Border (Specifies the border line color of a pie chart.)**

- **{Black}/{Blue}/{Red}/{Magenta}/{Green}/{Cyan}/{Yellow}** ... Specifies a single color for the border line.
- **{Clear}** ... No border line drawn.

When “Hist” (Histogram) is selected as the Graph Type:

- **Hist Area (Specifies the fill color of a histogram.)**

Settings are the same as those for Pie Area.

- **Hist Border (Specifies the border line color of a histogram.)**

Settings are the same as those for Pie Border.

- The Hist Border setting is always “Link” whenever anything other than “Off” is selected for the Color Link setting.

When “MedBox” (med-box graph) is selected as the Graph Type:

- **Outliers (outliers specification)**

- {On}/{Off} ... {display}/{do not display} Med-Box outliers

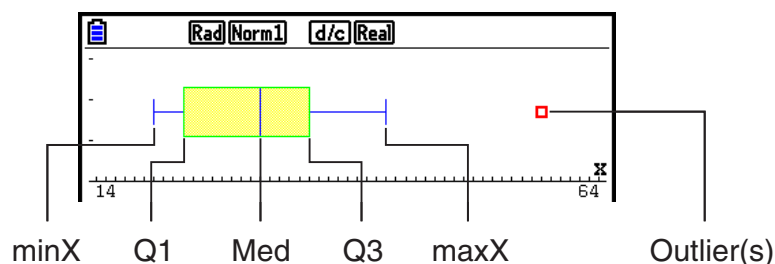

- **Box (Specifies the border line color of the box enclosed by Q1 through Q3, and the Med line color.)**

- {Black}/{Blue}/{Red}/{Magenta}/{Green}/{Cyan}/{Yellow} ... Specifies a single color for the border line.

- **Whisker (Specifies the whisker color from the box ends to minX and maxX.)**

Settings are the same as those for Box.

- **Outlier Color (Specifies the outliers color.)**

Settings are the same as those for Box.

- **Box Inside (Specifies the fill color of the box enclosed by Q1 through Q3.)**

Settings are basically the same as those for Pie Area, except for the following differences.

- When “Auto” is selected for the Area Color setting, blue is the fill color of the box from Q1 to Med, and yellow is the fill color of the box from Med to Q3.

When “Bar” (bar graph) is selected as the Graph Type:

- **Data1 (first stick data list)**

- {LIST} ... {List 1 to 26}

- **Data2 (second stick data list)/Data3 (third stick data list)**

- {None}/{LIST} ... {none}/{List 1 to 26}

- **Stick Style (stick style specification)**

- {Length}/{Horz} ... {length}/{horizontal}

- **D1 Area, D2 Area, D3 Area (Specifies the fill colors of bar graphs Data 1, Data 2, and Data 3.)**

Settings are the same as those for Hist Area.

- **D1 Border, D2 Border, D3 Border (Specifies the border colors of bar graphs Data 1, Data 2, and Data 3.)**

Settings are the same as those for Hist Border.

■ Graph Draw/Non-draw Status

[GRAPH]-[SELECT]

The following procedure can be used to specify the draw (On)/non-draw (Off) status of each of the graphs in the graph menu.

• To specify the draw/non-draw status of a graph

1. Pressing **[F1]** (GRAPH) **[F4]** (SELECT) displays the graph On/Off screen.

	Rad	Norm1	d/c	Real
StatGraph1	:	DrawOn		
StatGraph2	:	DrawOff		
StatGraph3	:	DrawOff		

- Note that the StatGraph1 setting is for Graph 1 (GRAPH1 of the graph menu), StatGraph2 is for Graph 2, and StatGraph3 is for Graph 3.
2. Use the cursor keys to move the highlighting to the graph whose status you want to change, and press the applicable function key to change the status.
 - **{On}/{Off}** ... {On (draw)}/{Off (non-draw)}
 - **{DRAW}** ... {draws all On graphs}
 3. To return to the graph menu, press **[EXIT]**.

■ Statistical Graph V-Window Settings

V-Window parameters are normally set automatically for statistical graphing. If you want to set V-Window parameters manually, you must change the Stat Wind item to “Manual”.

While the List Editor is on the display, perform the following procedure.

[SHIFT] **[MENU]** (SET UP) **[F2]** (Manual)

[EXIT] (Returns to previous menu.)

Note that V-Window parameters are set automatically for the following types of graphs regardless of whether or not the Stat Wind item is set to “Manual”.

Pie, 1-Sample Z Test, 2-Sample Z Test, 1-Prop Z Test, 2-Prop Z Test, 1-Sample t Test, 2-Sample t Test, χ^2 GOF Test, χ^2 2-way Test, 2-Sample F Test (x -axis only disregarded).

2. Calculating and Graphing Single-Variable Statistical Data

Single-variable data is data with only a single variable. If you are calculating the average height of the members of a class for example, there is only one variable (height).

Single-variable statistics include distribution and sum. The following types of graphs are available for single-variable statistics.

You can also use the procedures under “Statistical Graph Parameters” on page 6-1 to make the settings you want before drawing each graph.

■ Normal Probability Plot

This plot compares the data accumulated ratio with a normal distribution accumulated ratio. XList specifies the list where data is input, and Mark Type is used to select from among the marks {□ / ✕ / ■ } you want to plot.

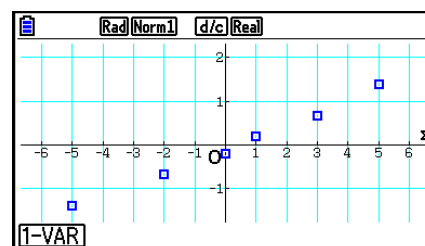

Press **AC**, **EXIT** or **SHIFT** **EXIT** (QUIT) to return to the List Editor.

■ Pie Chart

You can draw a pie chart based on the data in a specific list. The maximum number of graph data items (list lines) is 20. The graph is labeled A, B, C, and so on, corresponding to lines 1, 2, 3, and so on of the list used for the graph data.

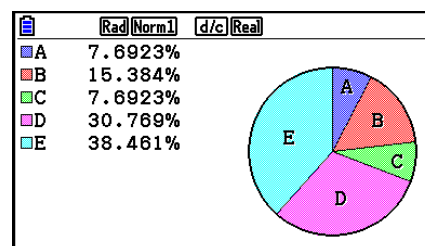

When “%” is selected for the “Display” setting on the general graph settings screen (page 6-3), a value showing the percentage is displayed for each of the alphabetic label letters.

■ Histogram

XList specifies the list where the data is input, while Freq specifies the list where the data frequency is input. 1 is specified for Freq when frequency is not specified.

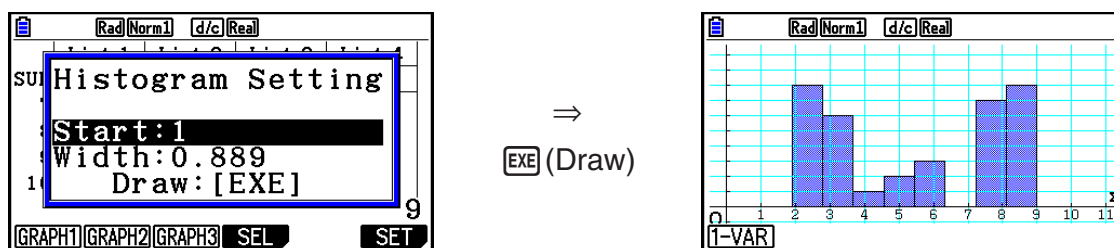

The display screen appears as shown above before the graph is drawn. At this point, you can change the Start and Width values.

■ Med-box Graph

This type of graph lets you see how a large number of data items are grouped within specific ranges. A box encloses all the data in an area from the first quartile (Q1) to the third quartile (Q3), with a line drawn at the median (Med). Lines (called whiskers) extend from either end of the box up to the minimum (minX) and maximum (maxX) of the data.

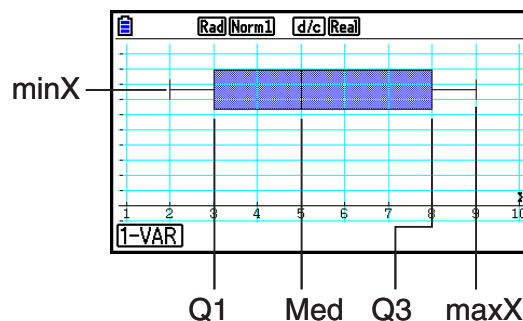

To plot the data that falls outside the box, first specify “MedBox” as the Graph Type. Then, on the same screen you use to specify the graph type, turn the Outliers item “On”, and draw the graph.

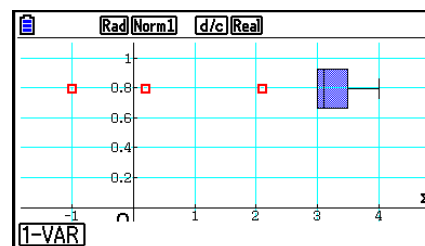

- Changing the “Q1Q3 Type” setting on the Setup screen can cause the Q1 and Q3 positions to change, even when a Med-box graph is drawn based on a single list.

■ Bar Graph

You can specify up to three lists for drawing a bar graph. The graph is labeled [1], [2], [3], and so on, corresponding to lines 1, 2, 3, and so on of the list used for the graph data.

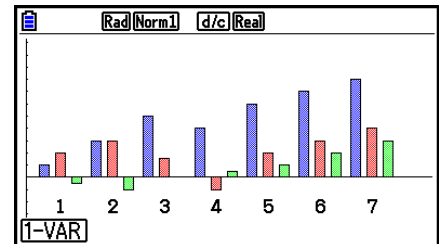

- Any of the following causes an error and cancels bar graph drawing.
 - A Condition ERROR occurs when drawing of multiple graphs is specified using the graph On/Off screen (page 6-7), and bar graph is specified for one of the graphs and a different graph type is specified for another graph.
 - A Dimension ERROR occurs when you draw a graph with two or three lists specified and the specified lists have a different number of list elements.
 - A Condition ERROR occurs when lists are assigned for Data1 and Data3, while “None” is specified for Data2.

■ Normal Distribution Curve

The normal distribution curve is graphed using the normal distribution function.

XList specifies the list where the data is input, while Freq specifies the list where the data frequency is input. 1 is specified for Freq when frequency is not specified.

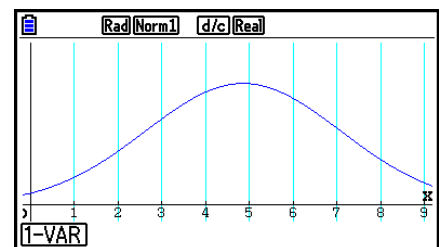

■ Broken Line Graph

Lines connect center points of a histogram bar.

XList specifies the list where the data is input, while Freq specifies the list where the data frequency is input. 1 is specified for Freq when frequency is not specified.

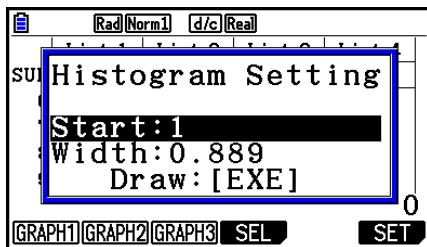

⇒
[EXE] (Draw)

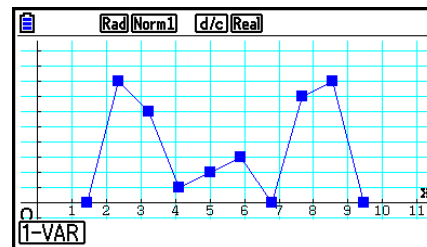

The display screen appears as shown above before the graph is drawn. At this point, you can change the Start and Width values.

■ Displaying the Calculation Results of a Drawn Single-Variable Graph

Single-variable statistics can be expressed as both graphs and parameter values. When these graphs are displayed, the single-variable calculation results appear as shown to the right when you press [F1] (1-VAR).

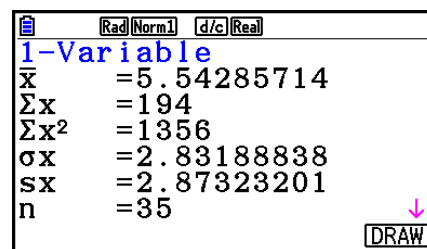

- Use to scroll the list so you can view the items that run off the bottom of the screen.

The following describes the meaning of each of the parameters.

\bar{x}	mean	minX.....	minimum
Σx	sum	Q1	first quartile
Σx^2	sum of squares	Med	median
σ_x	population standard deviation	Q3	third quartile
s_x	sample standard deviation	maxX.....	maximum
n	number of data items	Mod	mode
		Mod:n	number of data mode items
		Mod:F	data mode frequency

- Press [F6] (DRAW) to return to the original single-variable statistical graph.
- When Mod has multiple solutions, they are all displayed.
- You can use the Setup screen's "Q1Q3 Type" setting to select either "Std" (standard calculation) or "OnData" (French calculation) for the Q1 and Q3 calculation mode.

For details about calculation methods while "Std" or "OnData" is selected, see "Calculation Methods for the Std and OnData Settings" below.

■ Calculation Methods for the Std and OnData Settings

Q1, Q3 and Med can be calculated in accordance with the Setup screen's "Q1Q3 Type" setting as described below.

• Std

(1) When all Frequency values are integers

With this calculation method, processing depends on whether the number of elements n in the population is an even number or odd number.

When the number of elements n is an even number:

Using the center point of the total population as the reference, the population elements are divided into two groups: a lower half group and an upper half group. Q1, Q3 and Med then become the values described below.

Q1 = {median of the group of $\frac{n}{2}$ items from the bottom of the population}

Q3 = {median of the group of $\frac{n}{2}$ items from the top of the population}

Med = { $\frac{n}{2}$ -th and $\frac{n}{2} + 1$ -th element average value}

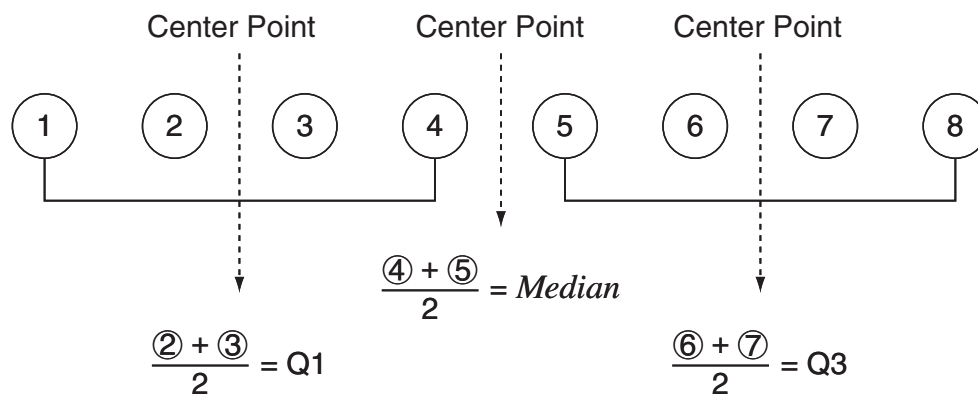

When the number of elements n is an odd number:

Using the median of the total population as the reference, the population elements are divided into two groups: a lower half group (values less than the median) and an upper half group (values greater than the median). The median value is excluded. Q1, Q3 and Med then become the values described below.

Q1 = {median of the group of $\frac{n-1}{2}$ items from the bottom of the population}

Q3 = {median of the group of $\frac{n-1}{2}$ items from the top of the population}

Med = { $\frac{n+1}{2}$ -th element}

- When $n = 1$, Q1 = Q3 = Med = population center point.

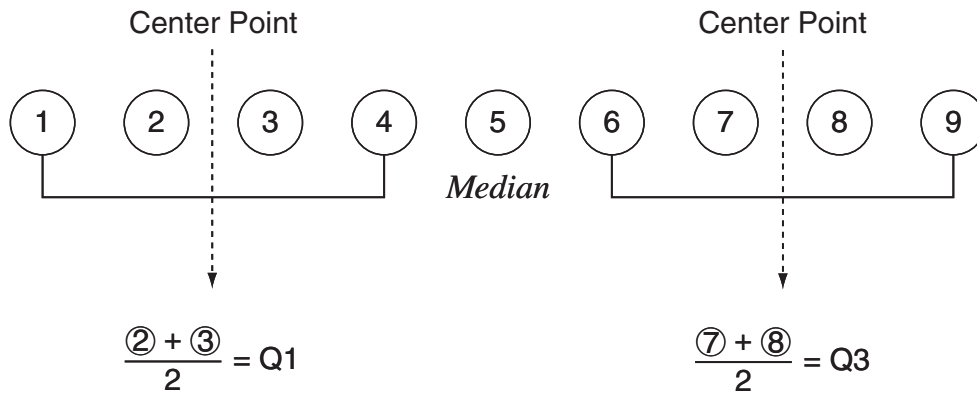

(2) When Frequency includes decimal fraction values

The Q1, Q3 and Med values for this calculation method are described below.

Q1 = {value of element whose cumulative frequency ratio is greater than 0.25 and nearest to 0.25}

When the cumulative frequency ratio for some data value is exactly 0.25, Q1 is the average of that data value and the next data value.

Q3 = {value of element whose cumulative frequency ratio is greater than 0.75 and nearest to 0.75}

When the cumulative frequency ratio for some data value is exactly 0.75, Q3 is the average of that data value and the next data value.

Med = {value of element whose cumulative frequency ratio is greater than 0.5 and nearest to 0.5}

When the cumulative frequency ratio for some data value is exactly 0.5, Med is the average of that data value and the next data value.

The following shows an actual example of the above.

Data Value	Frequency	Cumulative Frequency	Cumulative Frequency Ratio
1	0.1	0.1	0.1/1.0 = 0.1
2	0.1	0.2	0.2/1.0 = 0.2
3	0.2	0.4	0.4/1.0 = 0.4
4	0.3	0.7	0.7/1.0 = 0.7
5	0.1	0.8	0.8/1.0 = 0.8
6	0.1	0.9	0.9/1.0 = 0.9
7	0.1	1.0	1.0/1.0 = 1.0

- 3 is the value whose cumulative frequency ratio is greater than 0.25 and nearest to 0.25, so Q1 = 3.
- 5 is the value whose cumulative frequency ratio is greater than 0.75 and nearest to 0.75, so Q3 = 5.
- 4 is the value whose cumulative frequency ratio is greater than 0.5 and nearest to 0.5, so Med = 4.

• OnData

The Q1, Q3 and Med values for this calculation method are described below.

Q1 = {value of element whose cumulative frequency ratio is greater than 0.25 and nearest to 0.25}

Q3 = {value of element whose cumulative frequency ratio is greater than 0.75 and nearest to 0.75}

The following shows an actual example of the above.

(Number of Elements: 10)

Data Value	Frequency	Cumulative Frequency	Cumulative Frequency Ratio
1	1	1	1/10 = 0.1
2	1	2	2/10 = 0.2
3	2	4	4/10 = 0.4
4	3	7	7/10 = 0.7
5	1	8	8/10 = 0.8
6	1	9	9/10 = 0.9
7	1	10	10/10 = 1.0

- 3 is the value of whose cumulative frequency ratio is greater than or equal to 0.25 and nearest to 0.25, so Q1 = 3.
- 5 is the value of whose cumulative frequency ratio is greater than or equal to 0.75 and nearest to 0.75, so Q3 = 5.

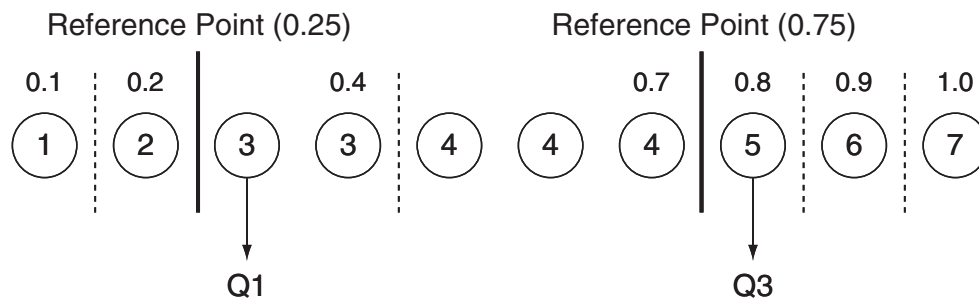

- Med is calculated using the same method as that used when the "Std" is selected for the "Q1Q3 Type" setting.
- It makes no different whether frequency values are all integers or include decimal fraction values when "OnData" is selected for the "Q1Q3 Type" setting.

3. Calculating and Graphing Paired-Variable Statistical Data (Curve Fitting)

■ Drawing a Scatter Diagram and xy Line Graph

The following procedure plots a scatter diagram and connects the dots to produce an xy line graph.

1. From the Main Menu, enter the **Statistics** mode.
2. Input the data into a list.
3. Specify Scatter (scatter diagram) or xy Line (xy line graph) as the graph type, and then execute the graph operation.

Press **AC**, **EXIT** or **SHIFT** **EXIT** (QUIT) to return to the List Editor.

Example **Input the two sets of data shown below. Next, plot the data on a scatter diagram and connect the dots to produce an xy line graph.**

0.5, 1.2, 2.4, 4.0, 5.2 (xList)

-2.1, 0.3, 1.5, 2.0, 2.4 (yList)

① **MENU** Statistics

② **0** **.** **5** **EXE** **1** **.** **2** **EXE** **2** **.** **4** **EXE** **4** **EXE** **5** **.** **2** **EXE** **▶**

(-) **2** **.** **1** **EXE** **0** **.** **3** **EXE** **1** **.** **5** **EXE** **2** **EXE** **2** **.** **4** **EXE**

③ (Scatter diagram) **F1** (GRAPH) **F6** (SET) **▼** **F1** (Scatter) **EXIT** **F1** (GRAPH1)

③ (xy line graph) **F1** (GRAPH) **F6** (SET) **▼** **F2** (xy Line) **EXIT** **F1** (GRAPH1)

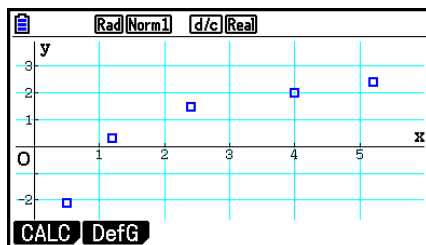

(Scatter diagram)

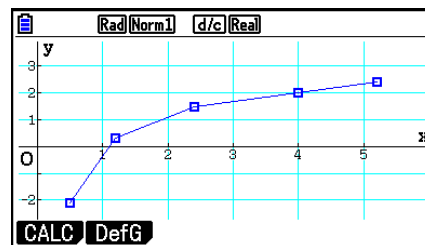

(xy line graph)

■ Drawing a Regression Graph

Use the following procedure to input paired-variable statistical data, perform a regression calculation using the data, and then graph the results.

1. From the Main Menu, enter the **Statistics** mode.
2. Input the data into a list, and plot the scatter diagram.
3. Select the regression type, execute the calculation, and display the regression parameters.
4. Draw the regression graph.

Example **Input the two sets of data shown below and plot the data on a scatter diagram. Next, perform logarithmic regression on the data to display the regression parameters, and then draw the corresponding regression graph.**

0.5, 1.2, 2.4, 4.0, 5.2 (xList)

-2.1, 0.3, 1.5, 2.0, 2.4 (yList)

- ① **MENU** Statistics
- ② **0** **.** **5** **EXE** **1** **.** **2** **EXE** **2** **.** **4** **EXE** **4** **EXE** **5** **.** **2** **EXE** **▶**
(-) **2** **.** **1** **EXE** **0** **.** **3** **EXE** **1** **.** **5** **EXE** **2** **EXE** **2** **.** **4** **EXE**
F1 (GRAPH) **F6** (SET) **▼** **F1** (Scatter) **EXIT** **F1** (GRAPH1)
- ③ **F1** (CALC) **F6** (**▶**) **F2** (Log)
- ④ **F6** (DRAW)

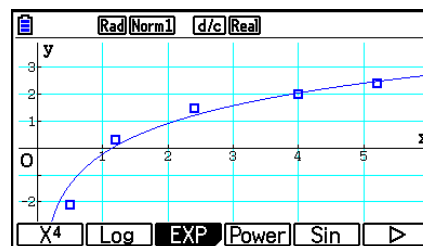
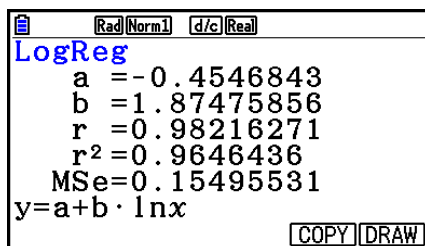

- You can perform trace on a regression graph. You cannot perform trace scroll.

■ Selecting the Regression Type

After you graph paired-variable statistical data, you can use the function menu at the bottom of the display to select from a variety of different types of regression.

- **{ax+b}**/**{a+bx}**/**{Med}**/**{X²}**/**{X³}**/**{X⁴}**/**{Log}**/**{ae^{bx}}**/**{ab^x}**/**{Power}**/**{Sin}**/**{Logistic}** ...
 {linear regression (ax+b form)}/{linear regression (a+bx form)}/{Med-Med}/{quadratic regression}/{cubic regression}/{quartic regression}/{logarithmic regression}/{exponential regression (ae^{bx} form)}/{exponential regression (ab^x form)}/{power regression}/
 {sinusoidal regression}/{logistic regression} calculation and graphing
- **{2-VAR}**... {paired-variable statistical results}

■ Displaying Regression Calculation Results

Whenever you perform a regression calculation, the regression formula parameter (such as a and b in the linear regression $y = ax + b$) calculation results appear on the display. The regression formula parameter calculation results also appear as soon as you press **F1** (CALC) and then a function key to select a regression type, while a graph is on the display.

The following parameters will also appear on the regression calculation result screen.

- r correlation coefficient (linear regression, logarithmic regression, exponential regression, and power regression only)
- r^2 coefficient of determination (except for Med-Med, sinusoidal regression, and logistic regression)
- MSe mean square error (except for Med-Med)

■ Graphing Statistical Calculation Results

While the parameter calculation result is on the display, you can graph the displayed regression formula by pressing **F6** (DRAW).

■ Linear Regression Graph

Linear regression uses the method of least squares to plot a straight line that passes close to as many data points as possible, and returns values for the slope and y-intercept (y-coordinate when $x = 0$) of the line.

The graphic representation of this relationship is a linear regression graph.

- F1** (CALC) **F2** (X)
- F1** ($ax+b$) or **F2** ($a+bx$)
- F6** (DRAW)

The following is the linear regression model formula.

$$y = ax + b$$

a regression coefficient (slope)

b regression constant term (y-intercept)

$$y = a + bx$$

a regression constant term (y-intercept)

b regression coefficient (slope)

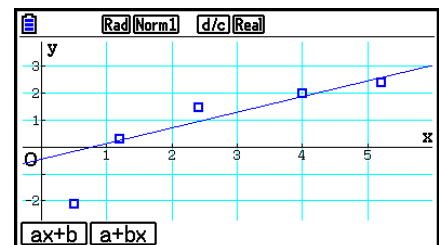

■ Med-Med Graph

When it is suspected that there are a number of extreme values, a Med-Med graph can be used in place of the least squares method. This is similar to linear regression, but it minimizes the effects of extreme values.

F1 (CALC) **F3** (Med)
F6 (DRAW)

The following is the Med-Med graph model formula.

$$y = ax + b$$

a Med-Med graph slope

b Med-Med graph y-intercept

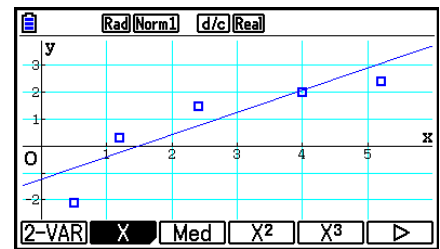

■ Quadratic/Cubic/Quartic Regression Graph

A quadratic/cubic/quartic regression graph represents connection of the data points of a scatter diagram. It uses the method of least squares to draw a curve that passes close to as many data points as possible. The formula that represents this is quadratic/cubic/quartic regression.

Ex. Quadratic regression

F1 (CALC) **F4** (X^2)
F6 (DRAW)

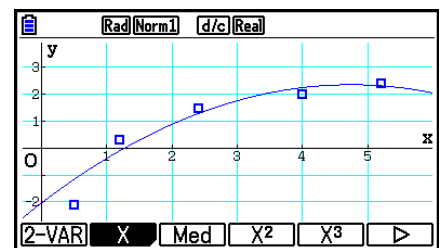

Quadratic regression

Model formula..... $y = ax^2 + bx + c$

a regression second coefficient

b regression first coefficient

c regression constant term
(y-intercept)

Cubic regression

Model formula..... $y = ax^3 + bx^2 + cx + d$

a regression third coefficient

b regression second coefficient

c regression first coefficient

d regression constant term
(y-intercept)

Quartic regression

Model formula..... $y = ax^4 + bx^3 + cx^2 + dx + e$

a regression fourth coefficient

b regression third coefficient

c regression second coefficient

d regression first coefficient

e regression constant term (y-intercept)

■ Logarithmic Regression Graph

Logarithmic regression expresses y as a logarithmic function of x . The standard logarithmic regression formula is $y = a + b \times \ln x$, so if we say that $X = \ln x$, the formula corresponds to linear regression formula $y = a + bX$.

F1 (CALC) **F6** (\triangleright) **F2** (Log)
F6 (DRAW)

The following is the logarithmic regression model formula.

$$y = a + b \cdot \ln x$$

a regression constant term

b regression coefficient

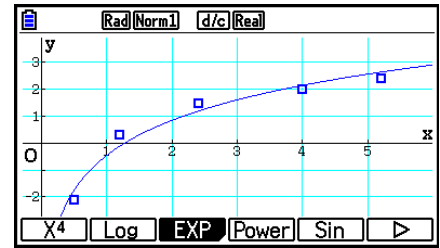

■ Exponential Regression Graph

Exponential regression expresses y as a proportion of the exponential function of x . The standard exponential regression formula is $y = a \times e^{bx}$, so if we take the logarithms of both sides we get $\ln y = \ln a + bx$. Next, if we say $Y = \ln y$, and $A = \ln a$, the formula corresponds to linear regression formula $Y = A + bx$.

F1 (CALC) **F6** (\triangleright) **F3** (EXP)
F1 (ae^{bx}) or **F2** (ab^x)
F6 (DRAW)

The following is the exponential regression model formula.

$$y = a \cdot e^{bx}$$

a regression coefficient

b regression constant term

$$y = a \cdot b^x$$

a regression constant term

b regression coefficient

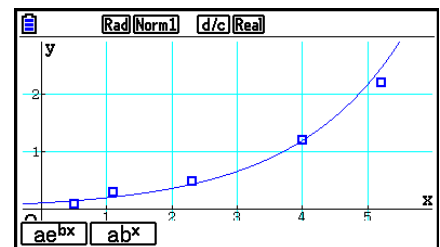

Power Regression Graph

Power regression expresses y as a proportion of the power of x . The standard power regression formula is $y = a \times x^b$, so if we take the logarithm of both sides we get $\ln y = \ln a + b \times \ln x$. Next, if we say $X = \ln x$, $Y = \ln y$, and $A = \ln a$, the formula corresponds to linear regression formula $Y = A + bX$.

F1 (CALC) **F6** (▷) **F4** (Power)

F6 (DRAW)

The following is the power regression model formula.

$$y = a \cdot x^b$$

a regression coefficient

b regression power

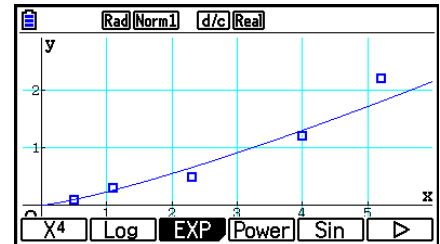

Sinusoidal Regression Graph

Sinusoidal regression is best applied for cyclical data.

The following is the sinusoidal regression model formula.

$$y = a \cdot \sin(bx + c) + d$$

F1 (CALC) **F6** (▷) **F5** (Sin)

F6 (DRAW)

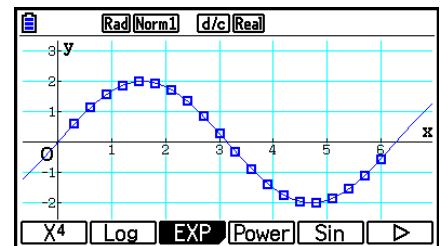

Drawing a sine regression graph causes the angle unit setting of the calculator to automatically change to Rad (radians). The angle unit does not change when you perform a sine regression calculation without drawing a graph.

- Certain types of data may take a long time to calculate. This does not indicate malfunction.

■ Logistic Regression Graph

Logistic regression is best applied for time-based phenomena in which there is a continual increase until a saturation point is reached.

The following is the logistic regression model formula.

$$y = \frac{c}{1 + ae^{-bx}}$$

F1(CALC) **F6**(▷) **F6**(▷) **F1**(Logistic)
F6(DRAW)

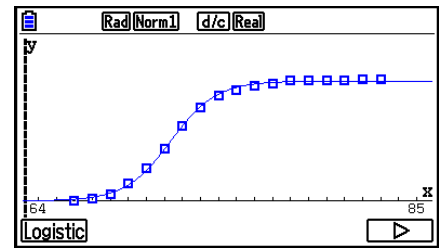

- Certain types of data may take a long time to calculate. This does not indicate malfunction.

■ Residual Calculation

Actual plot points (y -coordinates) and regression model distance can be calculated during regression calculations.

While the List Editor is on the display, recall the Setup screen to specify a LIST (“List 1” through “List 26”) for “Resid List”. Calculated residual data is stored in the specified list.

The vertical distance from the plots to the regression model will be stored in the list.

Plots that are higher than the regression model are positive, while those that are lower are negative.

Residual calculation can be performed and saved for all regression models.

Any data already existing in the selected list is cleared. The residual of each plot is stored in the same precedence as the data used as the model.

■ Displaying the Calculation Results of a Drawn Paired-Variable Graph

Paired-variable statistics can be expressed as both graphs and parameter values. When these graphs are displayed, the paired-variable calculation results appear as shown below when you press **F1** (CALC) **F1** (2-VAR).

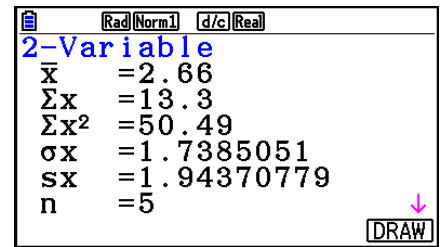

- Use **▼** to scroll the list so you can view the items that run off the bottom of the screen.

\bar{x}	mean of data stored in x List	Σy^2	sum of squares of data stored in y List
Σx	sum of data stored in x List	σ_y	population standard deviation of data stored in y List
Σx^2	sum of squares of data stored in x List	s_y	sample standard deviation of data stored in y List
σ_x	population standard deviation of data stored in x List	Σxy	sum of the product of data stored in x List and y List
s_x	sample standard deviation of data stored in x List	minX.....	minimum of data stored in x List
n	number of data	maxX.....	maximum of data stored in x List
\bar{y}	mean of data stored in y List	minY.....	minimum of data stored in y List
Σy	sum of data stored in y List	maxY.....	maximum of data stored in y List

■ Copying a Regression Graph Formula to the Graph Mode

You can copy regression formula calculation results to the **Graph** mode graph relation list, and store and compare.

1. While a regression calculation result is on the display (see “Displaying Regression Calculation Results” on page 6-17), press **F5** (COPY).
 - This will display the **Graph** mode graph relation list.*1
2. Use **▲** and **▼** to highlight the area to which you want to copy the regression formula of the displayed result.
3. Press **EXE** to save the copied graph formula and return to the previous regression calculation result display.

*1 You cannot edit regression formulas for graph formulas in the **Graph** mode.

4. Performing Statistical Calculations

All of the statistical calculations up to this point were performed after displaying a graph. The following procedures can be used to perform statistical calculations alone.

• To specify statistical calculation data lists

You have to input the statistical data for the calculation you want to perform and specify where it is located before you start a calculation. Display the statistical data and then press **F2**(CALC) **F6**(SET).

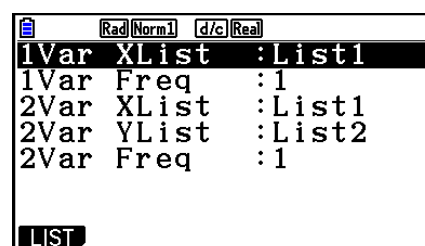

The following is the meaning for each item.

- 1Var XList..... location of single-variable statistic x values (XList)
 - 1Var Freq location of single-variable frequency values (Frequency)
 - 2Var XList..... location of paired-variable statistic x values (XList)
 - 2Var YList..... location of paired-variable statistic y values (YList)
 - 2Var Freq location of paired-variable frequency values (Frequency)
- Calculations in this section are performed based on the above specifications.

■ Single-Variable Statistical Calculations

In the previous example under “Displaying the Calculation Results of a Drawn Single-Variable Graph”, statistical calculation results were displayed after the graph was drawn. These were numeric expressions of the characteristics of variables used in the graphic display.

These values can also be directly obtained by displaying the List Editor and pressing **F2**(CALC) **F1**(1-VAR).

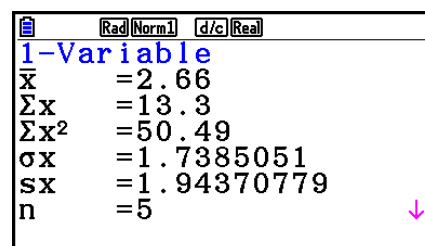

After this, pressing **▲** or **▼** scrolls the statistical calculation result display so you can view variable characteristics.

For details on the meanings of these statistical values, see “Displaying the Calculation Results of a Drawn Single-Variable Graph” (page 6-11).

■ Paired-Variable Statistical Calculations

In the previous example under “Displaying the Calculation Results of a Drawn Paired-Variable Graph”, statistical calculation results were displayed after the graph was drawn. These were numeric expressions of the characteristics of variables used in the graphic display.

These values can also be directly obtained by displaying the List Editor and pressing **F2** (CALC) **F2** (2-VAR).

	Rad(Norm1)	d/c(Real)
2-Variable		
\bar{x}	=20	
Σx	=100	
Σx^2	=2200	
σx	=6.32455532	
sx	=7.07106781	
n	=5	

After this, pressing **▲** or **▼** scrolls the statistical calculation result display so you can view variable characteristics.

For details on the meanings of these statistical values, see “Displaying the Calculation Results of a Drawn Paired-Variable Graph” (page 6-22).

■ Regression Calculation

In the explanations from “Linear Regression Graph” to “Logistic Regression Graph”, regression calculation results were displayed after the graph was drawn. Here, each coefficient value of the regression line or regression curve is expressed as a number.

You can directly determine the same expression from the data input screen.

Pressing **F2** (CALC) **F3** (REG) displays a function menu, which contains the following items.

- $\{ax+b\}/\{a+bx\}/\{\text{Med}\}/\{X^2\}/\{X^3\}/\{X^4\}/\{\text{Log}\}/\{ae^{bx}\}/\{ab^x\}/\{\text{Power}\}/\{\text{Sin}\}/\{\text{Logistic}\}$...
 {linear regression ($ax+b$ form)}/{linear regression ($a+bx$ form)}/{Med-Med}/{quadratic regression}/{cubic regression}/{quartic regression}/{logarithmic regression}/{exponential regression (ae^{bx} form)}/{exponential regression (ab^x form)}/{power regression}/{sinusoidal regression}/{logistic regression} parameters

Example **To display single-variable regression parameters**

F2 (CALC) **F3** (REG) **F1** (X) **F1** ($ax+b$)

	Rad(Norm1)	d/c(Real)
LinearReg(ax+b)		
a	=-0.05	
b	=4.4	
r	=-0.140859	
r^2	=0.01984126	
MSe	=8.23333333	
$y=ax+b$		

The meanings of the parameters that appear on this screen are the same as those for “Displaying Regression Calculation Results” and “Linear Regression Graph” to “Logistic Regression Graph”.

• Calculation of the Correlation Coefficient (r), Coefficient of Determination (r²) and Mean Square Error (MSe)

After the regression formula parameters on the regression calculation result screen, the following parameters also appear on the display. The parameters that appear depend on the regression formula.

Correlation coefficient (r)

Displayed following: linear regression, logarithmic regression, exponential regression, or power regression calculation.

Coefficient of determination (r²)

Displayed following: linear regression, quadratic regression, cubic regression, quartic regression, logarithmic regression, exponential regression, power regression calculation.

Mean square error (MSe)

Displayed following any regression calculation except Med-Med.

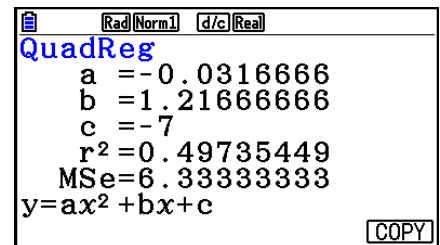

Depending on the regression calculation type, mean square error (MSe) is obtained using the following formulas.

- Linear Regression $(ax + b)$ $MSe = \frac{1}{n - 2} \sum_{i=1}^n (y_i - (ax_i + b))^2$
 $(a + bx)$ $MSe = \frac{1}{n - 2} \sum_{i=1}^n (y_i - (a + bx_i))^2$
- Quadratic Regression..... $MSe = \frac{1}{n - 3} \sum_{i=1}^n (y_i - (ax_i^2 + bx_i + c))^2$
- Cubic Regression..... $MSe = \frac{1}{n - 4} \sum_{i=1}^n (y_i - (ax_i^3 + bx_i^2 + cx_i + d))^2$
- Quartic Regression..... $MSe = \frac{1}{n - 5} \sum_{i=1}^n (y_i - (ax_i^4 + bx_i^3 + cx_i^2 + dx_i + e))^2$
- Logarithmic Regression..... $MSe = \frac{1}{n - 2} \sum_{i=1}^n (y_i - (a + b \ln x_i))^2$
- Exponential Regression $(a \cdot e^{bx})$ $MSe = \frac{1}{n - 2} \sum_{i=1}^n (\ln y_i - (\ln a + bx_i))^2$
 $(a \cdot b^x)$ $MSe = \frac{1}{n - 2} \sum_{i=1}^n (\ln y_i - (\ln a + (\ln b) \cdot x_i))^2$

- Power Regression $MSe = \frac{1}{n-2} \sum_{i=1}^n (\ln y_i - (\ln a + b \ln x_i))^2$
- Sin Regression $MSe = \frac{1}{n-2} \sum_{i=1}^n (y_i - (a \sin (bx_i + c) + d))^2$
- Logistic Regression $MSe = \frac{1}{n-2} \sum_{i=1}^n \left(y_i - \frac{C}{1 + ae^{-bx_i}} \right)^2$

• Estimated Value Calculation for Regression Graphs

The **Statistics** mode also includes a Y-CAL function that uses regression to calculate the estimated y -value for a particular x -value after graphing a paired-variable statistical regression.

The following is the general procedure for using the Y-CAL function.

1. After drawing a regression graph, press **[SHIFT]** **[F5]** (G-SOLVE) **[F1]** (Y-CAL) to enter the graph selection mode, and then press **[EXE]**.

If there are multiple graphs on the display, use **[▲]** and **[▼]** to select the graph you want, and then press **[EXE]**.

- This causes an x -value input dialog box to appear.

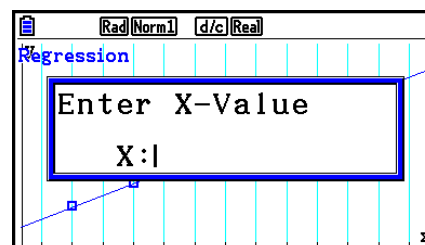

2. Input the value you want for x and then press **[EXE]**.

- This causes the coordinates for x and y to appear at the bottom of the display, and moves the pointer to the corresponding point on the graph.
- The pointer does not appear if the calculated coordinates are not within the display range.
- The coordinates do not appear if “Off” is specified for the “Coord” item of the Setup screen.

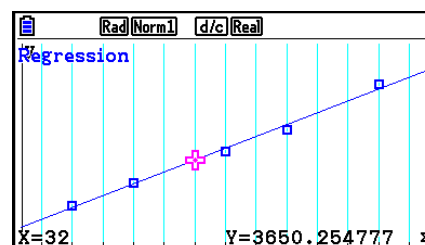

3. Pressing **[X,θ,T]** or a number key at this time causes the x -value input dialog box to reappear so you can perform another estimated value calculation if you want.
4. To exit the calculation, press **[EXIT]**. This will cause the coordinate values and pointer to disappear from the screen.

• Regression Formula Copy Function from a Regression Calculation Result Screen

In addition to the normal regression formula copy function that lets you copy the regression calculation result screen after drawing a statistical graph (such as Scatter Plot), the **Statistics** mode also has a function that lets you copy the regression formula obtained as the result of a regression calculation. To copy a resulting regression formula, press **F6** (COPY).

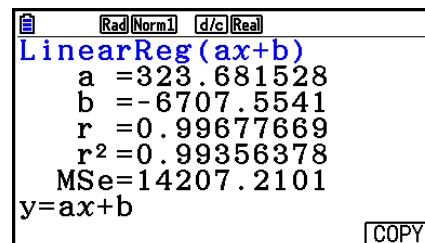

■ Estimated Value Calculation (\hat{x} , \hat{y})

After drawing a regression graph with the **Statistics** mode, you can use the **Run-Matrix** mode to calculate estimated values for the regression graph's x and y .

Example To perform a linear regression using the nearby data and estimate the values of \hat{y} and \hat{x} when $x_i = 20$ and $y_i = 1000$

x_i	10	15	20	25	30
y_i	1003	1005	1010	1011	1014

1. From the Main Menu, enter the **Statistics** mode.
2. Input data into the list and draw the linear regression graph.
3. From the Main Menu, enter the **Run-Matrix** mode.
4. Press the keys as follows.

2 **0** (value of x_i)
OPTN **F5** (STAT) **F2** (\hat{y}) **EXE**

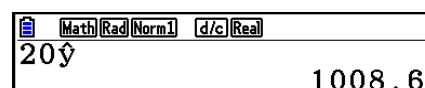

The estimated value \hat{y} is displayed for $x_i = 20$.

1 **0** **0** **0** (value of y_i)
F1 (\hat{x}) **EXE**

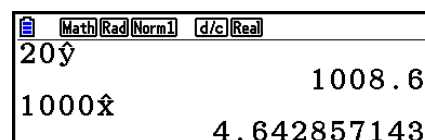

The estimated value \hat{x} is displayed for $y_i = 1000$.

- You cannot obtain estimated values for a Med-Med, quadratic regression, cubic regression, quartic regression, sinusoidal regression, or logistic regression graph.

Normal Probability Distribution Calculation

You can calculate normal probability distributions for single-variable statistics with the **Run-Matrix** mode.

Press **OPTN** **F6** (\triangleright) **F3** (PROB) **F6** (\triangleright) to display a function menu, which contains the following items.

- **{P()}{Q()}{R()}** ... obtains normal probability $\{P(t)\}/\{Q(t)\}/\{R(t)\}$ value
 - **{t()}** ... {obtains normalized variate $t(x)$ value}
- Normal probability $P(t)$, $Q(t)$, and $R(t)$, and normalized variate $t(x)$ are calculated using the following formulas.

Standard Normal Distribution

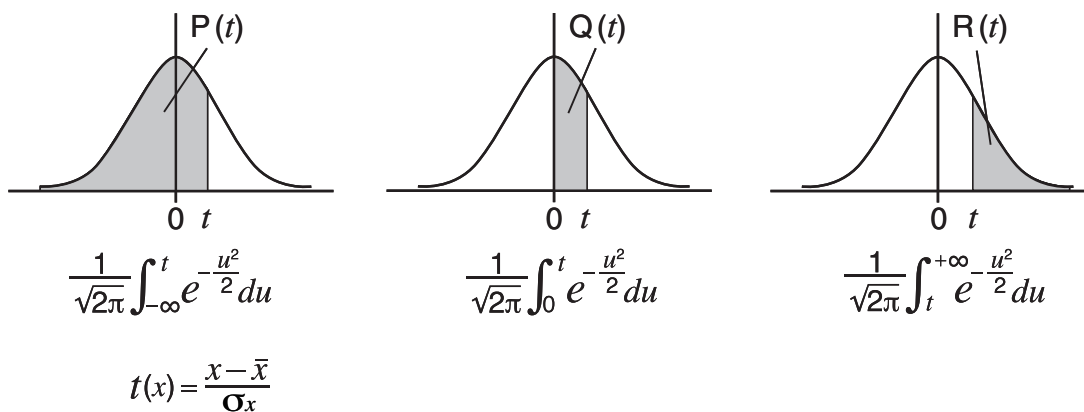

Example

The following table shows the results of measurements of the height of 20 college students. Determine what percentage of the students fall in the range 160.5 cm to 175.5 cm. Also, in what percentile does the 175.5 cm tall student fall?

Class no.	Height (cm)	Frequency
1	158.5	1
2	160.5	1
3	163.3	2
4	167.5	2
5	170.2	3

Class no.	Height (cm)	Frequency
6	173.3	4
7	175.5	2
8	178.6	2
9	180.4	2
10	186.7	1

1. From the Main Menu, enter the **Statistics** mode.
2. Input the height data into List 1 and the frequency data into List 2.
3. Perform the single-variable statistical calculations.

You can obtain the normalized variate immediately after performing single-variable statistical calculations only.

	Real(Norm)	d/c(Real)
1-Variable		
\bar{x}	=172.005	
Σx	=3440.1	
Σx^2	=592706.09	
σx	=7.04162445	
sx	=7.22455425	
n	=20	

F2(CALC) **F6**(SET)
F1(LIST) **1** **EXE**
F2(LIST) **2** **EXE** **SHIFT** **EXIT**(QUIT)
F2(CALC) **F1**(1-VAR)

4. Press **MENU**, select the **Run-Matrix** mode, press **OPTN** **F6**(\triangleright) **F3**(PROB) **F6**(\triangleright) to recall the probability calculation (PROB) menu.

F3(PROB) **F6**(\triangleright) **F4**(t) **1** **6** **0** **.** **5** **)** **EXE**

(Normalized variate t for 160.5 cm)

Result: -1.633855948
(\approx -1.634)

F4(t) **1** **7** **5** **.** **5** **)** **EXE**

(Normalized variate t for 175.5 cm)

Result: 0.4963343361
(\approx 0.496)

F1(P) **0** **.** **4** **9** **6** **)** **=**

F1(P) **(\leftarrow)** **1** **.** **6** **3** **4** **)** **EXE**

(Percentage of total)

Result: 0.6389233692
(63.9% of total)

F3(R) **0** **.** **4** **9** **6** **)** **EXE**

(Percentile)

Result: 0.3099472055
(31.0 percentile)

■ Drawing a Normal Probability Distribution Graph

You can draw a normal probability distribution graph using manual graphing with the **Run-Matrix** mode.

1. From the Main Menu, enter the **Run-Matrix** mode.
2. Input the commands to draw a rectangular coordinate graph.
3. Input the probability value.

Example To draw a normal probability P (0.5) graph.

- ① **MENU** Run-Matrix
SHIFT **MENU** (SET UP) **F2** (Line) **EXIT**
- ② **SHIFT** **F4** (SKETCH) **F1** (Cls) **EXE**
F5 (GRAPH) **F1** (Y=)
- ③ **OPTN** **F6** (\triangleright) **F3** (PROB) **F6** (\triangleright) **F1** (P()) **0** **.** **5** **)** **EXE**

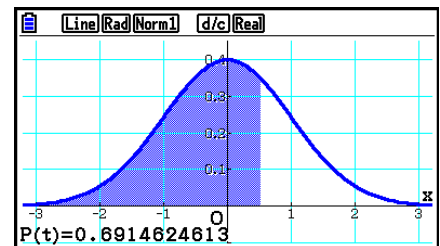

■ Calculations Using the Distribution Function

You can use special functions in the **Run-Matrix** mode or **Program** mode to perform calculations that are the same as the **Statistics** mode distribution function calculation (page 6-50).

Example To calculate normal probability distribution in the Run-Matrix mode for the data {1, 2, 3}, when the population standard deviation is $\sigma = 1.5$ and the population mean is $\mu = 2$.

1. From the Main Menu, enter the **Run-Matrix** mode.
2. Press the keys as follows.

SHIFT **MENU** (SET UP) **F2** (Line) **EXIT**
OPTN **F5** (STAT) **F3** (DIST) **F1** (NORM)
F1 (Npd) **SHIFT** **X** ({}) **1** **,** **2** **,** **3**
SHIFT **÷** ({}) **,** **1** **.** **5** **,** **2** **)** **EXE**

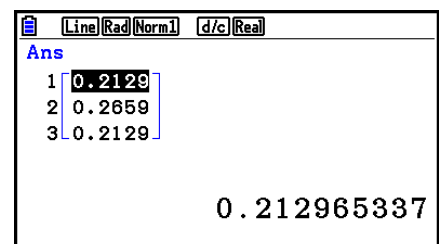

- For details about what you can do with the distribution function and its syntax, see “Performing Distribution Calculations in a Program” (page 8-41).

■ Determining Sample Standard Deviation, Unbiased Variance, Population Standard Deviation, and Population Variance from List Data

You can use functions to determine sample standard deviation, unbiased variance, population standard deviation, and population variance for specified list data. This calculation is performed in the **Run-Matrix** mode. You can perform calculations using data you saved to a list (List 1 to List 26) with the **Statistics** mode List Editor or list data you input directly on the **Run-Matrix** mode screen.

Syntax StdDev(List *n* [,List *m*]) StdDev_σ(List *n* [,List *m*])
 Variance(List *n* [,List *m*]) Variance_σ²(List *n* [,List *m*])
 List *n*.....Sample data
 List *m*.....Frequency data

Example To store the *x*-data below in List 1, the frequency values in List 2, and determine sample standard deviation, unbiased variance, population standard deviation, and population variance

<i>x</i>	60	70	80	90
Frequency	3	5	4	1

1. From the Main Menu, enter the **Statistics** mode.
2. Use the List Editor to store the above data.
3. From the Main Menu, enter the **Run-Matrix** mode.
4. Press the keys as follows.

OPTN F5 (STAT) F4 (StdDev) F1 (S) EXIT EXIT
 F1 (LIST) F1 (List) 1 ▸ F1 (List) 2 ▸ EXE

EXIT F5 (STAT) F5 (Var) F1 (S²) EXIT EXIT
 F1 (LIST) F1 (List) 1 ▸ F1 (List) 2 ▸ EXE

Math Rad Norm1 d/c Real
 StdDev(List 1, List 2) 9.26808696
 Variance(List 1, List 2) 85.8974359
 List List→Mat Dim Fill(Seq ▸

OPTN F5 (STAT) F4 (StdDev) F2 (σ) EXIT EXIT
 F1 (LIST) F1 (List) 1 ▸ F1 (List) 2 ▸ EXE

OPTN F5 (STAT) F5 (Var) F2 (σ²) EXIT EXIT
 F1 (LIST) F1 (List) 1 ▸ F1 (List) 2 ▸ EXE

Math Rad Norm1 d/c Real
 Variance(List 1, List 2) 85.8974359
 StdDev_σ(List 1, List 2) 8.904489925
 Variance_σ²(List 1, List 2) 79.28994083
 List List→Mat Dim Fill(Seq ▸

■ Calculations Using the TEST Command

You can use special functions in the **Run-Matrix** mode or **Program** mode to perform calculations that are the same as the **Statistics** mode Z Test, t Test, and other test calculations (page 6-33).

Example To determine the z score and p -value when a one-sample Z test is performed under the conditions below:
test condition (μ condition) $\neq \mu_0^*$, assumed population mean $\mu_0 = 0$, population standard deviation $\sigma = 1$, sample mean $\bar{x} = 1$, number of samples $n = 2$

* " μ condition $\neq \mu_0$ " can be specified by entering 0 as the initial argument of the one-sample Z test command "OneSampleZTest".

1. From the Main Menu, enter the **Run-Matrix** mode.
2. Perform the following key operation.

[SHIFT] [MENU] (SET UP) [F2] (Line) [EXIT]
 [OPTN] [F5] (STAT) [F6] (\triangleright) [F1] (TEST) [F1] (Z)
 [F1] (1-Sample) [0] [↵] [0] [↵] [1] [↵] [1]
 [↵] [2] [EXE]

[EXIT] [EXIT] [EXIT]
 [F1] (LIST) [F1] (List) [SHIFT] [←] (Ans) [EXE]

```

Line Rad Norm1 d/c Real
OneSampleZTest 0,0,1,
1,2
Done
  
```

```

Line Rad Norm1 d/c Real
Ans
1 1.4142
2 0.1572
3 1
4 2
1.414213562
  
```

The following calculation results are displayed as ListAns elements 1 through 4.

- 1: z score
- 2: p -value
- 3: \bar{x}
- 4: n

- For details about the function of the supported TEST command and their syntax, see "Using the TEST Command to Execute a Command in a Program" (page 8-45).

5. Tests

The **Z Test** provides a variety of different standardization-based tests. They make it possible to test whether or not a sample accurately represents the population when the standard deviation of a population (such as the entire population of a country) is known from previous tests. *Z* testing is used for market research and public opinion research, that need to be performed repeatedly.

1-Sample Z Test tests for the unknown population mean when the population standard deviation is known.

2-Sample Z Test tests the equality of the means of two populations based on independent samples when both population standard deviations are known.

1-Prop Z Test tests for an unknown proportion of successes.

2-Prop Z Test tests to compare the proportion of successes from two populations.

The **t Test** tests the hypothesis when the population standard deviation is unknown. The hypothesis that is the opposite of the hypothesis being proven is called the *null hypothesis*, while the hypothesis being proved is called the *alternative hypothesis*. The *t* Test is normally applied to test the null hypothesis. Then a determination is made whether the null hypothesis or alternative hypothesis will be adopted.

1-Sample t Test tests the hypothesis for a single unknown population mean when the population standard deviation is unknown.

2-Sample t Test compares the population means when the population standard deviations are unknown.

LinearReg t Test calculates the strength of the linear association of paired data.

With the **χ^2 test**, a number of independent groups are provided and a hypothesis is tested relative to the probability of samples being included in each group.

The **χ^2 GOF test** (χ^2 one-way Test) tests whether the observed count of sample data fits a certain distribution. For example, it can be used to determine conformance with normal distribution or binomial distribution.

The **χ^2 two-way test** creates a cross-tabulation table that structures mainly two qualitative variables (such as “Yes” and “No”), and evaluates the independence of the variables.

2-Sample F Test tests the hypothesis for the ratio of sample variances. It could be used, for example, to test the carcinogenic effects of multiple suspected factors such as tobacco use, alcohol, vitamin deficiency, high coffee intake, inactivity, poor living habits, etc.

ANOVA tests the hypothesis that the population means of the samples are equal when there are multiple samples. It could be used, for example, to test whether or not different combinations of materials have an effect on the quality and life of a final product.

One-Way ANOVA is used when there is one independent variable and one dependent variable.

Two-Way ANOVA is used when there are two independent variables and one dependent variable.

The following pages explain various statistical calculation methods based on the principles described above. Details concerning statistical principles and terminology can be found in any standard statistics textbook.

On the initial **Statistics** mode screen, press **F3**(TEST) to display the test menu, which contains the following items.

- **F3**(TEST) **F1**(Z) ... *Z* Tests (below)
 - F2**(t) ... *t* Tests (page 6-37)
 - F3**(CHI) ... χ^2 Test (page 6-40)
 - F4**(F) ... 2-Sample *F* Test (page 6-42)
 - F5**(ANOVA) ... ANOVA (page 6-43)

After setting all the parameters, use \blacktriangledown to move the highlighting to “Execute” and then press one of the function keys shown below to perform the calculation or draw the graph.

- **F1**(CALC) ... Performs the calculation.
- **F6**(DRAW) ... Draws the graph.

■ Test Common Functions

- You can use the procedure below to specify the graph line color before graphing test calculation results.
 1. Display the *Z*-test, *t*-test, χ^2 Test, 2-Sample *F* Test, or Two-Way ANOVA screen.
 - To display the 1-Sample *Z* Test input screen, for example, display the List Editor and then press **F3**(TEST) **F1**(Z) **F1**(1-SAMPLE).
 2. Move the highlighting to “GphColor” and then press **F1**(COLOR).
 3. On the color selection dialog box that appears, use the cursor keys to move the highlighting to the desired color and then press **EXE**.
- V-Window settings are automatically optimized for drawing the graph.

■ Z Tests

• Z Test Common Functions

You can use the following graph analysis functions after drawing a *Z* Test result output graph.

- **F1**(Z) ... Displays *z* score.

Pressing **F1**(Z) displays the *z* score at the bottom of the display, and displays the pointer at the corresponding location in the graph (unless the location is off the graph screen).

Two points are displayed in the case of a two-tail test. Use \blacktriangleleft and \blacktriangleright to move the pointer.

- **F2**(P) ... Displays *p*-value.

Pressing **F2**(P) displays the *p*-value at the bottom of the display without displaying the pointer.

- Executing an analysis function automatically stores the *z* and *p* values in alpha variables *Z* and *P*, respectively.

• 1-Sample Z Test

This test is used when the population standard deviation is known to test the hypothesis. The **1-Sample Z Test** is applied to the normal distribution.

Perform the following key operations from the List Editor.

F3 (TEST)

F1 (Z)

F1 (1-SAMPLE)

```

Rad(Norm1) d/c(Real)
1-Sample ZTest
Data :List
μ      :≠μ0
μ0     :0
σ      :1
List   :List1
Freq   :1
Save Res:None
GphColor:Blue
Execute
    
```

The following shows the parameter data specification items that are different from list data specification.

```

x̄      :0
n      :0
    
```

Calculation Result Output Example

```

Rad(Norm1) d/c(Real)
1-Sample ZTest
μ      ≠11.4
z      =0.26832815
p      =0.78844673
x̄      =11.52
sx     =0.61806148
n      =5
    
```

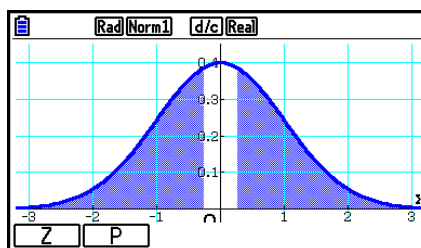

$\mu \neq 11.4$ direction of test

s_x Displayed only for Data:List setting.

- [Save Res] does not save the μ condition in line 2.

• 2-Sample Z Test

This test is used when the standard deviations for two populations are known to test the hypothesis. The **2-Sample Z Test** is applied to the normal distribution.

Perform the following key operations from the List Editor.

F3 (TEST)

F1 (Z)

F2 (2-SAMPLE)

```

Rad(Norm1) d/c(Real)
2-Sample ZTest
Data :List
μ1   :≠μ2
σ1   :1
σ2   :1
List(1) :List1
List(2) :List2
Freq(1) :1
Freq(2) :1
Save Res:None
GphColor:Blue
Execute
    
```

The following shows the parameter data specification items that are different from list data specification.

\bar{x}_1	:	0
n_1	:	0
\bar{x}_2	:	0
n_2	:	0

Calculation Result Output Example

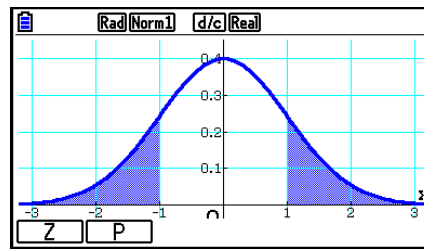
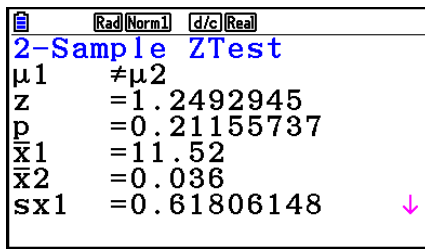

$\mu_1 \neq \mu_2$ direction of test
 s_{x1} Displayed only for Data:List setting.
 s_{x2} Displayed only for Data:List setting.

- [Save Res] does not save the μ_1 condition in line 2.

• **1-Prop Z Test**

This test is used to test for an unknown proportion of successes. The **1-Prop Z Test** is applied to the normal distribution.

Perform the following key operations from the List Editor.

- F3** (TEST)
- F1** (Z)
- F3** (1-PROP)

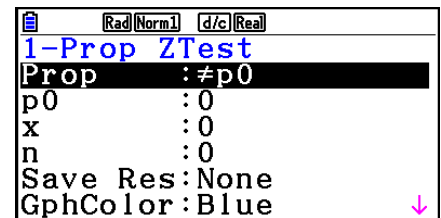

Execute

Calculation Result Output Example

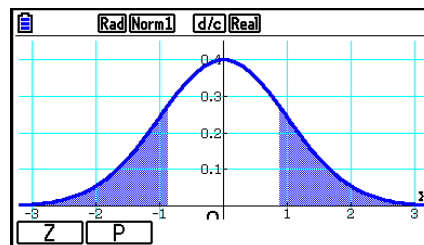
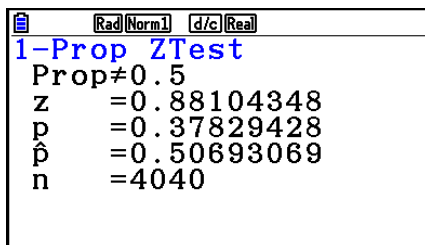

Prop≠0.5 direction of test

- [Save Res] does not save the Prop condition in line 2.

• 2-Prop Z Test

This test is used to compare the proportion of successes. The **2-Prop Z Test** is applied to the normal distribution.

Perform the following key operation from the List Editor.

[F3] (TEST)

[F1] (Z)

[F4] (2-PROP)

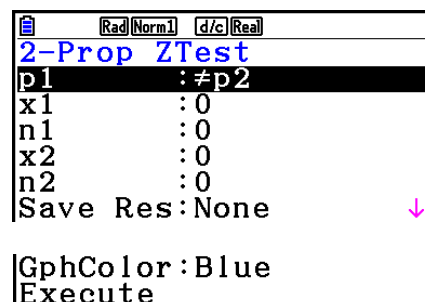

Calculation Result Output Example

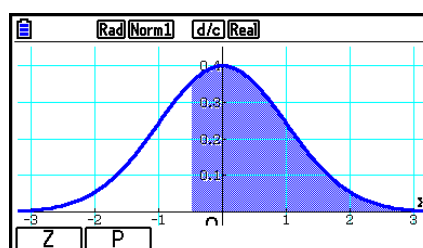
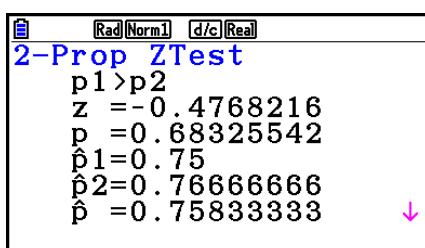

$p_1 > p_2$ direction of test

- [Save Res] does not save the p_1 condition in line 2.

■ t Tests

• t Test Common Functions

You can use the following graph analysis functions after drawing a t Test result output graph.

- **[F1]** (T) ... Displays t score.

Pressing **[F1]** (T) displays the t score at the bottom of the display, and displays the pointer at the corresponding location in the graph (unless the location is off the graph screen).

Two points are displayed in the case of a two-tail test. Use **[◀]** and **[▶]** to move the pointer.

- **[F2]** (P) ... Displays p -value.

Pressing **[F2]** (P) displays the p -value at the bottom of the display without displaying the pointer.

- Executing an analysis function automatically stores the t and p values in alpha variables T and P, respectively.

• 1-Sample t Test

This test uses the hypothesis test for a single unknown population mean when the population standard deviation is unknown. The **1-Sample t Test** is applied to t distribution.

Perform the following key operations from the List Editor.

F3 (TEST)

F2 (t)

F1 (1-SAMPLE)

```

Rad(Norm1) d/c(Real)
1-Sample tTest
Data :List
μ      :>μ0
μ0     :0
List   :List1
Freq   :1
Save Res:None
GphColor:Blue
Execute
  
```

The following shows the parameter data specification items that are different from list data specification.

```

x̄      :0
sx     :0
n      :0
  
```

Calculation Result Output Example

```

Rad(Norm1) d/c(Real)
1-Sample tTest
μ      ≠11.3
t      =0.79593206
p      =0.47063601
x̄      =11.52
sx     =0.61806148
n      =5
  
```

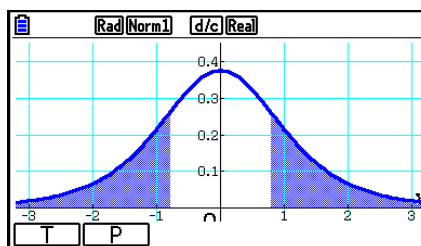

$\mu \neq 11.3$ direction of test

- [Save Res] does not save the μ condition in line 2.

• 2-Sample t Test

2-Sample t Test compares the population means when the population standard deviations are unknown. The **2-Sample t Test** is applied to t distribution.

Perform the following key operations from the List Editor.

F3 (TEST)

F2 (t)

F2 (2-SAMPLE)

```

Rad(Norm1) d/c(Real)
2-Sample tTest
Data :List
μ1   :≠μ2
List(1) :List1
List(2) :List2
Freq(1) :1
Freq(2) :1
Pooled :Off
Save Res:None
GphColor:Blue
Execute
  
```

The following shows the parameter data specification items that are different from list data specification.

$\bar{x}1$:0
$sx1$:0
$n1$:0
$\bar{x}2$:0
$sx2$:0
$n2$:0

Calculation Result Output Example

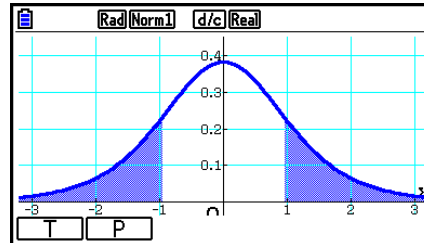
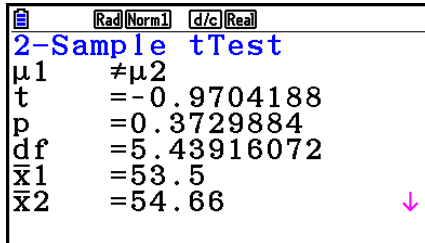

$\mu_1 \neq \mu_2$ direction of test
 s_p Displayed only when Pooled:On setting.

- [Save Res] does not save the μ_1 condition in line 2.

• **LinearReg t Test**

LinearReg t Test treats paired-variable data sets as (x, y) pairs, and uses the method of least squares to determine the most appropriate a, b coefficients of the data for the regression formula $y = a + bx$. It also determines the correlation coefficient and t score, and calculates the extent of the relationship between x and y .

Perform the following key operations from the List Editor.

- F3** (TEST)
- F2** (t)
- F3** (REG)

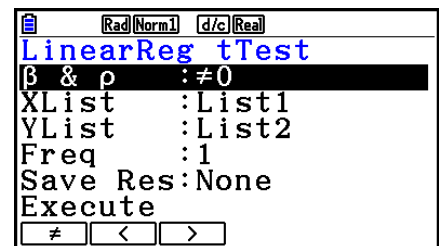

Calculation Result Output Example

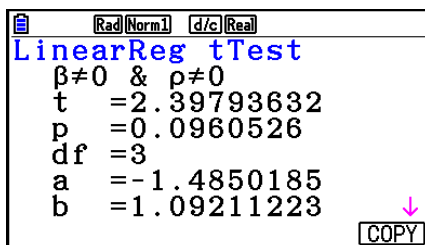

$\beta \neq 0$ & $\rho \neq 0$ direction of test

Pressing **F6** (COPY) while a calculation result is on the display copies the regression formula to the graph relation list.

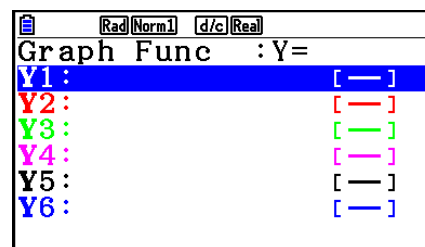

When there is a list specified for the [Resid List] item on the Setup screen, regression formula residual data is automatically saved to the specified list after the calculation is finished.

- You cannot draw a graph for LinearReg t Test.
- [Save Res] does not save the β & ρ conditions in line 2.
- When the list specified by [Save Res] is the same list specified by the [Resid List] item on the Setup screen, only [Resid List] data is saved in the list.

■ χ^2 Test

• χ^2 Test Common Functions

You can use the following graph analysis functions after drawing a graph.

- **F1** (CHI) ... Displays χ^2 value.

Pressing **F1** (CHI) displays the χ^2 value at the bottom of the display, and displays the pointer at the corresponding location in the graph (unless the location is off the graph screen).

- **F2** (P) ... Displays p -value.

Pressing **F2** (P) displays the p -value at the bottom of the display without displaying the pointer.

- Executing an analysis function automatically stores the χ^2 and p values in alpha variables C and P, respectively.

• χ^2 GOF Test (χ^2 one-way Test)

The χ^2 GOF Test (χ^2 one-way test) tests whether the frequency of sample data fits a certain distribution. For example, it can be used to determine conformance with normal distribution or binomial distribution.

Perform the following key operations from the List Editor.

- F3** (TEST)
- F3** (CHI)
- F1** (GOF)

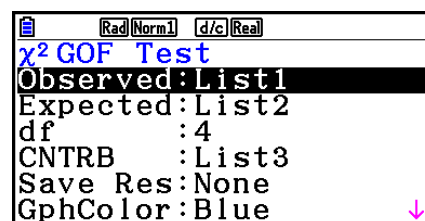

Execute

Next, specify the lists that contain the data. The following shows the meaning of the above items.

Observed..... name of list (1 to 26) that contains observed counts (all cells positive integers)

Expected..... name of list (1 to 26) that is for saving expected frequency

CNTRB Specifies a list (List 1 to List 26) as the storage location of the contribution of each observed count obtained as calculation results.

Calculation Result Output Examples

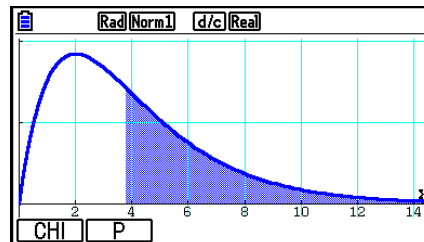
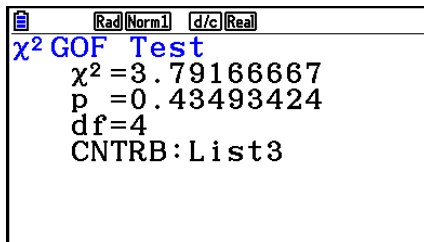

CNTRB list for output of contribution values

• χ^2 two-way Test

χ^2 two-way Test sets up a number of independent groups and tests hypothesis related to the proportion of the sample included in each group. The χ^2 Test is applied to dichotomous variables (variable with two possible values, such as yes/no).

Perform the following key operations from the List Editor.

F3 (TEST)

F3 (CHI)

F2 (2WAY)



Next, specify the matrix that contains the data. The following shows the meaning of the above items.

Observed..... name of matrix (A to Z) that contains observed counts (all cells positive integers)

Expected..... name of matrix (A to Z) that is for saving expected frequency

Calculation Result Output Example

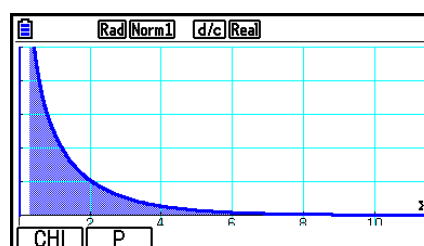
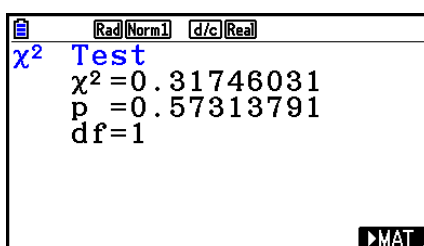

- The matrix must be at least two lines by two columns. An error occurs if the matrix has only one line or one column.
- Pressing **F1** (Mat) while the “Observed” and “Expected” parameter settings are highlighted will display the Matrix (A to Z) setting screen.
- Pressing **F2** (▶MAT) while the “Observed” and “Expected” parameter settings are highlighted enters the Matrix Editor, which you can use to edit and view the contents of matrices.
- Pressing **F6** (▶MAT) while a calculation result is displayed enters the Matrix Editor, which you can use to edit and view the contents of matrices.
- Switching from the Matrix Editor to the Vector Editor is not supported.

■ 2-Sample *F* Test

2-Sample *F* Test tests the hypothesis for the ratio of sample variances. The *F* Test is applied to the *F* distribution.

Perform the following key operations from the List Editor.

F3 (TEST)

F4 (F)

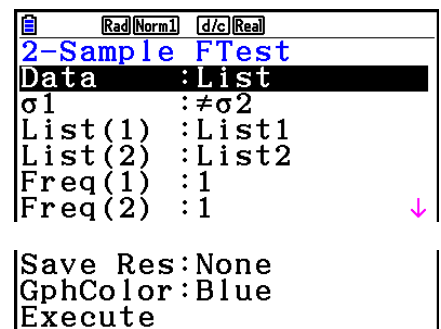

The following shows the parameter data specification items that are different from list data specification.

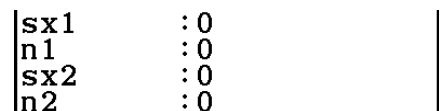

Calculation Result Output Example

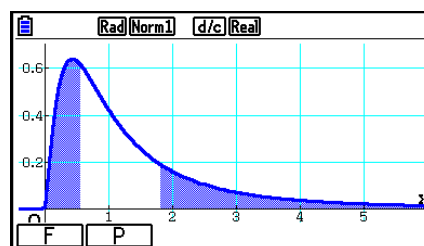
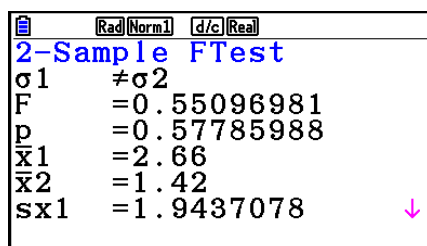

$\sigma_1 \neq \sigma_2$ direction of test

\bar{x}_1 Displayed only for Data:List setting.

\bar{x}_2 Displayed only for Data:List setting.

You can use the following graph analysis functions after drawing a graph.

- **F1** (F) ... Displays F value.

Pressing **F1** (F) displays the F value at the bottom of the display, and displays the pointer at the corresponding location in the graph (unless the location is off the graph screen).

Two points are displayed in the case of a two-tail test. Use **◀** and **▶** to move the pointer.

- **F2** (P) ... Displays p -value.

Pressing **F2** (P) displays the p -value at the bottom of the display without displaying the pointer.

- Executing an analysis function automatically stores the F and p values in variables F and P, respectively.
- [Save Res] does not save the σ_1 condition in line 2.

■ ANOVA

ANOVA tests the hypothesis that the population means of the samples are equal when there are multiple samples.

One-Way ANOVA is used when there is one independent variable and one dependent variable.

Two-Way ANOVA is used when there are two independent variables and one dependent variable.

Perform the following key operations from the List Editor.

F3 (TEST)

F5 (ANOVA)

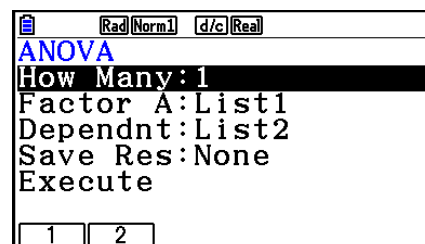

The following is the meaning of each item in the case of list data specification.

How Many..... selects One-Way ANOVA or Two-Way ANOVA (number of levels)

Factor A list to be used for category data (List 1 to 26)

Dependnt list to be used for sample data (List 1 to 26)

Save Res first list for storage of calculation results (None or List 1 to 22)*¹

Execute executes a calculation or draws a graph (Two-Way ANOVA only)

*¹ [Save Res] saves each vertical column of the table into its own list. The leftmost column is saved in the specified list, and each subsequent column to the right is saved in the next sequentially numbered list. Up to five lists can be used for storing columns. You can specify an first list number in the range of 1 to 22.

The following item appears in the case of Two-Way ANOVA only.

Factor B list to be used for category data (List 1 to 26)

GphColor specifies the graph line color (page 6-34)

After setting all the parameters, use  to move the highlighting to “Execute” and then press one of the function keys shown below to perform the calculation or draw the graph.

- **F1** (CALC) ... Performs the calculation.
- **F6** (DRAW) ... Draws the graph (Two-Way ANOVA only).

Calculation results are displayed in table form, just as they appear in science books.

Data and Calculation Result Example

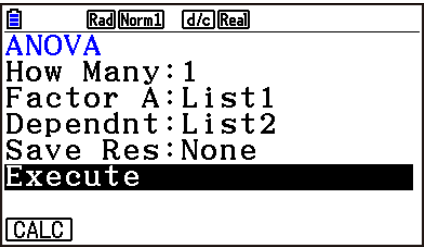
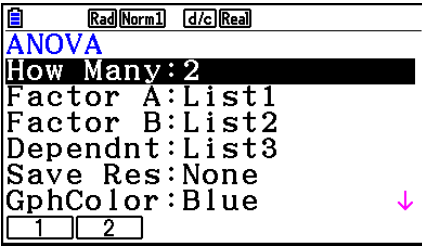
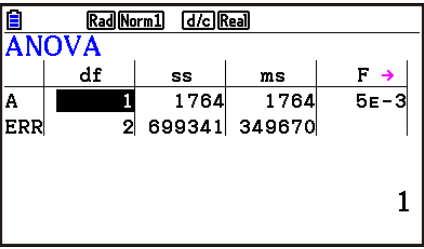
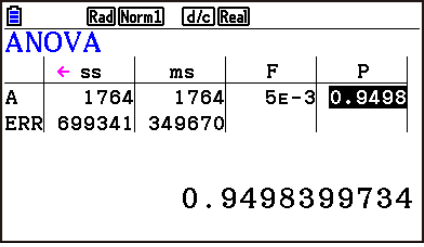
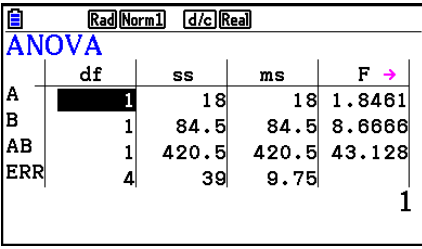
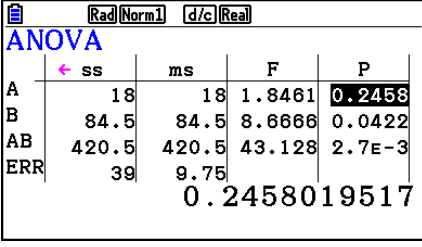
	One-Way ANOVA	Two-Way ANOVA
Data	List1={1,1,2,2} List2={124,913,120,1001}	List1={1,1,1,1,2,2,2,2} List2={1,1,2,2,1,1,2,2} List3={113,116,139,132,133,131,126,122}
Setup Screen		
Calculation Result	 	 

One-Way ANOVA

Line 1 (A) Factor A *df* value, *SS* value, *MS* value, *F* value, *p*-value

Line 2 (ERR) Error *df* value, *SS* value, *MS* value

Two-Way ANOVA

Line 1 (A) Factor A *df* value, *SS* value, *MS* value, *F* value, *p*-value

Line 2 (B) Factor B *df* value, *SS* value, *MS* value, *F* value, *p*-value

Line 3 (AB) Factor A × Factor B *df* value, *SS* value, *MS* value, *F* value, *p*-value

* Line 3 does not appear when there is only one observation in each cell.

Line 4 (ERR) Error *df* value, *SS* value, *MS* value

F *F* value

p *p*-value

df degrees of freedom

SS sum of squares

MS mean squares

With Two-Way ANOVA, you can draw Interaction Plot graphs. The number of graphs depends on Factor B, while the number of X-axis data depends on the Factor A. The Y-axis is the average value of each category.

You can use the following graph analysis function after drawing a graph.

- **F1** (Trace) or **SHIFT F1** (TRACE) ... Trace function

Pressing **◀** or **▶** moves the pointer on the graph in the corresponding direction. When there are multiple graphs, you can move between graphs by pressing **▲** and **▼**.

- Graphing is available with Two-Way ANOVA only. V-Window settings are performed automatically, regardless of Setup screen settings.
- Using the Trace function automatically stores the number of conditions to variable A and the mean value to variable M, respectively.

■ ANOVA (Two-Way)

● Description

The nearby table shows measurement results for a metal product produced by a heat treatment process based on two treatment levels: time (A) and temperature (B). The experiments were repeated twice each under identical conditions.

B (Heat Treatment Temperature) A (Time)	B1	B2
A1	113 , 116	139 , 132
A2	133 , 131	126 , 122

Perform analysis of variance on the following null hypothesis, using a significance level of 5%.

H_0 : No change in strength due to time

H_0 : No change in strength due to heat treatment temperature

H_0 : No change in strength due to interaction of time and heat treatment temperature

● Solution

Use Two-Way ANOVA to test the above hypothesis.

Input the above data as shown below.

List1={1,1,1,1,2,2,2,2}

List2={1,1,2,2,1,1,2,2}

List3={113,116,139,132,133,131,126,122}

Define List 3 (the data for each group) as Dependent. Define List 1 and List 2 (the factor numbers for each data item in List 3) as Factor A and Factor B respectively. Executing the test produces the following results.

- Time differential (A) level of significance $P = 0.2458019517$
The level of significance ($p = 0.2458019517$) is greater than the significance level (0.05), so the hypothesis is not rejected.
- Temperature differential (B) level of significance $P = 0.04222398836$
The level of significance ($p = 0.04222398836$) is less than the significance level (0.05), so the hypothesis is rejected.
- Interaction (A \times B) level of significance $P = 2.78169946e-3$
The level of significance ($p = 2.78169946e-3$) is less than the significance level (0.05), so the hypothesis is rejected.

The above test indicates that the time differential is not significant, the temperature differential is significant, and interaction is highly significant.

• Input Example

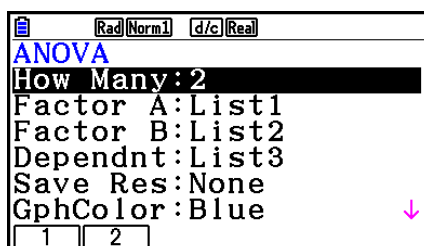

• Results

	df	ss	ms	F
A	1	18	18	1.8461
B	1	84.5	84.5	8.6666
AB	1	420.5	420.5	43.128
ERR	4	39	9.75	

	ss	ms	F	P
A	18	18	1.8461	0.2458
B	84.5	84.5	8.6666	0.0422
AB	420.5	420.5	43.128	2.7E-3
ERR	39	9.75		

0.2458019517

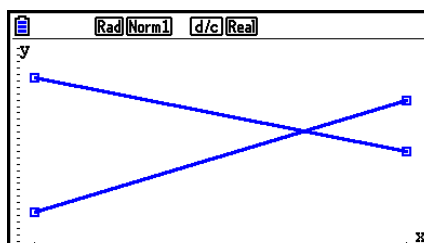

6. Confidence Interval

A confidence interval is a range (interval) that includes a statistical value, usually the population mean.

A confidence interval that is too broad makes it difficult to get an idea of where the population value (true value) is located. A narrow confidence interval, on the other hand, limits the population value and makes it difficult to obtain reliable results. The most commonly used confidence levels are 95% and 99%. Raising the confidence level broadens the confidence interval, while lowering the confidence level narrows the confidence level, but it also increases the chance of accidentally overlooking the population value. With a 95% confidence interval, for example, the population value is not included within the resulting intervals 5% of the time.

When you plan to conduct a survey and then t test and Z test the data, you must also consider the sample size, confidence interval width, and confidence level. The confidence level changes in accordance with the application.

1-Sample Z Interval calculates the confidence interval for an unknown population mean when the population standard deviation is known.

2-Sample Z Interval calculates the confidence interval for the difference between two population means when the population standard deviations of two samples are known.

1-Prop Z Interval calculates the confidence interval for an unknown proportion of successes.

2-Prop Z Interval calculates the confidence interval for the difference between the proportion of successes in two populations.

1-Sample t Interval calculates the confidence interval for an unknown population mean when the population standard deviation is unknown.

2-Sample t Interval calculates the confidence interval for the difference between two population means when both population standard deviations are unknown.

On the initial **Statistics** mode screen, press **F4** (INTR) to display the confidence interval menu, which contains the following items.

- **F4** (INTR) **F1** (Z) ... Z intervals (page 6-48)
F2 (t) ... t intervals (page 6-49)

After setting all the parameters, use **▼** to move the highlighting to “Execute” and then press the function key shown below to perform the calculation.

- **F1** (CALC) ... Performs the calculation.
- There is no graphing for confidence interval functions.

• General Confidence Interval Precaution

Inputting a value in the range of $0 \leq \text{C-Level} < 1$ for the C-Level setting sets a value you input. Inputting a value in the range of $1 \leq \text{C-Level} < 100$ sets a value equivalent to your input divided by 100.

■ Z Interval

• 1-Sample Z Interval

1-Sample Z Interval calculates the confidence interval for an unknown population mean when the population standard deviation is known.

Perform the following key operations from the List Editor.

F4 (INTR)
F1 (Z)
F1 (1-SAMPLE)

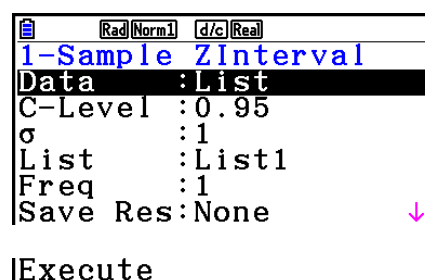

```
Rad(Norm1) d/c(Real)
1-Sample ZInterval
Data :List
C-Level :0.95
sigma :1
List :List1
Freq :1
Save Res:None
Execute
```

The following shows the parameter data specification items that are different from list data specification.

```
x̄ :0
n :0
```

Calculation Result Output Example

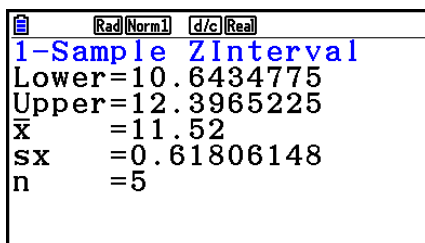

```
Rad(Norm1) d/c(Real)
1-Sample ZInterval
Lower=10.6434775
Upper=12.3965225
x̄ =11.52
sx =0.61806148
n =5
```

• 2-Sample Z Interval

2-Sample Z Interval calculates the confidence interval for the difference between two population means when the population standard deviations of two samples are known.

Perform the following key operations from the List Editor.

F4 (INTR)
F1 (Z)
F2 (2-SAMPLE)

• 1-Prop Z Interval

1-Prop Z Interval uses the number of data to calculate the confidence interval for an unknown proportion of successes.

Perform the following key operations from the List Editor.

- F4** (INTR)
- F1** (Z)
- F3** (1-PROP)

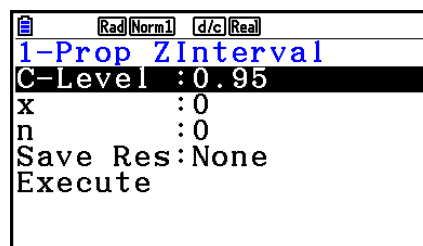

Data is specified using parameter specification.

Calculation Result Output Example

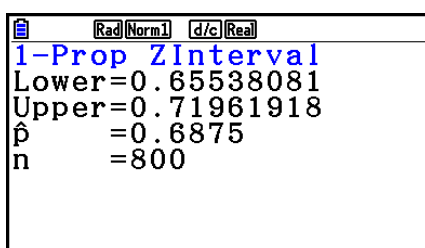

• 2-Prop Z Interval

2-Prop Z Interval uses the number of data items to calculate the confidence interval for the difference between the proportion of successes in two populations.

Perform the following key operations from the List Editor.

- F4** (INTR)
- F1** (Z)
- F4** (2-PROP)

■ *t* Interval

• 1-Sample *t* Interval

1-Sample *t* Interval calculates the confidence interval for an unknown population mean when the population standard deviation is unknown.

Perform the following key operations from the List Editor.

- F4** (INTR)
- F2** (t)
- F1** (1-SAMPLE)

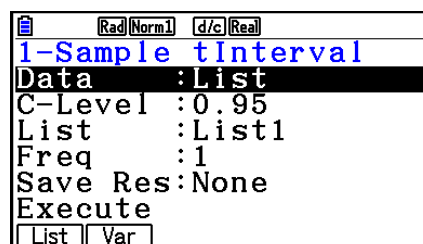

The following shows the parameter data specification items that are different from list data specification.

\bar{x}	: 0
sx	: 0
n	: 0

Calculation Result Output Example

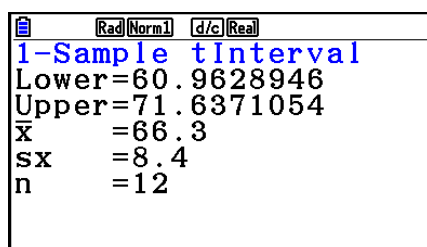

```
1-Sample t Interval
Lower=60.9628946
Upper=71.6371054
x̄ = 66.3
sx = 8.4
n = 12
```

• 2-Sample t Interval

2-Sample t Interval calculates the confidence interval for the difference between two population means when both population standard deviations are unknown. The t interval is applied to t distribution.

Perform the following key operations from the List Editor.

F4 (INTR)

F2 (t)

F2 (2-SAMPLE)

7. Distribution

There is a variety of different types of distribution, but the most well-known is “normal distribution”, which is essential for performing statistical calculations. Normal distribution is a symmetrical distribution centered on the greatest occurrences of mean data (highest frequency), with the frequency decreasing as you move away from the center. Poisson distribution, geometric distribution, and various other distribution shapes are also used, depending on the data type.

Certain trends can be determined once the distribution shape is determined. You can calculate the probability of data taken from a distribution being less than a specific value.

For example, distribution can be used to calculate the yield rate when manufacturing some product. Once a value is established as the criteria, you can calculate normal probability when estimating what percent of the products meet the criteria. Conversely, a success rate target (80% for example) is set up as the hypothesis, and normal distribution is used to estimate the proportion of the products will reach this value.

Normal probability density calculates the probability density of normal distribution from a specified x value.

Normal cumulative distribution calculates the probability of normal distribution data falling between two specific values.

Inverse normal cumulative distribution calculates a value that represents the location within a normal distribution for a specific cumulative probability.

Student- t probability density calculates t probability density from a specified x value.

Student- t cumulative distribution calculates the probability of t distribution data falling between two specific values.

Inverse Student- t cumulative distribution calculates the lower bound value of a Student- t cumulative probability density for a specified percentage.

Like t distribution, probability density (or probability), cumulative distribution and inverse cumulative distribution can also be calculated for χ^2 , F , **Binomial**, **Poisson**, **Geometric** and **Hypergeometric** distributions.

On the initial **Statistics** mode screen, press **F5**(DIST) to display the distribution menu, which contains the following items.

- **F5**(DIST) **F1**(NORM) ... Normal distribution (page 6-52)
 - F2**(t) ... Student- t distribution (page 6-54)
 - F3**(CHI) ... χ^2 distribution (page 6-55)
 - F4**(F) ... F distribution (page 6-57)
 - F5**(BINOMIAL) ... Binomial distribution (page 6-58)
 - F6**(▷) **F1**(POISSON) ... Poisson distribution (page 6-60)
 - F6**(▷) **F2**(GEO) ... Geometric distribution (page 6-62)
 - F6**(▷) **F3**(HYPRGEO) ... Hypergeometric distribution (page 6-64)

After setting all the parameters, use **▼** to move the highlighting to “Execute” and then press one of the function keys shown below to perform the calculation or draw the graph.

- **F1**(CALC) ... Performs the calculation.
- **F6**(DRAW) ... Draws the graph.

■ Common Distribution Functions

- Before drawing the graph of a distribution calculation result, you can use the procedure below to specify the graph line color (when Data:Variable only).
 1. Display the distribution input screen.
 - To display the normal probability density input screen, for example, display the List Editor and then press **F5**(DIST) **F1**(NORM) **F1**(Npd).
 2. Move the highlighting to “GphColor” and then press **F1**(COLOR).
 3. On the color selection dialog box that appears, use the cursor keys to move the highlighting to the desired color and then press **EXE**.

- V-Window settings for graph drawing are set automatically when the Setup screen's "Stat Wind" setting is "Auto". Current V-Window settings are used for graph drawing when the "Stat Wind" setting is "Manual".
- After drawing a graph, you can use the P-CAL function to calculate an estimated p -value for a particular x value. The P-CAL function can be used only after a Normal Probability Density, Student- t Probability Density, χ^2 Probability Density, or F Probability Density graph is drawn.

The following is the general procedure for using the P-CAL function.

1. After drawing a distribution graph, press **[SHIFT]** **[F5]** (G-SOLVE) **[F1]** (P-CAL) to display the x value input dialog box.
 2. Input the value you want for x and then press **[EXE]**.
 - This causes the x and p values to appear at the bottom of the display, and moves the pointer to the corresponding point on the graph.
 3. Pressing **[X,θ,T]** or a number key at this time causes the x value input dialog box to reappear so you can perform another estimated value calculation if you want.
 4. After you are finished, press **[EXIT]** to clear the coordinate values and the pointer from the display.
- Executing an analysis function automatically stores the x and p values in variables X and P, respectively.

■ Normal Distribution

• Normal Probability Density

Normal Probability Density calculates the probability density (p) for a specified single x -value or a list. When a list is specified, calculation results for each list element are displayed in list form.

[F5] (DIST) **[F1]** (NORM) **[F1]** (Npd)

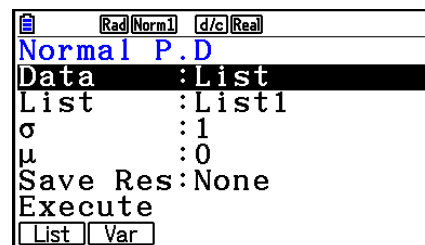

- Normal probability density is applied to standard normal distribution.
- Specifying $\sigma = 1$ and $\mu = 0$ specifies standard normal distribution.

Calculation Result Output Examples

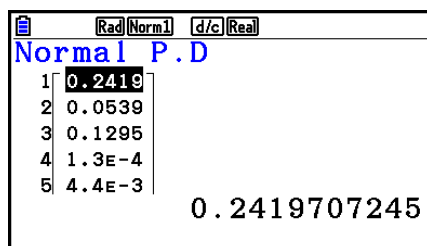

When a list is specified

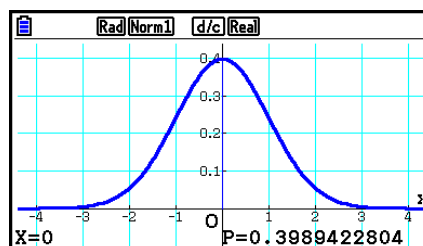

Graph when an x -value is specified

- Graphing is supported only when a variable is specified and a single x -value is entered as data.

• Normal Cumulative Distribution

Normal Cumulative Distribution calculates the normal cumulative probability of a normal distribution between a lower bound and an upper bound.

F5 (DIST) **F1** (NORM) **F2** (Ncd)

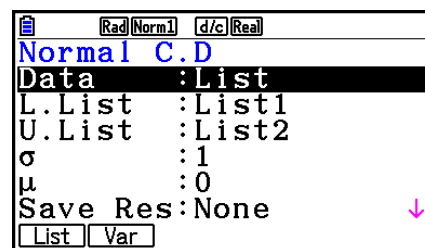

Calculation Result Output Examples

	p	z:Low	z:Up
1	0.1573	1	3
2	0.0807	1.4	4
3	0.0227	2	4
4	2.3E-4	3.5	5

0.1573053559

When a list is specified

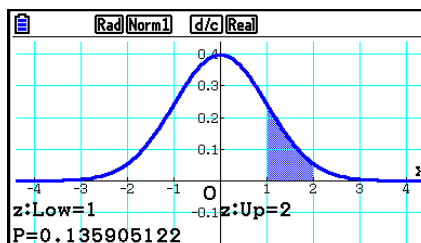

Graph when an x -value is specified

- Graphing is supported only when a variable is specified and a single x -value is entered as data.

• Inverse Normal Cumulative Distribution

Inverse Normal Cumulative Distribution calculates the boundary value(s) of a normal cumulative distribution probability for specified values.

F5 (DIST) **F1** (NORM) **F3** (InvN)

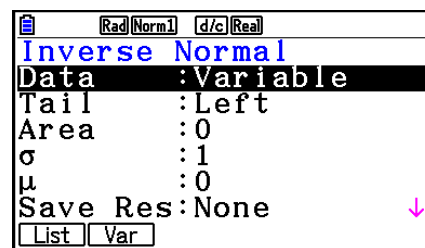

Area: probability value
($0 \leq \text{Area} \leq 1$)

Inverse cumulative normal distribution calculates a value that represents the location within a normal distribution for a specific cumulative probability.

$$\int_{-\infty}^{\text{Upper}} f(x)dx = p$$

Tail:Left

upper boundary
of integration
interval

$$\int_{\text{Lower}}^{+\infty} f(x)dx = p$$

Tail:Right

lower boundary
of integration
interval

$$\int_{\text{Lower}}^{\text{Upper}} f(x)dx = p$$

Tail:Central

upper and lower
boundaries of
integration interval

Specify the probability and use this formula to obtain the integration interval.

- This calculator performs the above calculation using the following: $\infty = 1\text{E}99$, $-\infty = -1\text{E}99$
- There is no graphing for Inverse Normal Cumulative Distribution.

Student-*t* Distribution

Student-*t* Probability Density

F5 (DIST) **F2** (t) **F1** (tpd)

Student-*t* Probability Density calculates the probability density (p) for a specified single x -value or a list. When a list is specified, calculation results for each list element are displayed in list form.

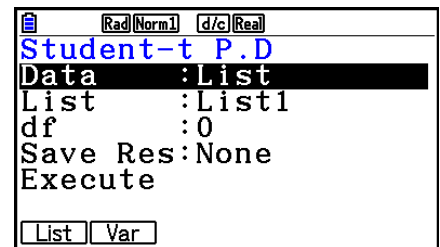

Calculation Result Output Examples

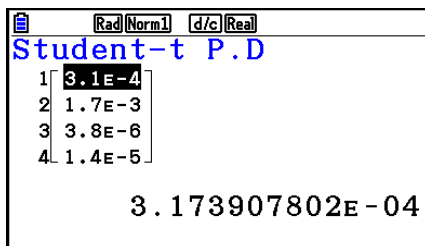

When a list is specified

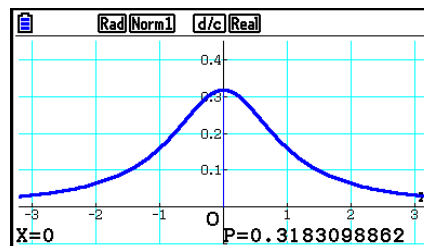

Graph when variable (x) is specified

- Graphing is supported only when a variable is specified and a single x -value is entered as data.

Student-*t* Cumulative Distribution

F5 (DIST) **F2** (t) **F2** (tcd)

Student-*t* Cumulative Distribution calculates the Student-*t* cumulative probability of a Student-*t* distribution between a lower bound and an upper bound.

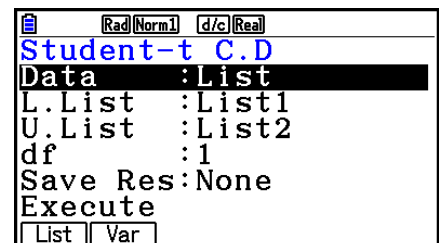

Calculation Result Output Examples

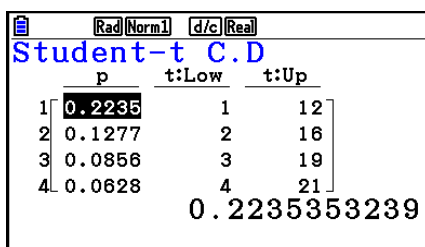

When a list is specified

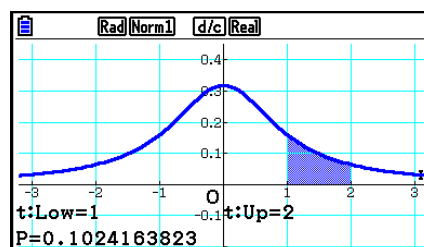

Graph when variable (x) is specified

- Graphing is supported only when a variable is specified and a single x -value is entered as data.

• Inverse Student-*t* Cumulative Distribution

F5 (DIST) **F2** (t) **F3** (Invt)

Inverse Student-*t* Cumulative Distribution calculates the lower bound value of a Student-*t* cumulative distribution for a specified *df* (degrees of freedom) value.

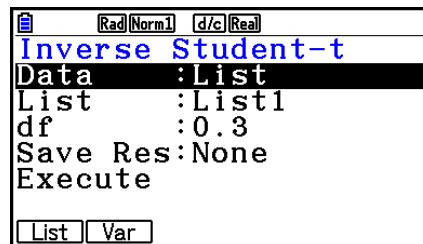

Calculation Result Output Examples

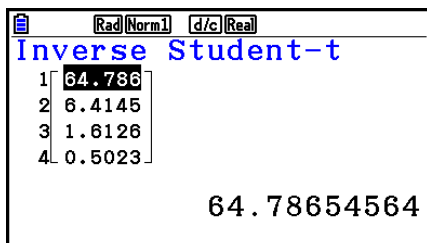

When a list is specified

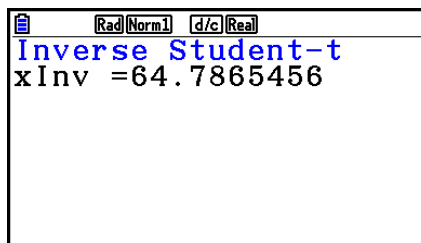

When variable (*x*) is specified

- There is no graphing for Inverse Student-*t* Cumulative Distribution.

■ χ^2 Distribution

• χ^2 Probability Density

F5 (DIST) **F3** (CHI) **F1** (Cpd)

χ^2 Probability Density calculates the χ^2 probability density (*p*) for a specified single *x*-value or a list. When a list is specified, calculation results for each list element are displayed in list form.

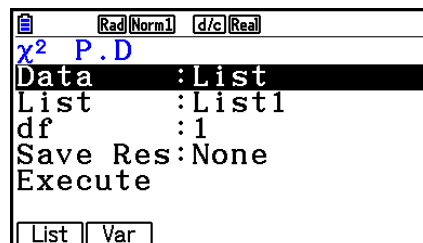

Calculation Result Output Examples

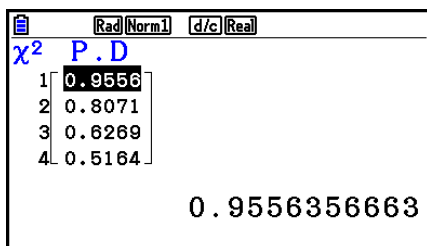

When a list is specified

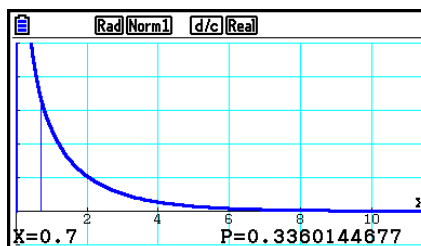

Graph when variable (*x*) is specified

- Graphing is supported only when a variable is specified and a single *x*-value is entered as data.

• χ^2 Cumulative Distribution

F5 (DIST) **F3** (CHI) **F2** (Ccd)

χ^2 Cumulative Distribution calculates the cumulative probability of a χ^2 distribution between a lower bound and an upper bound.

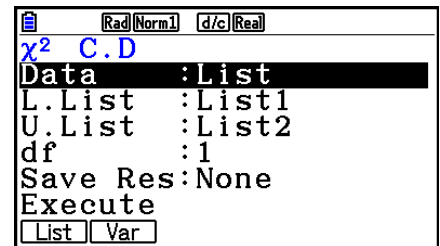

Calculation Result Output Examples

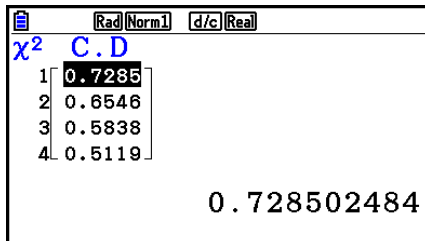

When a list is specified

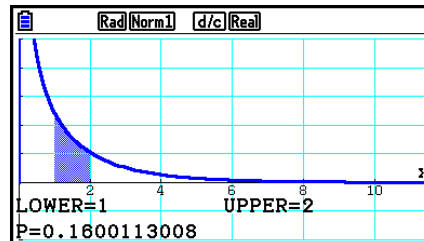

Graph when variable (x) is specified

- Graphing is supported only when a variable is specified and a single x -value is entered as data.

• Inverse χ^2 Cumulative Distribution

F5 (DIST) **F3** (CHI) **F3** (InvC)

Inverse χ^2 Cumulative Distribution calculates the lower bound value of a χ^2 cumulative distribution probability for a specified df (degrees of freedom) value.

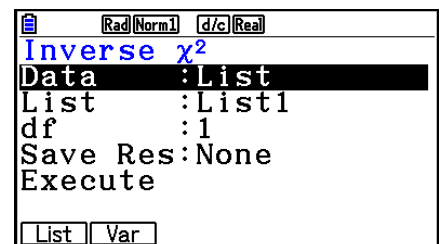

Calculation Result Output Examples

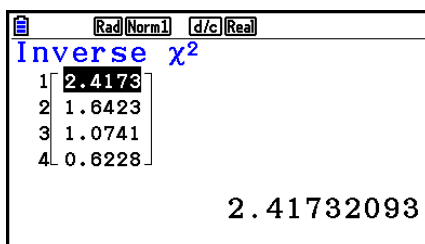

When a list is specified

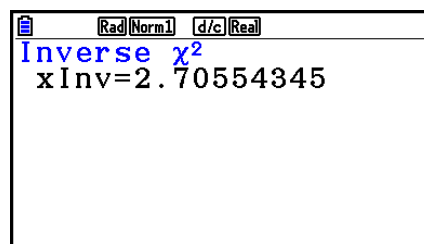

When variable (x) is specified

- There is no graphing for Inverse χ^2 Cumulative Distribution.

■ *F* Distribution

• *F* Probability Density

F Probability Density calculates the *F* probability density (p) for a specified single x -value or a list. When a list is specified, calculation results for each list element are displayed in list form.

[F5] (DIST) [F4] (F) [F1] (Fpd)

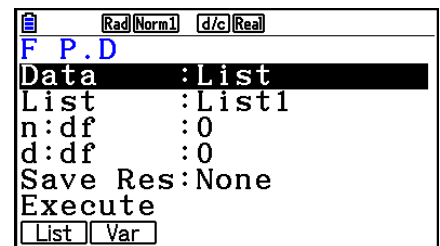

Calculation Result Output Examples

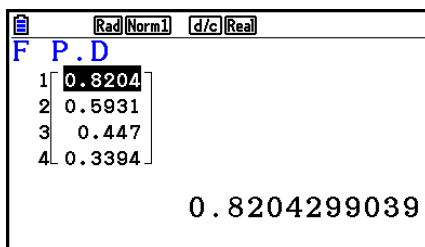

When a list is specified

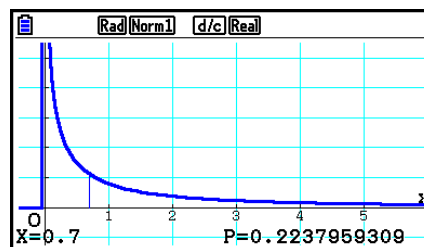

Graph when variable (x) is specified

- Graphing is supported only when a variable is specified and a single x -value is entered as data.

• *F* Cumulative Distribution

F Cumulative Distribution calculates the cumulative probability of an *F* distribution between a lower bound and an upper bound.

[F5] (DIST) [F4] (F) [F2] (Fcd)

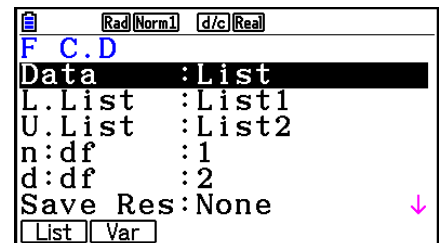

Calculation Result Output Examples

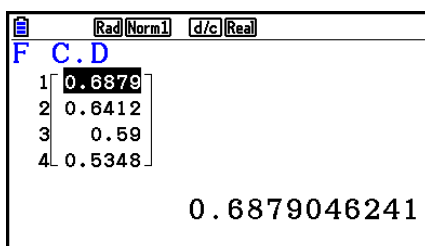

When a list is specified

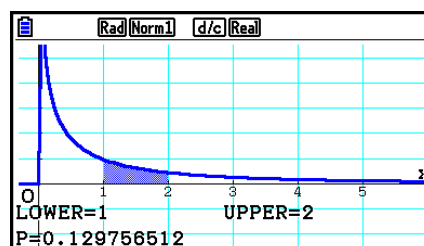

Graph when variable (x) is specified

- Graphing is supported only when a variable is specified and a single x -value is entered as data.

• Inverse F Cumulative Distribution

F5 (DIST) **F4** (F) **F3** (InvF)

Inverse F Cumulative Distribution calculates the lower bound value of an F cumulative distribution probability for specified $n:df$ and $d:df$ (degrees of freedom of numerator and denominator) values.

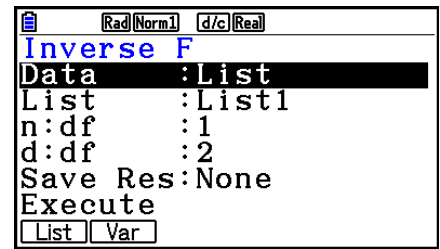

Calculation Result Output Examples

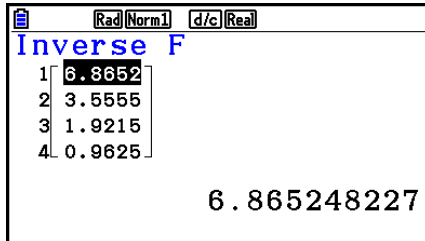

When a list is specified

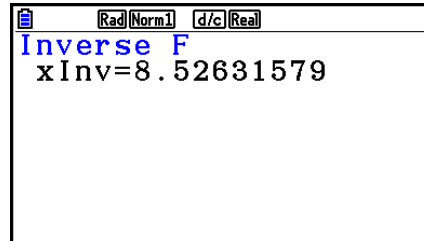

When variable (x) is specified

- There is no graphing for Inverse F Cumulative Distribution.

■ Binomial Distribution

• Binomial Probability

F5 (DIST) **F5** (BINOMIAL) **F1** (Bpd)

Binomial Probability calculates a probability at a specific single x -value or each list element for the discrete binomial distribution with the specified number of trials and probability of success on each trial. When a list is specified, calculation results for each list element are displayed in list form.

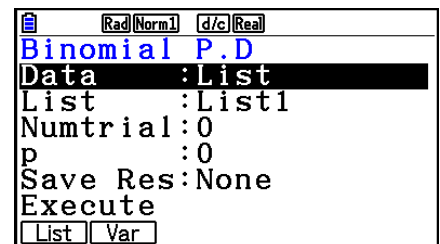

Calculation Result Output Examples

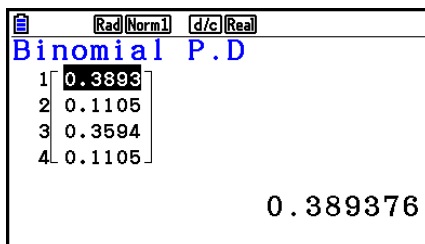

When a list is specified

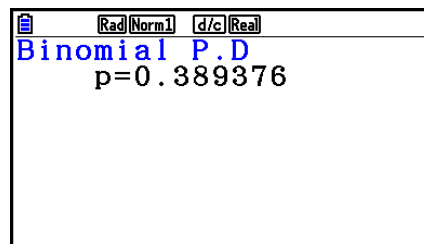

When variable (x) is specified

- There is no graphing for Binomial Probability.

• Binomial Cumulative Distribution

F5 (DIST) **F5** (BINOMIAL) **F2** (Bcd)

Binomial Cumulative Distribution determines the sum of probabilities (cumulative probability) that x , in the Binomial Probability $p(x)$, will fall within a range specified from a Lower value to an Upper value.

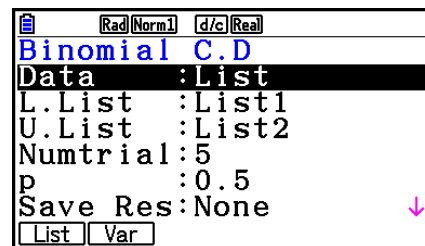

Calculation Result Output Examples

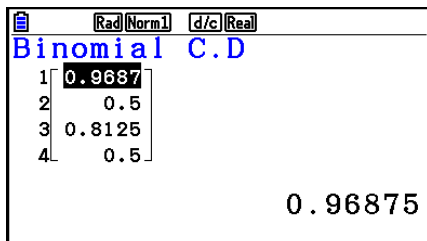

When a list is specified

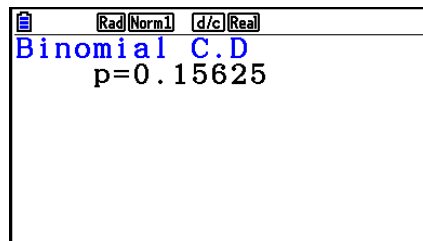

When variable (x) is specified

- There is no graphing for Binomial Cumulative Distribution.

• Inverse Binomial Cumulative Distribution

F5 (DIST) **F5** (BINOMIAL) **F3** (InvB)

Inverse Binomial Cumulative Distribution calculates the minimum number of trials of a binomial cumulative distribution for specified values.

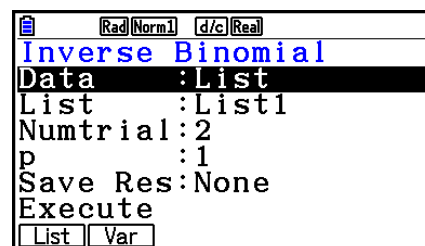

Calculation Result Output Examples

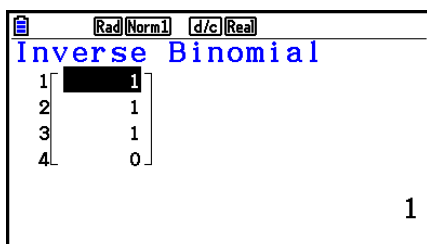

When a list is specified

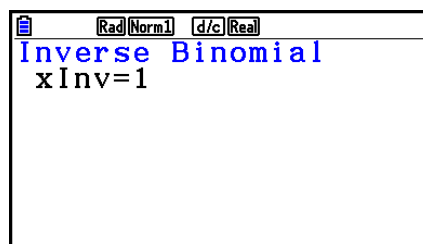

When variable (x) is specified

- There is no graphing for Inverse Binomial Cumulative Distribution.

Important!

When executing the Inverse Binomial Cumulative Distribution calculation, the calculator uses the specified Area value and the value that is one less than the Area value minimum number of significant digits (\ast Area value) to calculate minimum number of trials values.

The results are assigned to system variables $xInv$ (calculation result using Area) and $\ast xInv$ (calculation result using \ast Area). The calculator always displays the $xInv$ value only. However, when the $xInv$ and $\ast xInv$ values are different, the message shown below will appear with both values.

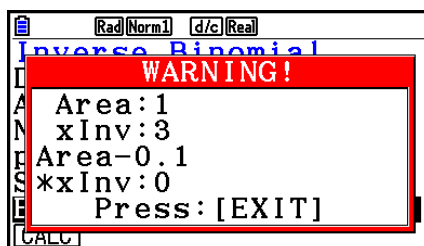

The calculation results of Inverse Binomial Cumulative Distribution are integers. Accuracy may be reduced when the Area value has 10 or more digits. Note that even a slight difference in calculation accuracy affects calculation results. If a warning message appears, check the displayed values.

■ Poisson Distribution

• Poisson Probability

[F5] (DIST) **[F6]** (\triangleright) **[F1]** (POISSON) **[F1]** (Ppd)

Poisson Probability calculates a probability at a specific single x -value or each list element for the discrete Poisson distribution with the specified mean.

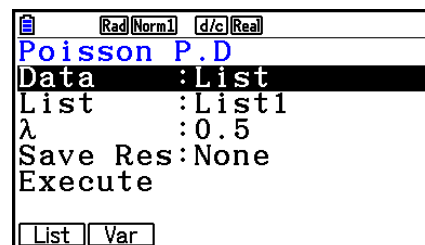

Calculation Result Output Examples

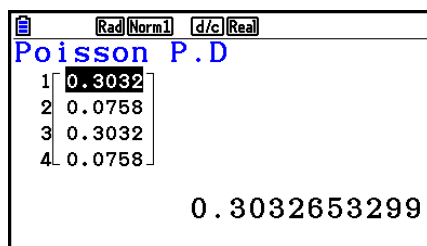

When a list is specified

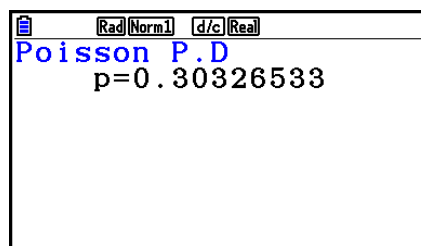

When variable (x) is specified

- There is no graphing for Poisson Probability.

• **Poisson Cumulative Distribution**

F5 (DIST) **F6** (\triangleright) **F1** (POISSON) **F2** (Pcd)

Poisson Cumulative Distribution determines the sum of probabilities (cumulative probability) that x , in the Poisson Probability $p(x)$, will fall within a range specified from a Lower value to an Upper value.

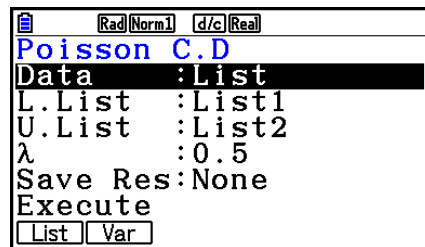

Calculation Result Output Examples

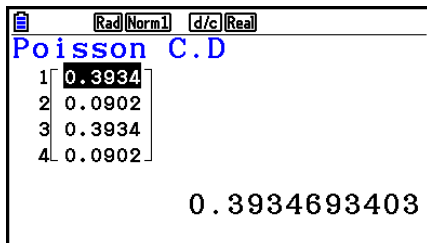

When a list is specified

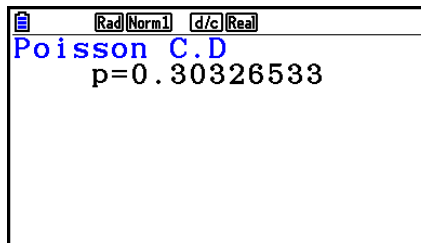

When variable (x) is specified

- There is no graphing for Poisson Cumulative Distribution.

• **Inverse Poisson Cumulative Distribution**

F5 (DIST) **F6** (\triangleright) **F1** (POISSON) **F3** (InvP)

Inverse Poisson Cumulative Distribution calculates the minimum number of trials of a Poisson cumulative probability distribution for specified values.

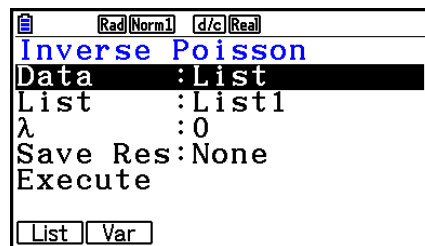

Calculation Result Output Examples

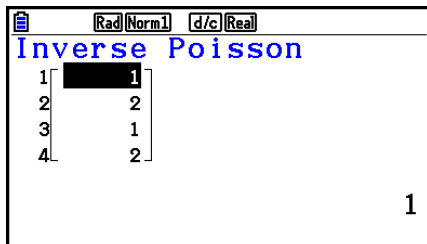

When a list is specified

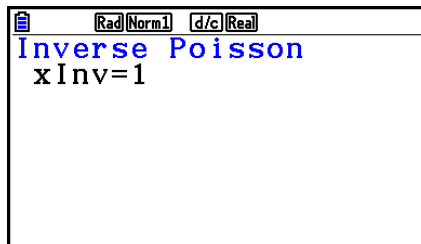

When variable (x) is specified

- There is no graphing for Inverse Poisson Cumulative Distribution.

Important!

When executing the Inverse Poisson Cumulative Distribution calculation, the calculator uses the specified Area value and the value that is one less than the Area value minimum number of significant digits (\ast Area value) to calculate minimum number of trials values.

The results are assigned to system variables $xInv$ (calculation result using Area) and $\ast xInv$ (calculation result using \ast Area). The calculator always displays the $xInv$ value only. However, when the $xInv$ and $\ast xInv$ values are different, the message will appear with both values.

The calculation results of Inverse Poisson Cumulative Distribution are integers. Accuracy may be reduced when the Area value has 10 or more digits. Note that even a slight difference in calculation accuracy affects calculation results. If a warning message appears, check the displayed values.

■ Geometric Distribution

• Geometric Probability

F5(DIST) **F6**(▷) **F2**(GEO) **F1**(Gpd)

Geometric Probability calculates the probability at a specific single x -value or each list element, and the number of the trial on which the first success occurs, for the geometric distribution with a specified probability of success.

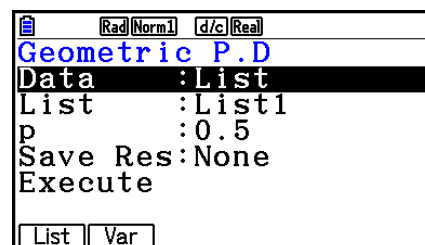

Calculation Result Output Examples

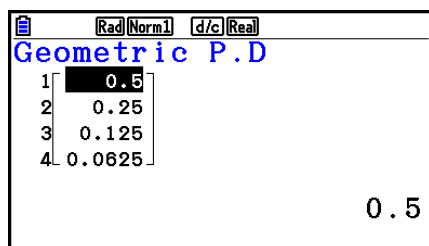

When a list is specified

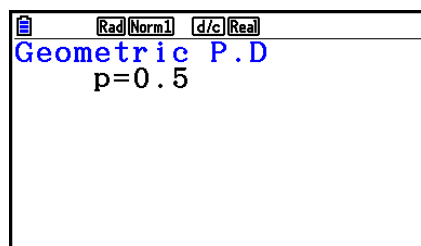

When variable (x) is specified

- There is no graphing for Geometric Probability.

• **Geometric Cumulative Distribution**

F5 (DIST) **F6** (▷) **F2** (GEO) **F2** (Gcd)

Geometric Cumulative Distribution determines the sum of probabilities (cumulative probability) that x , in the Geometric Probability $p(x)$, will fall within a range specified from a Lower value to an Upper value.

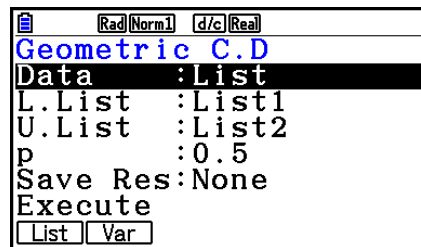

Calculation Result Output Examples

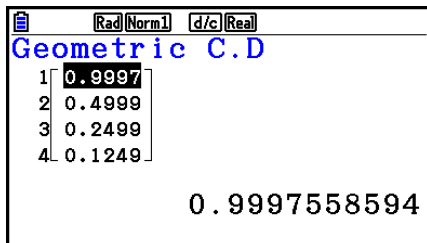

When a list is specified

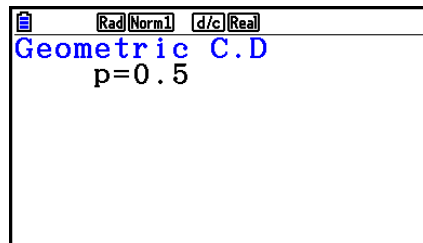

When variable (x) is specified

- There is no graphing for Geometric Cumulative Distribution.

• **Inverse Geometric Cumulative Distribution**

F5 (DIST) **F6** (▷) **F2** (GEO) **F3** (InvG)

Inverse Geometric Cumulative Distribution calculates the minimum number of trials of a geometric cumulative probability distribution for specified values.

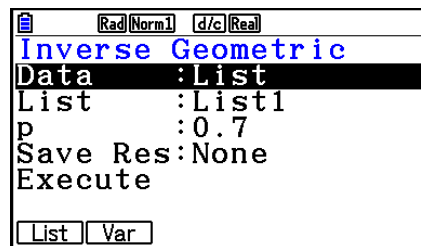

Calculation Result Output Examples

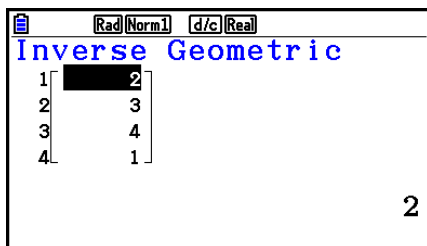

When a list is specified

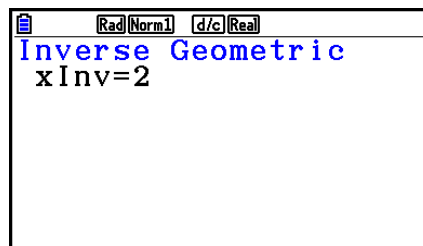

When variable (x) is specified

- There is no graphing for Inverse Geometric Cumulative Distribution.

Important!

When executing the Inverse Geometric Cumulative Distribution calculation, the calculator uses the specified Area value and the value that is one less than the Area value minimum number of significant digits (\ast Area value) to calculate minimum number of trials values.

The results are assigned to system variables $xInv$ (calculation result using Area) and $\ast xInv$ (calculation result using \ast Area). The calculator always displays the $xInv$ value only. However, when the $xInv$ and $\ast xInv$ values are different, the message will appear with both values.

The calculation results of Inverse Geometric Cumulative Distribution are integers. Accuracy may be reduced when the Area value has 10 or more digits. Note that even a slight difference in calculation accuracy affects calculation results. If a warning message appears, check the displayed values.

Hypergeometric Distribution

Hypergeometric Probability

F5 (DIST) **F6** (\triangleright) **F3** (HYPRGEO) **F1** (Hpd)

Hypergeometric Probability calculates the probability at a specific single x -value or each list element, and the number of the trial on which the first success occurs, for the hypergeometric distribution with a specified probability of success.

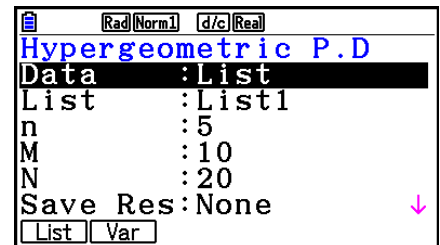

Calculation Result Output Examples

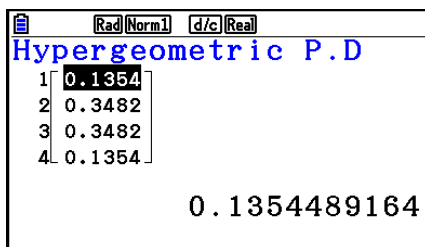

When a list is specified

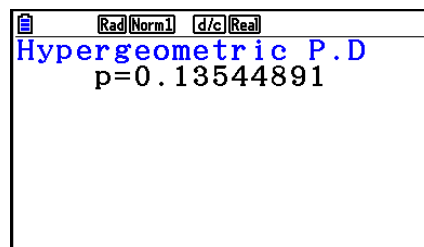

When variable (x) is specified

- There is no graphing for Hypergeometric Probability.

Hypergeometric Cumulative Distribution

F5 (DIST) **F6** (\triangleright) **F3** (HYPRGEO) **F2** (Hcd)

Hypergeometric Cumulative Distribution determines the sum of probabilities (cumulative probability) that x , in the Hypergeometric Probability $p(x)$, will fall within a range specified from a Lower value to an Upper value.

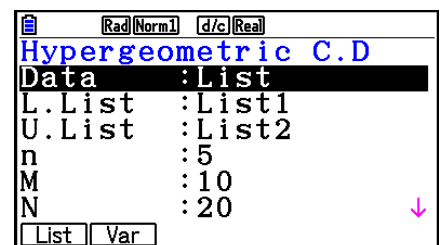

Calculation Result Output Examples

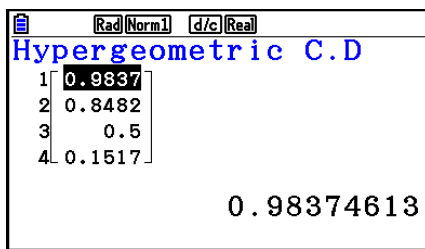

When a list is specified

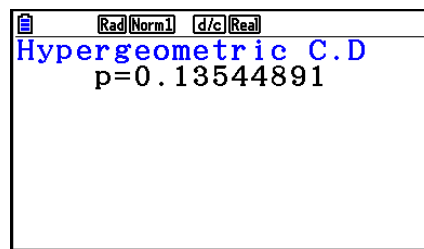

When variable (x) is specified

- There is no graphing for Hypergeometric Cumulative Distribution.

• Inverse Hypergeometric Cumulative Distribution

F5(DIST) **F6**(▷) **F3**(HYPRGEO) **F3**(InvH)

Inverse Hypergeometric Cumulative Distribution calculates the minimum number of trials of a hypergeometric cumulative probability distribution for specified values.

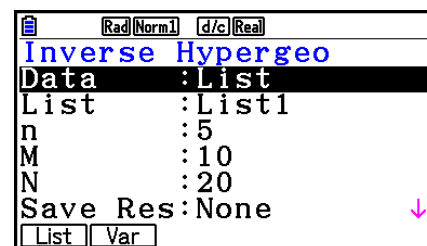

Calculation Result Output Examples

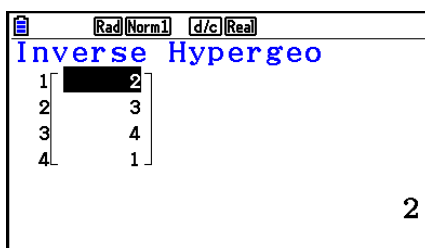

When a list is specified

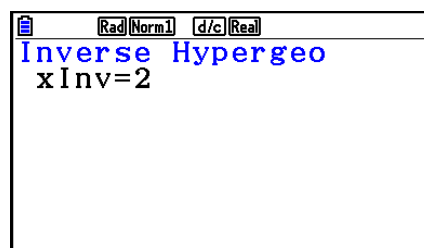

When variable (x) is specified

- There is no graphing for Inverse Hypergeometric Cumulative Distribution.

Important!

When executing the Inverse Hypergeometric Cumulative Distribution calculation, the calculator uses the specified Area value and the value that is one less than the Area value minimum number of significant digits (\ast Area value) to calculate minimum number of trials values.

The results are assigned to system variables $xInv$ (calculation result using Area) and $\ast xInv$ (calculation result using \ast Area). The calculator always displays the $xInv$ value only. However, when the $xInv$ and $\ast xInv$ values are different, the message will appear with both values.

The calculation results of Inverse Hypergeometric Cumulative Distribution are integers.

Accuracy may be reduced when the Area value has 10 or more digits. Note that even a slight difference in calculation accuracy affects calculation results. If a warning message appears, check the displayed values.

8. Input and Output Terms of Tests, Confidence Interval, and Distribution

The following explains the input and output terms that are used by tests, confidence interval, and distribution.

■ Input Terms

Data	data type
μ (1-Sample Z Test).....	population mean value test conditions (" $\neq \mu_0$ " specifies two-tail test, " $< \mu_0$ " specifies lower one-tail test, " $> \mu_0$ " specifies upper one-tail test.)
μ_1 (2-Sample Z Test)	population mean value test conditions (" $\neq \mu_2$ " specifies two-tail test, " $< \mu_2$ " specifies one-tail test where sample 1 is smaller than sample 2, " $> \mu_2$ " specifies one-tail test where sample 1 is greater than sample 2.)
Prop (1-Prop Z Test).....	sample proportion test conditions (" $\neq p_0$ " specifies two-tail test, " $< p_0$ " specifies lower one-tail test, " $> p_0$ " specifies upper one-tail test.)
p_1 (2-Prop Z Test)	sample proportion test conditions (" $\neq p_2$ " specifies two-tail test, " $< p_2$ " specifies one-tail test where sample 1 is smaller than sample 2, " $> p_2$ " specifies one-tail test where sample 1 is greater than sample 2.)
μ (1-Sample t Test).....	population mean value test conditions (" $\neq \mu_0$ " specifies two-tail test, " $< \mu_0$ " specifies lower one-tail test, " $> \mu_0$ " specifies upper one-tail test.)
μ_1 (2-Sample t Test)	sample mean value test conditions (" $\neq \mu_2$ " specifies two-tail test, " $< \mu_2$ " specifies one-tail test where sample 1 is smaller than sample 2, " $> \mu_2$ " specifies one-tail test where sample 1 is greater than sample 2.)
β & ρ (LinearReg t Test)	ρ -value test conditions (" $\neq 0$ " specifies two-tail test, " < 0 " specifies lower one-tail test, " > 0 " specifies upper one-tail test.)
σ_1 (2-Sample F Test)	population standard deviation test conditions (" $\neq \sigma_2$ " specifies two-tail test, " $< \sigma_2$ " specifies one-tail test where sample 1 is smaller than sample 2, " $> \sigma_2$ " specifies one-tail test where sample 1 is greater than sample 2.)
μ_0	assumed population mean
σ	population standard deviation ($\sigma > 0$)
σ_1	population standard deviation of sample 1 ($\sigma_1 > 0$)
σ_2	population standard deviation of sample 2 ($\sigma_2 > 0$)
List	list whose contents you want to use as data (List 1 to 26)
List1	list whose contents you want to use as sample 1 data (List 1 to 26)
List2.....	list whose contents you want to use as sample 2 data (List 1 to 26)

Freq.....frequency (1 or List 1 to 26)
 Freq1.....frequency of sample 1 (1 or List 1 to 26)
 Freq2.....frequency of sample 2 (1 or List 1 to 26)
 Execute.....executes a calculation or draws a graph
 \bar{x}mean of sample
 \bar{x}_1mean of sample 1
 \bar{x}_2mean of sample 2
 nsize of sample (positive integer)
 n_1size of sample 1 (positive integer)
 n_2size of sample 2 (positive integer)
 p_0expected sample proportion ($0 < p_0 < 1$)
 p_1sample proportion test conditions
 x (1-Prop Z Test).....sample value ($x \geq 0$ integer)
 x (1-Prop Z Interval).....data (0 or positive integer)
 x_1data value of sample 1 ($x_1 \geq 0$ integer)
 x_2data value of sample 2 ($x_2 \geq 0$ integer)
 s_xsample standard deviation ($s_x > 0$)
 s_{x1}standard deviation of sample 1 ($s_{x1} > 0$)
 s_{x2}standard deviation of sample 2 ($s_{x2} > 0$)
 XList.....list for x -axis data (List 1 to 26)
 YList.....list for y -axis data (List 1 to 26)
 C-Level.....confidence level ($0 \leq \text{C-Level} < 1$)
 Pooled.....pooling On (in effect) or Off (not in effect)
 x (Distribution).....data
 σ (Distribution).....standard deviation ($\sigma > 0$)
 μ (Distribution).....mean
 λ (Distribution).....mean
 Lower (Distribution).....lower boundary
 Upper (Distribution).....upper boundary
 L.List (Distribution).....list for lower bound data (List 1 to 26)
 U.List (Distribution).....list for upper bound data (List 1 to 26)
 df (Distribution).....degrees of freedom ($df > 0$)
 $n:df$ (Distribution).....numerator degrees of freedom (positive integer)
 $d:df$ (Distribution).....denominator degrees of freedom (positive integer)
 Numtrial (Distribution).....number of trials
 p (Distribution).....success probability ($0 \leq p \leq 1$)

■ Output Terms

z	z score
p	p -value
t	t score
χ^2	χ^2 value
F	F value
\hat{p}	estimated sample proportion
\hat{p}_1	estimated proportion of sample 1
\hat{p}_2	estimated proportion of sample 2
\bar{x}	mean of sample
\bar{x}_1	mean of sample 1
\bar{x}_2	mean of sample 2
s_x	sample standard deviation
s_{x1}	standard deviation of sample 1
s_{x2}	standard deviation of sample 2
s_p	pooled sample standard deviation
n	size of sample
n_1	size of sample 1
n_2	size of sample 2
df	degrees of freedom
a	constant term
b	coefficient
s_e	standard error
r	correlation coefficient
r^2	coefficient of determination
Lower	confidence interval lower limit
Upper	confidence interval upper limit

9. Statistic Formula

■ Test

Test	
1-Sample Z Test	$z = (\bar{x} - \mu_0)/(\sigma/\sqrt{n})$
2-Sample Z Test	$z = (\bar{x}_1 - \bar{x}_2)/\sqrt{(\sigma_1^2/n_1) + (\sigma_2^2/n_2)}$
1-Prop Z Test	$z = (x/n - p_0)/\sqrt{p_0(1 - p_0)/n}$
2-Prop Z Test	$z = (x_1/n_1 - x_2/n_2)/\sqrt{\hat{p}(1 - \hat{p})(1/n_1 + 1/n_2)}$
1-Sample t Test	$t = (\bar{x} - \mu_0)/(s_x/\sqrt{n})$
2-Sample t Test (pooled)	$t = (\bar{x}_1 - \bar{x}_2)/\sqrt{s_p^2(1/n_1 + 1/n_2)}$ $s_p = \sqrt{((n_1 - 1)s_{x_1}^2 + (n_2 - 1)s_{x_2}^2)/(n_1 + n_2 - 2)}$ $df = n_1 + n_2 - 2$
2-Sample t Test (not pooled)	$t = (\bar{x}_1 - \bar{x}_2)/\sqrt{s_{x_1}^2/n_1 + s_{x_2}^2/n_2}$ $df = 1/(C^2/(n_1 - 1) + (1 - C)^2/(n_2 - 1))$ $C = (s_{x_1}^2/n_1)/(s_{x_1}^2/n_1 + s_{x_2}^2/n_2)$
LinearReg t Test	$b = \frac{\sum_{i=1}^n (x_i - \bar{x})(y_i - \bar{y})}{\sum_{i=1}^n (x_i - \bar{x})^2} \quad a = \bar{y} - b\bar{x}$ $t = r\sqrt{(n - 2)/(1 - r^2)}$
χ^2 GOF Test	$\chi^2 = \sum_i^k (O_i - E_i)^2/E_i$ <p>O_i: The i-th element of the observed list E_i: The i-th element of the expected list</p>
χ^2 two-way Test	$\chi^2 = \sum_i^k \sum_j^\ell (O_{ij} - E_{ij})^2/E_{ij}$ <p>O_{ij}: The element at row i, column j of the observed matrix E_{ij}: The element at row i, column j of the expected matrix</p> $E_{ij} = \frac{\sum_{i=1}^k O_{ij} \cdot \sum_{j=1}^\ell O_{ij}}{\sum_{i=1}^k \sum_{j=1}^\ell O_{ij}}$
2-Sample F Test	$F = s_{x_1}^2/s_{x_2}^2$
ANOVA Test	$F = MS/MSe \quad MS = SS/Fdf \quad MSe = SSE/Edf$ $SS = \sum_{i=1}^k n_i (\bar{x}_i - \bar{x})^2 \quad SSE = \sum_{i=1}^k (n_i - 1)s_{xi}^2$ $Fdf = k - 1 \quad Edf = \sum_{i=1}^k (n_i - 1)$

■ Confidence Interval

Confidence Interval	<i>Lower</i> : confidence interval lower limit <i>Upper</i> : confidence interval upper limit
1-Sample <i>Z</i> Interval	$Lower, Upper = \bar{x} \mp Z(\alpha/2) \cdot \sigma/\sqrt{n}$
2-Sample <i>Z</i> Interval	$Lower, Upper = (\bar{x}_1 - \bar{x}_2) \mp Z(\alpha/2) \sqrt{\sigma_1^2/n_1 + \sigma_2^2/n_2}$
1-Prop <i>Z</i> Interval	$Lower, Upper = x/n \mp Z(\alpha/2) \sqrt{1/n \cdot (x/n \cdot (1 - x/n))}$
2-Prop <i>Z</i> Interval	$Lower, Upper = (x_1/n_1 - x_2/n_2) \mp Z(\alpha/2) \sqrt{(x_1/n_1 \cdot (1 - x_1/n_1))/n_1 + (x_2/n_2 \cdot (1 - x_2/n_2))/n_2}$
1-Sample <i>t</i> Interval	$Lower, Upper = \bar{x} \mp t_{n-1}(\alpha/2) \cdot s_x/\sqrt{n}$
2-Sample <i>t</i> Interval (pooled)	$Lower, Upper = (\bar{x}_1 - \bar{x}_2) \mp t_{n_1+n_2-2}(\alpha/2) \sqrt{s_p^2(1/n_1 + 1/n_2)}$ $s_p = \sqrt{((n_1 - 1)s_{x_1}^2 + (n_2 - 1)s_{x_2}^2)/(n_1 + n_2 - 2)}$
2-Sample <i>t</i> Interval (not pooled)	$Lower, Upper = (\bar{x}_1 - \bar{x}_2) \mp t_{df}(\alpha/2) \sqrt{s_{x_1}^2/n_1 + s_{x_2}^2/n_2}$ $df = 1/(C^2/(n_1 - 1) + (1 - C)^2/(n_2 - 1))$ $C = (s_{x_1}^2/n_1)/(s_{x_1}^2/n_1 + s_{x_2}^2/n_2)$

α : level of significance $\alpha = 1 - [\text{C-Level}]$ C-Level: confidence level ($0 \leq \text{C-Level} < 1$)

$Z(\alpha/2)$: upper $\alpha/2$ point of standard normal distribution

$t_{df}(\alpha/2)$: upper $\alpha/2$ point of *t* distribution with *df* degrees of freedom

■ Distribution (Continuous)

Distribution	Probability Density	Cumulative Distribution	
Normal Distribution	$p(x) = \frac{1}{\sqrt{2\pi}\sigma} e^{-\frac{(x-\mu)^2}{2\sigma^2}} \quad (\sigma > 0)$	$p = \int_{Lower}^{Upper} p(x)dx$	
Student- <i>t</i> Distribution	$p(x) = \frac{\Gamma\left(\frac{df+1}{2}\right)}{\Gamma\left(\frac{df}{2}\right)} \times \frac{\left(1 + \frac{x^2}{df}\right)^{-\frac{df+1}{2}}}{\sqrt{\pi \times df}}$		
χ^2 Distribution	$p(x) = \frac{1}{\Gamma\left(\frac{df}{2}\right)} \times \left(\frac{1}{2}\right)^{\frac{df}{2}} \times x^{\left(\frac{df}{2}-1\right)} \times e^{-\frac{x}{2}} \quad (x \geq 0)$		
<i>F</i> Distribution	$p(x) = \frac{\Gamma\left(\frac{ndf+ddf}{2}\right)}{\Gamma\left(\frac{ndf}{2}\right) \times \Gamma\left(\frac{ddf}{2}\right)} \left(\frac{ndf}{ddf}\right)^{\frac{ndf}{2}} x^{\frac{ndf}{2}-1} \left(1 + \frac{ndf \times x}{ddf}\right)^{-\frac{ndf+ddf}{2}} \quad (x \geq 0)$		
Distribution	Inverse Cumulative Distribution		
Normal Distribution	$p = \int_{-\infty}^{Upper} p(x)dx$ tail = Left	$p = \int_{Lower}^{\infty} p(x)dx$ tail = Right	$p = \int_{Lower}^{Upper} p(x)dx$ tail = Central
Student- <i>t</i> Distribution	$p = \int_{Lower}^{\infty} p(x)dx$		
χ^2 Distribution			
<i>F</i> Distribution			

■ Distribution (Discrete)

Distribution	Probability	
Binomial Distribution	$p(x) = {}_n C_x p^x (1-p)^{n-x}$ ($x = 0, 1, \dots, n$) n : number of trials	
Poisson Distribution	$p(x) = \frac{e^{-\lambda} \times \lambda^x}{x!}$ ($x = 0, 1, 2, \dots$) λ : mean ($\lambda > 0$)	
Geometric Distribution	$p(x) = p(1-p)^{x-1}$ ($x = 1, 2, 3, \dots$)	
Hypergeometric Distribution	$p(x) = \frac{{}^M C_x \times {}^{N-M} C_{n-x}}{{}^N C_n}$ <p> n: Number of elements extracted from population ($0 \leq x$ integer) M: Number of elements contained in attribute A ($0 \leq M$ integer) N: Number of population elements ($n \leq N, M \leq N$ integer) </p>	
Distribution	Cumulative Distribution	Inverse Cumulative Distribution
Binomial Distribution	$p = \sum_{x=Lower}^{Upper} p(x)$	$p \leq \sum_{x=0}^X p(x)$
Poisson Distribution		
Geometric Distribution	$p = \sum_{x=Lower}^{Upper} p(x)$	$p \leq \sum_{x=1}^X p(x)$
Hypergeometric Distribution	$p = \sum_{x=Lower}^{Upper} p(x)$	$p \leq \sum_{x=0}^X p(x)$

Chapter 7 Financial Calculation

Important!

- Calculation results and graphs produced in this mode should be regarded as reference values only.
- Whenever performing an actual financial transaction, be sure to check any calculation results obtained using this calculator with against the figures calculated by your financial institution.
- Whether you should use a positive or a negative value for the present value (PV) or the purchase price (PRC) depends on the type of calculation you are trying to perform.

1. Before Performing Financial Calculations

From the Main Menu, enter the **Financial** mode and display the Financial screen like the one shown below.

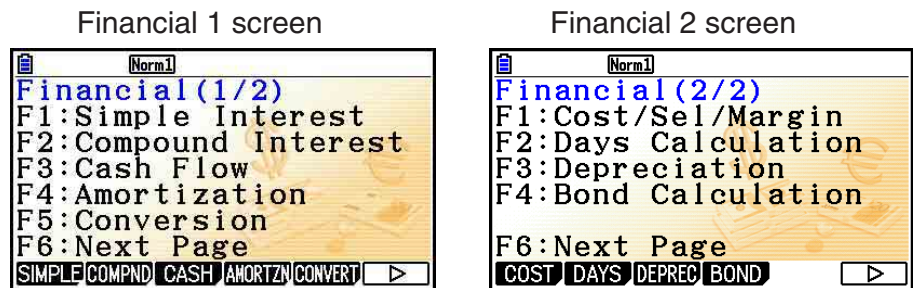

- {**SIMPLE**} ... {simple interest}
- {**COMPND**} ... {compound interest}
- {**CASH**} ... {cash flow (investment appraisal)}
- {**AMORTZN**} ... {amortization}
- {**CONVERT**} ... {interest rate conversion}
- {**COST**} ... {cost, selling price, margin}
- {**DAYS**} ... {day/date calculations}
- {**DEPREC**} ... {depreciation calculations}
- {**BOND**} ... {bond calculations}

■ Setup Items

~~~~ indicates default setting.

- **Payment**

- {**BEGIN**}/**END** ... Specifies {beginning of the period}/**end of the period** payment

- **Date Mode**

- **365**/**360** ... Specifies calculation according to a {365-day}/**360-day** year

- **Periods/YR. (payment interval specification)**

- **Annual**/**Semi** ... {annual}/**semiannual**

- **Graph Color**

- **Black**/**Blue**/**Red**/**Magenta**/**Green**/**Cyan**/**Yellow** ... Specifies a single border line color.

---

## ■ Graphing in the Financial Mode

After performing a financial calculation, you can use **F6** (GRAPH) to graph the results as shown below.

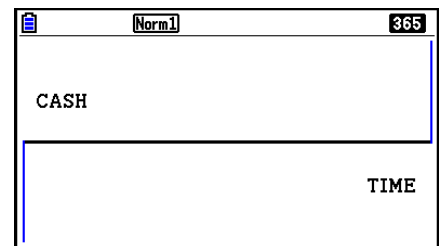

- Pressing **SHIFT** **F1** (TRACE) while a graph is on the display activates Trace, which can be used to look up other financial values. In the case of simple interest, for example, pressing **▶** displays *PV*, *SI*, and *SFV*. Pressing **◀** displays the same values in reverse sequence.
- While the graph screen is displayed, you can press **SHIFT** **F5** (FORMAT) and then use the dialog box that appears to change the graph color. The color specification you make on this dialog box is also reflected by the “Graph Color” setting of the Setup screen.
- Zoom, Scroll, and Sketch cannot be used in the **Financial** mode.
- The following graph Setup screen settings are all turned off for graphing in the **Financial** mode: Axes, Grid, Dual Screen.
- Drawing a financial graph while the Label item is turned on, displays the label CASH for the vertical axis (deposits, withdrawals), and TIME for the horizontal axis (frequency).
- You can use the Setup “Background” setting to display a **Financial** mode graph screen background image. This operation is the same as that for the **Graph** mode. For details, see “Displaying a Graph Background Image” (page 5-10). Note, however, that you cannot perform V-Window related operations while in the **Financial** mode.
- While a background image is being displayed on the **Financial** mode graph screen, you can adjust the lightness of the background image. For information about this operation, see “To adjust the lightness (Fade I/O) of the background image” (page 5-12).

## 2. Simple Interest

This calculator uses the following formulas to calculate simple interest.

### • Formula

|              |                                                                                   |                                  |
|--------------|-----------------------------------------------------------------------------------|----------------------------------|
| 365-day Mode | $SI' = \frac{n}{365} \times PV \times i \quad \left( i = \frac{I\%}{100} \right)$ | $SI$ : interest                  |
| 360-day Mode | $SI' = \frac{n}{360} \times PV \times i \quad \left( i = \frac{I\%}{100} \right)$ | $n$ : number of interest periods |
|              |                                                                                   | $PV$ : principal                 |
|              |                                                                                   | $I\%$ : annual interest          |
|              | $SI = -SI'$                                                                       | $SFV$ : principal plus interest  |
|              | $SFV = -(PV + SI')$                                                               |                                  |

Press **[F1]** (SIMPLE) from the Financial 1 screen to display the following input screen for simple interest.

**[F1]** (SIMPLE)

$n$  ..... number of interest periods (days)  
 $I\%$  ..... annual interest rate  
 $PV$  ..... principal

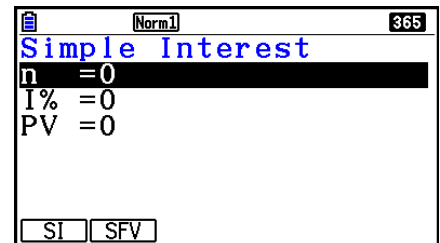

After configuring the parameters, use one of the function menus noted below to perform the corresponding calculation.

- **{SI}** ... {simple interest}
- **{SFV}** ... {simple future value}

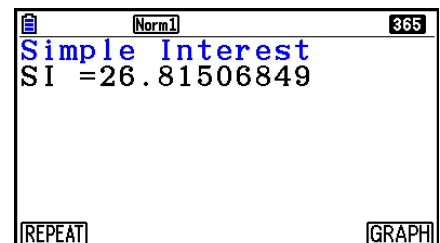

- An error occurs if parameters are not configured correctly.

Use the following function menus to maneuver between calculation result screens.

- **{REPEAT}** ... {parameter input screen}
- **{GRAPH}** ... {draws graph}

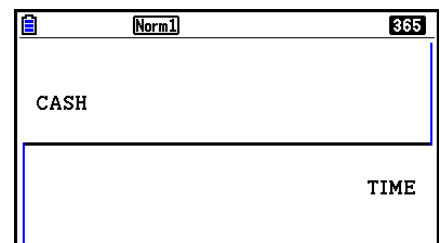

After drawing a graph, you can press  $\boxed{\text{SHIFT}} \boxed{\text{F1}}$  (TRACE) to turn on trace and read calculation results along the graph.

Each press of  $\blacktriangleright$  while trace is turned on cycles the displayed value in the sequence: present value ( $PV$ )  $\rightarrow$  simple interest ( $SI$ )  $\rightarrow$  simple future value ( $SFV$ ). Pressing  $\blacktriangleleft$  cycles in the reverse direction.

Press  $\boxed{\text{EXIT}}$  to return to the parameter input screen.

### 3. Compound Interest

This calculator uses the following standard formulas to calculate compound interest.

• **PV, PMT, FV, n**

$I\% \neq 0$

$$PV = -(\alpha \times PMT + \beta \times FV)$$

$$PMT = -\frac{PV + \beta \times FV}{\alpha}$$

$$FV = -\frac{PV + \alpha \times PMT}{\beta}$$

$$n = \frac{\log \left\{ \frac{(1+iS) \times PMT - FV \times i}{(1+iS) \times PMT + PV \times i} \right\}}{\log(1+i)}$$

$I\% = 0$

$$PV = -(PMT \times n + FV)$$

$$PMT = -\frac{PV + FV}{n}$$

$$FV = -(PMT \times n + PV)$$

$$n = -\frac{PV + FV}{PMT}$$

$$\alpha = (1+i \times S) \times \frac{1-\beta}{i}, \beta = (1+i)^{-n}$$

$$S = \begin{cases} 0 & \dots\dots\dots \text{Payment : End} \\ & \text{(Setup Screen)} \\ 1 & \dots\dots\dots \text{Payment : Begin} \\ & \text{(Setup Screen)} \end{cases}$$

$$i = \begin{cases} \frac{I\%}{100} & \dots\dots\dots (P/Y = C/Y = 1) \\ \left(1 + \frac{I\%}{100 \times [C/Y]}\right)^{\frac{C/Y}{P/Y}} - 1 & \dots\dots \text{(Other than those above)} \end{cases}$$

• **I %**

*i* (effective interest rate)

*i* (effective interest rate) is calculated using Newton's Method.

$$PV + \alpha \times PMT + \beta \times FV = 0$$

To I % from *i* (effective interest rate)

$$I\% = \begin{cases} i \times 100 & \dots\dots\dots (P/Y = C/Y = 1) \\ \left\{ \left(1 + i\right)^{\frac{P/Y}{C/Y}} - 1 \right\} \times C/Y \times 100\dots & \text{(Other than those above)} \end{cases}$$

*n* ..... number of compound periods

*FV* ..... future value

*I*% ..... annual interest rate

*P/Y* ..... installment periods per year

*PV* ..... present value

*C/Y* ..... compounding periods per year

*PMT* ..... payment

- A deposit is indicated by a plus sign (+), while a withdrawal is indicated by a minus sign (-).

Press **F2** (COMPND) from the Financial 1 screen to display the following input screen for compound interest.

**F2** (COMPND)

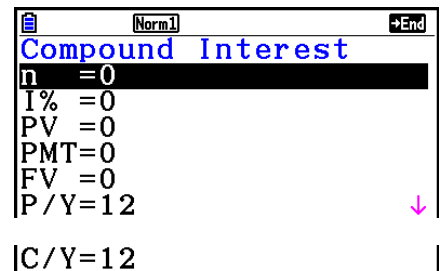

*n* ..... number of compound periods

*I*% ..... annual interest rate

*PV* ..... present value (loan amount in case of loan; principal in case of savings)

*PMT* ..... payment for each installment (payment in case of loan; deposit in case of savings)

*FV* ..... future value (unpaid balance in case of loan; principal plus interest in case of savings)

*P/Y* ..... installment periods per year

*C/Y* ..... compounding periods per year

## Important!

### Inputting Values

A period ( $n$ ) is expressed as a positive value. Either the present value ( $PV$ ) or future value ( $FV$ ) is positive, while the other ( $PV$  or  $FV$ ) is negative.

### Precision

This calculator performs interest calculations using Newton's Method, which produces approximate values whose precision can be affected by various calculation conditions. Because of this, interest calculation results produced by this calculator should be used keeping the above limitation in mind or the results should be verified.

After configuring the parameters, use one of the function menus noted below to perform the corresponding calculation.

- {**n**} ... {number of compound periods}
- {**I%**} ... {annual interest rate}
- {**PV**} ... {present value} (Loan: loan amount; Savings: principal)
- {**PMT**} ... {payment} (Loan: payment; Savings: deposit)
- {**FV**} ... {future value} (Loan: unpaid balance; Savings: principal plus interest)
- {**AMORTZN**} ... {amortization screen}

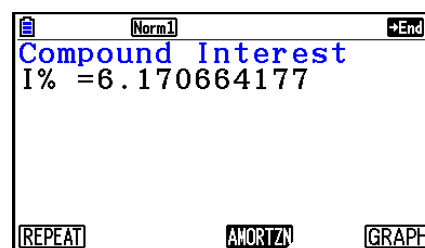

- An error occurs if parameters are not configured correctly.

Use the following function menus to maneuver between calculation result screens.

- {**REPEAT**} ... {parameter input screen}
- {**AMORTZN**} ... {amortization screen}
- {**GRAPH**} ... {draws graph}

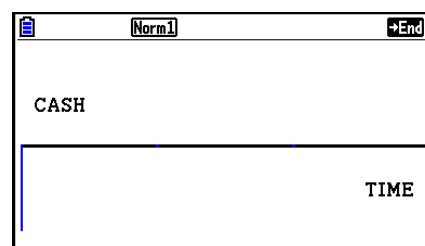

After drawing a graph, you can press **SHIFT** **F1** (TRACE) to turn on trace and read calculation results along the graph.

Press **EXIT** to return to the parameter input screen.



## 4. Cash Flow (Investment Appraisal)

This calculator uses the discounted cash flow (DCF) method to perform investment appraisal by totalling cash flow for a fixed period. This calculator can perform the following four types of investment appraisal.

- Net present value (*NPV*)
- Net future value (*NFV*)
- Internal rate of return (*IRR*)
- Payback period (*PBP*)

A cash flow diagram like the one shown below helps to visualize the movement of funds.

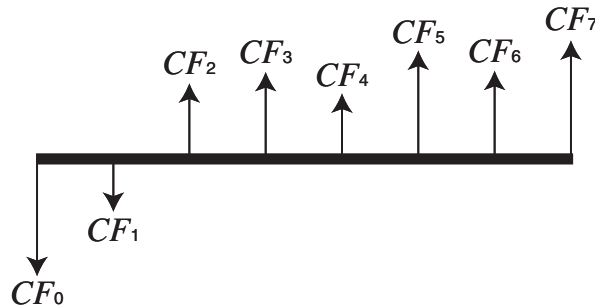

With this graph, the initial investment amount is represented by  $CF_0$ . The cash flow one year later is shown by  $CF_1$ , two years later by  $CF_2$ , and so on.

Investment appraisal can be used to clearly determine whether an investment is realizing profits that were originally targeted.

- ***NPV***

$$NPV = CF_0 + \frac{CF_1}{(1+i)} + \frac{CF_2}{(1+i)^2} + \frac{CF_3}{(1+i)^3} + \dots + \frac{CF_n}{(1+i)^n} \quad \left( i = \frac{I\%}{100} \right)$$

*n*: natural number up to 254

- ***NFV***

$$NFV = NPV \times (1+i)^n$$

- ***IRR***

$$0 = CF_0 + \frac{CF_1}{(1+i)} + \frac{CF_2}{(1+i)^2} + \frac{CF_3}{(1+i)^3} + \dots + \frac{CF_n}{(1+i)^n}$$

In this formula,  $NPV = 0$ , and the value of *IRR* is equivalent to  $i \times 100$ . It should be noted, however, that minute fractional values tend to accumulate during the subsequent calculations performed automatically by the calculator, so *NPV* never actually reaches exactly zero. *IRR* becomes more accurate the closer that *NPV* approaches to zero.

• **PBP**

$$PBP = \begin{cases} 0 & \dots\dots\dots (CF_0 \geq 0) \\ n - \frac{NPV_n}{NPV_{n+1} - NPV_n} & \dots \text{(Other than those above)} \end{cases} \quad NPV_n = \sum_{k=0}^n \frac{CF_k}{(1+i)^k}$$

*n*: smallest positive integer that satisfies the conditions  $NPV_n \leq 0$ ,  $NPV_{n+1} \geq 0$ , or 0

Press **F3** (CASH) from the Financial 1 screen to display the following input screen for Cash Flow.

**F3** (CASH)

I% ..... interest rate

Csh ..... list to be used for cash flow data

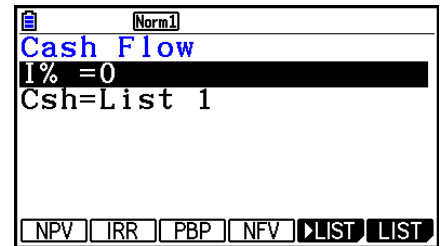

If you have not yet input data into a list, press **F5** (►LIST) and input data into a list.

After configuring the parameters, use one of the function menus noted below to perform the corresponding calculation.

- {**NPV**} ... {net present value}
- {**IRR**} ... {internal rate of return}
- {**PBP**} ... {payback period}
- {**NFV**} ... {net future value}
- {**►LIST**} ... {inputs data into a list}
- {**LIST**} ... {specifies a list}

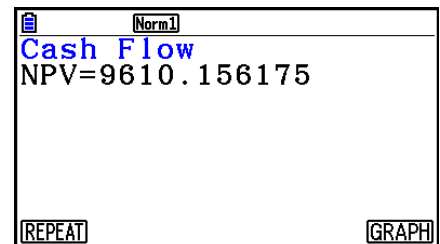

• An error occurs if parameters are not configured correctly.

Use the following function menus to maneuver between calculation result screens.

- {**REPEAT**} ... {parameter input screen}
- {**GRAPH**} ... {draws graph}

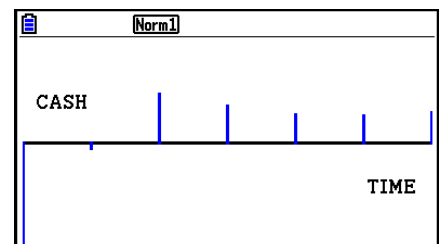

After drawing a graph, you can press **SHIFT F1** (TRACE) to turn on trace and read calculation results along the graph.

Press **EXIT** to return to the parameter input screen.

# 5. Amortization

This calculator can be used to calculate the principal and interest portion of a monthly installment, the remaining principal, and amount of principal and interest repaid up to any point.

• **Formula**

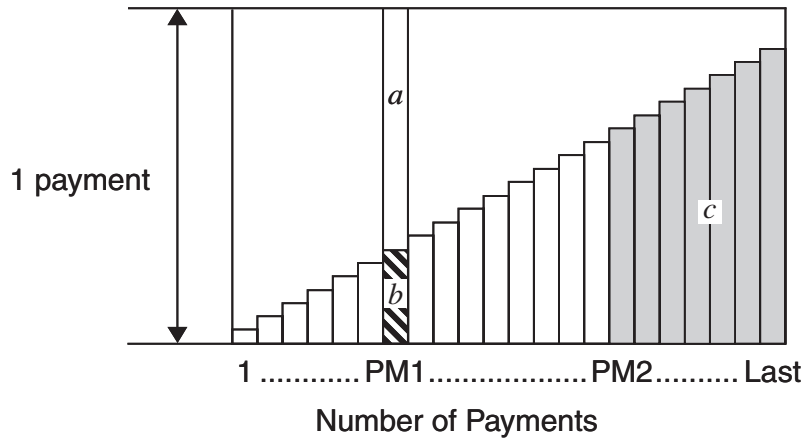

- a*: interest portion of installment PM1 (*INT*)
- b*: principal portion of installment PM1 (*PRN*)
- c*: balance of principal after installment PM2 (*BAL*)

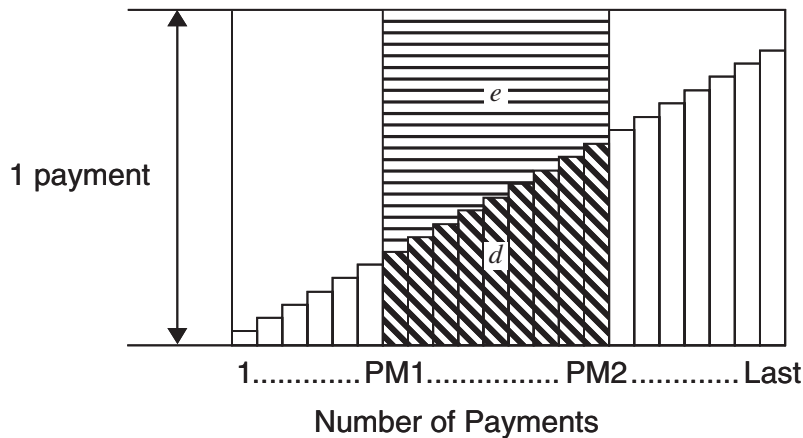

- d*: total principal from installment PM1 to payment of installment PM2 ( $\Sigma PRN$ )
- e*: total interest from installment PM1 to payment of installment PM2 ( $\Sigma INT$ )
- \**a* + *b* = one repayment (*PMT*)

$$\begin{aligned}
 a &: INT_{PM1} = |BAL_{PM1-1} \times i| \times (PMT \text{ sign}) \\
 b &: PRN_{PM1} = PMT + BAL_{PM1-1} \times i \\
 c &: BAL_{PM2} = BAL_{PM2-1} + PRN_{PM2} \\
 d &: \sum_{PM1}^{PM2} PRN = PRN_{PM1} + PRN_{PM1+1} + \dots + PRN_{PM2} \\
 e &: \sum_{PM1}^{PM2} INT = INT_{PM1} + INT_{PM1+1} + \dots + INT_{PM2}
 \end{aligned}$$

- “End” selected for the Setup screen Payment setting:  $BAL_0 = PV$
- “Begin” selected for the Setup screen Payment setting:  $INT_1 = 0$  and  $PRN_1 = PMT$

### • Converting between the nominal interest rate and effective interest rate

The nominal interest rate ( $I\%$  value input by user) is converted to an effective interest rate ( $I\%'$ ) for installment loans where the number of installments per year is different from the number of compound interest calculation periods.

$$I\%' = \left\{ \left( 1 + \frac{I\%}{100 \times [C/Y]} \right)^{\frac{[C/Y]}{[P/Y]}} - 1 \right\} \times 100$$

The following calculation is performed after conversion from the nominal interest rate to the effective interest rate, and the result is used for all subsequent calculations.

$$i = I\%' \div 100$$

Press **[F4]** (AMORTZN) from the Financial 1 screen to display the following input screen for amortization.

**[F4]** (AMORTZN)

```

Norm1 End
Amortization
PM1=0
PM2=0
n =0
I% =0
PV =0
PMT=0
FV =0
P/Y=12
C/Y=12
  
```

PM1..... first installment of installments 1 through  $n$

PM2..... second installment of installments 1 through  $n$

$n$  ..... installments

$I\%$  ..... interest rate

$PV$  ..... principal

$PMT$  ..... payment for each installment

$FV$  ..... balance following final installment

$P/Y$  ..... installments per year

$C/Y$  ..... compoundings per year

After configuring the parameters, use one of the function menus noted below to perform the corresponding calculation.

- **{BAL}** ... {balance of principal after installment PM2}
- **{INT}** ... {interest portion of installment PM1}
- **{PRN}** ... {principal portion of installment PM1}
- **{ΣINT}** ... {total interest paid from installment PM1 to installment PM2}
- **{ΣPRN}** ... {total principal paid from installment PM1 to installment PM2}
- **{COMPND}** ... {compound interest screen}

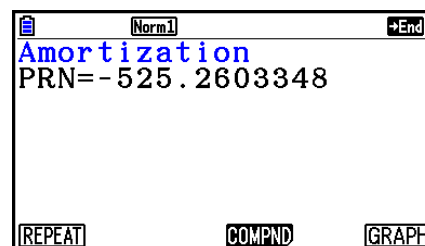

- An error occurs if parameters are not configured correctly.

Use the following function menus to maneuver between calculation result screens.

- **{REPEAT}** ... {parameter input screen}
- **{COMPND}** ... {compound interest screen}
- **{GRAPH}** ... {draws graph}

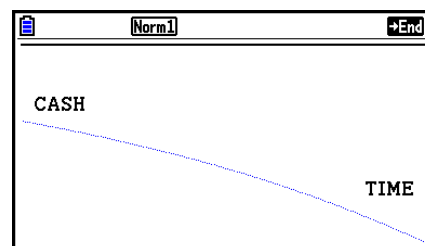

After drawing a graph, you can press **[SHIFT] [F1]** (TRACE) to turn on trace and read calculation results along the graph.

The first press of **[SHIFT] [F1]** (TRACE) displays *INT* and *PRN* when  $n = 1$ . Each press of **[▶]** shows *INT* and *PRN* when  $n = 2$ ,  $n = 3$ , and so on.

Press **[EXIT]** to return to the parameter input screen.

## 6. Interest Rate Conversion

The procedures in this section describe how to convert between the annual percent rate and effective interest rate.

### • Formula

$$EFF = \left[ \left( 1 + \frac{APR/100}{n} \right)^n - 1 \right] \times 100$$

$$APR = \left[ \left( 1 + \frac{EFF}{100} \right)^{\frac{1}{n}} - 1 \right] \times n \times 100$$

*APR* : annual percent rate (%)

*EFF* : effective interest rate (%)

*n* : number of compoundings

Press **F5** (CONVERT) from the Financial 1 screen to display the following input screen for interest rate conversion.

**F5** (CONVERT)

*n* ..... number of compoundings

*I*% ..... interest rate

After configuring the parameters, use one of the function menus noted below to perform the corresponding calculation.

- **EFF** ... {converts annual percent rate to effective interest rate}
- **APR** ... {converts effective interest rate to annual percent rate}

- An error occurs if parameters are not configured correctly.

Use the following function menu to maneuver between calculation result screens.

- **REPEAT** ... {parameter input screen}

# 7. Cost, Selling Price, Margin

Cost, selling price, or margin can be calculated by inputting the other two values.

• **Formula**

$$CST = SEL \left(1 - \frac{MRG}{100}\right)$$

$$SEL = \frac{CST}{1 - \frac{MRG}{100}}$$

$$MRG(\%) = \left(1 - \frac{CST}{SEL}\right) \times 100$$

*CST* : cost  
*SEL* : selling price  
*MRG* : margin

Press **[F1]**(COST) from the Financial 2 screen to display the following input screen.

**[F6]** (>) **[F1]** (COST)

Cst..... cost  
 Sel..... selling price  
 Mrg..... margin

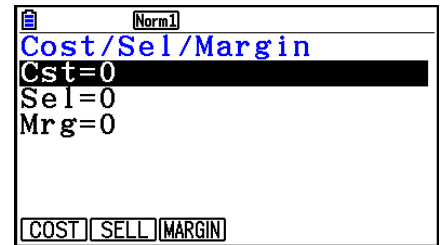

After configuring the parameters, use one of the function menus noted below to perform the corresponding calculation.

- **{COST}** ... {cost}
- **{SELL}** ... {selling price}
- **{MARGIN}** ... {margin}

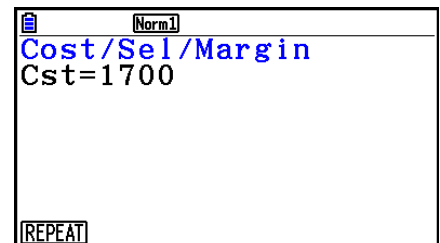

• An error occurs if parameters are not configured correctly.

Use the following function menu to maneuver between calculation result screens.

- **{REPEAT}** ... {parameter input screen}

## 8. Day/Date Calculations

You can calculate the number of days between two dates, or you can determine what date comes a specific number of days before or after another date.

Press **F2** (DAYS) from the Financial 2 screen to display the following input screen for day/date calculation.

**F6** (▷) **F2** (DAYS)

d1 ..... date 1

d2 ..... date 2

D ..... number of days

To input a date, first highlight d1 or d2. Pressing a number key to input the month causes an input screen like the one shown nearby to appear on the display.

Input the month, day, and year, pressing **EXE** after each.

After configuring the parameters, use one of the function menus noted below to perform the corresponding calculation.

- **{PRD}** ... {number of days from d1 to d2 (d2 – d1)}
- **{d1+D}** ... {d1 plus a number of days (d1 + D)}
- **{d1–D}** ... {d1 minus a number of days (d1 – D)}

• An error occurs if parameters are not configured correctly.

Use the following function menu to maneuver between calculation result screens.

- **{REPEAT}** ... {parameter input screen}

- The Setup screen can be used to specify either a 365-day or 360-day year for financial calculations. Day/date calculations are also performed in accordance with the current setting for number of days in the year, but the following calculations cannot be performed when the 360-day year is set. Attempting to do so causes an error.

(Date) + (Number of Days)

(Date) – (Number of Days)

- The allowable calculation range is January 1, 1901 to December 31, 2099.



---

## • 360-day Date Mode Calculations

The following describes how calculations are processed when 360 is specified for the Date Mode item in the Setup screen.

- If d1 and d2 are both the last day of February (day 28 in a normal year, day 29 in a leap year), d2 is treated as day 30.
- If d1 is the last day of February, d1 is treated as day 30.
- If d2 is day 31 of a month and d1 is day 30 or day 31 of a month, d2 is treated as day 30.
- If d1 is day 31 of a month, d1 is treated as day 30.

## 9. Depreciation

Depreciation lets you calculate the amount that a business expense can be offset by income (depreciated) over a given year.

- This calculator supports the following four types of depreciation calculations. straight-line (*SL*), fixed-percent (*FP*), sum-of-the-years'-digits (*SYD*), or declining-balance (*DB*).
- Any one of the above methods can be used to calculate depreciation for a specified period. A table and graph of the depreciated amount and undepreciated amount in year *j*.

---

### • Straight-Line Method (SL)

$$SL_1 = \frac{(PV-FV)}{n} \cdot \frac{\{Y-1\}}{12}$$

$$SL_j = \frac{(PV-FV)}{n}$$

$$SL_{n+1} = \frac{(PV-FV)}{n} \cdot \frac{12-\{Y-1\}}{12} \quad (\{Y-1\} \neq 12)$$

*SL<sub>j</sub>* : depreciation charge for the *j*th year

*n* : useful life

*PV* : original cost (basis)

*FV* : residual book value

*j* : year for calculation of depreciation cost

*Y-1* : number of months in the first year of depreciation

---

### • Fixed-Percent Method (FP)

$$FP_1 = PV \times \frac{I\%}{100} \times \frac{\{Y-1\}}{12}$$

$$FP_j = (RDV_{j-1} + FV) \times \frac{I\%}{100}$$

$$FP_{n+1} = RDV_n \quad (\{Y-1\} \neq 12)$$

$$RDV_1 = PV - FV - FP_1$$

$$RDV_j = RDV_{j-1} - FP_j$$

$$RDV_{n+1} = 0 \quad (\{Y-1\} \neq 12)$$

*FP<sub>j</sub>* : depreciation charge for the *j*th year

*RDV<sub>j</sub>* : remaining depreciable value at the end of *j*th year

*I%* : depreciation ratio

• **Sum-of-the-Years'-Digits Method (SYD)**

$$Z = \frac{n(n+1)}{2} \quad n' = n - \frac{\{Y-1\}}{12}$$

$$Z' = \frac{(n' \text{ integer part} + 1)(n' \text{ integer part} + 2 * n' \text{ fraction part})}{2}$$

$$SYD_1 = \frac{n}{Z} \times \frac{\{Y-1\}}{12} (PV - FV)$$

$$SYD_j = \left( \frac{n' - j + 2}{Z'} \right) (PV - FV - SYD_1) \quad (j \neq 1)$$

$$SYD_{n+1} = \left( \frac{n' - (n+1) + 2}{Z'} \right) (PV - FV - SYD_1) \times \frac{12 - \{Y-1\}}{12} \quad (\{Y-1\} \neq 12)$$

$$RDV_1 = PV - FV - SYD_1$$

$$RDV_j = RDV_{j-1} - SYD_j$$

$SYD_j$  : depreciation charge for the  $j$ th year

$RDV_j$  : remaining depreciable value at the end of  $j$ th year

• **Declining-Balance Method (DB)**

$$DB_1 = PV \times \frac{I\%}{100n} \times \frac{Y-1}{12}$$

$$RDV_1 = PV - FV - DB_1$$

$$DB_j = (RDV_{j-1} + FV) \times \frac{I\%}{100n}$$

$$RDV_j = RDV_{j-1} - DB_j$$

$$DB_{n+1} = RDV_n \quad (\{Y-1\} \neq 12)$$

$$RDV_{n+1} = 0 \quad (\{Y-1\} \neq 12)$$

$DB_j$  : depreciation charge for the  $j$ th year

$RDV_j$  : remaining depreciable value at the end of  $j$ th year

$I\%$  : depreciation factor

Press **F3** (DEPREC) from the Financial 2 screen to display the following input screen for depreciation calculation.

**F6** (>) **F3** (DEPREC)

|                                                                                                                             |        |
|-----------------------------------------------------------------------------------------------------------------------------|--------|
| [Norm]                                                                                                                      |        |
| <b>Depreciation</b>                                                                                                         |        |
| n                                                                                                                           | =5     |
| I%                                                                                                                          | =25    |
| PV                                                                                                                          | =12000 |
| FV                                                                                                                          | =0     |
| j                                                                                                                           | =1     |
| Y-1                                                                                                                         | =12    |
| <input type="checkbox"/> SL <input checked="" type="checkbox"/> FP <input type="checkbox"/> SYD <input type="checkbox"/> DB |        |

$n$  ..... useful life

$I\%$  ..... depreciation ratio in the case of the fixed percent (FP) method, depreciation factor in the case of the declining balance (DB) method

$PV$  ..... original cost (basis)

$FV$  ..... residual book value

$j$  ..... year for calculation of depreciation cost

$Y-1$  ..... number of months in the first year of depreciation

After configuring the parameters, use one of the function menus noted below to perform the corresponding calculation.

- **{SL}** ... {Calculate depreciation for year  $j$  using the straight-line method}
- **{FP}** ... **{FP}** ....{Calculate depreciation for year  $j$  using the fixed-percent method}
- **{I%}** .....{Calculate depreciation ratio}
- **{SYD}** ... {Calculate depreciation for year  $j$  using the sum-of-the-years'-digits method}
- **{DB}** ... {Calculate depreciation for year  $j$  calculated using the declining-balance method}

### Calculation Result Output Examples

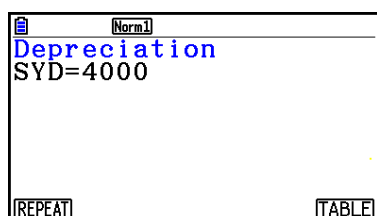

{SYD}

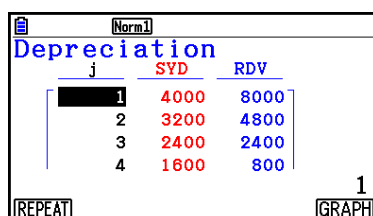

{SYD} – {TABLE}

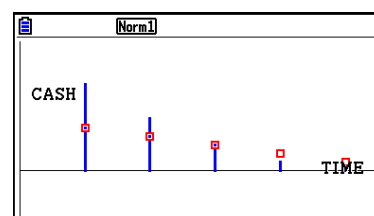

{SYD} – {GRAPH}

An error occurs if parameters are not configured correctly.

Use the following function menu to maneuver between calculation result screens.

- **{REPEAT}** ... {parameter input screen}
- **{TABLE}** ... {displays table}
- **{GRAPH}** ... {draws graph}

## 10. Bond Calculations

Bond calculation lets you calculate the purchase price or the annual yield of a bond.

Before starting bond calculations, use the Setup screen to configure “Date Mode” and “Periods/YR.” settings (page 7-2).

### • Formula

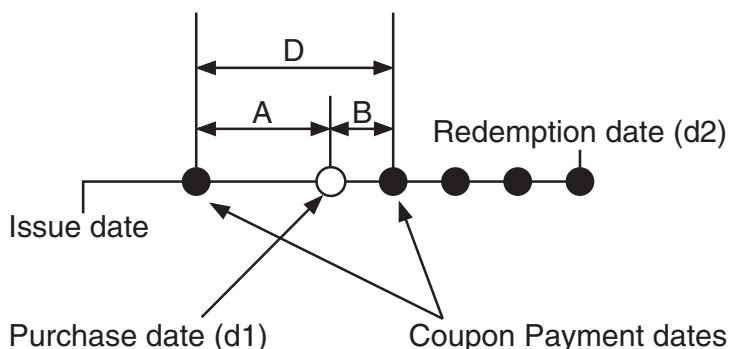

*PRC* : price per \$100 of face value

*CPN* : coupon rate (%)

*YLD* : annual yield (%)

*A* : accrued days

*M* : number of coupon payments per year (1=annual, 2=semi annual)

*N* : number of coupon payments between settlement date and maturity date

*RDV* : redemption price or call price per \$100 of face value

*D* : number of days in coupon period where settlement occurs

*B* : number of days from settlement date until next coupon payment date =  $D - A$

*INT* : accrued interest

*CST* : price including interest

- For one or fewer coupon period to redemption

$$PRC = - \frac{RDV + \frac{CPN}{M}}{1 + \left( \frac{B}{D} \times \frac{YLD/100}{M} \right)} + \left( \frac{A}{D} \times \frac{CPN}{M} \right)$$

- For more than one coupon period to redemption

$$PRC = - \frac{RDV}{\left(1 + \frac{YLD/100}{M}\right)^{(N-1+B/D)}} - \sum_{k=1}^N \frac{\frac{CPN}{M}}{\left(1 + \frac{YLD/100}{M}\right)^{(k-1+B/D)}} + \frac{A}{D} \times \frac{CPN}{M}$$
$$INT = - \frac{A}{D} \times \frac{CPN}{M} \quad CST = PRC + INT$$

---

### • Annual Yield (YLD)

YLD is calculated using Newton's Method.

Press **F4** (BOND) from the Financial 2 screen to display the following input screen for Bond calculation.

**F6** (>) **F4** (BOND)

|                         |          |
|-------------------------|----------|
| Norm1                   | Annu 365 |
| <b>Bond Calculation</b> |          |
| d1 = 01M01D1997Y(WED)   |          |
| d2 = 01M01D1997Y(WED)   |          |
| RDV=0                   |          |
| CPN=0                   |          |
| PRC=0                   |          |
| YLD=0                   |          |
| PRC                     | YLD      |

d1..... purchase date (month, date, year)  
d2..... redemption date (month, date, year)  
*RDV*..... redemption price per \$100 of face value  
*CPN*..... coupon rate  
*PRC* ..... price per \$100 of face value  
*YLD* ..... annual yield

- The allowable calculation range is January 1, 1902 to December 31, 2097.

After configuring the parameters, use one of the function menus noted below to perform the corresponding calculation.

- **{PRC}** ... {Calculate the bond's price (PRC), accrued interest (INT), and cost of bond (CST)}
- **{YLD}** ... {Calculate the yield to maturity}

### Calculation Result Output Examples

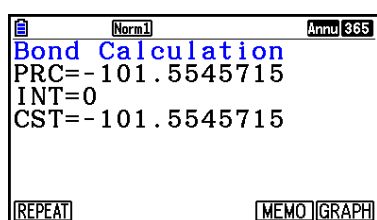

{PRC}

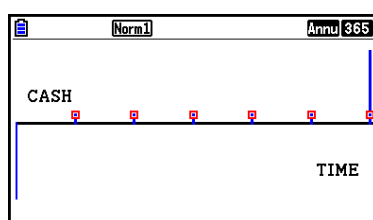

{PRC} - {GRAPH}

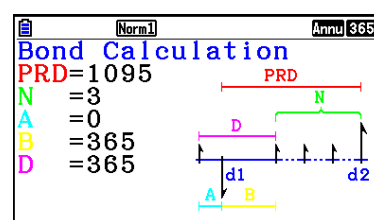

{PRC} - {MEMO}

An error occurs if parameters are not configured correctly.

Use the following function menu to maneuver between calculation result screens.

- **{REPEAT}** ... {parameter input screen}
- **{GRAPH}** ... {draws graph}
- **{MEMO}** ... {displays numbers of days used in calculations}

### MEMO Screen

- The following describes the meaning of the MEMO screen display items.

*PRD* ... number of days from d1 to d2

*N*..... number of coupon payments between settlement date and maturity date

*A*..... accrued days

*B*..... number of days from settlement date until next coupon payment date (D-A)

*D* ..... number of days in coupon period where settlement occurs

- Each press of **EXE** while the MEMO screen is displayed cycles the Coupon Payment Day (CPD) display sequentially from the redemption year up to the purchase year. This is true only when the “Date Mode” setting on the Setup screen is “365”.

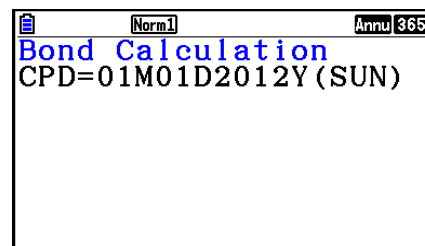

## 11. Financial Calculations Using Functions

You can use special functions in the **Run-Matrix** mode or **Program** mode to perform calculations that are the same as the **Financial** mode financial calculations.

**Example** To calculate the total interest and principal paid for a 2-year (730-day) \$300 loan at a simple annual interest rate of 5%. Use a Date Mode setting of 365.

1. From the Main Menu, enter the **Run-Matrix** mode.
2. Press the keys as follows.

**OPTN** **F6** (**▷**) **F6** (**▷**) **F2** (FINANCE)\*  
**F1** (SIMPLE) **F1** (SI) **7** **3** **0** **,** **5** **,**  
**3** **0** **0** **)** **EXE**

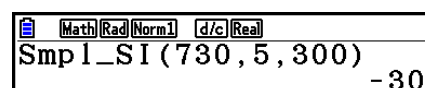

**F2** (SFV) **7** **3** **0** **,** **5** **,** **3** **0** **0** **)**  
**EXE**

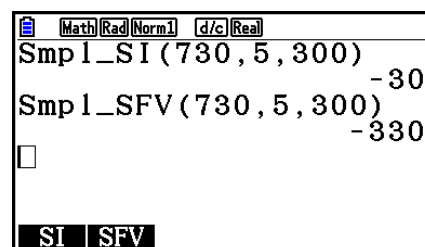

\* Math input/output mode operation. In the Linear input/output mode, use the following operation: **OPTN** **F6** (**▷**) **F6** (**▷**) **F6** (**▷**) **F1** (FINANCE).

- Use the **Financial** mode Setup screen (**SHIFT** **MENU** (SET UP)) to change the “Date Mode” setting. You also can use special commands (DateMode365, DateMode360) in the **Program** mode to change the setting.
- For details about what you can do with the financial calculation functions and their syntax, see “Performing Financial Calculations in a Program” (page 8-48).

# Chapter 8 Programming

## Important!

Input in the **Program** mode is always performed using the Linear input/output mode.

## 1. Basic Programming Steps

Commands and calculations are executed sequentially.

1. From the Main Menu, enter the **Program** mode. When you do, a program list appears on the display.

Selected program area  
(use ▲ and ▼ to move)



| Program List |   |     |
|--------------|---|-----|
| AREA *       | : | 48  |
| GRAPHICS     | : | 60  |
| MEASURE      | : | 84  |
| OCTA         | : | 60  |
| OCTONARY     | : | 96  |
| TRIANGLE     | : | 104 |

At the bottom of the screen, there are menu options: EXE, EDIT, NEW, DELETE, DEL-ALL, and a right arrow.

Files are listed in the alphabetic sequence of their names.

2. Register a file name.
  3. Input the program.
  4. Run the program.
- The values to the right of the program list indicate the number of bytes used by each program.
  - A file name can be up to eight characters long.
  - The following are the characters you can use in a file name: A through Z, {, }, ', ~, 0 through 9
  - Registering a file name uses 32 bytes of memory.

### Example

To calculate the surface area (cm<sup>2</sup>) and volume (cm<sup>3</sup>) of three regular octahedrons when the length of one side is 7, 10, and 15 cm, respectively

Store the calculation formula under the file name OCTA.

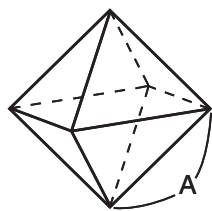

The following are the formulas used for calculating surface area S and volume V of a regular octahedron for which the length of one side A is known.

$$S = 2\sqrt{3} A^2, \quad V = \frac{\sqrt{2}}{3} A^3$$

- ① **MENU** Program
- ② **F3** (NEW) **9** (O) **In** (C) **⇄** (T) **X,θ,T** (A) **EXE**
- ③ **SHIFT** **VARS** (PRGM) **F4** (?) **→** **ALPHA** **X,θ,T** (A) **F6** (▷) **F5** (:)  
**2** **X** **SHIFT** **x<sup>2</sup>** ( $\sqrt{\quad}$ ) **3** **X** **ALPHA** **X,θ,T** (A) **x<sup>2</sup>** **F6** (▷) **F6** (▷) **F5** (▲)  
**SHIFT** **x<sup>2</sup>** ( $\sqrt{\quad}$ ) **2** **÷** **3** **X** **ALPHA** **X,θ,T** (A) **△** **3**  
**EXIT** **EXIT**

- ④ **F1** (EXE) or **EXE**  
**7** **EXE** (Value of A)  
**EXE**

|              |   |             |
|--------------|---|-------------|
|              | ? |             |
| S when A = 7 | 7 | 169.7409791 |
| V when A = 7 |   | 161.6917506 |

- EXE** **EXE**
- 1** **0** **EXE**
- EXE**

|               |    |             |
|---------------|----|-------------|
|               | ?  |             |
| S when A = 10 | 10 | 346.4101615 |
| V when A = 10 |    | 471.4045208 |

- EXE** **EXE**
- 1** **5** **EXE**
- EXE** \*1

|               |    |             |
|---------------|----|-------------|
|               | ?  |             |
| S when A = 15 | 15 | 779.4228634 |
| V when A = 15 |    | 1590.990258 |

\*1 Pressing **EXE** while the program's final result is on the display exits the program.

- You can also run a program while in the **Run-Matrix** mode by inputting: Prog "<file name>" **EXE**.
- Pressing **EXE** while the final result of a program executed using this method is on the display re-executes the program.
- An error occurs if the program specified by Prog "<file name>" cannot be found.

## 2. Program Mode Function Keys

### • File List Function Menu

Only the {NEW} and {LOAD} function menus are displayed when there are no program files in memory.

- {**EXE**}/{**EDIT**} ... program {execute}/{edit}
- {**NEW**} ... {new program}
- {**DELETE**}/{**DEL-ALL**} ... {specific program}/{all program} delete
- {**SEARCH**}/{**RENAME**} ... file name {search}/{change}
- {**SAVE • AS**} ... saves program as a text file
- {**LOAD**} ... converts a text file to a program and saves it
- {**🔑**} ... password protects a program or removes password protection





---

## • When you are registering a file name

- {RUN}/{BASE} ... {general calculation}/{number base} program input
- {} ... {password registration}
- {SYMBOL} ... {symbol menu}

---



## • When you are inputting a program — (RUN) ... default

- {TOP}/{BOTTOM} ... {top}/{bottom} of program
  - {SEARCH} ... {search}
  - {MENU} ... {mode menu}
  - {STAT}/{MAT}/{LIST}/{GRAPH}/{DYNA}/{TABLE}/{RECURSION}  
... {statistics}/{matrix}/{list}/{graph}/{Dynamic Graph}/{Table}/{recursion} menu
  - {A↔a} ... {toggles between upper-case and lower-case input}
  - {CHAR} ... {displays a screen for selecting various mathematical symbols, special symbols, and accented characters}
- Pressing   (PRGM) displays the following program (PRGM) menu.
- {COMMAND} ... {program command menu}
  - {CONTROL} ... {program control command menu}
  - {JUMP} ... {jump command menu}
  - {?}/{▲} ... {input}/{output} command
  - {CLEAR}/{DISPLAY} ... {clear}/{display} command menu
  - {RELATNL} ... {conditional jump relational operator menu}
  - {I/O} ... {I/O control/transfer command menu}
  - {:} ... {multi-statement command}
  - {STR} ... {string command}

See “Command Reference” on page 8-11 for full details on each of these commands.

- Pressing   (SET UP) displays the mode command menu shown below.
- {ANGLE}/{COORD}/{GRID}/{AXES}/{LABEL}/{DISPLAY}/{SKT/LIN}/{DRAW}/{DERIV}/  
{BACK}/{FUNC}/{SIMUL}/{SGV-WIN}/{LIST}/{LOCUS}/{TBL-VAR}/{ΣDISP}/{RESID}/  
{COMPLEX}/{FRAC}/{Y=SPEED}/{DATE}/{PMT}/{PERIODS}/{INEQ}/{SIMP}/{Q1Q3}/{P/L-  
CLR}

See “Setup Screen Function Key Menus” on page 1-32 for details about each of these commands.

- Pressing   (FORMAT) displays the color/paint command menu. For details, see “Using Color Commands in a Program” (page 8-28) and “Using Paint Commands in a Program” (page 8-29).

---

## • When you are inputting a program — **F2**(BASE)\*

\* Programs input after pressing **F2**(BASE) are indicated by **B** to the right of the file name.

- {**TOP**}/{**BOTTOM**}/{**SEARCH**}
  - {**MENU**}
  - {**d~o**} ... {decimal}/{hexadecimal}/{binary}/{octal} value input
  - {**LOGIC**} ... {bitwise operator}
  - {**DISPLAY**} ... conversion of displayed value to {decimal}/{hexadecimal}/{binary}/{octal}
  - {**A↔a**}/{**SYMBOL**}
- 
- Pressing **SHIFT** **VAR** (PRGM) displays the following program (PRGM) menu.
    - {**Prog**} ... {program recall}
    - {**JUMP**}/{**?**}/{**▲**}
    - {**RELATNL**} ... {conditional jump relational operator menu}
    - {**:**} ... {multi-statement command}
  - Pressing **SHIFT** **MENU** (SET UP) displays the mode command menu shown below.
    - {**Dec**}/{**Hex**}/{**Bin**}/{**Oct**}
  - Pressing **SHIFT** **5** (FORMAT) displays the color command menu. For details, see “Using Color Commands in a Program” (page 8-28).

## 3. Editing Program Contents

---

### ■ Debugging a Program

A problem in a program that keeps the program from running correctly is called a “bug”, and the process of eliminating such problems is called “debugging”. Either of the following symptoms indicates that your program contains bugs that require debugging.

- Error messages appearing when the program is run
- Results that are not within your expectations

---

#### • To eliminate bugs that cause error messages

An error message, like the one shown to the right, appears whenever something illegal occurs during program execution.

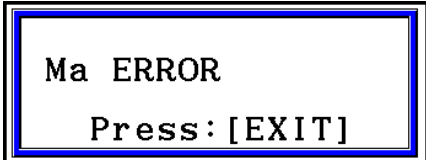

Ma ERROR  
Press: [EXIT]

When such a message appears, press **EXIT** to display the place in the program where the error was caused. The cursor will be flashing at the location of the problem. Check the “Error Message Table” (page α-1) for steps you should take to correct the situation.

- Note that pressing **EXIT** does not display the location of the error if the program is password protected.

### • To eliminate bugs that cause bad results

If your program produces results that are not what you normally expect, check the contents of the program and make necessary changes.

**F1** (TOP) ..... Moves the cursor to the top of the program

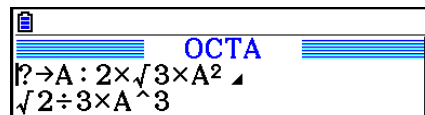

**F2** (BOTTOM) ... Moves the cursor to the bottom of the program

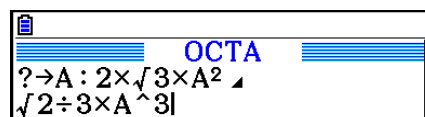

## ■ Searching for Data Inside a Program

**Example** To search for the letter "A" inside the program named OCTA

1. Recall the program.
2. Press **F3** (SEARCH) and input the data you want to find.

**F3** (SEARCH)

**ALPHA** **X,θ,T** (A)

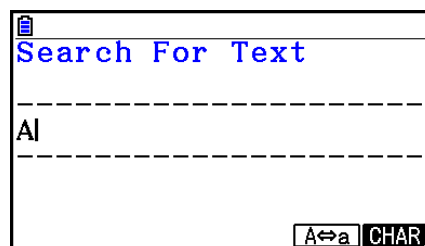
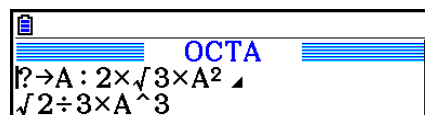

3. Press **EXE** to begin the search. The contents of the program appear on the screen with the cursor located at the first instance of the data you specified.\*<sup>1</sup>

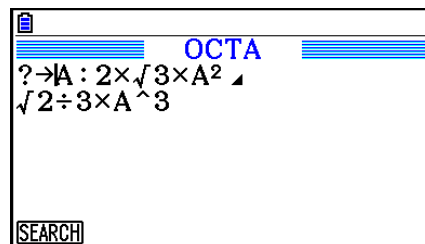

4. Each press of **EXE** or **F1** (SEARCH) causes the cursor to jump to the next instance of the data you specified.\*<sup>2</sup>

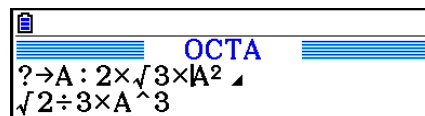

\*<sup>1</sup> The message "Not Found" appears when the search data you specify cannot be found in the program.

\*<sup>2</sup> If there are no more instances of the data you specified, the search operation ends.

- You cannot specify the newline symbol (↵) or output command (▲) for the search data.
- Once the contents of the program are on the screen, you can use the cursor keys to move the cursor to another location before searching for the next instance of the data. Only the part of the program starting from the current cursor location is searched when you press [EXE].
- Once the search finds an instance of your data, inputting characters or moving the cursor causes the search operation to be cancelled.
- If you make a mistake while inputting characters to search for, press [AC] to clear your input and re-input from the beginning.

## 4. File Management

---

### ■ Deleting a Program

---

#### • To delete a specific program

1. While the program list is on the display, use [▲] and [▼] to move the highlighting to the name of the program you want to delete.
  2. Press [F4] (DELETE).
  3. Press [F1] (Yes) to delete the selected program or [F6] (No) to abort the operation without deleting anything.
- 

#### • To delete all programs

1. While the program list is on the display, press [F5] (DEL-ALL).
  2. Press [F1] (Yes) to delete all the programs in the list or [F6] (No) to abort the operation without deleting anything.
- You also can delete all programs by entering the **Memory** mode from the Main Menu. See “Chapter 11 Memory Manager” for details.

---

## ■ Searching for a File

---

### ● To find a file using initial character search

**Example** To use initial character search to recall the program named OCTA

1. While the program list is on the display, press **F6**(▷)**F1**(SEARCH) and input the initial characters of the file you want to find.

**F6**(▷)**F1**(SEARCH)

**9**(O)**In**(C)**÷**(T)



2. Press **EXE** to search.

- The name that starts with the characters you input highlights.



- If there is no program whose file name starts with the characters you input, the message “Not Found” appears on the display. If this happens, press **EXIT** to clear the error message.

---

## ■ Editing a File Name

1. While the program list is on the display, use **▲** and **▼** to move the highlighting to the file whose name you want to edit and then press **F6**(▷)**F2**(RENAME).
2. Make any changes you want.
3. Press **EXE** to register the new name and return to the program list.

The program list is resorted according to the changes you made in the file name.

- If the modifications you make result in a file name that is identical to the name of a program already stored in memory, the message “Already Exists” appears. When this happens, press **EXIT** or **AC** to clear the input file name and input a new one.

---

## ■ Converting Programs and Text Files

You can convert programs created on this calculator to a text file, and then use a text editor or other application on your computer to edit them. You also can convert text files created and edited on your computer to a program that can be run by the calculator.

---

## • Program and Text File Conversion Rules

Conversion of program and text files is subject to the following rules.

- Certain characters in the program name are automatically replaced and the result is assigned as the file name whenever you convert a program to a text file. When you convert from a text file to a program, the program name is assigned by converting in the opposite direction.

| Program Name Characters | Text File Name Characters |
|-------------------------|---------------------------|
| r                       | _r_                       |
| $\theta$                | _t_                       |
| Leading/trailing spaces | _s_                       |
| "                       | _q_                       |
| Leading/trailing dots   | _p_                       |
| ×                       | _x_                       |
| ÷                       | _d_                       |
| +                       | _+_                       |
| –                       | _-                        |

- The following header information is added to the text file when converting from a program to a text file.

'Program Mode: RUN (RUN Mode program)

'Program Mode: BASE (BASE Mode program)

- Converting a text file that contains the above header information to a program converts to a program of the mode specified in the header information. The header information line text is not included in the converted program.
- Converting a program to a text file causes all CASIO scientific function calculator-specific commands in the program to be replaced by special corresponding character strings. Conversely, converting from a text file to a program converts the special character strings back to their corresponding commands. For information about program commands and their corresponding special character strings, see “CASIO Scientific Function Calculator Special Commands ⇔ Text Conversion Table” (page 8-59).

---

### • To convert a program to a text file

1. In the program list, use  $\blacktriangle$  and  $\blacktriangledown$  to move the highlighting to the name of the program you want to convert to a text file.
2. Press **F6**( $\triangleright$ )**F3**(SAVE • AS).
  - This starts conversion to a text file. The message “Complete!” appears after conversion is complete. To close the message dialog box, press **EXIT**.
  - The resulting text file is stored in the storage memory’s PROGRAM folder, under a name that is basically the same as the original file, except for certain special characters. For details about special character exceptions, see “Program and Text File Conversion Rules” above.

### ***Important!***

A program that is password protected cannot be converted to a text file. To convert a password protected file, first use the procedure under “To remove password protection from a program” (page 8-10) to remove password protection and then convert it.

---

## • **Auto Conversion from Text Files to Programs**

Whenever you terminate the USB connection between the calculator and computer, all of the text files that were transferred from the computer to Storage Memory\@MainMem\PROGRAM\ while they were connected will be automatically converted to programs and stored in the calculator’s main memory.

For details, see “Transferring Data between the Calculator and a Personal Computer” (page 13-5).

---

## • **To convert a text file to a program**

### ***Important!***

Using the procedure below to convert a text file to a program will create and save a program under a name that is basically the same as the original file, except for certain special characters. For details about special character exceptions, see “Program and Text File Conversion Rules” (page 8-8).

If there is already a program in memory with the same name as the program created by the conversion process, the existing program will be overwritten automatically with the new program. If you do not want such an existing program to be overwritten, use the program list to change its name before performing this procedure.

1. Copy the text file you want to convert to a program to the calculator’s storage memory root directory.
  - For information about the procedure for copying files from a computer or another calculator to this calculator’s storage memory, see “Chapter 13 Data Communication”.
2. From the Main Menu, enter the **Program** mode.
3. On the program list, press **F6** (▷) **F4** (LOAD).
  - This displays a list of folders and text files currently in the storage memory root directory.
4. Use **▲** and **▼** to move the highlighting to the text file you want to convert and then press **F1** (OPEN).

---

## ■ Registering a password

When inputting a program, you can protect it with a password that limits access to the program contents to those who know the password.

- You do not need to input the password to run a program.
- The password input procedure is identical to that used for file name input.

---

### • To password protect a program as you are creating it

1. While the program list is on the display, press **F3** (NEW) and input the file name of the new program file.
2. Press **F5** (🔑) and then input the password.
3. Press **EXE** to register the file name and password. Now you can input the contents of the program file.
4. After inputting the program, press **SHIFT** **EXIT** (QUIT) to exit the program file and return to the program list.  
Files that are password protected are indicated by an asterisk to the right of the file name.



---

### • To password protect an existing program

1. In the program list, use **▲** and **▼** to move the highlighting to the name of the program you want to password protect.
2. Press **F6** (▷) **F5** (🔑) and then input the password.
3. Press **EXE** to register the password.
  - This returns to the program list.

---

### • To remove password protection from a program

1. In the program list, use **▲** and **▼** to move the highlighting to the name of the program whose password you want to remove.
2. Press **F6** (▷) **F5** (🔑) and then input the programs current password.
3. To remove password protection, press **EXE**.
  - This returns to the program list.



---

## ■ Recalling a Password Protected Program

1. In the program list, use  $\blacktriangle$  and  $\blacktriangledown$  to move the highlighting to the name of the program you want to recall.
  2. Press  $\boxed{F2}$  (EDIT).
  3. Input the password and press  $\boxed{EXE}$  to recall the program.
- Inputting the wrong password when recalling a password protected program causes the message "Mismatch" to appear.

## 5. Command Reference

---

### ■ Command Index

|                                                |      |                                            |      |
|------------------------------------------------|------|--------------------------------------------|------|
| Break.....                                     | 8-15 | RclCapt .....                              | 8-27 |
| CloseComport38k .....                          | 8-24 | Receive(.....                              | 8-24 |
| ClrGraph .....                                 | 8-19 | Receive38k .....                           | 8-24 |
| ClrList .....                                  | 8-19 | Return .....                               | 8-16 |
| ClrMat .....                                   | 8-20 | Send( .....                                | 8-24 |
| ClrText .....                                  | 8-20 | Send38k.....                               | 8-24 |
| ClrVct .....                                   | 8-20 | Stop .....                                 | 8-17 |
| DispF-Tbl, DispR-Tbl .....                     | 8-20 | StrCmp(.....                               | 8-25 |
| Do~LpWhile .....                               | 8-14 | StrInv( .....                              | 8-26 |
| DrawDyna .....                                 | 8-20 | StrJoin(.....                              | 8-26 |
| DrawFTG-Con, DrawFTG-Plt .....                 | 8-20 | StrLeft( .....                             | 8-26 |
| DrawGraph .....                                | 8-21 | StrLen( .....                              | 8-26 |
| DrawR-Con, DrawR-Plt .....                     | 8-21 | StrLwr( .....                              | 8-26 |
| DrawR $\Sigma$ -Con, DrawR $\Sigma$ -Plt ..... | 8-21 | StrMid( .....                              | 8-26 |
| DrawStat .....                                 | 8-21 | StrRight(.....                             | 8-26 |
| DrawWeb .....                                  | 8-21 | StrRotate(.....                            | 8-27 |
| Dsz (Count Jump).....                          | 8-17 | StrShift( .....                            | 8-27 |
| Exp(.....                                      | 8-25 | StrSrc(.....                               | 8-27 |
| Exp►Str( .....                                 | 8-25 | StrUpr( .....                              | 8-27 |
| For~To~(Step~)Next.....                        | 8-14 | While~WhileEnd .....                       | 8-15 |
| Getkey .....                                   | 8-22 | ? (Input Command).....                     | 8-12 |
| Goto~Lbl .....                                 | 8-17 | ▲ (Output Command) .....                   | 8-12 |
| If~Then~(Else~)IfEnd .....                     | 8-13 | : (Multi-statement Command) .....          | 8-13 |
| Isz (Count Jump).....                          | 8-18 | ↵ (Carriage Return) .....                  | 8-13 |
| Locate .....                                   | 8-23 | ' (Comment Text Delimiter) .....           | 8-13 |
| Menu .....                                     | 8-19 | ⇒ (Jump Code) .....                        | 8-18 |
| OpenComport38k.....                            | 8-24 | =, ≠, >, <, ≥, ≤ (Relational Operators) .. | 8-24 |
| Prog .....                                     | 8-16 | + (Joins two strings).....                 | 8-27 |
| PlotPhase.....                                 | 8-22 |                                            |      |

The following are conventions that are used in this section when describing the various commands.

{Curly Brackets}..... Curly brackets are used to enclose a number of items, one of which must be selected when using a command. Do not input the curly brackets when inputting a command.

[Square Brackets] ..... Square brackets are used to enclose items that are optional. Do not input the square brackets when inputting a command.

Numeric Expressions... Numeric expressions (such as 10,  $10 + 20$ , A) indicate constants, calculations, numeric constants, etc.

Alpha Characters ..... Alpha characters indicate literal strings (such as AB).

---

## ■ Basic Operation Commands

### ? (Input Command)

**Function:** Prompts for input of values for assignment to variables during program execution.

**Syntax:** ? → <variable name>, "<prompt>" ? → <variable name>

**Example:** ? → A

**Description:**

- This command momentarily interrupts program execution and prompts for input of a value or expression for assignment to a variable. If you do not specify a prompt, execution of this command causes "?" to appear indicating the calculator is standing by for input. If a prompt is specified, "<prompt>?" appears to prompt input. Up to 255 bytes of text can be used for a prompt.
- Input in response to the input command must be a value or an expression, and the expression cannot be a multi-statement.
- You can specify a list name, matrix name, vector name, string memory, function memory (fn), graph (Yn), etc. as a variable name.

### ▲ (Output Command)

**Function:** Displays an intermediate result during program execution.

**Description:**

- This command momentarily interrupts program execution and displays alpha character text or the result of the calculation immediately before the command.
- The output command should be used at locations where you would normally press the  key during a manual calculation.



**Parameters:** condition, numeric expression

**Description:**

(1) If ~ Then ~ IfEnd

- When the condition is true, execution proceeds with the Then-statement and then continues with the statement following IfEnd.
- When the condition is false, execution jumps to the statement following IfEnd.

(2) If ~ Then ~ Else ~ IfEnd

- When the condition is true, execution proceeds with the Then-statement and then jumps to the statement following IfEnd.
- When the condition is false, execution jumps to the Else-statement and then continues with the statement following IfEnd.

**For~To~(Step~)Next**

**Function:** This command repeats everything between the For-statement and the Next-statement. The starting value is assigned to the control variable with the first execution, and the value of the control variable is changed according to the step value with each execution. Execution continues until the value of the control variable exceeds the ending value.

**Syntax:** For <starting value> → <control variable name> To <ending value>

(Step <step value>) <statement>  $\left\{ \begin{array}{c} \leftarrow \\ : \\ \rightarrow \end{array} \right\}$  Next

**Parameters:**

- control variable name: A to Z, r,  $\theta$
- starting value: value or expression that produces a value (i.e.  $\sin x$ , A, etc.)
- ending value: value or expression that produces a value (i.e.  $\sin x$ , A, etc.)
- step value: numeric value (default: 1)

**Description:**

- The default step value is 1.
- Making the starting value less than the ending value and specifying a positive step value causes the control variable to be incremented with each execution. Making the starting value greater than the ending value and specifying a negative step value causes the control variable to be decremented with each execution.

**Do~LpWhile**

**Function:** This command repeats specific commands as long as its condition is true (non-zero).

**Syntax:**

Do  $\left\{ \begin{array}{c} \leftarrow \\ : \\ \rightarrow \end{array} \right\}$  <statement>  $\left\{ \begin{array}{c} \leftarrow \\ : \\ \rightarrow \end{array} \right\}$  LpWhile <condition>  
numeric expression



## Prog

**Function:** This command specifies execution of another program as a subroutine. In the **Run-Matrix** mode, this command executes a new program.

**Syntax:** Prog "file name"

**Example:** Prog "ABC"

**Description:**

- Even when this command is located inside of a loop, its execution immediately breaks the loop and launches the subroutine.
- This command can be used as many times as necessary inside of a main routine to call up independent subroutines to perform specific tasks.
- A subroutine can be used in multiple locations in the same main routine, or it can be called up by any number of main routines.

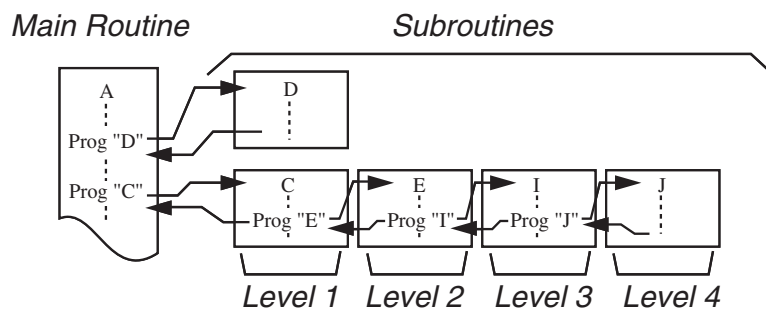

- Calling up a subroutine causes it to be executed from the beginning. After execution of the subroutine is complete, execution returns to the main routine, continuing from the statement following the Prog command.
- A Goto~Lbl command inside of a subroutine is valid inside of that subroutine only. It cannot be used to jump to a label outside of the subroutine.
- If a subroutine with the file name specified by the Prog command does not exist, an error occurs.
- In the **Run-Matrix** mode, inputting the Prog command and pressing **[EXE]** launches the program specified by the command.

## Return

**Function:** This command returns from a subroutine.

**Syntax:** Return

**Description:** Execution of the Return command inside a main routine causes execution of the program to stop. Execution of the Return command within a subroutine terminates the subroutine and returns to the program from which the subroutine was jumped to.

## Stop

**Function:** This command terminates execution of a program.

**Syntax:** Stop

**Description:**

- This command terminates program execution.
- Execution of this command inside of a loop terminates program execution without an error being generated.

## ■ Jump Commands (JUMP)

### Dsz (Count Jump)

**Function:** This command is a count jump that decrements the value of a control variable by 1, and then jumps if the current value of the variable is zero.

**Syntax:**

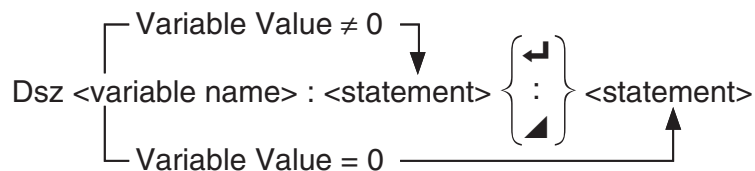

**Parameters:** variable name: A to Z, *r*, *θ*

[Example] Dsz B : Decrements the value assigned to variable B by 1.

**Description:** This command decrements the value of a control variable by 1, and then tests (checks) it. If the current value is non-zero, execution continues with the next statement. If the current value is zero, execution jumps to the statement following the multi-statement command (:), output command (↵), or carriage return (↵).

### Goto~Lbl

**Function:** This command performs an unconditional jump to a specified location.

**Syntax:** Goto <label name> ~ Lbl <label name>

**Parameters:** label name: value (0 to 9), variable (A to Z, *r*, *θ*)

**Description:**

- This command consists of two parts: Goto *n* (where *n* is a parameter as described above) and Lbl *n* (where *n* is the parameter referenced by Goto *n*). This command causes program execution to jump to the Lbl-statement whose *n* parameter matches that specified by the Goto-statement.
- This command can be used to loop back to the beginning of a program or to jump to any location within the program.
- This command can be used in combination with conditional jumps and count jumps.
- If there is no Lbl-statement whose value matches that specified by the Goto-statement, an error occurs.

## Isz (Count Jump)

**Function:** This command is a count jump that increments the value of a control variable by 1, and then jumps if the current value of the variable is zero.

**Syntax:**

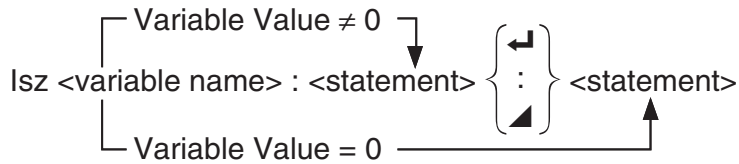

**Parameters:** variable name: A to Z, *r*, *θ*

[Example] Isz A : Increments the value assigned to variable A by 1.

**Description:** This command increments the value of a control variable by 1, and then tests (checks) it. If the current value is non-zero, execution continues with the next statement.

If the current value is zero, execution jumps to the statement following the multi-statement command (:), output command (▲), or carriage return (↵).

## ⇒ (Jump Code)

**Function:** This code is used to set up conditions for a conditional jump. The jump is executed whenever the conditions are false.

**Syntax:**

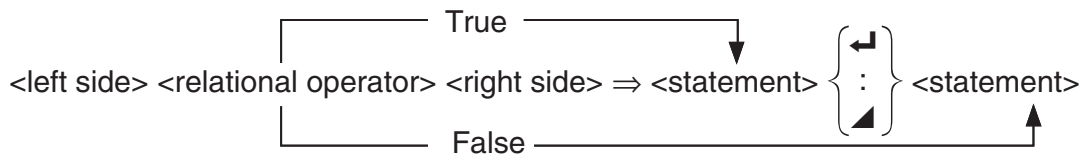

**Parameters:**

- left side/right side: variable (A to Z, *r*, *θ*), numeric constant, variable expression (such as:  $A \times 2$ )
- relational operator: =, ≠, >, <, ≥, ≤ (page 8-24)

**Description:**

- The conditional jump compares the contents of two variables or the results of two expressions, and a decision is made whether or not to execute the jump based on the results of the comparison.
- If the comparison returns a true result, execution continues with the statement following the ⇒ command. If the comparison returns a false result, execution jumps to the statements following the multi-statement command (:), output command (▲), or carriage return (↵).



## Menu

**Function:** Creates a branching menu in a program.

**Syntax:** Menu "<string (menu name)>", "<string (branch name) 1>", <value or variable 1>, "<string (branch name) 2>", <value or variable 2>, ... , "<string (branch name) n>", <value or variable n>

**Parameters:** value (0 to 9), variable (A to Z, r, θ)

**Description:**

- Each "<string (branch name) n>", <value or variable n> part is a branch set, and the entire branch set must be included.
- From two to nine branching sets can be included. An error occurs when there is only one or more than nine branching sets.
- Selecting a branch on the menu while the program is running jumps to the same type of label (Lbl n) as the one used in combination with the Goto command. Specifying ""OK", 3" for the ""<string (branch name) n>", <value or variable n>" part specifies a jump to Lbl 3.

**Example:** Lbl 2 ↵

```
Menu "IS IT DONE?", "OK", 1, "EXIT", 2 ↵
```

```
Lbl 1 ↵
```

```
"IT'S DONE !"
```

---

## ■ Clear Commands (CLEAR)

### ClrGraph

**Function:** This command clears the graph screen and returns the View Window settings to their initial (INITIAL) settings.

**Syntax:** ClrGraph

**Description:** This command clears the graph screen during program execution.

### ClrList

**Function:** This command deletes list data.

**Syntax:** ClrList <list name>

```
ClrList
```

**Parameters:** list name: 1 to 26, Ans

**Description:** This command deletes the data in the list specified by "list name". All list data is deleted if nothing is specified for "list name".

### ClrMat

**Function:** This command deletes matrix data.

**Syntax:** ClrMat <matrix name>

ClrMat

**Parameters:** matrix name: A to Z, Ans

**Description:** This command deletes the data in the matrix specified by “matrix name”. All matrix data is deleted if nothing is specified for “matrix name”.

### ClrText

**Function:** This command clears the text screen.

**Syntax:** ClrText

**Description:** This command clears text from the screen during program execution.

### ClrVct

**Function:** This command deletes vector data.

**Syntax:** ClrVct <vector name>

ClrVct

**Parameters:** vector name: A to Z, Ans

**Description:** This command deletes the data in the vector specified by “vector name”. All vector data is deleted if nothing is specified for “vector name”.

---

## ■ Display Commands (DISPLAY)

### DispF-Tbl, DispR-Tbl

No parameters

**Function:** These commands display numeric tables.

**Description:**

- These commands generate numeric tables during program execution in accordance with conditions defined within the program.
- DispF-Tbl generates a function table, while DispR-Tbl generates a recursion table.

### DrawDyna

No parameters

**Function:** This command executes a Dynamic Graph draw operation.

**Description:** This command draws a Dynamic Graph during program execution in accordance with the drawing conditions defined within the program.

### DrawFTG-Con, DrawFTG-Plt

No parameters

**Function:** This command uses values in a generated table to graph a function.

**Description:**

- This command draws a function graph in accordance with conditions defined within the program.
- DrawFTG-Con produces a connect type graph, while DrawFTG-Plt produces a plot type graph.

**DrawGraph****No parameters**

**Function:** This command draws a graph.

**Description:** This command draws a graph in accordance with the drawing conditions defined within the program.

**DrawR-Con, DrawR-Plt****No parameters**

**Function:** These commands graph recursion expressions, with  $a_n$  ( $b_n$  or  $c_n$ ) as the vertical axis and  $n$  as the horizontal axis.

**Description:**

- These commands graph recursion expressions in accordance with conditions defined within the program, with  $a_n$  ( $b_n$  or  $c_n$ ) as the vertical axis and  $n$  as the horizontal axis.
- DrawR-Con produces a connect type graph, while DrawR-Plt produces a plot type graph.

**DrawR $\Sigma$ -Con, DrawR $\Sigma$ -Plt****No parameters**

**Function:** These commands graph recursion expressions, with  $\Sigma a_n$  ( $\Sigma b_n$  or  $\Sigma c_n$ ) as the vertical axis and  $n$  as the horizontal axis.

**Description:**

- These commands graph recursion expressions in accordance with conditions defined within the program, with  $\Sigma a_n$  ( $\Sigma b_n$  or  $\Sigma c_n$ ) as the vertical axis and  $n$  as the horizontal axis.
- DrawR $\Sigma$ -Con produces a connect type graph, while DrawR $\Sigma$ -Plt produces a plot type graph.

**DrawStat**

**Function:** This draws a statistical graph.

**Syntax:** See “Using Statistical Calculations and Graphs in a Program” on page 8-35.

**Description:** This command draws a statistical graph in accordance with conditions defined within the program.

**DrawWeb**

**Function:** This command graphs convergence/divergence of a recursion expression (WEB graph).

**Syntax:** DrawWeb <recursion type>[, <number of lines>]

**Example:** DrawWeb  $a_{n+1}$  ( $b_{n+1}$  or  $c_{n+1}$ ), 5

**Description:**

- This command graphs convergence/divergence of a recursion expression (WEB graph).
- Omitting the number of lines specification automatically specifies the default value 30.

## PlotPhase

**Function:** Graphs a phase plot based on numeric sequences that correspond to the  $x$ -axis and  $y$ -axis.

**Syntax:** PlotPhase < $x$ -axis numeric sequence name>, < $y$ -axis numeric sequence name>

**Description:**

- Only the following commands can be input for each argument to specify the recursion table.

$a_n, b_n, c_n, a_{n+1}, b_{n+1}, c_{n+1}, a_{n+2}, b_{n+2}, c_{n+2}, \Sigma a_n, \Sigma b_n, \Sigma c_n, \Sigma a_{n+1}, \Sigma b_{n+1}, \Sigma c_{n+1}, \Sigma a_{n+2}, \Sigma b_{n+2}, \Sigma c_{n+2}$

- A Memory ERROR occurs if you specify a numeric sequence name that does not have values stored in the recursion table.

**Example:** PlotPhase  $\Sigma b_{n+1}, \Sigma a_{n+1}$

Graphs a phase plot using  $\Sigma b_{n+1}$  for the  $x$ -axis and  $\Sigma a_{n+1}$  for the  $y$ -axis.

## Input/Output Commands (I/O)

### Getkey

**Function:** This command returns the code that corresponds to the last key pressed.

**Syntax:** Getkey

**Description:**

- This command returns the code that corresponds to the last key pressed.

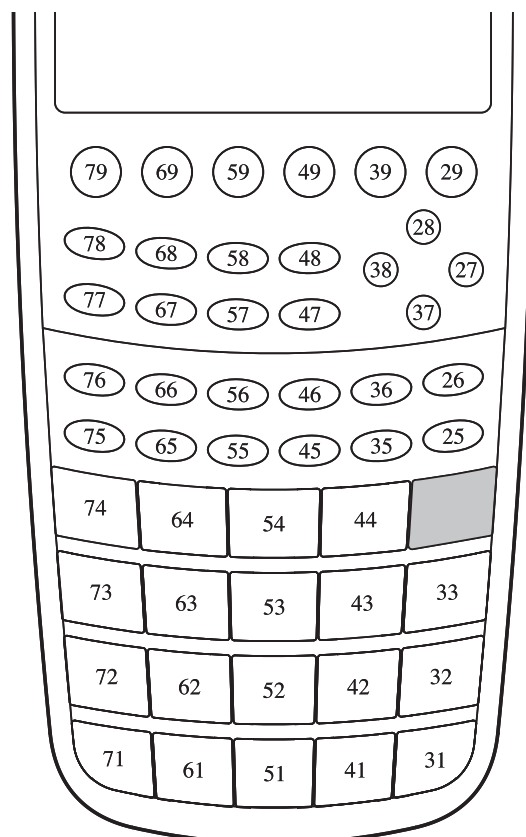

- A value of zero is returned if no key was pressed previous to executing this command.
- This command can be used inside of a loop.

## Locate

**Function:** This command displays alpha-numeric characters at a specific location on the text screen.

**Syntax:** Locate <column number>, <line number>, <value>

Locate <column number>, <line number>, <numeric expression>

Locate <column number>, <line number>, "<string>"

[Example] Locate 1, 1, "AB"

### Parameters:

- line number: number from 1 to 7
- column number: number from 1 to 21
- value and numeric expression
- string: character string

### Description:

- This command displays values (including variable contents) or text at a specific location on the text screen. If there is a calculation input, that calculation result is displayed.
- The line is designated by a value from 1 to 7, while the column is designated by a value from 1 to 21.

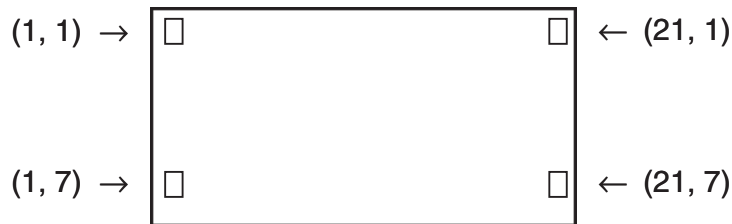

### Example: Cls ↵

Blue Locate 7, 1, "CASIO FX"

This program displays the text "CASIO FX" in blue, in the center of the screen.

- In some cases, the ClrText command should be executed before running the above program.

## Receive( / Send(

**Function:** This command receives data from and sends data to a connected device.

**Syntax:** Receive(<data>) / Send(<data>)

**Description:**

- This command receives data from and sends data to a connected device.
- The following types of data can be received (sent) by this command.
  - Individual values assigned to variables
  - Matrix data (all values - individual values cannot be specified)
  - List data (all values - individual values cannot be specified)

## OpenComport38k / CloseComport38k

**Function:** Opens and closes the 3-pin COM port (serial).

**Description:** See the Receive38k/Send38k command below.

## Receive38k / Send38k

**Function:** Executes data send and receive at a data rate of 38 kbps.

**Syntax:** Send38k <expression>

Receive38k { <variable name>  
<list name> }

**Description:**

- The OpenComport38k command must be executed before this command is executed.
- The CloseComport38k command must be executed after this command is executed.
- If this command is executed when the communication cable is not connected, program execution will continue without generating an error.

---

## ■ Conditional Jump Relational Operators (RELATNL)

=, ≠, >, <, ≥, ≤

**Function:** These relational operators are used in combination with the conditional jump command.

**Syntax:** <left side> <relational operator> <right side>

**Parameters:**

- left side/right side: variable (A to Z,  $r$ ,  $\theta$ ), numeric constant, variable expression (such as:  $A \times 2$ )
- relational operator: =, ≠, >, <, ≥, ≤

---

## ■ Strings

A string is a series of characters enclosed in double quotes. In a program, strings are used to specify display text. A string made up of numbers (like "123") or an expression (like " $x-1$ ") cannot be processed as a calculation.

To display a string at a specific location on the screen, use the Locate command (page 8-23).

- To include double quotes (") or a backslash (\) in a string, put a backslash (\) in front of the double quotes (") or backslash (\).

Example 1: To include Japan: "Tokyo" in a string

```
"Japan:\"Tokyo\""
```

Example 2: To include main\abc in a string

```
"main\\abc"
```

You can input a backslash from the menu that appears when you press **F6** (CHAR) **F2** (SYMBOL) in the **Program** mode, or from the String category of the catalog that appears when you press **SHIFT** **4** (CATALOG).

- You can assign strings to string memory (Str 1 through Str 20). For details about strings, see "String Memory" (page 2-8).
- You can use the "+" command (page 8-27) to connect strings inside of an argument.
- A function or command within a string function (Exp(, StrCmp(, etc.) is treated as a single character. For example, the "sin" function is treated as a single character.

### Exp(

**Function:** Converts a string to an expression, and executes the expression.

**Syntax:** Exp("<string>[")]

### Exp►Str(

**Function:** Converts a graph expression to a string and assigns it to the specified variable.

**Syntax:** Exp►Str(<formula>, <string variable name>[")]

**Description:** A graph expression ( $Y_n$ ,  $r$ ,  $X_t$ ,  $Y_t$ ,  $X$ ), recursion formula ( $a_n$ ,  $a_{n+1}$ ,  $a_{n+2}$ ,  $b_n$ ,  $b_{n+1}$ ,  $b_{n+2}$ ,  $c_n$ ,  $c_{n+1}$ ,  $c_{n+2}$ ), or function memory ( $f_n$ ) can be used as the first argument (<formula>).

### StrCmp(

**Function:** Compares "<string 1>" and "<string 2>" (character code comparison).

**Syntax:** StrCmp("<string 1>", "<string 2>[")]

**Description:** Compares two strings and returns one of the following values.

Returns 0 when "<string 1>" = "<string 2>".

Returns 1 when "<string 1>" > "<string 2>".

Returns -1 when "<string 1>" < "<string 2>".

**StrInv(**

**Function:** Inverts the sequence of a string.

**Syntax:** StrInv("<string>")]

**StrJoin(**

**Function:** Joins "<string 1>" and "<string 2>".

**Syntax:** StrJoin("<string 1>", "<string 2>")]

**Note:** The same result also can be achieved using the "+" command (page 8-27).

**StrLeft(**

**Function:** Copies a string up to the  $n$ th character from the left.

**Syntax:** StrLeft("<string>",  $n$ )] ( $0 \leq n \leq 9999$ ,  $n$  is a natural number)

**StrLen(**

**Function:** Returns the length of a string (the number of its characters).

**Syntax:** StrLen("<string>")]

**StrLwr(**

**Function:** Converts all the characters of a string to lower case.

**Syntax:** StrLwr("<string>")]

**StrMid(**

**Function:** Extracts from the  $n$ -th to the  $m$ -th character of a string.

**Syntax:** StrMid("<string>",  $n$  [, $m$ ]) ( $1 \leq n \leq 9999$ ,  $0 \leq m \leq 9999$ ,  $n$  and  $m$  are natural numbers)

**Description:** Omitting " $m$ " will extract from the  $n$ -th character to the end of the string.

**StrRight(**

**Function:** Copies a string up to the  $n$ th character from the right.

**Syntax:** StrRight("<string>",  $n$ )] ( $0 \leq n \leq 9999$ ,  $n$  is a natural number)



### StrRotate(

**Function:** Rotates the left side part and right side part of a string at the  $n$ th character.

**Syntax:** StrRotate("<string>", [, $n$ ]) ( $-9999 \leq n \leq 9999$ ,  $n$  is an integer)

**Description:** Rotation is to the left when " $n$ " is positive, and to the right when " $n$ " is negative. Omitting " $n$ " uses a default value of +1.

**Example:** StrRotate("abcde", 2) ..... Returns the string "cdeab".

### StrShift(

**Function:** Shifts a string left or right  $n$  characters.

**Syntax:** StrShift("<string>", [, $n$ ]) ( $-9999 \leq n \leq 9999$ ,  $n$  is an integer)

**Description:** Shift is to the left when " $n$ " is positive, and to the right when " $n$ " is negative. Omitting " $n$ " uses a default value of +1.

**Example:** StrShift("abcde", 2) ..... Returns the string "cde".

### StrSrc(

**Function:** Searches "<string 1>" starting from the specified point ( $n$ th character from beginning of string) to determine if it contains the data specified by "<string 2>". If the data is found, this command returns the location of the first character of "<string 2>", starting from the beginning of "<string 1>".

**Syntax:** StrSrc("<string 1>", "<string 2>"[, $n$ ]) ( $1 \leq n \leq 9999$ ,  $n$  is a natural number)

**Description:** Omitting the start point causes the search to start from the beginning of "<string 1>".

### StrUpr(

**Function:** Converts all the characters of a string to upper case.

**Syntax:** StrUpr("<string>[")]

### + (Joins two strings)

**Function:** Joins "<string 1>" and "<string 2>".

**Syntax:** "<string 1>"+ "<string 2>"

**Example:** "abc"+"de"→Str 1..... Assigns "abcde" to Str 1.

---

## ■ Other

### RclCapt

**Function:** Displays the contents specified by the capture memory number.

**Syntax:** RclCapt <capture memory number> (capture memory number: 1 to 20)

## 6. Using Calculator Functions in Programs

### ■ Using Color Commands in a Program

Color commands let you specify colors for on-screen lines, text, and other display elements. The following color commands are supported.

RUN Mode: Black, Blue, Red, Magenta, Green, Cyan, Yellow, ColorAuto, ColorClr

BASE Mode: Black, Blue, Red, Magenta, Green, Cyan, Yellow

- Color commands are input with the dialog box shown below, which appears when you press **(SHIFT) (5) (FORMAT) (1) (Color Command) (SHIFT) (5) (FORMAT)** in a BASE Mode program).

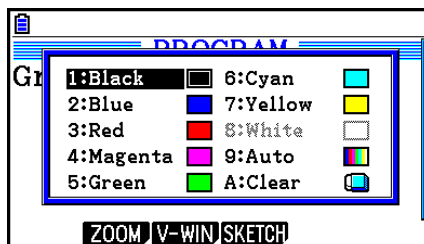

For example, the following key operation would input the color command Blue.

RUN Mode: **(SHIFT) (5) (FORMAT) (1) (Color Command) (2) (Blue)**

BASE Mode: **(SHIFT) (5) (FORMAT) (2) (Blue)**

- Except for ColorAuto and ColorClr, color commands can be used in a program in combination with the commands described below.

- Manual graph commands (page 5-25)

You can specify the color of a manual graph by placing a color command before "Graph Y=" or any other graph commands that can be input following **(SHIFT) (F4) (SKETCH) (F5) (GRAPH)**.

Example: Red Graph  $Y = X^2 - 1$

- Sketch Commands

You can specify the draw color of a figure drawn with a Sketch command by placing a color command before the following Sketch commands.

Tangent, Normal, Inverse, PlotOn, PlotChg, F-Line, Line, Circle, Vertical, Horizontal, Text, PxlOn, PxlChg, SketchNormal, SketchThick, SketchBroken, SketchDot, SketchThin

Example: Green SketchThin Circle 2, 1, 2

- List Command

You can specify a color for a list using the syntaxes shown below.

<color command> List  $n$  ( $n = 1$  to 26)

<color command> List "sub name"

You can specify a color for a specific element in a list using the syntaxes shown below.

<color command> List  $n$  [<element number>] ( $n = 1$  to 26)

<color command> List "sub name" [<element number>]

Example: Blue List 1

Red List 1 [3]

- The following commands can also be used together with color commands. Refer to the pages noted in parentheses for more information.  
 "<text>" ("Text Display", page 8-30), Locate (page 8-23), SetG-Color (page 8-32), Plot/Line-Color (page 8-32)
- Color commands also can be used when drawing graphs using **Graph** mode or **Statistics** mode functions in a program. For details, see "Using Graph Functions in a Program" (page 8-32) and "Using Statistical Calculations and Graphs in a Program" (page 8-35).

## ■ Using Paint Commands in a Program

Paint commands provide you with the means to add shading to graphs. The following are the two paint commands.

ColorNormal, ColorLighter

- Paint commands are input with the dialog box shown below, which appears when you press **SHIFT** **5** (FORMAT) **2** (Paint Command).

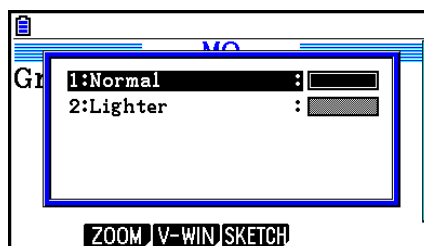

For example, the following key operation would input the paint command ColorLighter.

**SHIFT** **5** (FORMAT) **2** (Paint Command) **2** (Lighter)

- For details about syntaxes that can include paint commands, see "Using Statistical Calculations and Graphs in a Program" (page 8-35).



Executing this program produces the following result.

| [Rad] [Norm] |   | [d/c] [Real] PROG2 |  |
|--------------|---|--------------------|--|
| Ans          | 1 | 2                  |  |
| 1            | 1 | 2                  |  |
| 2            | 5 | 6                  |  |
| 3            | 3 | 4                  |  |

• **To calculate a scalar multiplication (\*Row)**

**Example 2** To calculate the product of Row 2 of the matrix in Example 1 and the scalar 4

The following is the syntax to use for this program.

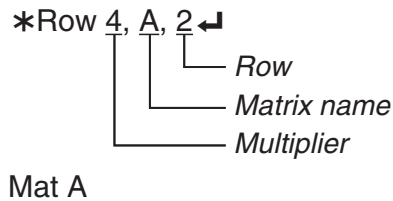

• **To calculate a scalar multiplication and add the results to another row (\*Row+)**

**Example 3** To calculate the product of Row 2 of the matrix in Example 1 and the scalar 4, then add the result to row 3

The following is the syntax to use for this program.

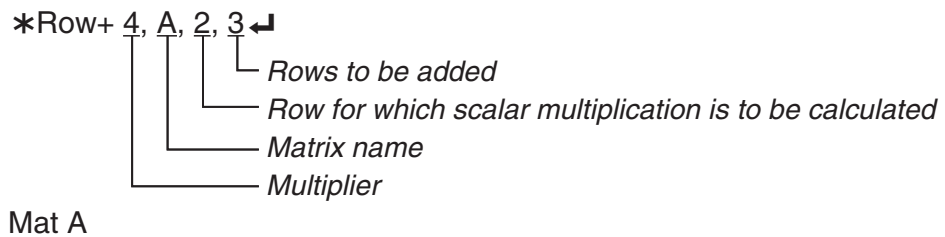

• **To add two rows (Row+)**

**Example 4** To add Row 2 to Row 3 of the matrix in Example 1

The following is the syntax to use for this program.

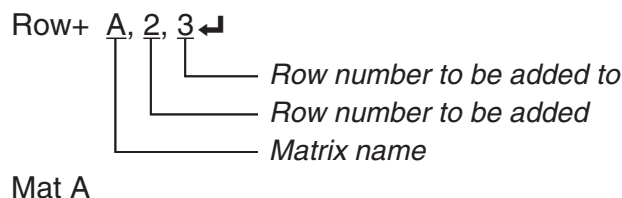

---

## ■ Using Graph Functions in a Program

You can incorporate graph functions into a program to draw complex graphs and to overlay graphs on top of each other. The following shows various types of syntax you need to use when programming with graph functions.

- V-Window                      View Window  $-5, 5, 1, -5, 5, 1$   $\leftarrow$
- Graph function input       $Y = \text{Type}$   $\leftarrow$  ..... Specifies graph type.  
                                         " $X^2 - 3$ "  $\rightarrow Y1^{*1}$   $\leftarrow$
- Graph Color                    SetG-Color Green, 1  $\leftarrow$
- Graph draw operation      DrawGraph

\*1 Input this Y1 with  $\boxed{\text{VAR}} \boxed{\text{F4}} (\text{GRAPH}) \boxed{\text{F1}} (Y) \boxed{1}$  (displayed as **Y1**). A Syntax ERROR will occur if you input "Y" with the calculator keys.

---

### ● Syntax of other graphing functions

- V-Window      View Window  $\langle X_{\min} \rangle, \langle X_{\max} \rangle, \langle X_{\text{scale}} \rangle, \langle Y_{\min} \rangle, \langle Y_{\max} \rangle, \langle Y_{\text{scale}} \rangle, \langle T\theta_{\min} \rangle, \langle T\theta_{\max} \rangle, \langle T\theta_{\text{ptch}} \rangle$   
                                         StoV-Win  $\langle \text{area of V-Win} \rangle$  ..... area: 1 to 6  
                                         RclV-Win  $\langle \text{area of V-Win} \rangle$  ..... area: 1 to 6
- Graph Color    SetG-Color  $\langle \text{color command} \rangle, \langle \text{area of graph} \rangle$  ..... area: 1 to 20  
                                         SetG-Color  $\langle \text{color command} \rangle, \langle \text{element of recursion formula} \rangle$   
                                         ..... element  $a_{n+1}, b_{n+1}$ , etc.
- Zoom            Factor  $\langle X \text{ factor} \rangle, \langle Y \text{ factor} \rangle$   
                                         ZoomAuto..... Non-parameter
- Pict             StoPict  $\langle \text{area of picture} \rangle$  ..... area: 1 to 20  
                                         StoPict "folder name\file name"  
                                         RclPict  $\langle \text{area of picture} \rangle$  ..... area: 1 to 20  
                                         RclPict "folder name\file name"
- Sketch           Plot/Line-Color  $\langle \text{color command} \rangle$   
                                         Plot  $\langle X\text{-coordinate} \rangle, \langle Y\text{-coordinate} \rangle$   
                                         PlotOn  $\langle X\text{-coordinate} \rangle, \langle Y\text{-coordinate} \rangle$   
                                         PlotOff  $\langle X\text{-coordinate} \rangle, \langle Y\text{-coordinate} \rangle$   
                                         PlotChg  $\langle X\text{-coordinate} \rangle, \langle Y\text{-coordinate} \rangle$   
                                         PxlOn  $\langle \text{line number} \rangle, \langle \text{column number} \rangle$   
                                         PxlOff  $\langle \text{line number} \rangle, \langle \text{column number} \rangle$   
                                         PxlChg  $\langle \text{line number} \rangle, \langle \text{column number} \rangle$   
                                         PxlTest( $\langle \text{line number} \rangle, \langle \text{column number} \rangle$ )]  
                                         Text  $\langle \text{line number} \rangle, \langle \text{column number} \rangle, \langle \text{text} \rangle$   
                                         Text  $\langle \text{line number} \rangle, \langle \text{column number} \rangle, \langle \text{expression} \rangle$   
                                         .....line number: 1 to 187, column number: 1 to 379

SketchThick <Sketch or Graph statement>  
 SketchBroken <Sketch or Graph statement>  
 SketchDot <Sketch or Graph statement>  
 SketchNormal <Sketch or Graph statement>  
 SketchThin <Sketch or Graph statement>  
 Tangent <function>, <X-coordinate>  
 Normal <function>, <X-coordinate>  
 Inverse <function>  
 Line ..... Non-parameter  
 F-Line <X-coordinate 1>, <Y-coordinate 1>, <X-coordinate 2>, <Y-coordinate 2>  
 Circle <center point X-coordinate>, <center point Y-coordinate>, <radius R value>  
 Vertical <X-coordinate>  
 Horizontal <Y-coordinate>

## ■ Using Background Picture in a Program

You can change the “Background” setting on the Setup screen from a program.

- Syntax when a background image is displayed

BG-Pict <area of picture> [,a] ... area: 1 to 20

BG-Pict "folder name\file name" [,a]

Appending “a” at the end loads V-Window values (that are saved with the image data) when the background image is displayed.

- Syntax when a background image is not displayed (or hidden)

BG-None

## ■ Using Dynamic Graph Functions in a Program

Using Dynamic Graph functions in a program makes it possible to perform repeated Dynamic Graph operations. Use the syntax like that shown in the example below when performing a Dynamic Graph draw operation inside a program.

- |                                         |                        |
|-----------------------------------------|------------------------|
| • Dynamic Graph formula input           | • Dynamic Graph range  |
| Y = Type ◀ ... Specifies graph type.    | 1 → D Start ◀          |
| "AX <sup>2</sup> – 3" → Y1*1 ◀          | 5 → D End ◀            |
| • Specifying the Dynamic Graph Variable | 1 → D pitch ◀          |
| D Var A ◀                               | • Graph draw operation |
|                                         | DrawDyna               |

\*1 Input this Y1 with  $\boxed{\text{VAR}} \boxed{\text{F4}} (\text{GRAPH}) \boxed{\text{F1}} (\text{Y}) \boxed{1}$  (displayed as **Y1**). A Syntax ERROR will occur if you input “Y” with the calculator keys.

---

## ■ Using Table & Graph Functions in a Program

Table & Graph functions in a program can generate numeric tables and perform graphing operations. The following shows various types of syntax you need to use when programming with Table & Graph functions.

- Table range setting
  - 1 → F Start ↵
  - 5 → F End ↵
  - 1 → F pitch ↵
- Numeric table generation
  - DispF-Tbl
- Graph draw operation
  - Connect type: DrawFTG-Con
  - Plot type: DrawFTG-Plt

---

## ■ Using Recursion Table & Graph Functions in a Program

Incorporating Recursion Table & Graph functions in a program lets you generate numeric tables and perform graphing operations. The following shows various types of syntax you need to use when programming with Recursion Table & Graph functions.

- Recursion formula input
  - $a_{n+1}$  Type ↵ .... Specifies recursion type.
  - " $3a_n + 2$ " →  $a_{n+1}$  ↵
  - " $4b_n + 6$ " →  $b_{n+1}$  ↵
- Table range setting
  - 1 → R Start ↵
  - 5 → R End ↵
  - 1 →  $a_0$  ↵
  - 2 →  $b_0$  ↵
  - 1 →  $a_n$  Start ↵
  - 3 →  $b_n$  Start ↵
- Numeric table generation
  - DispR-Tbl
- Graph draw operation
  - Connect type: DrawR-Con, DrawRΣ-Con
  - Plot type: DrawR-Plt, DrawRΣ-Plt
- Statistical convergence/divergence graph (WEB graph)
  - DrawWeb  $a_{n+1}$ , 10



---

## ■ Using List Sort Functions in a Program

These functions let you sort data in lists into ascending or descending order.

- Ascending order

SortA (List 1, List 2, List 3)  
└── Lists to be sorted (up to six can be specified)

- Descending order

SortD (List 1, List 2, List 3)  
└── Lists to be sorted (up to six can be specified)

---

## ■ Using Statistical Calculations and Graphs in a Program

Including statistical calculations and graphing operations in a program lets you calculate and graph statistical data.

---

### • To set conditions and draw a statistical graph

Following a StatGraph command (“S-Gph1”, “S-Gph2”, or “S-Gph3”), you must specify the following graph conditions:

- Graph draw/non-draw status (DrawOn/DrawOff)
- Graph Type
- x-axis data location (list name)
- y-axis data location (list name)
- Frequency data location (1 or list name)
- Mark Type
- ColorLink setting (X&Y, OnlyX, OnlyY, On, Off, X&Freq)
- Graph Color setting (one of the seven colors\* or ColorAuto)

#### When “Pie” is specified for the Graph Type:

- Display setting (% or Data)
- Percent data storage list specification (None or list name)

#### When “Pie” or “Hist” is specified for the Graph Type:

- Area color setting (one of the seven colors\* or ColorAuto)
- Paint style setting (ColorNormal, ColorLighter)
- Border color setting (one of the seven colors\* or ColorClr)

**When “MedBox” is specified for the Graph Type:**

- Outliers On/Off setting
- Box color setting (one of the seven colors\*)
- Whisker color setting (one of the seven colors\*)
- Outliers color setting (one of the seven colors\*)
- Box inside color setting (one of the seven colors\* or ColorAuto)
- Box inside paint setting (ColorNormal, ColorLighter)

**When “Bar” is specified for the Graph Type:**

- First bar graph data (list name)
- Second and third bar graph data (list name)
- Bar graph orientation (Length or Horizontal)
- Area color settings for each data (one of the seven colors\* or ColorAuto)
- Paint style settings for each data (ColorNormal, ColorLighter)
- Border color settings for each data (one of the seven colors\* or ColorClr)

\* Black, Blue, Red, Magenta, Green, Cyan, Yellow

The graph conditions that are required depends on the graph type. See “General Graph Settings” (page 6-2).

- The following is a typical graph condition specification for a scatter diagram or *xyLine* graph.

S-Gph1 DrawOn, Scatter, List 1, List 2, 1, Square, ColorLinkOff, ColorAuto

In the case of an *xy* line graph, replace “Scatter” in the above specification with “*xyLine*”.

- The following is a typical graph condition specification for a normal probability plot.

S-Gph1 DrawOn, NPPlot, List 1, Square, ColorLinkOff, Blue

- The following is a typical graph condition specification for a histogram.

S-Gph1 DrawOn, Hist, List 1, List 2, ColorLinkOff, Blue ColorLighter

- The following is a typical graph condition specification for a broken graph.

S-Gph1 DrawOn, Broken, List 1, List 2, ColorLinkOff, Blue

- The following is a typical graph condition specification for a normal distribution graph.

S-Gph1 DrawOn, N-Dist, List 1, List 2, Blue

- The following is a typical graph condition specification for a med-box graph.

S-Gph1 DrawOn, MedBox, List 1, 1, 1, Yellow, Green, Blue, Red

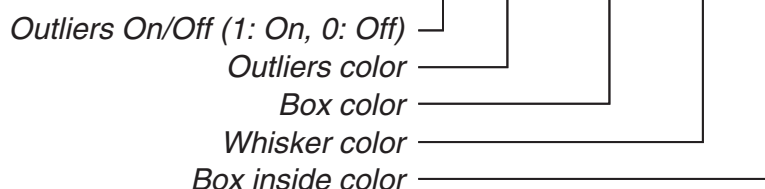

- The following is a typical graph condition specification for a regression graph.

S-Gph1 DrawOn, Linear, List 1, List 2, List 3, Blue

The same format can be used for the following types of graphs, by simply replacing “Linear” in the above specification with the applicable graph type.

|                           |         |                              |                            |
|---------------------------|---------|------------------------------|----------------------------|
| Linear Regression .....   | Linear  | Logarithmic Regression ..... | Log                        |
| Med-Med.....              | Med-Med | Exponential Regression ..... | ExpReg(a·e <sup>b</sup> x) |
| Quadratic Regression .... | Quad    |                              | ExpReg(a·b <sup>x</sup> )  |
| Cubic Regression .....    | Cubic   | Power Regression .....       | Power                      |
| Quartic Regression .....  | Quart   |                              |                            |

- The following is a typical graph condition specification for a sinusoidal regression graph.

S-Gph1 DrawOn, Sinusoidal, List 1, List 2, Blue

- The following is a typical graph condition specification for a logistic regression graph.

S-Gph1 DrawOn, Logistic, List 1, List 2, Blue

- The following is a typical graph condition specification for a pie chart.

S-Gph1 DrawOn, Pie, List 1, %, None, ColorLinkOff, ColorAuto ColorLighter, ColorClr

- The following is a typical graph condition specification for a bar graph.

S-Gph1 DrawOn, Bar, List 1, None, None, StickLength, ColorLinkOff, Blue ColorLighter, Black, Red ColorLighter, Black, Green ColorLighter, Black

To draw a statistical graph, insert the “DrawStat” command following the graph condition specification line.

ClrGraph ⌘

S-Wind Auto ⌘

{1, 2, 3} → List 1 ⌘

{1, 2, 3} → List 2 ⌘

S-Gph1 DrawOn, Scatter, List 1, List 2, 1, Square, ColorLinkOff, ColorAuto ⌘

DrawStat

## ■ Using Distribution Graphs in a Program

Special commands are used to draw distribution graphs in a program.

### • To draw a normal cumulative distribution graph

DrawDistNorm <Lower>, <Upper> [,σ, μ]

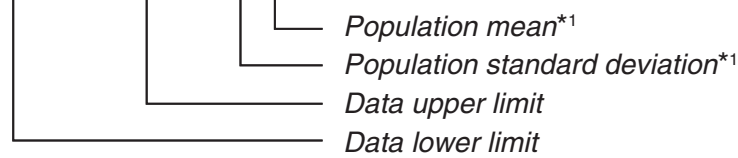

\*<sup>1</sup> This can be omitted. Omitting these items performs the calculation using  $\sigma = 1$  and  $\mu = 0$ .

$$p = \frac{1}{\sqrt{2\pi}\sigma} \int_{Lower}^{Upper} e^{-\frac{(x-\mu)^2}{2\sigma^2}} dx \quad ZLow = \frac{Lower - \mu}{\sigma} \quad ZUp = \frac{Upper - \mu}{\sigma}$$

- Executing DrawDistNorm performs the above calculation in accordance with the specified conditions and draws the graph. At this time the  $ZLow \leq x \leq ZUp$  region on the graph is filled in.

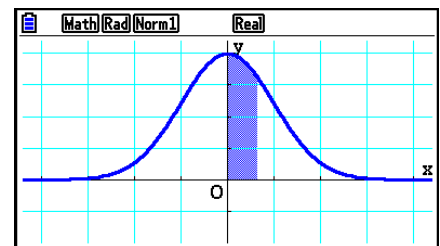

- At the same time, the  $p$ , ZLow, and ZUp calculation result values are assigned respectively to variables  $p$ , ZLow, and ZUp, and  $p$  is assigned to Ans.

### • To draw a Student- $t$ cumulative distribution graph

DrawDistT <Lower>, <Upper>, <df>

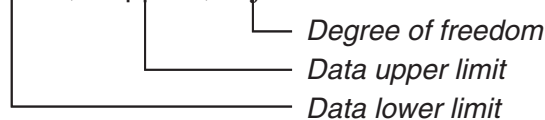

$$p = \int_{Lower}^{Upper} \frac{\Gamma\left(\frac{df+1}{2}\right)}{\Gamma\left(\frac{df}{2}\right)} \times \frac{\left(1 + \frac{x^2}{df}\right)^{-\frac{df+1}{2}}}{\sqrt{\pi \times df}} dx \quad tLow = Lower \quad tUp = Upper$$

- Executing DrawDistT performs the above calculation in accordance with the specified conditions and draws the graph. At this time the  $Lower \leq x \leq Upper$  region on the graph is filled in.
- At the same time, the  $p$  calculation result value and the Lower and Upper input values are assigned respectively to variables  $p$ , tLow, and tUp, and  $p$  is assigned to Ans.

---

- **To draw a  $\chi^2$  cumulative distribution graph**

DrawDistChi <Lower>, <Upper>, <df>

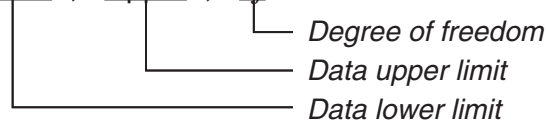

$$p = \int_{Lower}^{Upper} \frac{1}{\Gamma\left(\frac{df}{2}\right)} \times \left(\frac{1}{2}\right)^{\frac{df}{2}} \times x^{\left(\frac{df}{2}-1\right)} \times e^{-\frac{x}{2}} dx$$

- Executing DrawDistChi performs the above calculation in accordance with the specified conditions and draws the graph. At this time the  $Lower \leq x \leq Upper$  region on the graph is filled in.
  - At the same time, calculation result is assigned to variables  $p$  and Ans.
- 

- **To draw an  $F$  cumulative distribution graph**

DrawDistF <Lower>, <Upper>, <ndf>, <ddf>

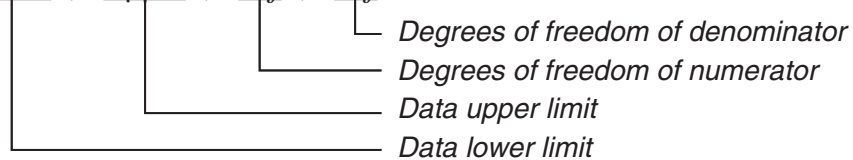

$$p = \int_{Lower}^{Upper} \frac{\Gamma\left(\frac{ndf + ddf}{2}\right)}{\Gamma\left(\frac{ndf}{2}\right) \times \Gamma\left(\frac{ddf}{2}\right)} \times \left(\frac{ndf}{ddf}\right)^{\frac{ndf}{2}} \times x^{\left(\frac{ndf}{2}-1\right)} \times \left(1 + \frac{ndf \times x}{ddf}\right)^{-\frac{ndf + ddf}{2}} dx$$

- Executing DrawDistF performs the above calculation in accordance with the specified conditions and draws the graph. At this time the  $Lower \leq x \leq Upper$  region on the graph is filled in.
- At the same time, calculation result  $p$  is assigned to variables  $p$  and Ans.

## ■ Performing Statistical Calculations in a Program

- Single-variable statistical calculation

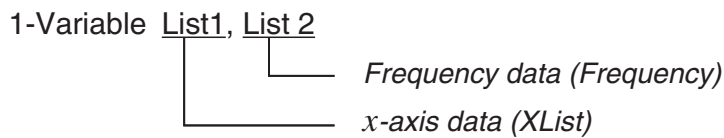

- Paired-variable statistical calculation

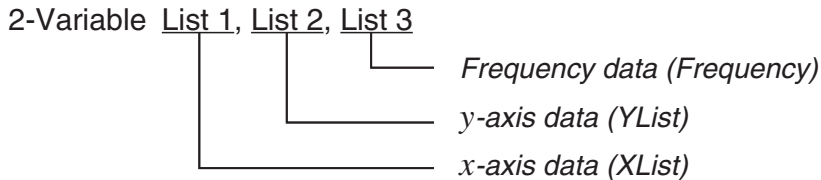

- Regression statistical calculation

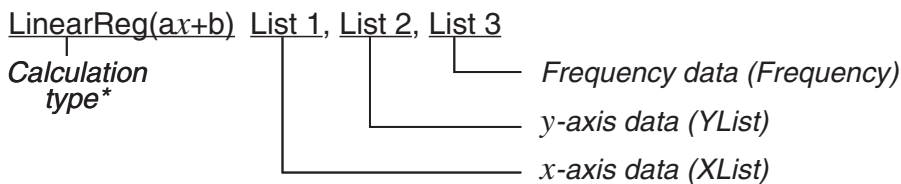

\* Any one of the following can be specified as the calculation type.

- LinearReg(ax+b).....linear regression ( $ax+b$  type)
- LinearReg(a+bx).....linear regression ( $a+bx$  type)
- Med-MedLine .....Med-Med calculation
- QuadReg .....quadratic regression
- CubicReg.....cubic regression
- QuartReg .....quartic regression
- LogReg .....logarithmic regression
- ExpReg( $a \cdot e^{bx}$ ).....exponential regression ( $a \cdot e^{bx}$  type)
- ExpReg( $a \cdot b^x$ ).....exponential regression ( $a \cdot b^x$  type)
- PowerReg .....power regression

- Sinusoidal regression statistical calculation

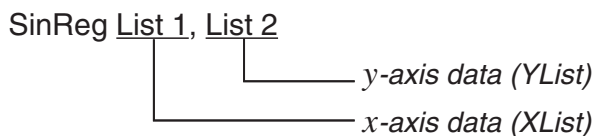

- Logistic regression statistical calculation

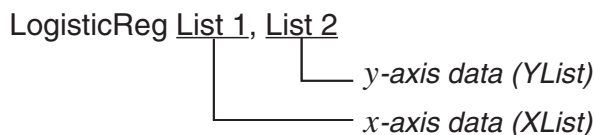

## ■ Performing Distribution Calculations in a Program

- The following values are substituted whenever any of the arguments enclosed in brackets ([ ]) are omitted.  
 $\sigma=1$ ,  $\mu=0$ , tail=L (Left)
- For the calculation formula of each probability density function, see “Statistic Formula” (page 6-69).

### • Normal Distribution

**NormPD(**: Returns the normal probability density ( $p$  value) for the specified data.

**Syntax:** NormPD( $x$ [,  $\sigma$ ,  $\mu$ ])

- A single value or a list can be specified for  $x$ . Calculation result  $p$  is assigned to variables  $p$  and Ans (ListAns when  $x$  is a list).

**NormCD(**: Returns the normal cumulative distribution ( $p$  value) for the specified data.

**Syntax:** NormCD(Lower, Upper[,  $\sigma$ ,  $\mu$ ])

- Single values or lists can be specified for Lower and Upper. Calculation results  $p$ , ZLow, and ZUp are assigned respectively to variables  $p$ , ZLow, and ZUp. Calculation result  $p$  also is assigned to Ans (ListAns when Lower and Upper are lists).

**InvNormCD(**: Returns the inverse normal cumulative distribution (lower and/or upper value(s)) for the specified  $p$  value.

**Syntax:** InvNormCD(["L(or -1) or R(or 1) or C(or 0)", ] $p$ [,  $\sigma$ ,  $\mu$ ])  
tail (Left, Right, Central)

- A single value or a list can be specified for  $p$ . Calculation results are output in accordance with the tail setting as described below.

tail = Left

The Upper value is assigned to variables  $x1$ InvN and Ans (ListAns when  $p$  is a list).

tail = Right

The Lower value is assigned to variables  $x1$ InvN and Ans (ListAns when  $p$  is a list).

tail = Central

The Lower and Upper values are assigned respectively to variables  $x1$ InvN and  $x2$ InvN. Lower only is assigned to Ans (ListAns when  $p$  is a list).

---

## • Student- $t$ Distribution

**tPD(**: Returns the Student- $t$  probability density ( $p$  value) for the specified data.

**Syntax:** tPD( $x$ ,  $df$  [])

- A single value or a list can be specified for  $x$ . Calculation result  $p$  is assigned to variables  $p$  and Ans (ListAns when  $x$  is a list).

**tCD(**: Returns the Student- $t$  cumulative distribution ( $p$  value) for the specified data.

**Syntax:** tCD(Lower,Upper, $df$  [])

- Single values or lists can be specified for Lower and Upper. Calculation results  $p$ , tLow, and tUp are assigned respectively to variables  $p$ , tLow, and tUp. Calculation result  $p$  also is assigned to Ans (ListAns when Lower and Upper are lists).

**InvTCD(**: Returns the inverse Student- $t$  cumulative distribution (Lower value) for the specified  $p$  value.

**Syntax:** InvTCD( $p$ , $df$  [])

- A single value or a list can be specified for  $p$ . The Lower value is assigned to the  $x$ Inv and Ans variables (ListAns when  $p$  is a list).

---

## • $\chi^2$ Distribution

**ChiPD(**: Returns the  $\chi^2$  probability density ( $p$  value) for the specified data.

**Syntax:** ChiPD( $x$ , $df$  [])

- A single value or a list can be specified for  $x$ . Calculation result  $p$  is assigned to variables  $p$  and Ans (ListAns when  $x$  is a list).

**ChiCD(**: Returns the  $\chi^2$  cumulative distribution ( $p$  value) for the specified data.

**Syntax:** ChiCD(Lower,Upper, $df$  [])

- Single values or lists can be specified for Lower and Upper. Calculation result  $p$  is assigned to variables  $p$  and Ans (ListAns when Lower and Upper are lists).

**InvChiCD(**: Returns the inverse  $\chi^2$  cumulative distribution (Lower value) for the specified  $p$  value.

**Syntax:** InvChiCD( $p$ , $df$  [])

- A single value or a list can be specified for  $p$ . The Lower value is assigned to the  $x$ Inv and Ans variables (ListAns when  $p$  is a list).



---

## • *F* Distribution

**FPD(**: Returns the *F* probability density (*p* value) for the specified data.

**Syntax:** FPD(*x*,*ndf*,*ddf* [])

- A single value or a list can be specified for *x*. Calculation result *p* is assigned to variables *p* and Ans (ListAns when *x* is a list).

**FCD(**: Returns the *F* cumulative distribution (*p* value) for the specified data.

**Syntax:** FCD(Lower,Upper,*ndf*,*ddf* [])

- Single values or lists can be specified for Lower and Upper. Calculation result *p* is assigned to variables *p* and Ans (ListAns when Lower and Upper are lists).

**InvFCD(**: Returns the inverse *F* cumulative distribution (Lower value) for the specified data.

**Syntax:** InvFCD(*p*,*ndf*,*ddf* [])

- A single value or a list can be specified for *p*. The Lower value is assigned to the *x*Inv and Ans variables (ListAns when *p* is a list).

---

## • Binomial Distribution

**BinomialPD(**: Returns the binomial probability (*p* value) for the specified data.

**Syntax:** BinomialPD([*x*,]*n*,*P*[])

- A single value or a list can be specified for *x*. Calculation result *p* is assigned to variables *p* and Ans (ListAns when *x* is a list).

**BinomialCD(**: Returns the binomial cumulative distribution (*p* value) for the specified data.

**Syntax:** BinomialCD([[Lower,] Upper,]*n*,*P*[])

- Single values or lists can be specified for Lower and Upper. Calculation result *p* is assigned to variables *p* and Ans (or ListAns).

**InvBinomialCD(**: Returns the inverse binomial cumulative distribution for the specified data.

**Syntax:** InvBinomialCD(*p*,*n*,*P*[])

- A single value or a list can be specified for *p*. The calculation result X value is assigned to the *x*Inv and Ans variables (ListAns when *p* is a list).

---

## • Poisson Distribution

**PoissonPD(**: Returns the Poisson probability ( $p$  value) for the specified data.

**Syntax:** PoissonPD( $x$ ,  $\lambda$ [])

- A single value or a list can be specified for  $x$ . Calculation result  $p$  is assigned to variables  $p$  and Ans (ListAns when  $x$  is a list).

**PoissonCD(**: Returns the Poisson cumulative distribution ( $p$  value) for the specified data.

**Syntax:** PoissonCD([Lower,] Upper,  $\lambda$ [])

- Single values or lists can be specified for Lower and Upper. Calculation result  $p$  is assigned to variables  $p$  and Ans (or ListAns).

**InvPoissonCD(**: Returns the inverse Poisson cumulative distribution for the specified data.

**Syntax:** InvPoissonCD( $p$ ,  $\lambda$ [])

- A single value or a list can be specified for  $p$ . The calculation result X value is assigned to the  $x$ Inv and Ans variables (ListAns when  $p$  is a list).

---

## • Geometric Distribution

**GeoPD(**: Returns the geometric probability ( $p$  value) for the specified data.

**Syntax:** GeoPD( $x$ , P[])

- A single value or a list can be specified for  $x$ . Calculation result  $p$  is assigned to variables  $p$  and Ans (ListAns when  $x$  is a list).

**GeoCD(**: Returns the geometric cumulative distribution ( $p$  value) for the specified data.

**Syntax:** GeoCD([Lower,] Upper,P[])

- Single values or lists can be specified for Lower and Upper. Calculation result  $p$  is assigned to variables  $p$  and Ans (or ListAns).

**InvGeoCD(**: Returns the inverse geometric cumulative distribution for the specified data.

**Syntax:** InvGeoCD( $p$ ,P[])

- A single value or a list can be specified for  $p$ . The calculation result is assigned to the  $x$ Inv and Ans variables (ListAns when  $p$  is a list).

---

## • Hypergeometric Distribution

**HypergeoPD(**: Returns the hypergeometric probability ( $p$  value) for the specified data.

**Syntax:** HypergeoPD( $x, n, M, N[ ]$ )

- A single value or a list can be specified for  $x$ . Calculation result  $p$  is assigned to variables  $p$  and Ans (ListAns when  $x$  is a list).

**HypergeoCD(**: Returns the hypergeometric cumulative distribution ( $p$  value) for the specified data.

**Syntax:** HypergeoCD([Lower,] Upper,  $n, M, N[ ]$ )

- Single values or lists can be specified for Lower and Upper. Calculation result  $p$  is assigned to variables  $p$  and Ans (or ListAns).

**InvHypergeoCD(**: Returns the inverse hypergeometric cumulative distribution for the specified data.

**Syntax:** InvHypergeoCD( $p, n, M, N[ ]$ )

- A single value or a list can be specified for  $p$ . The calculation result  $X$  value is assigned to the  $xInv$  and Ans variables (ListAns when  $p$  is a list).

---

## ■ Using the TEST Command to Execute a Command in a Program

- The following are the specifications ranges for the “ $\mu$  condition” argument of the command.

“<” or -1 when  $\mu < \mu_0$

“≠” or 0 when  $\mu \neq \mu_0$

“>” or 1 when  $\mu > \mu_0$

The above also apply for the “ $p$  condition” and “ $\beta$ & $p$  condition” specification methods.

- For explanations of arguments, see “Tests” (page 6-33) and “Input and Output Terms of Tests, Confidence Interval, and Distribution” (page 6-66).
- For the calculation formula of each command, see “Statistic Formula” (page 6-69).

---

## • Z Test

**OneSampleZTest:** Executes 1-sample  $Z$ -test calculation.

**Syntax:** OneSampleZTest “ $\mu$  condition”,  $\mu_0, \sigma, \bar{x}, n$

**Output Values:**  $z, p, \bar{x}, n$  are assigned respectively to variables  $z, p, \bar{x}, n$  and to ListAns elements 1 through 4.

**Syntax:** OneSampleZTest “ $\mu$  condition”,  $\mu_0, \sigma, \text{List}[, \text{Freq}]$

**Output Values:**  $z, p, \bar{x}, s_x, n$  are assigned respectively to variables  $z, p, \bar{x}, s_x, n$  and to ListAns elements 1 through 5.

|                        |                                                                                                                                                                                                                                     |
|------------------------|-------------------------------------------------------------------------------------------------------------------------------------------------------------------------------------------------------------------------------------|
| <b>TwoSampleZTest:</b> | Executes 2-sample $Z$ -test calculation.                                                                                                                                                                                            |
| <b>Syntax:</b>         | TwoSampleZTest " $\mu_1$ condition", $\sigma_1$ , $\sigma_2$ , $\bar{x}_1$ , $n_1$ , $\bar{x}_2$ , $n_2$                                                                                                                            |
| <b>Output Values:</b>  | $z$ , $p$ , $\bar{x}_1$ , $\bar{x}_2$ , $n_1$ , $n_2$ are assigned respectively to variables $z$ , $p$ , $\bar{x}_1$ , $\bar{x}_2$ , $n_1$ , $n_2$ and to ListAns elements 1 through 6.                                             |
| <b>Syntax:</b>         | TwoSampleZTest " $\mu_1$ condition", $\sigma_1$ , $\sigma_2$ , List1, List2[, Freq1 [, Freq2]]                                                                                                                                      |
| <b>Output Values:</b>  | $z$ , $p$ , $\bar{x}_1$ , $\bar{x}_2$ , $s_{x1}$ , $s_{x2}$ , $n_1$ , $n_2$ are assigned respectively to variables $z$ , $p$ , $\bar{x}_1$ , $\bar{x}_2$ , $s_{x1}$ , $s_{x2}$ , $n_1$ , $n_2$ and to ListAns elements 1 through 8. |
| <b>OnePropZTest:</b>   | Executes 1-proportion $Z$ -test calculation.                                                                                                                                                                                        |
| <b>Syntax:</b>         | OnePropZTest " $p$ condition", $p_0$ , $x$ , $n$                                                                                                                                                                                    |
| <b>Output Values:</b>  | $z$ , $p$ , $\hat{p}$ , $n$ are assigned respectively to variables $z$ , $p$ , $\hat{p}$ , $n$ and to ListAns elements 1 through 4.                                                                                                 |
| <b>TwoPropZTest:</b>   | Executes 2-proportion $Z$ -test calculation.                                                                                                                                                                                        |
| <b>Syntax:</b>         | TwoPropZTest " $p_1$ condition", $x_1$ , $n_1$ , $x_2$ , $n_2$                                                                                                                                                                      |
| <b>Output Values:</b>  | $z$ , $p$ , $\hat{p}_1$ , $\hat{p}_2$ , $\hat{p}$ , $n_1$ , $n_2$ are assigned respectively to variables $z$ , $p$ , $\hat{p}_1$ , $\hat{p}_2$ , $\hat{p}$ , $n_1$ , $n_2$ and to ListAns elements 1 through 7.                     |

## • $t$ Test

|                        |                                                                                                                                                                                                                                                                                                                                                                                                                                                 |
|------------------------|-------------------------------------------------------------------------------------------------------------------------------------------------------------------------------------------------------------------------------------------------------------------------------------------------------------------------------------------------------------------------------------------------------------------------------------------------|
| <b>OneSampleTTest:</b> | Executes 1-sample $t$ -test calculation.                                                                                                                                                                                                                                                                                                                                                                                                        |
| <b>Syntax:</b>         | OneSampleTTest " $\mu$ condition", $\mu_0$ , $\bar{x}$ , $s_x$ , $n$<br>OneSampleTTest " $\mu$ condition", $\mu_0$ , List[, Freq]                                                                                                                                                                                                                                                                                                               |
| <b>Output Values:</b>  | $t$ , $p$ , $\bar{x}$ , $s_x$ , $n$ are assigned respectively to the variables with the same names and to ListAns elements 1 through 5.                                                                                                                                                                                                                                                                                                         |
| <b>TwoSampleTTest:</b> | Executes 2-sample $t$ -test calculation.                                                                                                                                                                                                                                                                                                                                                                                                        |
| <b>Syntax:</b>         | TwoSampleTTest " $\mu_1$ condition", $\bar{x}_1$ , $s_{x1}$ , $n_1$ , $\bar{x}_2$ , $s_{x2}$ , $n_2$ [,Pooled condition]<br>TwoSampleTTest " $\mu_1$ condition", List1, List2, [, Freq1[, Freq2[, Pooled condition ]]]                                                                                                                                                                                                                          |
| <b>Output Values:</b>  | When Pooled condition = 0, $t$ , $p$ , $df$ , $\bar{x}_1$ , $\bar{x}_2$ , $s_{x1}$ , $s_{x2}$ , $n_1$ , $n_2$ are assigned respectively to the variables with the same names and to ListAns elements 1 through 9.<br>When Pooled condition = 1, $t$ , $p$ , $df$ , $\bar{x}_1$ , $\bar{x}_2$ , $s_{x1}$ , $s_{x2}$ , $s_p$ , $n_1$ , $n_2$ are assigned respectively to the variables with the same names and to ListAns elements 1 through 10. |
| <b>Note:</b>           | Specify 0 when you want to turn off the Pooled condition and 1 when you want to turn it on. Omitting the input is treated as Pooled condition off.                                                                                                                                                                                                                                                                                              |
| <b>LinRegTTest:</b>    | Executes linear regression $t$ -test calculation.                                                                                                                                                                                                                                                                                                                                                                                               |
| <b>Syntax:</b>         | LinRegTTest " $\beta$ & $\rho$ condition", XList, YList[, Freq]                                                                                                                                                                                                                                                                                                                                                                                 |
| <b>Output Values:</b>  | $t$ , $p$ , $df$ , $a$ , $b$ , $s$ , $r$ , $r^2$ are assigned respectively to the variables with the same names and to ListAns elements 1 through 8.                                                                                                                                                                                                                                                                                            |

---

## • $\chi^2$ Test

**ChiGOFTest:** Executes a chi-square goodness of fit test.

**Syntax:** ChiGOFTest List 1, List 2, df, List 3  
(List 1 is the Observed list, List 2 is the Expected list, and List 3 is the CNTRB list.)

**Output Values:**  $\chi^2$ ,  $p$ ,  $df$  are assigned respectively to the variables with the same names and to ListAns elements 1 through 3. The CNTRB list is stored in List 3.

**ChiTest:** Executes a chi-square test.

**Syntax:** ChiTest MatA, MatB  
(MatA is the Observed matrix and MatB is the Expected matrix.)

**Output Values:**  $\chi^2$ ,  $p$ ,  $df$  are assigned respectively to the variables with the same names and to ListAns elements 1 through 3. The Expected matrix is assigned to MatB.

---

## • $F$ Test

**TwoSampleFTest:** Executes 2-sample  $F$ -test calculation.

**Syntax:** TwoSampleFTest " $\sigma_1$  condition",  $s_{x1}$ ,  $n_1$ ,  $s_{x2}$ ,  $n_2$

**Output Values:**  $F$ ,  $p$ ,  $s_{x1}$ ,  $s_{x2}$ ,  $n_1$ ,  $n_2$  are assigned respectively to the variables with the same names and to ListAns elements 1 through 6.

**Syntax:** TwoSampleFTest " $\sigma_1$  condition", List1, List2, [, Freq1 [, Freq2]]

**Output Values:**  $F$ ,  $p$ ,  $\bar{x}_1$ ,  $\bar{x}_2$ ,  $s_{x1}$ ,  $s_{x2}$ ,  $n_1$ ,  $n_2$  are assigned respectively to the variables with the same names and to ListAns elements 1 through 8.

---

## • ANOVA

**OneWayANOVA:** Executes one-factor ANOVA analysis of variance.

**Syntax:** OneWayANOVA List1, List2  
(List1 is Factor list (A) and List2 is the Dependent list.)

**Output Values:** Adf, Ass, Ams, AF, Ap, ERRdf, ERRss, ERRms are assigned respectively to variables Adf, SSa, MSa, Fa, pa, Edf, SSe, MSe.

Also, output values are assigned to MatAns as shown below.

$$\text{MatAns} = \begin{bmatrix} Adf & Ass & Ams & AF & Ap \\ ERRdf & ERRss & ERRms & 0 & 0 \end{bmatrix}$$

**TwoWayANOVA:** Executes two-factor ANOVA analysis of variance.

**Syntax:** TwoWayANOVA List1, List2, List3  
(List1 is Factor list (A), List2 is Factor list (B), and List3 is the Dependent list.)

**Output Values:** Adf, Ass, Ams, AF, Ap, Bdf, Bss, Bms, BF, Bp, ABdf, ABss, ABms, ABF, ABp, ERRdf, ERRss, ERRms are assigned respectively to variables Adf, SSa, MSa, Fa, pa, Bdf, SSb, MSb, Fb, pb, ABdf, SSab, MSab, Fab, pab, Edf, SSe, MSe.

Also, output values are assigned to MatAns as shown below.

$$\text{MatAns} = \begin{bmatrix} Adf & Ass & Ams & AF & Ap \\ Bdf & Bss & Bms & BF & Bp \\ ABdf & ABss & ABms & ABF & ABp \\ ERRdf & ERRss & ERRms & 0 & 0 \end{bmatrix}$$

## ■ Performing Financial Calculations in a Program

### • Setup Commands

- Date Mode Setting for Financial Calculations
  - DateMode365..... 365 days
  - DateMode360..... 360 days
- Payment Period Setting
  - PmtBgn..... Start of period
  - PmtEnd..... End of period
- Bond Calculation Payment Periods
  - PeriodsAnnual..... Annual
  - PeriodsSemi..... Semiannual

### • Financial Calculation Commands

For the meaning of each argument, see “Chapter 7 Financial Calculation”.

#### • Simple Interest

**Smpl\_SI:** Returns the interest based on simple interest calculation.

**Syntax:** Smpl\_SI(*n*, *I%*, *PV*)

**Smpl\_SFV:** Returns the total of principal and interest based on simple interest calculation.

**Syntax:** Smpl\_SFV(*n*, *I%*, *PV*)

## • Compound Interest

### Note:

- P/Y and C/Y can be omitted for all compound interest calculations. When they are omitted, calculations are performed using P/Y=12 and C/Y=12.
- If you perform a calculation that uses a compound interest function (Cmpd\_n(), Cmpd\_I%(), Cmpd\_PV(), Cmpd\_PMT(), Cmpd\_FV()), the argument(s) you input and the calculation results will be saved to the applicable variables (*n*, *I%*, *PV*, etc.). If you perform a calculation that uses any other type of financial calculation function, the argument and calculation results are not assigned to variables.

**Cmpd\_n:** Returns the number of compound periods.

**Syntax:** Cmpd\_n(*I%*, PV, PMT, FV, P/Y, C/Y)

**Cmpd\_I%:** Returns the annual interest.

**Syntax:** Cmpd\_I%(*n*, PV, PMT, FV, P/Y, C/Y)

**Cmpd\_PV:** Returns the present value (loan amount for installment payments, principal for savings).

**Syntax:** Cmpd\_PV(*n*, *I%*, PMT, FV, P/Y, C/Y)

**Cmpd\_PMT:** Returns equal input/output values (payment amounts for installment payments, deposit amounts for savings) for a fixed period.

**Syntax:** Cmpd\_PMT(*n*, *I%*, PV, FV, P/Y, C/Y)

**Cmpd\_FV:** Returns the final input/output amount or total principal and interest.

**Syntax:** Cmpd\_FV(*n*, *I%*, PV, PMT, P/Y, C/Y)

## • Cash Flow (Investment Appraisal)

**Cash\_NPV:** Returns the net present value.

**Syntax:** Cash\_NPV(*I%*, Csh)

**Cash\_IRR:** Returns the internal rate of return.

**Syntax:** Cash\_IRR(Csh)

**Cash\_PBP:** Returns the payback period.

**Syntax:** Cash\_PBP(*I%*, Csh)

**Cash\_NFV:** Returns the net future value.

**Syntax:** Cash\_NFV(*I%*, Csh)

## • Amortization

**Amt\_BAL:** Returns the remaining principal balance following payment PM2.

**Syntax:** Amt\_BAL(PM1, PM2, *I%*, PV, PMT, P/Y, C/Y)

**Amt\_INT:** Returns the interest paid for payment PM1.

**Syntax:** Amt\_INT(PM1, PM2, *I%*, PV, PMT, P/Y, C/Y)

**Amt\_PRN:** Returns the principal and interest paid for payment PM1.

**Syntax:** Amt\_PRN(PM1, PM2, *I%*, PV, PMT, P/Y, C/Y)

**Amt\_ΣINT:** Returns the total principal and interest paid from payment PM1 to PM2.

**Syntax:** Amt\_ΣINT(PM1, PM2, I%, PV, PMT, P/Y, C/Y)

**Amt\_ΣPRN:** Returns the total principal paid from payment PM1 to PM2.

**Syntax:** Amt\_ΣPRN(PM1, PM2, I%, PV, PMT, P/Y, C/Y)

#### • Interest Rate Conversion

**Cnvt\_EFF:** Returns the interest rate converted from the nominal interest rate to the effective interest rate.

**Syntax:** Cnvt\_EFF(*n*, I%)

**Cnvt\_APR:** Returns the interest rate converted from the effective interest rate to the nominal interest rate.

**Syntax:** Cnvt\_APR(*n*, I%)

#### • Cost, Selling Price, Margin Calculations

**Cost:** Returns the cost based on a specified selling price and margin.

**Syntax:** Cost(Sell, Margin)

**Sell:** Returns the selling price based on a specified cost and margin.

**Syntax:** Sell(Cost, Margin)

**Margin:** Returns the margin based on a specified cost and selling price.

**Syntax:** Margin(Cost, Sell)

#### • Day/Date Calculations

**Days\_Prd:** Returns the number of days from a specified d1 to specified d2.

**Syntax:** Days\_Prd(MM1, DD1, YYYY1, MM2, DD2, YYYY2)

#### • Bond Calculations

**Bond\_PRC:** Returns in list form bond prices based on specified conditions.

**Syntax:** Bond\_PRC(MM1, DD1, YYYY1, MM2, DD2, YYYY2, RDV, CPN, YLD) = {PRC, INT, CST}

**Bond\_YLD:** Returns the yield based on specified conditions.

**Syntax:** Bond\_YLD(MM1, DD1, YYYY1, MM2, DD2, YYYY2, RDV, CPN, PRC)



# 7. Program Mode Command List

## RUN Program

| F4 (MENU) key |          |                    |               |  |
|---------------|----------|--------------------|---------------|--|
| Level 1       | Level 2  | Level 3            | Command       |  |
| STAT          | DRAW     | On                 | DrawOn        |  |
|               |          | Off                | DrawOff       |  |
|               | GRAPH    | S-Gph1             | S-Gph1_       |  |
|               |          | S-Gph2             | S-Gph2_       |  |
|               |          | S-Gph3             | S-Gph3_       |  |
|               |          | Scatter            | Scatter       |  |
|               |          | xyLine             | xyLine        |  |
|               |          | Hist               | Hist          |  |
|               |          | Box                | MedBox        |  |
|               |          | Bar                | Bar           |  |
|               |          | N-Dist             | N-Dist        |  |
|               |          | Broken             | Broken        |  |
|               |          | X                  | Linear        |  |
|               |          | Med                | Med-Med       |  |
|               |          | X <sup>2</sup>     | Quad          |  |
|               |          | X <sup>3</sup>     | Cubic         |  |
|               |          | X <sup>4</sup>     | Quart         |  |
|               |          | Log                | Log           |  |
|               |          | *1 (see page 8-57) |               |  |
|               |          | Power              | Power         |  |
|               |          | Sin                | Sinusoidal    |  |
|               |          | NPPlot             | NPPlot        |  |
|               | Logistic | Logistic           |               |  |
|               | Pie      | Pie                |               |  |
|               | List     | List_              |               |  |
|               | TYPE     | *2 (see page 8-57) |               |  |
|               | DIST     | DrawN              | DrawDistNorm_ |  |
|               |          | DrawT              | DrawDistT_    |  |
|               |          | DrawC              | DrawDistChi_  |  |
|               |          | DrawF              | DrawDistF_    |  |
|               | CALC     | 1-VAR              | 1-Variable_   |  |
|               |          | 2-VAR              | 2-Variable_   |  |
|               |          | *3 (see page 8-57) |               |  |
|               |          | Med                | Med-MedLine_  |  |
|               |          | X <sup>2</sup>     | QuadReg_      |  |
|               |          | X <sup>3</sup>     | CubicReg_     |  |
|               |          | X <sup>4</sup>     | QuartReg_     |  |
|               |          | Log                | LogReg_       |  |
|               |          | *4 (see page 8-57) |               |  |
|               |          | Power              | PowerReg_     |  |
|               | Sin      | SinReg_            |               |  |
|               | Logistic | LogisticReg_       |               |  |
|               | MAT      | Swap               | Swap_         |  |
|               |          | *Row               | *Row_         |  |
|               |          | *Row+              | *Row+_        |  |
|               |          | Row+               | Row+_         |  |
|               | LIST     | SortA              | SortA(        |  |
| SortD         |          | SortD(             |               |  |
| GRAPH         | SEL      | On                 | G_SelOn_      |  |
|               |          | Off                | G_SelOff_     |  |
|               | TYPE     | Y=                 | Y=Type        |  |
|               |          | r=                 | r=Type        |  |
|               |          | Param              | ParamType     |  |
|               |          | X=                 | X=Type        |  |

|           |                   |                   |                       |                       |
|-----------|-------------------|-------------------|-----------------------|-----------------------|
|           | Y>                | Y>Type            |                       |                       |
|           | Y<                | Y<Type            |                       |                       |
|           | Y≥                | Y≥Type            |                       |                       |
|           | Y≤                | Y≤Type            |                       |                       |
|           | X>                | X>Type            |                       |                       |
|           | X<                | X<Type            |                       |                       |
|           | X≥                | X≥Type            |                       |                       |
|           | X≤                | X≤Type            |                       |                       |
| STYLE     | —                 | NormalG_          |                       |                       |
|           | —                 | ThickG_           |                       |                       |
|           | .....             | BrokenThickG_     |                       |                       |
|           | .....             | DotG_             |                       |                       |
|           | —                 | ThinG_            |                       |                       |
|           | GPH-MEM           | Store             | StoGMEM_              |                       |
|           |                   | Recall            | RclGMEM_              |                       |
| GRHCLR    |                   | SetG-Color_       |                       |                       |
| DYNA      | On                | D_SelOn_          |                       |                       |
|           | Off               | D_SelOff_         |                       |                       |
|           | Var               | D_Var_            |                       |                       |
|           | TYPE              | Y=                | Y=Type                |                       |
|           |                   | r=                | r=Type                |                       |
|           |                   | Param             | ParamType             |                       |
|           | GRHCLR            |                   | SetG-Color_           |                       |
| TABLE     | On                | T_SelOn_          |                       |                       |
|           | Off               | T_SelOff_         |                       |                       |
|           | TYPE              | Y=                | Y=Type                |                       |
|           |                   | r=                | r=Type                |                       |
|           |                   | Param             | ParamType             |                       |
|           | STYLE             | —                 | NormalG_              |                       |
|           |                   | —                 | ThickG_               |                       |
| .....     |                   | BrokenThickG_     |                       |                       |
| .....     |                   | DotG_             |                       |                       |
| —         |                   | ThinG_            |                       |                       |
| GRHCLR    |                   | SetG-Color_       |                       |                       |
| RECURSION | SEL+S             | On                | R_SelOn_              |                       |
|           |                   | Off               | R_SelOff_             |                       |
|           | STYLE             | —                 | NormalG_              |                       |
|           |                   | —                 | ThickG_               |                       |
|           |                   | .....             | BrokenThickG_         |                       |
|           |                   | .....             | DotG_                 |                       |
|           |                   | —                 | ThinG                 |                       |
|           |                   | TYPE              | a <sub>n</sub>        | a <sub>n</sub> Type   |
|           |                   |                   | a <sub>n+1</sub>      | a <sub>n+1</sub> Type |
|           | a <sub>n+2</sub>  |                   | a <sub>n+2</sub> Type |                       |
|           | n.a <sub>n</sub>  |                   | n                     |                       |
|           |                   | a <sub>n</sub>    | a <sub>n</sub>        |                       |
|           |                   | a <sub>n+1</sub>  | a <sub>n+1</sub>      |                       |
|           | a <sub>n+2</sub>  | a <sub>n+2</sub>  |                       |                       |
|           | b <sub>n</sub>    | b <sub>n</sub>    |                       |                       |
|           | b <sub>n+1</sub>  | b <sub>n+1</sub>  |                       |                       |
|           | b <sub>n+2</sub>  | b <sub>n+2</sub>  |                       |                       |
|           | C <sub>n</sub>    | C <sub>n</sub>    |                       |                       |
|           | C <sub>n+1</sub>  | C <sub>n+1</sub>  |                       |                       |
|           | C <sub>n+2</sub>  | C <sub>n+2</sub>  |                       |                       |
|           | Σa <sub>n</sub>   | Σa <sub>n</sub>   |                       |                       |
|           | Σa <sub>n+1</sub> | Σa <sub>n+1</sub> |                       |                       |

|        |                  |                  |
|--------|------------------|------------------|
|        | $\Sigma a_{n+2}$ | $\Sigma a_{n+2}$ |
|        | $\Sigma b_n$     | $\Sigma b_n$     |
|        | $\Sigma b_{n+1}$ | $\Sigma b_{n+1}$ |
|        | $\Sigma b_{n+2}$ | $\Sigma b_{n+2}$ |
|        | $\Sigma c_n$     | $\Sigma c_n$     |
|        | $\Sigma c_{n+1}$ | $\Sigma c_{n+1}$ |
|        | $\Sigma c_{n+2}$ | $\Sigma c_{n+2}$ |
| RANGE  | a0               | Set_a0           |
|        | a1               | Set_a1           |
| GRHCLR |                  | SetG-Color_      |

| OPTN key |          |         |           |
|----------|----------|---------|-----------|
| Level 1  | Level 2  | Level 3 | Command   |
| LIST     | List     |         | List_     |
|          | Lst→Mat  |         | List→Mat( |
|          | Dim      |         | Dim_      |
|          | Fill(    |         | Fill(     |
|          | Seq      |         | Seq(      |
|          | Min      |         | Min(      |
|          | Max      |         | Max(      |
|          | Mean     |         | Mean(     |
|          | Med      |         | Median(   |
|          | Augment  |         | Augment(  |
|          | Sum      |         | Sum_      |
|          | Prod     |         | Prod_     |
|          | Cuml     |         | Cuml_     |
|          | %        |         | Percent_  |
| ΔList    |          | ΔList_  |           |
| MAT/VCT  | Mat      |         | Mat_      |
|          | Mat→Lst  |         | Mat→List( |
|          | Det      |         | Det_      |
|          | Trn      |         | Trn_      |
|          | Augment  |         | Augment(  |
|          | Identity |         | Identity_ |
|          | Dim      |         | Dim_      |
|          | Fill(    |         | Fill(     |
|          | Ref      |         | Ref_      |
|          | Rref     |         | Rref_     |
|          | Vct      |         | Vct_      |
|          | DotP(    |         | DotP(     |
|          | CrossP(  |         | CrossP(   |
|          | Angle(   |         | Angle(    |
| UnitV(   |          | UnitV(  |           |
| Norm(    |          | Norm(   |           |
| COMPLEX  | i        |         | i         |
|          | Abs      |         | Abs_      |
|          | Arg      |         | Arg_      |
|          | Conjg    |         | Conjg_    |
|          | ReP      |         | ReP_      |
|          | ImP      |         | ImP_      |
|          | ►r∠θ     |         | ►r∠θ      |
|          | ►a+bi    |         | ►a+bi     |
| CALC     | Solve    |         | Solve(    |
|          | d/dx     |         | d/dx(     |
|          | d²/dx²   |         | d²/dx²(   |
|          | ∫dx      |         | ∫(        |
|          | SolveN   |         | SolveN(   |
|          | FMin     |         | FMin(     |

|                          |                    |                    |                     |           |
|--------------------------|--------------------|--------------------|---------------------|-----------|
|                          | FMax               |                    | FMax(               |           |
|                          | Σ(                 |                    | Σ(                  |           |
|                          | log <sub>a</sub> b |                    | log <sub>a</sub> b( |           |
|                          | Int÷               |                    | _Int÷_              |           |
|                          | Rmdr               |                    | _Rmdr_              |           |
|                          | Simp               |                    | ►Simp_              |           |
| STAT                     | $\hat{x}$          |                    | $\hat{x}$           |           |
|                          | $\hat{y}$          |                    | $\hat{y}$           |           |
|                          | DIST               | *5 (see page 8-57) |                     |           |
|                          | StdDev             | s                  |                     | StdDev(   |
|                          |                    | σ                  |                     | StdDev_σ( |
|                          | Var                | s²                 |                     | Variance( |
| σ²                       |                    |                    | Variance_σ²(        |           |
| TEST                     | *6 (see page 8-57) |                    |                     |           |
| CONVERT*7<br>(page 8-58) | ►                  |                    | ►                   |           |
|                          | LENGTH             | fm                 |                     | [fm]      |
| Å                        |                    |                    | [Å]                 |           |
| μm                       |                    |                    | [μm]                |           |
| mm                       |                    |                    | [mm]                |           |
| cm                       |                    |                    | [cm]                |           |
| m                        |                    |                    | [m]                 |           |
| km                       |                    |                    | [km]                |           |
| AU                       |                    |                    | [AU]                |           |
| l.y.                     |                    |                    | [l.y.]              |           |
| pc                       |                    |                    | [pc]                |           |
| Mil                      |                    |                    | [Mil]               |           |
| in                       |                    |                    | [in]                |           |
| ft                       |                    |                    | [ft]                |           |
| yd                       |                    |                    | [yd]                |           |
| AREA                     | fath               |                    | [fath]              |           |
|                          | rd                 |                    | [rd]                |           |
|                          | mile               |                    | [mile]              |           |
|                          | n mile             |                    | [n mile]            |           |
|                          | cm²                |                    | [cm²]               |           |
|                          | m²                 |                    | [m²]                |           |
|                          | ha                 |                    | [ha]                |           |
|                          | km²                |                    | [km²]               |           |
|                          | in²                |                    | [in²]               |           |
|                          | ft²                |                    | [ft²]               |           |
| yd²                      |                    | [yd²]              |                     |           |
| acre                     |                    | [acre]             |                     |           |
| mile²                    |                    | [mile²]            |                     |           |
| VOLUME                   | cm³                |                    | [cm³]               |           |
|                          | mL                 |                    | [mL]                |           |
|                          | L                  |                    | [L]                 |           |
|                          | m³                 |                    | [m³]                |           |
|                          | in³                |                    | [in³]               |           |
|                          | ft³                |                    | [ft³]               |           |
|                          | fl_oz(UK)          |                    | [fl_oz(UK)]         |           |
|                          | fl_oz(US)          |                    | [fl_oz(US)]         |           |
|                          | gal(US)            |                    | [gal(US)]           |           |
|                          | gal(UK)            |                    | [gal(UK)]           |           |
|                          | pt                 |                    | [pt]                |           |
|                          | qt                 |                    | [qt]                |           |
|                          | tsp                |                    | [tsp]               |           |
|                          | tbsp               |                    | [tbsp]              |           |
| cup                      |                    | [cup]              |                     |           |
| TIME                     | ns                 |                    | [ns]                |           |
|                          | μs                 |                    | [μs]                |           |
|                          | ms                 |                    | [ms]                |           |

|          |                      |                        |
|----------|----------------------|------------------------|
|          | s                    | [s]                    |
|          | min                  | [min]                  |
|          | h                    | [h]                    |
|          | day                  | [day]                  |
|          | week                 | [week]                 |
|          | yr                   | [yr]                   |
|          | s-yr                 | [s-yr]                 |
|          | t-yr                 | [t-yr]                 |
| TMPR     | °C                   | [°C]                   |
|          | K                    | [K]                    |
|          | °F                   | [°F]                   |
|          | °R                   | [°R]                   |
| VELOCITY | m/s                  | [m/s]                  |
|          | km/h                 | [km/h]                 |
|          | knot                 | [knot]                 |
|          | ft/s                 | [ft/s]                 |
|          | mile/h               | [mile/h]               |
| MASS     | u                    | [u]                    |
|          | mg                   | [mg]                   |
|          | g                    | [g]                    |
|          | kg                   | [kg]                   |
|          | mton                 | [mton]                 |
|          | oz                   | [oz]                   |
|          | lb                   | [lb]                   |
|          | slug                 | [slug]                 |
|          | ton(short)           | [ton(short)]           |
|          | ton(long)            | [ton(long)]            |
| FORCE    | N                    | [N]                    |
|          | lbf                  | [lbf]                  |
|          | tonf                 | [tonf]                 |
|          | dyne                 | [dyne]                 |
|          | kgf                  | [kgf]                  |
| PRESSURE | Pa                   | [Pa]                   |
|          | kPa                  | [kPa]                  |
|          | mmH <sub>2</sub> O   | [mmH <sub>2</sub> O]   |
|          | mmHg                 | [mmHg]                 |
|          | atm                  | [atm]                  |
|          | inH <sub>2</sub> O   | [inH <sub>2</sub> O]   |
|          | inHg                 | [inHg]                 |
|          | lbf/in <sup>2</sup>  | [lbf/in <sup>2</sup> ] |
|          | bar                  | [bar]                  |
|          | kgf/cm <sup>2</sup>  | [kgf/cm <sup>2</sup> ] |
| ENERGY   | eV                   | [eV]                   |
|          | J                    | [J]                    |
|          | cal <sub>th</sub>    | [cal <sub>th</sub> ]   |
|          | cal <sub>15</sub>    | [cal <sub>15</sub> ]   |
|          | cal <sub>IT</sub>    | [cal <sub>IT</sub> ]   |
|          | kcal <sub>th</sub>   | [kcal <sub>th</sub> ]  |
|          | kcal <sub>15</sub>   | [kcal <sub>15</sub> ]  |
|          | kcal <sub>IT</sub>   | [kcal <sub>IT</sub> ]  |
|          | l-atm                | [l-atm]                |
|          | kW·h                 | [kW·h]                 |
|          | ft·lbf               | [ft·lbf]               |
|          | Btu                  | [Btu]                  |
|          | erg                  | [erg]                  |
|          | kgf·m                | [kgf·m]                |
| POWER    | W                    | [W]                    |
|          | cal <sub>th</sub> /s | [cal <sub>th</sub> /s] |
|          | hp                   | [hp]                   |
|          | ft·lbf/s             | [ft·lbf/s]             |

|         |                    |         |                      |
|---------|--------------------|---------|----------------------|
|         |                    | Btu/min | [Btu/min]            |
| HYPERBL | sinh               |         | sinh_                |
|         | cosh               |         | cosh_                |
|         | tanh               |         | tanh_                |
|         | sinh <sup>-1</sup> |         | sinh <sup>-1</sup> _ |
|         | cosh <sup>-1</sup> |         | cosh <sup>-1</sup> _ |
|         | tanh <sup>-1</sup> |         | tanh <sup>-1</sup> _ |
| PROB    | x!                 |         | !                    |
|         | nPr                |         | P                    |
|         | nCr                |         | C                    |
|         | RAND               | Ran#    | Ran#_                |
|         |                    | Int     | RanInt#(             |
|         |                    | Norm    | RanNorm#(            |
|         |                    | Bin     | RanBin#(             |
|         |                    | List    | RanList#(            |
|         |                    | Samp    | RanSamp#(            |
|         | P(                 |         | P(                   |
|         | Q(                 |         | Q(                   |
|         | R(                 |         | R(                   |
|         | t(                 |         | t(                   |
| NUMERIC | Abs                |         | Abs_                 |
|         | Int                |         | Int_                 |
|         | Frac               |         | Frac_                |
|         | Rnd                |         | Rnd                  |
|         | Intg               |         | Intg_                |
|         | RndFix             |         | RndFix(              |
|         | GCD                |         | GCD(                 |
|         | LCM                |         | LCM(                 |
|         | MOD                |         | MOD(                 |
|         | MOD_Exp            |         | MOD_Exp(             |
| ANGLE   | °                  |         | °                    |
|         | r                  |         | r                    |
|         | g                  |         | g                    |
|         | ° ' "              |         | ° ' "                |
|         | Pol(               |         | Pol(                 |
|         | Rec(               |         | Rec(                 |
|         | ►DMS               |         | ►DMS                 |
| ENG-SYM | m                  |         | m                    |
|         | μ                  |         | μ                    |
|         | n                  |         | n                    |
|         | p                  |         | p                    |
|         | f                  |         | f                    |
|         | k                  |         | k                    |
|         | M                  |         | M                    |
|         | G                  |         | G                    |
|         | T                  |         | T                    |
|         | P                  |         | P                    |
|         | E                  |         | E                    |
| PICTURE | Store              |         | StoPict_             |
|         | Recall             |         | RelPict_             |
|         | OPEN               |         | *8 (see page 8-58)   |
| FUNCMEM | fn                 |         | fn                   |
| LOGIC   | And                |         | _And_                |
|         | Or                 |         | _Or_                 |
|         | Not                |         | Not_                 |
|         | Xor                |         | Xor_                 |
| CAPTURE | Recall             |         | RelCapt_             |
| FINANCE | SIMPLE             | SI      | Smpl_SI(             |
|         |                    | SFV     | Smpl_SFV(            |
|         | COMPND             | n       | Cmpd_n(              |

|         |        |           |
|---------|--------|-----------|
|         | I%     | Cmpd_I%(  |
|         | PV     | Cmpd_PV(  |
|         | PMT    | Cmpd_PMT( |
|         | FV     | Cmpd_FV(  |
| CASH    | NPV    | Cash_NPV( |
|         | IRR    | Cash_IRR( |
|         | PBP    | Cash_PBP( |
|         | NFV    | Cash_NFV( |
| AMORTZN | BAL    | Amt_BAL(  |
|         | INT    | Amt_INT(  |
|         | PRN    | Amt_PRN(  |
|         | ΣINT   | Amt_ΣINT( |
|         | ΣPRN   | Amt_ΣPRN( |
| CONVERT | EFF    | Cnvt_EFF( |
|         | APR    | Cnvt_APR( |
| COST    | Cost   | Cost(     |
|         | Sell   | Sell(     |
|         | Margin | Margin(   |
| DAYS    | PRD    | Days_Prd( |
| BOND    | PRC    | Bond_PRC( |
|         | YLD    | Bond_YLD( |

| VARs key |         |                 |                 |
|----------|---------|-----------------|-----------------|
| Level 1  | Level 2 | Level 3         | Command         |
| V-WIN    | X       | min             | Xmin            |
|          |         | max             | Xmax            |
|          |         | scale           | Xscl            |
|          |         | dot             | Xdot            |
|          | Y       | min             | Ymin            |
|          |         | max             | Ymax            |
|          |         | scale           | Yscl            |
|          | T,θ     | min             | Tθmin           |
|          |         | max             | Tθmax           |
|          |         | pitch           | Tθptch          |
|          | R-X     | min             | RightXmin       |
|          |         | max             | RightXmax       |
|          |         | scale           | RightXscl       |
|          |         | dot             | RightXdot       |
|          | R-Y     | min             | RightYmin       |
|          |         | max             | RightYmax       |
| scale    |         | RightYscl       |                 |
| R-T, θ   | min     | RightTθmin      |                 |
|          | max     | RightTθmax      |                 |
|          | pitch   | RightTθptch     |                 |
| FACTOR   | Xfct    | Xfct            |                 |
|          | Yfct    | Yfct            |                 |
| STAT     | X       | n               | n               |
|          |         | $\bar{x}$       | $\bar{x}$       |
|          |         | Σx              | Σx              |
|          |         | Σx <sup>2</sup> | Σx <sup>2</sup> |
|          |         | σx              | σx              |
|          |         | sx              | sx              |
|          |         | minX            | minX            |
|          |         | maxX            | maxX            |
|          | Y       | $\bar{y}$       | $\bar{y}$       |
|          |         | Σy              | Σy              |
|          |         | Σy <sup>2</sup> | Σy <sup>2</sup> |
|          |         | Σxy             | Σxy             |

|                |                    |                  |                  |
|----------------|--------------------|------------------|------------------|
|                | σy                 | σy               |                  |
|                | sy                 | sy               |                  |
|                | minY               | minY             |                  |
|                | maxY               | maxY             |                  |
| GRAPH          | a                  | a                |                  |
|                | b                  | b                |                  |
|                | c                  | c                |                  |
|                | d                  | d                |                  |
|                | e                  | e                |                  |
|                | r                  | r                |                  |
|                | r <sup>2</sup>     | r <sup>2</sup>   |                  |
|                | MSe                | MSe              |                  |
|                | Q <sub>1</sub>     | Q <sub>1</sub>   |                  |
|                | Med                | Med              |                  |
|                | Q <sub>3</sub>     | Q <sub>3</sub>   |                  |
| Mod            | Mod                |                  |                  |
| Start          | H_Start            |                  |                  |
| Pitch          | H_pitch            |                  |                  |
| PTS            | x <sub>1</sub>     | x <sub>1</sub>   |                  |
|                | y <sub>1</sub>     | y <sub>1</sub>   |                  |
|                | x <sub>2</sub>     | x <sub>2</sub>   |                  |
|                | y <sub>2</sub>     | y <sub>2</sub>   |                  |
|                | x <sub>3</sub>     | x <sub>3</sub>   |                  |
| INPUT          | y <sub>3</sub>     | y <sub>3</sub>   |                  |
|                | n                  | n                |                  |
|                | $\bar{x}$          | $\bar{x}$        |                  |
|                | sx                 | sx               |                  |
|                | n <sub>1</sub>     | n <sub>1</sub>   |                  |
|                | n <sub>2</sub>     | n <sub>2</sub>   |                  |
|                | $\bar{x}_1$        | $\bar{x}_1$      |                  |
|                | $\bar{x}_2$        | $\bar{x}_2$      |                  |
|                | sx <sub>1</sub>    | sx <sub>1</sub>  |                  |
|                | sx <sub>2</sub>    | sx <sub>2</sub>  |                  |
| sp             | sp                 |                  |                  |
| RESULT         | *9 (see page 8-58) |                  |                  |
| GRAPH          | Y                  | Y                |                  |
|                | r                  | r                |                  |
|                | Xt                 | Xt               |                  |
|                | Yt                 | Yt               |                  |
|                | X                  | X                |                  |
| DYNA           | Start              | D_Start          |                  |
|                | End                | D_End            |                  |
|                | Pitch              | D_pitch          |                  |
| TABLE          | Start              | F_Start          |                  |
|                | End                | F_End            |                  |
|                | Pitch              | F_pitch          |                  |
|                | Result             | F_Result         |                  |
| RECURSION      | FORMULA            | a <sub>n</sub>   | a <sub>n</sub>   |
|                |                    | a <sub>n+1</sub> | a <sub>n+1</sub> |
|                |                    | a <sub>n+2</sub> | a <sub>n+2</sub> |
|                |                    | b <sub>n</sub>   | b <sub>n</sub>   |
|                |                    | b <sub>n+1</sub> | b <sub>n+1</sub> |
|                |                    | b <sub>n+2</sub> | b <sub>n+2</sub> |
|                |                    | C <sub>n</sub>   | C <sub>n</sub>   |
|                |                    | C <sub>n+1</sub> | C <sub>n+1</sub> |
|                |                    | C <sub>n+2</sub> | C <sub>n+2</sub> |
|                |                    | RANGE            | Start            |
| End            | R_End              |                  |                  |
| a <sub>0</sub> | a <sub>0</sub>     |                  |                  |
| a <sub>1</sub> | a <sub>1</sub>     |                  |                  |

|          |                      |                      |
|----------|----------------------|----------------------|
|          | a2                   | a2                   |
|          | b0                   | b0                   |
|          | b1                   | b1                   |
|          | b2                   | b2                   |
|          | C0                   | c0                   |
|          | C1                   | c1                   |
|          | C2                   | c2                   |
|          | a <sub>n</sub> Start | a <sub>n</sub> Start |
|          | b <sub>n</sub> Start | b <sub>n</sub> Start |
|          | C <sub>n</sub> Start | c <sub>n</sub> Start |
|          | Result               | R_Result             |
| EQUATION | SimRes               | Sim_Result           |
|          | SimCoef              | Sim_Coef             |
|          | PlyRes               | Ply_Result           |
|          | PlyCoef              | Ply_Coef             |
| FINANCE  | n                    | n                    |
|          | I%                   | I%                   |
|          | PV                   | PV                   |
|          | PMT                  | PMT                  |
|          | FV                   | FV                   |
|          | P/Y                  | P/Y                  |
| C/Y      | C/Y                  |                      |
| Str      |                      | Str_                 |

|         |         |                                |                 |
|---------|---------|--------------------------------|-----------------|
|         | FUNCTAB | Table                          | DispF-Tbl       |
|         |         | Gph-Con                        | DrawFTG-Con     |
|         |         | Gph-Plt                        | DrawFTG-Plt     |
|         | RECRTAB | Table                          | DispR-Tbl       |
|         |         | Phase                          | PlotPhase       |
|         |         | Web                            | DrawWeb_        |
|         |         | a <sub>n</sub> -C <sub>n</sub> | DrawR-Con       |
|         |         | Σa-C <sub>n</sub>              | DrawR Σ-Con     |
|         |         | a <sub>n</sub> -PI             | DrawR-Plt       |
|         |         | Σa-PI                          | DrawR Σ-Plt     |
| RELATNL | =       |                                | =               |
|         | ≠       |                                | ≠               |
|         | >       |                                | >               |
|         | <       |                                | <               |
|         | ≥       |                                | ≥               |
|         | ≤       |                                | ≤               |
| I/O     | Locate  |                                | Locate_         |
|         | Getkey  |                                | Getkey          |
|         | Send    |                                | Send(           |
|         | Receive |                                | Receive(        |
|         | S38k    |                                | Send38k_        |
|         | R38k    |                                | Receive38k_     |
|         | Open    |                                | OpenComport38k  |
|         | Close   |                                | CloseComport38k |
|         | :       |                                | :               |
| STR     | Join    |                                | StrJoin(        |
|         | Len     |                                | StrLen(         |
|         | Cmp     |                                | StrCmp(         |
|         | Src     |                                | StrSrc(         |
|         | Left    |                                | StrLeft(        |
|         | Right   |                                | StrRight(       |
|         | Mid     |                                | StrMid(         |
|         | E→S     |                                | Exp►Str(        |
|         | Exp     |                                | Exp(            |
|         | Upr     |                                | StrUpr(         |
|         | Lwr     |                                | StrLwr(         |
|         | Inverse |                                | StrInv(         |
|         | Shift   |                                | StrShift(       |
| Rotate  |         | StrRotate(                     |                 |

| SHIFT VARS (PRGM) key |         |         |           |
|-----------------------|---------|---------|-----------|
| Level 1               | Level 2 | Level 3 | Command   |
| COMMAND               | If      |         | If_       |
|                       | Then    |         | Then_     |
|                       | Else    |         | Else_     |
|                       | IfEnd   |         | IfEnd     |
|                       | For     |         | For_      |
|                       | To      |         | _To_      |
|                       | Step    |         | _Step_    |
|                       | Next    |         | Next      |
|                       | While   |         | While_    |
|                       | WEnd    |         | WhileEnd  |
|                       | Do      |         | Do        |
|                       | LpWhile |         | LpWhile_  |
|                       | CONTROL | Prog    |           |
| Return                |         |         | Return    |
| Break                 |         |         | Break     |
| Stop                  |         |         | Stop      |
| JUMP                  | Lbl     |         | Lbl_      |
|                       | Goto    |         | Goto_     |
|                       | ⇒       |         | ⇒         |
|                       | Isz     |         | Isz_      |
|                       | Dsz     |         | Dsz_      |
|                       | Menu    |         | Menu_     |
| ?                     |         | ?       |           |
| ▲                     |         | ▲       |           |
| CLEAR                 | Text    |         | ClrText   |
|                       | Graph   |         | ClrGraph  |
|                       | List    |         | ClrList_  |
|                       | Mat     |         | ClrMat_   |
|                       | Vct     |         | ClrVct_   |
| DISPLAY               | Stat    |         | DrawStat  |
|                       | Graph   |         | DrawGraph |
|                       | Dyna    |         | DrawDyna  |

| SHIFT MENU (SET UP) key |         |         |           |
|-------------------------|---------|---------|-----------|
| Level 1                 | Level 2 | Level 3 | Command   |
| ANGLE                   | Deg     |         | Deg       |
|                         | Rad     |         | Rad       |
|                         | Gra     |         | Gra       |
| COORD                   | On      |         | CoordOn   |
|                         | Off     |         | CoordOff  |
| GRID                    | On      |         | GridOn    |
|                         | Off     |         | GridOff   |
|                         | Line    |         | GridLine  |
| AXES                    | On      |         | AxesOn    |
|                         | Off     |         | AxesOff   |
|                         | Scale   |         | AxesScale |
| LABEL                   | On      |         | LabelOn   |
|                         | Off     |         | LabelOff  |
| DISPLAY                 | Fix     |         | Fix_      |
|                         | Sci     |         | Sci_      |
|                         | Norm    |         | Norm_     |

|         |                 |     |                    |
|---------|-----------------|-----|--------------------|
|         | ENG             | On  | EngOn              |
|         |                 | Off | EngOff             |
|         |                 | Eng | Eng                |
| SKT/LIN | —               |     | S-L-Normal         |
|         | —               |     | S-L-Thick          |
|         | .....           |     | S-L-Broken         |
|         | .....           |     | S-L-Dot            |
|         | —               |     | S-L-Thin           |
| DRAW    | Connect         |     | G-Connect          |
|         | Plot            |     | G-Plot             |
| DERIV   | On              |     | DerivOn            |
|         | Off             |     | DerivOff           |
| BACK    | None            |     | BG-None            |
|         | Pict            |     | BG-Pict_           |
|         | OPEN            |     | *8 (see page 8-58) |
| FUNC    | On              |     | FuncOn             |
|         | Off             |     | FuncOff            |
| SIMUL   | On              |     | SimulOn            |
|         | Off             |     | SimulOff           |
| SGV-WIN | Auto            |     | S-WindAuto         |
|         | Manual          |     | S-WindMan          |
| LIST    | File            |     | File_              |
| LOCUS   | On              |     | LocusOn            |
|         | Off             |     | LocusOff           |
| TBL-VAR | Range           |     | VarRange           |
|         | List            |     | VarList_           |
| ΣDISP   | On              |     | ΣdispOn            |
|         | Off             |     | ΣdispOff           |
| RESID   | None            |     | Resid-None         |
|         | List            |     | Resid-List_        |
| COMPLEX | Real            |     | Real               |
|         | a+bi            |     | a+bi               |
|         | $r\angle\theta$ |     | $r\angle\theta$    |
| FRAC    | d/c             |     | d/c                |
|         | ab/c            |     | ab/c               |
| Y=SPEED | Norm            |     | Y=DrawSpeedNorm    |
|         | High            |     | Y=DrawSpeedHigh    |
| DATE    | 365             |     | DateMode365        |
|         | 360             |     | DateMode360        |
| PMT     | Begin           |     | PmtBgn             |
|         | End             |     | PmtEnd             |
| PERIODS | Annual          |     | PeriodsAnnual      |
|         | Semi            |     | PeriodsSemi        |
| INEQ    | Intsect         |     | IneqTypeIntsect    |
|         | Union           |     | IneqTypeUnion      |
| SIMP    | Auto            |     | SimplifyAuto       |
|         | Manual          |     | SimplifyMan        |
| Q1Q3    | Std             |     | Q1Q3TypeStd        |
|         | OnData          |     | Q1Q3TypeOnData     |
| P/L-CLR |                 |     | Plot/Line-Color_   |

| [SHIFT] key |         |         |             |
|-------------|---------|---------|-------------|
| Level 1     | Level 2 | Level 3 | Command     |
| ZOOM        | Factor  |         | Factor_     |
|             | Auto    |         | ZoomAuto    |
| V-WIN       | V-Win   |         | ViewWindow_ |
|             | Store   |         | StoV-Win_   |
|             | Recall  |         | RclV-Win_   |

|        |          |          |               |              |
|--------|----------|----------|---------------|--------------|
| SKETCH | Cls      |          | Cls           |              |
|        | Tangent  |          | Tangent_      |              |
|        | Norm     |          | Normal_       |              |
|        | Inverse  |          | Inverse_      |              |
|        | GRAPH    | Y=       |               | Graph_Y=     |
|        |          | r=       |               | Graph_r=     |
|        |          | Param    |               | Graph(X,Y)=( |
|        |          | x=c      |               | Graph_X=     |
|        |          | G./dX    |               | Graph_f      |
|        |          | Y>       |               | Graph_Y>     |
|        |          | Y<       |               | Graph_Y<     |
|        |          | Y≥       |               | Graph_Y≥     |
|        |          | Y≤       |               | Graph_Y≤     |
|        |          | X>       |               | Graph_X>     |
|        | X<       |          | Graph_X<      |              |
|        | X≥       |          | Graph_X≥      |              |
|        | X≤       |          | Graph_X≤      |              |
|        | PLOT     | Plot     |               | Plot_        |
|        |          | PlotOn   |               | PlotOn_      |
|        |          | PlotOff  |               | PlotOff_     |
|        |          | PlotChg  |               | PlotChg_     |
|        | LINE     | Line     |               | Line         |
|        |          | F-Line   |               | F-Line_      |
|        | Circle   |          | Circle_       |              |
|        | Vertical |          | Vertical_     |              |
|        | Horz     |          | Horizontal_   |              |
|        | Text     |          | Text_         |              |
|        | PIXEL    | On       |               | PxlOn_       |
|        |          | Off      |               | PxlOff_      |
|        |          | Pxlchg   |               | PxlChg_      |
| Test   |          | PxlTest( |               |              |
| STYLE  | —        |          | SketchNormal_ |              |
|        | —        |          | SketchThick_  |              |
|        | .....    |          | SketchBroken_ |              |
|        | .....    |          | SketchDot_    |              |
|        | —        |          | SketchThin_   |              |

| [SHIFT] [5] (FORMAT) key |                 |          |               |
|--------------------------|-----------------|----------|---------------|
| Level 1                  | Level 2         | Level 3  | Command       |
| 1:Color Command          | 1:Black         |          | Black_        |
|                          | 2:Blue          |          | Blue_         |
|                          | 3:Red           |          | Red_          |
|                          | 4:Magenta       |          | Magenta_      |
|                          | 5:Green         |          | Green_        |
|                          | 6:Cyan          |          | Cyan_         |
|                          | 7:Yellow        |          | Yellow_       |
|                          | 9:Auto          |          | ColorAuto_    |
|                          | A:Clear         |          | ColorClr_     |
|                          | 2:Paint Command | 1:Normal |               |
| 2:Lighter                |                 |          | ColorLighter_ |

## BASE Program

| F4 (MENU) key |         |         |         |
|---------------|---------|---------|---------|
| Level 1       | Level 2 | Level 3 | Command |
| d~o           | d       |         | d       |
|               | h       |         | h       |
|               | b       |         | b       |
|               | o       |         | o       |
| LOGIC         | Neg     |         | Neg_    |
|               | Not     |         | Not_    |
|               | and     |         | and     |
|               | or      |         | or      |
|               | xor     |         | xor     |
|               | xnor    |         | xnor    |
| DISPLAY       | ►Dec    |         | ►Dec    |
|               | ►Hex    |         | ►Hex    |
|               | ►Bin    |         | ►Bin    |
|               | ►Oct    |         | ►Oct    |

| SHIFT VARS (PRGM) key |         |         |         |
|-----------------------|---------|---------|---------|
| Level 1               | Level 2 | Level 3 | Command |
| Prog                  |         |         | Prog_   |
| JUMP                  | Lbl     |         | Lbl_    |
|                       | Goto    |         | Goto_   |
|                       | ⇒       |         | ⇒       |
|                       | Isz     |         | Isz_    |
|                       | Dsz     |         | Dsz_    |
|                       | Menu    |         | Menu_   |
| ?                     |         |         | ?       |
| ▲                     |         |         | ▲       |
| RELATNL               | =       |         | =       |
|                       | ≠       |         | ≠       |
|                       | >       |         | >       |
|                       | <       |         | <       |
|                       | ≥       |         | ≥       |
|                       | ≤       |         | ≤       |
| :                     |         |         | :       |

| SHIFT MENU (SET UP) key |         |         |         |
|-------------------------|---------|---------|---------|
| Level 1                 | Level 2 | Level 3 | Command |
| Dec                     |         |         | Dec     |
| Hex                     |         |         | Hex     |
| Bin                     |         |         | Bin     |
| Oct                     |         |         | Oct     |

| SHIFT 5 (FORMAT) key |         |         |          |
|----------------------|---------|---------|----------|
| Level 1              | Level 2 | Level 3 | Command  |
| 1:Black              |         |         | Black_   |
| 2:Blue               |         |         | Blue_    |
| 3:Red                |         |         | Red_     |
| 4:Magenta            |         |         | Magenta_ |
| 5:Green              |         |         | Green_   |
| 6:Cyan               |         |         | Cyan_    |
| 7:Yellow             |         |         | Yellow_  |

|    | Level 3    | Level 4          | Command                    |
|----|------------|------------------|----------------------------|
| *1 | Exp        | ae <sup>bx</sup> | Exp(ae <sup>bx</sup> )     |
|    |            | ab <sup>x</sup>  | Exp(ab <sup>x</sup> )      |
| *2 | MARK       | □                | Square                     |
|    |            | ⊗                | Cross                      |
|    |            | ■                | Dot                        |
|    | STICK      | Length           | StickLength                |
|    |            | Horz             | StickHoriz                 |
|    | %DATA      | %                | %                          |
|    |            | Data             | Data                       |
|    | None       |                  | None                       |
|    | COLOR LINK | BothXY           | ColorLinkX&Y               |
|    |            | X&Freq           | ColorLinkX&Freq            |
|    |            | OnlyX            | ColorLinkOnlyX             |
|    |            | OnlyY            | ColorLinkOnlyY             |
|    |            | On               | ColorLinkOn                |
|    |            | Off              | ColorLinkOff               |
| *3 | X          | ax+b             | LinearReg(ax+b)            |
|    |            | a+bx             | LinearReg(a+bx)            |
| *4 | EXP        | ae <sup>bx</sup> | ExpReg(a•e <sup>bx</sup> ) |
|    |            | ab <sup>x</sup>  | ExpReg(a•b <sup>x</sup> )  |
| *5 | NORM       | Npd              | NormPD(                    |
|    |            | Ncd              | NormCD(                    |
|    |            | InvN             | InvNormCD(                 |
|    | t          | tpd              | tPD(                       |
|    |            | tcd              | tCD(                       |
|    |            | InvT             | InvTCD(                    |
|    | CHI        | Cpd              | ChiPD(                     |
|    |            | Ccd              | ChiCD(                     |
|    |            | InvC             | InvChiCD(                  |
|    | F          | Fpd              | FPD(                       |
|    |            | Fcd              | FCD(                       |
|    |            | InvF             | InvFCD(                    |
|    | BINOMIAL   | Bpd              | BinomialPD(                |
|    |            | Bcd              | BinomialCD(                |
|    |            | InvB             | InvBinomialCD(             |
|    | POISSON    | Ppd              | PoissonPD(                 |
|    |            | Pcd              | PoissonCD(                 |
|    |            | InvP             | InvPoissonCD(              |
|    | GEO        | Gpd              | GeoPD(                     |
|    |            | Gcd              | GeoCD(                     |
|    |            | InvG             | InvGeoCD(                  |
|    | HYPRGEO    | Hpd              | HypergeoPD(                |
|    |            | Hcd              | HypergeoCD(                |
|    |            | InvH             | InvHyperGeoCD(             |
| *6 | Z          | 1-Sample         | OneSampleZTest_            |
|    |            | 2-Sample         | TwoSampleZTest_            |
|    |            | 1-Prop           | OnePropZTest_              |
|    |            | 2-Prop           | TwoPropZTest_              |
|    | t          | 1-Sample         | OneSampleTTest_            |
|    |            | 2-Sample         | TwoSampleTTest_            |
|    |            | REG              | LinRegTTest_               |
|    | CHI        | GOF              | ChiGOFTest_                |
|    |            | 2WAY             | ChiTest_                   |
|    | F          |                  | TwoSampleFTest_            |
|    | ANOVA      | 1WAYANO          | OneWayANOVA_               |
|    |            | 2WAYANO          | TwoWayANOVA_               |

\*7 Metric conversion commands (commands included in **OPTN** **F6**( $\triangleright$ ) **F1**(CONVERT)) are supported only when the Metric Conversion add-in application is installed.

\*8 Selecting "OPEN" displays a dialog box for specifying an image file. The storage memory location (folder name and file name) of the specified image will be input. For example: "Pict\Pict01.g3p".

|    | Level 3 | Level 4     | Command      |
|----|---------|-------------|--------------|
| *9 | TEST    | p           | <b>p</b>     |
|    |         | z           | <b>z</b>     |
|    |         | t           | <b>t</b>     |
|    |         | Chi         | $\chi^2$     |
|    |         | F           | <b>F</b>     |
|    |         | $\hat{p}$   | $\hat{p}$    |
|    |         | $\hat{p}_1$ | $\hat{p}_1$  |
|    |         | $\hat{p}_2$ | $\hat{p}_2$  |
|    |         | df          | <b>df</b>    |
|    |         | se          | <b>se</b>    |
|    |         | r           | <b>r</b>     |
|    |         | $r^2$       | $r^2$        |
|    |         | pa          | <b>pa</b>    |
|    |         | Fa          | <b>Fa</b>    |
|    |         | Adf         | <b>Adf</b>   |
|    |         | SSa         | <b>SSa</b>   |
|    |         | MSa         | <b>MSa</b>   |
|    |         | pb          | <b>pb</b>    |
|    |         | Fb          | <b>Fb</b>    |
|    |         | Bdf         | <b>Bdf</b>   |
|    |         | SSb         | <b>SSb</b>   |
|    |         | MSb         | <b>MSb</b>   |
|    |         | pab         | <b>pab</b>   |
|    |         | Fab         | <b>Fab</b>   |
|    |         | ABdf        | <b>ABdf</b>  |
|    |         | SSab        | <b>SSab</b>  |
|    |         | MSab        | <b>MSab</b>  |
|    | Edf     | <b>Edf</b>  |              |
|    | SSe     | <b>SSe</b>  |              |
|    | MSe     | <b>MSe</b>  |              |
|    | INTR    | Lower       | <b>Lower</b> |
|    |         | Upper       | <b>Upper</b> |
|    |         | $\hat{p}$   | $\hat{p}$    |
|    |         | $\hat{p}_1$ | $\hat{p}_1$  |
|    |         | $\hat{p}_2$ | $\hat{p}_2$  |
|    |         | df          | <b>df</b>    |
|    | DIST    | p           | <b>p</b>     |
|    |         | xInv        | <b>xInv</b>  |
|    |         | x1Inv       | <b>x1Inv</b> |
|    |         | x2Inv       | <b>x2Inv</b> |
|    |         | zLow        | <b>zLow</b>  |
|    |         | zUp         | <b>zUp</b>   |
|    |         | tLow        | <b>tLow</b>  |
|    |         | tUp         | <b>tUp</b>   |



## 8. CASIO Scientific Function Calculator Special Commands ⇔ Text Conversion Table

The table below shows the special text strings that correspond to commands when converting between programs and text files. For details about the operations for converting between programs and text files, see “Converting Programs and Text Files” (page 8-7).

### **Important!**

- Converting a program that contains the types of commands described below to a text file will cause the commands to be converted to text strings with underbar (\_) characters appended at the beginning and end, as shown in the table below.
  - A command enclosed in quotation marks (" ")
  - A command in a comment line, which is a line that begins with a single quotation mark (')

Note that non-command alpha-numeric characters in a program that are enclosed in quotation marks (" ") or are in a comment line are output to the text file as-is.

Example:

| In the program: | In the text file (after conversion): |
|-----------------|--------------------------------------|
| "θ"             | "_Theta_"                            |
| "Theta"*1       | "Theta"                              |
| "Tθmax"*2       | "_TThetamax_"                        |
| "TThetamax"*1   | "TThetamax"                          |
| "or"*3          | "_or_"                               |
| "or"*1          | "or"                                 |

\*1 Non-command alpha-numeric characters

\*2 V-Window Tθmax command

\*3 Logical operator or

Converting from a text file to a program converts the special character strings back to their corresponding commands, shown above.

- When converting a program that contains special characters input using **F6** (CHAR) when editing the program on the calculator, the special characters will be converted to character string codes as shown below.

Example:

| In the program: | In the text file (after conversion): |
|-----------------|--------------------------------------|
| λ               | #E54A                                |
| □               | #E5A5                                |
| ①               | #E5F0                                |
| β               | #E641                                |
| ▲               | #E69C                                |
| ⇔               | #E6D6                                |

These codes are not included in the tables on the pages 8-60 through 8-65.

\* "□" in the following tables indicates a space.

| Command        | Text  |
|----------------|-------|
| f              | femto |
| p              | pico  |
| n              | nano  |
| μ              | micro |
| m              | milli |
| k              | kilo  |
| M              | Mega  |
| G              | Giga  |
| T              | Tera  |
| P              | Peta  |
| E              | Exa   |
| ▲              | Disps |
| ↵              | (CR)  |
| ->             | ->    |
| E              | Exp   |
| ≤              | <=    |
| ≠              | <>    |
| ≥              | >=    |
| ⇒              | =>    |
| f <sub>1</sub> | f1    |
| f <sub>2</sub> | f2    |
| f <sub>3</sub> | f3    |
| f <sub>4</sub> | f4    |
| f <sub>5</sub> | f5    |
| f <sub>6</sub> | f6    |
| Ⓐ              | &HA   |
| Ⓑ              | &HB   |
| Ⓒ              | &HC   |
| Ⓓ              | &HD   |
| Ⓔ              | &HE   |
| Ⓕ              | &HF   |
| □              | □     |
| !              | Char! |
| "              | "     |
| #              | #     |
| \$             | \$    |
| %              | %     |
| &              | &     |
| '              | '     |
| (              | (     |
| )              | )     |
| *              | **    |
| +              | ++    |
| ,              | ,     |
| -              | Char- |
| .              | .     |
| /              | //    |
| 0              | 0     |
| 1              | 1     |
| 2              | 2     |
| 3              | 3     |
| 4              | 4     |
| 5              | 5     |
| 6              | 6     |

| Command | Text |
|---------|------|
| 7       | 7    |
| 8       | 8    |
| 9       | 9    |
| :       | :    |
| ;       | ;    |
| <       | <    |
| =       | =    |
| >       | >    |
| ?       | ?    |
| @       | @    |
| A       | A    |
| B       | B    |
| C       | C    |
| D       | D    |
| E       | E    |
| F       | F    |
| G       | G    |
| H       | H    |
| I       | I    |
| J       | J    |
| K       | K    |
| L       | L    |
| M       | M    |
| N       | N    |
| O       | O    |
| P       | P    |
| Q       | Q    |
| R       | R    |
| S       | S    |
| T       | T    |
| U       | U    |
| V       | V    |
| W       | W    |
| X       | X    |
| Y       | Y    |
| Z       | Z    |
| [       | [    |
| \       | ¥    |
| ]       | ]    |
| ^       | ^^   |
| _       | _    |
| '       | '    |
| a       | a    |
| b       | b    |
| c       | c    |
| d       | d    |
| e       | e    |
| f       | f    |
| g       | g    |
| h       | h    |
| i       | i    |
| j       | j    |
| k       | k    |
| l       | l    |

| Command             | Text                |
|---------------------|---------------------|
| m                   | m                   |
| n                   | n                   |
| o                   | o                   |
| p                   | p                   |
| q                   | q                   |
| r                   | r                   |
| s                   | s                   |
| t                   | t                   |
| u                   | u                   |
| v                   | v                   |
| w                   | w                   |
| x                   | x                   |
| y                   | y                   |
| z                   | z                   |
| {                   | {                   |
|                     |                     |
| }                   | }                   |
| ~                   | ~                   |
| Pol(                | Pol(                |
| sin□                | sin□                |
| cos□                | cos□                |
| tan□                | tan□                |
| h                   | &h                  |
| ln□                 | ln□                 |
| √                   | Sqrt                |
| -                   | (-)                 |
| P                   | nPr                 |
| +                   | +                   |
| xnor                | xnor                |
| ²                   | ^<2>                |
| □                   | dms                 |
| ∫(                  | Integral(           |
| Mod                 | Mod                 |
| Σx²                 | Sigmax^2            |
| x                   | X                   |
| sin <sup>-1</sup> □ | sin <sup>-1</sup> □ |
| cos <sup>-1</sup> □ | cos <sup>-1</sup> □ |
| tan <sup>-1</sup> □ | tan <sup>-1</sup> □ |
| d                   | &d                  |
| log□                | log□                |
| ³√                  | Cbrt                |
| Abs□                | Abs□                |
| ℄                   | nCr                 |
| -                   | -                   |
| xor                 | xor                 |
| -1                  | ^<-1>               |
| °                   | deg                 |
| Med                 | Med                 |
| Σx                  | Sigmax              |
| Rec(                | Rec(                |
| sinh□               | sinh□               |
| cosh□               | cosh□               |
| tanh□               | tanh□               |
| o                   | &o                  |

| Command                           | Text                |
|-----------------------------------|---------------------|
| $e^{\wedge}$                      | $e^{\wedge}$        |
| Int□                              | Int□                |
| Not□                              | Not□                |
| $\wedge$                          | $\wedge$            |
| $\times$                          | $\ast$              |
| or                                | or                  |
| !                                 | !                   |
| $r$                               | rad                 |
| minY                              | minY                |
| minX                              | minX                |
| n                                 | Statn               |
| $\sinh^{-1}\square$               | $\sinh^{-1}\square$ |
| $\cosh^{-1}\square$               | $\cosh^{-1}\square$ |
| $\tanh^{-1}\square$               | $\tanh^{-1}\square$ |
| b                                 | &b                  |
| $10$                              | (10)                |
| Frac□                             | Frac□               |
| Neg□                              | Neg□                |
| $\sqrt[x]{\phantom{x}}$           | Xrt                 |
| $\div$                            | /                   |
| and                               | and                 |
| $\frac{\phantom{x}}{\phantom{x}}$ | frac                |
| $g$                               | gra                 |
| maxY                              | maxY                |
| maxX                              | maxX                |
| $\Sigma y^2$                      | SigmaY2             |
| Ans                               | Ans                 |
| Ran#□                             | Ran#                |
| $\bar{x}$                         | x-bar               |
| $\bar{y}$                         | y-bar               |
| $\sigma_x$                        | sigmax              |
| sx                                | Sx                  |
| $\sigma_x$                        | sigmay              |
| sy                                | Sy                  |
| a                                 | Regression_a        |
| b                                 | Regression_b        |
| r                                 | Regression_r        |
| $\hat{x}$                         | x-hat               |
| $\hat{y}$                         | y-hat               |
| $r$                               | <r>                 |
| $\theta$                          | Theta               |
| $\Sigma y$                        | SigmaY              |
| $\pi$                             | pi                  |
| Cls                               | Cls                 |
| Rnd                               | Rnd                 |
| Dec                               | &D                  |
| Hex                               | &H                  |
| Bin                               | &B                  |
| Oct                               | &O                  |
| □                                 | @D8                 |
| Norm□                             | Norm□               |
| Deg                               | Deg                 |
| Rad                               | Rad                 |
| Gra                               | Gra                 |
| Eng                               | Eng                 |

| Command      | Text              |
|--------------|-------------------|
| Intg□        | Intg□             |
| $\Sigma xy$  | SigmaXY           |
| Plot□        | Plot□             |
| Line         | Line              |
| Lbl□         | Lbl□              |
| Fix□         | Fix□              |
| Sci□         | Sci□              |
| Dsz□         | Dsz□              |
| Isz□         | Isz□              |
| Factor□      | Factor□           |
| ViewWindow□  | ViewWindow□       |
| Goto□        | Goto□             |
| Prog□        | Prog□             |
| Graph□Y=     | Graph□Y=          |
| Graph□/      | Graph□Integral    |
| Graph□Y>     | Graph□Y>          |
| Graph□Y<     | Graph□Y<          |
| Graph□Y≥     | Graph□Y>=         |
| Graph□Y≤     | Graph□Y<=         |
| Graph□r=     | Graph□r=          |
| Graph(X,Y)=( | Graph(X,Y)=(      |
| ,            | Para,             |
| P(           | ProbP(            |
| Q(           | ProbQ(            |
| R(           | ProbR(            |
| t(           | Probt(            |
| Xmin         | Xmin              |
| Xmax         | Xmax              |
| Xscl         | Xscl              |
| Ymin         | Ymin              |
| Ymax         | Ymax              |
| Yscl         | Yscl              |
| Tθmin        | TThetamin         |
| Tθmax        | TThetamax         |
| Tθptch       | TThetaptch        |
| Xfct         | Xfct              |
| Yfct         | Yfct              |
| D□Start      | D□Start           |
| D□End        | D□End             |
| D□pitch      | D□pitch           |
| RightXmin    | RightXmin         |
| RightXmax    | RightXmax         |
| RightXscl    | RightXscl         |
| RightYmin    | RightYmin         |
| RightYmax    | RightYmax         |
| RightYscl    | RightYscl         |
| RightTθmin   | RightTThetamin    |
| RightTθmax   | RightTThetamax    |
| RightTθptch  | RightTThetaptch   |
| StdDev_σ(    | StdDev_sigma(     |
| Variance_σ²( | Variance_sigma^2( |
| c            | Regression_c      |
| d            | Regression_d      |
| e            | Regression_e      |
| Max(         | Max(              |

| Command    | Text         |
|------------|--------------|
| Det□       | Det□         |
| Arg□       | Arg□         |
| Conjg□     | Conjg□       |
| ReP□       | ReP□         |
| ImP□       | ImP□         |
| d/dx(      | d/dx(        |
| d²/dx²(    | d^2/dx^2(    |
| Solve(     | Solve(       |
| Σ(         | Sigma(       |
| FMin(      | FMin(        |
| FMax(      | FMax(        |
| Seq(       | Seq(         |
| Min(       | Min(         |
| Mean(      | Mean(        |
| Median(    | Median(      |
| SolveN(    | SolveN(      |
| Red□       | Red□         |
| Blue□      | Blue□        |
| Green□     | Green□       |
| MOD(       | MOD(         |
| MOD_Exp(   | MOD_Exp(     |
| GCD(       | GCD(         |
| LCM(       | LCM(         |
| StdDev(    | StdDev(      |
| Variance(  | Variance(    |
| Mat□       | Mat□         |
| Trn□       | Trn□         |
| *Row□      | *Row□        |
| *Row+□     | *Row+□       |
| Row+□      | Row+□        |
| Swap□      | Swap□        |
| Dim□       | Dim□         |
| Fill(      | Fill(        |
| Identity□  | Identity□    |
| Augment(   | Augment(     |
| List→Mat(  | List->Mat(   |
| Mat→List(  | Mat->List(   |
| Sum□       | Sum□         |
| Prod□      | Prod□        |
| Percent□   | Percent□     |
| Cuml□      | Cuml□        |
| i          | Imaginary    |
| List□      | List□        |
| ΔList□     | Dlist□       |
| ∞          | Infinity     |
| ∠          | Angle        |
| Ref□       | Ref□         |
| Rref□      | Rref□        |
| ►          | Conv         |
| Sim□Coef   | Sim□Coef     |
| Ply□Coef   | Ply□Coef     |
| Sim□Result | Sim□Result   |
| Ply□Result | Ply□Result   |
| n          | Financial□n  |
| I%         | Financial□I% |

| Command              | Text          |
|----------------------|---------------|
| PV                   | Financial□PV  |
| PMT                  | Financial□PMT |
| FV                   | Financial□FV  |
| List1                | List1         |
| List2                | List2         |
| List3                | List3         |
| List4                | List4         |
| List5                | List5         |
| List6                | List6         |
| Q <sub>1</sub>       | Q1            |
| Q <sub>3</sub>       | Q3            |
| x <sub>1</sub>       | x1            |
| y <sub>1</sub>       | y1            |
| x <sub>2</sub>       | x2            |
| y <sub>2</sub>       | y2            |
| x <sub>3</sub>       | x3            |
| y <sub>3</sub>       | y3            |
| Vct□                 | Vct□          |
| logab(               | logab(        |
| RndFix(              | RndFix(       |
| RanInt#(             | RanInt#(      |
| RanList#(            | RanList#(     |
| RanBin#(             | RanBin#(      |
| RanNorm#(            | RanNorm#(     |
| RanSamp#(            | RanSamp#(     |
| $\Sigma a_n$         | Sigmaan       |
| $\Sigma b_n$         | Sigmabn       |
| $\Sigma c_n$         | Sigmacn       |
| Getkey               | Getkey        |
| F□Result             | F□Result      |
| F□Start              | F□Start       |
| F□End                | F□End         |
| F□pitch              | F□pitch       |
| R□Result             | R□Result      |
| R□Start              | R□Start       |
| R□End                | R□End         |
| H□Start              | H□Start       |
| H□pitch              | H□pitch       |
| ►Simp□               | >Simp         |
| a <sub>n</sub>       | an□           |
| a <sub>n+1</sub>     | an+1          |
| a <sub>n+2</sub>     | an+2          |
| a <sub>n</sub>       | Subscriptn    |
| a <sup>0</sup>       | a0            |
| a <sup>1</sup>       | a1            |
| a <sup>2</sup>       | a2            |
| b <sub>n</sub>       | bn□           |
| b <sub>n+1</sub>     | bn+1          |
| b <sub>n+2</sub>     | bn+2          |
| b <sup>0</sup>       | b0            |
| b <sup>1</sup>       | b1            |
| b <sup>2</sup>       | b2            |
| a <sub>n</sub> Start | anStart       |
| b <sub>n</sub> Start | bnStart       |
| □And□                | □And□         |

| Command          | Text        |
|------------------|-------------|
| □Or□             | □Or□        |
| Not□             | □Not□       |
| □Xor□            | □Xor□       |
| $\Sigma a_{n+1}$ | Sigmaan+1   |
| $\Sigma b_{n+1}$ | Sigmabn+1   |
| $\Sigma c_{n+1}$ | Sigmacn+1   |
| $\Sigma a_{n+2}$ | Sigmaan+2   |
| $\Sigma b_{n+2}$ | Sigmabn+2   |
| $\Sigma c_{n+2}$ | Sigmacn+2   |
| □Int÷□           | □Int/□      |
| □Rmdr□           | □Rmdr□      |
| Fa               | Fa          |
| n1               | n1          |
| n2               | n2          |
| $\bar{x}_1$      | x-bar1      |
| $\bar{x}_2$      | x-bar2      |
| sx1              | sx1         |
| sx2              | sx2         |
| sp               | Sxp         |
| $\hat{p}$        | p-hat       |
| $\hat{p}_1$      | p-hat1      |
| $\hat{p}_2$      | p-hat2      |
| Lower            | Lower       |
| Upper            | Upper       |
| P/Y              | P/Year      |
| C/Y              | C/Year      |
| Fb               | Fb          |
| F                | F-Value     |
| z                | z-Value     |
| p                | p-Value     |
| t                | t-Value     |
| se               | se          |
| $\chi^2$         | x^2         |
| r <sup>2</sup>   | r^2         |
| Adf              | Adf         |
| Edf              | Edf         |
| df               | df          |
| SSa              | SSa         |
| MSa              | MSa         |
| SSE              | SSE         |
| MSE              | MSE         |
| Fab              | Fab         |
| Bdf              | Bdf         |
| ABdf             | ABdf        |
| pa               | pa          |
| pb               | pb          |
| pab              | pab         |
| CellSum(         | CellSum(    |
| CellProd(        | CellProd(   |
| CellMin(         | CellMin(    |
| CellMax(         | CellMax(    |
| CellMean(        | CellMean(   |
| CellMedian(      | CellMedian( |
| CellIf(          | CellIf(     |
| Y                | GraphY      |

| Command                | Text         |
|------------------------|--------------|
| r                      | Graphr       |
| Xt                     | GraphXt      |
| Yt                     | GraphYt      |
| X                      | GraphX       |
| SSb                    | SSb          |
| SSab                   | SSab         |
| MSb                    | MSb          |
| MSab                   | MSab         |
| [ns]                   | [ns]         |
| [ $\mu$ s]             | [micros]     |
| [ms]                   | [ms]         |
| [s]                    | [s]          |
| [min]                  | [min]        |
| [h]                    | [h]          |
| [day]                  | [day]        |
| [week]                 | [week]       |
| [yr]                   | [yr]         |
| [s-yr]                 | [s-yr]       |
| [t-yr]                 | [t-yr]       |
| [°C]                   | [Centigrade] |
| [K]                    | [Kel]        |
| [°F]                   | [Fahrenheit] |
| [°R]                   | [Rankine]    |
| [u]                    | [u]          |
| [g]                    | [g]          |
| [kg]                   | [kg]         |
| [lb]                   | [lb]         |
| [oz]                   | [oz]         |
| [slug]                 | [slug]       |
| [ton(short)]           | [ton(short)] |
| [ton(long)]            | [ton(long)]  |
| [mton]                 | [mton]       |
| [l-atm]                | [l-atm]      |
| [ft·lbf]               | [ftlbf]      |
| [calIT]                | [calIT]      |
| [calth]                | [calth]      |
| [Btu]                  | [Btu]        |
| [kW·h]                 | [kWh]        |
| [kgf·m]                | [kgfm]       |
| [Pa]                   | [Pa]         |
| [kPa]                  | [kPa]        |
| [bar]                  | [bar]        |
| [mmH <sub>2</sub> O]   | [mmH2O]      |
| [mmHg]                 | [mmHg]       |
| [inH <sub>2</sub> O]   | [inH2O]      |
| [inHg]                 | [inHg]       |
| [lbf/in <sup>2</sup> ] | [lbf/in^2]   |
| [kgf/cm <sup>2</sup> ] | [kgf/cm^2]   |
| [atm]                  | [atm]        |
| [dyne]                 | [dyne]       |
| [N]                    | [New]        |
| [kgf]                  | [kgf]        |
| [lbf]                  | [lbf]        |
| [tonf]                 | [tonf]       |
| [fm]                   | [fm]         |

| Command              | Text                 |
|----------------------|----------------------|
| [mm]                 | [mm]                 |
| [cm]                 | [cm]                 |
| [m]                  | [m]                  |
| [km]                 | [km]                 |
| [Mil]                | [Mil]                |
| [in]                 | [in]                 |
| [ft]                 | [ft]                 |
| [yd]                 | [yd]                 |
| [fath]               | [fath]               |
| [rd]                 | [rd]                 |
| [mile]               | [mile]               |
| [n□mile]             | [n_mile]             |
| [acre]               | [acre]               |
| [ha]                 | [ha]                 |
| [cm <sup>2</sup> ]   | [cm <sup>2</sup> ]   |
| [m <sup>2</sup> ]    | [m <sup>2</sup> ]    |
| [km <sup>2</sup> ]   | [km <sup>2</sup> ]   |
| [in <sup>2</sup> ]   | [in <sup>2</sup> ]   |
| [ft <sup>2</sup> ]   | [ft <sup>2</sup> ]   |
| [yd <sup>2</sup> ]   | [yd <sup>2</sup> ]   |
| [mile <sup>2</sup> ] | [mile <sup>2</sup> ] |
| [m/s]                | [m/s]                |
| [km/h]               | [km/h]               |
| [ft/s]               | [ft/s]               |
| [mile/h]             | [mile/h]             |
| [knot]               | [knot]               |
| [mL]                 | [mL]                 |
| [L]                  | [Lit]                |
| [tsp]                | [tsp]                |
| [cm <sup>3</sup> ]   | [cm <sup>3</sup> ]   |
| [m <sup>3</sup> ]    | [m <sup>3</sup> ]    |
| [tbsp]               | [tbsp]               |
| [in <sup>3</sup> ]   | [in <sup>3</sup> ]   |
| [ft <sup>3</sup> ]   | [ft <sup>3</sup> ]   |
| [fl_oz (UK)]         | [fl_oz(UK)]          |
| [fl_oz (US)]         | [fl_oz(US)]          |
| [cup]                | [cup]                |
| [pt]                 | [pt]                 |
| [qt]                 | [qt]                 |
| [gal (US)]           | [gal(US)]            |
| [gal (UK)]           | [gal(UK)]            |
| [μm]                 | [microm]             |
| [mg]                 | [mg]                 |
| [A]                  | [Ang]                |
| [AU]                 | [AstU]               |
| [l.y.]               | [l.y.]               |
| [pc]                 | [pc]                 |
| [ft·lbf/s]           | [ftlbf/s]            |
| [calth/s]            | [calth/s]            |
| [hp]                 | [hp]                 |
| [Btu/min]            | [Btu/min]            |
| [W]                  | [Wat]                |
| [eV]                 | [eV]                 |
| [erg]                | [erg]                |
| [J]                  | [Jou]                |

| Command               | Text             |
|-----------------------|------------------|
| [cal <sub>15</sub> ]  | [cal15]          |
| [kcal <sub>15</sub> ] | [kcal15]         |
| [kcalth]              | [kcalth]         |
| [kcalIT]              | [kcalIT]         |
| If□                   | If□              |
| Then□                 | Then□            |
| Else□                 | Else□            |
| IfEnd                 | IfEnd            |
| For□                  | For□             |
| □To□                  | □To□             |
| □Step□                | □Step□           |
| Next                  | Next             |
| While□                | While□           |
| WhileEnd              | WhileEnd         |
| Do                    | Do               |
| LpWhile□              | LpWhile□         |
| Return                | Return           |
| Break                 | Break            |
| Stop                  | Stop             |
| Locate□               | Locate□          |
| Send(                 | Send(            |
| Receive(              | Receive(         |
| OpenComport38k        | OpenComport38k   |
| CloseComport38k       | CloseComport38k  |
| Send38k□              | Send38k□         |
| Recieve38k□           | Recieve38k□      |
| ClrText               | ClrText          |
| ClrGraph              | ClrGraph         |
| ClrList□              | ClrList□         |
| LinearReg(a+bx)□      | LinearReg(a+bx)□ |
| S-L-Normal            | S-L-Normal       |
| S-L-Thick             | S-L-Thick        |
| S-L-Broken            | S-L-Broken       |
| S-L-Dot               | S-L-Dot          |
| DrawGraph             | DrawGraph        |
| PlotPhase□            | PlotPhase□       |
| DrawDyna              | DrawDyna         |
| DrawStat              | DrawStat         |
| DrawFTG-Con           | DrawFTG-Con      |
| DrawFTG-Plt           | DrawFTG-Plt      |
| DrawR-Con             | DrawR-Con        |
| DrawR-Plt             | DrawR-Plt        |
| DrawRΣ-Con            | DrawRSigma-Con   |
| DrawRΣ-Plt            | DrawRSigma-Plt   |
| DrawWeb□              | DrawWeb□         |
| NormalG□              | NormalG□         |
| ThickG□               | ThickG□          |
| BrokenThickG□         | BrokenThickG□    |
| DispF-Tbl             | DispF-Tbl        |
| DispR-Tbl             | DispR-Tbl        |
| SimplifyAuto          | SimplifyAuto     |
| SimplifyMan           | SimplifyMan      |
| NPPlot                | NPPlot           |
| Sinusoidal            | Sinusoidal       |
| SinReg□               | SinReg□          |

| Command                     | Text                       |
|-----------------------------|----------------------------|
| Logistic                    | Logistic                   |
| LogisticReg□                | LogisticReg□               |
| Pie                         | Pie                        |
| Bar                         | Bar                        |
| DotG□                       | DotG                       |
| 1-Variable□                 | 1-Variable□                |
| 2-Variable□                 | 2-Variable□                |
| LinearReg(ax+b)□            | LinearReg(ax+b)□           |
| Med-MedLine□                | Med-MedLine□               |
| QuadReg□                    | QuadReg□                   |
| CubicReg□                   | CubicReg□                  |
| QuartReg□                   | QuartReg□                  |
| LogReg□                     | LogReg□                    |
| ExpReg(a·e <sup>bx</sup> )□ | ExpReg(ae <sup>bx</sup> )□ |
| PowerReg□                   | PowerReg□                  |
| S-Gph1□                     | S-Gph1□                    |
| S-Gph2□                     | S-Gph2□                    |
| S-Gph3□                     | S-Gph3□                    |
| Square                      | Square                     |
| Cross                       | Cross                      |
| Dot                         | Dot                        |
| Scatter                     | Scatter                    |
| xyLine                      | xyLine                     |
| Hist                        | Hist                       |
| MedBox                      | MedBox                     |
| N-Dist                      | N-Dist                     |
| Broken                      | Broken                     |
| Linear                      | Linear                     |
| Med-Med                     | Med-Med                    |
| Quad                        | Quad                       |
| Cubic                       | Cubic                      |
| Quart                       | Quart                      |
| Log                         | Log                        |
| Exp(a·e <sup>bx</sup> )     | Exp(ae <sup>bx</sup> )     |
| Power                       | Power                      |
| ExpReg(a·b <sup>x</sup> )□  | ExpReg(ab <sup>x</sup> )□  |
| S-WindAuto                  | S-WindAuto                 |
| S-WindMan                   | S-WindMan                  |
| Graph□X=                    | Graph□X=                   |
| Y=Type                      | Y=Type                     |
| r=Type                      | r=Type                     |
| ParamType                   | ParamType                  |
| X=Type                      | X=Type                     |
| X>Type                      | X>Type                     |
| X<Type                      | X<Type                     |
| Y>Type                      | Y>Type                     |
| Y<Type                      | Y<Type                     |
| Y≥Type                      | Y≥Type                     |
| Y≤Type                      | Y≤Type                     |
| X≥Type                      | X≥Type                     |
| X≤Type                      | X≤Type                     |
| G-Connect                   | G-Connect                  |
| G-Plot                      | G-Plot                     |
| Resid-None                  | Resid-None                 |
| Resid-List□                 | Resid-List□                |

| Command                                                 | Text                                                    |
|---------------------------------------------------------|---------------------------------------------------------|
| BG-None                                                 | BG-None                                                 |
| BG-Pict <input type="checkbox"/>                        | BG-Pict <input type="checkbox"/>                        |
| GridOff                                                 | GridOff                                                 |
| GridLine                                                | GridLine                                                |
| GridOn                                                  | GridOn                                                  |
| Exp(a·b^x)                                              | Exp(a^bx)                                               |
| D <input type="checkbox"/> Var <input type="checkbox"/> | D <input type="checkbox"/> Var <input type="checkbox"/> |
| Q1Q3TypeStd                                             | Q1Q3TypeStd                                             |
| VarRange                                                | VarRange                                                |
| Q1Q3TypeOnData                                          | Q1Q3TypeOnData                                          |
| SketchNormal <input type="checkbox"/>                   | SketchNormal <input type="checkbox"/>                   |
| SketchThick <input type="checkbox"/>                    | SketchThick <input type="checkbox"/>                    |
| SketchBroken <input type="checkbox"/>                   | SketchBroken <input type="checkbox"/>                   |
| SketchDot <input type="checkbox"/>                      | SketchDot <input type="checkbox"/>                      |
| a <sub>n</sub> Type                                     | a <sub>n</sub> Type                                     |
| a <sub>n+1</sub> Type                                   | a <sub>n+1</sub> Type                                   |
| a <sub>n+2</sub> Type                                   | a <sub>n+2</sub> Type                                   |
| StoPict <input type="checkbox"/>                        | StoPict <input type="checkbox"/>                        |
| RclPict <input type="checkbox"/>                        | RclPict <input type="checkbox"/>                        |
| StoGMEM <input type="checkbox"/>                        | StoGMEM <input type="checkbox"/>                        |
| RclGMEM <input type="checkbox"/>                        | RclGMEM <input type="checkbox"/>                        |
| StoV-Win <input type="checkbox"/>                       | StoV-Win <input type="checkbox"/>                       |
| RclV-Win <input type="checkbox"/>                       | RclV-Win <input type="checkbox"/>                       |
| %                                                       | Display%                                                |
| Data                                                    | DisplayData                                             |
| Menu <input type="checkbox"/>                           | Menu <input type="checkbox"/>                           |
| RclCapt <input type="checkbox"/>                        | RclCapt <input type="checkbox"/>                        |
| Tangent <input type="checkbox"/>                        | Tangent <input type="checkbox"/>                        |
| Normal <input type="checkbox"/>                         | Normal <input type="checkbox"/>                         |
| Inverse <input type="checkbox"/>                        | Inverse <input type="checkbox"/>                        |
| Vertical <input type="checkbox"/>                       | Vertical <input type="checkbox"/>                       |
| Horizontal <input type="checkbox"/>                     | Horizontal <input type="checkbox"/>                     |
| Text <input type="checkbox"/>                           | Text <input type="checkbox"/>                           |
| Circle <input type="checkbox"/>                         | Circle <input type="checkbox"/>                         |
| F-Line <input type="checkbox"/>                         | F-Line <input type="checkbox"/>                         |
| PlotOn <input type="checkbox"/>                         | PlotOn <input type="checkbox"/>                         |
| PlotOff <input type="checkbox"/>                        | PlotOff <input type="checkbox"/>                        |
| PlotChg <input type="checkbox"/>                        | PlotChg <input type="checkbox"/>                        |
| PxlOn <input type="checkbox"/>                          | PxlOn <input type="checkbox"/>                          |
| PxlOff <input type="checkbox"/>                         | PxlOff <input type="checkbox"/>                         |
| PxlChg <input type="checkbox"/>                         | PxlChg <input type="checkbox"/>                         |
| PxlTest(                                                | PxlTest(                                                |
| SortA(                                                  | SortA(                                                  |
| SortD(                                                  | SortD(                                                  |
| VarList1                                                | VarList1                                                |
| VarList2                                                | VarList2                                                |
| VarList3                                                | VarList3                                                |
| VarList4                                                | VarList4                                                |
| VarList5                                                | VarList5                                                |
| VarList6                                                | VarList6                                                |
| File1                                                   | File1                                                   |
| File2                                                   | File2                                                   |
| File3                                                   | File3                                                   |
| File4                                                   | File4                                                   |
| File5                                                   | File5                                                   |

| Command                                                    | Text                                                       |
|------------------------------------------------------------|------------------------------------------------------------|
| File6                                                      | File6                                                      |
| Y=DrawSpeedNorm                                            | Y=DrawSpeedNorm                                            |
| Y=DrawSpeedHigh                                            | Y=DrawSpeedHigh                                            |
| FuncOn                                                     | FuncOn                                                     |
| SimulOn                                                    | SimulOn                                                    |
| AxesOn                                                     | AxesOn                                                     |
| CoordOn                                                    | CoordOn                                                    |
| LabelOn                                                    | LabelOn                                                    |
| DerivOn                                                    | DerivOn                                                    |
| LocusOn                                                    | LocusOn                                                    |
| ΣdispOn                                                    | SigmadispOn                                                |
| G <input type="checkbox"/> SelOn <input type="checkbox"/>  | G <input type="checkbox"/> SelOn <input type="checkbox"/>  |
| T <input type="checkbox"/> SelOn <input type="checkbox"/>  | T <input type="checkbox"/> SelOn <input type="checkbox"/>  |
| D <input type="checkbox"/> SelOn <input type="checkbox"/>  | D <input type="checkbox"/> SelOn <input type="checkbox"/>  |
| R <input type="checkbox"/> SelOn <input type="checkbox"/>  | R <input type="checkbox"/> SelOn <input type="checkbox"/>  |
| DrawOn                                                     | DrawOn                                                     |
| ab/c                                                       | ab/c                                                       |
| d/c                                                        | d/c                                                        |
| FuncOff                                                    | FuncOff                                                    |
| SimulOff                                                   | SimulOff                                                   |
| AxesOff                                                    | AxesOff                                                    |
| CoordOff                                                   | CoordOff                                                   |
| LabelOff                                                   | LabelOff                                                   |
| DerivOff                                                   | DerivOff                                                   |
| LocusOff                                                   | LocusOff                                                   |
| ΣdispOff                                                   | SigmadispOff                                               |
| G <input type="checkbox"/> SelOff <input type="checkbox"/> | G <input type="checkbox"/> SelOff <input type="checkbox"/> |
| T <input type="checkbox"/> SelOff <input type="checkbox"/> | T <input type="checkbox"/> SelOff <input type="checkbox"/> |
| D <input type="checkbox"/> SelOff <input type="checkbox"/> | D <input type="checkbox"/> SelOff <input type="checkbox"/> |
| R <input type="checkbox"/> SelOff <input type="checkbox"/> | R <input type="checkbox"/> SelOff <input type="checkbox"/> |
| DrawOff                                                    | DrawOff                                                    |
| ►Dec                                                       | >&D                                                        |
| ►Hex                                                       | >&H                                                        |
| ►Bin                                                       | >&B                                                        |
| ►Oct                                                       | >&O                                                        |
| ►DMS                                                       | >DMS                                                       |
| ►a+bi                                                      | >a+bi                                                      |
| ►r∠θ                                                       | >re^Theta                                                  |
| Real                                                       | Real                                                       |
| a+bi                                                       | a+bi                                                       |
| r∠θ                                                        | re^Theta                                                   |
| EngOn                                                      | EngOn                                                      |
| EngOff                                                     | EngOff                                                     |
| Sel <input type="checkbox"/> a <sub>0</sub>                | Sel <input type="checkbox"/> a <sub>0</sub>                |
| Sel <input type="checkbox"/> a <sub>1</sub>                | Sel <input type="checkbox"/> a <sub>1</sub>                |
| c <sub>n</sub>                                             | cn <input type="checkbox"/>                                |
| c <sub>n+1</sub>                                           | cn+1                                                       |
| c <sub>n+2</sub>                                           | cn+2                                                       |
| c <sub>0</sub>                                             | c0                                                         |
| c <sub>1</sub>                                             | c1                                                         |
| c <sub>2</sub>                                             | c2                                                         |
| c <sub>n</sub> Start                                       | CnStart                                                    |
| IneqTypeIntsect                                            | IneqTypeIntsect                                            |
| f <sub>n</sub>                                             | fn                                                         |
| File <input type="checkbox"/>                              | File <input type="checkbox"/>                              |

| Command                               | Text                                  |
|---------------------------------------|---------------------------------------|
| VarList <input type="checkbox"/>      | VarList <input type="checkbox"/>      |
| ClrMat <input type="checkbox"/>       | ClrMat <input type="checkbox"/>       |
| ZoomAuto                              | ZoomAuto                              |
| Xdot                                  | Xdot                                  |
| RightXdot                             | R-Xdot                                |
| DrawDistNorm <input type="checkbox"/> | DrawDistNorm <input type="checkbox"/> |
| DrawDistT <input type="checkbox"/>    | DrawDistT <input type="checkbox"/>    |
| DrawDistChi <input type="checkbox"/>  | DrawDistChi <input type="checkbox"/>  |
| DrawDistF <input type="checkbox"/>    | DrawDistF <input type="checkbox"/>    |
| None                                  | None                                  |
| StickLength                           | StickLength                           |
| StickHoriz                            | StickHoriz                            |
| IneqTypeUnion                         | IneqTypeUnion                         |
| Graph <input type="checkbox"/> X>     | Graph <input type="checkbox"/> X>     |
| Graph <input type="checkbox"/> X<     | Graph <input type="checkbox"/> X<     |
| Graph <input type="checkbox"/> X≥     | Graph <input type="checkbox"/> X>=    |
| Graph <input type="checkbox"/> X≤     | Graph <input type="checkbox"/> X<=    |
| StrJoin(                              | StrJoin(                              |
| StrLen(                               | StrLen(                               |
| StrCmp(                               | StrCmp(                               |
| StrSrc(                               | StrSrc(                               |
| StrLeft(                              | StrLeft(                              |
| StrRight(                             | StrRight(                             |
| StrMid(                               | StrMid(                               |
| Exp►Str(                              | Exp>Str(                              |
| Exp(                                  | Exp(                                  |
| StrUpr(                               | StrUpr(                               |
| StrLwr(                               | StrLwr(                               |
| StrInv(                               | StrInv(                               |
| StrShift(                             | StrShift(                             |
| StrRotate(                            | StrRotate(                            |
| ClrVct <input type="checkbox"/>       | ClrVct <input type="checkbox"/>       |
| Str <input type="checkbox"/>          | Str <input type="checkbox"/>          |
| CrossP(                               | CrossP(                               |
| DotP(                                 | DotP(                                 |
| Norm(                                 | Norm(                                 |
| UnitV(                                | UnitV(                                |
| Angle(                                | Angle(                                |
| ColorAuto <input type="checkbox"/>    | ColorAuto <input type="checkbox"/>    |
| ColorLighter <input type="checkbox"/> | ColorLighter <input type="checkbox"/> |
| ColorLinkX&Y                          | ColorLinkX&Y                          |
| ColorLinkOnlyX                        | ColorLinkOnlyX                        |
| ColorLinkOnlyY                        | ColorLinkOnlyY                        |
| ColorLinkOn                           | ColorLinkOn                           |
| ColorLinkOff                          | ColorLinkOff                          |
| ColorNormal <input type="checkbox"/>  | ColorNormal <input type="checkbox"/>  |
| ERROR                                 | ERROR                                 |
| BLANK                                 | BLANK                                 |
| ColorClr <input type="checkbox"/>     | ColorClr <input type="checkbox"/>     |
| ColorLinkX&Freq                       | ColorLinkX&Freq                       |
| NormPD(                               | NormPD(                               |
| NormCD(                               | NormCD(                               |
| InvNormCD(                            | InvNormCD(                            |
| tPD(                                  | tPD(                                  |
| tCD(                                  | tCD(                                  |

| Command          | Text             |
|------------------|------------------|
| InvTCD(          | InvTCD(          |
| ChiPD(           | ChiPD(           |
| ChiCD(           | ChiCD(           |
| InvChiCD(        | InvChiCD(        |
| FPD(             | FPD(             |
| FCD(             | FCD(             |
| InvFCD(          | InvFCD(          |
| BinomialPD(      | BinomialPD(      |
| BinomialCD(      | BinomialCD(      |
| InvBinomialCD(   | InvBinomialCD(   |
| PoissonPD(       | PoissonPD(       |
| PoissonCD(       | PoissonCD(       |
| InvPoissonCD(    | InvPoissonCD(    |
| GeoPD(           | GeoPD(           |
| GeoCD(           | GeoCD(           |
| InvGeoCD(        | InvGeoCD(        |
| HypergeoPD(      | HypergeoPD(      |
| HypergeoCD(      | HypergeoCD(      |
| InvHypergeoCD(   | InvHypergeoCD(   |
| SetG-Color□      | SetG-Color□      |
| Plot/Line-Color□ | Plot/Line-Color□ |
| AxesScale        | AxesScale        |
| Black□           | Black□           |
| Magenta□         | Magenta□         |
| Cyan□            | Cyan□            |
| Yellow□          | Yellow□          |
| Smpl_SI(         | Smpl_SI(         |
| Smpl_SFV(        | Smpl_SFV(        |
| Cmpd_n(          | Cmpd_n(          |
| Cmpd_I%(         | Cmpd_I%(         |
| Cmpd_PV(         | Cmpd_PV(         |
| Cmpd_PMT(        | Cmpd_PMT(        |
| Cmpd_FV(         | Cmpd_FV(         |
| Cash_NPV(        | Cash_NPV(        |
| Cash_IRR(        | Cash_IRR(        |
| Cash_PBP(        | Cash_PBP(        |
| Cash_NFV(        | Cash_NFV(        |
| Amt_BAL(         | Amt_BAL(         |
| Amt_INT(         | Amt_INT(         |
| Amt_PRN(         | Amt_PRN(         |
| Amt_ΣINT(        | Amt_SigmaINT(    |
| Amt_ΣPRN(        | Amt_SigmaPRN(    |
| Cnvt_EFF(        | Cnvt_EFF(        |
| Cnvt_APR(        | Cnvt_APR(        |
| Cost(            | Cost(            |
| Sell(            | Sell(            |
| Margin(          | Margin(          |
| PmtEnd           | PmtEnd           |
| PmtBgn           | PmtBgn           |
| Bond_PRC(        | Bond_PRC(        |
| Bond_YLD(        | Bond_YLD(        |
| DateMode365      | DateMode365      |
| DateMode360      | DateMode360      |
| PeriodsAnnual    | PeriodsAnnual    |
| PeriodsSemi      | PeriodsSemi      |

| Command         | Text            |
|-----------------|-----------------|
| Days_Prd(       | Days_Prd(       |
| OneSampleZTest□ | OneSampleZTest□ |
| TwoSampleZTest□ | TwoSampleZTest□ |
| OnePropZTest□   | OnePropZTest□   |
| TwoPropZTest□   | TwoPropZTest□   |
| OneSampleTTest□ | OneSampleTTest□ |
| TwoSampleTTest□ | TwoSampleTTest□ |
| LinRegTTest□    | LinRegTTest□    |
| ChiGOFTest□     | ChiGOFTest□     |
| ChiTest□        | ChiTest□        |
| TwoSampleFTest□ | TwoSampleFTest□ |
| OneWayANOVA□    | OneWayANOVA□    |
| TwoWayANOVA□    | TwoWayANOVA□    |
| x1InvN          | x1InvN          |
| x2InvN          | x2InvN          |
| xInv            | xInv            |
| SketchThin□     | SketchThin□     |
| S-L-Thin        | S-L-Thin        |
| ThinG□          | ThinG□          |
| zLow            | zLow            |
| zUp             | zUp             |
| tLow            | tLow            |
| tUp             | tUp             |

On Version OS 1.01,  
following commands are  
converted as follows.

| Command        | Text  |
|----------------|-------|
| !              | !!    |
| ²              | ^2    |
| -1             | ^-1   |
| a <sub>n</sub> | an    |
| b <sub>n</sub> | bn    |
| [K]            | [K]   |
| [N]            | [N]   |
| [L]            | [L]   |
| [A]            | [A]   |
| [AU]           | [AU]  |
| [W]            | [W]   |
| [J]            | [J]   |
| c <sub>n</sub> | cn    |
| E              | ^E    |
| -              | --    |
| r              | Gamma |

# 9. Program Library

- Be sure to check how many bytes of unused memory are remaining before attempting to perform any programming.

| Program Name | Prime Factorization |
|--------------|---------------------|
|--------------|---------------------|

### Description

This program accepts input of natural number A, and divides it by B (2, 3, 5, 7....) to find the prime factors of A.

- If a division operation does not produce a remainder, the result of the operation is assigned to A.
- The above procedure is repeated until  $B > A$ .

### Purpose

This program continually divides a natural number by factors until all its prime factors are produced.

**Example**       $462 = 2 \times 3 \times 7 \times 11$

```

ClrText↵
"INPUT NUMBER"?→A↵
2→B↵
Do↵
While Frac (A÷B)=0↵
B↵
A÷B→A↵
WhileEnd↵
If B=2↵
Then 3→B↵
Else B+2→B↵
IfEnd↵
LpWhile B≤A↵
"END"
    
```

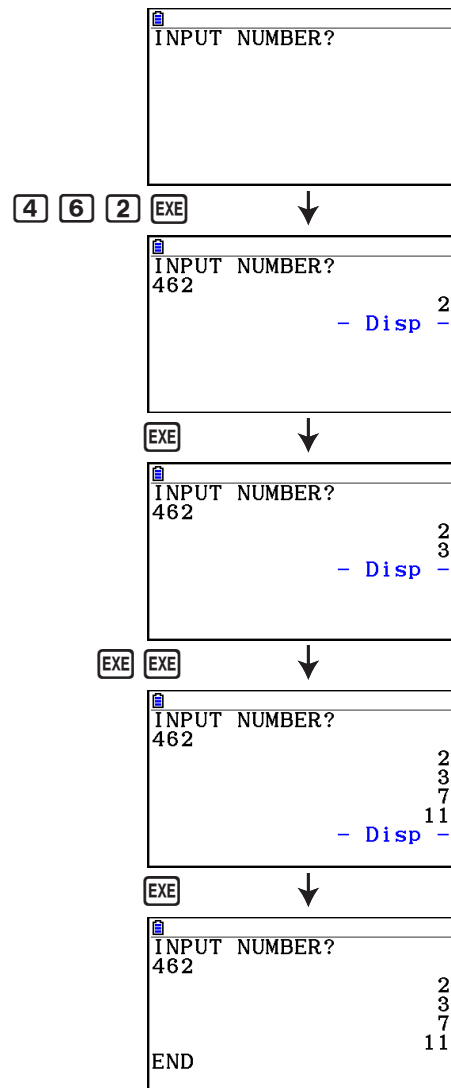



## Program Name

## Ellipse

### Description

This program displays a number table of the following values based on input of the foci of an ellipse, the sum of the distance between the loci and foci, and the pitch (step size) of X.

Y1: Coordinate values of upper half of ellipse

Y2: Coordinate values of lower half of ellipse

Y3: Distances between right focus and loci

Y4: Distances between left focus and loci

Y5: Sum of Y3 and Y4

Next, the program plots the foci and values in Y1 and Y2.

### Purpose

This program shows that the sums of the distances between the loci and two foci of an ellipse are equal.

```

AxesOff↵
Do↵
ClrText↵
"FOCUS (C,0),(-C,0)"↵
"C=?"→C↵
"SUM DISTANCE"?→D↵
LpWhile 2Abs C≥D Or D≤0↵
D÷2→A↵
√(A²-C²)→B↵
Y=Type↵
"B√(1-X²÷A²)"→Y1↵
"-Y1"→Y2↵
"√((X-C)²+Y1²)"→Y3↵
"√((X+C)²+Y1²)"→Y4↵
"Y3+Y4"→Y5↵
For 1→E To 20↵
If E≤5↵
Then T SelOn E↵
Else T SelOff E↵
IfEnd↵
Next↵
-Int A→F Start↵
Int A→F End↵
"F pitch"?→F pitch↵
DispF-Tbl↵
ClrGraph↵
1.2A→Xmax↵
-1.2A→Xmin↵
1.2B→Ymax↵
-1.2B→Ymin↵
T SelOff 3↵
T SelOff 4↵
T SelOff 5↵
DispF-Tbl↵
DrawFTG-Plt↵
PlotOn C,0↵
PlotOn -C,0↵
"END"
    
```

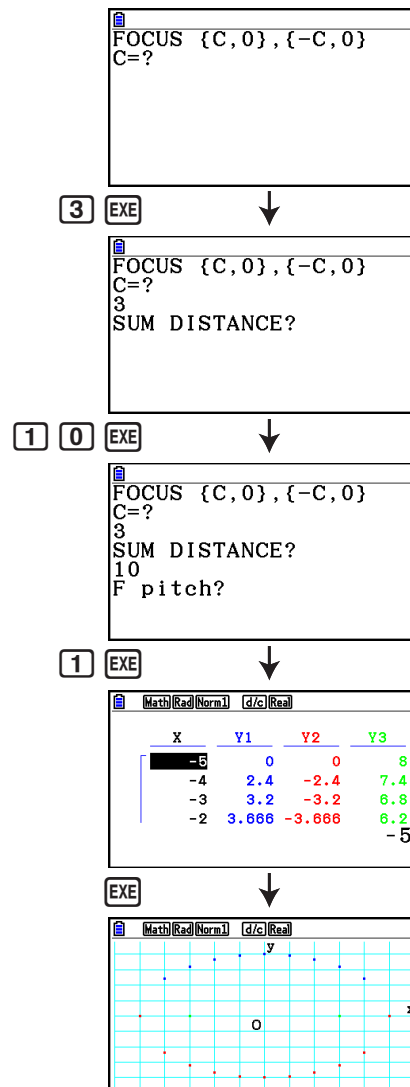

# Chapter 9 Spreadsheet

The Spreadsheet application provides you with powerful, take-along-anywhere spreadsheet capabilities.

All of the operations in this section are performed in the **Spreadsheet** mode.

## Note

A Memory ERROR may occur during a **Spreadsheet** mode operation if main memory capacity is low. If this happens, delete some input data or **Memory** mode data in order to increase available free space.

## 1. Spreadsheet Basics and the Function Menu

Selecting **Spreadsheet** on the Main Menu will display a spreadsheet screen. Entering the **Spreadsheet** mode automatically creates a new spreadsheet file named "SHEET".

The spreadsheet screen shows a number of cells (squares) and the data contained in each cell.

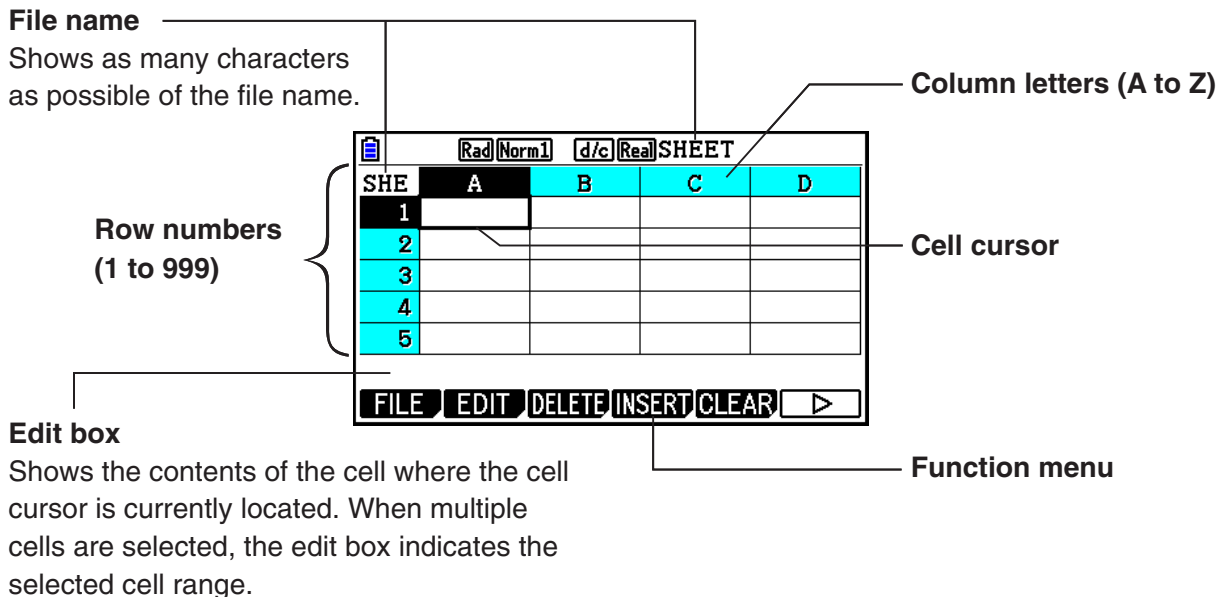

You can enter the following types of data into a cell.

**Constants** A constant is something whose value is fixed as soon as you finalize its input. A constant can be either a numeric value, or a calculation formula (such as  $7+3$ ,  $\sin 30$ ,  $A1 \times 2$ , etc.) that does not have an equal sign (=) in front of it.

**Text** A character string that starts with a quote mark (") is treated as text.

**Formula** A formula that starts out with an equal sign (=), such as  $=A1 \times 2$ , is executed as it is written.

Note that complex numbers are not supported in the **Spreadsheet** mode.

### Spreadsheet Mode Restrictions

The maximum file size that can be handled by the **Spreadsheet** mode is 30KB. Note, however, that the actual maximum file size depends on the type of data input into the spreadsheet and condition formatting settings. Also note that the maximum file size changes in accordance with the amount of main memory available.

## Restrictions on the Use of Spreadsheet Strips in the eActivity Mode

Main Memory data storage capacity is approximately 60KB. Approximately half of that (a little less than 30KB) is the maximum amount of data storage available in the **eActivity** mode. Approximately half of the **eActivity** mode storage memory (a little less than 15KB) is the maximum allowable Spreadsheet file size in the **eActivity** mode.

Because of this, inserting a Spreadsheet strip into an eActivity and performing a spreadsheet operation can cause limitations due to insufficient memory capacity. The following are examples of conditions that would cause the maximum file size to be exceeded.

(1) Inputting numeric data into spreadsheet cells A1 through A999, B1 through B999, and C1 through C520

In this case, the Spreadsheet strip of the eActivity will show only A1 through A999 and B1 through B80.

(2) Without inputting any data into the spreadsheet, assigning the conditional formatting shown below to all of the cells from A1 through A999 and B1 through B430

- For "Type", select "Expression".

- Input the following expression:  $B1=2 A1^3+3 A1^2+4 A1+5$ .

In this case, the Spreadsheet strip of the eActivity will show only A1 through A999 and B1 through B410.

---

## ■ Spreadsheet Screen Function Menu

- **{FILE}** ... Displays the following FILE submenu.
  - **{NEW}/{OPEN}/{SAVE • AS}/{RECALCS}/{CSV}**
- **{EDIT}** ... Displays the following EDIT submenu.
  - **{CUT}/{PASTE}/{COPY}/{CELL}/{JUMP}/{SEQ}/{FILL}/{SORTASC}/{SORTDES}**
  - PASTE is displayed only immediately after CUT or COPY is executed.
- **{DELETE}** ... Displays the following DELETE submenu.
  - **{ROW}/{COLUMN}/{ALL}**
- **{INSERT}** ... Displays the following INSERT submenu.
  - **{ROW}/{COLUMN}**
- **{CLEAR}** ... Displays the following CLEAR submenu.
  - **{CONTENT}/{FORMAT}/{ALL}**
- **{GRAPH}** ... Displays the following GRAPH menu. (Same as in the **Statistics** mode.)
  - **{GRAPH1}/{GRAPH2}/{GRAPH3}/{SELECT}/{SET}**
- **{CALC}** ... Displays the following CALC (statistical calculation) menu. (Same as in the **Statistics** mode.)
  - **{1-VAR}/{2-VAR}/{REG}/{SET}**
- **{STORE}** ... Displays the following STORE submenu.
  - **{VAR}/{LIST}/{FILE}/{MAT}/{VCT}**
- **{RECALL}** ... Displays the following RECALL submenu.
  - **{LIST}/{FILE}/{MAT}/{VCT}**
- **{CONDIT}** ... Displays the conditional formatting setting screen.
  - **{COND1}/{COND2}** ... Displays the {Condition1}/{Condition2} screens.

### Data Entry Function Menu

- {GRAB} ... Enters the GRAB mode for entering a cell reference name.
- {\$} ... Inputs the cell absolute reference command (\$).
- {:} ... Inputs the cell range specification command (:).
- {If} ... Inputs the CellIf( command.
- {CELL} ... Displays a submenu for inputting the following commands.
  - CellMin(, CellMax(, CellMean(, CellMedian(, CellSum(, CellProd(
- {RELATNL} ... Displays a submenu for inputting the following relational operators.
  - =, ≠, >, <, ≥, ≤

## 2. Basic Spreadsheet Operations

This section explains spreadsheet file operations, how to move the cursor and select one or more cells, and how to enter and edit data.

---

### ■ Spreadsheet File Operations

---

#### • To create a new file

1. Press **F1** (FILE) **F1** (NEW).
2. On the dialog box that appears, enter up to eight characters for the file name, and then press **EXE**.
  - This will create a new file and display a blank spreadsheet.
  - A new file will not be created if there is already a file with the same file name you enter in step 2. Instead, the existing file will be opened.

---

#### • To open a file

1. Press **F1** (FILE) **F2** (OPEN).
2. On the file list that appears, use **▲** and **▼** to select the file you want and then press **EXE**.

---

#### • Auto Save

In the **Spreadsheet** mode, Auto Save saves the currently open file automatically whenever you edit it. This means you do not need to perform any manual save operation.

---

#### • To save a file under a new name

1. Press **F1** (FILE) **F3** (SAVE • AS).
2. On the dialog box that appears, enter up to eight characters for the new file name, and then press **EXE**.
  - If a file already exists with the same file name you enter in step 2, a message will appear asking if you want to replace the existing file with the new one. Press **F1** (Yes) to replace the existing file, or **F6** (No) to cancel the save operation and return to the file name input dialog box in step 2.

---

### • To delete a file

1. Press **F1** (FILE) **F2** (OPEN).
2. On the file list that appears, use **▲** and **▼** to select the file you want to delete and then press **F1** (DELETE).
3. This causes a confirmation message to appear. Press **F1** (Yes) to delete the file, or **F6** (No) to cancel without deleting anything.
4. To return to the spreadsheet from the file list, press **EXIT**.
  - Deleting the currently open file will automatically create a new file named “SHEET” and display its spreadsheet.

---

## ■ Transferring Data between a Spreadsheet and CSV Files

You can import the contents of a CSV file stored with this calculator or transferred from a computer into a spreadsheet. You also can save the contents of a spreadsheet as a CSV file.

---

### • To import the contents of a CSV file to a spreadsheet

1. Prepare the CSV file you want to import.
  - See “Import CSV File Requirements” (page 3-18).
2. Press **F1** (FILE) **F5** (CSV) **F1** (LOAD).
  - Pressing **EXE** in the next step will overwrite all of the data on the spreadsheet with the CSV file data.
3. On the select file dialog box that appears, use **▲** and **▼** to move the highlighting to the file you want to import and then press **EXE**.
  - This imports the contents of the CSV file you specified to the spreadsheet.

### ***Important!***

- All blank data in the CSV file is imported as a blank cell.
- An error occurs if a CSV file contains even a single text string data item.
- If the CSV file includes data that cannot be converted, an error message will appear showing the location in the CSV file (Example: row 2, column 3) where the data that cannot be converted is located.
- Attempting to import a CSV file that has more than 26 columns or 999 rows will cause an “Invalid Data Size” error.

---

### • To save spreadsheet contents as a CSV file

1. If required, press **F1** (FILE) **F4** (RECALCS) to recalculate the spreadsheet contents.
  - Note that recalculation is not performed automatically when you save spreadsheet contents to a CSV file. Be sure to perform recalculation if the spreadsheet contains a formula, which starts with an equals symbol (=). See “Inputting a Formula into a Cell” (page 9-10) for more information.
  - Formulas are not saved to the CSV file. Only calculation results are saved.
  - All ERROR cell data on the spreadsheet is saved as blank data.

2. Press **F1** (FILE) **F5** (CSV) **F2** (SAVE • AS).
  - This displays a folder selection screen.
3. Select the folder where you want to save the CSV file.
  - To store the CSV file in the root directory, highlight “ROOT”.
  - To store the CSV file in a folder, use **▲** and **▼** to move the highlighting to the desired folder and then press **F1** (OPEN).
4. Press **F1** (SAVE • AS).
5. Input up to eight characters for the file name and then press **EXE**.
  - For information about how certain types of data is converted when being saved to a CSV file, see the “Important!” note under “To save matrix contents as a CSV file” (page 2-48).

---

- **To specify the CSV file delimiter symbol and decimal point**

Press **F1** (FILE) **F5** (CSV) **F3** (SET) to display the CSV format setting screen. Next, perform the procedure from step 3 under “Specifying the CSV File Delimiter Symbol and Decimal Point” (page 3-20).

---

## ■ Recalculating All of the Formulas in the Currently Open Spreadsheet

The **Spreadsheet** mode has an “Auto Calc” function that automatically recalculates all formulas in a spreadsheet whenever you open a file or perform an editing operation in the **Spreadsheet** mode. Auto Calc is one of the Spreadsheet setup items (page 1-35).

The initial factory default setting for Auto Calc is “On” (auto recalculation enabled). Note that depending on the content of the spreadsheet, auto recalculation can take a long time to complete. When Auto Calc is disabled (Off), you need to execute recalculation manually as required. Note that you can perform manual recalculation at any time, regardless of the current Auto Calc setting.

---

- **To execute spreadsheet re-calculation manually**

Press **F1** (FILE) **F4** (RECALCS). This recalculates all of the formulas in the currently open file and displays the applicable results.

### ***Important!***

- Regardless of the current Auto Calc setting, pressing **AC** will immediately terminate an ongoing recalculation operation. Note, however, that pressing **AC** will not return the spreadsheet that was being recalculated to its previous values. Any cells that were already recalculated when you pressed **AC** will show their new (recalculated) values.

## ■ Using the Cell Cursor

The cell cursor shows the cell that is selected on a spreadsheet. The highlighted cell is the one that is currently selected by the cell cursor.

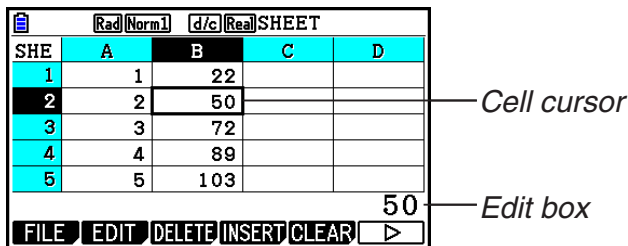

When a single cell is selected by the cell cursor, the contents of that cell are displayed in the edit box. The cell contents can be edited in the edit box.

When a multiple cells are selected by the cell cursor, the selection range is displayed in the edit box. In this case, you can copy, delete, or perform other cell operations on the entire range of selected cells.

### ● To select cells

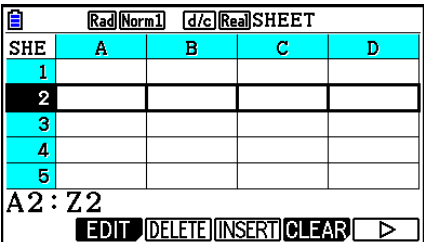
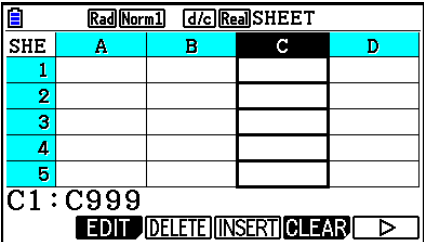
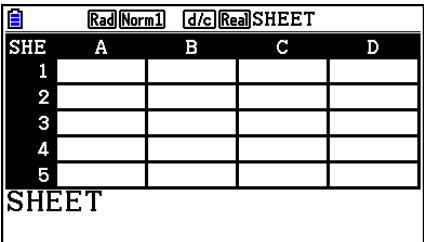
| To select this:                                                                                                            | Do this:                                                                                                                                                                                                                                                                                                     |
|----------------------------------------------------------------------------------------------------------------------------|--------------------------------------------------------------------------------------------------------------------------------------------------------------------------------------------------------------------------------------------------------------------------------------------------------------|
| A single cell                                                                                                              | Use the cursor keys to move the cell cursor to the cell you want, or use the JUMP comment to jump directly to the cell.                                                                                                                                                                                      |
| A range of cells                                                                                                           | See "To select a range of cells" (page 9-7).                                                                                                                                                                                                                                                                 |
| An entire row of cells<br>              | Move the cell cursor to column A of the row whose cells you want to select and then press ◀. Pressing ◀ while the cell cursor is located at cell A2, for example, will select the entire second row (from A2 to Z2). This will cause A2:Z2 (which indicates the selected range) to appear in the edit box.   |
| An entire column of cells<br>           | Move the cell cursor to row 1 of the column whose cells you want to select and then press ▲. Pressing ▲ while the cell cursor is located at cell C1, for example, will select the entire column C (from C1 to C999). This will cause C1:C999 (which indicates the selected range) to appear in the edit box. |
| All of the cells in the spreadsheet<br> | Press ◀ while the entire column A is selected or press ▲ while the entire row 1 is selected. This will select all of the cells in the spreadsheet and display the spreadsheet file name in the edit box.                                                                                                     |

## • Using the JUMP Command to Move the Cell Cursor

| To move the cell cursor to here: | Do this:                                                                                                                                                                                     |
|----------------------------------|----------------------------------------------------------------------------------------------------------------------------------------------------------------------------------------------|
| A particular cell                | 1. Press <b>F2</b> (EDIT) <b>F4</b> (JUMP) <b>F1</b> (GO).<br>2. On the dialog box that appears, enter the name of the cell (A1 to Z999) to which you want to jump.<br>3. Press <b>EXE</b> . |
| Line 1 of the current column     | Press <b>F2</b> (EDIT) <b>F4</b> (JUMP) <b>F2</b> (TOP↑).                                                                                                                                    |
| Column A of the current row      | Press <b>F2</b> (EDIT) <b>F4</b> (JUMP) <b>F3</b> (TOP←).                                                                                                                                    |
| Last line of the current column  | Press <b>F2</b> (EDIT) <b>F4</b> (JUMP) <b>F4</b> (BTM↓).                                                                                                                                    |
| Column Z of the current row      | Press <b>F2</b> (EDIT) <b>F4</b> (JUMP) <b>F5</b> (BTM→).                                                                                                                                    |

## • To select a range of cells

- Move the cell cursor to the start point of the range of cells you want to select.
  - You could select an entire row or column of cells as the start point, if you want. For details about selecting cells, see “To select cells” on page 9-6.
- Press **SHIFT** **8** (CLIP).
  - This will change the cell cursor to a thick-line boundary instead of the normal highlighting.
- Use the cursor keys to move the cell cursor to the end point of the range of cells you want to select.
  - The edit box will show the range of the selected cells.
  - To cancel cell selection, press **EXIT**. If you do, the cell cursor will be located at the end point of the range you selected.

| [Rad] [Norm] [d/c] [Real] SHEET |   |    |   |   |
|---------------------------------|---|----|---|---|
| SHE                             | A | B  | C | D |
| 1                               | 1 | 6  |   |   |
| 2                               | 2 | 7  |   |   |
| 3                               | 3 | 8  |   |   |
| 4                               | 4 | 9  |   |   |
| 5                               | 5 | 10 |   |   |

A2 : B3

FILE EDIT DELETE INSERT CLEAR >



---

## ■ Data (Constants, Text, Formula) Input Basics

First let's have a look at a few basic procedures that apply regardless of the type of data you are inputting.

---

### ● To overwrite data currently in a cell with new data

1. Move the cell cursor to the cell where you want to input data.

- If the cell you select already contains data, the following step will overwrite the existing data with new input.

2. Use the calculator's keys to input data.

- As you perform key operations to input values or text (such as **1**, **ALPHA** **log** (B), etc.), the applicable figures will appear aligned left inside the edit box.
- To cancel an input operation part way through at any point before advancing to step 3 below, press **EXIT**. This will return the cell contents to what they were in step 1 of this procedure.

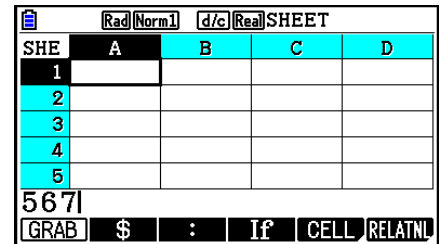

| SHE | A | B | C | D |
|-----|---|---|---|---|
| 1   |   |   |   |   |
| 2   |   |   |   |   |
| 3   |   |   |   |   |
| 4   |   |   |   |   |
| 5   |   |   |   |   |

567  
[GRAB] \$ : If CELL RELATNL

3. To finalize and apply your input, press **EXE**.

---

### ● To edit cell data

1. Move the cell cursor to the cell whose contents you want to edit.

2. Press **F2** (EDIT) **F3** (CELL).

- Cell contents in the edit box will change from align right to align left. A text cursor will appear in the edit box so you can edit its contents.

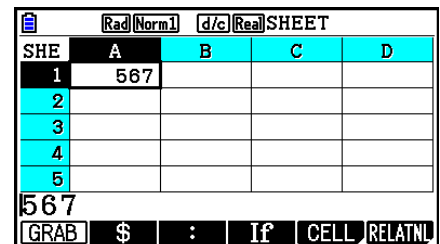

| SHE | A   | B | C | D |
|-----|-----|---|---|---|
| 1   | 567 |   |   |   |
| 2   |     |   |   |   |
| 3   |     |   |   |   |
| 4   |     |   |   |   |
| 5   |     |   |   |   |

567  
[GRAB] \$ : If CELL RELATNL

3. Use **▶** and **◀** to move the cursor around the contents of the cell, and edit them as required.

- To cancel an edit operation part way through at any point before advancing to step 4 below, press **EXIT**. This will return the cell contents to what they were in step 1 of this procedure.

4. To finalize and apply your edits, press **EXE**.

---

### ● To move the cell cursor while inputting data into a cell

Under factory default settings, pressing **EXE** while inputting data into a cell will cause the cell cursor to move to the next line. You can specify movement to the next column instead using the "Move" setting as described on page 1-35.

## ■ Inputting a Constant (Value, Calculation Result, Number Sequence) into a Cell

A constant is something whose value is fixed as soon as you finalize its input. A constant can be either a numeric value, or a calculation formula (such as  $7+3$ ,  $\sin 30$ ,  $A1 \times 2$ , etc.) that does not have an equal sign (=) in front of it. Inputting  $\boxed{\sin} \boxed{3} \boxed{0} \boxed{\text{EXE}}$ , for example will cause the value 0.5 (the calculation result) to appear in the cell (when Deg is selected as the Angle unit).

### • To input a number sequence automatically based on a function expression

1. Move the cell cursor to the cell where you want number sequence input to start.
  - Under initial default settings, automatic input of the number sequence will proceed downwards from the start cell. You can specify a different direction using the “Move” setting as described on page 1-35.
2. Press  $\boxed{\text{F2}}$  (EDIT)  $\boxed{\text{F5}}$  (SEQ) to display the Sequence screen, and then specify the function expression and values required to generate the required number sequence.

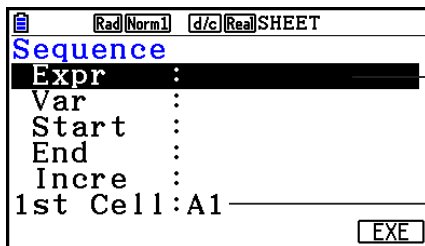

You can input data for the item that is highlighted on the screen.

Reference name of the cell selected in step 1

| Item  | Description                                                                                                                                                                                                                                           |
|-------|-------------------------------------------------------------------------------------------------------------------------------------------------------------------------------------------------------------------------------------------------------|
| Expr  | Input the function expression $f(x)$ for generating the number sequence.<br>Example: $\boxed{\text{ALPHA}} \boxed{+} \boxed{(X)} \boxed{x^2} \boxed{+} \boxed{1} \boxed{\text{EXE}}$ ( $X^2 + 1$ )                                                    |
| Var   | Input the variable name used in the function expression input for Expr.<br>Example: $\boxed{\text{ALPHA}} \boxed{+} \boxed{(X)} \boxed{\text{EXE}}$ (X)                                                                                               |
| Start | Input the starting value ( $X_1$ ) of the value to be substituted for the variable specified by Var.<br>Example: $\boxed{2} \boxed{\text{EXE}}$                                                                                                       |
| End   | Input the ending value ( $X_n$ ) of the value to be substituted for the variable specified by Var.<br>Example: $\boxed{1} \boxed{0} \boxed{\text{EXE}}$                                                                                               |
| Incre | Input the increment value ( $m$ ) for successive value of $X_1$ , as in: ( $X_2 = X_1 + m$ ), ( $X_3 = X_2 + m$ ), and so on. The number sequence is generated in the range of $X_1 + (n - 1)m \leq X_n$ .<br>Example: $\boxed{2} \boxed{\text{EXE}}$ |

| Item     | Description                                                                                                                                                                                                                                                                                                                                   |
|----------|-----------------------------------------------------------------------------------------------------------------------------------------------------------------------------------------------------------------------------------------------------------------------------------------------------------------------------------------------|
| 1st Cell | Input the reference name (A1, B2, etc.) of the cell where you want the first value of the number sequence to be input. Specify a cell here only if the starting cell is different from the one you specified in step 1 of this procedure.<br>Example: $\boxed{\text{ALPHA}} \boxed{\log} \boxed{(B)} \boxed{1} \boxed{\text{EXE}} \quad (B1)$ |

- Each time you press  $\boxed{\text{EXE}}$  after inputting data for a setting item, the highlighting will move to the next setting item. You also can use  $\boxed{\blacktriangle}$  and  $\boxed{\blacktriangledown}$  to move the highlighting upwards and downwards as required.
  - Performing the next step will input the number string automatically starting from the specified cell. If any cell that is within the range of cells where the number sequence values will be input already contains data, the existing data will be replaced with the number sequence values.
3. After inputting data for all the setting items, press  $\boxed{\text{F6}}$  (EXE) or the  $\boxed{\text{EXE}}$  key to start number sequence generation and input.

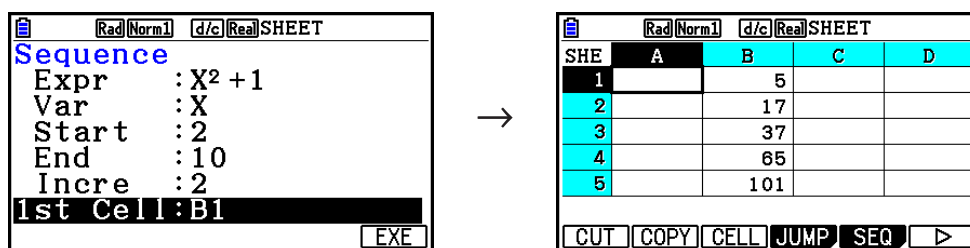

## ■ Inputting Text into a Cell

To input text, make sure the first thing you input into the cell is  $\boxed{\text{ALPHA}} \boxed{\text{EXP}}$  ("). The quote mark (") tells the calculator that what follows is text, and should be displayed as-is without calculation. The quote mark (") is not displayed as part of the text.

## ■ Inputting a Formula into a Cell

For the sake of example, let's try making a table that contains data based on the formula  $\langle \text{PRICE} \rangle \times \langle \text{QUANTITY} \rangle = \langle \text{TOTAL} \rangle$ . To do this, we would put  $\langle \text{PRICE} \rangle$  values in column A,  $\langle \text{QUANTITY} \rangle$  values in column B, and calculation formulas (like  $= A1 \times B1$ ,  $= A2 \times B2$ , and so on) in column C. If the Auto Calc feature is enabled (On), the values in column C would be recalculated and updated any time we change the values in column A or B.

In this example, note that we must start out the data in column C with the equal sign (=) in order to indicate it is a formula. In addition to values, arithmetic operators, and cell reference names, a formula also can contain built-in function commands (page 2-14) and special **Spreadsheet** mode commands (page 9-19).

## • Formula Input Example

|   | A     | B        | C     |
|---|-------|----------|-------|
| 1 | PRICE | QUANTITY | TOTAL |
| 2 | 35    | 15       | 525   |
| 3 | 52    | 15       | 780   |
| 4 | 78    | 20       | 1560  |

### Procedure

1. Input the text for line 1, and the applicable values in cells A2 through B4.
2. Move the cursor to cell C2, and input the formula for  $A2 \times B2$ .

SHIFT [=] ALPHA X,θ,T (A) 2 ✕ ALPHA log (B) 2 EXE

3. Copy the formula in cell C2 and copy it into cells C3 and C4. Move the cell cursor to cell C2 and then perform the following operation.

F2 (EDIT) F2 (COPY) ▼ F1 (PASTE) ▼ F1 (PASTE) EXIT

- For details about the copy and paste operations, see “Copying and Pasting Cell Contents” (page 9-14).

| Rad(Norm) d/c(Real) SHEET |       |        |       |   |
|---------------------------|-------|--------|-------|---|
| SHE                       | A     | B      | C     | D |
| 1                         | PRICE | QUANTI | TOTAL |   |
| 2                         | 35    | 15     | 525   |   |
| 3                         | 52    | 15     | 780   |   |
| 4                         | 78    | 20     | 1560  |   |
| 5                         |       |        |       |   |

=A4×B4

CUT COPY CELL JUMP SEQ >

## ■ Inputting a Cell Reference Name

Each cell on a spreadsheet has what is called a “reference name”, which is derived by combining its column name (A through Z) with its row name (1 through 999). A cell reference name can be used inside of a formula, which makes the value of the called cell part of the formula. See “Inputting a Formula into a Cell” above for more information. There are two methods you can use to input a cell reference name: direct input of the name and input using the GRAB command. The following illustrates how you would use each of these methods to input  $=A1+5$  into cell B1.

### • To input a cell reference name using direct input

Move the cell cursor to cell B1 and then perform the following operation.

SHIFT [=] ALPHA X,θ,T (A) 1 + 5 EXE

---

## • To input a cell reference name using the GRAB command

Move the cell cursor to cell B1 and then perform the following operation.

**SHIFT** **□** (=) **F1** (GRAB) **◀** **F1** (SET) **+** **5** **EXE**

- Commands **F2** (GO) through **F6** (BTM→) on the submenu that appears when you press **F1** (GRAB) are identical to commands **F1** (GO) through **F5** (BTM→) of the JUMP command submenu. See “Using the JUMP Command to Move the Cell Cursor” on page 9-7 about these commands.

---

## ■ Relative and Absolute Cell Reference Names

There are two types of cell reference names: relative and absolute. Normally, cell reference names are treated as being relative.

### Relative Cell Reference Names

In the formula =A1+5, the cell reference name A1 indicates a relative cell reference. It is “relative” because copying the formula and pasting in a different cell will cause the cell reference name to change in accordance with the location of cell where it is pasted. If the formula =A1+5 is originally located in cell B1, for example, copying at pasting in cell C3 will result in =B3+5 in cell C3. Moving from column B to column C (one column) causes A to change to B, while moving from row 1 to row 3 changes (two rows) changes the 1 to 3.

**Important!** If the result of a copy and paste operation causes a relative cell reference name to change to something that is outside the range of the spreadsheet cells, the applicable column letter and/or row number will be replaced by a question mark (?), and “ERROR” will be displayed as the cell’s data.

### Absolute Reference Names

If you want the row or the column, or both the row and the column parts of a cell reference name to remain the same to matter where you paste them, you need to create an absolute cell reference name. You do this by affixing a dollar sign (\$) in front of the part of the cell reference name you want to remain unchanged. You have three options when using the dollar sign (\$) to create an absolute cell reference name: absolute column with relative row (\$A1), relative column with absolute row (A\$1), and absolute row and column (\$A\$1).

---

## • To input the absolute cell reference name symbol (\$)

When inputting a cell reference into a spreadsheet cell, press **F2** (\$).

For example, the following key operation inputs the absolute cell reference name = \$B\$1.

**SHIFT** **□** (=) **F2** (\$) **ALPHA** **log** (B) **F2** (\$) **1**

## ■ Specifying Cell Formatting

For each cell, you can specify the text color, cell color, and cell color lightness (Normal or Lighter).

### • To specify cell formatting

1. Select the range of cells whose formatting you want to specify.
2. Press **[SHIFT] [5]** (FORMAT) to display the FORMAT dialog box.

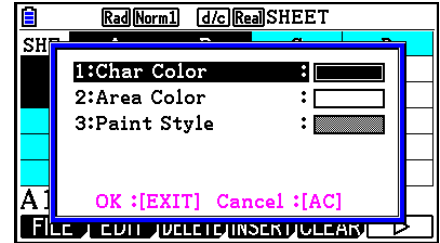

3. Configure the above dialog box with the following settings.

| To specify this:                        | Perform this operation:                                                                                     |
|-----------------------------------------|-------------------------------------------------------------------------------------------------------------|
| Specify the text color                  | Press <b>[1]</b> (Char Color) and then use keys <b>[1]</b> through <b>[8]</b> to specify the desired color. |
| Specify the cell color                  | Press <b>[2]</b> (Area Color) and then use keys <b>[1]</b> through <b>[8]</b> to specify the desired color. |
| Specify the lightness of the cell color | Press <b>[3]</b> (Paint Style) and then press <b>[1]</b> (Normal) or <b>[2]</b> (Lighter).                  |

4. To apply the settings you configure, return to the FORMAT dialog box and then press **[EXIT]**.

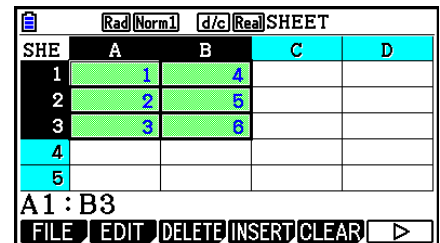

---

## ■ Copying and Pasting Cell Contents

You can copy the contents of one or more cells and paste them into another location. Once you perform the copy operation, you can copy the contents to multiple locations, if you want.

---

### ● To copy and paste spreadsheet data

1. Select the cell(s) you want to copy.
    - See “To select cells” (page 9-6) for more information.
  2. Press **F2** (EDIT) **F2** (COPY).
    - This will go into paste standby for the selected data, indicated by the **F1** menu item changing to (PASTE).
    - You can exit the paste standby at any time before you perform step 4 below by pressing **EXIT**.
  3. Use the cursor keys to move the cell cursor to location where you want to paste the data.
    - If you selected a range of cells in step 1, the cell you select with the cell cursor will be the upper left cell of the paste range.
    - If the location you select is within the range that you copied, performing step below will cause the existing data to be overwritten with the pasted data.
  4. Press **F1** (PASTE).
    - This will paste the copied data.
    - To paste the same data in other locations, repeat steps 3 and 4.
  5. After you are finish pasting the data, press **EXIT** to exit paste standby.
- 

## ■ Cutting and Pasting Cell Contents

You can use cut and paste to move the contents of one or more cells to another location. Cell contents (regardless of whether it includes relative or absolute cell name references) generally are unchanged by a cut and paste operation.

| SHE | A | B | C  | D |
|-----|---|---|----|---|
| 1   | 1 | 6 | 11 |   |
| 2   |   |   |    |   |
| 3   |   |   |    |   |
| 4   |   |   |    |   |
| 5   |   |   |    |   |

=A1+5

FILE EDIT DELETE INSERT CLEAR ▶

→

| SHE | A | B | C | D |
|-----|---|---|---|---|
| 1   | 1 |   |   | 5 |
| 2   |   | 6 |   |   |
| 3   |   |   |   |   |
| 4   |   |   |   |   |
| 5   |   |   |   |   |

=A1+5

CUT COPY CELL JUMP SEQ ▶

Cutting the formula =A1+5 in cell B1 and pasting it into cell B2. The A1 reference name is unchanged.

When you are cut and paste a range cells, reference names that affect relationships within the range are changed accordingly when the range is pasted in order to maintain the correct relationship, regardless of whether they are relative or absolute reference names.

| SHE | A | B | C  | D |
|-----|---|---|----|---|
| 1   | 1 | 6 | 11 |   |
| 2   |   |   |    |   |
| 3   |   |   |    |   |
| 4   |   |   |    |   |
| 5   |   |   |    |   |

B1 : C1

CUT COPY CELL JUMP SEQ >

→

| SHE | A | B | C  | D |
|-----|---|---|----|---|
| 1   | 1 |   |    |   |
| 2   |   | 6 | 11 |   |
| 3   |   |   |    |   |
| 4   |   |   |    |   |
| 5   |   |   |    |   |

=B2+5

CUT COPY CELL JUMP SEQ >

Cutting the B1:C1 range of cells that includes the formula =B1+5 and pasting it into B2:C2. The formula pasted into C2 is changed to =B2+5 in order to maintain the relationship with the cell to the left, which was also part of the pasted range.

## • To cut and paste spreadsheet data

1. Select the cell(s) you want to cut.
  - See "To select cells" (page 9-6) for more information.
2. Press **F2** (EDIT) **F1** (CUT).
  - This will go into paste standby for the selected data, indicated by the **F1** menu item changing to (PASTE).
  - You can exit the paste standby at any time before you perform step 4 below by pressing **EXIT**.
3. Use the cursor keys to move the cell cursor to location where you want to paste the data.
  - If you selected a range of cells in step 1, the cell you select with the cell cursor will be the upper left cell of the paste range.
  - If the location you select is within the range that you cut, performing step below will cause the exiting data to be overwritten with the pasted data.
4. Press **F1** (PASTE).
  - This will paste the data from the cell(s) you selected in step 1 and paste it into the location you selected in step 3.
  - Regardless of whether Auto Calc is enabled or disabled (page 9-5), pasting cut data will cause all of the formulas in the spreadsheet to be recalculated.



## ■ Inputting the Same Formula into a Range of Cells

Use the Fill command when you want to input the same formula into a specified range of cells. The rules governing relative and absolute cell name references are the same as those for copy and paste.

When you need to input the same formula into cells B1, B2, and B3, for example, the Fill command lets you do so by inputting the formula once, into cell B1. Note the following about how the Fill command handles cell name references in this case.

| When cell B1 contains this: | The Fill command will do this: |           | * Note that in actual practice cells B1, B2, and B3 will show the calculation results, not the formulas as shown here. |
|-----------------------------|--------------------------------|-----------|------------------------------------------------------------------------------------------------------------------------|
| =A1×2                       | A                              | B         |                                                                                                                        |
|                             | 1                              | =A1×2     |                                                                                                                        |
|                             | 2                              | =A2×2     |                                                                                                                        |
|                             | 3                              | =A3×2     |                                                                                                                        |
| =\$A\$2×2                   | A                              | B         |                                                                                                                        |
|                             | 1                              | =\$A\$2×2 |                                                                                                                        |
|                             | 2                              | =\$A\$2×2 |                                                                                                                        |
|                             | 3                              | =\$A\$2×2 |                                                                                                                        |

### ● To input the same formula into a range of cells

- Select the range of cells into which you want to input the same formula.
  - In this example we will assume the B1:B3 is selected. See “To select a range of cells” (page 9-7).
- Press **F2** (EDIT) **F6** (▷) **F1** (FILL).
- On the Fill screen that appears, enter the formula you want to input.

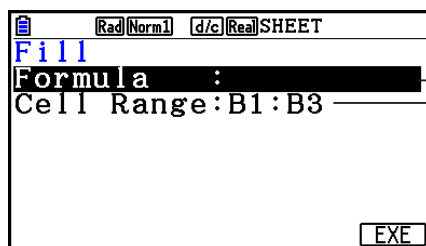

You can input data for the item that is highlighted on the screen.

This is the range of cells you selected in step 1.

- If there is data input in the upper left cell of the range specified in step 1 above, the formula will be displayed in the “Formula” line.
  - In the “Formula” line, input =A1×2 (**SHIFT** **□** (=) **ALPHA** **X,θ,T** (A) **1** **X** **2** **EXE**). Pressing **EXE** will cause the cell cursor to move to the “Cell Range” line.
  - If any cell within the cell range already contains data, performing the next step will cause the existing data to be overwritten with the new fill data (formula).
- Press **F6** (EXE) or the **EXE** key.
    - This will input the formula into the range of cells you specified.

---

## ■ Sorting Constant Data

Note that only constant data can be sorted. You can select multiple columns within a single line or multiple lines within a single column for sorting.

---

### ● To sort constant data

1. Select a range of column cells in a single row or a range of row cells in a single column.
  - See “To select a range of cells” (page 9-7).
  - A Syntax ERROR message will appear if any of the cells in the range you select contain data other than constant data.
2. Depending on the type of sort you want to perform, perform either one of the following operations.

To sort ascending: **F2**(EDIT) **F6**(▷) **F2**(SORTASC)

To sort descending: **F2**(EDIT) **F6**(▷) **F3**(SORTDES)

---

## ■ Deleting and Inserting Cells

### ● To delete an entire line or column of cells

Select the row(s) or column(s) you want to delete and then press **F3**(DELETE). This will delete the selected row(s) or column(s) immediately, without displaying a confirmation message.

You also can perform the following steps to delete a row or column.

1. Select one or more cells inside the row(s) or column(s) you want to delete.
    - If you want to delete lines 2 through 4, for example, you could select A2:B4, C2:C4, or any other range of cells that includes the lines to be deleted.
    - If you want to delete columns A and B, for example, you could select A1:B1, A2:B4, etc.
  2. Press **F3**(DELETE).
    - This enters delete standby. If you decide you want to cancel the delete operation at this time, press **EXIT**.
  3. To delete the entire line(s) that include the cells you selected in step 1, press **F1**(ROW). To delete the entire column, press **F2**(COLUMN).
- 

### ● To delete the contents of all the cells in a spreadsheet

1. Press **F3**(DELETE) **F3**(ALL).
2. In response to the confirmation message that appears, press **F1**(Yes) to delete the data or **F6**(No) to cancel without deleting anything.

---

## • To insert a row or column of blank cells

1. Perform one of the following operations to specify the location of the insert and the number of rows or columns to be inserted.

### • To insert rows

Starting with the row immediately below of the row where you want the insert to be performed, select the same number of rows that you want to insert.

Example: To insert three rows above row 2, you could select A2:A4, B2:C4, etc.

### • To insert columns

Starting with the column immediately to the right of the column where you want the insert to be performed, select the same number of columns that you want to insert.

Example: To insert three columns to the left of column B, you could select B2:D4, B10:D20, etc.

2. Press **F4** (INSERT).

- This will enter insert standby. If you decide you want to cancel the insert operation at this time, press **EXIT**.

3. Press **F1** (ROW) to insert the applicable number of rows or **F2** (COLUMN) to insert columns.

- A Range ERROR occurs if an insert operation causes existing cells that contain data to move outside the range of A1:Z999.

---

## ■ Clearing Cell Contents and Formatting

You can clear cell contents only, formatting only, or both contents and formatting.

- Content clear: Clears values, formulas, and other cell data.
- Format clear: Returns the character color, area color, and paint style settings of the cells to their initial default settings. This operation also clears conditional formatting (page 9-21).

---

### • To clear cell contents and formatting

1. Select the cell or range of cells you want to clear.

2. Perform the operations below to specify the cells you want to clear.

| To clear this:               | Perform this key operation:           |
|------------------------------|---------------------------------------|
| Cell contents only           | <b>F5</b> (CLEAR) <b>F1</b> (CONTENT) |
| Cell formatting only         | <b>F5</b> (CLEAR) <b>F2</b> (FORMAT)  |
| Cell contents and formatting | <b>F5</b> (CLEAR) <b>F3</b> (ALL)     |

### 3. Using Special Spreadsheet Mode Commands

The **Spreadsheet** mode has a number of special commands like CellSum(), which returns the sum of a range of cells, and CellIf(), which specifies branching conditions. These special commands can be used inside of formulas.

#### ■ Special Spreadsheet Mode Command List

“Input Key Operation” operations can be performed during cell input only.

You can omit anything enclosed in brackets ([ ]) in the Syntax of each command.

| Command                                  | Description                                                                                                                                                                                                                                                                                                                                                                                                                                           |
|------------------------------------------|-------------------------------------------------------------------------------------------------------------------------------------------------------------------------------------------------------------------------------------------------------------------------------------------------------------------------------------------------------------------------------------------------------------------------------------------------------|
| <b>CellIf</b> (<br>(Branch Condition)    | Returns Expression 1 when the equality or inequality provided as the branch condition is true, and Expression 2 when it is false.<br><b>Input Key Operation:</b> <b>F4</b> (If)<br><b>Syntax:</b> CellIf(equality, expression 1, expression 2[]) or CellIf(inequality, expression 1, expression 2[])<br><b>Example:</b> =CellIf(A1>B1, A1, B1)<br>Returns the value of A1 when {Cell A1 value} > {Cell B1 value}. Otherwise, returns the value of B1. |
| <b>CellMin</b> (<br>(Cell Minimum Value) | Returns the minimum value in a specified range of cells.<br><b>Input Key Operation:</b> <b>F5</b> (CELL) <b>F1</b> (Min)<br><b>Syntax:</b> CellMin(start cell:end cell[])<br><b>Example:</b> =CellMin(A3:C5)<br>Returns the minimum value of the data in cell range A3:C5.                                                                                                                                                                            |
| <b>CellMax</b> (<br>(Cell Maximum Value) | Returns the maximum value in a specified range of cells.<br><b>Input Key Operation:</b> <b>F5</b> (CELL) <b>F2</b> (Max)<br><b>Syntax:</b> CellMax(start cell:end cell[])<br><b>Example:</b> =CellMax(A3:C5)<br>Returns the maximum value of the data in cell range A3:C5.                                                                                                                                                                            |
| <b>CellMean</b> (<br>(Mean of Cells)     | Returns the mean value in a specified range of cells.<br><b>Input Key Operation:</b> <b>F5</b> (CELL) <b>F3</b> (Mean)<br><b>Syntax:</b> CellMean(start cell:end cell[])<br><b>Example:</b> =CellMean(A3:C5)<br>Returns the mean value of the data in cell range A3:C5.                                                                                                                                                                               |

| Command                                  | Description                                                                                                                                                                                                                                                                    |
|------------------------------------------|--------------------------------------------------------------------------------------------------------------------------------------------------------------------------------------------------------------------------------------------------------------------------------|
| <b>CellMedian</b> (<br>(Median of Cells) | Returns the median value in a specified range of cells.<br><b>Input Key Operation:</b> <b>F5</b> (CELL) <b>F4</b> (Med)<br><b>Syntax:</b> CellMedian(start cell:end cell[])<br><b>Example:</b> =CellMedian(A3:C5)<br>Returns the median value of the data in cell range A3:C5. |
| <b>CellSum</b> (<br>(Sum of Cells)       | Returns the sum of the data in a specified range of cells.<br><b>Input Key Operation:</b> <b>F5</b> (CELL) <b>F5</b> (Sum)<br><b>Syntax:</b> CellSum(start cell:end cell[])<br><b>Example:</b> =CellSum(A3:C5)<br>Returns the sum of the data in cell range A3:C5.             |
| <b>CellProd</b> (<br>(Product of Cells)  | Returns the product of the data in a specified range of cells.<br><b>Input Key Operation:</b> <b>F5</b> (CELL) <b>F6</b> (Prod)<br><b>Syntax:</b> CellProd(start cell:end cell[])<br><b>Example:</b> =CellProd(B3:B5)<br>Returns the product of the data in cell range B3:B5.  |

## ■ Spreadsheet Mode Command Example

This example inputs the special **Spreadsheet** mode formula CellSum( into cell C1 in order to calculate the sum of all the data in cell range A1:B5. It is assumed that there is already data in the cell range A1:B5.

1. Move the cell cursor to cell C1 and then perform the following operation.

**SHIFT** **=** (**F5**) (CELL) (**F5**) (Sum)  
**EXIT** **ALPHA** **X,θ,T** (A) **1** **F3** (: **ALPHA** **log** (b) **5** **)**

- You can perform the following operation, which uses the GRAB function (page 9-12) and CLIP function (page 9-7) in place of the underlined part in the above operation.

| [Rad] [Norm] [d/c] [Real] SHEET |   |    |   |   |
|---------------------------------|---|----|---|---|
| SHE                             | A | B  | C | D |
| 1                               | 1 | 6  |   |   |
| 2                               | 2 | 7  |   |   |
| 3                               | 3 | 8  |   |   |
| 4                               | 4 | 9  |   |   |
| 5                               | 5 | 10 |   |   |

=CellSum(A1:B5)  
[GRAB] \$ : If CELL RELATNL

**EXIT** **F1** (GRAB) **F4** (TOP←) (Enters the GRAB mode and moves the cursor to A1.)

**SHIFT** **8** (CLIP) **▶** **▼** **▼** **▼** (Specifies the selection range for the CLIP function.)

**EXE** **)**

2. Press **EXE** to finalize input of the formula.

| [Rad] [Norm] [d/c] [Real] SHEET |   |    |    |   |
|---------------------------------|---|----|----|---|
| SHE                             | A | B  | C  | D |
| 1                               | 1 | 6  | 55 |   |
| 2                               | 2 | 7  |    |   |
| 3                               | 3 | 8  |    |   |
| 4                               | 4 | 9  |    |   |
| 5                               | 5 | 10 |    |   |

FILE EDIT DELETE INSERT CLEAR ▶

## 4. Conditional Formatting

The conditional formatting function can be used to define conditional expressions (such as  $A1 < 0$ ) that determine the formatting (text color, area color, paint style) of a cell.

### ■ Conditional Formatting Overview

You can specify up to two conditions for each cell.

Pressing **F6** ( $\triangleright$ ) **F5** (CONDIT) displays the Condition screen.

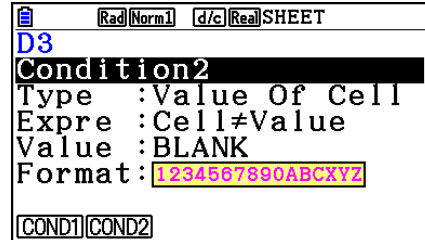
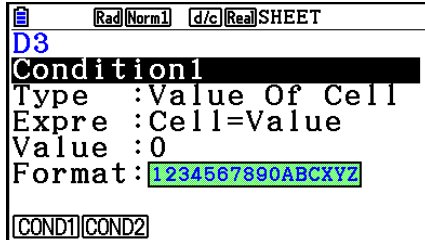

To select a particular condition, move the highlighting to the "Condition" line and then press **F1** (COND1) for Condition1 or **F2** (COND2) for Condition2.

### ● Condition Priority Sequence

When you have multiple conditions defined for a cell, they are applied starting from the lower numbered condition first. If Condition1 is  $0 \leq A1 \leq 10$  and Condition2 is  $10 \leq A1 \leq 20$ , for example, both conditions are satisfied when  $A1 = 10$  and the formatting specified by Condition1 is applied.

If a cell is configured directly using the procedure under "To specify cell formatting" (page 9-13) and with conditional formatting, application of the conditional formatting is given priority over the direct settings.

### ● Condition Types

There are two different condition types: Value Of Cell and Expression.

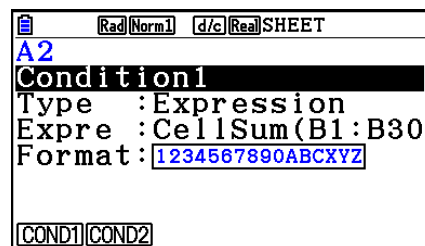
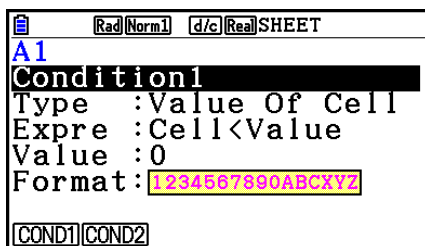

#### • Type: Value Of Cell

Use this condition type to define a condition based on a formula (such as  $A1 < 0$ ) that references a value input into the cell. For example you could configure cell A1 so its text is red when  $A1 < 0$ , and blue when  $1 < A1$ .

- **Type: Expression**

Use this condition type to define a condition based on a formula (such as  $\text{CellMin}(A1:B10) \leq C1$ ) that references one or more cells. This condition type provides a wide range of versatility to set up conditions such as the ones shown below.

- When  $A1 \times 30 > 100$ , A1 text is blue.
- When  $\text{CellSum}(B1:B30) \leq A1$ , A1 text is blue, and when  $A1 < \text{CellSum}(B1:B30)$ , A1 text is red.

## ■ Configuring Conditional Formatting Settings

This section provides the basic operational flow for configuring conditional formatting settings. For full details about each individual setting, see the pages referred to within the procedure below.

- **To configure conditional formatting settings**

1. Select the cell or range of cells for which you want to configure conditional formatting.
2. Press **F6** (▷) **F5** (CONDIT) to display the Condition screen.

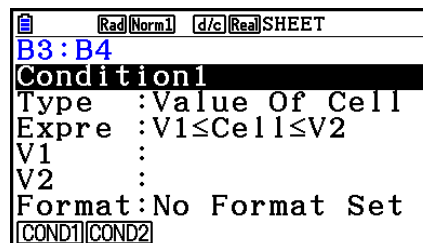

3. Use ▲ and ▼ to move the highlighting to “Condition” and then use the function menu to select the condition you want to configure (1 or 2).
4. Use ▲ and ▼ to move the highlighting to “Type” and then press **F1** (CELLVAL) to select “Value Of Cell” or **F2** (EXPRESS) to select “Expression” as the condition type.
  - For details about conditions types, see “Condition Types” (page 9-21).
5. Use ▲ and ▼ to move the highlighting to “Expre” and then perform one of the following operations.

| If you selected this in step 4: | Do this:                                                                                                                                                                                                                                         |
|---------------------------------|--------------------------------------------------------------------------------------------------------------------------------------------------------------------------------------------------------------------------------------------------|
| Value Of Cell                   | Use the function menu to select a conditional expression, and then use the “Value”, “V1”, and “V2” lines to assign values for the conditional expression. For details, see “Configuring Settings for Value Of Cell Type Conditions” (page 9-23). |
| Expression                      | Directly input the conditional expression. For details, see “Configuring Settings for Expression Type Conditions” (page 9-24).                                                                                                                   |

6. Use  $\blacktriangle$  and  $\blacktriangledown$  to move the highlighting to “Format” and then press **F1** (SETFORM).

- On the FORMAT dialog box that appears, perform steps 3 and 4 of the procedure under “To specify cell formatting” (page 9-13) to configure format settings.
- Including format settings will cause a sample of the format to appear in the “Format” line.

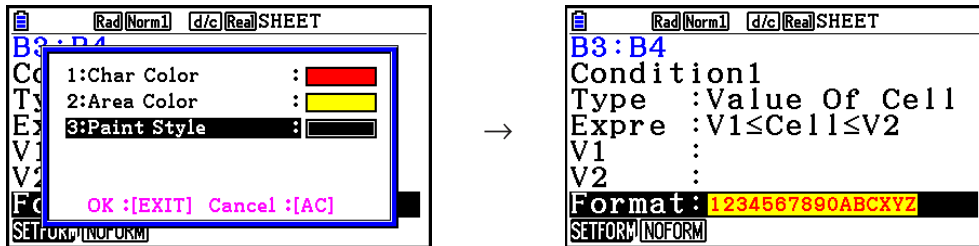

7. If you want to configure multiple conditions, repeat steps 3 through 6.

8. After the settings are the way you want, press **EXIT**.

- This returns to the screen in step 1. The  icon is displayed in the status bar while the cell cursor is located at a cell with conditional formatting.

## • Configuring Settings for Value Of Cell Type Conditions

The following condition settings can be configured when “Value Of Cell” is selected as the condition type in step 4 under “To configure conditional formatting settings” (page 9-22).

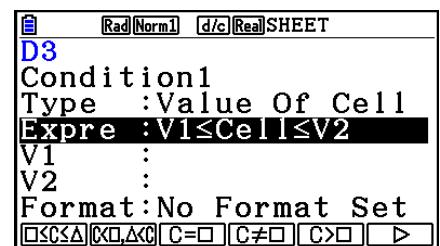

- Expre (Expression) ... Specifies the conditional expression (Cell = input value), which is selected using the function menu. In the function menu formulas “C” is used in place of “Cell”.
- V1, V2 (Value 1, Value 2) ... When **F1** ( $\square \leq C \leq \Delta$ ) or **F2** ( $C < \square, \Delta < C$ ) is selected for “Expre”, use these lines to input values for assignment to the V1 and V2 variables in the conditional expression.
- Value ... When a function menu item other than **F1** or **F2** is selected for “Expre”, use this line to input a value for assignment to the Value variable in the conditional expression.

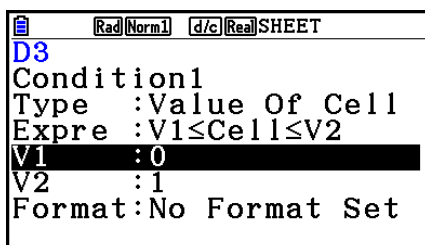

Example:  $0 \leq \text{Cell} \leq 1$

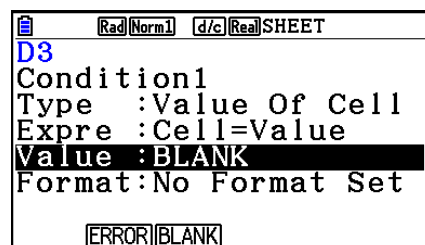

Example: Cell=BLANK



The following is the basic syntax for inputting values for V1, V2, and Value.

- Move the highlighting to the line whose setting you want to change, input a value or calculation formula, and then press **[EXE]**. If you input a calculation formula, the final value will be the calculation result.
- If **[F3]** (C=□) or **[F4]** (C≠□) is selected for “Expre”, you can specify **[F2]** (ERROR) or **[F3]** (BLANK) for “Value”.
  - **[F2]** (ERROR) ... Decision depends on whether or not “ERROR” is displayed in the cell whose settings are being configured.
  - **[F3]** (BLANK) ... Decision depends on whether or not the cell whose settings are being configured is blank.

---

## • Configuring Settings for Expression Type Conditions

The following condition settings can be configured when “Expression” is selected as the condition type in step 4 under “To configure conditional formatting settings” (page 9-22).

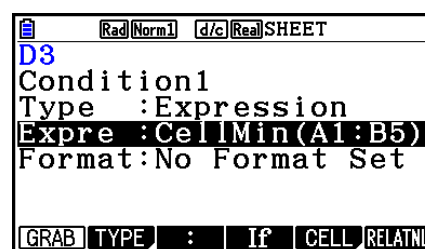

### Expre (Expression)

Use this line to directly input the conditional expression to be used for true/false judgment. Input rules are virtually identical to those that apply when inputting an expression that starts with an equal sign (=) into a spreadsheet cell, except for the following points.

- Do not include an equal sign (=) at the beginning of the expression.
- The function menu is identical to the one displayed during cell editing, except for the **[F2]** (TYPE) item. For details about using other menu items besides **[F2]**, see the following.
  - “Inputting a Cell Reference Name” (page 9-11)
  - “Relative and Absolute Cell Reference Names” (page 9-12)
  - “Using Special **Spreadsheet** Mode Commands” (page 9-19)
- Pressing **[F2]** (TYPE) displays the submenu shown below.



- **[F1]** (\$) ... Inputs the dollar sign (\$) used for specifying an absolute cell reference in a conditional expression. See “Relative and Absolute Cell Reference Names” (page 9-12).

- **F2** (ERROR) ... Inputs "ERROR" into the conditional expression. For example, you can use this to input A1=ERROR. Decision depends on whether or not "ERROR" is displayed in the cell being referenced in the conditional expression (A1 in the example here).
- **F3** (BLANK) ... Inputs "BLANK" into the conditional expression. Decision depends on whether or not the cell being referenced in the conditional expression is blank.
- **F4** (And) ... Inputs the logical operator "And" into the conditional expression.
- **F5** (Or) ... Inputs the logical operator "Or" into the conditional expression.

**Note**

- You can input up to 255 bytes of data for a conditional expression.
- ERROR, BLANK, and text strings can be used in a conditional expression only in the syntaxes shown below or their inverses (ERROR=<Cell>, etc.). <Cell> stands for a single cell reference (such as A1).  
 <Cell>=ERROR, <Cell>=BLANK, <Cell>≠ERROR, <Cell>≠BLANK, <Cell>=<text string>, <Cell>≠<text string>

• **To delete conditional formatting settings**

1. Select the cell or range of cells whose conditional formatting you want to delete.
  - Performing step 2 below will immediately clear, without any confirmation message, both the conditional formatting as well as any character color, area color, and paint style settings configured for the selected cell(s).
2. Press **F5** (CLEAR) **F2** (FORMAT).

■ **Conditional Formatting Setting Example**

In this example we will show how to configure the range of cells B3:C4 with the conditional formatting shown below. This procedure assumes that the cells already contain values.

| Condition | When the value input in the cell (=C) satisfies this condition: | This formatting is applied: |            |             |
|-----------|-----------------------------------------------------------------|-----------------------------|------------|-------------|
|           |                                                                 | Character Color             | Area Color | Paint Style |
| 1         | C<0                                                             | Red                         | Yellow     | Normal      |
| 2         | 0≤C≤100                                                         | Blue                        | Magenta    | Lighter     |

## ● Procedure

1. Select the range of cells B3:C4.

|     |    | Rad(Norm) | d/c(Real) | SHEET |  |
|-----|----|-----------|-----------|-------|--|
| SHE | A  | B         | C         | D     |  |
| 1   | 2  | 2         | 80        |       |  |
| 2   | 1  | 1         | 90        |       |  |
| 3   | 0  | 0         | 100       |       |  |
| 4   | -1 | -1        | 110       |       |  |
| 5   |    |           |           |       |  |

B3 : C4

FILE EDIT DELETE INSERT CLEAR >

2. Press **F6**(▷)**F5**(CONDIT) to display the Condition screen.
  - Condition1 appears first, so configure the first condition here.
3. Use **▼** to move the highlighting to “Expre” (Expression) and then press **F6**(▷)**F1**(C<□).
  - Initially, “Cell < Value” is displayed in the Expre line.
4. Use **▼** to move the highlighting to “Value” and then press **0** **EXE** to input 0.
5. Use **▼** to move the highlighting to “Format” and then press **F1**(SETFORM).
  - On the FORMAT dialog box that appears, configure the following settings:  
Character Color: Red, Area Color: Yellow, Paint Style: Normal.
6. Use **▲** to move the highlighting to “Condition1” and then press **F2**(COND2) to display Condition2.
7. Repeat steps 3 through 5 above to configure the Condition2 settings.
  - Input **F1**(□≤C≤△) in the “Expre” line, **0** **EXE** in the “V1” line, and **1** **0** **0** **EXE** in the “V2” line.
  - In the “Format” line, press **F1**(SETFORM) and then configure the following settings:  
Character Color: Blue, Area Color: Magenta, Paint Style: Lighter.
- 8 Press **EXIT**.
  - This returns to the screen in step 1 of this procedure and applies the formatting you configured to each cell.

|     |    | Rad(Norm) | d/c(Real) | SHEET |  |
|-----|----|-----------|-----------|-------|--|
| SHE | A  | B         | C         | D     |  |
| 1   | 2  | 2         | 80        |       |  |
| 2   | 1  | 1         | 90        |       |  |
| 3   | 0  | 0         | 100       |       |  |
| 4   | -1 | -1        | 110       |       |  |
| 5   |    |           |           |       |  |

B3 : C4

GRAPH CALC STORE RECALL CONDIT >

## Note

- It may take some time to display calculation results when a large number of cells containing conditional formatting are selected.
- Cell modification and recalculation may take some time to complete when there is a large amount of conditional formatting.

## 5. Drawing Statistical Graphs, and Performing Statistical and Regression Calculations

When you want to check the correlation between two sets of data (such as temperature and the price of some product), trends become easier to spot if you draw a graph that uses one set of data as the  $x$ -axis and the other set of data as the  $y$ -axis.

With the spreadsheet you can input the values for each set of data and draw a scatter plot or other types of graphs. Performing regression calculations on the data will produce a regression formula and correlation coefficient, and you can overlay a regression graph over the scatter plot.

**Spreadsheet** mode graphing, statistical calculations, and regression calculations use the same functions as the **Statistics** mode. The following shows an operation example that is unique to the **Spreadsheet** mode.

### ■ Example of Statistical Graph Operations (GRAPH Menu)

Input the following data and draw a statistical graph (scatter plot in this example).

0.5, 1.2, 2.4, 4.0, 5.2 ( $x$ -axis data)  
 -2.1, 0.3, 1.5, 2.0, 2.4 ( $y$ -axis data)

#### ● To input data and draw a statistical graph (scatter plot)

1. Input the statistical calculation data into the spreadsheet.

- Here we will input the  $x$ -axis data into column A, and the  $y$ -axis data into column B.

2. Select the range of cells you want to graph (A1:B5).

| SHE | A   | B    | C | D |
|-----|-----|------|---|---|
| 1   | 0.5 | -2.1 |   |   |
| 2   | 1.2 | 0.3  |   |   |
| 3   | 2.4 | 1.5  |   |   |
| 4   | 4   | 2    |   |   |
| 5   | 5.2 | 2.4  |   |   |

A1 : B5  
 FILE EDIT DELETE INSERT CLEAR >

3. Press **F6** (▶) **F1** (GRAPH) to display the GRAPH menu, and then press **F1** (GRAPH1).

- This will produce a scatter plot of the data in the range of cells you selected in step 2 of this procedure.
- The graph shown here is what is produced under initial default **Spreadsheet** mode settings. You can change the configuration of graph settings on the screen that appears when you press **F6** (SET) on the GRAPH menu. For details see “General Graph Settings Screen Operations” below.

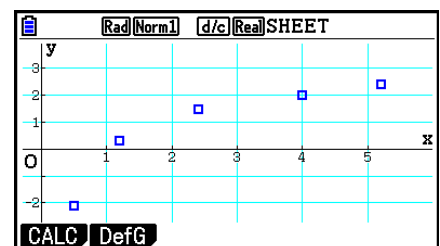

## ■ General Graph Settings Screen Operations

You can use the general graph setting screen to specify the range of data to be used for graphing, and to select the type of graph to be drawn.

### • To configure statistical graph settings

1. Input the statistical calculation data into the spreadsheet and then select the range of cells you want to graph.
  - Actually, the above step is not necessary at this point. You also could configure settings first before inputting data and selecting the range of cells to be graphed.
2. Press **F6** (▷) **F1** (GRAPH) **F6** (SET).
  - This will display the general graph settings screen (StatGraph1 in this example).

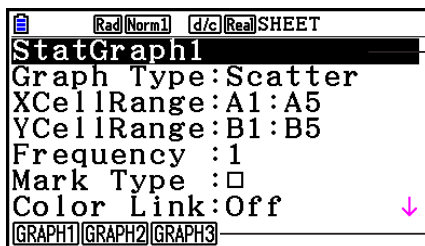

You can configure the setting for the item that is highlighted on the screen.

A function menu will appear when certain setting items are selected.

- The number of columns you select in step 1 will determine what information is input automatically on the general graph settings screen.

| If you select this number of columns: | This information will be input automatically: |
|---------------------------------------|-----------------------------------------------|
| 1                                     | XCellRange                                    |
| 2                                     | XCellRange, YCellRange                        |
| 3                                     | XCellRange, YCellRange, Frequency             |

- The following describes each of the setting items for this screen.

| Item       | Description                                                                                                                       |
|------------|-----------------------------------------------------------------------------------------------------------------------------------|
| StatGraph1 | Select the name of the setup you want. You can have up to three different setups registered, named StatGraph 1, 2, or 3.          |
| Graph Type | Select the graph type. The initial default setting is Scatter (scatter plot).                                                     |
| XCellRange | Specifies the cell range assigned to the graph <i>x</i> -axis (XCellRange). Only XCellRange is displayed for some Graph Types.    |
| YCellRange | Specifies the cell range assigned to the graph <i>y</i> -axis (YCellRange). The YCellRange is not displayed for some Graph Types. |

| Item      | Description                                                                                                                                                       |
|-----------|-------------------------------------------------------------------------------------------------------------------------------------------------------------------|
| Frequency | Specifies the range cells that contain values indicating the frequency of each graph data item. Select <b>F1</b> (1) if you do not want to use frequency values.  |
| Mark Type | Specify the type of mark ( <input type="checkbox"/> , <input checked="" type="checkbox"/> , or <input type="checkbox"/> ) to use as the mark on the scatter plot. |

- Use **▲** and **▼** to move the highlighting to the setting item you want to change. On the function menu that appears, select the setting you want.
  - For details about the StatGraph1, Graph Type, and Mark Type settings, see “To display the general graph settings screen” (page 6-3).
  - If you want to change the XCellRange, YCellRange, or Frequency setting, move the highlighting to the item you want to change and then input the cell range directly, or select **F1**(CELL) (**F2**(CELL) for Frequency) and then edit the currently input range. When inputting a cell range manually, use **F1**(:) to enter a colon (:) between two cells that define the range.
- After configuring the required settings, press **EXIT** or **EXE**.

## ■ Example of Statistical Calculation Operation (CALC Menu)

This example uses the data from the “Drawing a Scatter Diagram and  $xy$  Line Graph” (page 6-15) to perform paired-variable statistical calculations.

0.5, 1.2, 2.4, 4.0, 5.2 ( $x$ -data)  
-2.1, 0.3, 1.5, 2.0, 2.4 ( $y$ -data)

### ● To perform paired-variable statistical calculations and regression calculations

- Input the above  $x$ -data into cells A1:A5 of the spreadsheet and the  $y$ -data into cells B1:B5, and then select the range of the cells where you input the data (A1:B5).

| SHE | A   | B    | C | D |
|-----|-----|------|---|---|
| 1   | 0.5 | -2.1 |   |   |
| 2   | 1.2 | 0.3  |   |   |
| 3   | 2.4 | 1.5  |   |   |
| 4   | 4   | 2    |   |   |
| 5   | 5.2 | 2.4  |   |   |

A1 : B5  
FILE EDIT DELETE INSERT CLEAR

- Press **F6**(**▶**) **F2**(CALC) to display the CALC menu, and then press **F2**(2-VAR).

- This will display a screen of paired variable calculation results based on the data you selected in step 1. Use **▼** and **▲** to scroll the result screen. To close the screen, press **EXIT**.

2-Variable  
 $\bar{x}$  = 2.66  
 $\sum x$  = 13.3  
 $\sum x^2$  = 50.49  
 $\sigma x$  = 1.7385051  
 $s_x$  = 1.94370779  
 $n$  = 5

- For information about the meaning of each of the values on the result screen, see “Displaying the Calculation Results of a Drawn Paired-Variable Graph” on page 6-22.
- To return to the spreadsheet screen, press **EXIT**.

## ■ Using the Statistical Calculation Data Range Specification Screen

You can use a special setting screen to specify the range of data to be used for statistical calculation.

### ● To specify the data range for statistical calculation

1. Input the statistical calculation data into the spreadsheet and then select its range of cells.
2. Press **F6** (▷) **F2** (CALC) **F6** (SET).

- This will display a setting screen like the one shown to the right.

| Rad(Norm) d/c(Real)SHEET |              |
|--------------------------|--------------|
| 1Var                     | XCell: A1:A5 |
| 1Var                     | Freq : B1:B5 |
| 2Var                     | XCell: A1:A5 |
| 2Var                     | YCell: B1:B5 |
| 2Var                     | Freq : 1     |
| CELL                     |              |

- The number of columns you select in step 1 will determine what information is input automatically on the statistical calculation data range specification screen.

| If you select this number of columns: | This information will be input automatically: |
|---------------------------------------|-----------------------------------------------|
| 1                                     | 1Var XCell and 2Var XCell                     |
| 2                                     | 1Var Freq and 2Var YCell                      |
| 3                                     | 2Var Freq                                     |

- The following describes each of the setting items for this screen.

| Item                                  | Description                                                                                                                                                 |
|---------------------------------------|-------------------------------------------------------------------------------------------------------------------------------------------------------------|
| 1Var XCell<br>1Var Freq               | The cell range data specified here is used for variable $x$ and Frequency values when performing single-variable statistical calculations.                  |
| 2Var XCell<br>2Var YCell<br>2Var Freq | The cell range data specified here is used for variable $x$ , variable $y$ , and Frequency values when performing paired-variable statistical calculations. |

3. If you want to change the cell range, use ▲ and ▼ to move the highlighting to the item you want to change and the input the new cell range.
  - To input the colon (:), press **F1** (:).
  - To edit the currently input cell range, press **F1** (CELL) (in the case of 1Var XCell, 2Var XCell, and 2Var YCell) or **F2** (CELL) (in the case of 1Var Freq and 2Var Freq).
4. After configuring the required settings, press **EXIT** or **EXE**.

## ■ Statistics Mode and Spreadsheet Mode Function Menu Correspondence Table

In both the **Statistics** mode and the **Spreadsheet** mode, statistical graph functions are on the GRAPH function menu and statistical/regression calculation functions are on the CALC function menu. The structures of these menus and their submenus are the same in the **Statistics** mode and the **Spreadsheet** mode. For details about each menu item, refer to the pages referenced in the table below.

| For information about this menu item: | Refer to:                                                                                                                                                                                             |
|---------------------------------------|-------------------------------------------------------------------------------------------------------------------------------------------------------------------------------------------------------|
| {GRAPH} - {GRAPH1}                    | "Statistical Graph Parameters" (page 6-1)                                                                                                                                                             |
| {GRAPH} - {GRAPH2}                    |                                                                                                                                                                                                       |
| {GRAPH} - {GRAPH3}                    |                                                                                                                                                                                                       |
| {GRAPH} - {SELECT}                    | "Graph Draw/Non-draw Status" (page 6-7)                                                                                                                                                               |
| {GRAPH} - {SET}                       | "Statistical Graph Parameters" (page 6-1)<br>"General Graph Settings"(page 6-2)<br>"To display the general graph settings screen"(page 6-3)<br>"General Graph Settings Screen Operations" (page 9-28) |
| {CALC} - {1-VAR}                      | "Single-Variable Statistical Calculations" (page 6-23)                                                                                                                                                |
| {CALC} - {2-VAR}                      | "Paired-Variable Statistical Calculations" (page 6-24)                                                                                                                                                |
| {CALC} - {REG}                        | "Regression Calculation" (page 6-24)                                                                                                                                                                  |
| {CALC} - {SET}                        | "Using the Statistical Calculation Data Range Specification Screen" (page 9-30)                                                                                                                       |



When drawing a pie chart or bar graph, only the Color Link settings (page 6-3) are different from the settings in the **Statistics** mode and **Spreadsheet** mode.

| For this graph type: | Selecting this for Color Link: | Causes this to happen:                                                                                                                                                                   |
|----------------------|--------------------------------|------------------------------------------------------------------------------------------------------------------------------------------------------------------------------------------|
| Pie                  | Category                       | Of the data being used to draw the graph, the text color of the cells in the range specified by the StatGraph screen “Category” setting is reflected in the graph.                       |
|                      | Data                           | Of the data being used to draw the graph, the text color of the cells in the range specified by the StatGraph screen “Data” setting is reflected in the graph.                           |
|                      | Off                            | The text color of the data being used to draw the graph is ignored.                                                                                                                      |
| Bar                  | Category                       | Same as the pie chart, above.                                                                                                                                                            |
|                      | Data                           | Of the data being used to draw the graph, the text colors of the cells in the range specified by the StatGraph screen “Data1”, “Data2”, and “Data3” settings are reflected in the graph. |
|                      | Off                            | Same as the pie chart, above.                                                                                                                                                            |

- When “Pie” is selected as the Graph Type, the “Pie Area” setting is always “Link” whenever anything other than “Off” is selected for the “Color Link” setting.
- When “Bar” is selected as the Graph Type, the “Data1 Area”, “Data1 Border”, “Data2 Area”, “Data2 Border”, “Data3 Area”, and “Data3 Border” settings are always “Link” whenever anything other than “Off” is selected for the “Color Link” setting.

## • Graphing examples using Color Link

**Example** To input the data below into a spreadsheet and then draw a pie chart with “Category” selected as the Color Link setting

| SHE | A  | B  | C  | D  |
|-----|----|----|----|----|
| 1   | 10 | 38 | 49 | 80 |
| 2   | 15 | 38 | 49 | 80 |
| 3   | 10 | 38 | 49 | 80 |
| 4   | 10 | 38 | 49 | 80 |
| 5   | 10 | 38 | 49 | 80 |

1. Input the data shown nearby, with the text color of cells from A1 through A5 as shown.
  - For information about specifying the text color, see “Specifying Cell Formatting” (page 9-13).
2. Select the cells in the range A1:B5.
  - For information about selecting cells, see “To select a range of cells” (page 9-7).

3. Perform the following operation to display the general graph settings screen: **F6**(▷)  
**F1**(GRAPH)**F6**(SET).
  - The “Category” and “Data” settings are configured automatically. Check to make sure that A1:A5 is shown for “Category” and B1:B5 is shown for “Data”.
4. Use ▲ and ▼ to move the highlighting to “Graph Type” and then press **F4**(Pie).
5. Use ▲ and ▼ to move the highlighting to “Color Link” and then press **F1**(Cat).

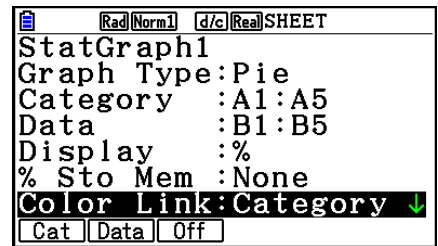

6. Press **EXIT** to exit the general graph settings screen.
7. Press **F1**(GRAPH1).
  - The graph will reflect the text colors in the “Category” cell range (A1:A5).

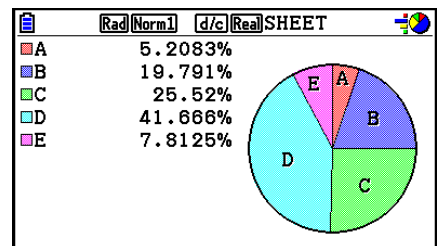

8. Press **SHIFT F1**(TRACE).
  - This will highlight label A and display a pointer in area A of the graph.
9. Use ▲ and ▼ to move the pointer to area D and then press **SHIFT 5**(FORMAT).
10. On the color selection dialog box that appears, press **2**(Blue).

- This will close the dialog box and change the color of area D to blue.

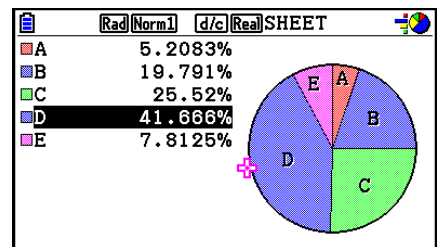

11. Press **EXIT** to close the graph screen.
  - The color you change to on the graph screen will be reflected as the text color in the applicable cell of the “Category” cell range.

| SHE | A | B  | C | D |
|-----|---|----|---|---|
| 1   | A | 10 |   |   |
| 2   | B | 38 |   |   |
| 3   | C | 49 |   |   |
| 4   | D | 80 |   |   |
| 5   | E | 15 |   |   |

A1:B5  
[GRAPH1][GRAPH2][GRAPH3] SELECT SET

## 6. Spreadsheet Mode Memory

You can use the calculator's different types of memory (variables, list memory, file memory, matrix memory, vector memory) to store data, and recall data from a memory into the spreadsheet.

### ■ Saving Spreadsheet Data to a Memory

The following table shows an overview of the store operations for each type of memory. For details about each operation, see the example operations following the table.

| Memory Type                        | Store Operation                                                                                                                                                                                                                                                                                                                                                                                                  |
|------------------------------------|------------------------------------------------------------------------------------------------------------------------------------------------------------------------------------------------------------------------------------------------------------------------------------------------------------------------------------------------------------------------------------------------------------------|
| Variables<br>(A ~ Z, r, $\theta$ ) | You can assign the content of a single cell to a variable.<br>While a single cell is selected, press <b>F6</b> ( $\triangleright$ ) <b>F3</b> (STORE) <b>F1</b> (VAR), and then specify the variable name on the screen that appears.                                                                                                                                                                            |
| List Memory<br>(List 1 ~ List 26)  | You can store data in a range of cells in a single row or a single column in list memory.<br>While a range of cells in a single row or single column is selected, press <b>F6</b> ( $\triangleright$ ) <b>F3</b> (STORE) <b>F2</b> (LIST), and then specify the list number on the screen that appears.                                                                                                          |
| File Memory<br>(File 1 ~ File 6)   | You can store data in a range of cells that spans a multiple rows and columns in file memory. While a range of cells is selected, press <b>F6</b> ( $\triangleright$ ) <b>F3</b> (STORE) <b>F3</b> (FILE), and then specify the file number on the screen that appears.<br>The first column of the selected range is stored in the specified file as List 1, the second column is saved as List 2, and so on.    |
| Matrix Memory<br>(Mat A ~ Mat Z)   | You can store data in a range of cells that spans a multiple rows and columns in matrix memory. While a range of cells is selected, press <b>F6</b> ( $\triangleright$ ) <b>F3</b> (STORE) <b>F4</b> (MAT), and then specify the matrix name on the screen that appears.<br>The first column of the selected range is stored in the specified matrix as List 1, the second column is saved as List 2, and so on. |
| Vector Memory<br>(Vct A ~ Vct Z)   | You can store data in a range of cells in one row or one column in vector memory. While a range of cells in a single row or single column is selected, press <b>F6</b> ( $\triangleright$ ) <b>F3</b> (STORE) <b>F5</b> (VCT), and then specify the vector name on the screen that appears.                                                                                                                      |

#### **Note**

When spreadsheet data is saved to list memory or file memory, the text color information of each cell is inherited by the destination memory. Text color information is ignored when spreadsheet data is saved to a variable, to matrix memory or to vector memory.

#### **Important!**

The following describes what happens if you try to store data in memory when a cell does not contain any data, when a cell contains text, or when ERROR is displayed for a cell.

- If you are assigning data to a variable, an error occurs.
- If you are storing data in list memory, file memory, matrix memory, or vector memory, 0 is written into the applicable cell(s).

## ● Example: To store column data in list memory

1. In a single column, select the range of cells you want to store in list memory.

- For example, you could select A1:A10.

2. Press **F6** (▷) **F3** (STORE) **F2** (LIST).

- This will display a screen like the one shown to the right. The “Cell Range” setting will show the range of cells you selected in step 1.

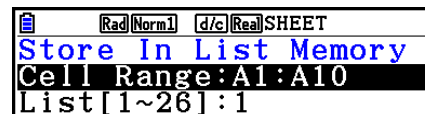

3. Press **▽** to move the highlighting to “List[1~26]”.

4. Input the List number (1 to 26) of the list memory where you want to store the data and then press **EXE**.

- Performing the next step will overwrite any data currently stored under the list memory number you specified here with the data in the range of cells specified by “Cell Range”.

5. Press **F6** (EXE) or the **EXE** key to store the data.

## ■ Recalling Data from Memory to a Spreadsheet

The following table shows an overview of the recall operations for each type of memory. For details about each operation, see the example operations following the table.

| Memory Type                       | Recall Operation                                                                                                                                                                                                                                                                                                                                                                                                                                    |
|-----------------------------------|-----------------------------------------------------------------------------------------------------------------------------------------------------------------------------------------------------------------------------------------------------------------------------------------------------------------------------------------------------------------------------------------------------------------------------------------------------|
| List Memory<br>(List 1 ~ List 26) | You can recall data from a specified list memory to a range of cells in a single row or a single column. While the first cell of the range in a single row or single column is selected, press <b>F6</b> (▷) <b>F4</b> (RECALL) <b>F1</b> (LIST), and then specify the list number on the screen that appears.<br><br>Whether the data is recalled in a column direction or row direction depends on the Setup screen’s “Move” setting (page 1-35). |
| File Memory<br>(File 1 ~ File 6)  | You can recall data from a specified file memory to the spreadsheet. Select the cell you want to be the upper left corner of the recalled data and then press <b>F6</b> (▷) <b>F4</b> (RECALL) <b>F2</b> (FILE). Next, specify the file memory number on the screen that appears.                                                                                                                                                                   |
| Matrix Memory<br>(Mat A ~ Mat Z)  | You can recall data from a specified matrix memory to the spreadsheet. Select the cell you want to be the upper left corner of the recalled data and then press <b>F6</b> (▷) <b>F4</b> (RECALL) <b>F3</b> (MAT). Next, specify the matrix name on the screen that appears.                                                                                                                                                                         |
| Vector Memory<br>(Vct A ~ Vct Z)  | You can recall data from a specified vector memory to a range of cells in a single row or a single column. While the first cell of the range in a single row or single column is selected, press <b>F6</b> (▷) <b>F4</b> (RECALL) <b>F4</b> (VCT), and then specify the vector name on the screen that appears.                                                                                                                                     |

## Note

- When data is recalled to a spreadsheet from list memory or file memory, the text color information of each element is inherited by the spreadsheet cells. The area color and paint style colors of the destination cells are set to their initial defaults of the destination cells.
- When data is recalled to a spreadsheet from matrix memory or vector memory, the text color, area color, and paint style are set to the initial defaults of the destination cells.

---

### • Example: To recall data from a matrix memory to a spreadsheet

1. On the spreadsheet, select the upper left cell of the range where you want the recalled data to be input.

2. Press **F6** (▷) **F4** (RECALL) **F3** (MAT).

- This will display a screen like the one shown to the right. The “1st Cell” setting will show the name of the cell you selected in step 1.

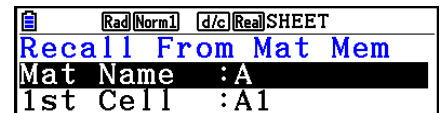

3. Input the name (A to Z) of the matrix memory whose data you want to recall and then press **EXE**.

4. Press **F6** (EXE) or **EXE** to recall the data.

### **Important!**

When recalling list memory, file memory, matrix memory, or vector memory data, an error will occur if the recalled data runs outside the allowable range of the spreadsheet (A1:Z999).

# Chapter 10 eActivity

You can use the **eActivity** mode to input data into an eActivity file. You can input text, numeric expressions and pictures, and also paste data (like graphs, tables, etc.) from the calculator's built-in applications as "strips".

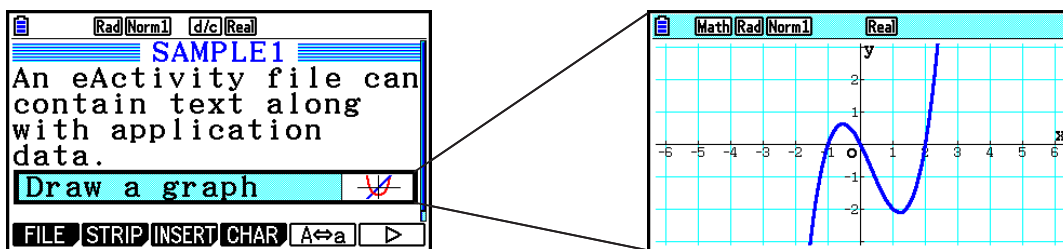

eActivity files can be used by a teacher, for example, to create math problems or exercises that provide hints to solutions, for distribution to students. Students can use eActivity files to keep classroom notes, memos of problems and their solutions, etc.

## 1. eActivity Overview

The first thing that appears when you select the **eActivity** mode on the Main Menu is the file menu.



No **eActivity** mode files in memory



At least one folder or an **eActivity** mode file in memory

Opening a file in the **eActivity** mode will display a workspace screen that you can use for inputting and editing text, calculation expressions, and other data.

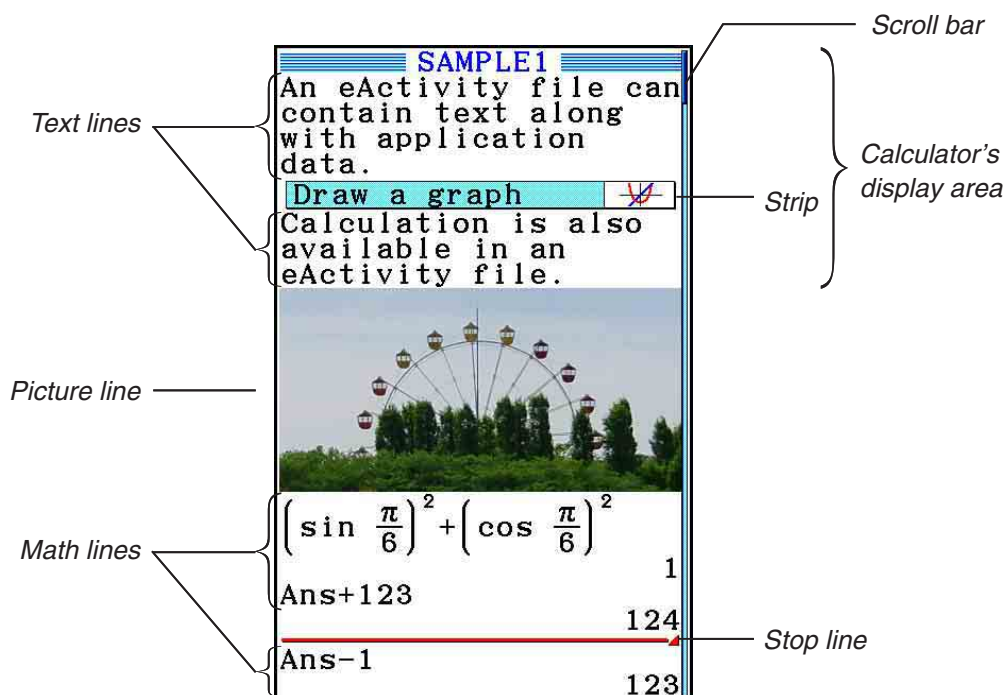

The following explains the type of data you can input and edit in an eActivity file.

Text line .....A text line can be used to input characters, numbers, and expressions as text.

Calculation line..... Use the calculation line to enter an executable calculation formula. The result will appear in the following line. Calculations are performed the same way as they are performed in the **Run-Matrix** mode, while the Math input/output mode is selected.

Stop line .....A stop line can be used to stop calculation at a particular point.

Picture line .....A picture line can be used to insert an image.

Strip.....A strip can be used to embed data into an eActivity from the Graph, Conic Graphs, Spreadsheet, or other built-in applications.

## 2. eActivity Function Menus

---

### ■ File List Function Menu

- **{OPEN}** ... Opens an eActivity file or folder.
- **{NEW}** ... Creates a new eActivity file.
- **{DELETE}** ... Deletes an eActivity file.
- **{SEARCH}** ... Searches for an eActivity file.
- **{MEMO}** ... Displays a list of memos included in the eActivity file currently selected in the file list.
  - **{JUMP}** ... Opens the eActivity file and jumps to the eActivity line where the memo selected in the list is located.
  - **{EDIT}** ... Displays a screen for editing the memo selected in the list.
  - **{DETAIL}** ... Opens a details screen for the memo selected in the list.
  - **{DELETE}** ... Deletes the memo selected in the list.
  - **{DEL-ALL}** ... Deletes all memos in the eActivity file.
- At least 128 kbytes of memory area is required when the **eActivity** mode is used for the first time. A Memory Full error will appear if there is not enough memory available.

---

## ■ Workspace Screen Function Menu

Part of the content of the workspace function menu depends on the line (or strip) that is currently selected.

### • Workspace Screen Common Menu Items

Only the menu items marked with an asterisk (\*) below are supported while a picture line is selected.

- **{FILE}**\* ... Displays the following file operation submenu.
  - **{SAVE}** ... Saves the file currently being edited.
  - **{SAVE • AS}** ... Saves the file currently being edited under another name.
  - **{OPT}** ... See “Optimizing Storage Memory” on page 11-13.
  - **{CAPACITY}** ... Displays a screen showing the data size of the file being edited and how much memory capacity remains.
- **{STRIP}**\* ... Inserts a strip.
- **{JUMP}**\* ... Displays the following submenu to control cursor movement.
  - **{TOP}**/**{BOTTOM}**/**{PageUp}**/**{PageDown}** ... See page 10-6.
- **{DEL-LINE}**/**{DELETE}**\* ... Deletes the line that is currently selected or where the cursor is located.
- **{INSERT}**\* ... Displays the following insert submenu, for inserting a new line above the line that is currently selected or where the cursor is located.
  - **{TEXT}** ... Inserts a text line.
  - **{CALC}** ... Inserts a calculation line.
  - **{STOP}** ... Inserts a calculation stop line.
  - **{PICTURE}** ... Inserts a picture line.
- **{▶MAT/VCT}** ... Displays the Matrix Editor (page 10-9)/Vector Editor (page 10-9).
- **{▶LIST}** ... Displays the List Editor (page 10-9).
- **Menu when a Text Line is Selected**
  - **{TEXT}** ... Changes the current line from a text line to a calculation line.
  - **{CHAR}** ... Displays a menu for inputting math symbols, special symbols, and characters of various languages.
  - **{A↔a}** ... Toggles between uppercase and lowercase input while alpha character input is enabled (by pressing the  key).
  - **{MATH}** ... Displays the MATH menu (page 1-14).



- {**COLOR**} ... Displays the following COLOR submenu.
  - {**MARKER**} ... Enters the marker mode for highlighting text (page 10-10).
  - {**CHAR**} ... Enters the color mode for coloring text (page 10-11).
- {**MEMO**} ... Displays the following MEMO submenu.
  - {**INSERT**} ... Appends a memo at the current cursor position.
  - {**DELETE**} ... Deletes the memo at the current cursor position.
  - {**Catalog**} ... Displays a list of memos included in a file.
  - {**VIEW**} ... Displays the memo at the current cursor position.

- **Menu when a Calculation Line or Stop Line is Selected**

Only the menu items marked with an asterisk (\*) below are supported while a stop line is selected.

- {**CALC**}\* ... Changes the current line from a calculation line to a text line.
- {**MATH**}\* ... Same as {MATH} under “Menu when a Text Line is Selected”.
- {**COLOR**} ... Same as {COLOR} under “Menu when a Text Line is Selected”.
- {**MEMO**} ... Same as {MEMO} under “Menu when a Text Line is Selected”.

- **Menu when a Strip is Selected**

- {**FILE**} ... Displays the following file operation submenu.
  - {**SAVE**}/{**SAVE • AS**}/{**OPT**}/{**CAPACITY**} ... Same as the {FILE} submenus under “Workspace Screen Common Menu Items”.
  - {**SIZE**} ... Displays the size of the strip at the current cursor position.
- {**CHAR**} ... Same as {CHAR} under “Menu when a Text Line is Selected”.
- {**A↔a**} ... Same as {A↔a} under “Menu when a Text Line is Selected”.

### 3. eActivity File Operations

This section explains the different file operations you can perform from the eActivity file menu screen. All of the operations in this section can be performed while the file menu is displayed.

- For information about the **F5** (MEMO) function menu displayed for an eActivity file menu, see “Appending a Memo to a Text Line or Calculation Line” (page 10-11).
- This section does not cover folder operations. For details about folders, see “Chapter 11 Memory Manager”.

---

- **To create a new file**

1. While the file menu is displayed, press **F2** (NEW).
  - This will display a file name input screen.

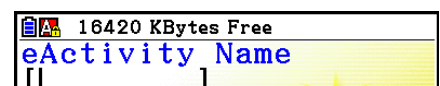

2. Input up to 8 characters for the file name and then press **[EXE]**.

- This displays a blank workspace screen.

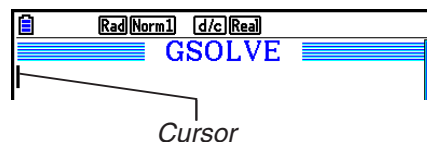

- The following are the characters allowed in a file name.

A to Z, {, }, ', ~, 0 to 9

---

### • To open a file

Use **[▲]** and **[▼]** to highlight the file you want to open, and then press **[F1]**(OPEN) or **[EXE]** \*.

\* If an error occurs, delete capture memory and clipboard data, or transfer the data to your computer.

---

### • To delete a file

1. Use **[▲]** and **[▼]** to highlight the file you want to delete, and then press **[F3]**(DELETE).

- This will display a “Delete eActivity?” confirmation message.

2. Press **[F1]**(Yes) to delete the file or **[F6]**(No) to cancel without deleting anything.

---

### • To search for a file

1. While the file menu is displayed, press **[F4]**(SEARCH).

- This will display a file search screen.

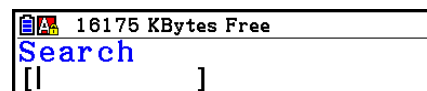

2. Enter part or the entire name of the file you want to find.

- File name characters are searched from left to right. Entering “IT” will count names like ITXX, ITABC, IT123 as hits, but not names like XXIT or ABITC.

3. Press **[EXE]**.

- If a name matches the text you input in step 2, it will be selected on the file menu.



- The message “Not Found” will appear if a match cannot be found. Press the **[EXIT]** key to close the message dialog box.

## 4. Inputting and Editing Data

All of the operations in this section are performed on the eActivity workspace screen. Use the procedures under “eActivity File Operations” (page 10-4) to create a new file or to open an existing file.

### ■ Cursor Movement and Scroll Operations

| When you want to do this:                                | Use this key operation:                      |
|----------------------------------------------------------|----------------------------------------------|
| Move the cursor forward and back                         | ▲ or ▼                                       |
| Scroll one screen back                                   | SHIFT ▲ or<br>F6 (▷) F1 (JUMP) F3 (PageUp)   |
| Scroll one screen forward                                | SHIFT ▼ or<br>F6 (▷) F1 (JUMP) F4 (PageDown) |
| Move the cursor to the beginning of the workspace screen | F6 (▷) F1 (JUMP) F1 (TOP)                    |
| Move the cursor to the end of the workspace screen       | F6 (▷) F1 (JUMP) F2 (BOTTOM)                 |

### ■ Inputting into a Text Line

Use a text line to input alphanumeric characters, expressions, etc.

#### ● Inputting characters and expressions as text

1. Move the cursor to a text line.

- While the cursor is in a text line, “TEXT” will be displayed for the F3 function menu item. This indicates that text input is enabled.

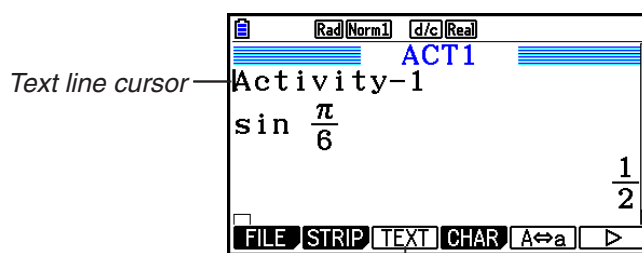

F3 key menu becomes “TEXT”.

- “CALC” will be displayed for the F3 function menu item if the cursor is located in a calculation line. Pressing **F3**(CALC) will change the calculation line to a text line.
  - If the cursor is located in a strip, use **▲** and **▼** to move to the cursor to a text line.
  - On the function menu, selecting {INSERT} and then {TEXT} will insert a new text line above the line where the cursor is currently located.
2. Input the text or expression you want into the text strip.
- See “Text Line Input and Editing Operations” described below.

## • Text Line Input and Editing Operations

- You can input up to 255 bytes of text into a single text line. Text in the text line wraps automatically to fit inside the display area (Word Wrap Function). Note, however, that numeric expressions and commands do not wrap.\*<sup>1</sup> Scroll arrows (**◀▶**) will appear on the left and right sides of the calculation line to let you know some of the calculation does not fit within the calculation line display area. In this case, you can use the left and right cursor keys to scroll the calculation.
- The **F5**(A↔a) function key toggles between upper-case and lower-case input. This function is available only while alpha text input is enabled. See page 2-8 for details. When upper-case input is selected, **A** is displayed in the status bar, and **a** is displayed while lower-case input is selected.
- Press **EXE** to input a carriage return into text. No symbol will be displayed for a carriage return.
- If the text is wrapped into multiple lines, pressing the **AC** key will delete the line where the cursor is currently located only. The part of the text that is wrapped to other lines will not be deleted.
- Always use the Math input/output mode (page 1-13) to input an expression into a text line.

\*<sup>1</sup> Also, any word that includes the symbol “ ’ ”, “ { ” or “ **10** ”, which are input using the menu that appears when you press **F4**(CHAR), does not wrap.

## ■ Inputting into a Calculation Line

Inputting a calculation expression into an eActivity calculation line and pressing **EXE** will display the calculation result in the following line. Such a calculation line can be used in the same way as the **Run-Matrix** mode (page 1-3). A calculation line and its result make up one set.

- Note that the word wrap function does not apply in the case of math lines. Scroll arrows (**◀▶**) will appear on the left and right sides of the calculation line to let you know some of the calculation does not fit within the calculation line display area. In this case, you can use the left and right cursor keys to scroll the calculation.

## • To input a calculation formula into an eActivity

1. Move the cursor to a calculation line.

- While the cursor is in a calculation line, “CALC” will be displayed for the F3 function menu item. This indicates that calculation expression input is enabled.

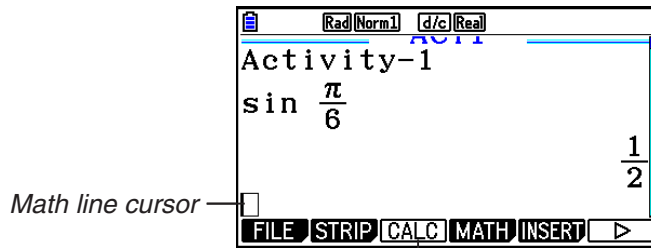

This will cause the **F3** key menu to change to “CALC”.

- “TEXT” will be displayed for the F3 function menu item if the cursor is located in a text line. Pressing **F3** (CALC) will change the calculation line to a text line.
  - If the cursor is located in a strip, use  $\blacktriangle$  and  $\blacktriangledown$  to move to the cursor to a calculation line.
  - On the function menu, selecting {INSERT} and then {CALC} will insert a new calculation line above the line where the cursor is currently located.
2. Input a calculation expression (Example:  $\sin \alpha \frac{\pi}{6}$  **SHIFT** **EXP** ( $\pi$ )  $\blacktriangledown$  **6**).

- Calculation line input and editing operations are the same as those in the **Run-Matrix** mode while the Math input/output mode is selected.

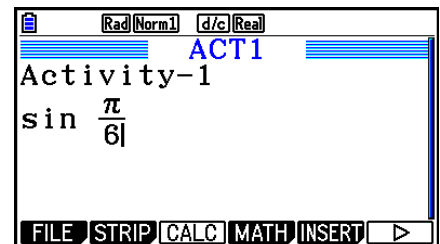

3. To obtain the result of the calculation, press **EXE**.

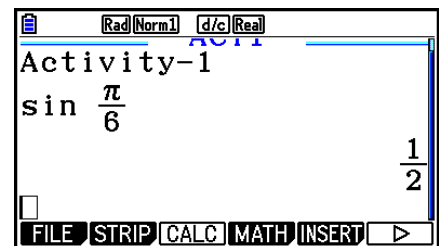

---

## • Matrix Calculations Using the Matrix Editor

Selecting {▶MAT/VCT} on the function menu displays the Matrix Editor.

Matrix Editor operations and matrix calculations in the **eActivity** mode are the fundamentally identical to those in the **Run-Matrix** mode. For details about the Matrix Editor and matrix calculation operations, see “Matrix Calculations” (page 2-42). Note, however, that **eActivity** mode Matrix Editor operations and matrix calculations differ from those in the **Run-Matrix** mode as described below.

- **eActivity** mode matrix memory is saved separately for each file. Matrix memory will be different from those produced when called from a non-**eActivity** mode.

---

## • Vector Calculations Using the Vector Editor

Selecting {▶MAT/VCT} on the function menu displays the Vector Editor.

Vector Editor operations and vector calculations in the **eActivity** mode are the fundamentally identical to those in the **Run-Matrix** mode. For details about the Vector Editor and vector calculation operations, see “Vector Calculations” (page 2-59). Note, however, that **eActivity** mode Vector Editor operations and vector calculations differ from those in the **Run-Matrix** mode as described below.

- **eActivity** mode vector memory is saved separately for each file. Vector memory will be different from those produced when called from a non-**eActivity** mode.

---

## • List Calculations Using the List Editor

Selecting {▶LIST} on the function menu displays the List Editor.

List Editor operations in the **eActivity** mode are identical to those in the **Statistics** mode (“Inputting and Editing a List”, page 3-1). This processing and calculations are fundamentally the identical to those in the **Run-Matrix** mode (“Manipulating List Data” on page 3-7, “Arithmetic Calculations Using Lists” on page 3-13). Note, however, that **eActivity** mode List Editor operations and list calculations differ from those in other modes as described below.

- The **eActivity** mode List Editor function menu provides only screen two of the **Statistics** mode List Editor function menu.
- To return to the workspace screen from the List Editor in the **eActivity** mode, press **EXIT**.
- In the **eActivity** mode, values for list memory is saved separately for each file. List memory will be different from those produced when called from a non-**eActivity** mode.

---

## ■ Inserting a Calculation Stop Line

Pressing **EXE** after you edit a calculation line on a workspace screen that contains multiple calculation lines will cause all of the calculations following the edited line to be re-calculated. Re-calculation can take quite a bit of time if there are a large number of calculation lines or if some of the calculations are complex. Inserting a calculation stop line will stop the re-calculation process at the point where the line is located.

---

### • To insert a stop line

On the function menu, select {INSERT} and then {STOP} to insert a stop line above the currently selected line or strip.

---

## ■ Highlighting and Changing the Color of Text

You can highlight or change the color of text line or calculation line text in order to add emphasis.

- You cannot mark or change the color of the text of a calculation line result.
- 

### • To highlight text

1. Move the cursor to the beginning (or end) of the text you want to highlight.

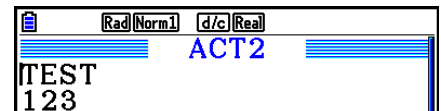

2. Press **F6** (▶) **F5** (COLOR) **F1** (MARKER).

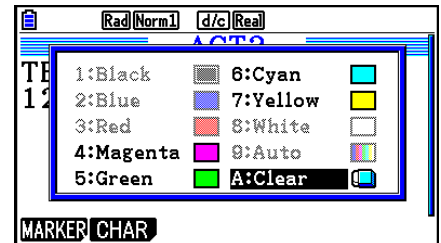

3. On the dialog box that appears, press the number key that corresponds to the highlighting color (magenta, green, cyan, yellow) you want to use.

- This closes the dialog box. The cursor will now be the color you selected.

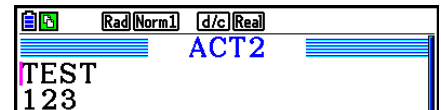

4. Use **▶** and **◀** to move the cursor in the direction of the text you want to highlight.

- The text the cursor passed over will become highlighted.
- You also can highlight across multiple lines by using **▲** and **▼** to change lines before moving the cursor left and right.

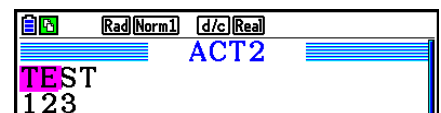

5. To apply the highlighting, press **F1** (SET).

- To cancel highlighting, press **EXIT**.
- 

### • To unhighlight text

Perform the same operation you used to highlight text under “To highlight text” to unhighlight it. In step 3, press **X01** (Clear) instead of selecting a highlight color.

---

## ● To change the text color

1. Move the cursor to the beginning (or end) of the text whose color you want to change.
2. Press **F6** (▶) **F5** (COLOR) **F2** (CHAR).
3. On the dialog box that appears, press the number key that corresponds to the color you want to use.
  - This closes the dialog box. The cursor will now be the color you selected.
4. Use **▶** and **◀** to move the cursor in the direction of the text whose color you want to change.
  - You also can change text color across multiple lines by using **▲** and **▼** to change lines before moving the cursor left and right.
5. To register the character color change, press **F1** (SET).
  - To cancel the character color change, press **EXIT**.

---

## ■ Appending a Memo to a Text Line or Calculation Line

After you append a memo to a text line or calculation line in an eActivity file, you can jump to that line from the memo list.

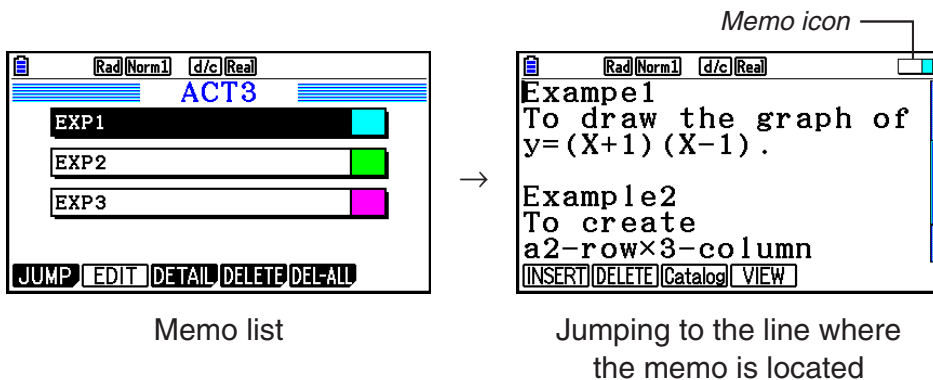

- You can append one memo per line.\* The memo icon will appear in the upper right corner of the screen if there is a memo appended to the line where the cursor is currently located.
  - \* Note that a line of text runs from the beginning of the line up to the next new line operation (which is not displayed) and may span multiple display lines.
- In addition to being able to display the memory list while an eActivity file is open, you also can open it by pressing **F5** (MEMO) in the file menu before opening the eActivity file.
- A memo can be appended to a text line or calculation line only.
- You cannot append a memo to a calculation line result.



---

## • To append a memo to a line

1. Move the cursor to the text line or calculation line where you want to append a memo.
2. If the cursor is located at a text line, press **F6** (▷) **F6** (▷) **F3** (MEMO) **F1** (INSERT). If it is at a calculation line, press **F6** (▷) **F6** (▷) **F1** (MEMO) **F1** (INSERT).
  - This displays a memo color selection dialog box.
3. Use the cursor keys to move the highlighting to the color you want to select and then press **EXE**. Or you can use the number keys to enter the number next to the color you want to select.
  - A memo window appears in the center of the screen, ready for text input.

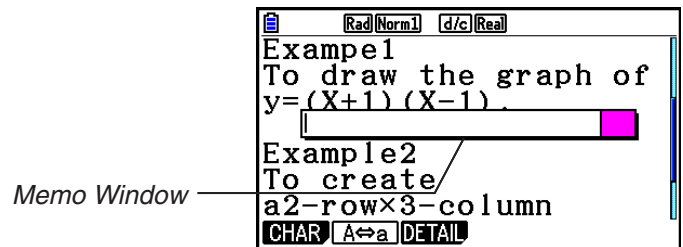

4. Enter the text you want. You can enter an explanation of the line, some symbol, etc.
  - You can enter up to 255 bytes of text.
5. Press **EXE**.
  - This closes the memo window. At this time the memo icon will appear in the upper right corner of the screen because there is now a memo appended to the line where the cursor is located.

---

## • To jump to a line that has a memo appended

1. If the cursor is currently located at a text line, press **F6** (▷) **F6** (▷) **F3** (MEMO) **F3** (Catalog). If it is at a calculation line, press **F6** (▷) **F6** (▷) **F1** (MEMO) **F3** (Catalog).
  - This displays a list of memos contained in the file.
2. Use **▲** and **▼** to move the highlighting to the memo for your jump destination and then press **EXE**.
  - This jumps to the line where the selected memo is located, with the cursor at the first character of the line.

---

## • To edit the text of an existing memo

1. Move the cursor to the line where the memo you want to edit is appended.
2. If the cursor is located at a text line, press **F6** (▷) **F6** (▷) **F3** (MEMO) **F4** (VIEW). If it is at a calculation line, press **F6** (▷) **F6** (▷) **F1** (MEMO) **F4** (VIEW).
  - This will display the memo window as shown in the screen shot on the left, below. Pressing **F3** (DETAIL) here will display a memo detail editing screen like the screen shot on the right. You can use either of these screens to edit memo text. The detail editing screen is best when the memo contains a lot of text.

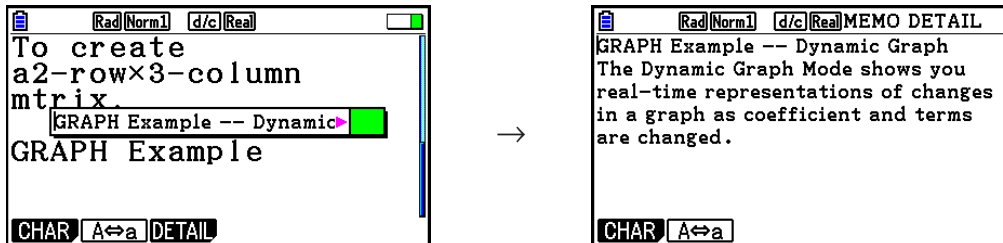

3. Edit the text and then press **EXE**.
  - This returns to step 1 of this procedure.



---

## • To remove a memo

1. Move the cursor to the line where the memo you want to remove is appended.
2. If the cursor is located at a text line, press **F6** (▷) **F6** (▷) **F3** (MEMO) **F2** (DELETE). If it is at a calculation line, press **F6** (▷) **F6** (▷) **F1** (MEMO) **F2** (DELETE).
3. In response to the confirmation dialog that appears, press **F1** (Yes) to delete the memo or **F6** (No) to cancel the delete operation.

## ■ Inserting an Image (Picture)

The following table shows the image file sizes that are supported for insertion into an eActivity file.

| Width × Height (dots) | Size                                                                                                                                                                                                                       | Example Screen                                                                      |
|-----------------------|----------------------------------------------------------------------------------------------------------------------------------------------------------------------------------------------------------------------------|-------------------------------------------------------------------------------------|
| (a) 384 × 216         | This is the overall screen size for this model. The graphic images stored in capture memory (page 1-36) are this size. The 48 vertical dots that are outside of the eActivity display range can be displayed by scrolling. |  |
| (b) 384 × 192         | This is the screen size when a graph screen is saved to picture memory (page 5-21).                                                                                                                                        |  |

- The line on the eActivity workspace screen where an image is inserted is called a “picture line”. You can insert only one image per picture line, and you cannot enter text or numbers into the same line where a picture line is inserted.
- You can insert a 16-bit g3p format file or a screen image (3-bit g3p format file) saved to capture memory (page 1-36).

---

## • To insert an image

1. Use  $\blacktriangle$  and  $\blacktriangledown$  to move the cursor to the location where you want to insert the image.
2. If the cursor is located at a text line, press  $\text{F6}$  ( $\triangleright$ )  $\text{F3}$  (INSERT)  $\text{F4}$  (PICTURE). If it is at a calculation line, press  $\text{F5}$  (INSERT)  $\text{F4}$  (PICTURE).
  - This displays a list of g3p files stored in the PICT folder in storage memory.
3. Use  $\blacktriangle$  and  $\blacktriangledown$  to move the highlighting to the image you want to insert and then press  $\text{EXE}$ .
  - This inserts the image with a red boundary around it. The red boundary means that the image is selected.

---

## • To select an image

You can use  $\blacktriangle$  and  $\blacktriangledown$  to move the cursor between lines and select images. The following shows how images appear on the display when they are selected.

Selecting an image that does not have a boundary causes a red boundary to appear around it.

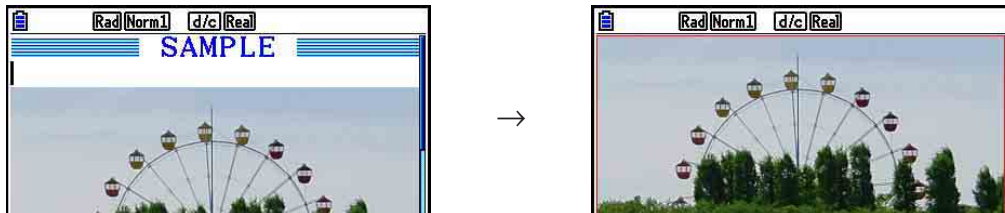

Selecting an image that has a boundary causes the boundary to change color, indicating it is highlighted.

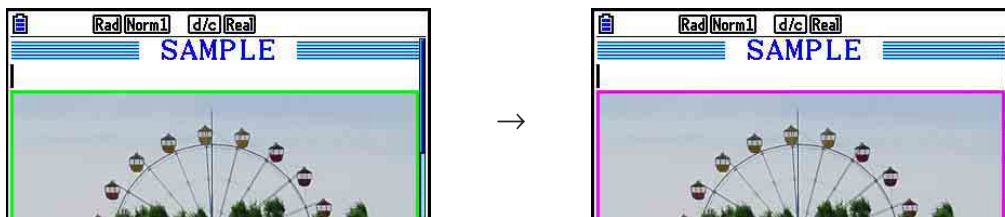

---

### • To add a boundary line around an image

1. Use **▲** and **▼** to select the image to which you want to add a boundary line.
2. Press **SHIFT** **5** (FORMAT).
  - This displays a dialog box for specifying the style and color of the boundary line.
3. Specify the boundary line style and color.
  - Use **▲** and **▼** to move the highlighting to Line Style or Line Color and then press **EXE**. On the option dialog box that appears, highlight the option you want to select and then press **EXE**.
  - The following are the settings that are available for Line Style and Line Color.  
Line Style: 1.Normal, 2.Thick, 5.Thin  
Line Color: 1.Black, 2.Blue, 3.Red, 4.Magenta, 5.Green, 6.Cyan, 7.Yellow, 8.White
4. After the settings are the way you want, press **EXIT**.

---

### • To remove a boundary line from around an image

1. Use **▲** and **▼** to select the image whose boundary line you want to remove.
2. Press **SHIFT** **5** (FORMAT) **2** (Line Color) **9** (Clear) **EXE**.
3. Press **EXIT**.

---

### • To delete an image

1. Use **▲** and **▼** to select the image you want to delete.
2. Press **F6** (**▷**) **F2** (DELETE).
3. In response to the confirmation dialog that appears, press **F1** (Yes) to delete the image or **F6** (No) to cancel the delete operation.

---

## ■ Using Strips

Strips are tools that let you embed built-in application data into an eActivity file. Only one built-in application screen can be associated with each strip, and the strip can store the data (graphs, etc.) produced by the screen.

The table below shows the built-in application screens that can be inserted into strips. The “Strip Name” column shows the names included on the dialog box that appears when you press **F2** (STRIP).

**Strip Data Type Table**

| <b>Data Type</b>                                                                                                                                                                                | <b>Strip Name</b> |
|-------------------------------------------------------------------------------------------------------------------------------------------------------------------------------------------------|-------------------|
| <b>Run-Matrix</b> mode calculation data (When the <b>Run-Matrix</b> mode is called from an eActivity, it starts up in the Math input/output mode.)                                              | RUN               |
| <b>Graph</b> mode graph screen data                                                                                                                                                             | Graph             |
| <b>Graph</b> mode graph relation list screen data                                                                                                                                               | Graph Editor      |
| <b>Table</b> mode table relation list screen data                                                                                                                                               | Table Editor      |
| <b>Conic Graphs</b> mode graph screen data                                                                                                                                                      | Conics Graph      |
| <b>Conic Graphs</b> mode function list screen data                                                                                                                                              | Conics Editor     |
| <b>Statistics</b> mode statistical graph screen data                                                                                                                                            | Stat Graph        |
| <b>Statistics</b> mode List Editor data                                                                                                                                                         | List Editor       |
| <b>Equation</b> mode calculation solution screen data                                                                                                                                           | Solver            |
| <b>Recursion</b> mode recursion type selection screen                                                                                                                                           | Recur Editor      |
| Notes screen data (Notes is a special eActivity application. See “Notes Strips” on page 10-19 for more information.)                                                                            | Notes             |
| <b>Run-Matrix</b> mode Matrix Editor data                                                                                                                                                       | Matrix Editor     |
| <b>Run-Matrix</b> mode Vector Editor data                                                                                                                                                       | Vector Editor     |
| <b>Equation</b> mode simultaneous equation solution screen data                                                                                                                                 | Simul Equation    |
| <b>Equation</b> mode high-order equation solution screen data                                                                                                                                   | Poly Equation     |
| <b>Dyna Graph</b> mode graph screen data                                                                                                                                                        | Dynamic Graph     |
| <b>Financial</b> mode calculation solution screen data                                                                                                                                          | Financial         |
| <b>Spreadsheet</b> mode spreadsheet screen data                                                                                                                                                 | SpreadSheet       |
| <b>E-CON3</b> mode setup wizard data                                                                                                                                                            | Econ SetupWizard  |
| <b>E-CON3</b> mode advanced setup data                                                                                                                                                          | Econ AdvancSetup  |
| <b>E-CON3</b> mode advanced setup data<br>(Executing this strip starts sampling immediately based on the setup information that is recorded to the strip the first time the strip is executed.) | Econ Sampling     |
| <b>E-CON3</b> mode advanced setup data<br>(Executing this strip graphs sampled data that is recorded to the strip the first time the strip is executed.)                                        | Econ Graph        |
| <b>Geometry</b> mode screen data                                                                                                                                                                | Geometry          |
| <b>Picture Plot</b> mode screen data                                                                                                                                                            | Picture Plot      |

## • To insert a strip

1. Move the cursor to the location where you want to insert the strip.

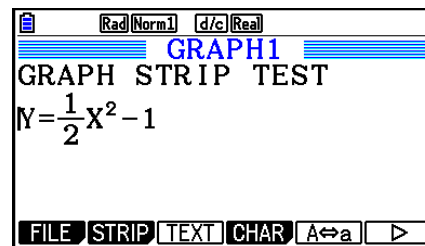

2. Press **F2** (STRIP).

- This will display a dialog box with a list of insertable strips. For information about the display names and data types that appear on this dialog box, see the “Strip Data Type Table” (page 10-17).

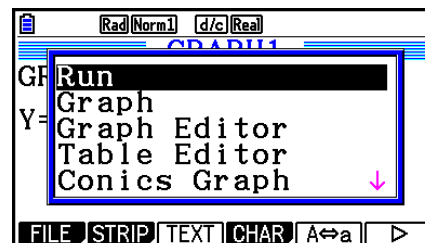

3. Use **▼** and **▲** to select the strip that corresponds to the type of data you want to insert.

- In this example we will select “Graph” (**Graph** mode graph screen data).

4. Press **EXE**.

- This will insert the type of strip you selected (Graph strip in this example) one line above the line where you located the cursor in step 1 of this procedure.

5. Input up to 16 characters for the strip title, and then press **EXE**.

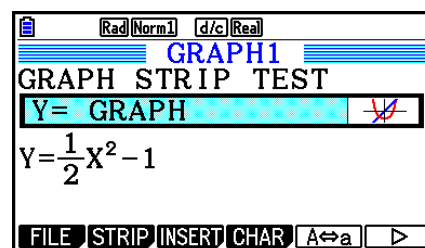

6. Press **EXE** again to start creating strip data.

- This will start up the built in application for the selected strip type (**Graph** mode in this example), and display the graph screen. At this point, a blank graph screen appears because there is no data yet.

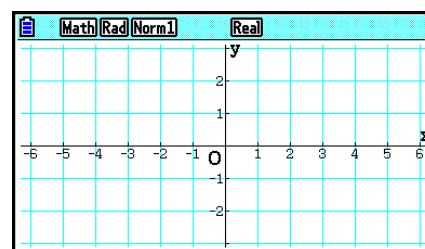

7. Press **EXIT** to display the graph relation list screen.

8. Enter the function you want to graph.

(Example:  $Y = \frac{1}{2}x^2 - 1$ )

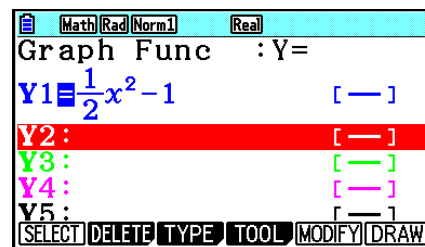

9. Press **F6** (DRAW).

- This will graph the function you entered.

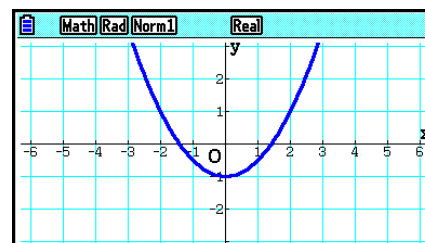

10. To return to the eActivity workspace screen, press **SHIFT** **↔** (🔒).

- The data that is graphed in step 8 will be saved in the Graph strip.
- The saved graph data is linked to this Graph strip only. It is independent of data for modes that are entered from the Main Menu.

11. Pressing **EXE** here again will display the graph screen, and draw the graph based on the data saved by the strip.

## • Notes Strips

“Notes” is a special eActivity text editor that comes in handy when you want to write long text explanations on the workspace screen. You can call up the Notes screen from a Notes strip on the workspace screen. Input and editing operations on the Notes screen are identical to those you use for an eActivity text line.

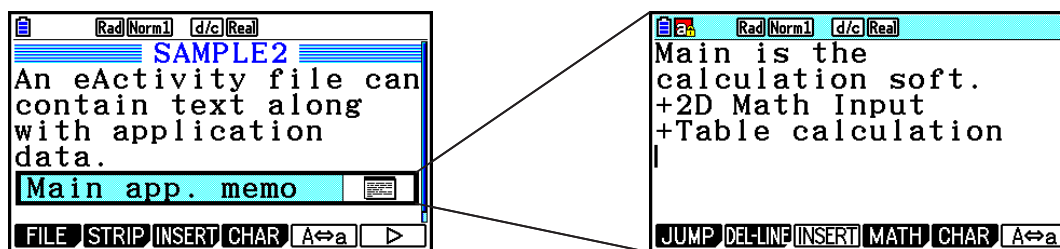



The following describes the Notes screen function menu items.

- **{JUMP}**... Displays a JUMP menu that you can use to jump to the top (**[F1]**(TOP)) of the data, the bottom (**[F2]**(BOTTOM)) of the data, the previous page (**[F3]**(PageUp)), or the next page (**[F4]**(PageDown)).
- **{DEL-LINE}** ... Deletes the line that is currently selected or where the cursor is located.
- **{INSERT}** ... Inserts one new line above the line where the cursor is currently located.
- **{MATH}** ... Displays the MATH menu (page 1-14).
- **{CHAR}** ... Displays a menu for inputting math symbols, special symbols, and characters of various languages.
- **{A↔a}** ... Toggles between uppercase and lowercase input while alpha character input is enabled (by pressing the **[ALPHA]** key).

---

### • To change the title of a strip

1. Use **[▼]** and **[▲]** to select the strip whose title you want to change.
2. Input up to 16 characters for the strip title, and then press **[EXE]**.
  - The remainder of the existing title will disappear as soon as you input the first character. Input the new title in its entirety. If you want to partially edit the existing title, press **[◀]** or **[▶]** first to move the cursor.
  - Pressing **[EXIT]** instead of **[EXE]** will exit strip title editing without changing anything.

---

### • To call an application from a strip

- Use **[▼]** and **[▲]** to select the strip whose application you want to call and then press **[EXE]**.
- This will display the application screen that corresponds to the selected strip. If the strip already contains data, the application is called using the data that was last saved.
  - The background color of the status bar changes from its normal white to light cyan to indicate that the displayed application screen was called from a strip.
  - If you select a Conics Graph strip and press **[EXE]** without inputting any graph data, the Conics Editor screen appears in place of the Conics Graph screen.

---

- **To toggle between the eActivity workspace screen and an application screen called from a strip**

Press **SHIFT** **→** (**↶**).

Each press of **SHIFT** **→** (**↶**) toggles between the eActivity workspace screen and the application screen called from the strip.

---

- **To switch from an application screen called up from a strip to another application screen**

Press **SHIFT** **↵** (**↶**). On the dialog box that appears, use **▼** and **▲** to select the name of an application and then press **EXE**.

---

- **To display the strip memory usage screen**

1. Use **▼** and **▲** to select the strip whose memory usage screen you want to view.

2. Press **F1** (FILE) **F5** (SIZE).

- This will display the memory usage screen of the currently selected strip.

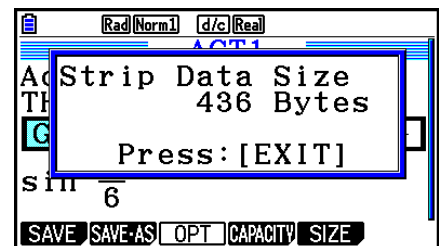

3. To exit the memory usage screen, press **EXIT**.

---

- **To delete a line or strip**

1. Move the cursor to the line or strip you want to delete.

- If you move the cursor to a calculation line, note that both the calculation and the result will be deleted.

2. Press **F6** (**▷**) **F2** (DEL-LINE).

- This causes a confirmation message to appear.

3. Press **F1** (Yes) to delete, or **F6** (No) to cancel without deleting anything.

---

## ■ Saving a File

Use the procedures in this section to save a file after inputting or editing it on the workspace screen.

An eActivity file for the fx-CG10/fx-CG20/fx-CG20 AU may have a file name extension of “g3e”. Performing either of the following operations on the fx-CG10/fx-CG20/fx-CG20 AU to save an eActivity file always will cause the extension “g3e” to be appended to the file name.

- Saving a newly created file
- Saving an existing file using the “save as” operation (F1)(FILE)F2(SAVE • AS))

If you save an eActivity file using the fx-CG10/fx-CG20/fx-CG20 AU to save a file with a file name extension “g2e” (a file transferred from an older version calculator), the file name extension will be determined according to the following rules.

- The “g3e” extension is used for an eActivity file that includes data for new features added by the fx-CG10/fx-CG20/fx-CG20 AU.  
Here, the expression “data for new features added by the fx-CG10/fx-CG20/fx-CG20 AU” means, for example, colored text data, memo data appended to a line, picture line data, etc.
- The “g2e” extension is used for eActivity files other than those described above.

---

### ● To replace the existing file with the new version

Press F1(F1)(FILE)F1(SAVE) to save the currently open file.

---

### ● To save a file under a new name

1. On the eActivity workspace screen, press F1(F1)(FILE)F2(SAVE • AS).
  - This will display a file name input screen.
2. Input up to 8 characters for the file name and then press EXE.
  - If a file already exists with the same file name you enter in step 2, a message will appear asking if you want to replace the existing file with the new one. Press F1(F1)(Yes) to replace the existing file, or F6(F6)(No) to cancel the save operation and return to the file name input dialog box in step 2.

### ***Important!***

- An eActivity file with the g3e file name extension cannot be opened by any CASIO calculator model older than the fx-CG10/fx-CG20/fx-CG20 AU.
- Using the fx-CG10, fx-CG20 or fx-CG20 AU to open an eActivity file with a file name extension of g1e or g2e, which was created on an older model CASIO calculator (fx-9860G, fx-9860GII, fx-9860G AU, fx-9860G AU PLUS, GRAPH 85/85 SD, GRAPH 95/75), will cause any G-MEM (Graph memory) or DYNA MEM (Dynamic Graph memory) instances in the eActivity strips to be deleted.

---

## ■ Displaying the eActivity Memory Usage Screen

The maximum size of an eActivity file is approximately 29,000 bytes.\* You can use the eActivity file memory usage screen to check how much memory capacity remains for the file you are currently working on.

\* Actual maximum file size depends on capture memory and clipboard memory usage, and may be less than 29,000 bytes.

---

### ● To display the eActivity memory usage screen

On the workspace screen, press **F1** (FILE) **F4** (CAPACITY).

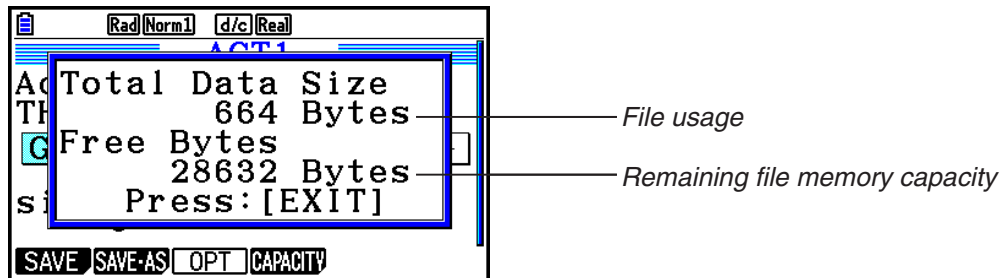

To exit the memory usage screen, press **EXIT**.

---

### ● To return to the file list from the workspace screen

Press **EXIT**.

If a confirmation message appears asking if you want to save the current file appears, perform one of the operations described below.

| To do this:                                                                               | Press this key: |
|-------------------------------------------------------------------------------------------|-----------------|
| Overwrite the existing eActivity file with the edited version and return to the file list | <b>F1</b> (Yes) |
| Return to the file list without saving the file you are currently editing                 | <b>F6</b> (No)  |
| Return to the eActivity workspace screen                                                  | <b>AC</b>       |

# Chapter 11 Memory Manager

This calculator includes main memory and storage memory for data storage.

The main memory is a work area where you can input data, perform calculations, and run programs. Data in the main memory can be deleted by batteries going dead or when you perform a reset.

Storage memory is an area for storing eActivity files, picture data (g3p files), and other relatively large-volume data. The storage memory uses “flash memory,” so data is safe even when power is interrupted. Normally, you should use the storage memory for data you need to store securely for long periods, loading data into the main memory only when you need it.

## 1. Using the Memory Manager

From the Main Menu, enter the **Memory** mode.



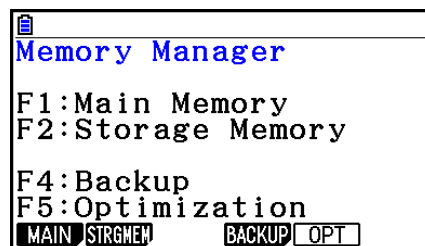

- {**MAIN**} ... {displays main memory information}
- {**STRGMEM**} ... {displays storage memory information}
- {**BACKUP**} ... {main memory backup}
- {**OPT**} ... {storage memory optimization}



### Memory Information Screen

The memory information screen shows information about one memory at a time: the calculator’s main memory or storage memory.

| To display this memory information screen: | Press this key:              |
|--------------------------------------------|------------------------------|
| Main memory                                | <p><b>[F1] (MAIN)</b></p>    |
| Storage memory                             | <p><b>[F2] (STRGMEM)</b></p> |























- Use the cursor  and  keys to move the highlighting and check the number of bytes used by each type of data.
- The status bar shows the remaining capacity of the currently displayed memory area (main or storage).
- If the name of a file transferred to storage memory from your computer or other source has a file name that is more than eight characters long, its name will be abbreviated to eight characters when displayed on the storage memory information screen (Example: AAAABBBBCC.txt > AAAABB~1.txt). Also, if a file name extension has more than three characters, everything after the third character of the file name extension will be trimmed off.
- Up to 300 files per folder can be displayed on the main memory information screen. If a folder has more than 300 files and you need to display them all, divide them among multiple folders so the total number of files in a single folder is not greater than 300.
- Up to 200 files per folder can be displayed on the storage memory information screen. If a folder has more than 200 files and you need to display them all, divide them among multiple folders so the total number of files in a single folder is not greater than 200.
- Though you can create folders on your computer nested to more than three levels in storage memory, this calculator will display only up to the third level.
- Moving the highlighting to a data group or folder and pressing  will display the data group or folder contents. Pressing  will return to the previous screen.
- While storage memory folder contents are displayed, the top line of the screen shows the file path to the current directory level. "SMEM" stands for "Storage Memory".
- The following are characters that can be used in file names and folder names.  
A-Z, a-z, 0-9, !, #, \$, %, ', ,(comma), (, ), +, -, ., :, =, @, [, ], ^, \_, ` , ~, space



















The following data can be checked.

## Main Memory







### Note

For information about the “Overwrite Check” column in the table below, see “To execute a send operation” (page 13-12) and “Error Checks During Data Copy” (page 11-9).



| Icon/Data Name                                                                                                         | Contents                                                                | Overwrite Check |
|------------------------------------------------------------------------------------------------------------------------|-------------------------------------------------------------------------|-----------------|
|  ALPHA MEM                            | Alpha letter variables                                                  | No              |
|  CONICS                               | Conics setting data                                                     | No              |
|  DYNA MEM                             | Dynamic Graph memory                                                    | Yes             |
|  E-CON2                               | E-CON group                                                             | —               |
|  CPnnn                                | Custom probe memory (1 to 99) contents                                  | Yes             |
|  SUnnn                                | E-CON3 setup memory (1 to 99) contents                                  | Yes             |
|  SDnnn                                | E-CON3 measurement memory (CH1, CH2, CH3, CHSNC, CHMIC, CHFFT) contents | Yes             |
|  ECON3                                | E-CON3 current setup memory contents                                    | Yes             |
|  EQUATION                             | Equation data                                                           | No              |
|  F-MEM                              | Function memory group                                                   | —               |
|  F-MEM $n$ ( $n = 1$ to 20)         | Function memory                                                         | No              |
|  G-MEM                              | Graph memory group                                                      | —               |
|  G-MEM $n$ ( $n = 1$ to 20)         | Graph memory                                                            | Yes             |
|  @GEOM                              | Geometry group                                                          | —               |
|  @IMAGE                             | <b>Geometry</b> mode current data                                       | Yes             |
|  Each Geometry file name            | Geometry data                                                           | Yes             |
|  LISTFILE                           | List file group                                                         | —               |
|  LIST $n$ ( $n = 1$ to 26, and Ans) | List memory contents                                                    | Yes             |
|  LISTFILE $n$ ( $n = 1$ to 6)       | List file                                                               | Yes             |
|  MAT_VCT                            | Matrix/Vector group                                                     | —               |
|  MAT $n$ ( $n = A$ to Z, and Ans)   | Matrix                                                                  | Yes             |
|  VCT $n$ ( $n = A$ to Z, and Ans)   | Vector                                                                  | Yes             |
|  @PICTPLT                           | Picture Plot group                                                      | —               |

| Icon/Data Name                                                                                                   | Contents                                                              | Overwrite Check |
|------------------------------------------------------------------------------------------------------------------|-----------------------------------------------------------------------|-----------------|
|  PICTPLOT                       | Picture Plot data                                                     | Yes             |
|  PROGRAM                        | Program group                                                         | —               |
|  Each program name              | Programs                                                              | Yes             |
|  RECURSION                      | Recursion data                                                        | No              |
|  S-SHEET                        | Spreadsheet group                                                     | —               |
|  _SETTING                       | <b>Spreadsheet</b> mode setting data                                  | No              |
|  Each spreadsheet name          | Spreadsheet data                                                      | Yes             |
|  SETUP                          | Setup data                                                            | No              |
|  STAT                           | Stat result data                                                      | No              |
|  STRING                         | String memory group                                                   | —               |
|  STRING $n$ ( $n = 1$ to 20)    | String memory                                                         | No              |
|  SYSTEM                         | OS and data shared by applications (clipboard, replay, history, etc.) | No              |
|  TABLE                         | Table data                                                            | No              |
|  FINANCE                      | <b>Financial</b> mode data                                            | No              |
|  V-WIN                        | V-Window memory group                                                 | —               |
|  V-WIN $n$ ( $n = 1$ to 6)    | V-Window memory                                                       | No              |
|  Y=DATA                       | Graph expression                                                      | No              |
|  Each add-in application name | Application-specific data                                             | Yes             |

### Storage Memory\*<sup>1</sup>

| Icon                                                                                | File Extension                  | Description                                                                                     |
|-------------------------------------------------------------------------------------|---------------------------------|-------------------------------------------------------------------------------------------------|
|  | .g1m, .g2m, .g3m, .g1r, or .g2r | Data items listed in the main memory information screen that has been copied to storage memory. |
|  | .g1e, .g2e, or .g3e             | eActivity files                                                                                 |
|  | .g3a, .g3l                      | .g3a: Add-in applications<br>.g3l: Add-in languages and add-in menus                            |
|  | .g3p                            | Picture files                                                                                   |
|  | .g3b                            | Flipbook files                                                                                  |
|  | .bmp                            | Bitmap files                                                                                    |
|  | .txt                            | Text files                                                                                      |



| Icon                                                                              | File Extension             | Description                                       |
|-----------------------------------------------------------------------------------|----------------------------|---------------------------------------------------|
|  | .CSV                       | CSV files                                         |
|  | Other file name extensions | These files are not supported by this calculator. |

\*1 “No Data” is displayed when there is no data in storage memory.

## ■ Creating a Folder in Storage Memory

### ● To create a new folder

1. While storage memory data is on the display, press **[F4]** (FOLDER) **[F1]** (MKEFLDR) to display the folder name input screen.
2. Input up to eight characters for the name you want to give to the folder.
  - Only the following characters are supported: A through Z, {, }, ', ~, 0 through 9
  - An “Invalid Name” error occurs if the name you input is already being used by an existing file.
  - To cancel folder creation, press **[EXIT]**.
3. Press **[EXE]** to create the folder and return to the storage memory information screen.

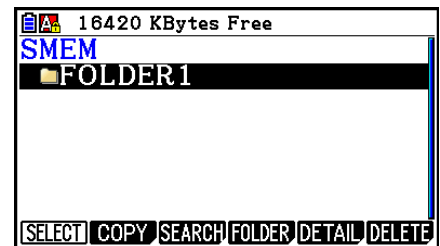
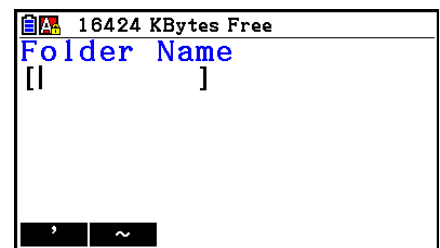

- This calculator supports nesting of folders up to three levels only.
- Though you can create folders on your computer nested to more than three levels in storage memory, this calculator will display only up to the third level. In this case you will be able to see folders stored in a level three folder, but you will not be able to open them.
- Selecting a folder stored in a level three folder and then performing the delete operation (page 11-10) will delete the selected (level 4) folder and everything inside it.

### ● To rename a folder

1. On the storage memory information screen, select the folder you want to rename.
2. Press **[F4]** (FOLDER) **[F2]** (RENFLDR) to display the rename folder screen.
  - The remaining steps of this procedure are the same as those starting with step 2 under “To create a new folder” above.

## ■ Viewing Detailed Information about a File in Storage Memory

On the storage memory information screen, you can highlight a file and then press **[F5]** (DETAIL) or **[▶]** to display its DETAIL screen. If you select a g3p or g3b file, these operations will display a preview of the file's image.

### Non g3p/g3b File

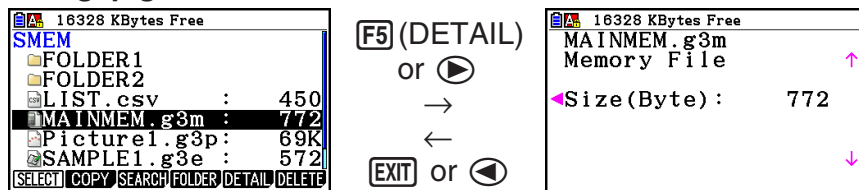

### g3p/g3b File

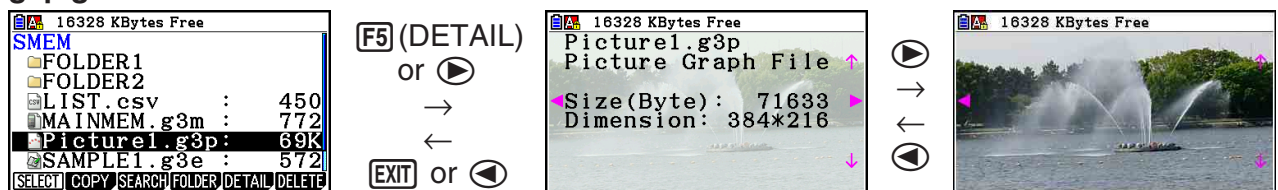

- You can use **[▶]** and **[◀]** to move between the storage memory information screen, file DETAIL screen, and image preview screen (g3p or g3b file only) as shown above.
- Pressing **[▲]** or **[▼]** while a file DETAIL screen or image preview screen is displayed will scroll either up or down to the DETAIL screen or image preview screen of the next file in the sequence that the files are listed on the storage memory information screen.

## ■ Selecting Data

- Press **[F1]** (SELECT) to select the currently highlighted item, which is indicated by the selection pointer (▶) appearing next to it. Pressing **[F1]** (SELECT) again will deselect the item, causing the selection pointer to disappear.
- You can select multiple files, if you want.

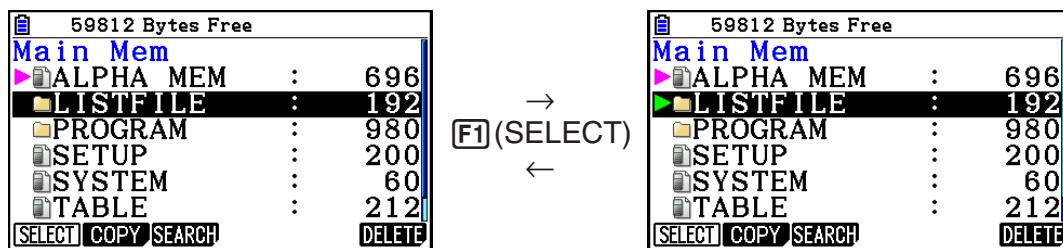

- Selecting a group or folder also selects everything inside of it. Deselecting a group or folder deselects all of its contents.

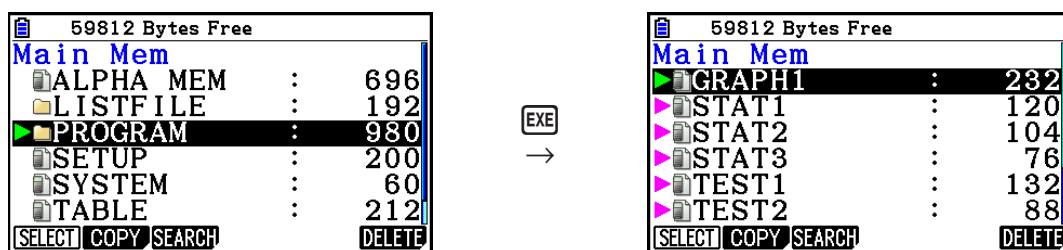

- If you select one or more individual items inside of a data group or folder, the selection pointer (▶) appears next to each item, while a selection pointer (▷) appears next to the group or folder name.

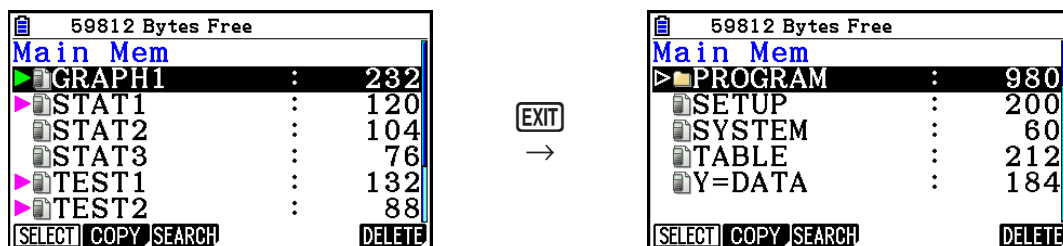

- Returning to the **Memory** mode initial screen deselects all currently selected items.

## ■ Copying Data

### • To copy from main memory to storage memory

The following procedure saves the selected data into a single file. You assign a name to the file, which is stored in storage memory.

1. On the main memory information screen, select the data you want to copy.
2. Press **[F2]** (COPY).

- This displays the folder selection screen. “ROOT” is the storage memory root directory.

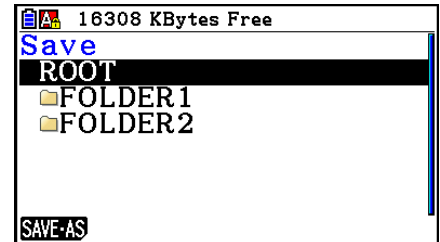

3. Specify the folder you want.

- Highlight ROOT to copy the data to the root directory.
- To copy the data to a specific folder, use **[▲]** and **[▼]** to move the highlighting to the desired folder and then press **[F1]** (OPEN).

4. Press **[F1]** (SAVE • AS).

- This displays the file name input screen.

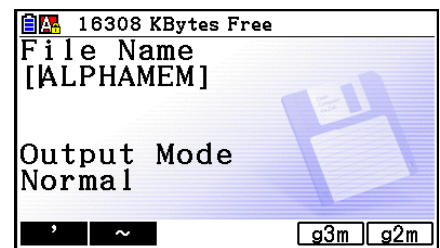

5. Input the file name you want to give to the file.

- To cancel the copy operation, press **[EXIT]**.

6. Press **[F5]** (g3m) or **[F6]** (g2m) as required to specify the file format.

- g3m is the fx-CG10/fx-CG20/fx-CG20 AU file type. g2m is the file format used to transfer data to the fx-9860GII and other older model calculators via Program-Link Software (FA-124).

7. Press **[EXE]** to copy the data.

- The message “Complete!” appears when the copy operation is complete.

---

## • To copy from storage memory to main memory

1. On the storage memory information screen, select the file you want to copy.
  - The only files that can be copied to main memory are those with one of the following file name extensions: g1m, g2m, g3m, g1r, g2r. Selecting a file of any other format and performing the following step will cause an “Invalid Type” error.
  - Performing the following step causes the files stored in storage memory to be expanded into individual component data (SETUP, STAT, and other data described on page 11-3), and copy the data to main memory.
2. Press **[F2]**(COPY) to copy the data.
  - Depending on the data type, an overwrite confirmation message will appear if there is always data with the same name in main memory as the data being copied. For information about which types of data cause a confirmation message to appear, see the “Overwrite Check” column in the data table on page 11-3. “Yes” means that a confirmation message is displayed, while “No” indicates that the copy operation is performed without any confirmation message.
  - The message “Complete!” appears when the copy operation is complete.

---

## • Error Checks During Data Copy

The following error checks are performed while a data copy operation is being executed.

### Low battery check

The calculator performs low battery check before starting the data copy operation. If the battery is at Level 1, a low battery error occurs and the copy operation is not performed.

### Available memory check

The calculator checks to see if there is enough free memory available to store the copied data.

A “Memory Full” error occurs if there is not enough memory available.

A “Too Much Data” error occurs when the number of data items is too great.

### Overwrite check

The calculator checks to see if there is any existing data at the copy destination with the same name as the data being copied.

An overwrite confirmation message appears if there is data with the same name.

- **[F1]**(Yes) ... overwrites the existing data with the new data
  - **[F6]**(No) ... advances to the next data item without copying the data with the same name
- Pressing **[AC]** will cancel the copy operation.

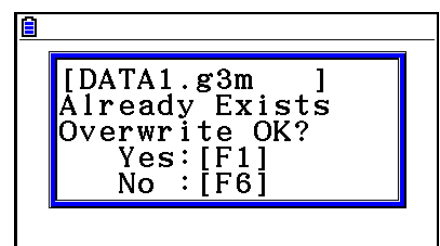

## Type mismatch error check

Only files whose names have the extension .g1m, .g2m, .g3m, .g1r, or .g2r can be copied from storage memory to main memory. Any other type of error will cause a type mismatch error.

## Other File Operations

### To delete a file or folder

1. Display the main memory information screen or the storage memory information screen.
2. Select all of the files and folders you want to delete.
  - For details about selecting files and folders, see “Selecting Data” (page 11-7).
3. Press **[F6]** (DELETE).

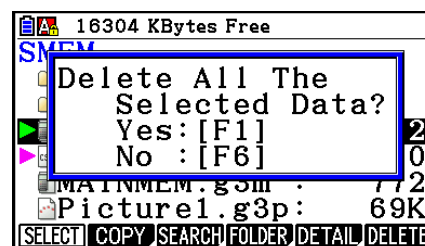

4. In response to the confirmation dialog that appears, press **[F1]** (Yes) to delete or **[F6]** (No) to cancel the delete operation.

### To search for a file

**Example** To search for all files in the main memory (or storage memory) whose names begin with the letter “R”

1. Display the main memory (or storage memory) information screen.
2. Press **[F3]** (SEARCH).
  - Input the letter “R” for the keyword and press **[EXE]**.

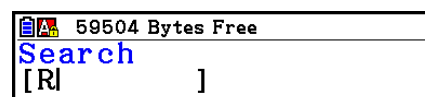

- The first file name that begins with the letter “R” appears highlighted on display.

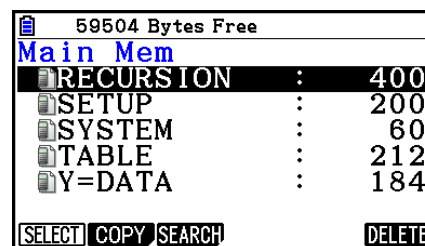

- You can input up to eight characters for the keyword.
- The message “Not Found” appears if there are no file names that match your keyword.

## ■ Backing Up Main Memory Data

### • To back up main memory data

1. On the initial **Memory** mode screen press **[F4]** (BACKUP).

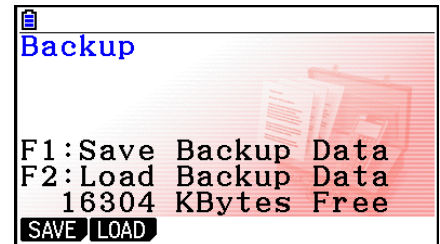

2. Press **[F1]** (SAVE).

- This displays a folder selection screen.

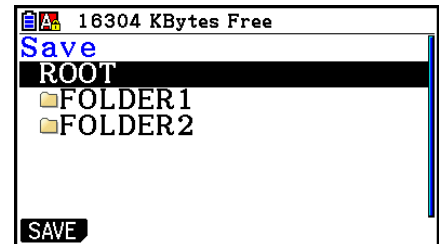

3. Use **▲** and **▼** to select the folder where you want to save the data.

4. Press **[EXE]** to start the backup.

- A "Memory Full" occurs when there is not enough space available in the storage memory to complete the backup operation.
- The following message appears if there is already backup data in the storage memory.

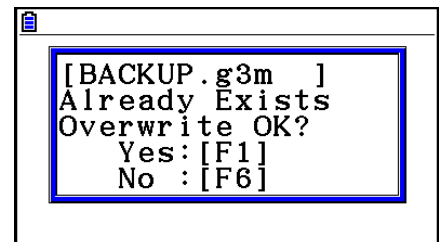

Press **[F1]** (Yes) to back up the data, or **[F6]** (No) to cancel the backup operation.

The message "Complete!" appears when the backup operation is finished.

- Backup data is saved in a file named BACKUP.g3m.

5. Press **[EXIT]** to return to the screen displayed in step 1.

---

## • To restore backup data to the main memory

1. On the initial **Memory** mode screen press **[F4]** (BACKUP).
  - On the screen that appears, you can confirm whether or not there is backup data in the storage memory.
2. Press **[F2]** (LOAD).
  - This displays the folder selection screen.

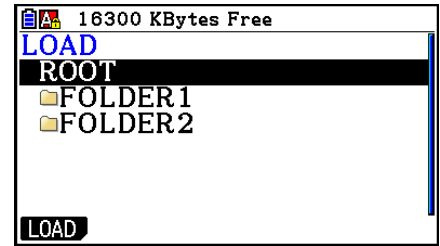

3. Use **▲** and **▼** to select a folder.
4. Press **[EXE]**.<sup>\*1</sup>
  - A message appears to confirm whether or not you really want to restore the backed up data.

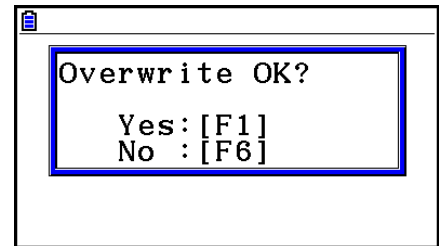

- <sup>\*1</sup> The message "No Data" will appear if there is no backup data stored in the selected folder. Pressing **[EXIT]** will return the screen in step 1.
5. Press **[F1]** (Yes) to restore the data and delete any data currently in the area. Press **[F6]** (No) to cancel the data backup operation.
    - The message "Complete!" appears when the restore operation is finished.
    - Press **[EXIT]** to return to the screen displayed in step 1.



---

## ■ Optimizing Storage Memory

Storage memory can become fragmented after many store and load operations, causing entire blocks of memory to become unavailable for data storage. Because of this, you should periodically perform the storage memory optimization procedure, which rearranges the data in the storage memory and makes memory usage more economical.

- Note that the calculator performs storage memory optimization automatically whenever you perform a save operation and the calculator discovers storage memory is running low.

---

### • To optimize the storage memory

On the initial **Memory** mode screen, press **[F5]** (OPT) to optimize the storage memory.

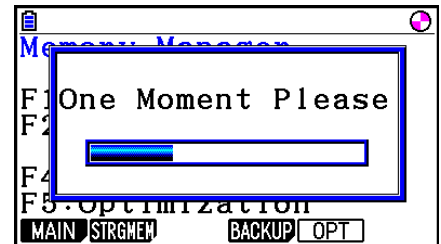

The message "Complete!" appears when the optimize operation is complete.

Press **[EXIT]** to return to the initial **Memory** mode screen.

- In some cases, the amount of free memory capacity may be unchanged when you check it after performing the optimization procedure. This does not indicate any problem with the calculator.

# Chapter 12 System Manager

Use the System Manager to view system information and make system settings.

## 1. Using the System Manager

From the Main Menu, enter the **System** mode and display the following menu items.

- **F1** (DISPLAY) ... {display brightness adjustment}
- **F2** (PWRProp) ... {power properties settings}
- **F3** (LANGUAGE) ... {system language}
- **F4** (VERSION) ... {version}
- **F5** (RESET) ... {system reset operations}
- **F6** (▷) **F1** (BattSet) ... {battery settings}
- **F6** (▷) **F2** (UserName) ... {user name registration}
- **F6** (▷) **F5** (OS Update) ... {OS update}

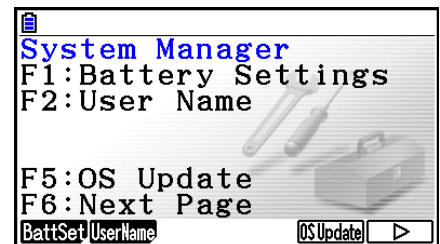
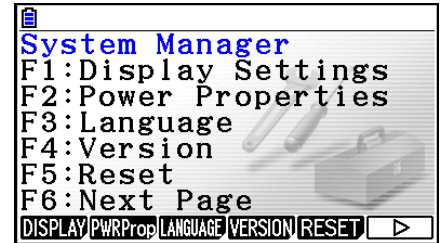

## 2. System Settings

### ■ Display Brightness Adjustment

While the initial **System** mode screen is displayed, press **F1** (DISPLAY) to display the brightness adjustment screen.

- The **▶** cursor key makes display brightness lighter.
- The **◀** cursor key makes display brightness darker.
- **F1** (INITIAL) returns display brightness to its initial default.

Press **EXIT** or **SHIFT** **EXIT** (QUIT) to return to the initial **System** mode screen.

---

## ■ Power Properties Settings

---

### • To specify the Auto Power Off trigger time

While the initial **System** mode screen is displayed, press **F2** (PWRProp) to display the Power Properties setting screen.

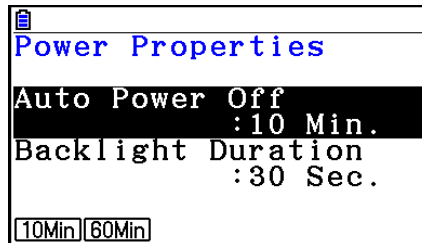

- **F1** (10Min) ... {10 minutes} (initial default setting)
- **F2** (60Min) ... {60 minutes}

Press **EXIT** or **SHIFT EXIT** (QUIT) to return to the initial **System** mode screen.

---

### • To specify the backlight duration

1. While the initial **System** mode screen is displayed, press **F2** (PWRProp) to display the Power Properties setting screen.

2. Use **▲** and **▼** to select "Backlight Duration".

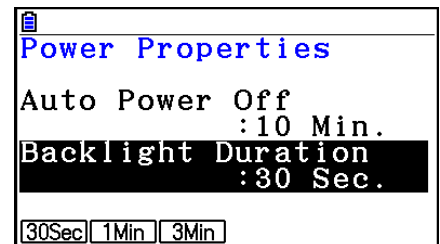

- **F1** (30Sec) ... {turns off the backlight 30 seconds after the last key operation is performed} (initial default setting)
  - **F2** (1Min) ... {turns off the backlight one minute after the last key operation is performed}
  - **F3** (3Min) ... {turns off the backlight three minutes after the last key operation is performed}
3. Press **EXIT** or **SHIFT EXIT** (QUIT) to return to the initial **System** mode screen.

---

## ■ System Language Setting

Use LANGUAGE to specify the display language for built-in applications.

---

### ● To select the message language

1. While the initial **System** mode screen is displayed, press **F3** (LANGUAGE) to display the Message Language selection screen.
  2. Use the **▲** and **▼** cursor keys to select the language you want, and then press **F1** (SELECT).
  3. The pop up window appears using the language you selected. Check the contents and then press **EXIT**.
  4. Press **EXIT** or **SHIFT** **EXIT** (QUIT) to return to the initial **System** mode screen.
- 

### ● To select the menu language

1. While the initial **System** mode screen is displayed, press **F3** (LANGUAGE) to display the Message Language selection screen.
2. Press **F6** (MENU).
3. Use the **▲** and **▼** cursor keys to select the language you want, and then press **F1** (SELECT).
4. The pop up window appears using the language you selected. Check the contents and then press **EXIT**.
  - Press **F6** (MESSAGE) to return to the Message Language selection screen.
5. Press **EXIT** or **SHIFT** **EXIT** (QUIT) to return to the initial **System** mode screen.

---

## Version List

Use VERSION to display the operating system version.

---

### • To display version information

1. While the initial **System** mode screen is displayed, press **F4** (VERSION) to display the Version list.
  2. Use **▲** and **▼** to scroll the screen. The contents of the list are shown below.
    - Operating system version
    - Add-in application names and versions (only installed add-ins are displayed)
    - Message languages and versions
    - Menu languages and versions
  3. Press **EXIT** or **SHIFT EXIT** (QUIT) to return to the initial **System** mode screen.
- 

## Reset

1. While the initial **System** mode screen is displayed, press **F5** (RESET) to display the Reset Screen 1.
  - **F1** (SETUP) ... {setup initialization}
  - **F2** (MAIN) ... {main memory data clear}
  - **F3** (ADD-IN) ... {add-in application clear}
  - **F4** (STRGMEM) ... {storage memory data clear}
  - **F5** (A&S) ... {add-in application and storage memory data clear}

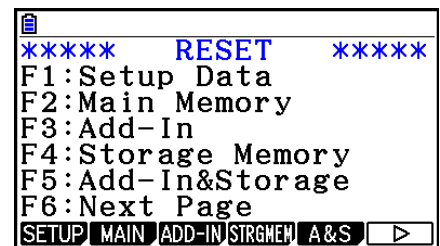

Pressing **F6** (▷) on the above screen displays the Reset Screen 2 shown below.

- **F1** (M&S) ... {main memory data and storage memory data clear}
- **F2** (ALL) ... {all memory clear}
- **F3** (LANGUAGE) ... {add-in language clear}



The following table shows the functions of the function keys. You can use the function keys to delete the specific data you want.

### Function Key Functions

|                                    | Initialize Setup Information | Delete Main Memory Data | Delete Add-in Applications | Delete Add-in Languages | Delete Storage Memory Data (Excluding Add-in Applications and Languages) |
|------------------------------------|------------------------------|-------------------------|----------------------------|-------------------------|--------------------------------------------------------------------------|
| <b>F1</b> (SETUP)                  | ○                            |                         |                            |                         |                                                                          |
| <b>F2</b> (MAIN)                   | ○                            | ○                       |                            |                         |                                                                          |
| <b>F3</b> (ADD-IN)                 |                              |                         | ○                          |                         |                                                                          |
| <b>F4</b> (STRGMEM)                |                              |                         |                            |                         | ○                                                                        |
| <b>F5</b> (A&S)                    |                              |                         | ○                          |                         | ○                                                                        |
| <b>F6</b> (▷) <b>F1</b> (M&S)      | ○                            | ○                       |                            |                         | ○                                                                        |
| <b>F6</b> (▷) <b>F2</b> (ALL)      | ○                            | ○                       | ○                          | *1                      | ○                                                                        |
| <b>F6</b> (▷) <b>F3</b> (LANGUAGE) |                              |                         |                            | ○                       |                                                                          |

\*1 If an add-in language is selected for the System Language Setting (page 12-3), the add-in language file (g3l) is not deleted.

2. Press the function key that corresponds to the reset operation you want to perform.
3. In response to the confirmation message that appears, press **F1**(Yes) to perform the reset operation you specified, or **F6**(No) to cancel.
4. A message appears to let you know when the reset operation is complete.

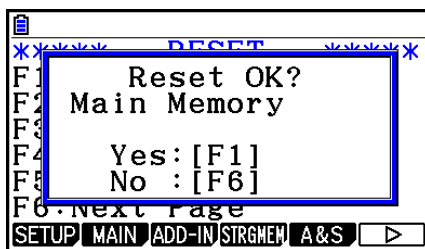

Screen produced when **F2**(MAIN) is pressed in step 2.

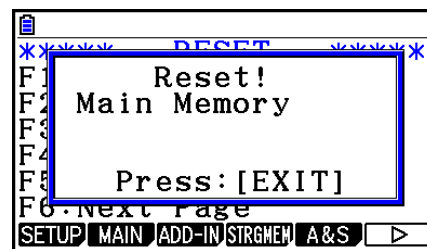

Screen produced when **F1**(Yes) is pressed in step 3.

### Important!

Note that deleting add-in language data causes the language setting to switch automatically to English. The deleted language will no longer be available for display.

## Note

After pressing **F6**(▷) **F2**(ALL) to execute initialize all you will need to configure a number of initial settings, the same way you do the first time you turn on the calculator after purchasing it. The following screens will appear automatically in sequence. Use each one to configure the required settings.

- Message Language selection screen (page 12-3)
- Display Settings screen (page 12-1)
- Power Properties screen (page 12-2)
- Battery Settings screen (shown below)

---

## ■ Battery Settings

### *Important!*

Whenever you replace batteries, be sure to perform the operation below to specify the type of batteries you are loading.

---

### • To change the battery type

1. From the initial **System** mode screen, press **F6**(▷) **F1**(BattSet).

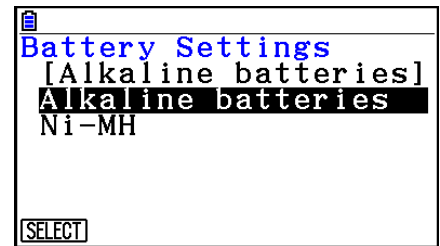

2. Use ▲ and ▼ to move the highlighting to the battery type that matches the batteries you are using and then press **F1**(SELECT).

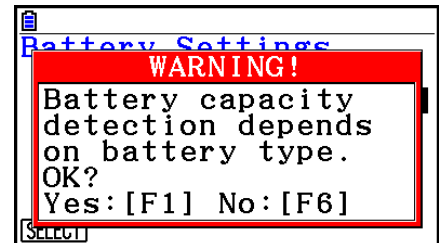

3. Press **F1**(Yes) to change the setting, or **F6**(No) to cancel without changing anything.

---

## ■ User Name

Use the procedure in this section to identify yourself as the user of the calculator by registering your name and organization.

### ***Important!***

- In order to protect against misuse of your calculator, be sure to also register a password when you register your name and organization. You will need to enter the correct password whenever you want to change or delete the registered user name and/or organization. Take care that you do not forget the password.
- Do not remove batteries or press the RESTART button while the operation below is in progress. Doing so can corrupt data.

---

### • To register or edit a user name and organization

1. While the initial **System** mode screen is displayed, press **F6**(▷)**F2**(UserName) to display the user name screen.

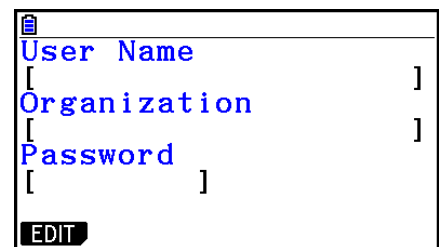

```

┌───┐
│ User Name          │
│ ┌───────────┐     │
│ Organization      │
│ ┌───────────┐     │
│ Password          │
│ ┌───────────┐     │
│ └───────────┘     │
│ ┌───┐             │
│ EDIT │             │
└───┘

```

2. Press **F1**(EDIT).
  - If nothing is registered yet, the cursor will appear in the “User Name” field.
  - If there is already data registered, the cursor will appear in the “Password” field. If this happens, enter the correct password and then press **EXE**. If the password matches the one that is registered, the cursor will move to the “User Name” field. If the password does not match, the cursor will remain in the “Password” field.
3. Input information in the sequence shown below.
  - (1) Input a User Name (up to 19 characters) and then press **▼** or **EXE**.
  - (2) Input your Organization (up to 19 characters) and then press **▼** or **EXE**.
  - (3) Input a Password (up to eight characters) and then press **EXE**.
    - Inputting a password and pressing **EXE** will display a registration confirmation dialog box to appear.
4. Press **F1**(Yes) to register the information or **F6**(No) to cancel the registration operation.



---

- **To delete the user name and organization name**

1. While the initial **System** mode screen is displayed, press **F6** (▷) **F2** (UserName) to display the user name screen.
2. Press **F2** (DELETE).
  - This will display the cursor in the “Password” field.
3. Enter the correct password and then press **EXE**.
  - This causes a confirmation dialog box to appear.
4. Press **F1** (Yes) to delete or **F6** (No) to cancel the delete operation.

---

## ■ OS Update

You can update the operating system by connecting the calculator to a computer. For details, see the text of releases that are issued when a new operating system version is released.

# Chapter 13 Data Communication

This chapter explains how to transfer data between a calculator and a computer, or between two calculators. Data communication operations are performed in the **Link** mode.

From the Main Menu, enter the **Link** mode. The following data communication main menu appears on the display.

- **{TRANSMIT}** ... {displays the data send screen}
- **{RECV}** ... {displays the data receive screen}
- **{EXAM}** ... {displays the Examination Mode menu}
- **{CABLE}** ... {displays the cable type selection screen}
- **{WAKEUP}** ... {displays the wakeup setting screen}
- **{CAPTURE}** ... {displays the screen image capture setting screen}

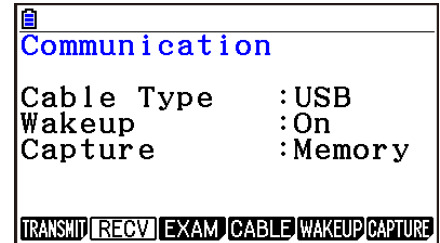

Communication parameters are fixed at the following settings.

- 3-pin serial port
  - Speed (BPS): 9600 bps max. (Connected with CFX-9850G series or fx-7400G series calculator)  
115200 bps max. (Connected with another fx-CG10, fx-CG20, fx-CG20 AU, fx-CG20 CN, fx-9860GII SD, fx-9860GII, fx-9860G AU PLUS, fx-9750GII, fx-7400GII, fx-9860G Slim (OS 1.11), fx-9860G SD (OS 2.0), fx-9860G (OS 2.0) or fx-9860G AU (OS 2.0) calculator)
  - Parity (PARITY): NONE
- USB port
  - Communication speed is in accordance with USB standards.

## ■ Configuring the Receiver's Wakeup Feature

When Wakeup is turned on the receiver, the receiver turns on automatically when data transfer starts.

- When communicating between two calculators (3PIN selected as the cable type), the receiver enters the receive mode automatically after it wakes up.
- When communication is with a computer (USB selected as the cable type), connecting the USB cable to a computer and then to the calculator (while the calculator is turned off) will cause the calculator to turn on and the "Select Connection Mode" dialog box to appear.

### • To configure the receiver's wakeup feature

1. On the receiver's data communication main menu, press **[F5]** (WAKEUP).

This displays the Wakeup setting screen.

- **{On}** ... {turns Wakeup on}
- **{Off}** ... {turns Wakeup off}

2. Press **[F1]** (On).

This turns on Wakeup and returns of the data communication main menu.

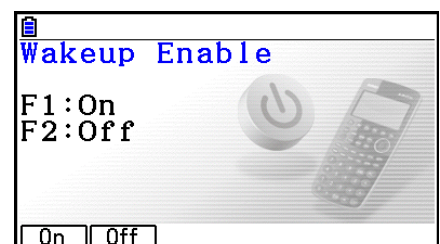

3. Turn off the receiver.
4. Connect the receiver to the sender.
5. Starting a send operation on the sender causes the receiver to turn on automatically and performs the data transfer operation.

## ■ Capture Set Mode

You can specify either g3p format or bmp format for screen images saved by the operation **[SHIFT] [7] (CAPTURE)**.

The data communication menu provides the following operations.

**[F6] (CAPTURE) [F1] (Memory)** ... Saves screen capture images in g3p format.

**[F6] (CAPTURE) [F2] (BMP)** ... Saves screen capture images in bmp format.

For details about the screen capture operation, see “Using Screen Capture” (page 1-36).



## ■ Select Connection Mode Screen

Connecting the USB cable to the calculator will cause the “Select Connection Mode” dialog box to appear. The key operation you should perform on this screen depends on the device currently connected to the calculator.

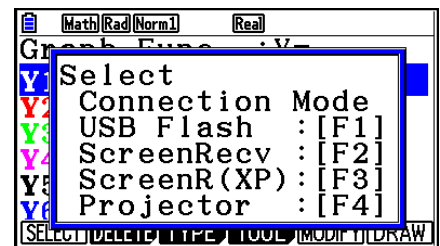
- **[F1] (USB Flash)** ... Mode for connecting the calculator to a computer for data transfer. See “To establish a connection between the calculator and a computer” (page 13-3).
- **[F2] (ScreenRecv)** ... Mode for using the Screen Receiver software on a Windows Vista® or later computer to display the calculator screen on the computer. For details, see the separate “Screen Receiver User’s Guide”.  
Wait until the calculator screen appears on the Screen Receiver window before performing any calculator operation.
- **[F3] (ScreenR(XP))** ... Mode for using the Screen Receiver software on a Windows® XP computer to display the calculator screen on the computer.
- **[F4] (Projector)** ... Mode for connecting the calculator to a projector and projecting the calculator screen. See “Connecting the Calculator to a Projector” (page 13-16).



### **Important!**

The “Select Connection Mode” dialog box will not appear if you connect the USB cable to the calculator while the  icon is in the status bar or while a graph, **Geometry** mode figure, or other figure is flashing on the display. Wait until the  icon disappears, or perform the required operation to stop the flashing of the graph or figure, and then try connecting the USB cable again.

# 1. Performing Data Communication between the Calculator and a Personal Computer

Establishing a USB connection between the calculator and a computer will cause the computer to recognize the calculator's storage memory as a mass storage drive. Connection immediately causes main memory contents to be read into storage memory automatically, so main memory data can be accessed from the computer. After a connection is established, data can be transferred between the calculator and computer using computer operations only.

---

## ■ Minimum Computer System Requirements

The following are the minimum requirements for a computer to exchange data with the calculator.

- USB port
- Running one of the following operating systems.

Windows Vista (32-bit, SP1 or later)

Windows 7 (32-bit, 64-bit)

Windows 8 (32-bit, 64-bit)

Windows 8.1 (32-bit, 64-bit)

Windows 10 (32-bit, 64-bit)

Mac OS X (10.5.6 or later, 10.6.2 or later)

---

## ■ Connecting and Disconnecting with a Computer in the Mass Storage Mode

Use the USB cable that comes with the calculator to connect to your computer.

### ***Important!***

Never touch the USB cable plugs and screen while a data communication operation is in progress. Static electricity from your fingers can cause data communication to be terminated.

---

### • To establish a connection between the calculator and a computer

1. Start up your computer.
2. After starting up your computer, use the USB cable to connect it to the calculator.

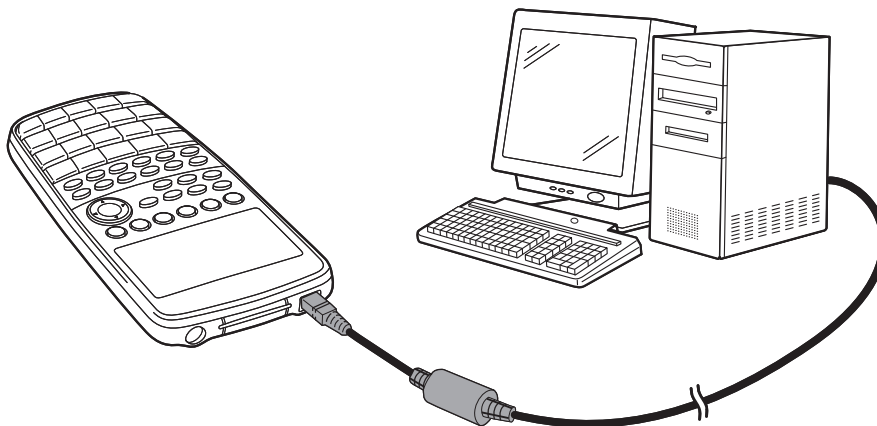

- The calculator will turn on automatically and the “Select Connection Mode” screen will appear.

3. Press **[F1]** (USB Flash).

- The message “Preparing USB” will appear on the calculator screen. Stand by and do not perform any operation on the calculator. Establishing a connection between the calculator and a computer will cause the screen shown nearby to appear.

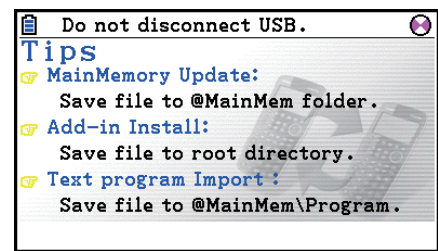

4. On your computer, open the calculator drive.

- If you are using Windows, the location of the calculator drive will depend on your Windows Version. Use Windows Explorer to open the calculator drive.
  - Windows Vista, Windows 7, Windows 8: Inside Computer
  - Windows 8.1: Inside PC
  - Windows 10: Inside This PC
- Under Mac OS X, the calculator drive icon appears on the Mac desktop. Double-click the icon to open it.
- The calculator drive represents calculator's storage memory.

5. Perform the required operation on your computer to transfer the data.

- For details about data transfer operations, see “Transferring Data between the Calculator and a Personal Computer” (page 13-5).

---

• **To terminate the connection between the calculator and a computer**

1. If the calculator is connected to a Windows computer, note the drive letter (E, F, G, etc.) assigned to the calculator drive.
2. Depending on the type of operating system your computer is running, perform one of the following operations.
  - Windows: Click the “Safely Remove Hardware” icon in the task tray in the lower right corner of the display. On the menu that appears, select “USB mass storage device” whose letter matches the calculator drive letter you noted in step 1 above. Check to make sure the “Safe To Remove Hardware” message is displayed.
  - Mac OS: Drag the calculator drive icon to the Eject icon (Trash icon). Check to make sure that the calculator drive icon is no longer on your desktop.
3. The message “Updating Main Memory” will appear on the calculator screen. Stand by and do not perform any operation on the calculator. The message “Complete!” will appear after updating of main memory is complete. To close the message dialog box, press **[EXIT]**.
4. Disconnect the USB cable from the calculator.

## ■ Transferring Data between the Calculator and a Personal Computer

This section explains how to connect the calculator to the computer and open the calculator drive on the computer to transfer data.

### ● Main Memory Data during a USB Connection

The contents of the @MainMem folder in the calculator drive correspond to the contents of the calculator's main memory. Each time you establish a connection between the calculator and a computer, the contents of the calculator's main memory are copied to storage memory. If there is not enough storage memory capacity to support the copy operation, the message "Storage Memory Full" will be displayed on the calculator and the copy operation will not be performed. If this happens, delete files you no longer need from storage memory to increase capacity, and then try establishing a USB connection again.

Each group in main memory is displayed as a folder in the @MainMem folder. Also, each data item in main memory is displayed as a file in the @MainMem folder.

Main Memory group names and data item names are displayed in the @MainMem folder as shown in the table below.

| Main Memory Group Name | @MainMem Folder Name | Main Memory Item Name | @MainMem File Name |
|------------------------|----------------------|-----------------------|--------------------|
| E-CON2                 | ECON2                | ECON3                 | ECON3.g3m          |
|                        |                      | SUxxx                 | SUxxx.g3m          |
|                        |                      | SDxxx                 | SDxxx.g3m          |
|                        |                      | CPxxx                 | CPxxx.g3m          |
| F-MEM                  | FMEM                 | F-MEM xx              | FMEMxx.g3m         |
| @GEOM                  | GEOM                 | @IMAGE                | @IMAGE.g3m         |
|                        |                      | <Data name>           | <Data name>.g3m    |
| G-MEM                  | GMEM                 | G-MEM xx              | GMEMxx.g3m         |
| LISTFILE               | LISTFILE             | LIST xx               | LISTxx.g3m         |
|                        |                      | LISTFILE x            | FILEx.g3m          |
| MAT_VCT                | MAT_VCT              | MAT ANS               | MATANS.g3m         |
|                        |                      | MAT x                 | MATx.g3m           |
|                        |                      | VCT ANS               | VCTANS.g3m         |
|                        |                      | VCT x                 | VCTx.g3m           |
| @PICTPLT               | @PICTPLT             | PICTPLOT              | PICTPLOT.g3m       |
| PROGRAM                | PROGRAM              | <Program name>        | <Program name>.g3m |
|                        |                      |                       | <Program name>.txt |
| S-SHEET                | SSHEET               | <Data name>           | <Data name>.g3m    |
| V-WIN                  | VMEM                 | V-WIN x               | VMEMx.g3m          |
| ROOT                   | ROOT                 | ALPHA MEM             | ALPHAMEM.g3m       |
|                        |                      | RECURSION             | RECUR.g3m          |
|                        |                      | SETUP                 | SETUP.g3m          |
|                        |                      | STRING                | STRING.g3m         |
|                        |                      | CONICS                | CONICS.g3m         |

| Main Memory Group Name | @MainMem Folder Name | Main Memory Item Name | @MainMem File Name |
|------------------------|----------------------|-----------------------|--------------------|
| ROOT                   | ROOT                 | DYNA MEM              | DYNA MEM.g3m       |
|                        |                      | EQUATION              | EQUATION.g3m       |
|                        |                      | FINANCIAL             | FINANCE.g3m        |
|                        |                      | STAT                  | STAT.g3m           |
|                        |                      | SYSTEM                | SYSTEM.g3m         |
|                        |                      | TABLE                 | TABLE.g3m          |
|                        |                      | Y=DATA                | Y=DATA.g3m         |

### • Main Memory Data Updating upon Termination of a USB Connection

While there is a USB connection between the calculator and a computer, you can use the computer to edit the @MainMem folder contents by deleting folders and files, editing files, adding files, etc. When you terminate the USB connection, the calculator's main memory data is updated with the current contents of the @MainMem folder. Note the following important points.

- Deleting the @MainMem folder will cause all data in the calculator's main memory to be initialized.
- Updating the @MainMem folder affects up to three levels of folders inside the storage memory root folder.

SMEM ← Storage memory root folder

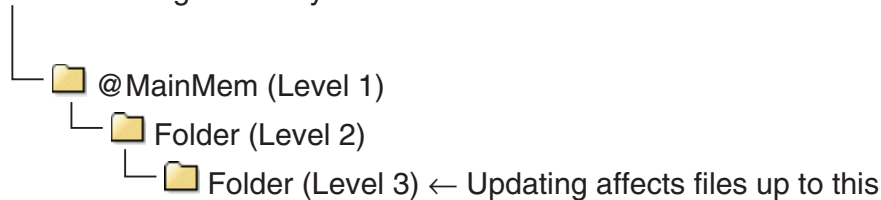

Any folders and files past Level 3 are moved to a folder named "SAVE-F" in storage memory.

- Adding a g3m file to the @MainMem folder while there is a USB connection between the calculator and a computer will copy the data item(s) included in the g3m file to the calculator's main memory. For details about the main memory data item names that correspond to the g3m file names in the @MainMem folder, see "Main Memory Data during a USB Connection" (page 13-5). If there is no group in main memory that corresponds to the data items included in the g3m file, a corresponding group will be created automatically and the data items will be copied to that group.
- Depending on the data type, an overwrite confirmation message will appear if there is already data with the same name in calculator's main memory as the data being copied from @MainMem folder. For information about which types of data cause a confirmation message to appear, see the "Overwrite Check" column in the data table on page 11-3. "Yes" means that a confirmation message is displayed, while "No" indicates that the copy operation is performed without any confirmation message.



- If you place a file or folder that is not supported by the calculator into the @MainMem folder, it will be transferred to a folder named “SAVE-F” in the calculator’s storage memory and will not be shown in main memory.
- If the size of the data in the @MainMem folder exceeds the available capacity of main memory, the message “Memory ERROR” will appear on the calculator when you terminate the USB connection and main memory will not be updated.
- If there is an add-in file (.g3a/.g3l) in the @MainMem folder, that file will be moved to the storage memory root directory. Note, however, that if there is already an add-in with the same name in storage memory root directory, the existing add-in will be overwritten with the new one, without displaying a confirmation message.
- If a text file (.txt) has been added to the @MainMem\PROGRAM folder, it will be automatically converted to a program with same name as the file and stored in the main memory PROGRAM group. For details about the rules that govern file names and other conversion issues, see “Program and Text File Conversion Rules” (page 8-8).

## • To transfer data between the calculator and a computer

1. Connect the calculator and computer, and open the calculator drive on the computer.

- See “To establish a connection between the calculator and a computer” (page 13-3).

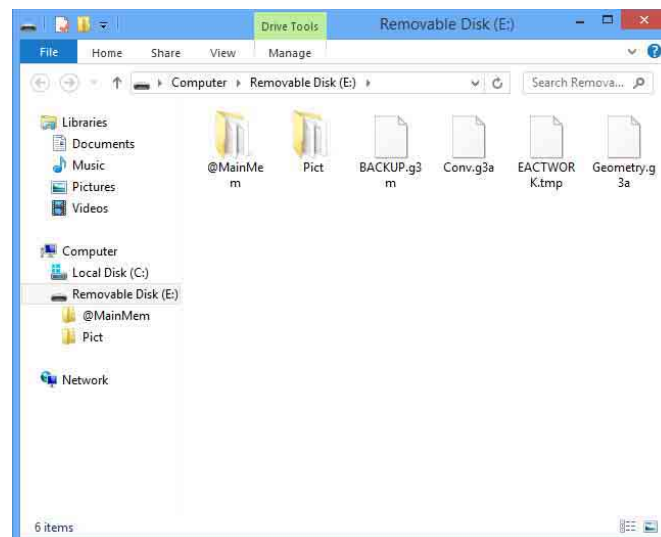

2. Copy, edit, delete, or add files as desired.

- Use the same file operations that you normally do on your computer.
- For information about the folders and files in the @MainMem folder, see “Main Memory Data during a USB Connection” (page 13-5) and “Main Memory Data Updating upon Termination of a USB Connection” (page 13-6).

3. After you finish all the operations you want to perform, terminate the connection between the calculator and a computer.

- See “To terminate the connection between the calculator and a computer” (page 13-4).

### **Note**

Copying a file to the storage memory can cause the connection between the calculator and computer to be dropped. If this happens, enter the **Memory** mode and execute an Optimize operation (page 11-13), and then re-establish a connection between the calculator and computer.



---

## ● To use your computer to edit a program created on the calculator

1. Use the calculator's **Program** mode to create the program. (See "Chapter 8 Programming.")
2. Connect the calculator and computer, and open the calculator drive on the computer.
3. Display the contents of the @MainMem\PROGRAM folder, and then use a text editor to open the text file with the same name as the program you want to edit.
  - If you are running Windows you could use Notepad, etc. With the Mac OS, you can use TextEdit, etc.
4. Perform the required edits.
  - For information about calculator commands and their corresponding special character strings, see "CASIO Scientific Function Calculator Special Commands ⇔ Text Conversion Table" (page 8-59).
5. After you are finished editing, save and close the text file.
  - Save the edits under a different file name, as required. If you use Save As to save your edits, be sure to save the new file in @MainMem\PROGRAM\.
  - Be sure to save the file in ASCII or ANSI code txt format.
6. Terminate the connection between the calculator and a computer
  - See "To terminate the connection between the calculator and a computer" (page 13-4).

---

## ■ Installing Add-In Files

Add-in files can be installed on the calculator to give it additional functions. The following are types of add-in files that are available.

- Add-in applications (.g3a): These files add new applications to the Main Menu.
- Add-in languages (.g3l): These files add languages to those that can be selected with the "System Language Setting" procedure (page 12-3) for on-screen messages.
- Add-in menus (.g3l): These files add languages to those that can be selected with the "System Language Setting" procedure (page 12-3) for function menus.

---

## ● To install an add-in file

In step 2 of the procedure under "To transfer data between the calculator and a computer" (page 13-7), copy the add-in file (.g3a/.g3l) you want to install to the calculator drive root directory.

---

## ■ USB Connection Precautions

- Depending on the operating system your computer is running, perform one of the following operations on the computer to terminate a connection with the calculator.
  - Windows: Click the “Safely Remove Hardware” icon in the task tray in the lower right corner of the display. On the menu that appears, select “USB mass storage device”. Check to make sure the “Safe To Remove Hardware” message is displayed.
  - Mac OS: Drag the calculator drive to Trash. Check to make sure that the calculator drive is no longer on your desktop.
- Never use a computer operation to format the calculator drive. Doing so will cause a “File System ERROR” message to appear on the calculator screen after you terminate the USB connection between the calculator and computer. When this happens, you will not be able to start up the calculator unless you perform an Initialize All operation, which deletes all data currently in calculator memory. For details, see “File System ERROR” (page  $\alpha$ -8).
- When copying a file from your computer’s local disk to the calculator drive, it may take several minutes before copying starts. This is because copying automatically performs optimization of the calculator’s storage memory. It does not indicate malfunction. For information about storage memory optimization, see “Optimizing Storage Memory” (page 11-13).
- A USB connection between the calculator and a computer may be terminated automatically if the computer enters a power save mode, sleep mode, or any other standby state.

## 2. Performing Data Communication between Two Calculators

---

### ■ Connecting Two Calculators

The following procedure describes how to connect two calculators with the optionally available SB-62 cable\*.

\* Included with the calculator in some areas.

---

#### • To connect two calculators

1. Check to make sure that the power of both calculators is off.
2. Connect the two calculators using the cable.
3. Perform the following steps on both calculators to specify 3PIN as the cable type.
  - (1) From the Main Menu, enter the **Link** mode.
  - (2) Press **F4** (CABLE). This displays the cable type selection screen.
  - (3) Press **F2** (3PIN).

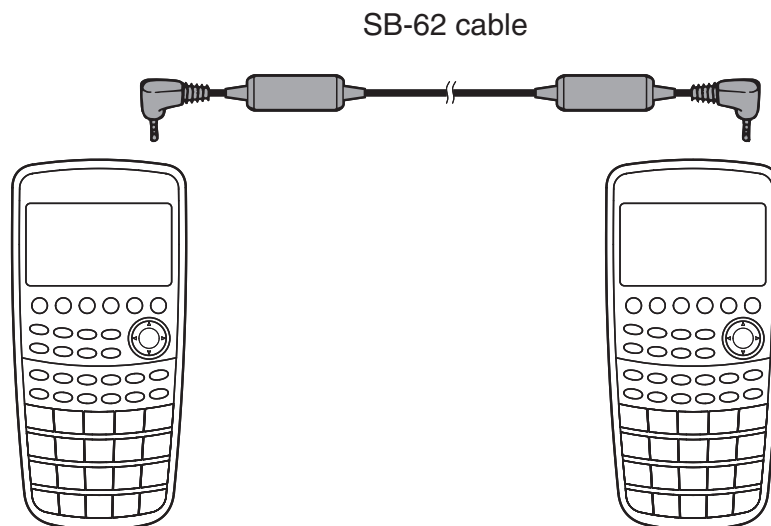

- Models that are supported for this configuration are shown below.

fx-CG10, fx-CG20, fx-CG20 AU, fx-CG20 CN, fx-9860GII SD, fx-9860GII, fx-9860G AU PLUS, fx-9750GII, fx-7400GII, fx-9860G Slim (OS 1.11), fx-9860G SD (OS 2.0), fx-9860G (OS 2.0), fx-9860G AU (OS 2.0), CFX-9850G series

## ■ Performing a Data Transfer Operation

Connect the two calculators and then perform the following procedures.

### Receiving calculator

To set up the calculator to receive data, press **F2** (RECV) while the data communication main menu is displayed.

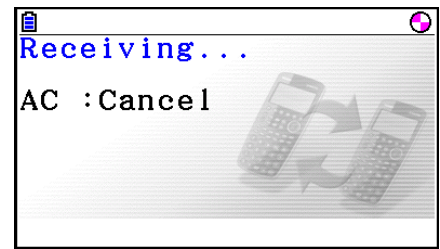

The calculator enters a data receive standby mode and waits for data to arrive. Actual data receive starts as soon as data is sent from the sending calculator.

### Sending calculator

To set up the calculator to send data, press **F1** (TRANSMIT) while the data communication main menu is displayed.

This displays a screen for specifying the data selection method.

- **{SELECT}** ... {selects new data}
- **{CURRENT}** ... {automatically selects previously selected data\*<sup>1</sup>}

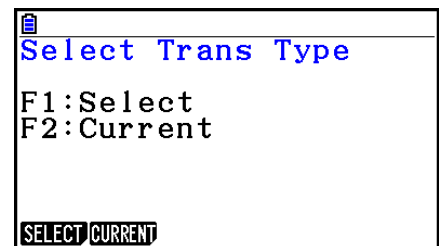

\*<sup>1</sup> The previously selected data memory is cleared whenever you change to another mode.

### • To send selected data items (Example: To send user data)

Press **F1** (SELECT) or **F2** (CURRENT) to display a data item selection screen.

- **{SELECT}** ... {selects data item where cursor is located}
- **{ALL}** ... {selects all data}
- **{TRANSMIT}** ... {sends selected data items}

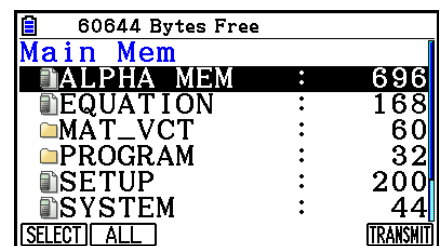

Use the **▲** and **▼** cursor keys to move the cursor to the data item you want to select and press **F1** (SELECT) to select it. Currently selected data items are marked with "▶". Pressing **F6** (TRANSMIT) sends all the selected data items.

- To deselect a data item, move the cursor to it and press **F1** (SELECT) again.

## • To execute a send operation

After selecting the data items to send, press **[F6]** (TRANSMIT). A message appears to confirm that you want to execute the send operation.

- **[F1]** (Yes) ... sends data
- **[F6]** (No) ... returns to data selection screen

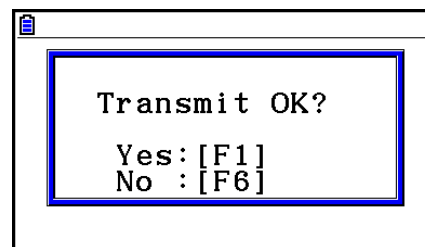

Press **[F1]** (Yes) to send the data.

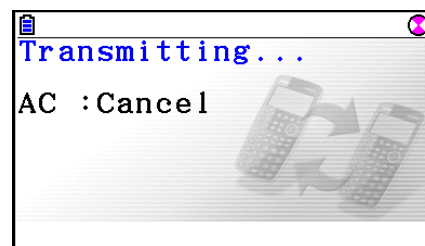

- You can interrupt a data operation at any time by pressing **[AC]**.

The following shows what the displays of the sending and receiving calculator look like after the data communication operation is complete.

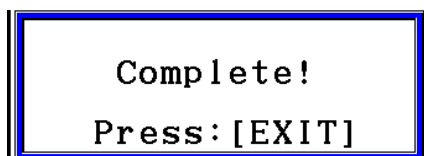

Press **[EXIT]** to return to the data communication main menu.

For information about the types of data items that can be sent, see "Main Memory" (pages 11-3 and 11-4). The following explains the meanings of the "Yes" and "No" indications in the "Overwrite Check" column on those pages.

**Yes:** Overwrite check is performed. If the receiving calculator already contains the same type of data, the message below appears to ask if the existing data should be overwritten with the new data.

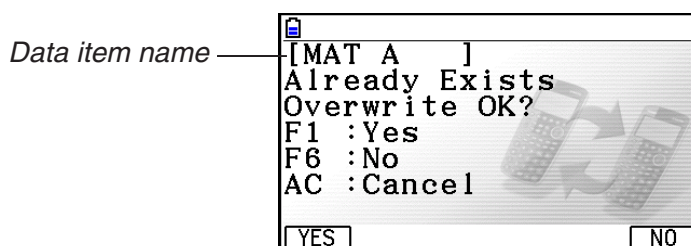

Press **F1** (Yes) to replace the receiving calculator's existing data with the new data, or **F6** (No) to skip to next data item.

**No:** Overwrite check is not performed. If the receiving calculator already contains the same type of data, the existing data is overwritten with the new data.

---

## ■ Data Communication Precautions

Note the following precautions whenever you perform data communication.

- An error occurs whenever you try to send data to a receiving calculator that is not yet standing by to receive data. When this happens, press **EXIT** to clear the error and try again, after setting up the receiving calculator to receive data.
- An error occurs whenever the receiving calculator does not receive any data approximately six minutes after it is set up to receive data. When this happens, press **EXIT** to clear the error.
- An error occurs during data communication if the cable becomes disconnected, if the parameters of the two calculators do not match, or if any other communication problem occurs. When this happens, press **EXIT** to clear the error, then correct the problem before trying data communication again. If data communication is interrupted by the **EXIT** key operation or an error, any data successfully received up to the interruption will be in the memory of the receiving calculator.
- An error occurs if the receiving calculator memory becomes full during data communication. When this happens, press **EXIT** to clear the error and delete unneeded data from the receiving calculator to make room for the new data, and then try again.
- When sending data from the fx-CG10/fx-CG20/fx-CG20 AU to an older model calculator, folders in storage memory are not sent. In this case, send individual files (not folders).

---

## ■ Exchanging Data with another Model Calculator

Though it is possible to exchange data between this calculator (fx-CG10/fx-CG20/fx-CG20 AU) and the other CASIO calculator models listed under "To connect two calculators" (page 13-10), there are certain restrictions that apply when exchanging data with an older model calculator.

---

### • Transferring Data from this Calculator to an Older Calculator Model

Basically, only data for functions that are available on both this calculator (fx-CG10/fx-CG20/fx-CG20 AU) and the older model can be transferred.

Data for a function that is available on this calculator but not on the older model cannot be transferred. Transferring **Graph** mode graph expression data (Y=DATA) from this calculator to the fx-9860GII, for example, will cause color information to be dropped automatically, because the fx-9860GII does not support color.

The following table shows how each type of data is handled when transferring from this calculator (fx-CG10/fx-CG20/fx-CG20 AU) to an older model CASIO calculator.

| Data Item          | *1       | fx-9750GII | fx-7400GII | CFX-9850G |
|--------------------|----------|------------|------------|-----------|
| ALPHAMEM           | ⊙        | ⊙          | ⊙          | ⊙         |
| CONICS             | *2       | *2         | ×          | *2        |
| DYNA               | ×        | ×          | ×          | ×         |
| E-CON3             | *8       | *8         | ×          | ×         |
| EQUATION           | ⊙        | ⊙          | ⊙          | ⊙         |
| FMEM               | ⊙        | ⊙          | ⊙          | ⊙         |
| @GEOM              | ×        | ×          | ×          | ×         |
| GMEM               | *2 *3    | *2 *3      | *2 *3      | *2 *3     |
| LIST <i>n</i>      | *2       | *2         | *2         | *2        |
| LIST FILE <i>n</i> | *2       | *2         | *2         | *2        |
| MAT <i>n</i>       | ⊙        | ⊙          | ⊙          | ⊙         |
| VCT <i>n</i>       | ×        | ×          | ×          | ×         |
| @PICTPLT           | ×        | ×          | ×          | ×         |
| PROGRAM            | *4       | *4         | *4         | *4        |
| RECUR              | *2       | *2         | *2         | *2        |
| SETUP              | *5       | *5         | *5         | *5        |
| SSHEET             | *2 *6    | ×          | ×          | ×         |
| STAT               | *2       | *2         | *2         | *2        |
| STRING <i>n</i>    | ⊙        | ⊙          | ⊙          | ×         |
| SYSTEM             | ×        | ×          | ×          | ×         |
| TABLE              | ⊙        | ⊙          | ⊙          | ⊙         |
| FINANCE            | *2       | *2         | *2         | *2        |
| VMEM               | *7       | *7         | *7         | *7        |
| Y=DATA             | *2 *3 *7 | *2 *3 *7   | *2 *3 *7   | *2 *3 *7  |

⊙: Sent as-is    ×: Not sent

\*1 fx-9860GII SD (OS 2.0), fx-9860GII (OS 2.0), fx-9860G AU PLUS (OS 2.0), fx-9860G Slim (OS 1.11), fx-9860G SD (OS 2.0), fx-9860G (OS 2.0), fx-9860G AU (OS 2.0)

\*2 Color data not sent.

\*3 “Thin” line style changed to “Normal”.

\*4 Program contents are sent as-is, without conversion.

The pixel values in the arguments of Text, PxlOn, PxlOff, Pxlchg, and PxlTest( commands are transferred as-is. Because of this, executing a program that includes these commands on an older calculator model will result in incorrect display or a Syntax ERROR.

\*5 When a Setup item is configured to settings supported by this calculator (fx-CG10/fx-CG20/fx-CG20 AU) but not supported by the receiving calculator, the receiving calculator’s setting is set to its default value. If “Thin” is selected for the fx-CG10/fx-CG20/fx-CG20 AU “Sketch Line” Setup item, for example, the setting will be changed to “Normal” on the receiving calculator. Setup items that are supported by this calculator (fx-CG10/fx-CG20/fx-CG20 AU) but not by the receiving calculator are not transferred.

\*6 Conditional formatting data is not sent.

\*7 The V-Window dot value is recalculated in accordance with the number of screen dots of the receiving calculator.

\*8 Data can be used by calculator with E-CON3 equipped. Data can be transferred to a calculator with E-CON2 equipped, but the data cannot be used.

## • Transferring Data from an Older Calculator Model to this Calculator

Almost all data produced by an older model CASIO calculator can be transferred to this calculator (fx-CG10/fx-CG20/fx-CG20 AU).

- Some data may be converted in order to make it compatible with this calculator's specifications. Transferring **Graph** mode graph expression data (Y=DATA) from the fx-9860GII to this calculator, for example, will cause the V-Window dot value to be corrected because the displays of the two models have different numbers of dots.
- In some cases, color data may be appended to data and other adjustments may be performed automatically. In this case, the adjustments use initial default values. Transferring **Graph** mode graph expression data (Y=DATA) from the fx-9860GII to this calculator, for example, the default color (blue) is applied for the graph color.
- Even if Wakeup is turned on (page 13-1), the Wakeup function is disabled.

The following table shows how each type of data is handled when transferring from an older model CASIO calculator to this calculator (fx-CG10/fx-CG20/fx-CG20 AU).

| Data Item                                                                                                                                    | Description                                                                                                                                                                                                                                                                                                        |
|----------------------------------------------------------------------------------------------------------------------------------------------|--------------------------------------------------------------------------------------------------------------------------------------------------------------------------------------------------------------------------------------------------------------------------------------------------------------------|
| ALPHAMEM, CONICS, DYNA, EQUATION, FMEM, Geometry, LIST <i>n</i> , LIST FILE <i>n</i> , MAT <i>n</i> , RECUR, SSHEET, STRING <i>n</i> , TABLE | Data is transferred as-is.                                                                                                                                                                                                                                                                                         |
| CAPT <i>n</i> , PICT <i>n</i> , SYSTEM                                                                                                       | Not sent.                                                                                                                                                                                                                                                                                                          |
| E-CON3, SETUP, STAT, FINANCE                                                                                                                 | Original data is transferred as-is. However, Setup items that are supported by this calculator (fx-CG10/fx-CG20/fx-CG20 AU) but not by the sending calculator will be set to their initial default values.                                                                                                         |
| GMEM                                                                                                                                         | Original data is transferred as-is. However, the default color is assigned to expressions.                                                                                                                                                                                                                         |
| Program                                                                                                                                      | <ul style="list-style-type: none"> <li>• Pixel values specified by the Text command argument are converted to match this calculator's screen size.</li> <li>• Pixel values specified by the PxlOn, PxlOff, Pxlchg, PxlTest( command arguments are not converted to match this calculator's screen size.</li> </ul> |
| VMEM, Y=DATA                                                                                                                                 | Original data is transferred as-is. However, the dot value is recalculated in accordance with the number of dots for this calculator's (fx-CG10/fx-CG20/fx-CG20 AU) display.                                                                                                                                       |



## 3. Connecting the Calculator to a Projector

You can connect the calculator to a CASIO projector and project calculator screen contents onto a screen.

---

### ■ Connectable Projectors

For information about connectable projectors, visit the site below.

<http://edu.casio.com/support/projector/>

---

#### • To project calculator screen contents from a projector

1. Use the USB cable that comes with the calculator to connect to the projector.
  - Connecting the USB cable to the calculator will cause the “Select Connection Mode” dialog box to appear.
2. Press **F4** (Projector).

---

### ■ Precautions when Connecting

- The  icon may remain projected on the screen after you connect the calculator to a projector. If this happens, performing some operation on the calculator will restore normal display.
- If the calculator stops operating normally, disconnect the USB cable and then reconnect it. If this does not correct the problem, disconnect the USB cable, turn the projector off and then back on, and then reconnect the USB cable.
- Connecting the calculator to a projector with the USB cable immediately after starting up the projector may cause the projected image to appear in grayscale and not in color. If this happens, disconnect and then reconnect the USB cable.

# Chapter 14 Geometry

## 1. Geometry Mode Overview

The **Geometry** mode allows you to draw and analyze geometric objects.

From the Main Menu, enter the **Geometry** mode.

### ■ Geometry Mode Menus

Unlike other modes, the **Geometry** mode does not have function menus along the bottom of the screen. Instead, it uses menus named [F1] through [F6] and [OPTN], like the ones shown below.

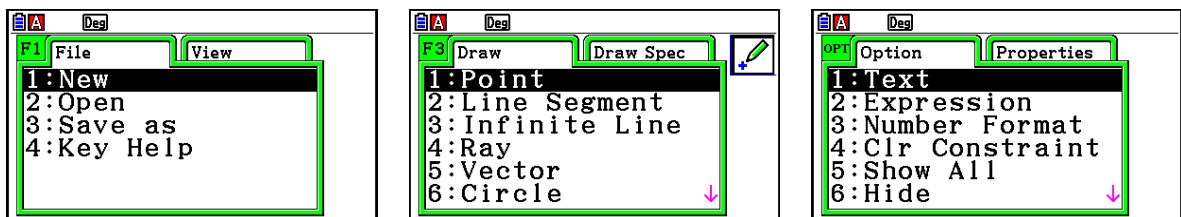

The following is a general explanation of **Geometry** mode menus.

- Pressing a key that corresponds to a menu ([F1] through [F6] or [OPTN]) will display the menu for that tab.
- After displaying a menu, use  $\blacktriangleright$  and  $\blacktriangleleft$  to move between menu screens.
- To close a menu without selecting anything, press [EXIT].

### ● Menu Operations in This Chapter

Menu operations are shown using the following form in this chapter: [F3](Draw) – 5:Vector. When you see this, it means you can perform either of the following two operations.

- Press [F3] to display the Draw menu, use  $\blacktriangledown$  and  $\blacktriangleup$  to highlight “5:Vector”, and then press [EXE].
- Press [F3] to display the Draw menu and then press [5].

---

## ■ Menu Reference

The following tables describe the menu items that appear on each of the **Geometry** mode menus.

---

### ● **F1** (File)

| To do this:                                      | Select this menu item: |
|--------------------------------------------------|------------------------|
| Create a new file                                | 1:New                  |
| Open a file                                      | 2:Open                 |
| Save a file under a new name                     | 3:Save as              |
| Display a list of functions assigned to each key | 4:Key Help             |

---

### ● **F1** (View)

| To do this:                                                  | Select this menu item: |
|--------------------------------------------------------------|------------------------|
| Start a box zoom operation                                   | 1:Zoom Box             |
| Enter the pan mode (page 14-35)                              | 2:Pan                  |
| Enter the scroll mode (page 14-36)                           | 3:Scroll               |
| Enlarge the display image                                    | 4:Zoom In              |
| Reduce the size of the display image                         | 5:Zoom Out             |
| Adjust the size of the display image so it fills the display | 6:Zoom to Fit          |

---

### ● **F2** (Edit)

| To do this:                           | Select this menu item: |
|---------------------------------------|------------------------|
| Undo or redo the last operation       | 1:Undo/Redo            |
| Select all objects on the screen      | 2:Select All           |
| Deselect all objects on the screen    | 3:Deselect All         |
| Select an entire polygon (page 14-19) | 4:Select Figure        |
| Delete the currently selected object  | 5>Delete               |
| Clear the screen                      | 6:Clear All            |

• **F3 (Draw)**

| To do this:          | Select this menu item: |
|----------------------|------------------------|
| Plot a point         | 1:Point                |
| Draw a line segment  | 2:Line Segment         |
| Draw a straight line | 3:Infinite Line        |
| Draw a ray           | 4:Ray                  |
| Draw a vector        | 5:Vector               |
| Draw a circle        | 6:Circle               |
| Draw an arc          | 7:Arc                  |
| Draw a semi circle   | 8:SemiCirc (Diam)      |

• **F3 (Draw Spec)**

| To do this:                | Select this menu item: |
|----------------------------|------------------------|
| Draw a triangle            | 1:Triangle             |
| Draw an isosceles triangle | 2:Isosc Triangle       |
| Draw a rectangle           | 3:Rectangle            |
| Draw a square              | 4:Square               |
| Draw a polygon             | 5:Polygon              |
| Draw a regular n-gon       | 6:Regular n-gon        |
| Draw a function graph      | 7:Function f(x)        |

• **F4 (Construct)**

| To do this:                             | Select this menu item: |
|-----------------------------------------|------------------------|
| Construct a perpendicular bisector      | 1:Perp Bisector        |
| Construct a perpendicular               | 2:Perpendicular        |
| Construct a midpoint                    | 3:Midpoint             |
| Construct an intersection               | 4:Intersection         |
| Construct an angle bisector             | 5:Angle Bisector       |
| Construct a parallel                    | 6:Parallel             |
| Construct a tangent                     | 7:Tangent              |
| Attach an angle measurement to a figure | 8:Attached Angle       |

• **F5 (Transform)**

| To do this:                                       | Select this menu item: |
|---------------------------------------------------|------------------------|
| Reflect an object                                 | 1:Reflection           |
| Translate an object by specified values           | 2:Translation          |
| Translate an object using an existing vector      | 3:Trans(Sel Vec)       |
| Rotate an object                                  | 4:Rotation             |
| Dilate an object                                  | 5:Dilation             |
| Rotate an object 180 degrees on a specified point | 6:Symmetry             |

• **F6 (Animate)**

| To do this:                                                                                     | Select this menu item: |
|-------------------------------------------------------------------------------------------------|------------------------|
| Add animation to two selected objects                                                           | 1:Add Animation        |
| Replace the current animation assigned to two selected objects                                  | 2:Replace Anima        |
| Turn on trace for a point and trace the movement of the point while animation is being executed | 3:Trace                |
| Display the animation editing screen                                                            | 4:Edit Animation       |
| Perform an animation sequence once                                                              | 5:Go (once)            |
| Perform an animation sequence repeatedly                                                        | 6:Go (repeat)          |
| Add one or more values to the animation table (page 14-62)                                      | 7:Add Table            |
| Display the animation table                                                                     | 8:Display Table        |

• **OPTN (Option)**

| To do this:                                                                                                | Select this menu item: |
|------------------------------------------------------------------------------------------------------------|------------------------|
| Input text                                                                                                 | 1:Text                 |
| Input an expression                                                                                        | 2:Expression           |
| Specify the number format <b>Geometry</b> mode measurements                                                | 3:Number Format        |
| Unlock all measurements                                                                                    | 4:Clr Constraint       |
| Display all objects                                                                                        | 5:Show All             |
| Hide the currently selected object                                                                         | 6:Hide                 |
| Perform an arithmetic operation or another type of operation using the surface area of one or more figure. | 7:Area Calc            |

• **OPTN (Option) ► (Properties)**

| To do this:                                                      | Select this menu item: |
|------------------------------------------------------------------|------------------------|
| Move the selected object to the front                            | 1:to the front         |
| Move the selected object to the back                             | 2:to the back          |
| Move all text to the front                                       | 3:All TEXT             |
| Adjust the lightness of the background image                     | 4:Fade I/O             |
| Save <b>Geometry</b> mode screen contents as an image (g3p File) | 5:Store Picture        |

■ **Using the Pointer**

You can use the following operations to move the on-screen pointer (👉) around the display when drawing objects, editing objects, etc.

• **To move the pointer**

Use the cursor keys to move the pointer around the display. Holding down a cursor key moves the pointer at high speed.

• **To make the pointer jump to a particular location**

Pressing a number key (1 to 9) will cause the pointer to jump to the corresponding section of the screen as shown below.

|   |   |   |
|---|---|---|
| 7 | 8 | 9 |
| 4 | 5 | 6 |
| 1 | 2 | 3 |

■ **Using Key Help**

Pressing **F1** (File) – 4:Key Help or the **0** key will display Key Help, which provides information the function of each key in the **Geometry** mode.

Use the **▼** and **▲** keys to navigate between the three Key Help screens.

To exit the Key Help screens, press **EXIT**.

**Note**

The key operations shown on the Key Help screens apply to the drawing screen only.

---

## ■ Managing Geometry Mode Files

This section explains how to save **Geometry** mode data to files, and how to manage your files.

---

### • To create a new file

1. Perform the following operation: **[F1]**(File) – 1:New.

- The following dialog box will appear if you have a drawing on the screen.

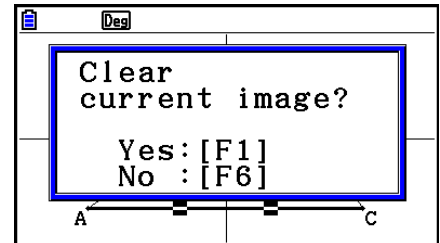

2. To clear the current drawing and create a new file, press **[F1]**(Yes).

- This will create a new file and display a blank drawing screen.
- 

### • To open an existing file

1. Perform the following operation: **[F1]**(File) – 2:Open.

- This displays a menu of existing files.
- Pressing **[F6]**(STRGMEM) here will display the storage memory file list where you can open a g3p file. For details, see “Displaying a **Geometry** Mode Screen Background Image” (page 14-8).

2. Use **[↓]** and **[↑]** to move the highlighting to the file you want to open and then press **[EXE]**.

- The following dialog box will appear if you have a drawing on the screen.

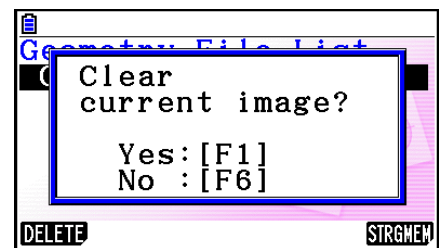

3. To clear the current drawing, press **[F1]**(Yes).

- This will open the file you selected in step 2.

---

## • To delete a file

1. Perform the following operation: **F1** (File) – 2:Open.
  - This displays a menu of existing files.
2. Use **▼** and **▲** to move the highlighting to the file you want to delete and then press **F1** (DELETE).
  - This causes a confirmation dialog box to appear.
3. Press **F1** (Yes) to delete the selected file or **F6** (No) to cancel the delete operation.
4. To exit the file menu, press **EXIT**.

---

## • To save a file under a different name

1. While the file you want to save is open, perform the following operation: **F1** (File) – 3:Save as.
  - This will display the file name input screen and automatically switch the calculator's keys to Alpha Lock.

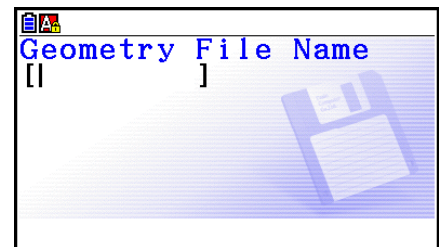

2. Input up to 8 characters for the file name and then press **EXE**.
  - You can use the following characters in a file name.
    - Uppercase alphabetic characters A through Z
    - Numerals 0 through 9
    - Braces ( { }
  - After inputting the name you want, press **EXE** to save the file and return to its drawing screen.



---

## ■ Displaying a Geometry Mode Screen Background Image

In the **Geometry** mode, you can open an image file (g3p) and use it as a background image for a **Geometry** mode drawing.

- If you open a g3p file, draw something, and then save the result to a file, the g3p file will be saved along with the **Geometry** mode data.
- After opening a background image, you adjust its lightness on the display. See “Adjusting the Lightness of the Background Image” (page 14-37).
- Once you add a background image and save it, you will not be able to change the background image of the file or remove it.

---

### ● To open a g3p file in the Geometry mode

1. Perform the following operation: **[F1]**(File) – 2:Open.
2. Press **[F6]**(STRGMEM).
  - This displays the storage memory file list screen.
3. Use **▼** and **▲** to move the highlighting to the background image file you want to use and then press **[EXE]**.
  - If a drawing is currently on the screen, the “Clear current image?” confirmation dialog box will appear.
4. To clear the current drawing, press **[F1]**(Yes).
  - If the file does not contain any **Geometry** mode data, a dialog box will appear at this point asking if you want to use the Geometry V-Window initial default value. To open the file using the Geometry V-Window initial default value, press **[F1]**. To cancel the open file operation, press **[F6]**.
  - If the file already contains **Geometry** mode data, the file will open immediately.

---

## ■ Saving Current Screen Contents as an Image (g3p File) in the Geometry Mode

You can save a **Geometry** mode screen shot as an image (g3p) file. The saved file includes current V-Window setting information.

---

### ● To save current screen contents as an image in picture memory

1. While the screen you want to save is displayed, perform the following operation:  
[OPTN] (Option) [▶] (Properties) – 5:Store Picture [EXE] (Pict [1~20]).
  2. On the Store In Picture Memory screen that appears, enter a value from 1 to 20 and then press [EXE].
    - Storing a graphic image in a memory area that already contains a graphic image replaces the existing graphic image with the new one.
- 

### ● To save current screen contents under a file name

1. While the screen you want to save is displayed, perform the following operation:  
[OPTN] (Option) [▶] (Properties) – 5:Store Picture [▼] [EXE] (Save As).
2. Perform the procedure starting from step 2 under “To store a graph screen image under a file name” (page 5-21).

## Key Functions

The figure below shows the keys that are used for **Geometry** mode drawing screen operations.

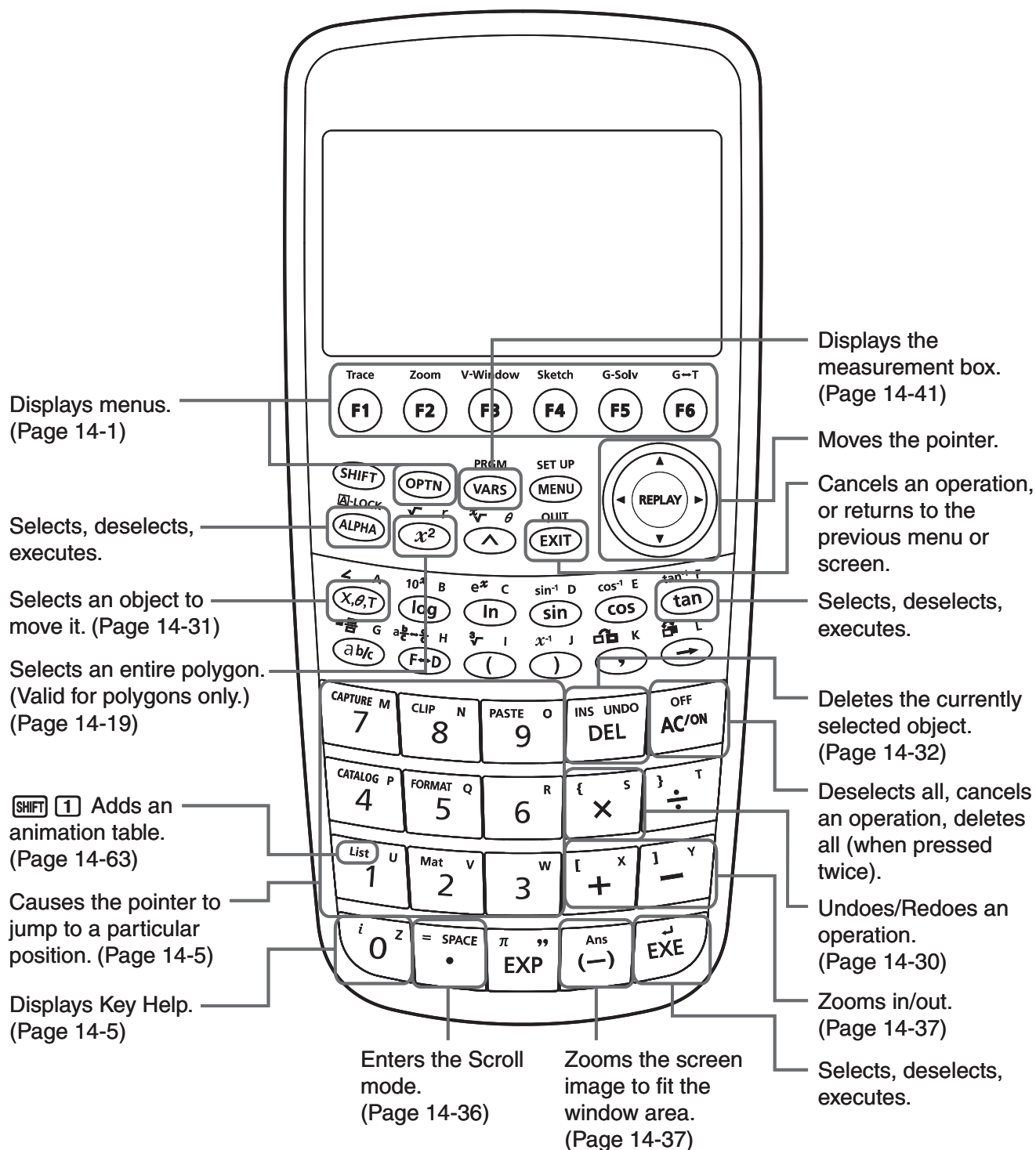

## 2. Drawing and Editing Objects

This section explains how to perform the following operations.

- Plot points, draw line segments, polygons, etc. ([F3](Draw) menu, [F3] [▷](Draw Spec) menu)
- Select and deselect objects ([F2](Edit) menu)
- For a drawn object, construct a perpendicular bisector, perpendicular, etc. ([F4](Construct) menu)
- For a drawn object, perform various transform operations ([F5](Transform) menu)
- Undo an operation, move an object, delete an object and other editing operations ([F2](Edit) menu)

---

### ■ Using the Draw Menu

Press [F3](Draw) to display the Draw menu. You can use the Draw menu to plot points, and draw line segments, triangles, polygons, and other objects.

---

#### • To plot a point

1. Perform the following operation: [F3](Draw) – 1:Point.
2. Move the pointer to the location on the screen where you want to plot a point and then press [EXE].
  - This will plot a point at the pointer location.

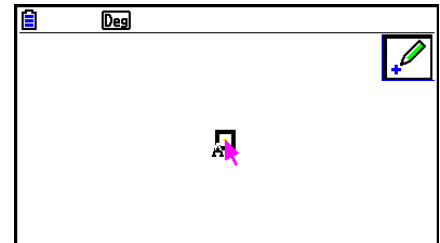

- The  icon will remain on the display, which means you repeat step 2 to plot more points, if you want.
3. After you are finished plotting all the points you want, press [AC/ON] or [EXIT] to deselect the Point tool.

#### **Note**

Some drawing tools remain after you draw something, like the Point tool. To deselect such a tool, press [AC/ON] or [EXIT].

---

## • To add a labeled point to an existing line

### Note

You can use the following procedure to add a labeled point to an existing line, to a side of a polygon, to the periphery of a circle, etc.

1. Perform the following operation: **[F3]** (Draw) – 1:Point.
2. Move the pointer on the screen towards the line where you want to add the labeled point.
  - This selects the line, which is indicated by “□”.

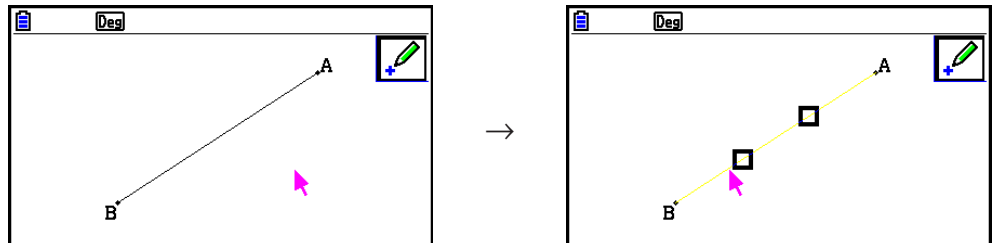

3. Press **[EXE]**.
  - This will add a point on the line at the pointer location.

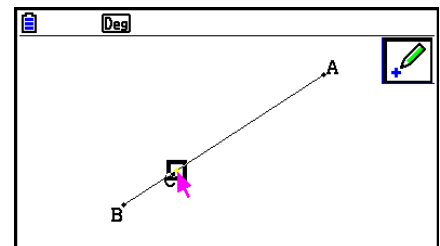

---

## • To draw a line segment

1. Perform the following operation: **[F3]** (Draw) – 2:Line Segment.
2. Move the pointer to the location on the display from where you want to draw the line segment and then press **[EXE]**.
3. Move the pointer to the location on the display to where you want to draw the line segment and then press **[EXE]**.
  - This will draw a line segment between the two points.

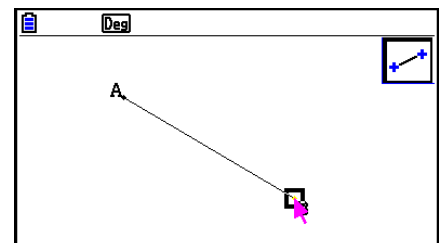

### Note

In steps 2 and 3 of the above procedure, you can move the pointer to an existing point on the screen and press **[EXE]**. This will make the existing point one of the ends of the line segment.

---

### • To draw an infinite line

1. Perform the following operation: **F3** (Draw) – 3:Infinite Line.
2. Move the pointer to any location on the display and then press **EXE**.
3. Move the pointer to another location on the display and then press **EXE**.
  - This will draw a line that passes between the two points.

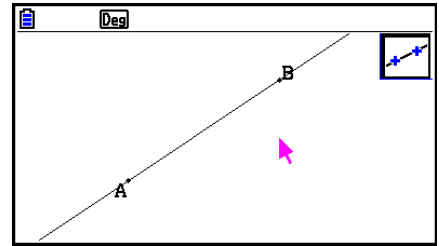

---

### • To draw a ray

1. Perform the following operation: **F3** (Draw) – 4:Ray.
2. Move the pointer to any location on the display and then press **EXE**.
3. Move the pointer to another location on the display and then press **EXE**.
  - This will draw a ray that starts from the first point you selected and that passes through the second point.

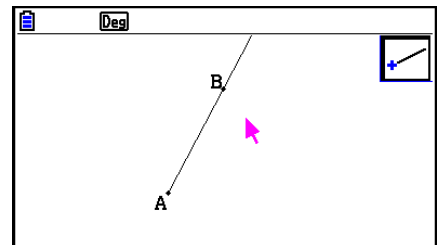

---

### • To draw a vector

1. Perform the following operation: **F3** (Draw) – 5:Vector.
2. Move the pointer to the location on the display from where you want to draw the vector and then press **EXE**.
3. Move the pointer to the location on the display to where you want to draw the vector and then press **EXE**.
  - This draws the vector.

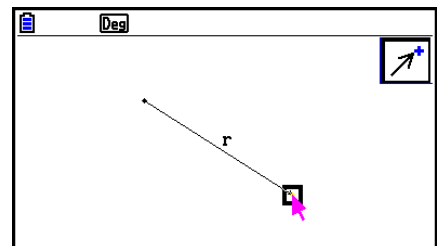

---

### • To draw a circle

1. Perform the following operation: **F3** (Draw) – 6:Circle.
2. Move the pointer to the location on the display where you want the center point of the circle to be and then press **EXE**.
3. Move the pointer to the location on the display where you want the circumference of the circle to be and then press **EXE**.
  - This draws a circle. The distance between the two points you specify is the radius of the circle.

### Note

In steps 2 and 3 of the above procedure, you can move the pointer to an existing point on the screen and press **EXE**. This will make the existing point either the center point or the circumference point.

---

### • To draw an arc

1. Perform the following operation: **F3** (Draw) – 7:Arc.
2. Move the pointer to the location on the display where you want the center point of the arc to be and then press **EXE**.
3. Move the pointer to the location on the display where you want the start point of the arc to be and then press **EXE**.
4. Move the pointer to the location where you want the end point of the arc to be.

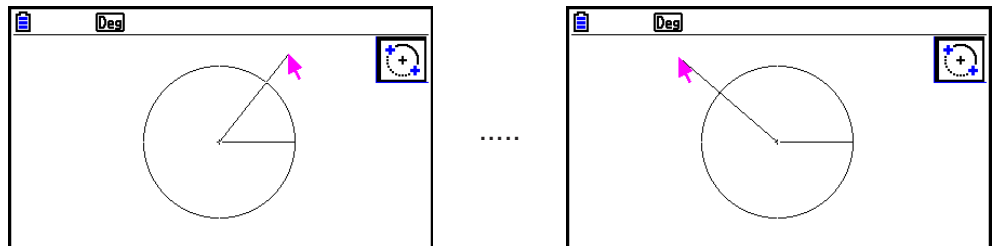

5. Move the pointer and the line segment to the location on the display where you want the end point of the arc to be and then press **EXE**.

- An arc will be drawn from the start point to the end point, in a counterclockwise direction.

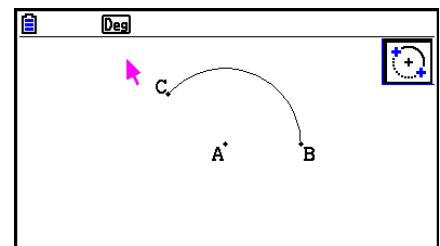

---

### • To draw a semi circle

1. Perform the following operation: **F3** (Draw) – 8:SemiCirc (Diam).
2. Move the pointer to the point you want to specify as one end of the semi circle diameter and then press **EXE**.
3. Move the pointer to the point you want to specify as the other end of the semi circle diameter.

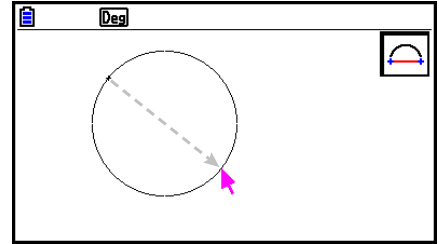

- In accordance with the pointer movement, a circle whose diameter passes through the first point and the current point will appear on the display. Pressing **EXE** in the following step will draw a semi circle with a diameter that forms an arc that goes counterclockwise from the first point you specified to the second point.

4. Press **EXE** to draw the semi circle.

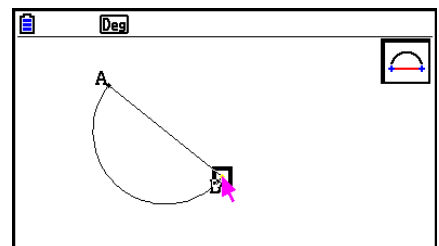

---

### • To draw a triangle

1. Perform the following operation: **F3** (Draw Spec) – 1:Triangle.
2. Move the pointer to any location on the display and then press **EXE**.
3. Move the pointer to another location.
  - This causes a selection boundary to appear, indicating the size of the triangle that will be drawn.



4. Press **EXE**.

- This draws a triangle.

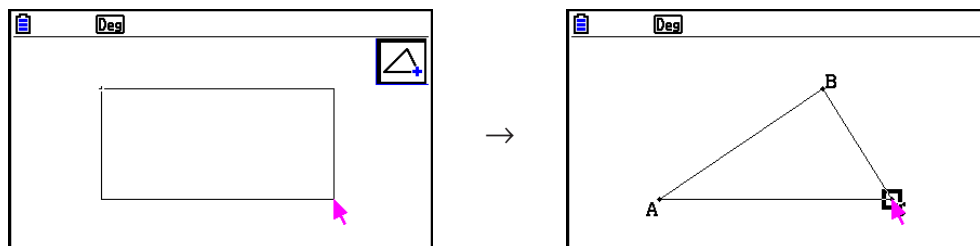

- If the location of the pointer when you press **EXE** is very close to the point you specified in step 2, the triangle that is drawn will be the maximum size that fits in the screen.

### **Note**

The same type of two-point selection boundary in the above procedure is also used when drawing an isosceles triangle, rectangle, square, or regular n-gon.

In each case, the resulting object will be the maximum size that fits in the screen if the second point specified is too close to or at the same location of the first point.

---

### • To draw an isosceles triangle

1. Perform the following operation: **F3** **▶** (Draw Spec) – 2:Isosc Triangle.
2. Perform steps 2 through 4 under “To draw a triangle” (page 14-15).

- This draws an isosceles triangle.

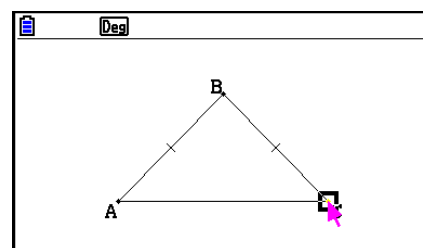

---

### • To draw a rectangle or a square

1. Perform either of the following operations: **F3** **▶** (Draw Spec) – 3:Rectangle or **F3** **▶** (Draw Spec) – 4:Square.
2. Move the pointer to any location on the display and then press **EXE**.
3. Move the pointer to another location.

- This causes a selection boundary to appear, indicating the size of the rectangle (or square) that will be drawn.

4. Press **EXE**.

- This draws a rectangle or square.

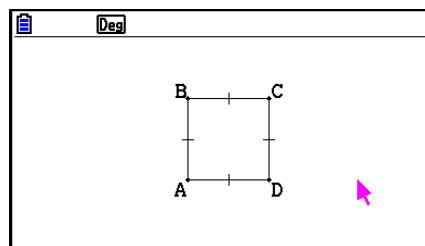
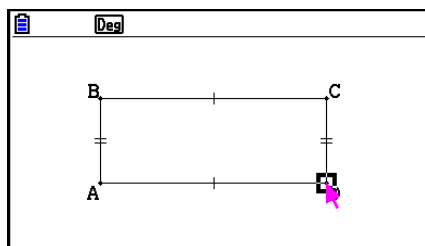

- If the location of the pointer when you press **EXE** is very close to the point you specified in step 2, the object that is drawn will be the maximum size that fits in the screen.

### Note

In the case of a square, each side will be the length of the shorter side of the rectangle you specify with the selection boundary in step 3.

---

### • To draw a polygon

1. Perform the following operation: **F3** (Draw Spec) – 5:Polygon.
2. Move the pointer to the location on the display where you want a vertex of the polygon to be and then press **EXE**.
  - Repeat this step as many times as required to specify the other vertices of the polygon.
3. To complete the polygon, move the pointer to the location of the first vertex and then press **EXE**.

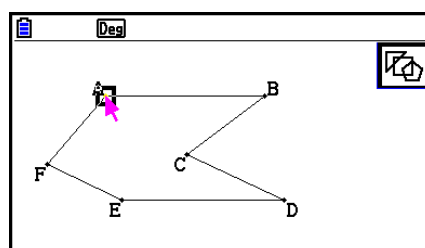
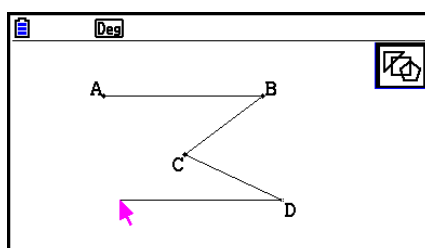

### Note

If you press **EXIT** in place of step 3, the figure will be finalized as-is, resulting in an unclosed non-polygon.

---

### • To draw a regular n-gon

1. Perform the following operation: **F3**  (Draw Spec) – 6:Regular n-gon.
  - This displays a dialog box prompting you to specify the number of sides.
2. Input a value from 3 to 12 and then press **EXE**.
3. Perform steps 2 through 4 under “To draw a triangle” (page 14-15).
  - This will draw a regular n-gon using the number of sides you specified in step 2.

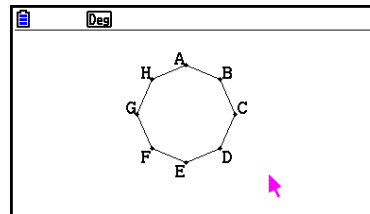
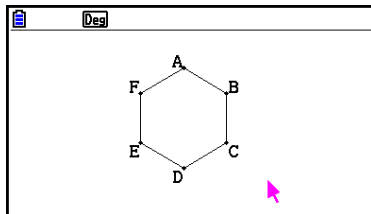
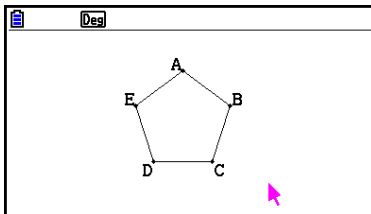

---

### • To draw a function

1. Perform the following operation: **F3**  (Draw Spec) – 7:Function f(x).
  - This causes the Function dialog box to appear.
2. Input the function.
3. Press **EXE** to draw it.

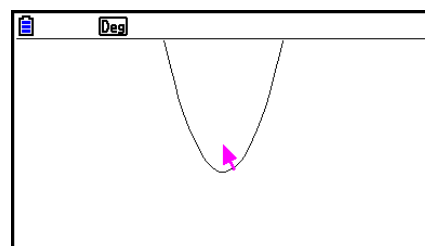
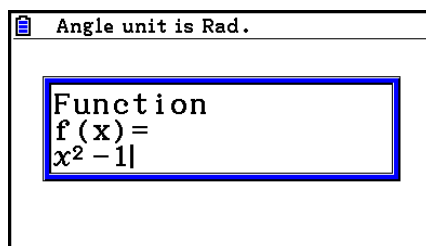

### **Note**

- The only graph type that can be drawn is  $Y=f(x)$ .
- The angle unit of the graph that is drawn is always Rad, regardless of the Angle setting on the Setup screen.





---

## ■ Selecting and Deselecting Objects

Before you can edit (move or delete) an object or create a figure using an object, you first need to select part of it or all of it. This section explains how to select and deselect objects.

---

### • To select a particular object

1. If any tool icon is in the upper right corner of the screen, press **[EXIT]** or **[AC/ON]** to deselect the tool.
2. Move the pointer close to the object you want to select.
  - This will cause one or more  marks to appear on the object. At this time the object will begin to flash. Note that the object will not flash if it is a point and a  mark is displayed on the point.
3. Press **[EXE]**.
  - This will cause the  to change to  and will change the outline of the object to become a thick line, which indicates that the object is selected.

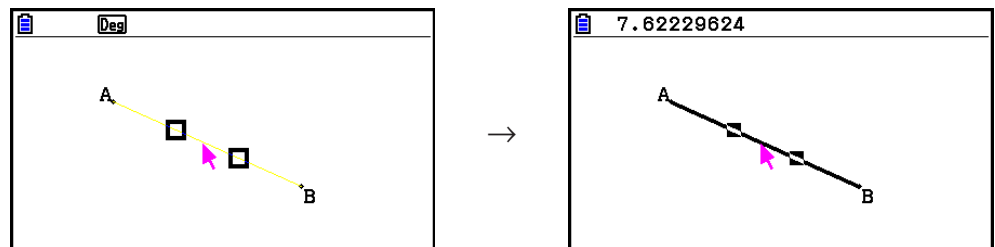

- Now you can repeat steps 2 and 3 to select other objects, if you want.
- 

### • To select an entire polygon

1. If any tool icon is in the upper right corner of the screen, press **[EXIT]** or **[AC/ON]** to deselect the tool.
2. Move the pointer close to the object you want to select.
  - This will cause  marks to appear on some part (vertex, side, etc.) of the object.

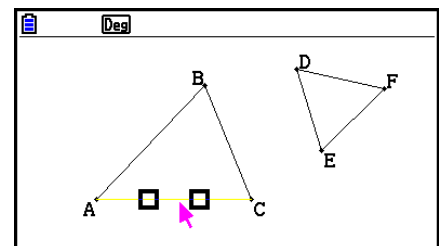

3. Press  $\boxed{x^2}$  or perform the following operation:  $\boxed{F2}$  (Edit) – 4:Select Figure.

- This selects the entire object.

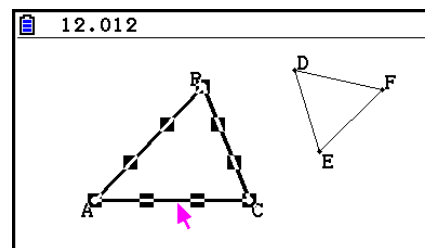

---

• **To deselect a particular object**

1. If any tool icon is in the upper right corner of the screen, press  $\boxed{EXIT}$  or  $\boxed{AC/ON}$  to deselect the tool.
2. Move the pointer close to the object you want to deselect.
  - This will cause the ■ marks to become highlighted. At this time the object will begin to flash. Note that the object will not flash if it is a point and a ■ mark is displayed on the point.

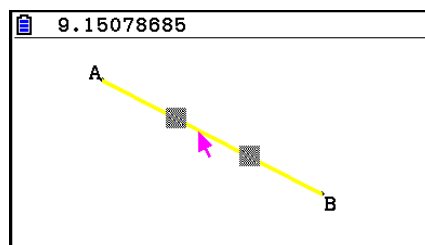
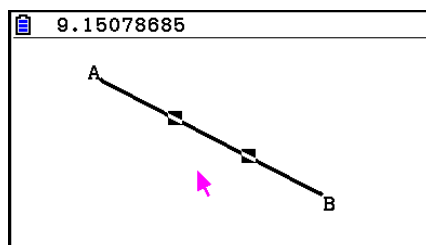

3. Press  $\boxed{EXE}$ .

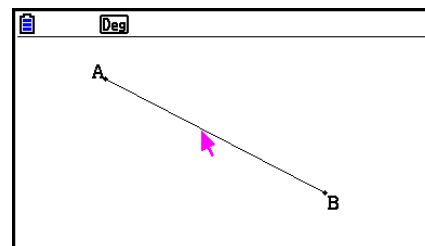

- This will deselect the object, which causes the ■ mark(s) to disappear.

---

• **To select all objects on the screen**

Perform the following operation:  $\boxed{F2}$  (Edit) – 2:Select All.

---

• **To deselect all objects on the screen**

Press  $\boxed{AC/ON}$  or perform the following operation:  $\boxed{F2}$  (Edit) – 3:Deselect All.

## ■ Specifying the Color and Line Type of a Displayed Object

You can use the procedure below to specify the color and line type for the outline of a displayed figure, the fill color inside a figure, or the color of text, labels, and other non-figure objects.

### • To specify the color and line type of all the displayed objects

1. Perform the following operation: **[F2]** (Edit) – 2:Select All.
2. Press **[SHIFT]** **[5]** (FORMAT) to display the dialog box shown below.

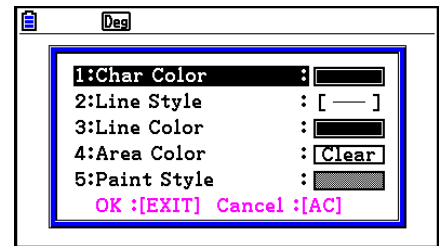

- The dialog box will show only supported settings, which depend on the composition of the selected object.

3. Configure the above dialog box with the following settings.

| To specify this:                               | Perform this operation:                                                                                                                                             |
|------------------------------------------------|---------------------------------------------------------------------------------------------------------------------------------------------------------------------|
| Specify the text color                         | Press <b>[1]</b> (Char Color) and then use keys <b>[1]</b> through <b>[8]</b> to specify the desired color.                                                         |
| Specify the line type                          | Press <b>[2]</b> (Line Style) and then press one of the following keys: <b>[1]</b> (Norm), <b>[2]</b> (Thick), <b>[5]</b> (Thin).                                   |
| Specify the line color                         | Press <b>[3]</b> (Line Color) and then use keys <b>[1]</b> through <b>[8]</b> to specify the desired color.                                                         |
| Specify the figure fill color                  | Press <b>[4]</b> (Area Color) and then use keys <b>[1]</b> through <b>[8]</b> to specify the desired color. To specify no fill color, press <b>[X,0,T]</b> (Clear). |
| Specify the lightness of the figure fill color | Press <b>[5]</b> (Paint Style) and then press <b>[1]</b> (Normal) or <b>[2]</b> (Lighter).                                                                          |

- To apply the settings you configure, return to the dialog box in step 2 of this procedure and then press **[EXIT]**.

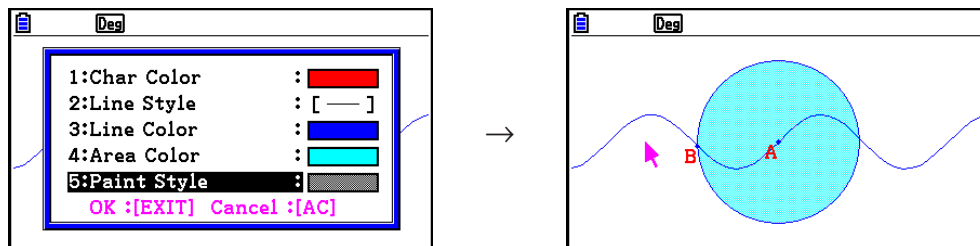

### • To specifying the color and line type of a particular object

- Use the procedure under “Selecting and Deselecting Objects” (page 14-19) to select the object whose color and/or line type you want to specify.
- Press **[SHIFT] [5]** (FORMAT).
  - This displays a dialog box that shows supported settings, which depend on the composition of the selected object.
- Perform the procedure starting from step 3 under “To specify the color and line type of all the displayed objects” (page 14-21).

## ■ Using the Construct Menu

Press **[F4]** (Construct) to display the Construct menu. You can use the Construct menu to construct various types of geometric objects, such as a perpendicular bisector, parallel, angle bisector, etc.

### • To construct a perpendicular bisector

- Draw a line segment and select it.
- Perform the following operation: **[F4]** (Construct) – 1:Perp Bisector.
  - This will draw the perpendicular bisector of the line segment you selected.

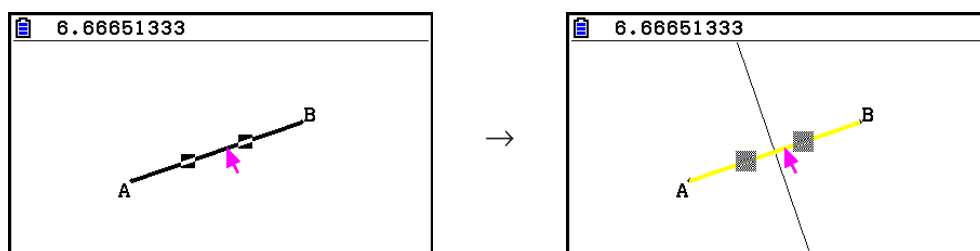

### **Note**

You can perform a perpendicular bisector construct operation while a single line segment, one side of a polygon, or two points are selected on the screen.

---

### • To construct a perpendicular

1. Draw a line segment, plot a point, and select the line and point.
2. Perform the following operation: **[F4]** (Construct) – 2:Perpendicular.
  - This will draw a perpendicular to the selected line segment and passes through the selected point.

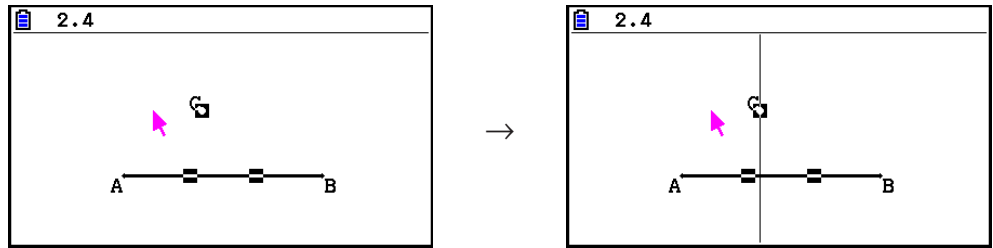

### **Note**

You can perform a perpendicular construct operation while a single line segment and single point, a single line and single point, a single ray and a single point, a single vector and a single point, or one side of a polygon and a single point are selected on the screen.

---

### • To construct a midpoint

1. Draw a line segment and select it.
2. Perform the following operation: **[F4]** (Construct) – 3:Midpoint.
  - This will plot the midpoint of the line segment you selected.

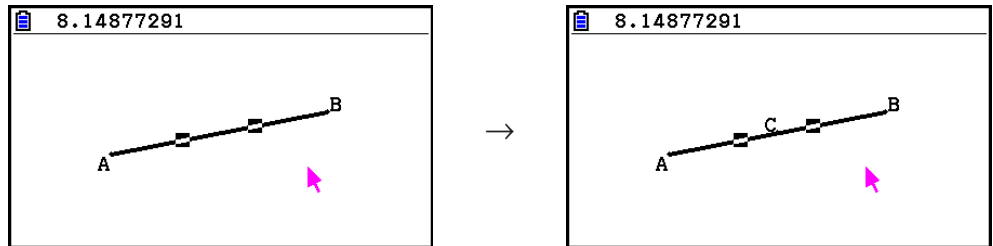

### **Note**

You can perform a midpoint construct operation while a single line segment, one side of a polygon, or two points are selected on the screen.



---

- **To construct the point of intersection of two lines**

1. Draw two intersecting line segments and select them.
2. Perform the following operation: **[F4]** (Construct) – 4: Intersection.
  - This plots the point where the two line segments intersect.

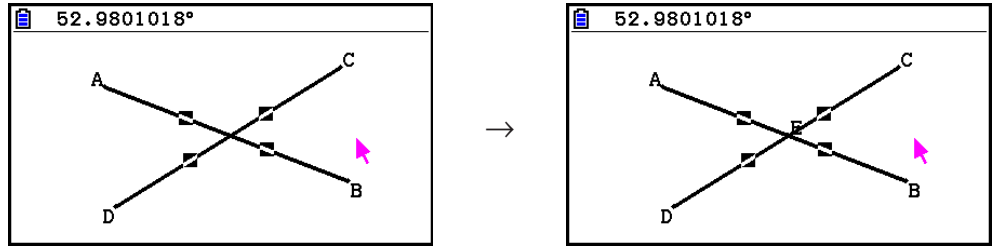

**Note**

You can construct the point of intersection of two lines while two of any of the following objects (two of the same object or two different objects) are selected on the screen: line segment, line, rays, vector, side of a polygon, circle, or arc.

---

- **To construct an angle bisector**

1. Draw a triangle and select two of its sides.
2. Perform the following operation: **[F4]** (Construct) – 5: Angle Bisector.
  - This draws the bisector of the angle formed by the two sides of the triangle that you selected.

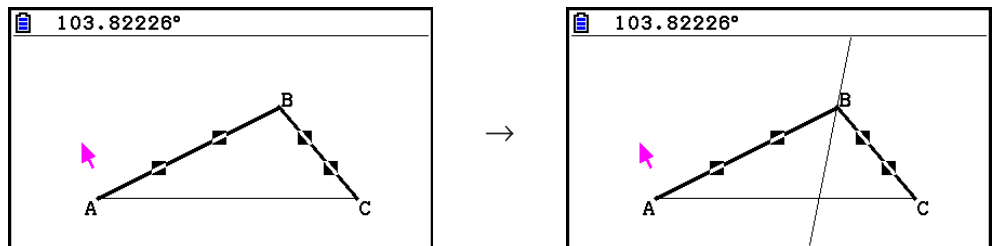

**Note**

- You can perform an angle bisector construct operation while two of any of the following objects (two of the same object or two different objects) are selected on the screen: line segment, line, ray, vector, or one side of a polygon.
- If the two objects you select are intersecting, the angle bisector construct operation will construct two angle bisectors.

---

## • To construct a parallel

1. Draw a line segment, plot a point, and select the line and point.
2. Perform the following operation: **[F4]** (Construct) – 6:Parallel.
  - This will draw an infinite line that is parallel to the selected line segment and passes through the selected point. Marks ( $\sphericalangle$ ) appear on both the line segment and the infinite line to indicate they are parallel.

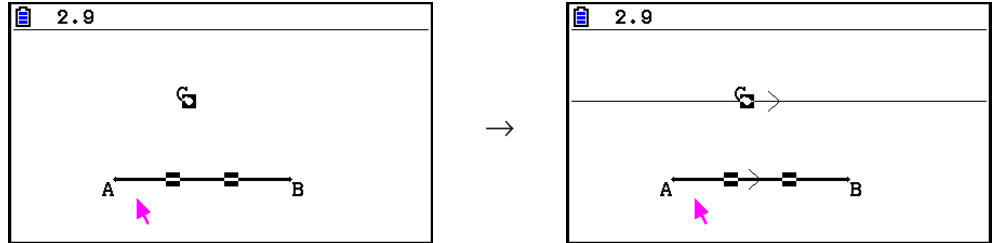

### **Note**

You can perform a parallel construct operation while any of the following combination objects is selected.

- A single line segment and a single point, a single line and a single point, a single ray and a single point, a single vector and a single point
- One side of a polygon and a single point

---

## • To construct a tangent

1. Draw a circle.
2. Perform the following operation: **[F4]** (Construct) – 7:Tangent.
  - This will cause the message “Select Curve” to appear.
3. Move the pointer close to the location on the circle where you want to construct the tangent.
  - Move the pointer towards the circle until  $\square$  marks appear on it.
4. Press **[EXE]**.
  - This will draw a line that is tangent to the circle at the location you selected with the pointer.

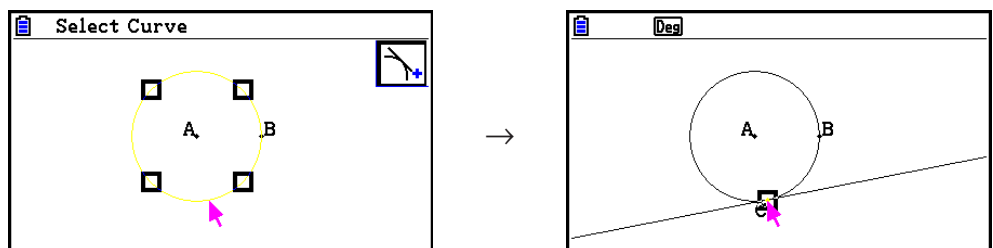

### **Note**

You can perform the tangent construct operation while a circle, semi circle, arc, or function graph is selected.

---

- **To attach an angle measurement to a figure**

1. Draw a triangle and select two of its sides.
2. Perform the following operation: **[F4]** (Construct) – 8:Attached Angle.
  - This attaches the angle measurement to the figure.

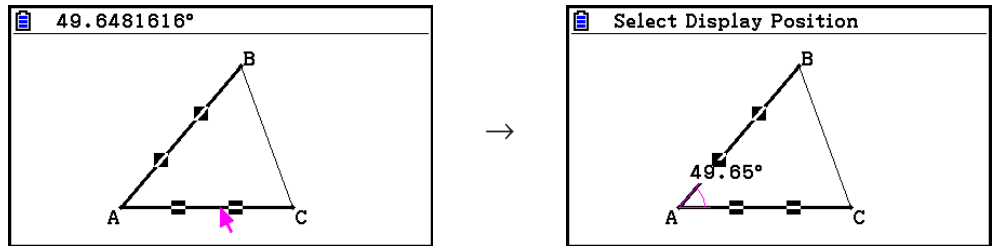

- While the “Select Display Position” message is displayed, you can use the cursor keys to specify which angle measurement is displayed for the two selected sides.

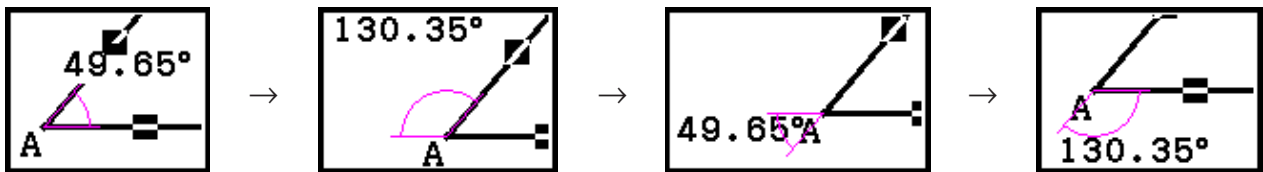

3. To view the angle measurement, press **[EXE]**.

---

## ■ Using the Transform Menu

Press **[F5]** (Transform) to display the Transform menu. You can use the Transform menu to perform various transform operations, such as object reflection, object rotation, etc.

---

- **To reflect an object**

1. Draw the object you want to reflect. Here, we will use a triangle.
2. Draw a line segment that represents the axis of the reflection.
3. Perform the following operation: **[F5]** (Transform) – 1:Reflection.
  - This will cause the message “Select Axis” to appear.
4. Move the pointer close to the line segment that you want to use as the axis of the reflection.
  - Move the pointer towards the line segment until **■** marks appears on it.

5. Press **EXE**.

- This reflects the object using the line segment as the axis.

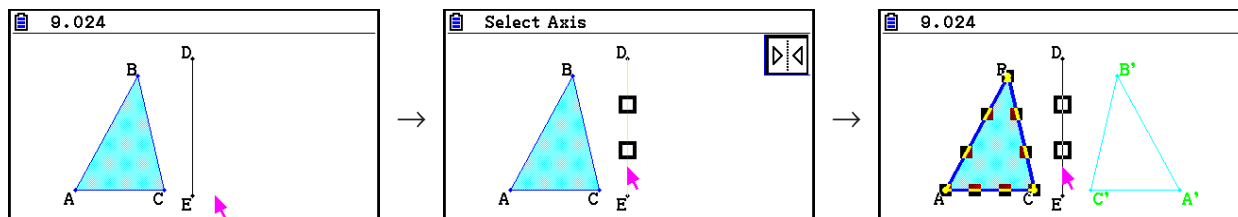

**Note**

You can specify a line segment, line, ray, one side of a polygon, or the *x*-axis or *y*-axis as the axis of reflection.

• **To translate an object by specified values**

1. Draw the object you want to translate. Here, we will use a triangle.
2. Perform the following operation: **F5**(Transform) – 2:Translation.
  - This displays the Translation screen.
3. Input vector format values to specify the distance of parallel translation.
  - The value in line 1 is the translation distance along the X-axis, while the value in line 2 is the distance along the Y-axis.
4. After the values are the way you want, press **EXE**.
  - This performs parallel translation of the object by the distance specified by the values you input in step 3.

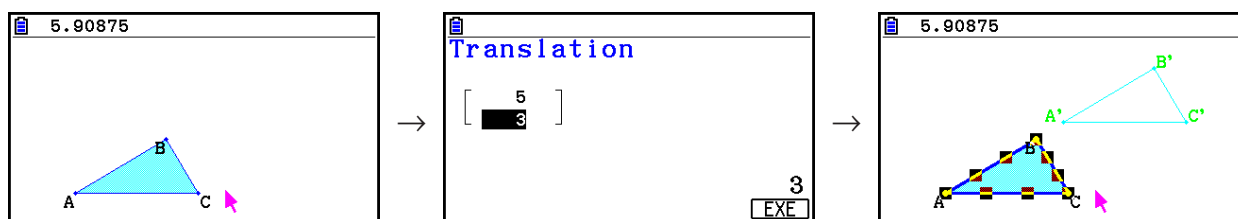

**Note**

If you select only part of an object before performing step 2 of the above procedure, only the selected part will be translated.

• **To translate an object using an existing vector**

1. Draw the object you want to translate. Here, we will use a triangle. Next, draw the vector you want to use for parallel translation.
2. Perform the following operation: **F5**(Transform) – 3:Trans(Sel Vec).
  - This will cause the message “Select Vector” to appear.
3. Move the pointer close to the vector you want to use for the parallel translation.
  - Move the pointer towards the vector until **□** marks appears on it.

4. Press **EXE**.

- This will perform parallel translation of the original object in the direction of the vector you selected.

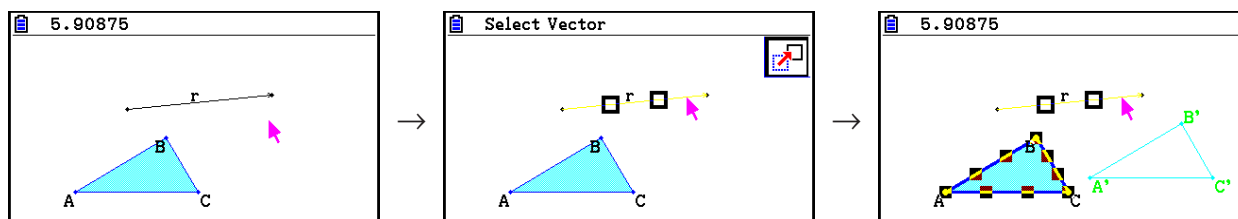

### Note

If you select only part of an object before performing step 2 of the above procedure, only the selected part will be translated.

---

### • To rotate an object

1. Draw the object you want to rotate. Here, we will use a triangle.
2. Perform the following operation: **F5** (Transform) – 4:Rotation.
  - This will cause the message “Sel Rotation Center” to appear.
3. Move the pointer to the location you want to specify as the center of rotation.
4. Press **EXE**.
  - This displays a dialog box for specifying the angle of rotation.
5. Input the angle of rotation (counterclockwise) in degrees and then press **EXE**.
  - This will draw the original object, rotated the specified amount.

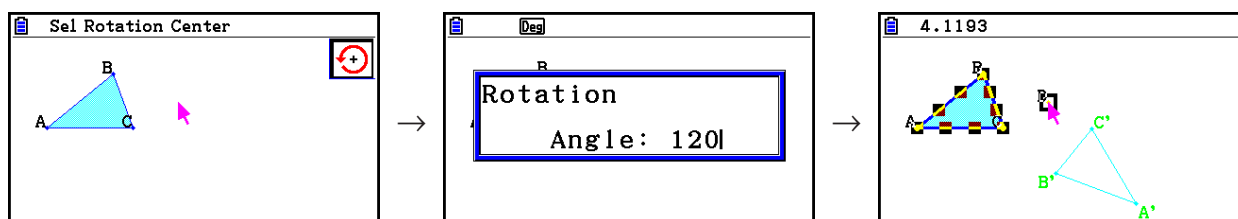

### Note

If you select only part of an object before performing step 2 of the above procedure, only the selected part will be rotated.

---

### • To dilate an object

1. Draw the object you want to dilate. Here, we will use a triangle.
2. Perform the following operation: **F5** (Transform) – 5:Dilation.
  - This will cause the message “Sel Dilation Center” to appear.
  - See the figure in the notes below for details about meanings of the terms used during the dilation operation.
3. Move the pointer to the location you want to specify as the center of dilation.
4. Press **EXE**.
  - This displays a dialog box for specifying the dilation scale.

5. Input a scale value in the range of  $0.1 \leq |x| \leq 10$  and then press **EXE**.

- This will draw a resized version of the original object.

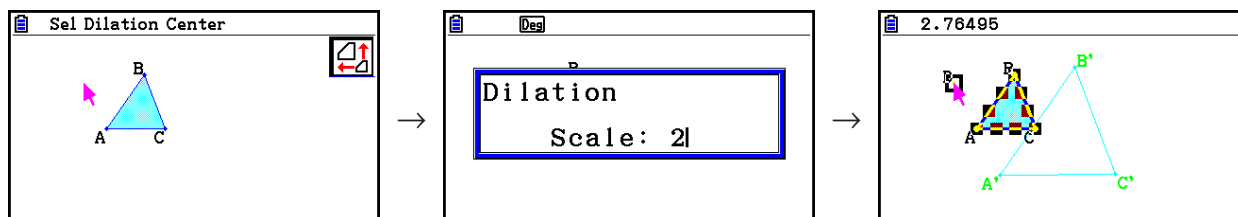

### Note

- If you select only part of an object before performing step 2 of the above procedure, only the selected part will be dilated.
- The following figure illustrates the meanings of the terms used in the above procedure.

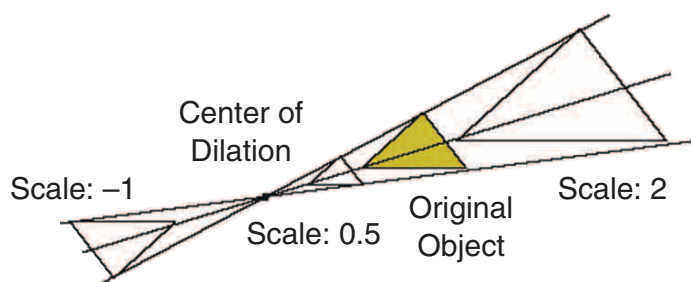

### • To rotate a figure 180 degrees on a specified point

1. Draw the figure you want to rotate and select it. Here, we will use a triangle.
2. Perform the following operation: **F5** (Transform) – 6:Symmetry.
  - This will cause the message “Select Center Point” to appear.
3. Move the pointer to the point you want to use as the center point of the rotation and then press **EXE**.
  - This will draw the figure rotated 180 degrees on the selected point. In addition, a point is plotted at the center point.

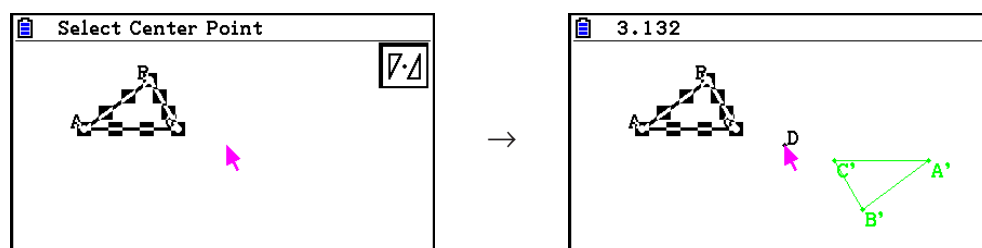

---

## ■ Undoing and Redoing an Operation

The Undo command lets you undo the last operation you performed, while Redo lets you restore an operation you have undone.

---

### • To undo the last operation you performed

Immediately after performing the operation you want to undo, press **⌘** or perform the following operation: **F2** (Edit) – 1:Undo/Redo.

#### **Important!**

Note that the following operations cannot be undone.

- Clear all objects operation: **F2** (Edit) – 6:Clear All (page 14-32).
- View Window setting configuration (page 14-35)
- Zoom operation (page 14-36)
- Scroll operation (page 14-36)
- Pan operation (page 14-35)
- Setup change (page 14-33)

---

### • To redo an operation

Immediately after undoing the operation, press **⌘** or perform the following operation: **F2** (Edit) – 1:Undo/Redo.

---

## ■ Moving and Deleting an Object

Before you can move or delete an object, you first need to select it. For details, see “Selecting and Deselecting Objects” (page 14-19).

---

### • To move an object

#### **Note**

Sometimes you may find that an object will not move the way you want it to. If this happens, try locking the part(s) of the object that you do not want to move (page 14-47), or temporarily unlock all objects (Clr Constraint, page 14-48).

1. Select the object you want to move.

- If you want to move only one of the vertices of a triangle for example, select the vertex. To move only one side of the triangle, select the side.

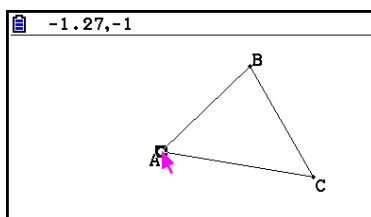

One vertex selected

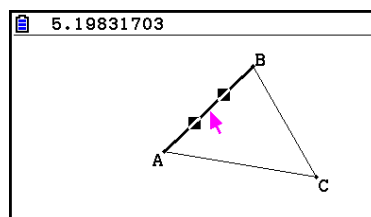

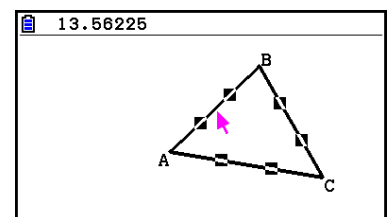

One side selected



Three sides selected

2. Press  $\boxed{X,\theta,T}$ .

- This causes the  icon to appear in the upper right corner of the screen and the pointer to change from  to . Also, a rectangle will enclose the object that you selected in step 1.

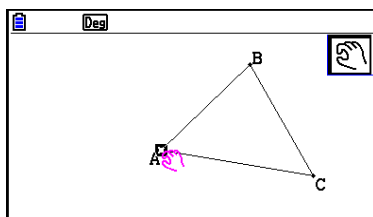

One vertex selected

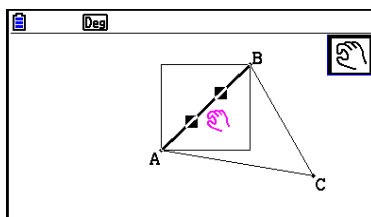

One side selected

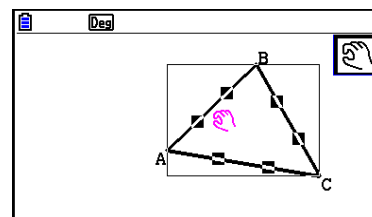

Three sides selected

3. Use the cursor keys to move the object in the direction you want.

- The rectangle will move in corresponding direction.

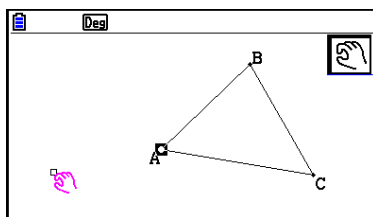

One vertex selected

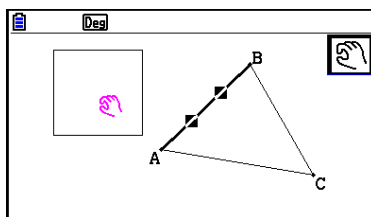

One side selected

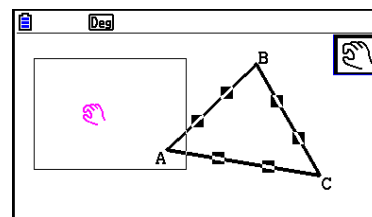

Three sides selected

4. To move the object to the current location of the rectangle, press  $\boxed{EXE}$ .

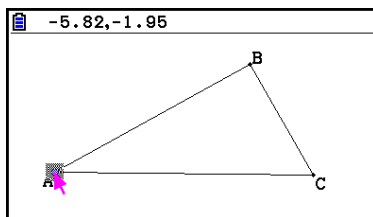

One vertex selected

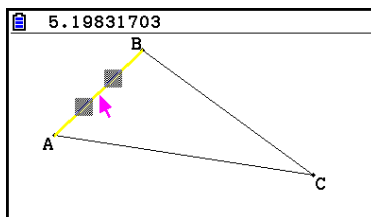

One side selected

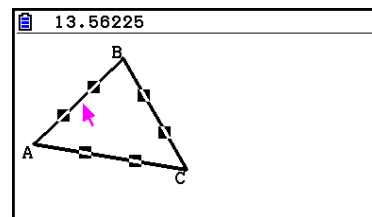

Three sides selected

**Note**

If you press  $\boxed{X,\theta,T}$  when nothing is selected on the screen, the pointer will change to a , which you can use to pan (shift) the entire screen.

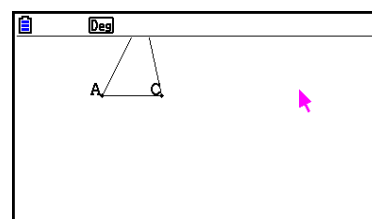
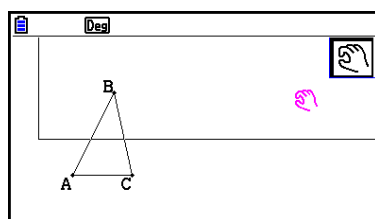
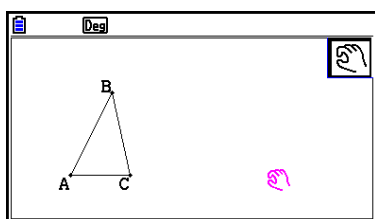



---

### • To delete an object

1. Select the object you want to delete.
  - If you want to delete only one of the vertices of a triangle for example, select the vertex. To delete only one side of the triangle, select the side.
2. Press **[DEL]** or perform the following operation: **[F2]** (Edit) – 5:Delete.
  - This deletes the selected object.

---

### • To delete all objects on the screen

1. Perform the following operation: **[F2]** (Edit) – 6:Clear All.
  - This causes a confirmation dialog box to appear.

#### ***Important!***

Pressing **[F1]** (Yes) in the following step will delete all the objects currently on the screen. This operation cannot be undone.

2. Press **[F1]** (Yes) to delete all the objects on the screen or **[F6]** (No) to cancel the delete operation.

#### **Note**

You can also delete all objects by pressing **[AC/ON]** twice while nothing is selected on the screen.

---

## ■ Hiding and Showing Objects

Use the following operations to hide specific objects and to show all currently hidden objects.

---

### • To hide an object

1. Select the object you want to hide.
2. Perform the following operation: **[OPTN]** (Option) – 6:Hide.
  - This hides the selected objects.

---

### • To show all hidden objects

Perform the following operation: **[OPTN]** (Option) – 5:Show All. This shows all currently hidden objects.

---

## ■ Changing the Display Priority of Objects

Basically, objects you draw in the **Geometry** mode are stacked in the order they are drawn (newest drawing on top). You can use the operations in this section to move a drawn object to the top or the bottom of the stack. You also can move all text to the front, if you want.

- To move a particular object to the front: **[OPTN]** (Option) **[▶]** (Properties) – 1:to the front.
- To move a particular object to the back: **[OPTN]** (Option) **[▶]** (Properties) – 2:to the back.
- To move all text to the front: **[OPTN]** (Option) **[▶]** (Properties) – 3:All TEXT.

### 3. Controlling the Appearance of the Geometry Window

This section provides information about how to control the appearance of the screen by scrolling or zooming, and by showing or hiding axes and the grid.

#### **Important!**

Settings you configure on the **Geometry** mode Setup screen are applied in the **Geometry** mode only. Even if another mode has settings of the same name, the **Geometry** mode settings will not affect them. Conversely, changing setting with the same name in another mode will not affect the **Geometry** mode settings.

---

#### ■ Displaying the Axes and Grid

You can display axes and grid points (or grid lines) on the **Geometry** mode screen. You also can specify the pitch (spacing) of the grid points and lines.

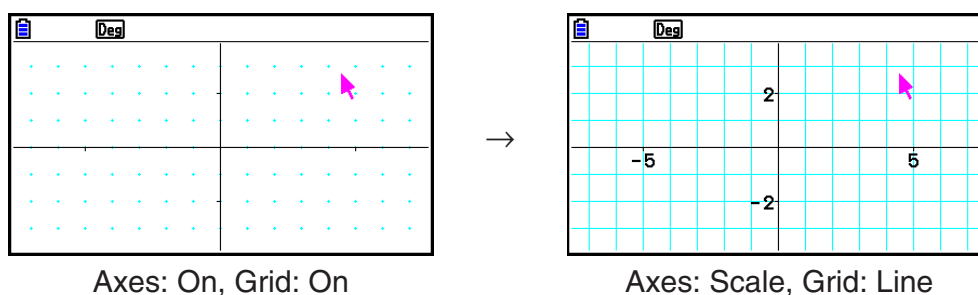

---

#### ● To specify the axis and grid settings

1. Press **[SHIFT] [MENU]** (SET UP) to display the Setup screen.
2. Use **▲** and **▼** to move the highlighting to “Grid” and then use the following operations to configure the settings you want.

| To select this setting: | Press this key:    |
|-------------------------|--------------------|
| Show grid points        | <b>[F1]</b> (On)   |
| Hide the grid           | <b>[F2]</b> (Off)  |
| Show grid lines         | <b>[F3]</b> (Line) |

- If you select Off to hide the grid, you can skip steps 3 and 4.
3. Use **▲** and **▼** to move the highlighting to “Grid Space” and then press **[F1]** (Space).
  4. On the dialog box that appears, enter a value to specify the pitch of the grid and then press **[EXE]**.
    - You can specify a value from 0.01 to 1000, in increments of 0.01.

5. Use  $\blacktriangle$  and  $\blacktriangledown$  to move the highlighting to “Axes” and then use the following operations to configure the settings you want.

| To select this setting:              | Press this key:   |
|--------------------------------------|-------------------|
| Show on-screen axes                  | <b>F1</b> (On)    |
| Hide on-screen axes                  | <b>F2</b> (Off)   |
| Show on-screen axes and scale values | <b>F3</b> (Scale) |

6. After the setting is the way you want, press **EXIT**.

## ■ Specifying Angle and Length Display Units

You can use the procedure in this section to show or hide the units of angle and length values. You also can specify which units should be used for angle and length values.

Angle unit: Deg, Rad

Length: mm, cm, m, km, inch, feet, yard, mile

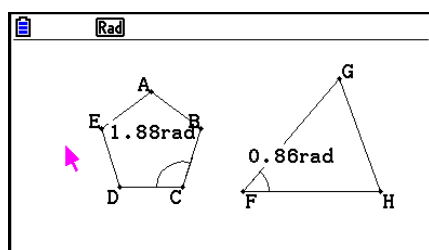

Angle: Rad, Angle Unit: On

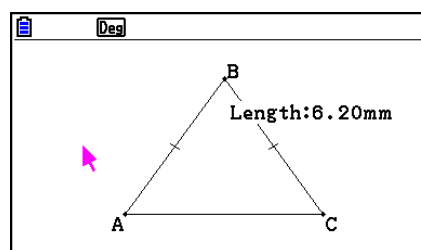

Length Unit: On (mm)

### ● To specify angle and length display units

1. Press **SHIFT** **MENU** (SET UP) to display the Setup screen.
2. Perform the following operations to configure the settings you want.

| To select this setting:                        | Perform this operation:                                                                                                                                     |
|------------------------------------------------|-------------------------------------------------------------------------------------------------------------------------------------------------------------|
| Degrees for display and calculation angle unit | Highlight “Angle” and then press <b>F1</b> (Deg).                                                                                                           |
| Radians for display and calculation angle unit | Highlight “Angle” and then press <b>F2</b> (Rad).                                                                                                           |
| Show unit for angle values                     | Highlight “Angle Unit” and then press <b>F1</b> (On).                                                                                                       |
| Hide unit for angle values                     | Highlight “Angle Unit” and then press <b>F2</b> (Off).                                                                                                      |
| Show unit for length values                    | 1. Highlight “Length Unit” and then press <b>F1</b> (On).<br>2. When the dialog box appears, use keys <b>1</b> through <b>8</b> to specify the length unit. |
| Hide unit for length values                    | Highlight “Length Unit” and then press <b>F2</b> (Off).                                                                                                     |

3. After the setting is the way you want, press **EXIT**.

---

## ■ Configuring View Window Settings

You can configure View Window settings to specify the coordinates of the screen's left edge (Xmin) and right edges (Xmax). The length of the y-axis is configured automatically using a ratio of 1:2 (y-axis:x-axis), but you can specify what part of the y-axis is in the middle of the screen (Ymid).

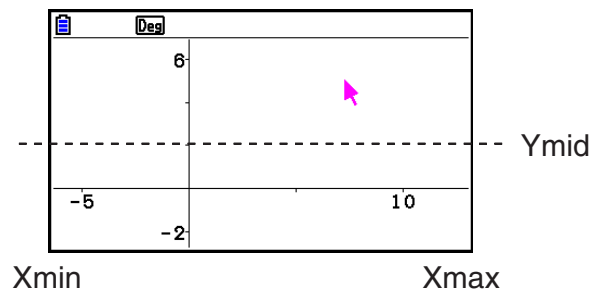

---

### • To configure View Window settings

1. Perform the following operation to display the View Window screen: **[SHIFT]** **[F3]** (V-WIN).

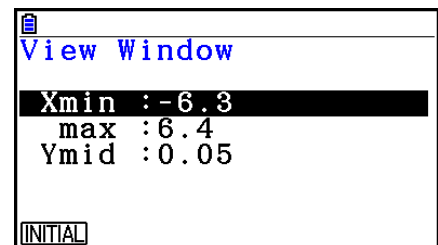

2. Input values for Xmin, Xmax, and Ymid.
  - If you want to return these settings to their initial defaults, press **[F1]** (INITIAL).
3. After all the settings are the way you want, press **[EXIT]**.



---

## ■ Using Pan and Scroll to Shift the Display Image

There are two methods available for shifting the contents of the screen. In addition to scrolling, you can also use pan, which lets you grab a specific point on the screen and shift it to the position you want.

---



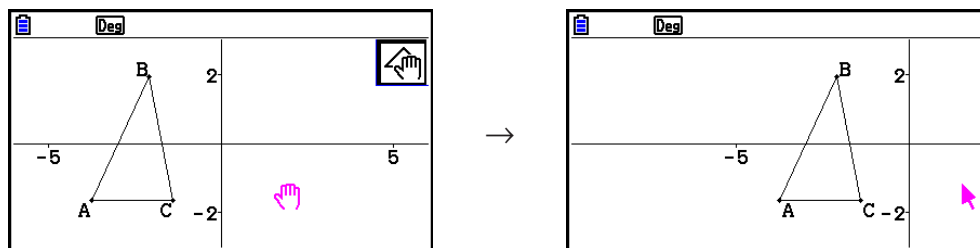

### • To pan the screen

1. Perform the following operation: **[F1]** **[▶]** (View) – 2:Pan.
  - This enters the Pan mode, which is indicated by the  icon in the upper right corner of the screen.
2. Move the pointer to the location on the screen you want to grab and then press **[EXE]**.
  - This causes the pointer to change from  to .
3. Use the cursor keys to shift the screen in the direction you want.



4. To exit the Pan mode, press **EXIT**.



### Note

In the Pan mode, each press of **EXE** toggles the shape of the pointer between  and . While the  pointer is displayed, you can use the cursor keys to move it to another location on the screen. Pressing the cursor keys while the  pointer is displayed will shift (pan) the screen contents.



### • To scroll the screen

1. Press  or perform the following operation: **F1**  (View) – 3:Scroll.
  - This enters the Scroll mode, which is indicated by the  icon in the upper right corner of the screen. The pointer disappears from the screen at this time.
2. Use the cursor keys to scroll the screen in the direction you want.
3. To exit the Scroll mode, press **EXIT**.

## ■ Zooming

The **Geometry** mode provides you with a selection of zoom commands that you can use to enlarge or reduce an entire screen image or a specific area of an object.

### • To zoom using the zoom box

1. Perform the following operation: **F1**  (View) – 1:Zoom Box.
  - This causes the  icon to appear in the upper right corner of the screen.
2. Move the pointer to the location on the display on one edge of the area you want to select as the zoom box area and then press **EXE**.
3. Move the pointer in the direction of the opposite edges of the zoom box area.
  - As you do, the calculator will display a selection boundary that will expand as you move the pointer.
4. After selecting the zoom box area you want, press **EXE**.
  - The area within the zoom box area expands to fill the entire screen.

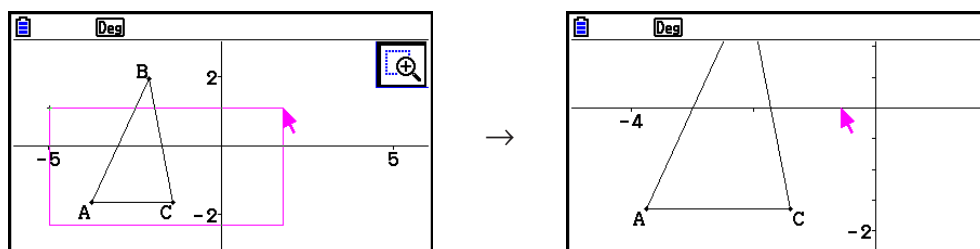

---

### • To zoom in and out

To double the size of the displayed image, press  $\boxed{+}$  or perform the following operation:

$\boxed{F1}$   $\blacktriangleright$  (View) – 4:Zoom In.

To halve the size of the displayed image, press  $\boxed{-}$  or perform the following operation:

$\boxed{F1}$   $\blacktriangleright$  (View) – 5:Zoom Out.

---

### • To zoom the screen image to fit the window area

Press  $\boxed{\leftarrow}$  or perform the following operation:  $\boxed{F1}$   $\blacktriangleright$  (View) – 6:Zoom to Fit.

- This will enlarge or reduce the currently display image so it fills the screen.

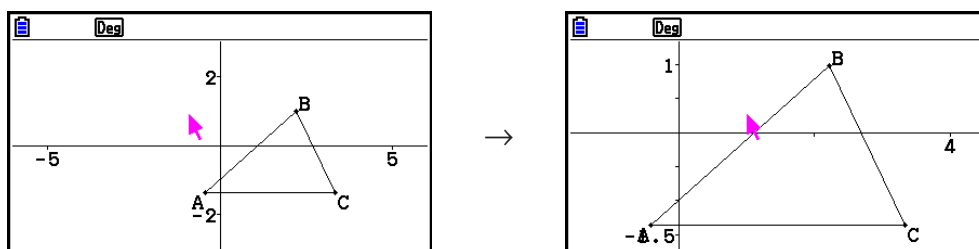

### Note

The above operation does not apply in the case of a graph drawn using  $\boxed{F3}$   $\blacktriangleright$  (Draw Spec) 7: Function  $f(x)$ .

---

## ■ Adjusting the Lightness of the Background Image

You can adjust the lightness of the background image while a g3p file is open in the **Geometry** mode. To adjust image lightness, press  $\boxed{OPTN}$  (Option)  $\blacktriangleright$  (Properties) 4:Fade I/O and then perform the procedure from step 2 under “To adjust the lightness (Fade I/O) of the background image” (page 5-12).

---

## 4. Using Text and Labels in a Screen Image

You can use the procedures in this section to insert text into a screen image. You can also edit the labels that the calculator inserts automatically for objects, and add labels to objects.

---

### ■ Inserting Text into Screen Images

You can use the following procedure to insert text into a screen image and to edit existing text.

---

#### • To insert text into a screen image

1. Move the pointer to the location on the screen where you want to insert the text.
2. Perform the following operation:  $\boxed{OPTN}$  (Option) – 1:Text.

- This will display a text input dialog box and automatically switch the calculator’s keys to Alpha Lock.

3. Input up to 31 characters of text and then press **[EXE]**.

- The text you input is inserted into the screen image at the location of the pointer.

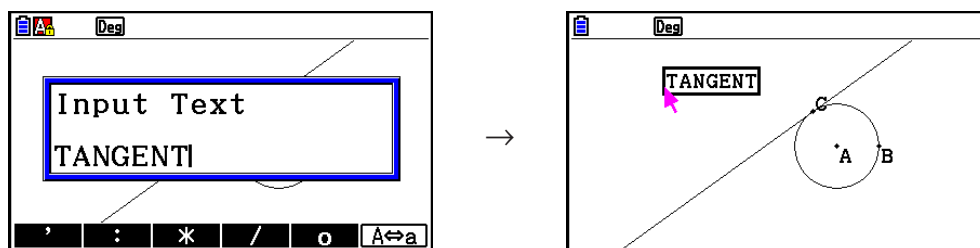

4. Now you can move the text to another location on the screen, if you want.

- For details, see “To move an object” (page 14-30).

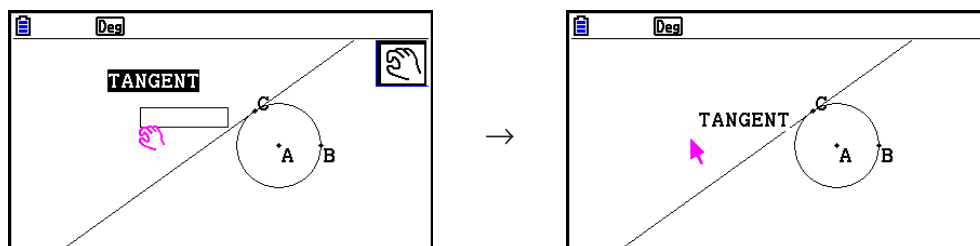

### • To edit screen text

1. Select the text you want to edit.

2. Press **[VARS]**.

- This displays the measurement box at the bottom of the screen.

3. Press **[EXE]**.

- This displays the text input dialog box.

4. Edit the text and then press **[EXE]**.

- This causes the newly edited text to appear on the screen.

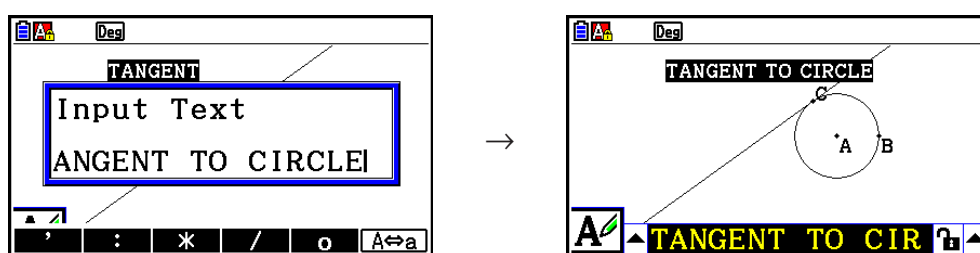

5. To close the measurement box, press **[EXIT]** twice.

## ■ Adding or Modifying a Label

Label operations are explained in this section using a triangle. In the first example we modify an existing label, while in the second example we add a label to one side of the triangle.

### • To modify an existing label

1. On the triangle, select the vertex whose label you want to change. In this example we will select point A.

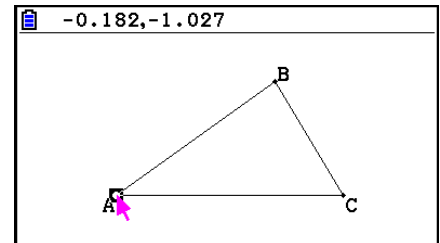

2. Press **[VARS]**.

- This displays the measurement box at the bottom of the screen.

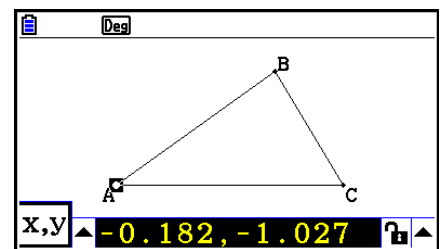

3. Press **[◀]** to highlight the up arrow button on the left side of the measurement box and then press **[EXE]**.

- This displays an icon palette.

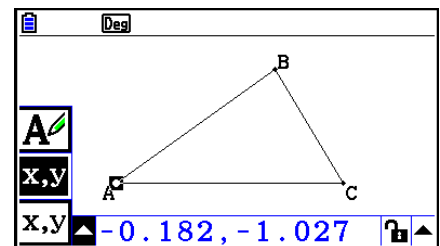

4. Use the cursor keys to move the highlighting to the **A** icon on the icon palette and then press **[EXE]**.

5. Press **[▶]** to move the highlighting back to the measurement box and then press **[EXE]**.

- This will display a label editing dialog box and automatically switch the calculator's keys to Alpha Lock.

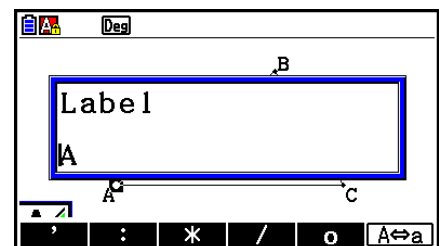



6. Input up to 14 characters for the label text and then press **EXE**.

- This will modify the label.

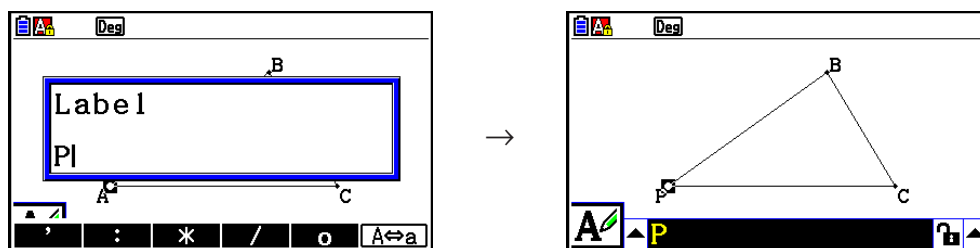

7. To close the measurement box, press **EXIT** twice.

### • To add a new label

1. Select the side of the triangle to which you want to add the label.

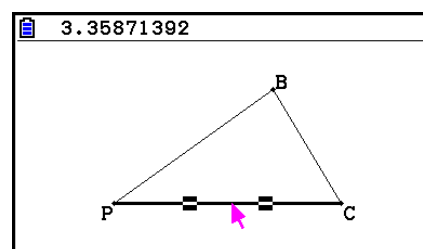

2. Press **VARS** to display the measurement box.

3. Press **▲** to highlight the up arrow button on the left side of the measurement box and then press **EXE**.

- This displays an icon palette.

4. Use the cursor keys to move the highlighting to the **A** icon on the icon palette and then press **EXE**.

5. Press **▶** to move the highlighting back to the measurement box and then press **EXE**.

- This will display the label edit dialog box.

6. Input up to 14 characters for the new label text and then press **EXE**.

- This will add the label.

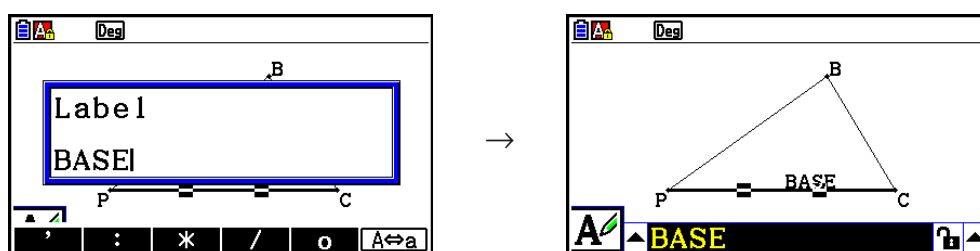

7. To close the measurement box, press **EXIT** twice.

## 5. Using the Measurement Box

Pressing **VAR** displays a measurement box at the bottom of the screen as shown below.

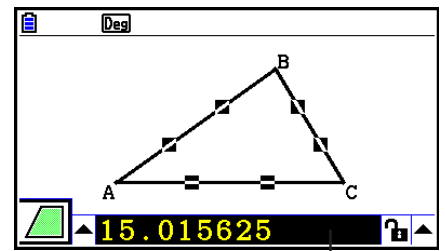

Measurement Box

You can use the measurement box to perform the following operations.

### ***View the measurements of an object***

Displaying the measurement box and selecting an object displays combinations of the following measurements, depending on the type of object you select: coordinates, distance/length, slope, equation, vector, radius, circumference, perimeter, area, angle, supplementary angle, tangency, congruence, incidence, or point on curve.

### ***Specify the measurement of part of an object***

After you display the measurement box, you can select part of an object and then change numeric values for the applicable measurement. You can specify the coordinates of a point, the length of a line segment (distance between endpoints), the angle formed by two lines, etc.

### ***Lock the measurement of part of an object***

After you display the measurement box, you can select part of an object and then lock the applicable measurement. You can lock the coordinates of a point, the length of a line segment, the angle formed by two lines, etc.







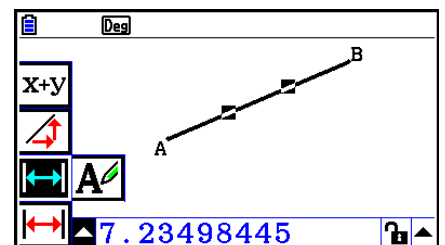





---

## ■ Viewing the Measurements of an Object

The type of information that appears in the measurement box depends on the object that is currently selected on the display. If a line segment is selected, for example, the measurement box shows the distance, slope, or the equation for that line. You can specify the type of information you want to view by highlighting the up arrow button to the left of the measurement box, pressing the **EXE** (or **▲**) key, and then using the cursor keys to highlight the appropriate icon on the icon palette that appears.







The following table describes the information that appears when you highlight each icon, and explains when each icon is available for selection.

| Icon                                                                                | Icon Name                         | This icon appears when this is selected:                                                | Highlighting this icon displays:                                | Lockable         |
|-------------------------------------------------------------------------------------|-----------------------------------|-----------------------------------------------------------------------------------------|-----------------------------------------------------------------|------------------|
|    | Coordinates                       | A single point                                                                          | Coordinates of the point                                        | Yes              |
|    | Distance/<br>length               | Two points on one object or two different objects, or a single line segment or a vector | Distance between two points, length of a line segment or vector | Yes              |
|    | Slope                             | Single line, ray, line segment, or vector                                               | Slope of the line, ray, line segment or vector                  | Yes              |
|    | Equation                          | Any single line or line segment, ray, circle, semi circle, arc or function graph        | Function of the object (using rectangular coordinates)          | No               |
|    | Expression                        | A single expression ("EXPR=" object)                                                    | Calculation formula                                             | No               |
|    | Vector                            | A single vector                                                                         | Vector components                                               | Yes              |
|   | Radius                            | A single circle, semi circle or arc                                                     | Radius of circle, semi circle or arc                            | Yes              |
|  | Circumference                     | A single circle, semi circle or arc                                                     | Length of the circumference                                     | No* <sup>3</sup> |
|  | Perimeter                         | A single polygon                                                                        | Sum of the lengths of the sides                                 | No               |
|  | Area                              | Any three points, a single circle, semi circle, arc, or polygon                         | Area                                                            | No* <sup>3</sup> |
|  | Angle* <sup>1</sup>               | Two lines, line segments, rays, or vectors* <sup>2</sup> in any combination             | Angle and its supplement formed by the two objects              | Yes              |
|  | Supplementary Angle* <sup>1</sup> |                                                                                         |                                                                 |                  |
|  | Tangency                          | Two circles or arcs, line and circle, or a line and arc                                 | Whether the two items are tangent                               | Yes              |

\*<sup>1</sup> The angle and supplementary angle is always displayed as degrees.

\*<sup>2</sup> When two vectors are selected, the angle that is no the angle formed mathematically by the two vectors. It merely indicates the simple angle that would be formed if the vectors were two lines.

\*<sup>3</sup> The circle itself can be locked.

| Icon                                                                              | Icon Name         | This icon appears when this is selected:                   | Highlighting this icon displays:              | Lockable |
|-----------------------------------------------------------------------------------|-------------------|------------------------------------------------------------|-----------------------------------------------|----------|
|  | Congruence        | Two line segments                                          | Whether the line segments are the same length | Yes      |
|  | Incidence         | Point and a line, arc, circle or a vector                  | Whether the point is on the line/curve        | Yes      |
|  | Rotation angle    | Two points created by the <b>[F5]</b> – 4:Rotation command | Angle of rotation                             | No       |
|  | Scale of dilation | Two points created by the <b>[F5]</b> – 5:Dilation command | Scale of dilation                             | No       |
|  | Label/Text        | A point that has a label or an object that can be named    | Label text                                    | No       |

You can use the measurement box to determine certain measurements.

The first example below shows how to view the measurements of a line segment. In the second example, three points are selected on the screen and the measurement box shows the area of the triangle formed by them.

### • To view the measurements of a line segment

1. Draw a line segment and select it.
  - This displays the length of the line segment.

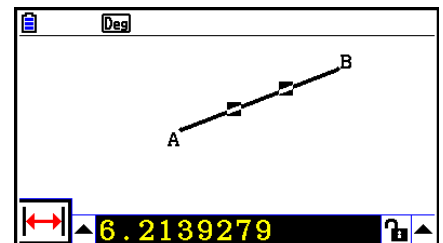

3. Press  to highlight the up arrow button on the left side of the measurement box and then press **[EXE]**.
  - This displays an icon palette.

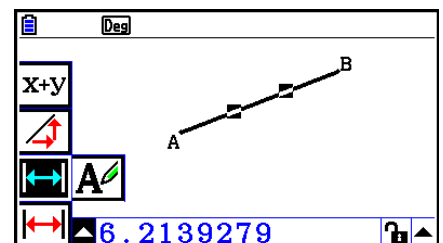

4. Select the icons on the icon palette to display other measurements.

- In the case of the line segment, for example, you can view its length, slope, and equation.

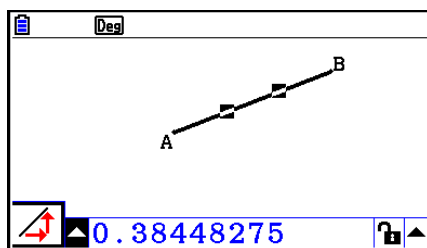

Slope

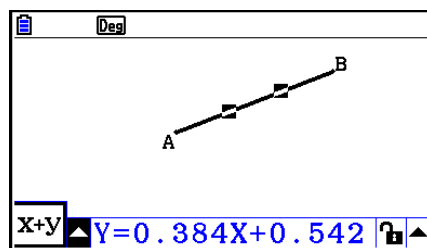

Equation

5. To close the measurement box, press **EXIT** twice.

### • To display the area of a rectangular area

You can use the measurement box to display the area of a triangle formed by any three points you select on the display.

**Example:** To use the rectangle ABCD to determine the areas of the triangles formed by points A, D, and B, and points A, D, and C

1. Draw the rectangle.
2. Select points A, D, and B.
3. Press **VAR**.

- This causes the area of the triangle ADB to appear in the measurement box.

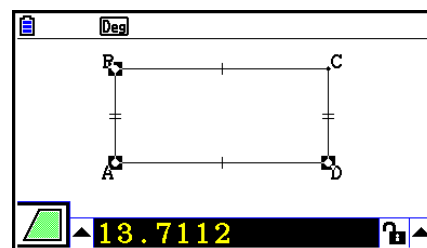

4. To make the drawing screen active, press **EXIT**.

- This causes the measurement box to become unhighlighted and the pointer to reappear on the drawing screen.

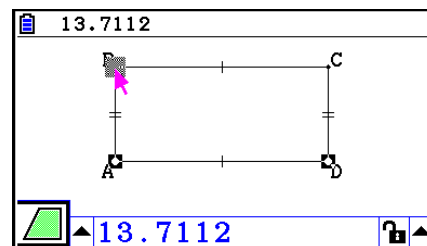

5. Press **AC/ON** to deselect the current points and then select points A, D, and C.

- This causes the area of the triangle ADC to appear in the measurement box. The above procedure shows that the areas of the two triangles are the same.

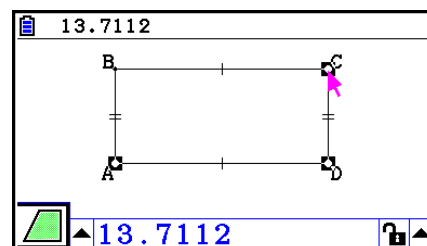

6. To close the measurement box, press **EXIT**.

## Note

A value that shows the area of an object whose lines intersect is indicated by double asterisks (\*\*\*) to the left of the value. This indicates that the value may not indicate the correct area.

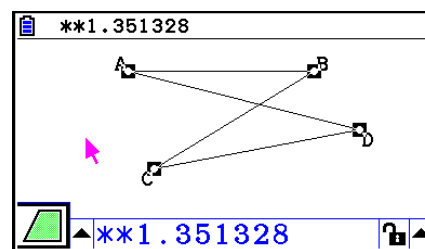

## ■ Specifying a Measurement of an Object

In the following examples, we specify the angle of a triangle and the length of one side of a triangle.

### • To specify the angle of a triangle

1. Draw a triangle.
2. Select side AC and then select side BC.
3. Press **[VARS]** to display the measurement box.
  - This displays the size of  $\angle ACB$  (in degrees) in the measurement box.

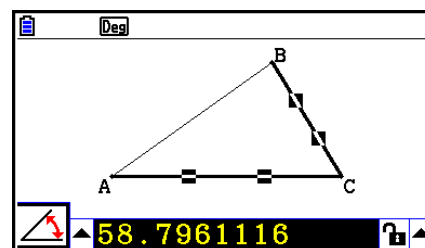

4. Input the value you want to specify for  $\angle ACB$  (in degrees) into the measurement box and then press **[EXE]**.
  - In this example we input 90, which makes  $\angle ACB$  90 degrees.

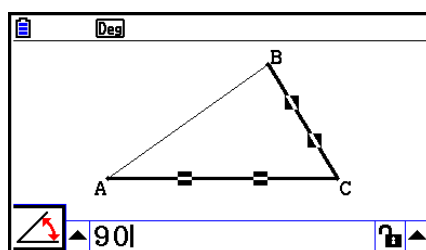

→

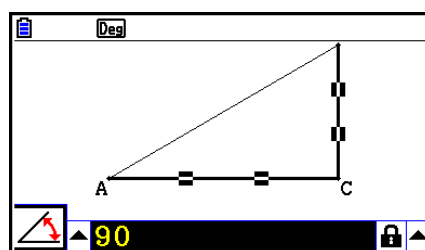

5. To close the measurement box, press **[EXIT]** twice.

## Note

- Performing step 5 in the above procedure not only changes the measurement value, it also locks the measurement. For details about locking and unlocking measurements, see “Locking or Unlocking a Measurement of an Object” (page 14-47).
- Specifying a value can change an object in a way that is unexpected. If this happens, try locking part(s) of the object (page 14-47) or temporarily unlock all objects (Clr Constraint, page 14-48).

---

## • To specify the length of one side of a triangle

### Note

- Specifying any one of the following measurements for the first time in the file you are editing (or immediately after an all clear operation: **F2** (Edit) – 6:Clear All) will cause the resulting object to be resized so it fits within the display area.
  - Length of one side of a triangle
  - Length of a line segment or vector
  - Length of one side of a rectangle, square, polygon, or regular n-gon
  - Circumference of a circle or length of an arc

View Window settings will be reconfigured automatically so the size of the object on the display may not appear to change very much.

The following example shows what happens when the length of the base of a triangle drawn with default View Window settings (with a screen width of 10.7) is changed to 120.

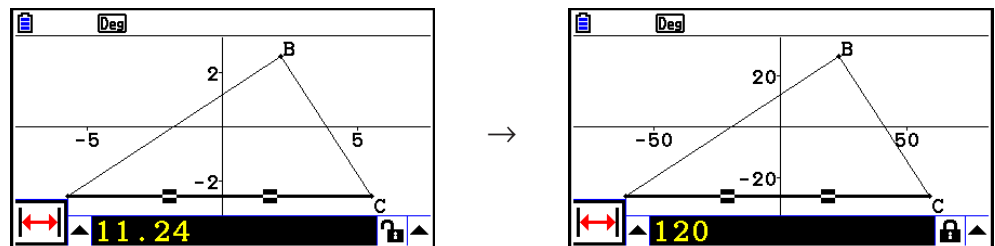

View Window settings are reconfigured in order to ensure that specifying a measurement of an object does not make it too big to fit on the screen or too small to see. Note that all other objects currently on the screen also will be resized by the same amount as the object whose measurement you are specifying.

- Once you specify one measurement of an object, it will not be resized further if you specify another of its measurements.

## ■ Locking or Unlocking a Measurement of an Object

By “locking a measurement” we mean that the corresponding object cannot be moved. For example, if we lock a point to a circle and move the circle, the point will also move.

### ● To lock or unlock a measurement

The icon to the right of the measurement box indicates whether a measurement is locked or unlocked.

 Measurement is unlocked.

 Measurement is locked.

### ● To lock a particular measurement

You can lock a particular measurement by performing any one of the following operations.

- Perform the procedure under “Specifying a Measurement of an Object” (page 14-45) to specify the measurement. This will cause the specified measurement to become locked automatically.

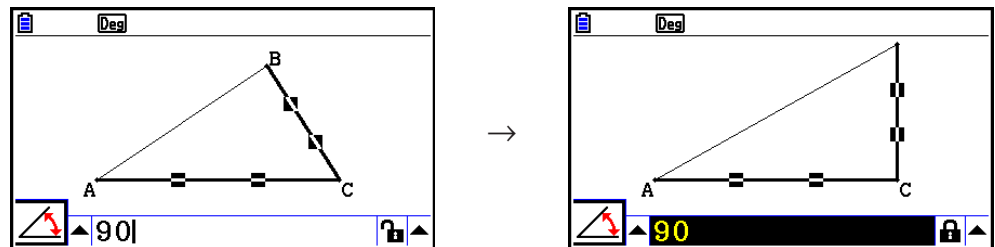

- If the icon to the right of the measurement box is , move the highlighting to the icon and press **EXE**.

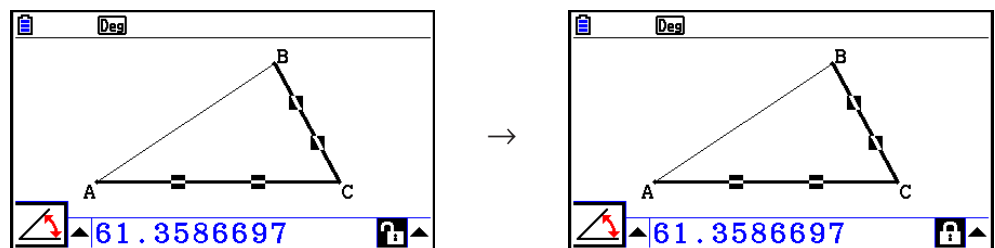

- Move the highlighting to the up arrow button to the right of the  icon and press **EXE**. On the menu that appears, select [Lock] and then press **EXE**.

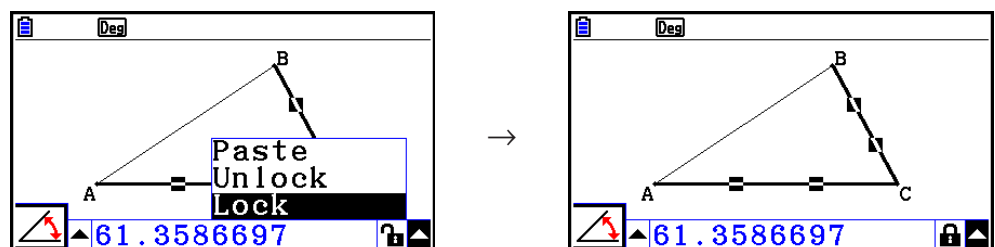





## Note

- Some measurements cannot be locked. For details, see the “Lockable” column in the table under “Viewing the Measurements of an Object” (page 14-41).

---

### • To unlock a particular measurement

You can unlock a particular measurement by performing any one of the following operations.

- If the icon to the right of the measurement box is , move the highlighting to the icon and press **EXE**.
- Move the highlighting to the up arrow button to the right of the  icon and press **EXE**. On the menu that appears, select [Unlock] and then press **EXE**.

---

### • To unlock all objects on the screen

Perform the following operation: **OPTN** (Option) – 4:Clr Constraint.

This unlocks all locked settings.

## Note

The above operation unlocks both measurements you locked manually, as well as objects that are locked automatically whenever they are drawn. For example, the above operation unlocks all of the following lock conditions.

- The lock that is applied when you draw a rectangle that keeps its opposing sides equal (opposing side congruence lock)
- The lock that is applied when you draw an isosceles triangle (ABC) that keeps side AB and side BC equal (side AB and side BC congruence lock)
- The lock that is applied when you draw an infinite line that keeps the line passing through two points (point A and point B) (infinite line and point A, B incidence lock)
- The relationship between the line segment and perpendicular bisector that is formed when you select a line segment and perform the following operation: **F4** (Construct) – 1:Perp Bisector.
- The (locked) similarities of objects when you select the objects and perform the following operation: **F5** (Transform) – 5:Dilation.

## ■ Pasting Measurements into a Screen Image

You can use the procedures in this section to paste object measurements into the image on the screen. The measurements change dynamically as you manipulate the object.

The following types of measurements can be pasted into a screen image: coordinates, distance/length, slope, equation, vector components, radius, circumference, perimeter, area, angle, supplementary angle.

### ● To paste a measurement into a screen image

**Example:** To paste an internal angle measurement into a screen image

1. Draw a triangle and select two of its sides.

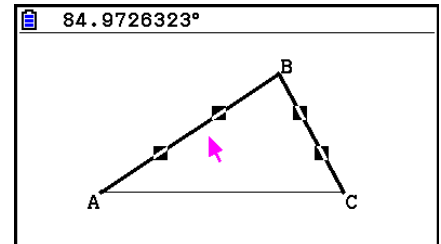

2. Press **[VARS]** to display the measurement box.

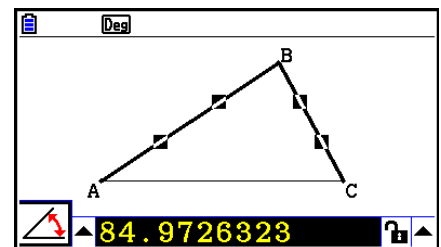

3. Press **[▶]** to highlight the up arrow button on the right side of the measurement box and then press **[EXE]**.

- This will display a menu.

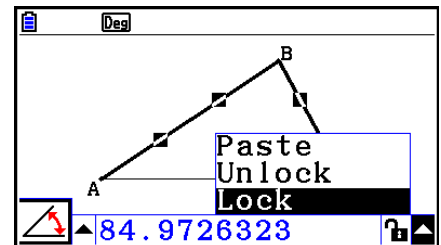

4. Use **[▲]** to move the highlighting to [Paste] and then press **[EXE]**.

- This will cause the measurement in the measurement box to be pasted into the screen image. At this time, the pasted measurement text is selected.

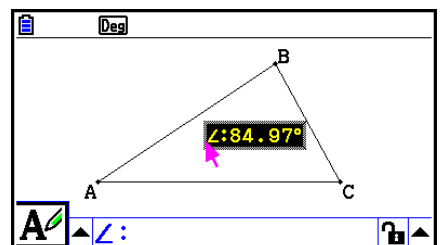
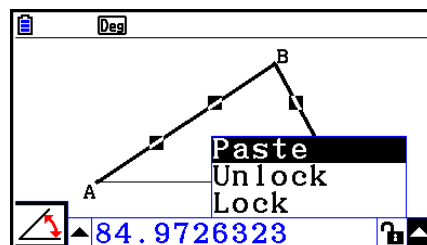

5. Move the text to another location on the screen, if you want.

- Press  $\boxed{X, \theta, T}$  and then use the cursor keys to move the pasted measurement around the screen. For details, see “To move an object” (page 14-30).

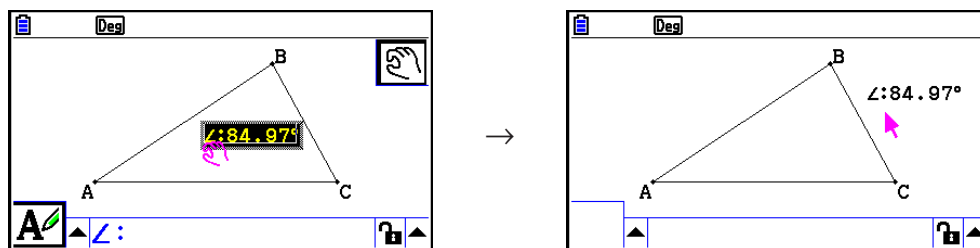

### Note

You can also paste the measurement that is currently in the measurement box into the screen image by pressing  $\boxed{\text{SHIFT}} \boxed{9}$  (PASTE) while the measurement box is highlighted in step 2 of the above procedure.

## ■ Editing a Measurement Type Tag

When you paste a measurement into a screen image using the “To paste a measurement into a screen image” procedure on page 14-49, a measurement type tag (text or a symbol) is appended in front of the measurement value to indicate the measurement type.

|                       |                    |
|-----------------------|--------------------|
| Examples: Length      | <b>Length:8.32</b> |
| Angle (Internal)      | <b>∠:84.97°</b>    |
| Angle (Supplementary) | <b>≅:148.72°</b>   |

You can edit or delete the measurement type tag as required.

### • To edit a measurement type tag

1. Select the measurement whose type tag you want to edit and then press  $\boxed{\text{VAR}} \boxed{\text{S}}$ .

- This will display the measurement box and display the type tag of the selected measurement inside it.

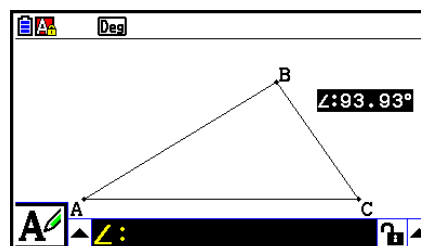

2. Press  $\boxed{\text{EXE}}$ .

- This will display the label edit dialog box.

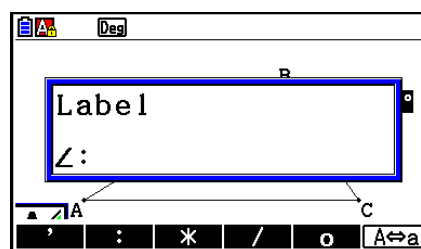

3. Input up to 14 characters for the label type tag.

- To delete the label type tag, press  $\boxed{AC/ON}$ .

4. Press  $\boxed{EXE}$ .

- This changes the measurement, which is highlighted on the display.

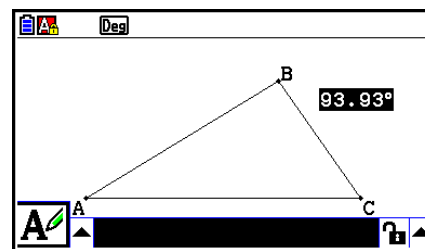

5. To close the measurement box, press  $\boxed{EXIT}$  twice.

---

## ■ Displaying the Result of a Calculation that Uses On-screen Measurement Values

You can use the procedure in this section to perform calculations using the angle value, line length, and other measurement values attached to an object, and display the result on the screen.

- 
- **To display the result of a calculation that uses on-screen measurement values**

**Example:** With line segment AB and line segment CD (point C being on AB) drawn on the display as shown here, calculate the sum of  $\angle ACD$  and  $\angle DCB$ , and display the result on the screen. ( $54.72 + 125.28 = 180.00$ )

- For information about displaying measurement values of  $\angle ACD$  and  $\angle DCB$ , see “Pasting Measurements into a Screen Image” (page 14-49).

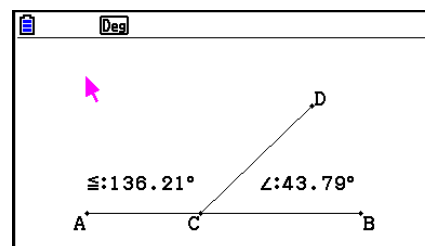

1. Perform the following operation:  $\boxed{\text{OPTN}}$  (Option) – 2:Expression.

- This will display “EXPR=” at the pointer location and display the measurement box.
- The above will also display labels for each measurement currently on the screen.

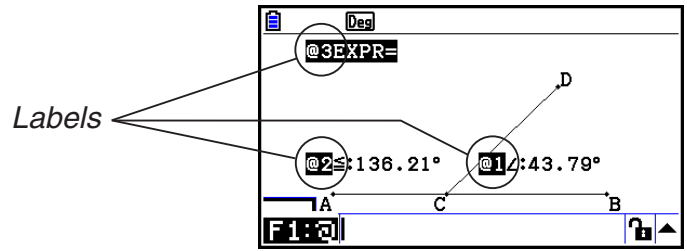

2. Now you can use the labels to specify measurement values in the calculation you input in the measurement box.

- To input a measurement value in the measurement box, input the at sign (@) followed by the numeric label of the value: @1, @2, etc. Since we want to calculate the sum of angles DCB (@1) and ACD (@2) here, you would input the following: @1+@2.
- You can input “@” by pressing  $\boxed{\text{F1}}$ .

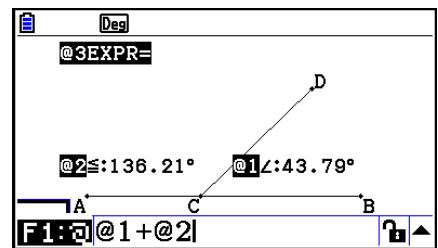

3. After inputting the calculation expression, press  $\boxed{\text{EXE}}$ .

- The calculation result is displayed to the right of “EXPR=”.

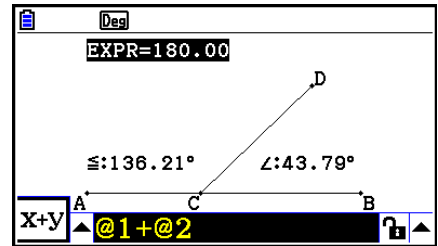

**Note**

When a measurement is a coordinate or vector component, the label format becomes, “@1X”, “@1Y”, etc. “@1X” indicates the x-value of a coordinate or the x-component value of a vector, while “@1Y” indicates the y-value of a coordinate or the y-component value of a vector.

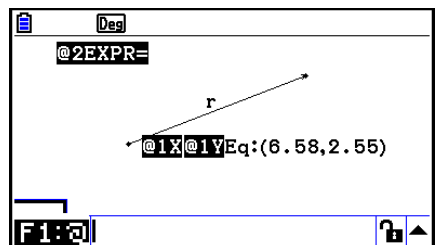
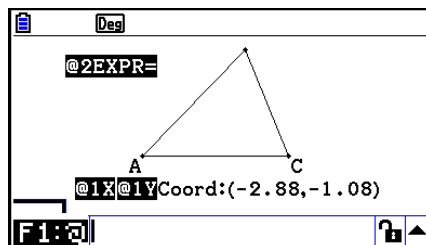

## ■ Calculation Using the Surface Area of Displayed Figures

You can use the procedures in this section to perform calculations using the surface area of figures, and display both the expression and calculation results. For example, calculation of the sum of the surface areas of triangle ABC and triangle A'B'C' can be displayed as shown below.

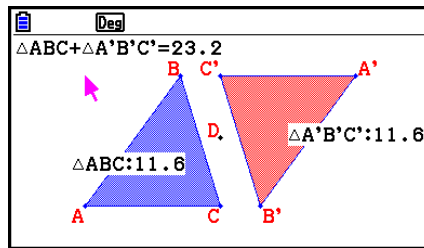

Figures that can be specified for a calculation are those with fill colors (those whose Area Color is anything other than “Clear”). For information about the Area Color setting, see “Specifying the Color and Line Type of a Displayed Object” (page 14-21).

### ● To perform a calculation using the surface area of displayed figures

**Example:** To calculate the sum of the surface areas of two displayed triangles, and display the expression and calculation results

1. Draw the triangles, and then specify blue for the Area Color of one, and red for the Area Color of the other.

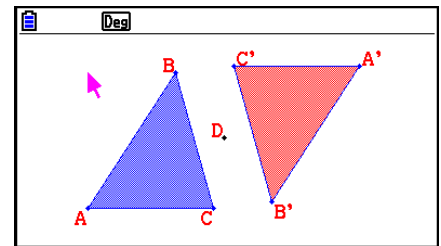

2. Perform the following operation:  $\boxed{\text{OPTN}}$  (Option) – 7:Area Calc.

- This display the measurement box with one of the triangles highlighted. The highlighted figure is the one that is currently selected for surface area calculation. You can use  $\blacktriangleleft$  and  $\blacktriangleright$  to move the highlighting between the two figures.

3. Select the first figure to be calculated (the left one in this example) and then press  $\boxed{\text{EXE}}$ .

- This will highlight the measurement box, indicating that the contents of the box can be edited.
- “@1 ΔABC” appears on the left triangle, and “@1” (the symbol for  $\Delta ABC$ ) is input into the measurement box.

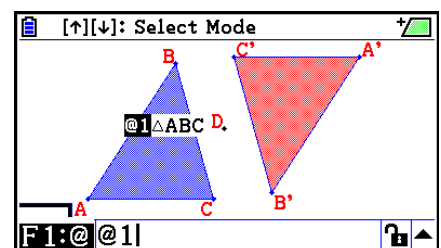

4. Press  $\boxed{+}$ .

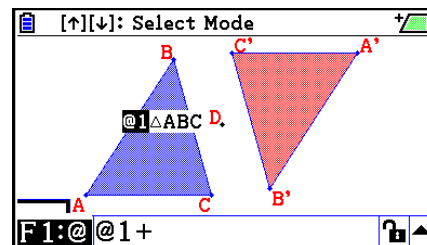

5. Press  $\triangleleft$  to return the editing focus to the drawing screen from the measurement box, and then press  $\boxed{\text{EXE}}$  to select the other triangle on the right side of the screen.

- “@2  $\Delta A'B'C'$ ” appears on the right triangle, and “@2” (the symbol for  $\Delta A'B'C'$ ) is input into the measurement box.

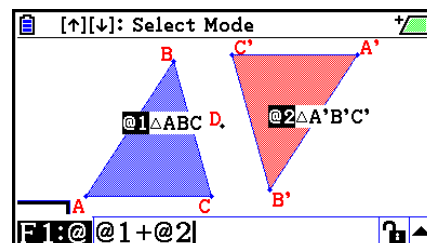

6. Press  $\boxed{\text{EXE}}$ .

- This causes the calculation expression  $\Delta ABC + \Delta A'B'C'$  to appear at the top of the screen.

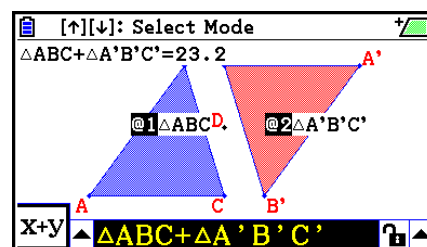

7. Press  $\boxed{\text{EXIT}}$  to close the measurement box.

- Now you can move the text on the screen as you like.
- For more information, see “To move an object” (page 14-30).

## ■ Specifying the Number Format of a Measurement

You can specify the number format for each measurement on the screen.

### Note

- The initial default number format is “Fix2”. For details about number formats, see “Specifying the Angle Unit and Display Format” (page 2-12).
- Regardless of the current number format setting, integer values are always displayed with their decimal parts cut off.

### ● To specify the number format of a measurement

**Example:** To specify one decimal places for measurement values

1. Select the measurement whose number format you want to change.

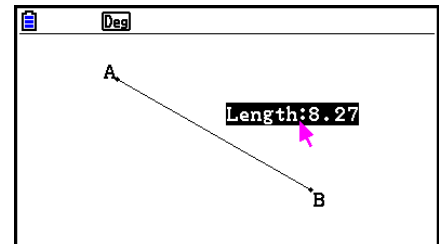

2. Perform the following operation:  $\boxed{\text{OPTN}}$  (Option) – 3: Number Format.

- This displays the Number Format dialog box.

3. Move the highlighting to the number format you want. Since we want to specify one decimal places, we will select “Fix1” here.

4. Press  $\boxed{\text{EXE}}$ .

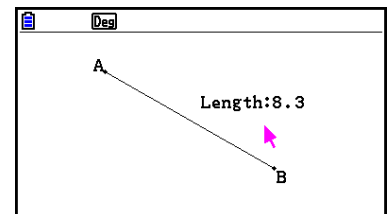
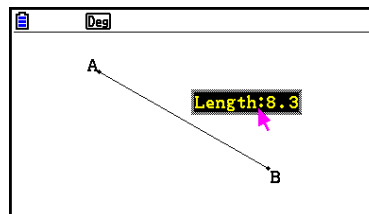
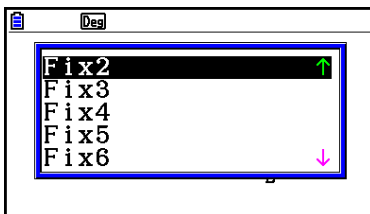



# 6. Working with Animations

An animation consists of one or more point/curve pairs, in which the curve can be a line segment, circle, semi circle, arc, or function. You build an animation by selecting a point/curve pair and then adding it to an animation.

## ■ Creating and Running an Animation

### • To add an animation and run it

**Example:** To animate a point around a circle

1. Plot a point and draw a circle, and select them.

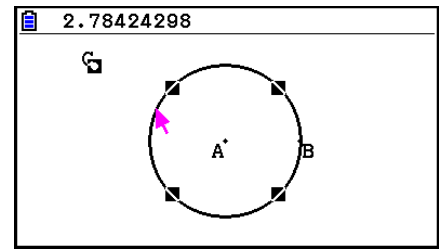

2. Perform the following operation: **F6** (Animate) – 1:Add Animation.

- This will add an animation effect that causes a point to move along the circumference of the circle.

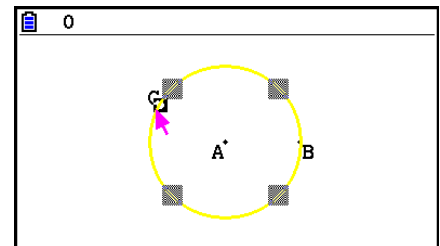

3. Perform either of the following operations: **F6** (Animate) – 5:Go (once) or **F6** (Animate) – 6:Go (repeat).

- This cause the point to move along the circumference of the circle.

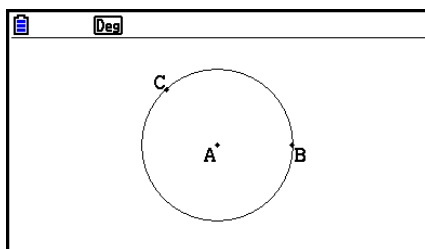

→

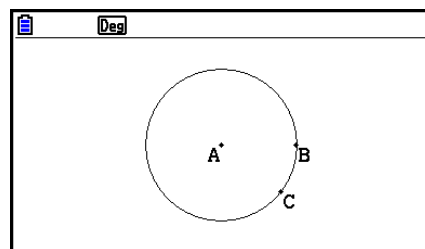

...

4. To stop the animation, press **EXIT** or **AC/ON**.

### Note

- You can repeat the above procedure to create multiple points that move simultaneously.

Try this:

- Draw a line segment and plot another point.
- Select the line segment and the point.
- Repeat steps 2 and 3 above.

Notice that both animations go at the same time!

- To start a new animation, perform the procedure under “To replace the current animation with a new one” below.

---

### • To replace the current animation with a new one

1. Select the point and curve for the new animation.
2. Perform the following operation: **F6**(Animate) – 2:Replace Anima.
  - This discards the current animations and sets up an animation for a new point and curve set.
3. To execute the new animation, perform either of the following operations:  
**F6**(Animate) – 5:Go (once) or **F6**(Animate) – 6:Go (repeat)
4. To stop the animation, press **EXIT** or **AC/ON**.

---

### • To trace a locus of points

#### Note

Using trace leaves a trail of points when the animation is run.

#### Example: To use the Trace command to draw a parabola

A parabola is the locus of points equidistant from a point (the focus) and a line (the directrix). Use the Trace command to draw a parabola using a line segment (AB) as the directrix and a point (C) as the focus.

1. Draw a line segment AB and plot point C, which is not on line segment AB.
2. Plot point D, which should also not be on line segment AB, but should be on the same side of the line segment as point C.
3. Draw a line segment that connects point D with point C.
4. Draw another line segment that connects point D with line segment AB. This is line segment DE.

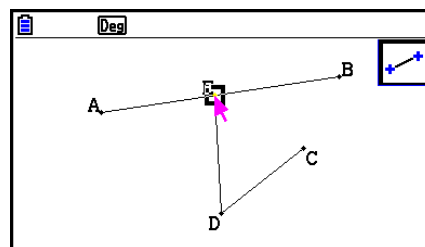

5. Select line segments AB and DE, and then press **VAR**.
  - This displays the measurement box, which shows the angle between line segments AB and DE.

6. Input 90 into the measurement box by pressing **9** **0** **EXE**.

- This makes the angle between line segments AB and DE 90 degrees, and locks it.

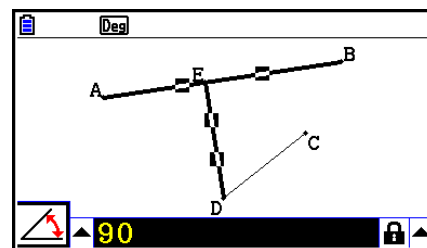

7. Press **EXIT** **AC/ON** to deselect all objects on the screen.

8. Select line segments DE and DC, and then press **VAR**.

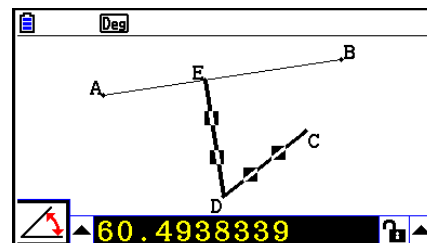

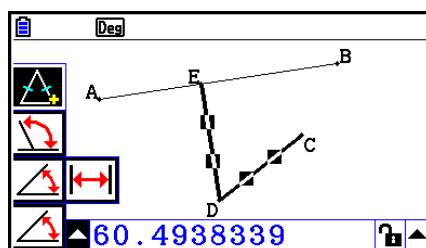

9. Press **◀** **EXE** to display the icon palette, move the highlighting to the  icon, and then press **EXE**.

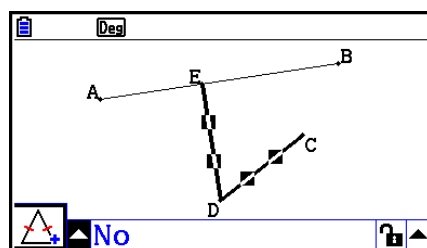

**EXE**  
→



10. Use **▶** to move the highlighting to the  icon and then press **EXE**.

- This changes the icon to .
- This makes line segments DE and DC congruent in length.

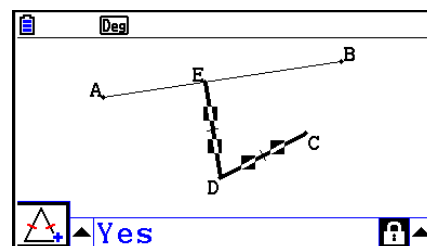

11. Press **EXIT** **EXIT** **AC/ON** and then select point E and line segment AB.

12. Perform the following operation: **F6** (Animate) – 1: Add Animation.

13. Press **AC/ON** and then select point D.

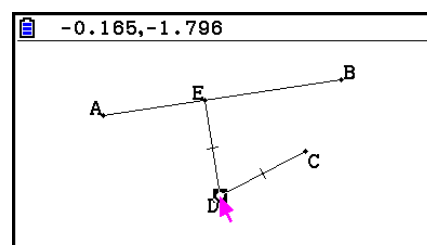

14. Perform the following operation:  $\boxed{F6}$  (Animate) – 3:Trace.

- This specifies point D (the one you selected in step 13) as the “trace point”.

15. Perform the following operation:  $\boxed{F6}$  (Animate) – 5:Go (once).

- This should cause a parabola to be traced on the display. Note that line segment AB is the directrix and point C is the focus of the parabola.

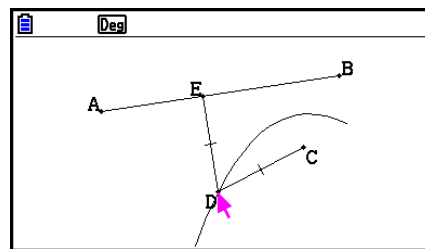

**Note**

- All of the points that are currently selected on the screen become trace points when you perform the following operation:  $\boxed{F6}$  (Animate) – 3:Trace. This operation also cancels Trace for any point that is currently configured as a trace point.
- The calculator’s auto power off feature will turn off power if an animation is being performed. If calculator power is turned off (either by auto power off or manually) while an animation is being performed, the animation will be stopped.

**• To edit an animation**

**Example:** While the animation screen created with the procedure under “To trace a locus of points”, use the Edit Animations screen to edit the animation

1. While the animation screen you want to edit is on the display, perform the following operation:  $\boxed{F6}$  (Animate) – 4:Edit Animation.

- This will display the Edit Animations screen.

2. Edit the animation using one of the procedures below.

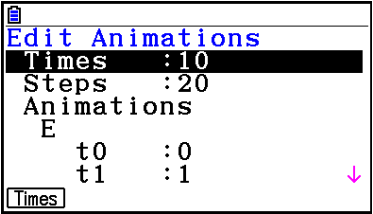
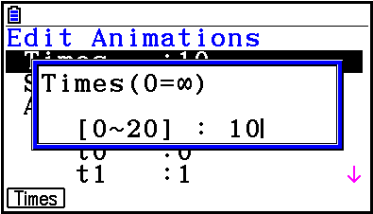
| When you want to do this:                                                                                                         | Perform this procedure:                                                                                                                                                                                                                                                                                                                                                                                                                                                                                                                                                                                                                                                                                                                                                                                                                                                                                              |
|-----------------------------------------------------------------------------------------------------------------------------------|----------------------------------------------------------------------------------------------------------------------------------------------------------------------------------------------------------------------------------------------------------------------------------------------------------------------------------------------------------------------------------------------------------------------------------------------------------------------------------------------------------------------------------------------------------------------------------------------------------------------------------------------------------------------------------------------------------------------------------------------------------------------------------------------------------------------------------------------------------------------------------------------------------------------|
| Specify how many times the animation should be executed when you perform the operation:<br>$\boxed{F6}$ (Animate) – 6:Go (repeat) | <ol style="list-style-type: none"> <li>Use <math>\blacktriangledown</math> and <math>\blacktriangle</math> to move the highlighting on the Edit Animations screen to “Times” and then press <math>\boxed{F1}</math> (Times).               <div style="display: flex; align-items: center; justify-content: center; margin: 10px 0;">  <span style="margin: 0 10px;">→</span>  </div> </li> <li>On the dialog box that appears, input the number of repeats you want to specify and then press <math>\boxed{EXE}</math>.               <ul style="list-style-type: none"> <li>• Inputting 0 here will cause the animation to repeat until you press <math>\boxed{EXIT}</math> or <math>\boxed{AC/ON}</math> stop it.</li> </ul> </li> </ol> |

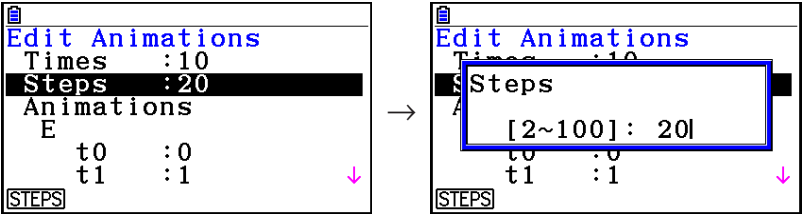
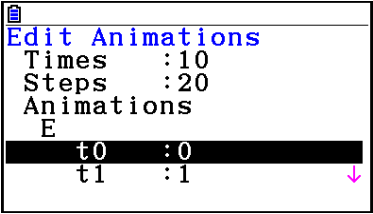
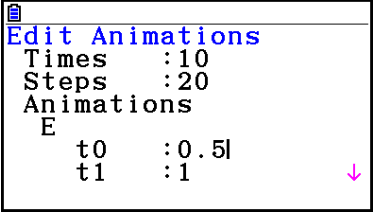
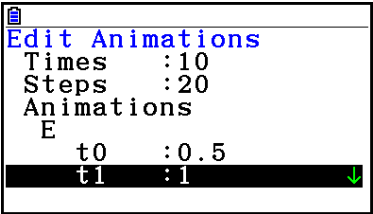
| When you want to do this:                                                                  | Perform this procedure:                                                                                                                                                                                                                                                                                                                                                                                                                                                                                                                                                                                                                                                                                                                                                                                                                                                                                                                                                                                                                                                                                                                                                                                                                                                                                                                                                          |
|--------------------------------------------------------------------------------------------|----------------------------------------------------------------------------------------------------------------------------------------------------------------------------------------------------------------------------------------------------------------------------------------------------------------------------------------------------------------------------------------------------------------------------------------------------------------------------------------------------------------------------------------------------------------------------------------------------------------------------------------------------------------------------------------------------------------------------------------------------------------------------------------------------------------------------------------------------------------------------------------------------------------------------------------------------------------------------------------------------------------------------------------------------------------------------------------------------------------------------------------------------------------------------------------------------------------------------------------------------------------------------------------------------------------------------------------------------------------------------------|
| Specify the number of steps to be used as point E travels along line segment AB            | <p>1. Use <math>\blacktriangledown</math> and <math>\blacktriangle</math> to move the highlighting on the Edit Animations screen to “Steps” and then press <math>\boxed{F1}</math> (STEPS).</p>  <p>2. On the dialog box that appears, input an integer from 2 through 100 and then press <math>\boxed{EXE}</math>.</p>                                                                                                                                                                                                                                                                                                                                                                                                                                                                                                                                                                                                                                                                                                                                                                                                                                                                                                                                                                        |
| Specify the start point and the end point of the movement of point E along line segment AB | <p>1. Use <math>\blacktriangledown</math> and <math>\blacktriangle</math> to move the highlighting on the Edit Animations screen to “t0”, which is located just under the “E” of “Animations”.</p>  <p>2. Input a number from -10 to 10.</p>  <ul style="list-style-type: none"> <li>t0 specifies the start point for point E movement along line segment AB. Inputting a value of 0 specifies point A as the start point, while a value of 1 specifies point B. Specifying 0.5 specifies the center of line segment AB. A value smaller than 0.5 shifts the start point towards point A, while a larger values shift towards point B.</li> </ul> <p>3. After specifying a value for t0, press <math>\boxed{EXE}</math>.</p> <ul style="list-style-type: none"> <li>This will highlight “t1”.</li> </ul>  <p>4. Input a value from -10 to 10 and then press <math>\boxed{EXE}</math>.</p> <ul style="list-style-type: none"> <li>t1 specifies the end point for point E movement along line segment AB. Inputting a value of 1 specifies point B as the end point, while a value of 0 specifies point A.</li> </ul> |

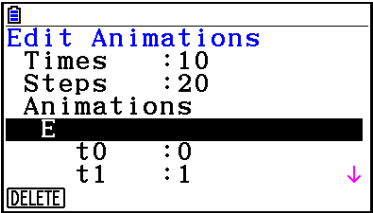
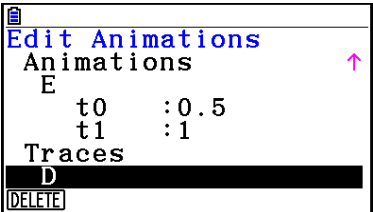
| When you want to do this:                | Perform this procedure:                                                                                                                                                                                                                                                                                                                                                                                                                                                                                                                                                                                                                                                                           |
|------------------------------------------|---------------------------------------------------------------------------------------------------------------------------------------------------------------------------------------------------------------------------------------------------------------------------------------------------------------------------------------------------------------------------------------------------------------------------------------------------------------------------------------------------------------------------------------------------------------------------------------------------------------------------------------------------------------------------------------------------|
| Delete the animation assigned to point E | <p>1. Use <math>\blacktriangledown</math> and <math>\blacktriangle</math> to move the highlighting on the Edit Animations screen to “E”, which is located under “Animations”.</p>  <p>2. Press <math>\boxed{F1}</math> (DELETE).</p> <ul style="list-style-type: none"> <li>This deletes the animation assigned to point E and causes “E” (along with the “t0” and “t1” values under it) to disappear from under “Animations” screen.</li> </ul> <p><b>Note</b><br/>Selecting “Animations” in step 1 and then pressing <math>\boxed{F1}</math> (DELETE) will delete the animations assigned to all points.</p> |
| Turn off trace for point D               | <p>1. Use <math>\blacktriangledown</math> and <math>\blacktriangle</math> to move the highlighting on the Edit Animations screen to “D” under “Traces”.</p>  <p>2. Press <math>\boxed{F1}</math> (DELETE).</p> <ul style="list-style-type: none"> <li>This turns off trace for point D and causes “D” to disappear from under “Traces”.</li> </ul> <p><b>Note</b><br/>Selecting “Traces” in step 1 and then pressing <math>\boxed{F1}</math> (DELETE) will turn off trace for all points.</p>                                                                                                                 |

3. After all the settings are the way you want, press  $\boxed{EXIT}$ .

- This will close the Edit Animations screen.

## ■ Generating an Animation Table

Under default settings, an animation causes a specified point to move along a specified line segment, circle, or arc in 20 steps. You can configure the calculator to generate a table, called an “animation table”, which records the coordinates of each step, the length of the line segment, the area of the object, etc.

Any of the following data can be added to the animation table: coordinates  $(x, y)$ , distance/length, slope, radius, circumference, perimeter, area, angle, supplementary angle, vector segments  $(x, y)$ , and expression.

### ● To add columns to the animation table

**Example:** Draw the triangle CDE with a base parallel to and a vertex (point D) located on horizontal line AB. Next, generate an animation table that includes the length of line segment CD and the area of the triangle as point D moves along line segment AB.

1. Draw line segment AB and triangle CDE.

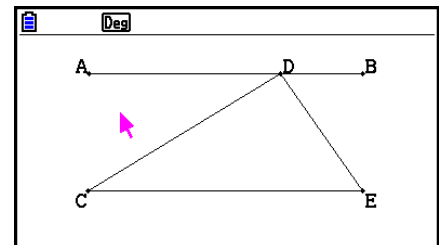

2. Select line segment AB and point D, and then perform the following operation:



**[F6]** (Animate) – 1: Add Animation.

- This will add an animation effect that causes point D to move along line segment AB.

3. Here we will generate an animation table for the length of line segment CD, so first select line segment CD.

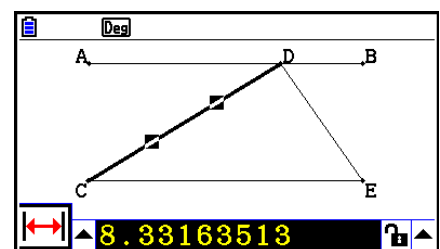
4. Press **[VARS]** to display the measurement box.



- If the  icon does not appear on the left edge of the screen, highlight the up arrow to the left of the measurement box and then press **[EXE]**. On the icon palette that appears, select the  icon.

5. Press  to highlight the up arrow button on the right side of the measurement box and then press **[EXE]**.

- This will display a menu.

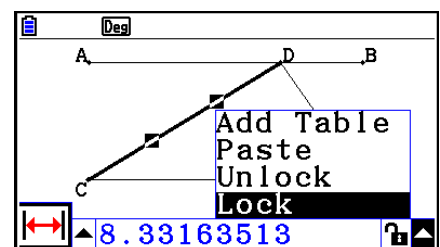

6. Use  $\blacktriangle$  to move the highlighting to [Add Table] and then press  $\boxed{\text{EXE}}$ .

- This will display an animation table that shows the length of line segment CD at each step of the animation in a column labeled "Length".

| Length |
|--------|
| 4.34   |
| 4.3752 |
| 4.4744 |
| 4.6334 |
| 4.8463 |
| 5.1066 |

STORE DELETE

7. Press  $\boxed{\text{EXIT}}$  to close the animation table screen.

8. Press  $\boxed{\text{EXIT}}$  again to make the drawing screen active.

9. Select sides CD, DE, and CE of the triangle.

10. Press  $\boxed{\text{VARS}}$  to display the measurement box.

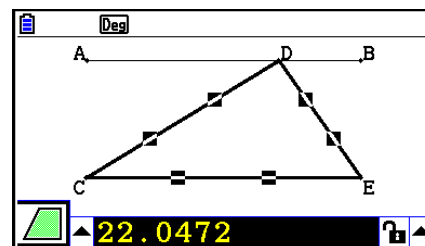

- If the  $\triangle$  icon does not appear on the left edge of the screen, highlight the up arrow to the left of the measurement box and then press  $\boxed{\text{EXE}}$ . On the icon palette that appears, select the  $\triangle$  icon.

11. Perform steps 5 through 6 above.

- Now when the animation table appears, it will include the "Length" column we created in step 6, long with a new "Area" column, which contains the area of triangle CDE at each step of the animation.

| Length | Area   |
|--------|--------|
| 4.34   | 22.047 |
| 4.3752 | 22.047 |
| 4.4744 | 22.047 |
| 4.6334 | 22.047 |
| 4.8463 | 22.047 |
| 5.1066 | 22.047 |

STORE DELETE

- As can be seen here, the area of triangle CDE does not change as point D moves along line segment AB, which is parallel to the base (CE) of the triangle.

12. To exit the animation table screen, press  $\boxed{\text{EXIT}}$ .

13. To close the measurement box, press  $\boxed{\text{EXIT}}$  twice.

### Note

- You can add up to 26 columns to the animation table.
- In place of steps 4 through 6 in the above procedure, you can use either of the following operations to add a column to the animation table:  $\boxed{\text{F6}}$  (Animate) – 7: Add Table or  $\boxed{\text{SHIFT}} \boxed{1}$ .



---

### • To display the animation table

To display the animation table you generated with the procedure under “To add columns to the animation table”, perform the following operation: **F6**(Animate) – 8:Display Table.

---

### • To save an animation table column to a list

1. Display the animation table.
2. Use **◀** and **▶** to move the highlighting to the column you want to save as list data.

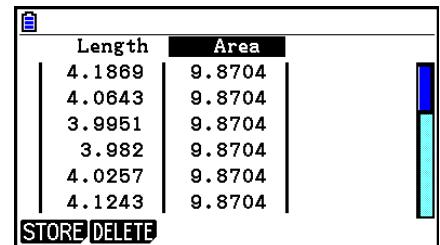

| Length | Area   |
|--------|--------|
| 4.1869 | 9.8704 |
| 4.0643 | 9.8704 |
| 3.9951 | 9.8704 |
| 3.982  | 9.8704 |
| 4.0257 | 9.8704 |
| 4.1243 | 9.8704 |

STORE DELETE

3. Press **F1**(STORE) **F1**(LIST).
    - This displays a dialog box for specifying the number of the list where you want to save the column.
  4. Input the list number as an integer from 1 to 26 and then press **EXE**.
    - For details about list data, see “Chapter 3 List Function”.
- 

### • To save an entire animation table as spreadsheet data

1. Display the animation table.
  2. Press **F1**(STORE) **F2**(S-SHT).
    - This displays a dialog box for inputting the spreadsheet file name.
  3. Input up to 8 characters for the file name and then press **EXE**.
    - For details about spreadsheet data, see “Chapter 9 Spreadsheet”.
- 

### • To delete a particular column from an animation table

1. Display the animation table.
  2. Use **◀** and **▶** to move the highlighting to the column you want to delete.
  3. Press **F2**(DELETE) **F1**(DELETE).
- 

### • To delete all of the columns from an animation table

1. Display the animation table.
2. Press **F2**(DELETE) **F2**(DEL-ALL).
  - This causes a confirmation dialog box to appear.
3. Press **F1**(Yes) to delete the selected file or **F6**(No) to cancel the delete operation.

# Chapter 15 Picture Plot

## Note

fx-CG20 AU Users: Install the Picture Plot add-in application.

Picture Plot is an application that lets you plot points (that represent coordinates) on a photograph, illustration, or other graphic and perform various types of analysis based on the plotted data (coordinate values).

For example, the photograph below shows the nozzles of a fountain shooting thin streams of water at different angles.



If we view the plane traced by the water of the nozzle closest to us in the photograph as an XY Cartesian coordinate plane, we then will be able to express any point on the path traced by the water as a coordinate (X, Y). The Picture Plot plot function makes it easy to plot points on a photograph such as this or some other image, and extract the coordinate values of the plots.

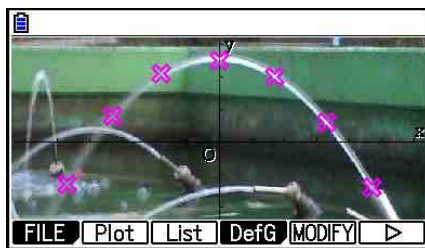

Plotting points

|   | X   | Y    | T |
|---|-----|------|---|
| 1 | 4.7 | -1.4 | 0 |
| 2 | 3.3 | 0.6  | 1 |
| 3 | 1.7 | 2    | 2 |
| 4 | 0   | 2.5  | 3 |

Coordinates (plot list screen)

You can use the plots to perform the following types of operations.

- Register and graph a  $Y=f(x)$  form equation and overlay it on a photograph and plot. You also can use the graph Modify function (page 5-36) to adjust the coefficient values of the expression and find a function that lines up better with the plots.
- Perform regression calculation based on the plotted coordinate values and draw a regression graph that overlays the plots. This makes it possible to produce the mathematical expression and graph of a path of movement.

- Add time values (T) to the coordinate values (X, Y) and plot points on the T-X plane or T-Y plane. This makes it possible to produce the mathematical expressions and graphs of the correlation between horizontal direction movement and time, and the correlation between vertical direction movement and time.

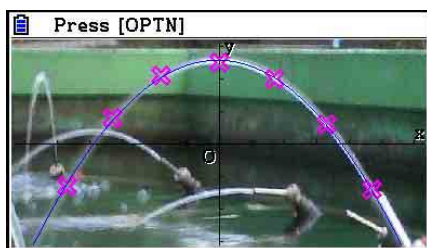

Regression graph

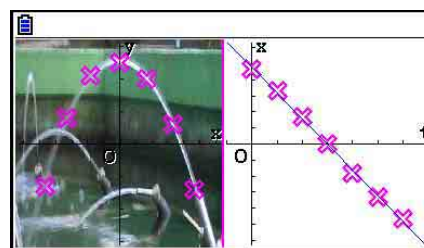

T-X regression graph  
(left side)

During full-screen display of an X-Y coordinate graph, SKETCH and G-SOLVE operations can be used the same way they are in the **Graph** mode.

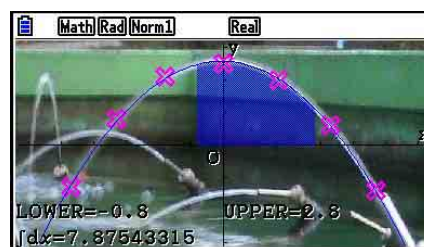
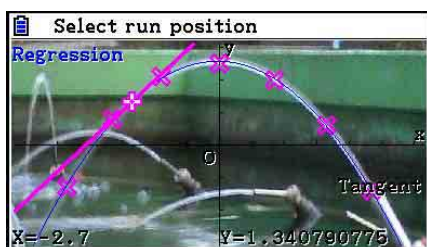

## Picture Plot Specific Setup Items

The items described below are Picture Plot specific Setup screen items that appear only after you press **[SHIFT] [MENU] (SET UP)**.

~~~~~ indicates default setting.

• Axtans Wind

- **{Auto}**/**{Manual}** ... Specifies {auto link left-side (X-Y coordinate system) settings}/ {do not link to left-side (X-Y coordinate system) settings} with the Y-axis or X-axis V-Window setting of the right side (T-Y or T-X coordinate system) of the AXTRANS screen.

• Plot Color

- **{Black}**/**{Blue}**/**{Red}**/**{Magenta}**/**{Green}**/**{Cyan}**/**{Yellow}** ... Specifies a color for plots.

• Plot Type

- **{□}**/**{⊗}**/**{■}** ... Specifies the plot figure.

• Sketch Color

- **{Black}**/**{Blue}**/**{Red}**/**{Magenta}**/**{Green}**/**{Cyan}**/**{Yellow}** ... Specifies a draw color for the Sketch function.

1. Picture Plot Function Menus

■ File List Screen Function Menu

- **{OPEN}** ... Opens a g3p/g3b file or folder.
- **{DELETE}** ... Deletes a g3p/g3b file.
- **{SEARCH}** ... Searches for a g3p/g3b file.
- **{DETAIL}** ... Displays the file DETAIL screen (page 11-6).

■ Picture Plot Screen Function Menu

- **{FILE}** ... Displays the following submenu.
 - **{OPEN}** ... Opens the file list.
 - **{SAVE}** ... Saves the currently open file and overwrites its previously save version (if any).
 - **{SAVE • AS}** ... Saves the currently open file under a new name (Save As).
- **{Plot}** ... Enters the plot mode (for plotting points on the screen).
- **{List}** ... Displays a plot coordinate value list (Plot List screen).
 - For information about Plot List function menu items, see “Plot List Function Menu” (page 15-4).
- **{DefG}** ... Displays a screen for registering graph expressions.
- **{MODIFY}** ... Enters the Modify mode (page 5-36).
- **{AXTRNS}** ... Displays the following submenu.
 - **{T-Y}/{T-X}** ... Splits the screen in half (left and right) and specifies {horizontal axis = T, vertical axis = Y}/{horizontal axis = T, vertical axis = X} for the right side.
- **{REG}** ... Displays a submenu (same as the one on page 6-24) for executing regression calculation based on plots.
- **{EDIT}** ... Enters the plot editing mode (only when plots are on the display).
- **{DELETE}** ... Deletes all plots (only when plots are on the display).
- **{PLAY}** ... When the currently open image is a g3b file, sequentially displays the image in the file.
 - **{Auto}** ... Sequentially displays all of the images in a g3b file three times automatically.
 - **{Manual}** ... Allows manual display of the images in a g3b file using ◀ (back) and ▶ (forward).
- **{PICTURE}** ... Displays the following submenu.
 - **{1~20}** ... Saves the current screen as an image in Picture Memory.
 - **{SAVE • AS}** ... Saves the current screen as an image under a name specified by you.
- **{PAN}** ... Enters the Pan mode (page 5-10).
- **{Fadel/O}** ... Adjusts the lightness of an image (page 15-12).

■ Plot List Function Menu

- **{AXTRNS}** ... Same as {AXTRNS} under “Picture Plot Screen Function Menu”.
- **{EDIT}** ... Selects to edit the currently highlighted value on the plot list.
- **{DEL • BTM}** ... Deletes the last line of data on the plot list.
- **{DEL-ALL}** ... Deletes all of the data on the plot list.
- **{SET}** ... Selects to configure the time (T) value (page 15-15).
- **{JUMP}** ... Displays the following submenu.
 - **{TOP}/{BOTTOM}** ... {jump to the top line}/{jump to the bottom line}
- **{Plot}** ... Exits the plot list screen and enters the plot mode.
- **{REG}** ... Same as {REG} under “Picture Plot Screen Function Menu”.
- **{STORE}** ... Saves the specified Plot List column (X or Y) to list memory.
- **{RECALL}** ... Recalls list memory data to the Plot List X-column or Y-column.

■ Plot Mode Function Menu

- **{PICTURE}** ... Same as {PICTURE} under “Picture Plot Screen Function Menu”.
- **{UNDO}** ... Deletes the last point plotted. Executing {UNDO} again will plot the deleted point.
- **{EDIT}** ... Same as {EDIT} under “Picture Plot Screen Function Menu”.

■ AXTRANS Screen Function Menu

- **{Switch}** ... Switches the display mode of the left side (X-Y coordinate system) of the AXTRANS screen.
- **{Cutout}** ... Specifies the trimming range of the left side (X-Y coordinate system) of the AXTRANS screen.
- **{List}** ... Returns to the plot list screen.
- **{REG}** ... Displays a submenu (same as the one on page 6-24) for executing regression calculation based on plots on the right side (T-Y or T-X coordinate system) of the AXTRANS screen.
- **{P-LINK}** ... Causes plots on the left side and right side of the AXTRANS screen that correspond to each other to flash.

2. Managing Picture Plot Files

Picture Plot requires the use of a background image file. The following types of image files can be opened by Picture Plot.

g3p file ... A file that contains a single image.

g3b file ... A file that contains multiple images.

You can use an image file that is already built into the calculator, or you can use CASIO original contents you download from <http://edu.casio.com>.

■ Starting a Picture Plot Operation

A Picture Plot operation is started by entering the **Picture Plot** mode and opening an image file (g3p or g3b).

Note

Opening an image file is required when you enter the **Picture Plot** mode for the first time after purchasing or resetting the calculator. After that, the image file you last opened will be opened automatically whenever you enter the **Picture Plot** mode. After opening an image file, you do not need to do so again unless you want to change to another image file or reset the calculator.

● To open a file

1. From the Main Menu, enter the **Picture Plot** mode.
 - This displays the file list screen.
 - If the file you opened the last time you used the **Picture Plot** mode is displayed (or if the Picture Plot screen is currently displayed), press **[OPTN] [F1] (FILE) [F1] (OPEN)** to display the file list screen.
2. Use **▲** and **▼** to highlight the file you want to open, and then press **[F1] (OPEN)** or **[EXE]**.

■ Saving a File

Plotting points on the Picture Plot screen and saving the file will cause the Picture Plot plot data to be added to the image file (g3p or g3b). This does not affect the image data of the original image file and the file name extension remains the same as what it was before the Picture Plot data was added. This means that even if you add Picture Plot data to an image file, you will be able to use that file in other modes. Note, however, that the plots will not be displayed if you open such an image file in another mode. Also using an image file in another mode does not affect its Picture Plot data.

• Picture Plot Settings Saved to Image Files

- Picture Plot settings that can be changed on the Setup screen are divided into two groups: settings that are saved in the image file and settings that are saved by the calculator.

| Item name | Settings saved to the image file | Settings saved by the calculator |
|--------------|----------------------------------|----------------------------------|
| Axtrans Wind | <input type="radio"/> *1 | |
| Graph Func | | <input type="radio"/> |
| Plot Color | <input type="radio"/> *1 | |
| Plot Type | <input type="radio"/> *1 | |
| Sketch Color | <input type="radio"/> *1 | |
| Sketch Line | <input type="radio"/> *2 | |
| Angle | | <input type="radio"/> |
| Complex Mode | | <input type="radio"/> |
| Coord | | <input type="radio"/> |
| Grid | <input type="radio"/> *2 | |
| Axes | <input type="radio"/> *2 | |
| Label | <input type="radio"/> *2 | |
| Display | | <input type="radio"/> |

*1 Picture Plot specific setup item

*2 Common setting in all modes. If you enter the **Picture Plot** mode after changing these settings in another mode, the setting of the file that was opened the last time you were in the **Picture Plot** mode will be recalled.

- For V-Window settings, the settings stored with a file will be recalled whenever the file is opened in the **Picture Plot** mode. This means that if you change V-Window settings in another mode and then return to the **Picture Plot** mode, the V-Window settings will revert to the settings for the file that is currently opened in the **Picture Plot** mode. If you go from the **Picture Plot** mode to another mode, the Picture Plot V-Window settings are retained. Settings do not change in accordance with the mode being entered.

• To save a file

While the Picture Plot screen is displayed, press **[OPTN] [F1] (FILE) [F2] (SAVE)**. This will save the file you are editing by replacing the currently stored version (if any).

• To save a file under a different name

1. While the Picture Plot screen is displayed, press **OPTN** **F1** (FILE) **F3** (SAVE • AS).
 - This displays a folder selection screen.
2. Specify the folder you want.
 - Highlight ROOT to save the file to the root directory.
 - To save the file in a specific folder, use **▲** and **▼** to move the highlighting to the desired folder and then press **F1** (OPEN).
3. Press **F1** (SAVE • AS).
4. On the File Name dialog box that appears, enter a name up to eight characters long and then press **EXE**.

3. Using the Plot Function

You can plot points on the screen, overlay them with a graph of an expression in the form $Y=f(x)$, and draw a regression graph that approximates the plots.

■ Plotting Points

• To plot points on the screen

1. Enter the **Picture Plot** mode and then open a g3p or g3b file.
 - This displays the Picture Plot screen.
 - For information about how to open a file, see “To open a file” (page 15-5).

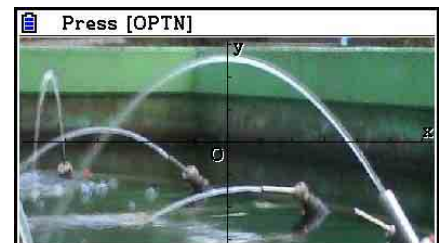

2. Press **OPTN** **F2** (Plot) to enter the Plot mode.
 - A pointer will appear in the center of the screen.
3. Use the cursor keys (or number keys) to move the pointer to the location of the point you want to plot and then press **EXE**.
 - This plots a point at the current pointer location.
 - If the currently open file is a g3b file, plotting a point will switch to the next image in the file. For details, see “Plotting Points in a g3b File” (page 15-8).
 - To delete the last point you plotted, press **OPTN** **F2** (UNDO).
 - For information about using the number keys to move the pointer to a particular location, see “To make the pointer jump to a particular location” (page 15-8).

4. Repeat step 3 as many times as required to plot all of the points you want.

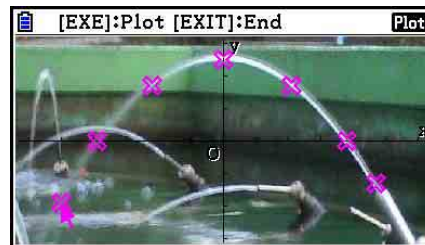

- Here, you could press **[OPTN] [F3]** (EDIT), select a plot, and move it to another location. For details, see “To move a plot” (page 15-9).
 - You can plot up to 50 points in the case of a g3p file. For a g3b file, you can plot one point for each of the images contained in the file.
5. After you are finished plotting all of the points you want, press **[EXIT]** or **[SHIFT] [EXIT]** (QUIT).

• To make the pointer jump to a particular location

In the Plot mode, pressing a number key (**[1]** to **[9]**) will cause the pointer to jump to the corresponding section of the screen as shown below.

| | | |
|------------|------------|------------|
| [7] | [8] | [9] |
| [4] | [5] | [6] |
| [1] | [2] | [3] |

• Plotting Points in a g3b File

A g3b file is a special Picture Plot file that can contain up to 30 images in a single file.

- Opening a g3b file with Picture Plot and plotting a point will switch to the next sequential image in the file.

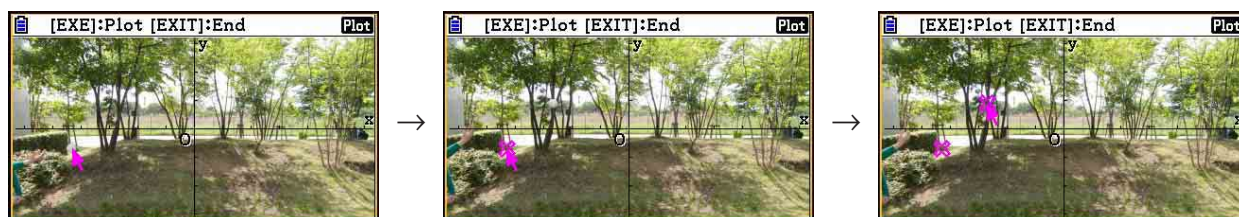

- To view the images contained in a g3b file, press **[OPTN] [F6] (>)** **[F5]** (PLAY) and then perform one of the playback operations described below.

- Press **[F1]** (Auto). This sequentially displays all of the images in the file three times automatically.
- Press **[F2]** (Manual). Use **[◀]** and **[▶]** to scroll the images in the file.

Press **[EXIT]** to return to the screen that was displayed before you pressed **[OPTN] [F6] (>)** **[F5]** (PLAY).

- g3b files can be opened in the **Picture Plot** mode only.

• To move a plot

1. While the Picture Plot screen is displayed, press **[OPTN] [F6] (>) [F3] (EDIT)**.
 - You also could press **[OPTN] [F2] (Plot) [OPTN] [F3] (EDIT)** instead.
 - This enters the plot editing mode with the pointer located at the first point that was plotted on the image.

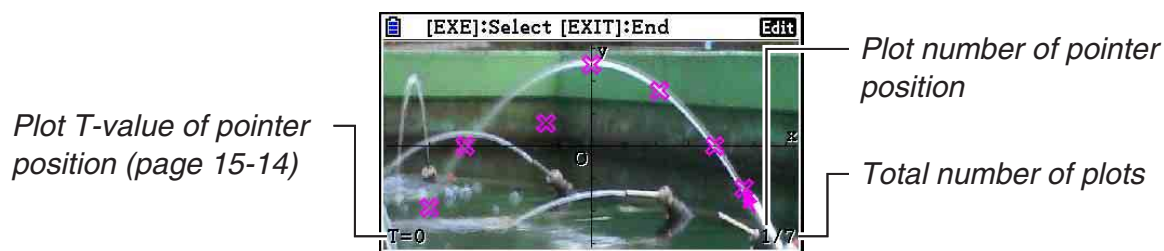

2. Use **[▶]** and **[◀]** to move the pointer to the plot you want to move and then press **[EXE]**.
 - This selects the plot, causing it to flash.
3. Use the cursor keys (or number keys) to move the pointer to the location to which you want to move the plot and then press **[EXE]**.
 - This will move the plot. The pointer will move to the next sequential plot, when there is one.

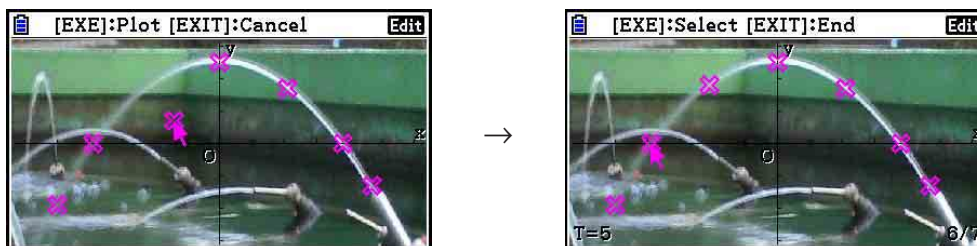

- If you want to move another plot, repeat steps 2 and 3.
4. After you are finished moving all of the plots you want, press **[EXIT]** or **[SHIFT] [EXIT] (QUIT)**.

• To change the color of all the plots

Either of the following operations can be used to change the color of all the plots currently on the screen.

- On the Setup screen, change the “Plot Color” setting.
- While the Picture Plot screen is displayed, press **[SHIFT] [5] (FORMAT)** to display the FORMAT dialog box, and then change the color setting.

Changing the color using the FORMAT dialog box also changes the Setup screen’s “Plot Color” setting. The color you change to is also reflected in the text color on the plot list screen.

• To delete all plots

Press **OPTN** **F6** (\triangleright) **F4** (DELETE), and a confirmation dialog box will appear. Press **F1** (Yes) to delete all of the plots. To cancel the delete operation, press **F6** (No) instead.

Note

- In addition to using the plot list screen to delete all plots, you also can sequentially delete plots one-by-one, starting from the last point plotted. See “Deleting the Last Plot Data Line” (page 15-14).

■ Inputting an Expression of the Form $Y=f(x)$ and Graphing It

You can draw a graph based on an expression with the form $Y=f(x)$ on the Picture Plot screen. From the Picture Plot screen, press **OPTN** **F4** (DefG) to display the graph relation list screen. From there, operations are identical to those in the **Graph** mode.

Note

- The data on the graph relation list screen is shared with the **Graph** mode. Note, however, that only $Y=$ type graphs can be used in the **Picture Plot** mode. Because of this, calling up the graph relation list screen from the **Picture Plot** mode will display a “Y” ($Y=$ type) item for function menu key **F3**. Also note that the **F5** (MODIFY) function menu item is not displayed on the graph relation list screen. The Modify function can be executed from the Picture Plot screen.
- $Y=$ type expressions on the graph relation list screen that include variables can be modified by pressing **OPTN** **F5** (MODIFY) while the Picture Plot screen is displayed. For details about this operation, see “Modifying a Graph” (page 5-36).

■ Using Regression Graphs

You can perform regression calculation based on plotted coordinate values and draw a regression graph.

• To draw a regression graph overlaid on plots

1. Perform the procedure under “To plot points on the screen” (page 15-7).
2. Press **OPTN** **F6** (\triangleright) **F2** (REG).

- This displays the regression calculation type function menu.

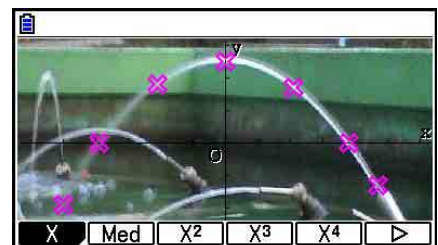

3. Press the function key that corresponds to the type of regression calculation*¹ you want to perform.

- To perform quadratic regression, for example, press **F3** (X^2). This performs the regression calculation and displays the results.*²

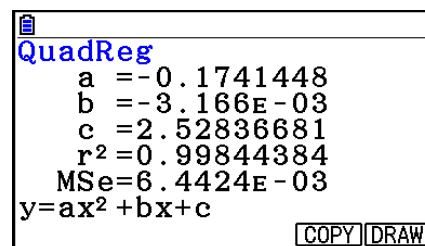

- You can press **F5** (COPY) here to copy the obtained regression formula to the graph relation list screen. See “Inputting an Expression of the Form $Y=f(x)$ and Graphing It” (page 15-10) for more information.

4. To draw a regression graph, press **F6** (DRAW).

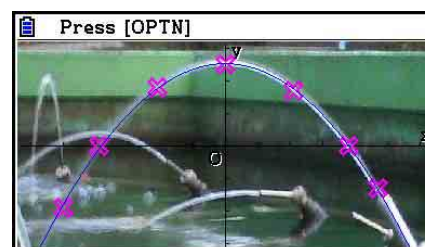

*¹ For information about regression calculation types, see “Selecting the Regression Type” (page 6-16).

*² For information about the meanings of the values that appear on this screen, see “Displaying Regression Calculation Results” (page 6-17) and the regression graph explanations on pages 6-17 through 6-21.

Note

- Besides regression graphs, you also can specify your own expressions and graph them. See “Inputting an Expression of the Form $Y=f(x)$ and Graphing It” (page 15-10).

• Scrolling and Panning a Plot or Graph Screen

On the Picture Plot screen, you can use the cursor keys to scroll the XY-coordinate axes up, down, left, and right. Note that the background image is fixed and does not scroll.

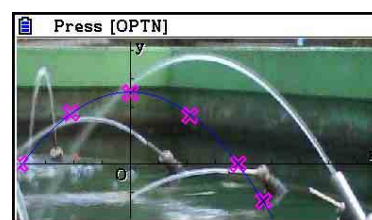
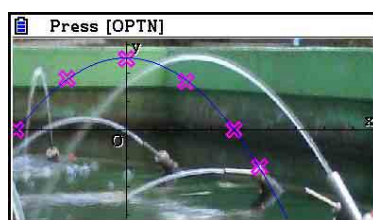
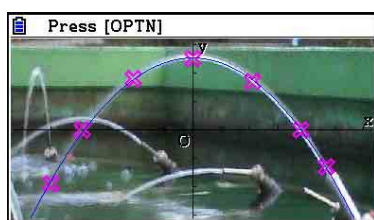

You also can press **OPTN** **F6** (\triangleright) **F5** (PAN) and pan (grab-and-drag) the XY-coordinate axes. The pan operation is the same as that in the **Graph** mode (page 5-10).

• **To maneuver between the Picture Plot screen, AXTRANS screen, and plot list screen**

Once you display the plot list screen and AXTRANS screen (page 15-14), each press of **[SHIFT] [F6] (G↔T)** cycles between the Picture Plot screen, AXTRANS screen, and plot list screen.

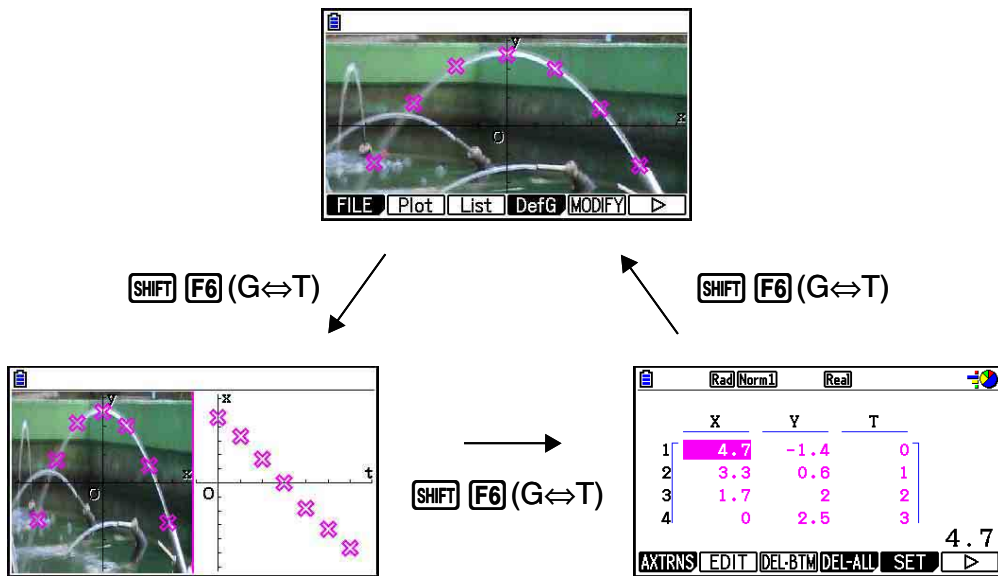

■ **Adjusting the Lightness (Fade I/O) of an Image**

You can adjust the lightness of an image within a range of 0% (as-is) to 100% (not displayed). A higher setting value makes the image lighter, and a setting of 100% displays all white.

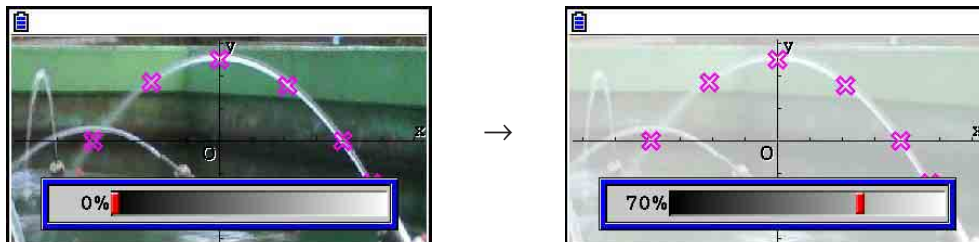

You can adjust the lightness for optimum viewing of plots and graphs.

- Note that the lightness setting can be adjusted only when the image is a 16-bit image data.
- After you adjust the lightness level, the setting is stored in the image file when you perform either of the following operations: **[OPTN] [F1] (FILE) [F2] (SAVE)** or **[F3] (SAVE • AS)**.

• **To adjust the lightness (Fade I/O) of an image**

1. While the Picture Plot screen is displayed, press **[OPTN] [F6] (▷) [F6] (▷) [F3] (Fadel/O)**.

- This causes a slider for adjusting image lightness to appear on the display.

2. Use **◀** and **▶** to adjust the lightness value.

- You can also input values directly, if you want. To specify a lightness value of 20%, for example, press **[2] [0] [EXE]**.

3. After the setting is the way you want, press **[EXE]**.

4. Using the Plot List

Each plot on the Picture Plot screen has coordinate value data. You can use the plot list to display and edit these coordinates.

■ Displaying Coordinate Values of Plots (Plot List)

You can use the procedures in this section to display a list of plot coordinates (X, Y), and use the list to edit values, delete plot data, and change plot colors. You also can specify a time value (T) for each plot and draw a T-X or T-Y graph (AXTRANS) function.

● To edit plot coordinate values

1. While the Picture Plot screen is displayed, press **[OPTN]** **[F3]** (List) to display the plot list screen.

| | X | Y | T |
|---|-----|------|---|
| 1 | 4.7 | -1.4 | 0 |
| 2 | 3.3 | 0.6 | 1 |
| 3 | 1.7 | 2 | 2 |
| 4 | 0 | 2.5 | 3 |

4.7

AXTRNS EDIT DEL-BTM DEL-ALL SET ▶

- The X and Y values of the plot list screen show plot coordinates. The T-value indicates time. (For more information about T-values, see “Displaying Plots on T-Y Coordinates and T-X Coordinates (AXTRANS Screen)” on page 15-14.) On this screen you can edit the X and Y values only.
2. Use the cursor keys to move the highlighting to the X-column or Y-column value you want to edit and then press **[F2]** (EDIT).
 3. Edit the values and then press **[EXE]**.
 - If you want to edit other values, repeat steps 2 and 3.
 - To return to the Picture Plot screen, press **[EXIT]** or **[SHIFT]** **[EXIT]** (QUIT).
 - Changing a value cause the change to be reflected by the corresponding plot on the Picture Plot screen.

Note

- While the plot list screen is displayed, you can use **[F6]** (▶) **[F4]** (STORE) to store list data on the plot list to list memory and **[F6]** (▶) **[F5]** (RECALL) to recall plot list data from list memory. Note, however, that both the store and recall operations ignore any color information associated with list data.

• Deleting the Last Plot Data Line

Perform one of the following operations, depending on the type of cell that is currently highlighted.

- If the X-value or Y-value of the last line of the plot list screen is selected, press **F3** (DEL • BTM) once to delete the last line of plot data.
- If the X-value or Y-value of any line besides the last line of the plot list screen is selected, press **F3** (DEL • BTM) once to move the highlighting to the last line and then press **F3** (DEL • BTM) again to delete the last line of plot data.

• To delete all plots

Press **F4** (DEL-ALL), and a confirmation dialog box will appear. Press **F1** (Yes) to delete all of the plots. To cancel the delete operation, press **F6** (No) instead.

• To return to the Picture Plot screen from the plot list screen

Press **EXIT**, **SHIFT** **EXIT** (QUIT), or **SHIFT** **F6** (G \leftrightarrow T).

■ Displaying Plots on T-Y Coordinates and T-X Coordinates (AXTRANS Screen)

As can be seen on the plot list screen, the data for each plot includes X and Y-coordinates, as well as a time value T.

On the Picture Plot screen each plot is normally displayed as coordinates (X, Y) on an X-Y plane, but time value T can be used to display plots as coordinates (T, Y) on a T-Y plane or as coordinates (T, X) on a T-X plane.

- Under initial default settings, time values are 0, 1, 2, and so on (arithmetic progression with a start value of 0 and a step value of 1), in accordance with the sequence that the points are plotted. You can change the T value assigned to each plot by changing the start value and step value.
- T-Y coordinate plots and T-X coordinate plots are displayed on a special screen called the AXTRANS screen. The AXTRANS screen simultaneously displays the X-Y coordinate plots and the T-Y or T-X coordinate plots as shown in the example below.

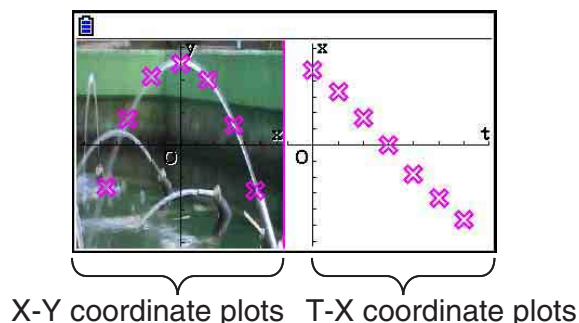

• To configure the time (T) value

1. While the plot list screen is displayed, press **[F5]** (SET).

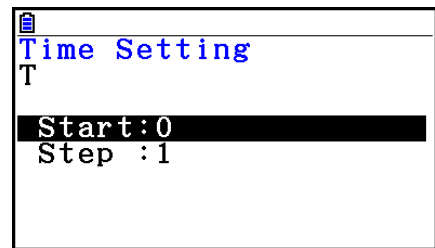

2. On the screen that appears, specify the start value and step value.

- If you want to specify a start value of 1 and a step of 1.5, for example, press **[1]** **[EXE]** **[1]** **[.]** **[5]** **[EXE]**.

3. After the settings are the way you want, press **[EXE]** (or **[EXIT]**).

- This returns to the plot list screen, where you can check whether the T-value has changed as you intended.

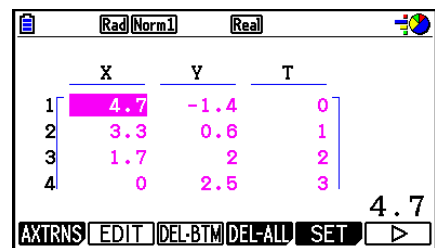

Note

The following are the ranges for the start value and the step value.

$$-1.0E+10 < \text{Start} < 1.0E+10$$

$$0 < \text{Step} < 1.0E+10$$

• To display plots on T-Y coordinates or T-X coordinates

1. While the plot list screen is displayed, press **[F1]** (AXTRNS). From the Picture Plot screen, you also could press **[OPTN]** **[F6]** (\triangleright) **[F1]** (AXTRNS).



2. Depending on the coordinate system you want to use to display the plots, press **[F1]** (T-Y) or **[F2]** (T-X).

- This displays the AXTRANS screen, which shows the X-Y coordinate system plots on the left and the T-Y or T-X coordinate system plots on the right.

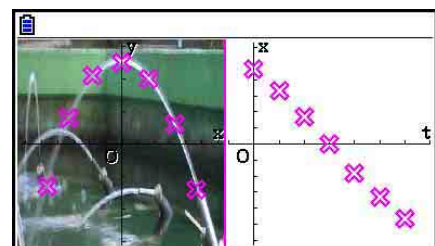

Note

- While the AXTRANS screen is displayed, the “Grid” setting on the Setup screen is always “Off”, while the “Label” setting is always “On”. For the “Axes” setting, you can select “On” or “Scale” only. If you try to select “Off” for this setting, it will change back to “On” automatically.
- As soon as the AXTRANS screen is displayed, the right screen T-axis V-Window is always configured automatically, regardless of the current “Axtrans Wind” setup.
- Pressing **[OPTN]** while this screen is shown will display a function menu you can use to perform the following operations.

| To do this: | Press this key: | And then perform the procedure located here: |
|----------------------------------------------------------------------------------------------------------|----------------------|---------------------------------------------------------------------------------------------------------------------------|
| Change the display mode of the left-side screen | [F1] (Switch) | “To switch the display mode of the left side (X-Y coordinate system) of the AXTRANS screen” below |
| Go to the plot list screen | [F3] (List) | — |
| Draw a regression graph overlaid on the plots in the right-side screen | [F4] (REG) | From step 3 under “To draw a regression graph overlaid on plots” (page 15-10) |
| Cause plots on the left side and right side of the AXTRANS screen that correspond to each other to flash | [F5] (P-LINK) | “To make plots on the left side and right side of the AXTRANS screen that correspond to each other to flash” (page 15-17) |

3. To return to the plot list screen, press **[EXIT]**.

• To switch the display mode of the left side (X-Y coordinate system) of the AXTRANS screen

1. While the AXTRANS screen is displayed, press **[OPTN]** to display the function menu.
2. Press **[F1]** (Switch).
 - Each press of **[F1]** (Switch) cycles the left-side display mode in the sequence shown below.

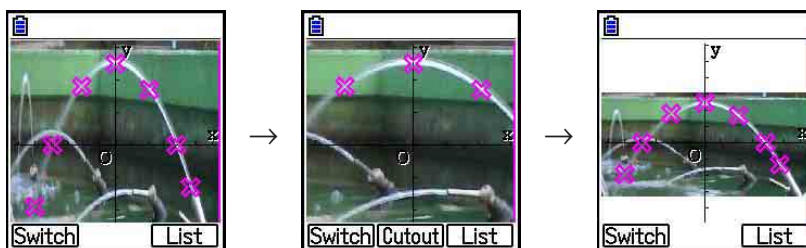

- (1) Full screen with horizontal squeeze
- (2) Cut off screen (no squeeze)

(3) Compressed screen, maintaining aspect ratio

- When (2) (no squeeze) is selected as the display mode, you can specify what part of the screen is cut off. To do so, press **F2** (Cutout) and then use the **◀** and **▶** keys to move the boundary so it encloses the part of the screen you want to display. Finally, press **EXE**.

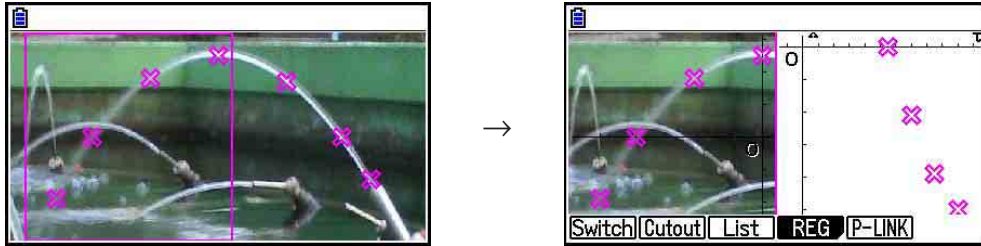

3. When the display mode is the way you want, press **EXIT**.

• **To make plots on the left side and right side of the AXTRANS screen that correspond to each other to flash**

1. While the AXTRANS screen is on the display, press **OPTN F5** (P-LINK).

- This will cause the plots on the left-side (X-Y coordinates) and right-side (T-X coordinates) that correspond to the first line of data (the first plots) to flash.

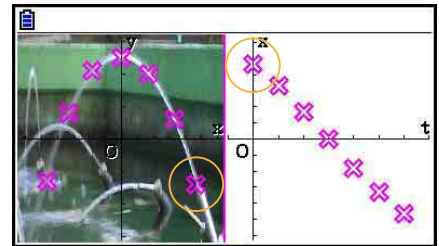

- Use **◀** and **▶** to move the flashing back and forth between plots. This feature is useful to determine how the plots on either side of the screen correspond to each other.

2. To stop the flashing, press **EXIT**.

• **To return to the plot list screen from the AXTRANS screen**

Press **EXIT** or **SHIFT F6** (G⇌T).

5. Common Functions with the Graph Mode

On the Picture Plot screen, **SHIFT** **F1** to **F5** function menu items are the same as those in the **Graph** mode. See the pages below for more information.

- **SHIFT** **F1** (TRACE) ... “Reading Coordinates on a Graph Line” (page 5-52)
- **SHIFT** **F2** (ZOOM) ... “Zoom” (page 5-8)
- **SHIFT** **F3** (V-WIN) ... “V-Window (View Window) Settings” (page 5-5)
- **SHIFT** **F4** (SKETCH) ... “Drawing Dots, Lines, and Text on the Graph Screen (Sketch)” (page 5-50)
- **SHIFT** **F5** (G-SOLVE) ... “Analyzing Graphs (G-SOLVE Menu)” (page 5-54)

Note

After you start a trace operation by pressing **SHIFT** **F1** (TRACE), you can change the color of the plot where the trace pointer is currently located. Perform the following steps to change the plot color.

1. While the Picture Plot screen contains plotted points, press **SHIFT** **F1** (TRACE).
 - This causes a trace pointer to appear at the first point that was plotted on the image.
 - If there are both plots and a graph on the Picture Plot screen, pressing **SHIFT** **F1** (TRACE) will cause the trace pointer to appear on the graph first. In this case, use **▲** and **▼** to move the trace pointer between the graph and the plots.
2. Use **▶** and **◀** to move the trace pointer to the plot whose color you want to change.
3. Press **SHIFT** **5** (FORMAT) to display the FORMAT dialog box.
4. Use the cursor keys to move the highlighting to the desired color and then press **EXE**.
 - The color you change to is also reflected in the text color of the corresponding plot data.

Appendix

1. Error Message Table

- General calculation errors

| When you see this message: | It means this: | So you need to do this: |
|-----------------------------------------|-------------------------------------------------------------------------------------------------------------------------------------------------------------------|------------------------------------------------------------------------------------------------------------------------------------------------------------------------------------------------------------------------|
| Syntax ERROR | <ul style="list-style-type: none"> • Illegal syntax • Attempt to input an illegal command | Press EXIT to display the error and make necessary corrections. |
| Ma ERROR | <ul style="list-style-type: none"> • Calculation result that exceeds the calculation range. • Mathematical error (division by zero, etc.) | Check input values and make corrections to ensure that values are within allowable limits. |
| Stack ERROR | Execution of calculations that exceed the capacity of the stack for numeric values or stack for commands. | <ul style="list-style-type: none"> • Simplify the formulas to keep stacks within 10 levels for the numeric values and 26 levels for the commands. • Divide the formula into two or more parts. |
| Input value must be integer. | Attempting to input a non-integer value in a location that requires integer input. | Input an integer value. |
| Input value must be a matrix. | Attempting to input a non-matrix value in a location that requires matrix input. | Input a matrix value. |
| Input value must be a matrix or vector. | Attempt to input a non-matrix or non-vector value in a location where a matrix or vector should be input. | Input a matrix or vector. |
| Input value must be a list. | Attempting to input a non-list value in a location that requires list input. | Input a list value. |
| Input value must be a real number. | Attempting to input a non-real number value in a location that requires real number input. | Input a real number value. |
| Invalid polar form | Attempting to input an imaginary number for polar form ($r\angle\theta$) r or θ . | Check the polar form. |
| Wrong argument size relationship. | The size relationship between two arguments is opposite from what it should be.
Example: $nCr(3,10)$ | Change the values so the size relationship required by the syntax is maintained. |



| When you see this message: | It means this: | So you need to do this: |
|-------------------------------------------------------------|-----------------------------------------------------------------------------------------------------------------------------------------------------------------------------------------------------------------------------------------------------------------------------------------|-----------------------------------------------------------------------------------------------------------------------------------------------|
| Non-Real ERROR | Calculation that produces a complex number when Real is specified for the Complex Mode setting on the Setup screen, even though the argument is a real number. | Change the Complex Mode setting to something other than Real. |
| Can't Simplify | Fraction simplification was attempted using the ►Simp function (page 2-26), but simplification could not be performed using the specified divisor. Example: Specifying a divisor of 3 to simplify the fraction 4/8. | Specify a different divisor or execute ►Simp without specifying any divisor. |
| Can't Solve! Adjust initial value or bounds. Then try again | A Solve calculation could not obtain a solution within the specified range. | <ul style="list-style-type: none"> • Change the specified range. • Correct the input expression. |
| Time Out | A Solve calculation was unable to satisfy convergence conditions. | If you are performing a Solve calculation, try changing to the initial default estimated value. |
| Conversion ERROR | <ul style="list-style-type: none"> • Attempting to use the unit conversion command to convert between two units in different categories. • Executing a conversion calculation using the same command twice in a conversion expression. | In a conversion expression, specify two different commands that are in the same category. |
| Invalid Type | An illegal data type is specified. | Specify valid data. |
| Underflow | When performing a function calculation or an equation calculation, you input an extremely small value for one of the arguments or you input values for multiple arguments that are extremely removed from each other. Example: $\Sigma(X,X,1,2,1E-50)$, $1E99x^2+1E99x+1E-99=0$, etc. | Depending on the calculation contents, the underflow will occur and the calculation will not be performed. Change the value(s) and try again. |

- **List, matrix, and vector calculation errors**

| When you see this message: | It means this: | So you need to do this: |
|------------------------------------|-------------------------------------------------------------------------------------------------------------------------|----------------------------------------------------------------------------------------------------------------------------------------------------------------------------------------------------|
| Invalid List, Matrix or Vector | Incorrect use of a list, matrix, or vector. | Press EXIT to display the error and make necessary corrections. |
| Dimension ERROR | Illegal dimension used during matrix, vector, or list calculations. | Check the matrix, vector, or list dimension. |
| Complex Number in List | List containing complex number used in a calculation or operation for which complex number data is invalid. | Change all data in the list to real numbers. |
| Complex Number in Matrix | Matrix containing complex number used in a calculation or operation for which complex number data is invalid. | Change all data in the matrix to real numbers. |
| Complex Number in Matrix or Vector | Matrix or vector containing complex number used in a calculation or operation for which complex number data is invalid. | Change all data in the matrix or vector to real numbers. |
| Improper Number of Elements | You attempted to create a list, matrix, or vector whose number of elements exceeds the maximum limit. | A list cannot have more than 999 elements, and a matrix cannot exceed 999 rows \times 999 columns. For vector elements, specify within 1 row \times 999 columns or 999 rows \times 1 column. |

- **Equation mode errors**

| When you see this message: | It means this: | So you need to do this: |
|-----------------------------------|--------------------------------------------------------------------|--------------------------------------------------|
| Infinitely Many Solutions | An infinite number of solutions for simultaneous linear equations. | — |
| No Solution | No solution for simultaneous linear equations. | — |
| No Variable | No variable within a Solve equation. | Input a Solve equation that includes a variable. |

• **Graph, Dyna Graph, Table, Recursion, Conic Graphs mode errors**

| When you see this message: | It means this: | So you need to do this: |
|-----------------------------------|---------------------------------------------------------------------------------------------------------------------------------------------------------------------------------------------------------------------------------------------------------------------------------------------------------------------------------------------------------------------------------------------------------|-----------------------------------------------------------------------|
| Range ERROR | V-Window range settings exceeded when a graph is redrawn. | Redraw using the proper settings. |
| No Variable | No variable specified within a graph function being used for Dynamic Graph. | Specify a variable for the graph function. |
| Too Many Variables | Attempting to execute the Modify function using an expression with more than five variables. | Change the expression so it contains no more than five variables. |
| No item is selected | Attempting to draw a graph or create a table while there is no data selected. | Select data and try again. |
| Expression in use | Attempting to copy the expression of a graph while Modify is running to an area where an expression that is being used for graphing is located. | Select a different area and try again. |
| Requires one variable expression. | <ul style="list-style-type: none"> • You attempted to execute a Modify function operation while no expression that contains a variable is selected. • You attempted to execute a Modify operation while multiple expressions containing variables are selected. | Select at least one and only one expression that contains a variable. |
| Invalid graph type | <ul style="list-style-type: none"> • You attempted to execute a Modify operation in the Graph mode while a list graph expression, overwrite graph expression, or inequality is selected. • You attempted to execute a Modify operation in the Table mode while a list graph expression, overwrite graph expression, inequality, or a range of values is selected. | Select a different type of expression and try again. |
| Too Many Sectors | You executed a calculation using G-Solve $\int dx$ - ROOT, $\int dx$ - INTSECT or $\int dx$ - MIXED, but there are 21 or more roots in the range specified by you. | Specify a range that is narrower and try again. |

• **Statistics mode errors**

| When you see this message: | It means this: | So you need to do this: |
|-----------------------------------|-------------------------------------------------------------------------------------------------------------------------------------------------------------------------------------------------------------------------------------------------------------------------------------------------------------------------------------------------------------------------------------------------|----------------------------------------------------------------------------------------------------------------------------------------------------------------------------------------------------------------------------------------------------------------------------------------|
| Condition ERROR | You are attempting to display multiple statistical graphs of different types. | Press F1 (GRAPH) F4 (SELECT) to display the graph On/Off screen, and then select "DrawOn" only for graphs of the same type. |
| Data in use | <ul style="list-style-type: none"> You attempted to execute a regression calculation while the same list specified by "Resid List" (residual list) is specified as calculation data. You attempted to execute a Test, Confidence Interval, or Distribution calculation while the same list specified by "Save Res" (save result list) is specified as calculation data. | <ul style="list-style-type: none"> For "Resid List", specify a list other than the one being used for the regression calculation. For "Save Res", specify a list other than the one being used for the Test, Confidence Interval, or Distribution calculation. |

• **Program errors**

| When you see this message: | It means this: | So you need to do this: |
|-----------------------------------|-----------------------------------------------------------------------------------------------------------------------------------------------------------------|-------------------------------------------------------------------------------------------------------------------------------------------------------------------------------------------------------------------------------------------------------------------------------------------------------------------------------------------------------|
| Go ERROR | <ol style="list-style-type: none"> No corresponding Lbl <i>n</i> for Goto <i>n</i>. No program stored in program area Prog "file name". | <ol style="list-style-type: none"> Correctly input a Lbl <i>n</i> to correspond to the Goto <i>n</i>, or delete the Goto <i>n</i> if not required. Store a program in program area Prog "file name", or delete the Prog "file name" if not required. |
| Nesting ERROR | Nesting of subroutines by Prog "file name" exceeds 10 levels. | <ul style="list-style-type: none"> Ensure that Prog "file name" is not used to return from subroutines to main routine. If used, delete any unnecessary Prog "file name". Trace the subroutine jump destinations and ensure that no jumps are made back to the original program area. Ensure that returns are made correctly. |
| Too many path levels | Specification of more than three path levels in a program. | Specify no more than three path levels. |

• **Spreadsheet mode errors**

| When you see this message: | It means this: | So you need to do this: |
|----------------------------|------------------------------------------------------------------------------------|-----------------------------------------------------------------------|
| Range ERROR | The spreadsheet cell range was exceeded by paste, recall, or other cell operation. | Repeat the procedure taking care that the cell range is not exceeded. |
| Circular ERROR | There is a circular reference (such as “=A1” in cell A1) in the spreadsheet. | Change cell contents to remove the circular references. |

• **eActivity mode errors**

| When you see this message: | It means this: | So you need to do this: |
|---------------------------------|-------------------------------------------------------------------------------------------------------------------------------------------------------------------------------------------------------------------------------------------------------------------------------------------------|-------------------------------------------------------------------------|
| No MEMO | <ul style="list-style-type: none"> • On the eActivity mode file menu screen, pressing F5 (MEMO) while a file that does not include a MEMO is selected. • Attempting to display the MEMO Catalog screen while editing a file that does not include a MEMO. | Perform these operations while a file that includes a MEMO is selected. |
| Only one memo allowed per line. | <ul style="list-style-type: none"> • In the eActivity mode, attempting to append a MEMO to a line that already has a MEMO appended. • In the eActivity mode, attempting to delete the newline code between two lines that both have a MEMO appended. | — |
| Image wrong size for insertion. | In the eActivity mode, you are attempting to insert an image file whose file size is not supported. | Use an image file that is the supported size (page 10-14). |

• **Memory mode errors**

| When you see this message: | It means this: | So you need to do this: |
|-------------------------------------------------|-------------------------------------------------------------------------------------------------------------------------------------------------------------------------------------------|-----------------------------------------------------------------------------------------------------------------------------------------------------------------------------------------------------------------------|
| Memory ERROR | Operation or memory storage operation exceeds remaining memory capacity. | <ul style="list-style-type: none"> • Simplify the data you are trying to store to keep it within the available memory capacity. • Delete no longer needed data to make room for the new data. |
| Folder has over 300 files. Some will be skipped | The number of files in the storage memory folder you are trying to open in the Memory mode exceeds 300. | Use your computer* ¹ to distribute the files among multiple folders so no folder in storage memory contains more than 300 files. |
| Sub-folders in this folder cannot be displayed | In the Memory mode, a level 3 nested storage memory folder is displayed, and it contains a level 4 nested folder. (The level 4 folder will be displayed, but it cannot be opened.) | Use your computer* ¹ to store all files you want to access in the top three folder nesting levels. |
| Too Much Data | The number of data items is too large. | Delete unneeded data. |
| Fragmentation ERROR | Memory must be optimized before any more data can be stored. | Optimize memory. |
| Invalid Name | The file name you input includes invalid characters. | Use the correct characters to input a valid file name. |
| Invalid Type | An illegal data type is specified. | Specify valid data. |
| Storage Memory Full | The storage memory is full. | Delete unneeded data. |
| Data ERROR | A data error occurred. | Check to make sure you are writing correct type of data and try again. |

*¹ For details about using a computer to perform storage memory file and folder operations, see “Transferring Data between the Calculator and a Personal Computer” (page 13-5).

| When you see this message: | It means this: | So you need to do this: |
|----------------------------|---------------------------------------------------------------------------------------------------------------------------|------------------------------------------------------------------------------------------------------------------------------------------------------------------------------------------------------------------------------------------------------------------------------------------------------------------------------------------------------------------------------------------------------------------------------------------------------------------------------------------------------------------------------------------------------------------------------------------------------------------------------------|
| File System ERROR | The calculator memory file system is corrupted or the storage memory format is one that cannot be read by the calculator. | <p>After reading the information under “Important!” below, perform an Initialize All operation as described in “Reset” (page 12-4).</p> <p>Important!
 Performing an Initialize All operation will delete all data in calculator memory, including language data. If you need the data in calculator memory, use the USB cable to connect the calculator to a computer and copy all of the data you want to keep to your computer’s hard disk before performing the Initialize All operation. For more information, see “Performing Data Communication between the Calculator and a Personal Computer” (page 13-3).</p> |

• **Data communication errors**

| When you see this message: | It means this: | So you need to do this: |
|------------------------------------|-----------------------------------------------------------------------------------------------------------------------------------------------------------------------------------------------------------------------------------------------------------------------------------------------------------|--------------------------------------------------------------------------------------------------------------------|
| Complex Number in Data | Data sent from a function of this calculator (matrix, etc.) includes complex number data, but the corresponding function of the receiving calculator does not support data that includes complex numbers.
Example: Attempting to send a matrix containing a complex number in an element to CFX-9850G. | Send data that does not include complex numbers. |
| CSV error in row [A] or column [B] | The imported CSV file included data that cannot be converted. | Use your computer to check the row A, column B data in the file and change it to data that can be converted. |
| USB Connect ERROR | USB cable connection broken during data communication. | Use the USB cable to correctly connect the calculator and computer (or other device). |
| Com ERROR | Problem with cable connection or parameter setting during data communication. | Check to make sure there is nothing wrong with the cable connection, and that parameters are configured correctly. |
| Transmit ERROR | Problem with cable connection or parameter setting during data communication. | Check to make sure there is nothing wrong with the cable connection, and that parameters are configured correctly. |
| Receive ERROR | Problem with cable connection or parameter setting during data communication. | Check to make sure there is nothing wrong with the cable connection, and that parameters are configured correctly. |
| Memory Full | Memory of receiving calculator became full during program data communication. | Delete some data stored in the receiving calculator and try again. |
| Invalid Data Size | Attempting to send data of a size that is not supported by the receiving device. | Make sure the data being sent is of a size that is supported by the receiving device. |
| Invalid Data Number | Attempting to send data with a data number that is not supported by the receiving device. | Specify a data number supported by the receiving device when sending data. |
| Please Reconnect | The connection was dropped for some reason while updating the operating system. | Reconnect and try again. |

• **Geometry mode errors**

| When you see this message: | It means this: | So you need to do this: |
|-------------------------------------------|-----------------------------------------------------------------------------------------------------------------------------------------------------------------------------------------------------------------------------------------------------------------------------------------------------------------------------------------------------------------------------------|-----------------------------------------------------------------------------------------------------------------------|
| First select a segment. | You are attempting to construct a perpendicular bisector without first selecting a line segment. | Select the required object(s) and then try again. |
| First select a line and point. | You are attempting to construct a perpendicular or parallel without first selecting a line segment and point. | |
| First select 2 points or a segment. | You are trying to construct a midpoint without first selecting two points or a line segment. | |
| First select the applicable figure. | <ul style="list-style-type: none"> • You are trying to construct a point of intersection without first selecting two lines. • You are trying to execute an Add Animation or Replace Animation command without first selecting the required object. • You are trying to execute an Add Table command without first selecting the required object. | |
| First select 2 segments. | You are trying to construct an angle bisector without first selecting two line segments. | |
| Too Many Objects!
Work memory cleared. | Work memory became full. | Delete objects you no longer need or open a new file. |
| Invalid Measurement | You are attempting to use the Expression command to input an expression that contains a measurement that does not exist. | Check to make sure that the expression you are inputting contains only measurements that are currently on the screen. |
| Too Many Animations | You are trying to add more than 10 animations. | Use the Edit Animations screen to delete animations you no longer need, or create a new file and add new animations. |
| First select point(s). | You are trying to execute the Trace command without first specifying a trace point. | Specify the trace point and try again. |
| Too Many Trace Points | You are trying to specify more than 10 trace points. | Select only up to 10 trace points. |
| Too Many Rows | You are trying to add more than 26 columns to an animation table. | Delete columns from the animation table that you do not need and try again. |

| When you see this message: | It means this: | So you need to do this: |
|--------------------------------------------------------|------------------------------------------------------------------------------------------------------------------------------------------------------------------------------------------------------------------------------------------------------------------------------------------------------------------------------------------------------------------------------------------------------------------------------|---------------------------------------------------------------------------|
| First configure animation settings. | <ul style="list-style-type: none"> • You are trying to run an animation without first configuring its settings. • You are trying to execute an Add Table command without first configuring animation settings. | Configure animation settings and try again. |
| Cannot Add Animation | <ul style="list-style-type: none"> • The point you selected for an Add Animation or Replace Animation command operation cannot be used in an animation because it is locked, etc. • The point you selected for an Add Animation or Replace Animation command operation cannot be used in an animation because it is already being used in the animation you are configuring or in another animation. | Select a point to which animation can be added and try again. |
| Select the applicable measurement icon. | You are trying to execute the Add Table command without first selecting the appropriate measurement icon. | Select the icon of a measurement that can be added to an animation table. |
| First configure animation settings and create a table. | You tried to execute the Display Table command without generating an animation table. | Generate an animation table first. |
| Create at least one figure with a fill color. | You are attempting to execute a surface area calculation (OPTN (Option) – 7:Area Calc) when there is no figure on the screen with a fill color. | Draw a figure with a fill color and try again. |

• **Picture Plot mode errors**

| When you see this message: | It means this: | So you need to do this: |
|----------------------------|-----------------------------------------------------------------------------------------|-------------------------|
| Too many plots | In the Picture Plot mode, the number of plots exceeds the allowable upper limit. | — |

• **Setup errors**

| When you see this message: | It means this: | So you need to do this: |
|----------------------------|---------------------------------------------------------------------------------------------------------------------------------------------------------------------------------------------------------------------------------------------------------------------------------------------------------------------------------------------------------------------------------------------------------------------------------------------------------------------------------------------------------------------------------------------------------------------------------------------------------------------------------------------------------------------------------------------------------------------------------------------------------------------------------------------------------------------------------------------------------------------|------------------------------------------------------------------------------------------------------------------------------------------------------------------------------------------------------------------------------------------------------------------------------------------------------------------------------------------------------------------------------------------------------------------------------------------------------------------------------------------------------------------------------------------------------------------------------------------------------------------------------|
| Out of Domain | Attempting to input a value that is outside the allowable input range. | Input a value that is within the allowable range. |
| Invalid setting | <ul style="list-style-type: none"> • Input of an improper V-Window value. • Input of an improper value on the range screen and use of that value for execution. • Attempting to create a table with a Step value of 0. • Attempting to input illegal V-Window setting combinations.
Example: $X_{min} = 10$, $X_{max} = 10$ • Attempting to create a table in the Recursion mode when the Start value is greater than or equal to the End value. • The Edit Animations screen is configured with the setting $t_0=t_1$ in the Geometry mode. • Internal calculation generated a mathematical error (division by zero, etc.) when executing a function calculation, or a calculation in the Financial mode or Statistics mode. | <ul style="list-style-type: none"> • Change the V-Window value so it is within range. • Input a proper range value. • Specify a Step value other than 0. • Enter values that have the proper relationship with each other. • Change the value so the Start value is less than the End value. • Configure the Edit Animations screen so t_0 and t_1 are assigned different values for the same animation. • Since the calculation contains one or more values that cannot be calculated, input different values and try again. |
| Out of Range | Calculation result that exceeds the calculator display range. | Change the calculation formula. |

• **Other errors**

| When you see this message: | It means this: | So you need to do this: |
|-----------------------------------|----------------------------------------------------------------------------------------------------------------------------------------------------------------------------------------------------------------------------------------------------------------------------------------------------------|---------------------------------------------------------------------------------------------------------------------------------------------------------------------------------------------------------------------------------------------------------------------------------------|
| No Data | The specified data does not exist. (Occurs when a list or variable that does not contain data is referenced.) | Change the data specification. |
| No File | Attempting to recall a file from Picture Memory (1 through 20) when there is no file located at the applicable Picture Memory number. | Specify a Picture Memory number where a file is stored. |
| Not Enough Elements | <ul style="list-style-type: none"> • The list you specified for a calculation does not contain the number of elements required to perform the calculation. • You attempted to execute a statistical calculation using a list whose elements are all zero for the frequency data. | <ul style="list-style-type: none"> • Check the number of elements required by the calculation you are trying to perform and adjust the number of list elements accordingly. • For frequency data, use a list whose elements contain values greater than zero. |

2. Input Ranges

| Function | Input range for real number solutions | Internal digits | Precision | Notes |
|-------------------------------------------------|---------------------------------------------------------------------------------------------------------------------------------------------------------------|-----------------|-----------------------------------------------------|----------------------------------------------------------------------------------------------------------------------------------------|
| $\sin x$
$\cos x$
$\tan x$ | (DEG) $ x < 9 \times (10^9)^\circ$
(RAD) $ x < 5 \times 10^7 \pi$ rad
(GRA) $ x < 1 \times 10^{10}$ grad | 15 digits | As a rule, precision is ± 1 at the 10th digit.* | However, for $\tan x$:
$ x \neq 90(2n+1)$: DEG
$ x \neq \pi/2(2n+1)$: RAD
$ x \neq 100(2n+1)$: GRA |
| $\sin^{-1}x$
$\cos^{-1}x$ | $ x \leq 1$ | " | " | |
| $\tan^{-1}x$ | $ x < 1 \times 10^{100}$ | " | " | |
| $\sinh x$
$\cosh x$ | $ x \leq 230.9516564$ | " | " | |
| $\tanh x$ | $ x < 1 \times 10^{100}$ | " | " | |
| $\sinh^{-1}x$
$\cosh^{-1}x$
$\tanh^{-1}x$ | $ x < 1 \times 10^{100}$
$1 \leq x < 1 \times 10^{100}$
$ x < 1$ | " | " | |
| $\log x$
$\ln x$ | $1 \times 10^{-99} \leq x < 1 \times 10^{100}$ | " | " | • Complex numbers can be used as arguments. |
| 10^x
e^x | $-1 \times 10^{100} < x < 100$
$-1 \times 10^{100} < x \leq 230.2585092$ | " | " | • Complex numbers can be used as arguments. |
| \sqrt{x}
x^2 | $0 \leq x < 1 \times 10^{100}$
$ x < 1 \times 10^{50}$ | " | " | • Complex numbers can be used as arguments. |
| $1/x$
$\sqrt[3]{x}$ | $ x < 1 \times 10^{100}, x \neq 0$
$ x < 1 \times 10^{100}$ | " | " | • Complex numbers can be used as arguments. |
| $x!$ | $0 \leq x \leq 69$
(x is an integer) | " | " | |
| nPr
nCr | Result $< 1 \times 10^{100}$
n, r (n and r are integers)
$0 \leq r \leq n, n < 1 \times 10^{10}$ | " | " | |
| Pol (x, y) | $\sqrt{x^2 + y^2} < 1 \times 10^{100}$ | " | " | |
| Rec
(r, θ) | $ r < 1 \times 10^{100}$
(DEG) $ \theta < 9 \times (10^9)^\circ$
(RAD) $ \theta < 5 \times 10^7 \pi$ rad
(GRA) $ \theta < 1 \times 10^{10}$ grad | " | " | However, for $\tan \theta$:
$ \theta \neq 90(2n+1)$: DEG
$ \theta \neq \pi/2(2n+1)$: RAD
$ \theta \neq 100(2n+1)$: GRA |

| Function | Input range for real number solutions | Internal digits | Precision | Notes |
|--------------------------------------------------|----------------------------------------------------------------------------------------------------------------------------------------------------------------------------------------------------------------------------------------------|-----------------|-----------------------------------------------------|---------------------------------------------------------------------------------------------|
| $\circ, ', ''$
\leftarrow
$\circ, ', ''$ | $ a , b, c < 1 \times 10^{100}$
$0 \leq b, c$ | 15 digits | As a rule, precision is ± 1 at the 10th digit.* | |
| | $ x < 1 \times 10^{100}$
Sexagesimal display:
$ x < 1 \times 10^7$ | | | |
| $\wedge(x^y)$ | $x > 0$:
$-1 \times 10^{100} < y \log x < 100$
$x = 0$: $y > 0$
$x < 0$: $y = n, \frac{m}{2n+1}$
(m, n are integers)
However;
$-1 \times 10^{100} < y \log x < 100$ | " | " | <ul style="list-style-type: none"> Complex numbers can be used as arguments. |
| $^x\sqrt{y}$ | $y > 0$: $x \neq 0$
$-1 \times 10^{100} < \frac{1}{x} \log y < 100$
$y = 0$: $x > 0$
$y < 0$: $x = 2n+1, \frac{2n+1}{m}$
($m \neq 0$; m, n are integers)
However;
$-1 \times 10^{100} < \frac{1}{x} \log y < 100$ | " | " | <ul style="list-style-type: none"> Complex numbers can be used as arguments. |
| $a^{b/c}$ | Total of integer, numerator and denominator must be within 10 digits (includes division marks). | " | " | |

* For a single calculation, calculation error is ± 1 at the 10th digit. (In the case of exponential display, calculation error is ± 1 at the last significant digit.) Errors are cumulative in the case of consecutive calculations, which can also cause them to become large. (This is also true of internal consecutive calculations that are performed in the case of $\wedge(x^y)$, $^x\sqrt{y}$, $x!$, $^3\sqrt{x}$, nPr , nCr , etc.)

In the vicinity of a function's singular point and point of inflection, errors are cumulative and may become large.

| Function | Input range |
|-------------------------------------------------|----------------------------------------------------------------------------------------------------------------------------------------------------------------------------------------------------------------------------------------------------------------------------------------------------------------------------------------------------------------------------------------------------------------------------|
| Binary, octal, decimal, hexadecimal calculation | Values fall within following ranges after conversion:
DEC: $-2147483648 \leq x \leq 2147483647$
BIN: $1000000000000000 \leq x \leq 1111111111111111$ (negative)
$0 \leq x \leq 1111111111111111$ (0, positive)
OCT: $20000000000 \leq x \leq 37777777777$ (negative)
$0 \leq x \leq 17777777777$ (0, positive)
HEX: $80000000 \leq x \leq FFFFFFFF$ (negative)
$0 \leq x \leq 7FFFFFFF$ (0, positive) |

E-CON3
Application
(English)

Important!

- All explanations in this section assume that you are fully familiar with all calculator and Data Logger (CMA CLAB* or CASIO EA-200) precautions, terminology, and operational procedures.
- The E-CON3 application is designed to get the most out of the measurement functions of the CASIO EA-200 Data Logger. Though it can run on a CMA CLAB Data Logger, CLAB does not have a SONIC port, microphone, or speaker as is equipped on the EA-200. While a calculator is connected to a CLAB Data Logger, attempting to configure E-CON3 application settings and perform measurement using parameters that are not supported by CLAB will cause an error.

* For information about CMA and the CLAB Data Logger, visit <http://cma-science.nl/>.

1. E-CON3 Overview

- From the Main Menu, enter the **E-CON3** mode.

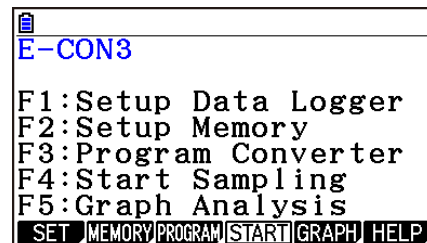

E-CON3 Main Menu

- The **E-CON3** mode provides the functions listed below for simple and more efficient data sampling using a Data Logger.
 - **F1** (SET)Displays a screen for setting up a Data Logger.
 - **F2** (MEMORY)Displays a screen for saving Data Logger setup data under a file name.
 - **F3** (PROGRAM).....Performs program conversion.
 - This function can be used to convert Data Logger setup data configured using E-CON3 to a Data Logger control program that can run on the fx-9860G Series/fx-CG10/fx-CG20/fx-CG20 AU.
 - It also can be used to convert data to a program that can be run on a CFX-9850 Series/fx-7400 Series calculator.
 - **F4** (START)Starts data collection.
 - **F5** (GRAPH)Graphs data sampled by a Data Logger, and provides tools for analyzing graphs. Graph Analysis tools include calculation of periodic frequency, various types of regression, Fourier series calculation, and more.
 - **F6** (HELP)Displays E-CON3 help.
- Pressing the **OPTN** key (Setup Preview) or a cursor key while the E-CON3 main menu is on the screen displays a preview dialog box that shows the contents of the setup in the current setup memory area.

To close the preview dialog box, press **EXIT**.

Note

- For details about setup data and the current setup memory area, see “Using Setup Memory” (page ε-24).

2. Using the Setup Wizard

This section explains how to use the Setup Wizard to configure the Data Logger setup quickly and easily simply by replying to questions as they appear.

■ Setup Wizard Parameters

Setup Wizard lets you make changes to the following three Data Logger basic sampling parameters using an interactive wizard format.

- Sensor (Select Sensor)
- Total Sampling Time
- Sampling Time Unit (Select Unit)

Note the following rules whenever you use the Setup Wizard.

- The EA-200 sampling channel is CH1 or SONIC.
- The CLAB sampling channel is CH1 only.
- The trigger for a Setup Wizard setup is always the **[EXE]** key.

• To configure a Data Logger setup using Setup Wizard

Note

- To terminate Setup Wizard part way through and cancel the setup, press **[SHIFT]** **[EXIT]** (QUIT).

1. Display the E-CON3 main menu (page ε-1).
2. Press **[F1]** (SET) and then **[F1]** (WIZARD).
 - This launches the Setup Wizard and displays the “Select Sensor” screen.
3. Press one of the following function keys to specify the manufacturer of the sensor you are using for measurement: **[F1]** (CASIO), **[F2]** (VERNIER), **[F3]** (CMA).
 - Pressing either key will display the corresponding sensor list.
4. Specify the sensor you want to use.

Use the **[▲]** and **[▼]** cursor keys to move the highlighting to the sensor you want to use, and then press **[EXE]**.

- If the “Input Total Sampling Interval” screen appears, skip to step 6.
- If the sensor you specified has more than one option (more detailed specifications, such as sampling unit, mode, etc.), an option list will appear on the display at this time. If this happens, advance to step 5.

5. Select the options for the sensor you specified in step 4.

Use the ▲ and ▼ cursor keys to move the highlighting to the option you want to select, and then press **EXE**.

- If the “Input Total Sampling Interval” screen appears, advance to step 6.

Important!

When special settings are required by the sensor and/or option you select, other screens other than the “Input Total Sampling Interval” screen will appear on the display. The following shows where you should go to find information about the operations you need to perform for each sensor/option selection.

| If you select this sensor/option: | Go here for more information: |
|----------------------------------------------------------------------|----------------------------------------------------------------------------------------------------------|
| [CASIO] - [Microphone] - [Sound wave & FFT] | “Using Setup Wizard to Configure Settings for FFT (Frequency Characteristics) Data Sampling” on page ε-4 |
| [CASIO] - [Microphone] - [FFT only] | |
| [VERNIER] - [Photogate] - [Gate] or [CMA] - [Photogate] - [Gate] | “To configure a setup for Photogate alone” on page ε-5 |
| [VERNIER] - [Photogate] - [Pulley] or [CMA] - [Photogate] - [Pulley] | “To configure a setup for Photogate and Smart Pulley” on page ε-5 |
| [CASIO] - [Speaker] - [y=f(x)] | “Outputting the Waveform of a Function through the Speaker” on page ε-6 |

6. Use the number input keys to input the total sampling time. Just input a value.

In step 8 of this procedure, you will be able to specify the unit (seconds, minutes, hours, days) of the value you input here.

Note

- With some sensors ([CASIO] - [Microphone] - [Sound wave], etc.) sampling time is limited to a few seconds. The unit for such a sensor is always seconds, and so the “Select Unit” screen does not appear.
 - If you specify a total sampling time value in the range of 10 seconds to 23 hours, 59 minutes, 59 seconds, real-time graphing will be performed during sampling. This is the same as selecting the Real-time Mode on the “Advanced Setup” screen.
7. After inputting total sampling time value you want, press **EXE**.
 - This displays the “Select Unit” screen.
 8. Use number keys **1** through **4** to specify the unit for the value you specified in step 6.
 - This displays a confirmation screen.

9. If there is no problem with the contents of the confirmation screen, press **[F1]**.
If you need to change the setup, press **[F6]** or **[EXIT]**. This will return to the screen in step 6 (for setting the total sampling interval), where you can change the setting.
 - Pressing **[F1]** will take you to the final Setup Wizard screen.
10. Press number keys described below to specify what you want to do with the setup you have configured.
 - [1]** (Start Setup).....Starts sampling using the setup (page ε-30)
 - [2]** (Save Setup-MEM)Saves the setup (page ε-24)
 - [3]** (Convert Program)Converts the setup to a program (page ε-27)

■ Using Setup Wizard to Configure Settings for FFT (Frequency Characteristics) Data Sampling (EA-200 only)

When you perform sound sampling executed by the EA-200's built-in microphone (by specifying [CASIO] - [Microphone] as the sensor), Setup Wizard will provide you with three options: [Sound wave], [Sound wave & FFT], and [FFT only]. "Sound wave" records the following two dimensions for the sampled sound data: elapsed time (horizontal axis) and volume (vertical axis). "FFT" records the following two dimensions: frequency (horizontal axis) and volume (vertical axis).

The following shows the settings for recording FFT data.

1. Perform the first two steps of the procedure under "To configure a Data Logger setup using Setup Wizard" on page ε-2.
2. On the "Select Sensor" screen, select [CASIO] - [Microphone] - [Sound wave & FFT] or [CASIO] - [Microphone] - [FFT only].
 - This causes a "Select FFT Range" screen to appear.
 - You can select one of four settings for FFT Range. The setting you select will automatically apply the applicable fixed parameters shown below.

| Setting | 2 - 1000 Hz: | 4 - 2000 Hz: | 6 - 3000 Hz: | 8 - 4000 Hz: |
|-----------------------------------|--------------|--------------|--------------|--------------|
| Parameter | [F1] | [F2] | [F3] | [F4] |
| Frequency pitch | 2 Hz | 4 Hz | 6 Hz | 8 Hz |
| Upper limit of sampling frequency | 1000 Hz | 2000 Hz | 3000 Hz | 4000 Hz |
| Sampling interval | 61 μsec | 31 μsec | 20 μsec | 31 μsec |
| Number of samples | 8192 | 8192 | 8192 | 4096 |

3. Use function keys **[F1]** through **[F4]** to select an FFT Range setting.
 - Selecting an FFT Range causes the final Setup Wizard screen to appear.
4. Perform step 10 under "To configure a Data Logger setup using Setup Wizard" on page ε-2 to finalize the procedure.

■ Using Setup Wizard to Configure a Photogate Setup

Connection of a Vernier or CMA Photogate requires configuration of setup parameters that are slightly different from parameters for other types of sensors.

• To configure a setup for Photogate alone

1. On the E-CON3 main menu, press **F1**(SET) **F1**(WIZARD) to start the setup wizard.
 - This displays the “Select Sensor” dialog box.
2. If you are using a Vernier Photogate alone, select [VERNIER] - [Photogate] - [Gate]. When the “Select Channel” dialog box appears, advance to step 3 of this procedure. If you are using a CMA Photogate alone, select [CMA] - [Photogate] - [Gate]. When the “Gate Status” dialog box appears, advance to step 4 of this procedure.
3. Press **F1**(CH1) or **F2**(SONIC) to specify the channel where the Photogate is connected.
 - This displays the “Gate Status” dialog box.
4. On the “Gate Status” dialog box, select a gate status for measurement by pressing a function key (**F1** through **F4**).
 - The gate status defines what Photogate status should cause timing to start, and what status should cause timing to stop.
 - F1**(Open-Open)Timing starts when the gate opens, and continues until it closes and then opens again.
 - F2**(Open-Close).....Timing starts when the gate opens, and continues until it closes.
 - F3**(Close-Open).....Timing starts when the gate closes, and continues until it opens.
 - F4**(Close-Close)Timing starts when the gate closes, and continues until it opens and then closes again.
 - Selecting a gate status causes a screen for specifying the number of samples to appear.
5. Input an integer in the range of 1 to 255 to specify the number of samples.
6. Perform step 10 (in the case of a Vernier Photogate) or steps 9 and 10 (in the case of a CMA Photogate) under “To configure a Data Logger setup using Setup Wizard” (page ε-2).

• To configure a setup for Photogate and Smart Pulley

1. On the E-CON3 main menu, press **F1**(SET) **F1**(WIZARD) to start the setup wizard.
2. This displays the “Select Sensor” dialog box.
3. If you are using a Vernier Photogate, select [VERNIER] - [Photogate] - [Pulley]. When the “Select Channel” dialog box appears, advance to step 4 of this procedure. If you are using a CMA Photogate, select [CMA] - [Photogate] - [Pulley]. When the “Input Distance(m)” dialog box appears, advance to step 5 of this procedure.
4. Press **F1**(CH1) or **F2**(SONIC) to specify the channel where the Photogate is connected.
 - This displays the “Input Distance(m)” dialog box.
5. On the “Input Distance(m)” dialog box, input a value in the range of 0.1 to 4.0 and then press **EXE**.
6. Perform step 10 (in the case of a Vernier Photogate) or steps 9 and 10 (in the case of a CMA Photogate) under “To configure a Data Logger setup using Setup Wizard” (page ε-2).

■ Outputting the Waveform of a Function through the Speaker (EA-200 only)

Normally, the Setup Wizard helps you configure setups for sensors connected to a Data Logger. If you select [CASIO] - [Speaker] - [y=f(x)] on the “Select Sensor” screen, however, it configures the EA-200 to output the sound that corresponds to a function that you input and graph on the calculator.

• To configure a setup for speaker output

1. Connect the data communication cable (SB-62) to the communication port of the calculator and the MASTER port of the EA-200.
2. Perform the first two steps of the procedure under “To configure a Data Logger setup using Setup Wizard” on page ε-2.
3. On the “Select Sensor” screen, select [CASIO] - [Speaker] - [y=f(x)].

This displays a screen like the one shown nearby.

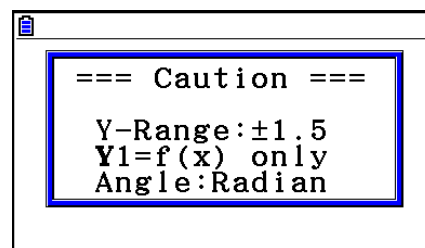

4. Press [EXE] to advance to the View Window setting screen.
 - The following settings are configured automatically: Ymin = -1.5 and Ymax = 1.5. Do not change these settings.
5. Press [EXE] or [EXIT] to advance to the graph relation list.
6. In line “Y1”, input the function of the waveform for the sound you want to input.
 - Note that the angle unit is always radians.
 - Input a function where the value of “Y” is within the range of -1.5 to +1.5.

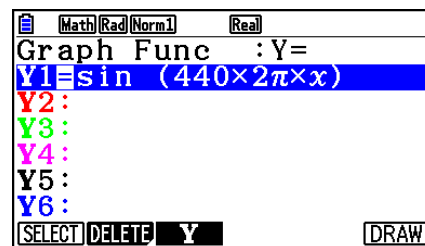

7. Press [F6] (DRAW) to graph the function.
 - This graphs the function and displays a vertical cursor line as shown in the sample display nearby. Use the graph to specify the range that you want to output to the speaker.

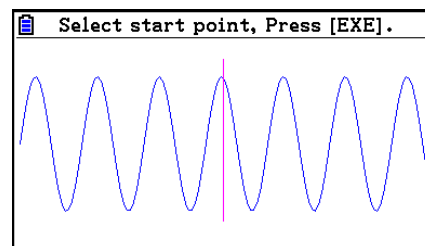

8. Use the [◀] and [▶] cursor keys to move the cursor to the start point of the output, and then press [EXE] to register it.

9. Use the ◀ and ▶ cursor keys to move the cursor to the end point of the output, and then press [EXE] to register it.
 - After you specify the start point and end point, an output frequency dialog box shown below appears on the display.

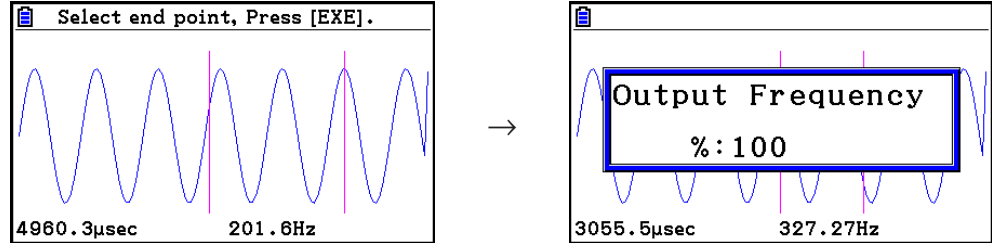

10. Input a percent value for the output frequency value you want.
 - To output the original sound as-is, specify 100%. To raise the original sound by one octave, input a value of 200%. To lower the original sound by one octave, input a value of 50%.
11. After inputting an output frequency value, press [EXE].
 - This outputs the waveform between the start point and end point from the EA-200 speaker.
 - If the sound you configured cannot be output for some reason, the message “Range Error” will appear. If this happens, press [EXIT] to scroll back through the previous setting screens and change the setup as required.
12. To terminate sound output, press the EA-200 [START/STOP] key.
13. Press [EXE].
 - This displays a screen like the one shown nearby.

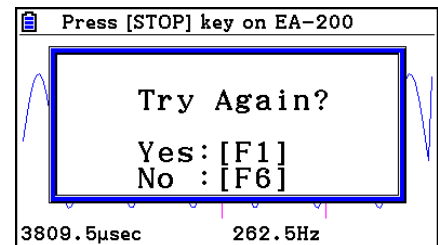

14. Perform one of the following operations, depending on what you want to do.

To change the output frequency and try again:

Press [F1] (Yes) to return to the “Output Frequency” dialog box. Next, repeat the above steps from step 10.

To change the output range of the waveform graph and try again:

Press [F6] (No) to return to the graph screen in step 7. Next, repeat the above steps from step 8.

To change the function:

Press [F6] (No) and then [EXIT] to return to the graph relation list in step 6. Next, repeat the above steps from step 6.

To exit the procedure and return to the E-CON3 main menu:

Press [F6] (No) and then press [EXIT] twice.

3. Using Advanced Setup

Advanced Setup provides you with total control over a number of parameters that you can adjust to configure the Data Logger setup that suits your particular needs.

■ Advanced Setup Operations

• To configure a Data Logger setup using Advanced Setup

The following procedure describes the general steps for using Advanced Setup. Refer to the pages as noted for more information.

1. Display the E-CON3 main menu (page E-1).
2. Press **[F1]** (SET). This displays the “Setup Data Logger” submenu.
3. Press **[F2]** (ADVANCE). This displays the Advanced Setup menu.

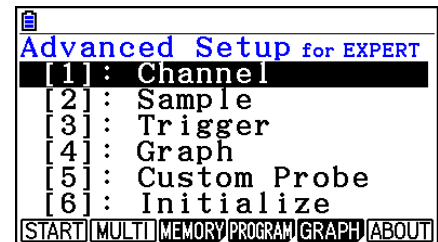

Advanced Setup Menu

4. If you want to configure a custom probe at this point, press **[5]** (Custom Probe). Next, follow the steps under “To configure a custom probe setup” on page E-19.
 - You can also configure a custom probe during the procedure under “To configure Channel Setup settings” on page E-9.
 - Custom probe configurations you have stored in memory can be selected using Channel in step 5, below.
5. Use the Advanced Setup keys described below to set other parameters.
 - **[1]** (Channel) Displays a screen that shows the sensors that are currently assigned to each channel (CH1, CH2, CH3, SONIC, Mic). You can also use this dialog to change sensor assignments. See “Channel Setup” on page E-9 for more information.
 - **[2]** (Sample) Displays a screen for selecting the sampling mode, and for specifying the sampling interval, the number of samples, and the warm-up mode. When “Fast” is selected for “Mode”, this dialog box also displays a setting for turning FFT (frequency characteristics) graphing on and off. See “Sample Setup” on page E-11 for more information.
 - **[3]** (Trigger) Displays a screen for configuring sampling start (trigger) conditions. See “Trigger Setup” on page E-13 for more information.
 - **[4]** (Graph) Displays a screen for configuring graph settings. See “Graph Setup” on page E-17 for more information.
- You can return the settings on the above setup screens (**[1]** through **[4]**) using the procedure described under “To return setup parameters to their initial defaults” below.

6. After you configure a setup, you can use the function key operations described below to start sampling or perform other operations.
- **[F1]** (START)Starts sampling using the setup (page ε-30).
 - **[F2]** (MULTI)Starts MULTIMETER mode sampling using the setup (page ε-23).
 - **[F3]** (MEMORY)Saves the setup (page ε-24).
 - **[F4]** (PROGRAM)....Converts the setup to a program (page ε-27).
 - **[F5]** (GRAPH)Graphs data sampled by the Data Logger, and provides tools for analyzing graphs (page ε-35).
 - **[F6]** (ABOUT).....Displays version information about the Data Logger unit that is currently connected to the calculator.

• To return setup parameters to their initial defaults

Perform the following procedure when you want to return the parameters of the setup in the current setup memory area to their initial defaults.

1. While the Advanced Setup menu (page ε-8) is on the display, press **[6]** (Initialize).
2. In response to the confirmation message that appears, press **[F1]** (Yes) to initialize the setup.
 - To clear the confirmation message without initializing the setup, press **[F6]** (No).

■ Channel Setup

The Channel Setup screen shows the sensors that are currently assigned to each channel (CH1, CH2, CH3, SONIC, Mic).

• To configure Channel Setup settings

1. While the Advanced Setup menu (page ε-8) is on the display, press **[1]** (Channel).
 - This displays the Channel Setup screen.

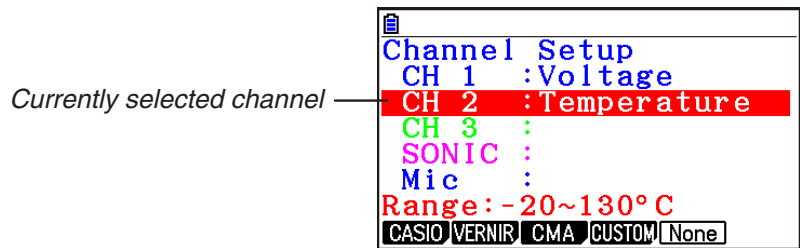

Channel Setup Screen

2. Use the **▲** and **▼** cursor keys to move the highlighting to the channel whose setting you want to change.

3. What you need to do next depends on the currently selected channel.

- CH1, CH2, or CH3

Press a function key to display a menu of sensors that can be assigned to the selected channel.

F1 (CASIO).....Displays a menu of CASIO sensors.

F2 (VERNIR)Displays a menu of Vernier sensors.

F3 (CMA).....Displays a menu of CMA sensors.

F4 (CUSTOM)Displays a menu of custom probes.

F5 (None)Press this key when you want leave the channel without any sensor assigned to it.

- SONIC Channel (EA-200 only)

Press a function key to display a menu of sensors that can be assigned to this channel.

F1 (CASIO).....Displays a menu of CASIO sensors, but only “Motion” can be selected.

F2 (VERNIR)Displays a menu of Vernier sensors. You can select “Motion” or “Photogate”.

Note

- On the menu that appears after you select “Motion” from either the CASIO or Vernier sensor menu, select either “meters” or “feet” as the sampling unit.
- After selecting “Motion” from either the CASIO or Vernier sensor menu, you can press the **OPTN** key to toggle “smoothing (correction of measurement error)” on (“-Smooth” displayed) and off (“-Smooth” not displayed).
- From the menu that appears after you select “Photogate” as the sensor, select [Gate] or [Pulley].

[Gate]Select this option when using the Photogate sensor alone.

[Pulley]Select this option when using the Photogate sensor along with a smart pulley.

F5 (None)Select this option to disable the SONIC channel.

- Mic Channel (EA-200 only)

For this channel, the sensor is automatically set to Built-in (External) Microphone. However, you need to configure the settings described below.

F1 (Sound)Select this option to record elapsed time and volume 2-dimensional sampled sound data (elapsed time on the horizontal axis, volume on the vertical axis).

F2 (FFT)Select this option to record frequency and volume 2-dimensional sampled sound data (frequency on the horizontal axis, volume on the vertical axis).

F5 (None)Select this option to disable the Mic channel.

4. Repeat steps 2 and 3 as many times as necessary to configure all the channels you want.

5. After all the settings are the way you want, press **EXE**.

- This returns to the Advanced Setup menu.

Note

- When you select a channel on the Channel Setup screen, the sampling range of the selected channel appears in the bottom line of the screen.

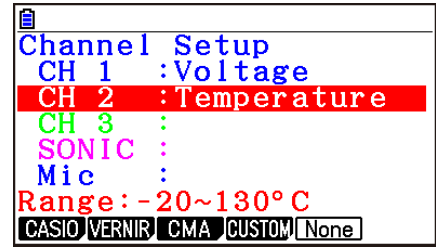

In the above example, the range of the temperature sensor assigned to CH2 appears on the display.

If the sampling range value is too long to fit on the display, only the part of the value that fits on the display will be shown.

■ Sample Setup

The Sample Setup screen lets you configure a number of settings that control sampling.

• To configure Sample Setup settings

1. While the Advanced Setup menu (page ε-8) is on the display, press **[2]** (Sample).

- This displays the Sample Setup screen, with the “Mode” line highlighted, which indicates that you can select the sampling mode.

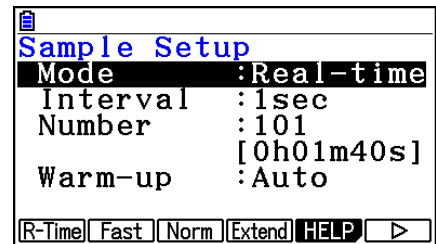

2. Select the sampling mode that suits the type of sampling you want to perform.

| To do this: | Press this key: | To select this mode: |
|----------------------------------------------------------------------------------------------------------------------------------------|--------------------------------------|----------------------|
| Graph data in real-time as it is sampled | [F1] (R-Time) | Real-time |
| Perform sampling of high-speed phenomena (sound, etc.) | [F2] (Fast) | Fast |
| Perform sampling over a long time (weather, etc.) | [F4] (Extend) | Extended* |
| Sample sound using built-in microphone (EA-200 only) | [F6] (▷) [F1] (Sound) | Sound |
| Record the time of the occurrence of a particular trigger event as an absolute value starting from 0, which is the sampling start time | [F6] (▷) [F2] (Clock) | Clock |
| Perform periodic sampling, from a start trigger event to an end trigger event | [F6] (▷) [F3] (Period) | Period |
| Perform sampling other than that described above | [F3] (Norm) | Normal |

* While performing measurements with the Extended mode, the EA-200 will enter a power off sleep state while standing by.

- Note that the mode you select also determines the channel(s) you can use.

| Sampling Mode | Selectable Channel(s) |
|-----------------------------|-----------------------|
| Real-time, Extended, Normal | CH1, CH2, CH3, SONIC |
| Fast | CH1, Mic |
| Sound | Mic |
| Clock, Period | CH1 |

- To change the sampling interval setting, move the highlighting to “Interval”. Next, press **F1** to display a dialog box for specifying the sampling interval.

- The range of values you can select depends on the current sampling mode setting.

| If this sampling mode is selected: | This is the allowable setting range: |
|------------------------------------|-------------------------------------------|
| Real-time | 0.2 to 299 sec |
| Fast | 20 to 500 μsec |
| Extended | 5 to 240 min |
| Period | “=Trigger” only (no value input required) |
| Sound | 20 to 27 μsec |
| Clock | “=Trigger” only (no value input required) |
| Normal | 0.0005 to 299 sec |

- To change the number of samples setting, move the highlighting to “Number”. Next, press **F1** to display a dialog box for specifying the number of samples.

- The total sampling time shown at the bottom of the dialog box is calculated by multiplying the “Sampling Interval” value you specified in step 3 by the number of samples you specify here.

Important!

- When all of the following conditions exist, a “Distance” setting appears in place of the “Number” setting. See “To configure the Distance setting” (page ε-13) for information about configuring the “Distance” setting.

- Channel setup (page ε-9): **F2** (VERNIR) - [Photogate] - [Pulley], **F3** (CMA) - [Photogate] - [Pulley]
- Sampling mode (page ε-11): Clock

- To change the warm-up time setting, move the highlighting to “Warm-up”. Next, perform one of the function key operations described below.

Note

- The “Warm-up” setting will not be displayed on the Sample Setup screen if “Fast”, “Sound” or “Extended” is currently selected as the sampling mode.

| To do this: | Press this key: |
|---------------------------------------------------------|--------------------|
| Have the warm-up time for each sensor set automatically | F1 (Auto) |
| Input a warm-up time, in seconds, manually | F2 (Manual) |
| Disable the warm-up time | F3 (None) |

Important!

- When the following condition exists, an “FFT Graph” setting appears in place of the “Warm-up” setting. See “To configure the FFT Graph setting” below, for information about configuring the “FFT Graph” setting.
 - Sampling mode (page ε-11): Fast
6. After all the settings are the way you want, press **[EXE]**.
- This returns to the Advanced Setup menu.

• **To configure the Distance setting**

In place of step 3 of the procedure under “To configure Sample Setup settings”, press **[F1]** to display a dialog box for specifying the distance the weight travels in meters.

- Specify a value in the range of 0.1 to 4 meters.

• **To configure the FFT Graph setting**

In place of step 5 of the procedure under “To configure Sample Setup settings”, press **[F1]** to display a dialog box for turning frequency characteristic graphing (FFT Graph) on and off.

| To do this: | Press this key: |
|---------------------------------------------------------------|-------------------|
| Turn on graphing of frequency characteristics after sampling | [F1] (On) |
| Turn off graphing of frequency characteristics after sampling | [F2] (Off) |

■ Trigger Setup

You can use the Trigger Setup screen to specify the event that causes sampling to start (**[EXE]** key operation, etc.). The event that causes sampling to start is called the “trigger source”, which is indicated as “Source” on the Trigger Setup screen.

The following table describes each of the six available trigger sources.

| To start sampling when this happens: | Select this trigger source: |
|-------------------------------------------------------------------------|-----------------------------|
| When the [EXE] key is pressed | [EXE] key |
| After the specified number of seconds are counted down | Count Down |
| When input at CH1 reaches a specified value | CH1 |
| When input at the SONIC channel reaches a specified value (EA-200 only) | SONIC |
| When the built-in microphone detects sound (EA-200 only) | Mic |
| When the [START/STOP] key is pressed (EA-200 only) | [START] key |
| When [Button] is pressed (CLAB only) | [START] key |

• **To configure Trigger Setup settings**

1. While the Advanced Setup menu (page ε-8) is on the display, press **[3]** (Trigger).

- This displays the Trigger Setup screen with the “Source” line highlighted.
- The function menu items that appears in the menu bar depend on the sampling mode selected with Sample Setup (page ε-11). The nearby screen shows the function menu when “Normal” is selected as the sample sampling mode.

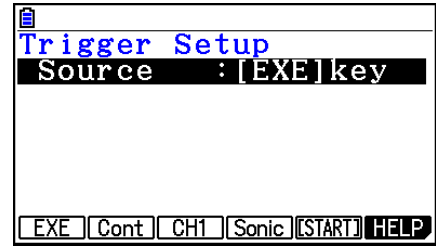

2. Use the function keys to select the trigger source you want.

- The following shows the trigger sources that can be selected for each sampling mode.

| Sampling Mode | Trigger Source |
|---------------|-------------------------------------------------------------------------------------------------------------------------------------------|
| Real-time | [F1] (EXE) : [EXE] key, [F2] (Cont) : Count Down |
| Fast | [F1] (EXE) : [EXE] key, [F2] (Cont) : Count Down, [F3] (CH1), [F5] (Mic) |
| Normal | [F1] (EXE) : [EXE] key, [F2] (Cont) : Count Down, [F3] (CH1), [F4] (Sonic), [F5] (START) : [START] key |
| Sound | [F1] (EXE) : [EXE] key, [F2] (Cont) : Count Down, [F5] (Mic) |

- The trigger source is always “[EXE] key” when the sampling mode is “Extended”, and “CH1” when the sampling mode is “Clock” or “Period”.

3. Perform one of the following operations, in accordance with the trigger source that was selected in step 2.

| If this is the trigger source: | Do this next: |
|--------------------------------|---------------------------------------------------------------------------------------------------------------------------------------------------------------------------------------------------------------------------------------------------------------------------------------------------------------|
| [EXE] key | Press [EXE] to finalize Trigger Setup and return to the Advanced Setup menu. |
| Count Down | Specify the countdown start time. See “To specify the countdown start time” below. |
| CH1 | Specify the trigger threshold value and trigger edge direction. See “To specify the trigger threshold value and trigger edge type” on page ε-15, “To configure trigger threshold, trigger start edge, and trigger end edge settings” or “To configure Photogate trigger start and end settings” on page ε-16. |
| SONIC | Specify the trigger threshold value and motion sensor level. See “To specify the trigger threshold value and motion sensor level” on page ε-17. |
| Mic | Specify microphone sensitivity. See “To specify microphone sensitivity” on page ε-15. |
| [START] key | Press [EXE] to finalize Trigger Setup and return to the Advanced Setup menu. |

• To specify the countdown start time

1. Move the highlighting to “Timer”.
2. Press **[F1]**(Time) to display a dialog box for specifying the countdown start time.
3. Input a value in seconds from 1 to 10.
4. Press **[EXE]** to finalize Trigger Setup and return to the Advanced Setup menu.

• To specify microphone sensitivity

1. Move the highlighting to “Sense” and then press one of the function keys described below.

| To select this level of microphone sensitivity: | Press this key: |
|-------------------------------------------------|----------------------|
| Low | [F1] (Low) |
| Medium | [F2] (Middle) |
| High | [F3] (High) |

2. Press **[EXE]** to finalize Trigger Setup and return to the Advanced Setup menu (page ε-8).

• To specify the trigger threshold value and trigger edge type

Perform the following steps when “Fast”, “Normal”, or “Clock” is specified as the sampling mode (page ε-11).

1. Move the highlighting to “Threshold”.
2. Press **[F1]**(EDIT) to display a dialog box for specifying the trigger threshold value, which is value that data needs to attain before sampling starts.

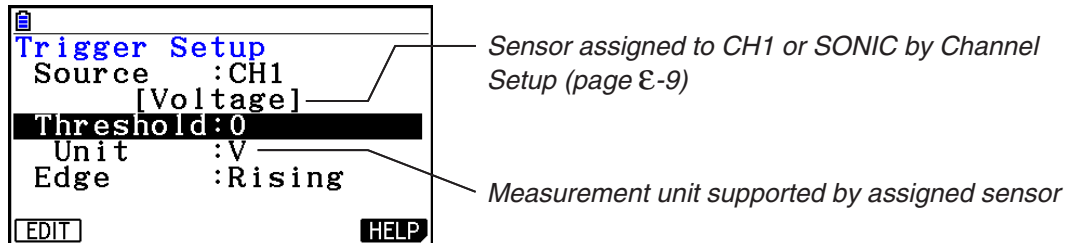

3. Input the value you want, and then press **[EXE]**.
4. Move the highlighting to “Edge”.
5. Press one of the function keys described below.

| To select this type of edge: | Press this key: |
|------------------------------|--------------------|
| Falling | [F1] (Fall) |
| Rising | [F2] (Rise) |

6. Press **[EXE]** to finalize Trigger Setup and return to the Advanced Setup menu (page ε-8).

• **To configure trigger threshold, trigger start edge, and trigger end edge settings**

Perform the following steps when “Period” is specified as the sampling mode (page ε-11).

1. Move the highlighting to “Threshold”.
2. Press **[F1]** (EDIT) to display a dialog box for specifying the trigger threshold value, which is value that data needs to attain before sampling starts.
3. Input the value you want.
4. Move the highlighting to “Start to”.
5. Press one of the function keys described below.

| To select this type of edge: | Press this key: |
|------------------------------|--------------------|
| Falling | [F1] (Fall) |
| Rising | [F2] (Rise) |

6. Move the highlighting to “End Edge”.
7. Press one of the function keys described below.

| To select this type of edge: | Press this key: |
|------------------------------|--------------------|
| Falling | [F1] (Fall) |
| Rising | [F2] (Rise) |

8. Press **[EXE]** to finalize Trigger Setup and return to the Advanced Setup menu (page ε-8).

• **To configure Photogate trigger start and end settings**

Perform the following steps when CH1 is selected as a Photogate trigger source.

1. Move the highlighting to “Start to”.
2. Press one of the function keys described below.

| To specify this Photogate status: | Press this key: |
|-----------------------------------|---------------------|
| Photogate closed | [F1] (Close) |
| Photogate open | [F2] (Open) |

3. Move the highlighting to “End Gate”.
4. Press one of the function keys described below.

| To specify this Photogate status: | Press this key: |
|-----------------------------------|---------------------|
| Photogate closed | [F1] (Close) |
| Photogate open | [F2] (Open) |

5. Press **[EXE]** to finalize Trigger Setup and return to the Advanced Setup menu (page ε-8).

• **To specify the trigger threshold value and motion sensor level**

1. Move the highlighting to “Threshold”.
2. Press **[F1]**(EDIT) to display a dialog box for specifying the trigger threshold value, which is value that data needs to attain before sampling starts.
3. Input the value you want, and then press **[EXE]**.
4. Move the highlighting to “Level”.
5. Press one of the function keys described below.

| To select this type of level: | Press this key: |
|-------------------------------|---------------------|
| Below | [F1] (Below) |
| Above | [F2] (Above) |

6. Press **[EXE]** to finalize Trigger Setup and return to the Advanced Setup menu (page ε-8).

■ **Graph Setup**

Use the Graph Setup screen to configure settings for the graph produced after sampling is complete. You use the Sample Setup settings (page ε-11) to turn graphing on or off.

• **To configure Graph Setup settings**

1. While the Advanced Setup menu (page ε-8) is on the display, press **[4]** (Graph).
 - This displays the Graph Setup screen.

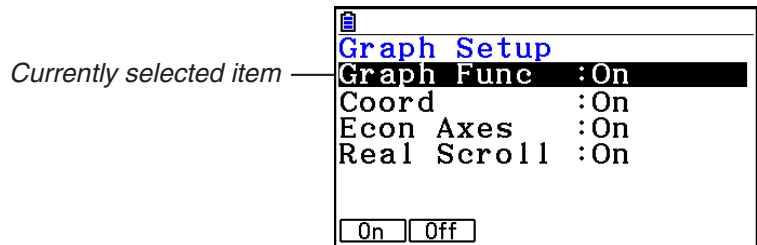

Graph Setup Screen

2. To change the graph source data name display setting, use the **▲** and **▼** cursor keys to move the highlighting to “Graph Func”. Next, press one of the function keys described below.

| To specify this graph source data name display setting: | Press this key: |
|---------------------------------------------------------|-------------------|
| Display source data name | [F1] (On) |
| Hide source data name | [F2] (Off) |

- When the graph data is stored in a sample data memory file, the file name appears as the source data name. When the graph data is stored in current data area, the channel name appears.

Note

- For details about sample data memory and current data area, see “Using Sample Data Memory” (page ε-33).

3. To change the trace operation coordinate display setting, use the ▲ and ▼ cursor keys to move the highlighting to “Coord”. Next, press one of the function keys described below.

| To specify this coordinate display setting for the trace operation: | Press this key: |
|---------------------------------------------------------------------|-----------------|
| Display trace coordinates | F1 (On) |
| Hide trace coordinates | F2 (Off) |

4. To change the numeric axes display setting, use the ▲ and ▼ cursor keys to move the highlighting to “Econ Axes”. Next, press one of the function keys described below.

| To specify this axes display setting: | Press this key: |
|---------------------------------------|-----------------|
| Display axes | F1 (On) |
| Hide axes | F2 (Off) |

5. To change the real-time scroll setting, use the ▲ and ▼ cursor keys to move the highlighting to “Real Scroll”. Next, press one of the function keys described below.

| To specify this real-time scrolling setting: | Press this key: |
|----------------------------------------------|-----------------|
| Real-time scrolling on | F1 (On) |
| Real-time scrolling off | F2 (Off) |

6. Press **EXE** to finalize Graph Setup and return to the Advanced Setup menu.

4. Using a Custom Probe

You can use the procedures in this section to configure a custom probe for use with a Data Logger.

Important!

- The sensors (CASIO, Vernier, CMA) that appear on the list during Channel Setup (page ε-9) are E-CON3 mode standard sensors. If you want to use a sensor that is not included in the list, configure custom probe settings.
- A sensor with an output voltage in the range of 0 to 5 volts can be configured with E-CON3 as a custom probe. Use of sensors with an output voltage outside of this range is not supported.

■ Configuring a Custom Probe Setup

To configure a custom probe setup, you must input values for the constants of the fixed linear interpolation formula ($ax + b$). The required constants are slope (a) and intercept (b). x in the above expression ($ax + b$) is the sampled voltage value (sampling range: 0 to 5 volts).

• To configure a custom probe setup

1. From the E-CON3 main menu (page ε-1), press **[F1]**(SET) and then **[F2]**(ADVANCE) to display the Advanced Setup menu.
2. On the Advanced Setup menu (page ε-8), press **[5]**(Custom Probe) to display the Custom Probe List.
 - The message “No Custom Probe” appears if the Custom Probe List is empty.
3. Press **[F1]**(NEW).
 - This displays a custom probe setup screen like the one shown nearby.

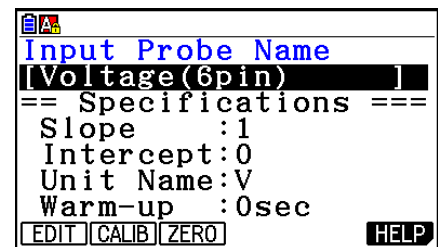

4. Press **[F1]**(EDIT).
5. Input up to 18 characters for the custom probe name, and then press **[EXE]**.
 - This will cause the highlighting to move to “Slope”.
6. Use the function keys described below to configure the custom probe setup.
 - To change the setting of an item, first use the **▲** and **▼** cursor keys to move the highlighting to the item. Next, use the function keys to select the setting you want.
 - (1) Slope
Press **[F1]**(EDIT) to input the slope for the linear interpolation formula.
 - (2) Intercept
Press **[F1]**(EDIT) to input the intercept for the linear interpolation formula.
 - (3) Unit Name
Press **[F1]**(EDIT) to input up to eight characters for the unit name.
 - (4) Warm-up
Press **[F1]**(EDIT) to input the warm-up time.

7. Press **[EXE]** and then input a memory number (1 to 99).
 - This saves the custom probe setup and returns to the Custom Probe List, which should now contain the new custom probe setup you configured.

• **To recall the specifications of a Vernier or CMA sensor and configure custom probe settings**

1. Perform the first two steps of the procedure under “To configure a custom probe setup” on page ε-19.
2. Press **[F4]** (VERNIR) or **[F5]** (CMA).
 - This displays a sensor list.
3. Use the **▲** and **▼** keys to move the highlighting to the sensor whose setting you want to use as the basis of the custom probe settings, and then press **[EXE]**.
 - The name and specifications of the sensor you select will appear on the custom probe setup screen.
 - To complete this procedure, perform steps 4 through 7 under “To configure a custom probe setup” (page ε-19).

■ Auto Calibrating a Custom Probe

Auto calibration automatically corrects the slope and intercept values of a custom probe setup based on two actual samples.

Important!

- Before performing the procedure below, you should prepare two conditions whose measurement values are known.
- When inputting reference value in step 5 of the procedure below, input the exact known measurement value of the condition you will sample in step 4. When inputting reference value in step 7 of the procedure below, input the exact known measurement value of the condition you will sample in step 6.

• **To auto calibrate a custom probe**

1. Connect the calculator and Data Logger, and connect the custom probe you want to auto calibrate to CH1 of the Data Logger.
2. What you should do first depends on whether you are configuring a new custom probe for calibration, or editing the configuration of an existing custom probe.

If you are configuring a new custom probe:

- Perform steps 1 through 6 of the procedure under “To configure a custom probe setup” on page ε-19.
- Auto calibrate will automatically set the slope and intercept, so you do not need to specify them in step 6 of the above procedure.

If you are editing the configuration of an existing custom probe:

- (1) On the Custom Probe List, use the **▲** and **▼** cursor keys to highlight the name of the custom probe you want to edit, and then press **[F2]** (EDIT).
- (2) Perform the procedure starting from step 6 under “To configure a custom probe setup” on page ε-19.

3. Press **[F2]** (CALIB).

- This will start the first sampling operation with the sensor connected to Data Logger's CH1, and then display a screen like the one shown below.

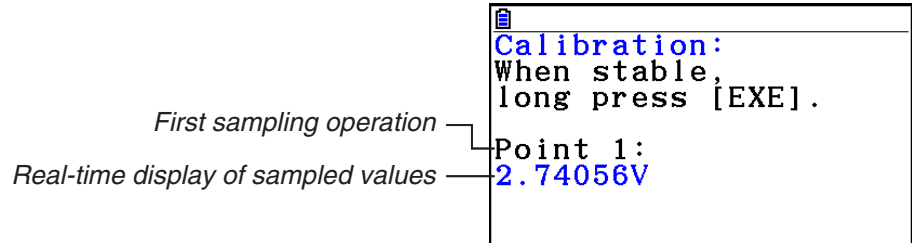

4. After the sampled value stabilizes, hold down **[EXE]** for a few seconds.

- This will register the first sampled value and display it on the screen. At this time the cursor will appear at the bottom of the display, ready for input of a reference value.

5. Use the key pad to input the reference value for the first sampled value, and then press **[EXE]**.

- This cause sampling of the second value to be performed automatically, and display the same type of screen that appeared in step 3.

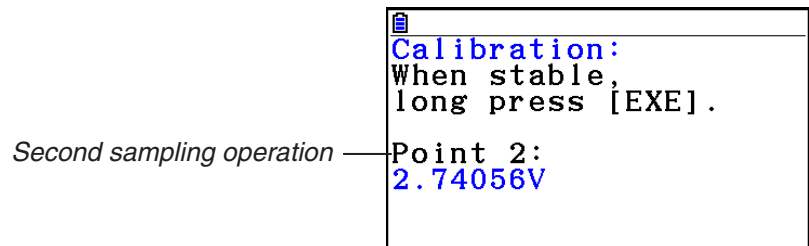

6. After the sampled value stabilizes, hold down **[EXE]** for a few seconds.

- This will register the second sampled value and display it on the screen. The cursor will appear at the bottom of the display, ready for input of a reference value.

7. Use the key pad to input the reference value for the second sampled value, and then press **[EXE]**.

- This will return to the custom probe setup screen.
- The E-CON3 will calculate the slope and intercept value based on the two reference values that you input, and configure the settings automatically. The automatically configured values will appear on the custom probe setup screen, where you can view them.

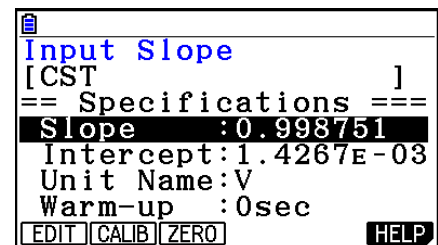

8. Press **[EXE]**, and then input a memory number from 1 to 99.

- This saves the custom probe setup and returns to the custom probe list.

■ Zero Adjusting a Custom Probe

This procedure zero adjusts a custom probe and sets its intercept value based on an actual sample using the applicable custom probe.

• To zero adjust a custom probe

1. Connect the calculator and Data Logger, and connect the custom probe you want to zero adjust to CH1 of the Data Logger.
2. What you should do first depends on whether you are configuring a new custom probe for zero adjusting, or editing the configuration of an existing custom probe.

If you are configuring a new custom probe:

- Perform steps 1 through 6 of the procedure under “To configure a custom probe setup” on page ε-19.
- Auto calibrate will automatically set the intercept, so you do not need to specify it in step 6 of the above procedure.

If you are editing the configuration of an existing custom probe:

- (1) On the Custom Probe List, use the ▲ and ▼ cursor keys to highlight the name of the custom probe you want to edit, and then press **[F2]** (EDIT).
 - (2) Perform the procedure starting from step 6 under “To configure a custom probe setup” on page ε-19.
3. Press **[F3]** (ZERO).
 - This will start the sampling operation with the sensor connected to Data Logger’s CH1, and then display a screen like the one shown nearby.

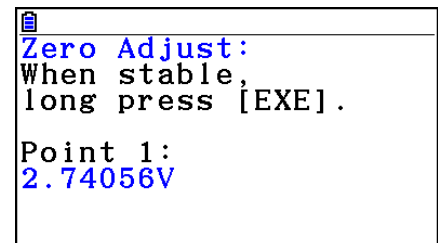

4. At the point your want to perform zero adjustment (the point that the displayed value is the appropriate zero adjust value), press **[EXE]**.
 - This will return to the custom probe setup screen.
 - The E-CON3 will set the intercept value automatically based on the sampled value. The automatically configured value will appear on the custom probe setup screen, where you can view it.

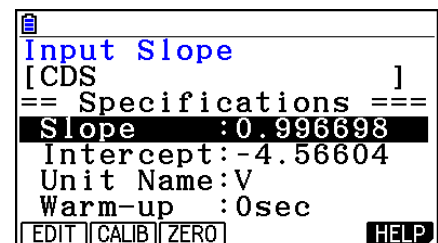

5. Press **[EXE]**, and then input a memory number from 1 to 99.
 - This saves the custom probe setup and returns to the custom probe list.

5. Using the MULTIMETER Mode

You can use the Channel Setup screen (page ε-9) to configure a channel so that Data Logger MULTIMETER mode sampling is triggered by a calculator operation.

• To use the MULTIMETER mode

1. Connect the calculator and Data Logger, and connect the sensors you want to the applicable Data Logger channels.
2. From the Advanced Setup menu (page ε-8), use the Channel Setup screen (page ε-9) to configure sensor setups for each channel you will be using.
3. After configuring the sensor setups, press **[EXE]** to return to the Advanced Setup menu (page ε-8), and then press **[F2]** (MULTI).
 - This starts sampling in the Data Logger MULTIMETER mode and displays a list of sample values for each channel.
 - Displayed sample data is refreshed at 0.5-second intervals.
 - Do not connect sensors to any other channels except for those you specified in step 2.
 - Data sampled in the MULTIMETER mode is not saved in memory.
4. To end MULTIMETER mode sampling, press the **[EXE]** key.

```

===== E-CON3 =====
CH 1 : 31.14Lum Int
CH 2 : 120.8°C
CH 3 : 100.1V
SONIC: 146.4meters
STOP: [EXE] long press
  
```

6. Using Setup Memory

Creating Data Logger setup data using the Setup Wizard or Advanced Setup causes the data to be stored in the “current setup memory area”. The current contents of the current setup memory area are overwritten whenever you create other setup data.

You can use setup memory to save the current setup memory area contents to calculator memory to keep it from being overwritten, if you want.

■ Saving a Setup

A setup can be saved when any one of the following conditions exist.

- After configuring a new setup with Setup Wizard (page ε-2)
- After configuring a new setup with Advanced Setup (page ε-8)
- While the E-CON3 main menu (page ε-1) is on the display

Details on saving a setup are listed below.

• To save a setup

1. If the final Setup Wizard screen is on the display, advance to step 2. If it isn't, start the save operation by performing one of the function key operations described below.
 - If the Advanced Setup menu (page ε-8) is on the display, press **F3** (MEMORY).
 - If the E-CON3 main menu (page ε-1) is on the display, press **F2** (MEMORY).
- Performing any one of the above operations causes the setup memory list to appear.
- The message “No Setup-MEM” appears if setup memory is empty.
2. If you are starting from the final Setup Wizard screen, press **F2** (Save Setup-MEM). If you are starting from another screen, press **F2** (SAVE).
 - This displays the screen for inputting the setup name.
3. Input up to 18 characters for the setup name.
4. Press **EXE** and then input a memory number (1 to 99).
 - If you start from the final Setup Wizard screen, this saves the setup and the message “Complete!” appears. Press **EXE** to return to the final Setup Wizard screen.
 - If you start from the Advanced Setup menu (page ε-8) or the E-CON3 main menu (page ε-1), this saves the setup and returns to the setup memory list which includes the name you assigned it.

Important!

- Since you assign both a setup name and a file number to each setup, you can assign the same name to multiple setups, if you want.

■ Using and Managing Setups in Setup Memory

All of the setups you save are shown in the setup memory list. After selecting a setup in the list, you can use it to sample data or you can edit it.

• To preview saved setup data

You can use the following procedure to check the contents of a setup before you use it for sampling.

1. On the E-CON3 main menu (page ε-1), press **[F2]** (MEMORY) to display the setup memory list.
2. Use the **▲** and **▼** cursor keys to highlight the name of the setup you want.
3. Press **[OPTN]** (Setup Preview).
 - This displays the preview dialog box.

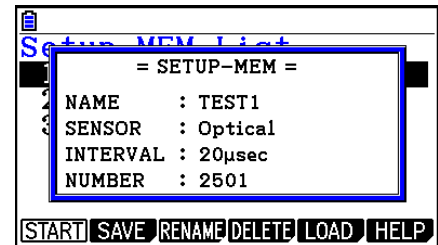

4. To close the preview dialog box, press **[EXIT]**.

• To recall a setup and use it for sampling

Be sure to perform the following steps before starting sampling with a Data Logger.

1. Connect the calculator to a Data Logger.
2. Turn on Data Logger power.
3. In accordance with the setup you plan to use, connect the proper sensor to the appropriate Data Logger channel.
4. Prepare the item whose data is to be sampled.
5. On the E-CON3 main menu (page ε-1), press **[F2]** (MEMORY) to display the setup memory list.
6. Use the **▲** and **▼** cursor keys to highlight the name of the setup you want.
7. Press **[F1]** (START).
 - Pressing **[EXE]** sets up the Data Logger and then starts sampling.
 - To clear the confirmation message without sampling, press **[F6]**.

Note

- See “Operations during a sampling operation” on page ε-31 for information about operations you can perform while a sampling operation is in progress.

• To change the name of setup data

1. On the E-CON3 main menu (page ε-1), press **F2** (MEMORY) to display the setup memory list.
2. Use the **▲** and **▼** cursor keys to highlight the name of the setup you want.
3. Press **F3** (RENAME).
 - This displays the screen for inputting the setup name.
4. Input up to 18 characters for the setup name, and then press **EXE**.
 - This changes the setup name and returns to the setup memory list.

• To delete setup data

1. On the E-CON3 main menu (page ε-1), press **F2** (MEMORY) to display the setup memory list.
2. Use the **▲** and **▼** cursor keys to highlight the name of the setup you want.
3. Press **F4** (DELETE).
4. In response to the confirmation message that appears, press **F1** (Yes) to delete the setup.
 - To clear the confirmation message without deleting anything, press **F6** (No).

• To recall setup data

Recalling setup data stores it in the current setup memory area. You can then use Advanced Setup to edit the setup. This capability comes in handy when you need to perform a setup that is slightly different from one you have stored in memory.

1. On the E-CON3 main menu (page ε-1), press **F2** (MEMORY) to display the setup memory list.
2. Use the **▲** and **▼** cursor keys to highlight the name of the setup you want.
3. Press **F5** (LOAD).
4. In response to the confirmation message that appears, press **F1** (Yes) to recall the setup.
 - To clear the confirmation message without recalling the setup, press **F6** (No).

Note

- Recalling setup data replaces any other data currently in the current setup memory area.

7. Using Program Converter

Program Converter converts a Data Logger setup you configured using Setup Wizard or Advanced Setup to a program that can run on the calculator. You can also use Program Converter to convert a setup to a CFX-9850 Series/fx-7400 Series-compatible program.*1 *2

*1 See the documentation that came with your scientific calculator or EA-200 for information about how to use a converted program.

*2 See online help (PROGRAM CONVERTER HELP) for information about supported CFX-9850 Series and fx-7400 Series models.

■ Converting a Setup to a Program

A setup can be converted to a program when any one of the following conditions exists.

- After configuring a new setup with Setup Wizard (page ε-2)
- After configuring a new setup with Advanced Setup (page ε-8)
- While the E-CON3 main menu (page ε-1) is on the display

The program converter procedure is identical in all of the above cases.

• To convert a setup to a program

1. Start the converter operation by performing one of the key operations described below.
 - If the final Setup Wizard screen is on the display, press **[3]** (Convert Program).
 - If the Advanced Setup menu (page ε-8) is on the display, press **[F4]** (PROGRAM).
 - If the E-CON3 main menu (page ε-1) is on the display, press **[F3]** (PROGRAM).
- After you perform any one of the above operations, the program converter screen will appear on the display.

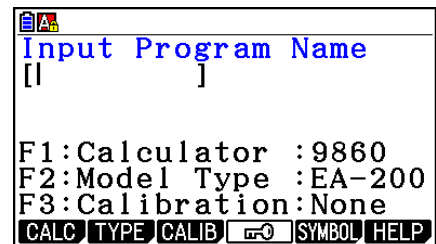

2. Enter up to eight characters for the program name.

Note

Using the program converter initial default settings will create a program like the one below.

- Associated Scientific Calculator: fx-9860G Series/fx-CG10/fx-CG20/fx-CG20 AU
- Associated Data Logger: EA-200
- Calibration: None
- Password: None

If you want to use these settings the way they are without changing them, skip steps 3 through 7 and go directly to step 8. If you want to change any of the settings, perform the applicable operations in steps 3 through 7.

- Specify the scientific calculator model to be associated with the program. Perform one of the following key operations to associate the program with a scientific calculator.

| To associate the program with this calculator: | Perform this key operation: |
|------------------------------------------------|-----------------------------------|
| fx-9860G Series/fx-CG10/fx-CG20/fx-CG20 AU | F1 (CALC) F1 (9860) |
| CFX-9850 Series | F1 (CALC) F2 (9850) |
| fx-7400 Series | F1 (CALC) F3 (7400) |

- The number part of the scientific calculator model number you specify will appear in line “F1:” of the program converter screen.

Note

- For information about **F1** (CALC) **F4** (→38k), see “Converting a CFX-9850 Series Program to a fx-9860G Series/fx-CG10/fx-CG20/fx-CG20 AU Compatible Program” (page ε-29).

- Specify the Data Logger model (EA-100 or EA-200) to be associated with the program. Perform one of the following key operations to associate the program with a Data Logger.

| To associate the program with this Data Logger: | Perform this key operation: |
|-------------------------------------------------|----------------------------------|
| EA-200 | F2 (TYPE) F1 (200) |
| EA-100 | F2 (TYPE) F2 (100) |

- The number part of the Data Logger model number you specify will appear in line “F2:” of the program converter screen.

Important!

- Note that the capabilities of the EA-100 and EA-200 are different. Because of this, you should keep in mind that an EA-200 program converted to an EA-100 program and used to perform sampling with an EA-100 setup may not produce the desired results.

- If you plan to use a custom probe connected to CH1 of the Data Logger, specify whether calibration or zero adjust should be performed. Perform one of the following key operations to configure the desired setting.

| To perform this operation: | Perform this key operation: |
|-------------------------------------|-------------------------------------|
| Calibration of the CH1 custom probe | F3 (CALIB) F1 (CALIB) |
| Zero adjust of the CH1 custom probe | F3 (CALIB) F2 (ZERO) |
| No calibration | F3 (CALIB) F3 (None) |

- The operation you specify will appear in line “F3:” of the program converter screen.

- To password protect the program, press **F4** (LOCK).

- This will cause the “Password?” prompt and password input field to appear under the program name input field.

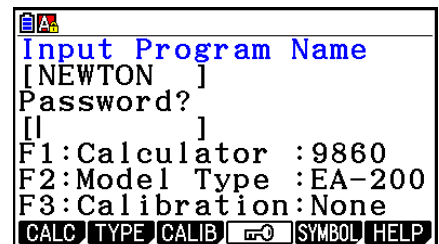

7. Enter up to eight characters for the password.
 - If you change your mind about assigning a password, press **[EXIT]** here. This will cause the password input field to disappear and cancel password input.
8. After everything is the way you want, press **[EXE]** to convert the program in accordance with the setup.
 - The message “Complete!” appears when conversion is complete. To clear the message and return to the screen that was on the display in step 1, press **[EXE]** or **[EXIT]**.

■ Converting a CFX-9850 Series Program to a fx-9860G Series/fx-CG10/fx-CG20/fx-CG20 AU Compatible Program

To use an EA-200 control program created on the CFX-9850 Series calculator (for use on the CFX-9850) on the E-CON3, you need to convert the program to an fx-9860G Series/fx-CG10/fx-CG20/fx-CG20 AU program. Conversion can be performed using the program converter.

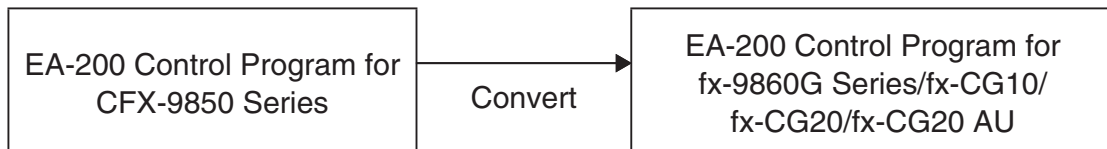

• To convert a program

1. Transfer the EA-200 control program created for the CFX-9850 Series to the fx-CG10/fx-CG20/fx-CG20 AU main memory.
 - Use the data communication cable to connect its 3-pin serial port to the 3-pin serial port of the CFX-9850. For details, see Chapter 13 of this manual.
2. Perform step 1 under “To convert a setup to a program” on page ε-27, which displays the program converter screen.
3. Press **[F1]**(CALC) and then press **[F4]**(→38k).
 - This displays a list of programs currently in main memory.
4. Use **▲** and **▼** to move the highlighting of the program you want to convert, and then press **[F1]**(EXE) or **[EXE]**.
 - A program name input screen will appear after conversion is complete.
5. Enter up to eight characters for the program name.
 - If you want to password protect the program, perform steps 6 and 7 under “To convert a setup to a program” after inputting the program name.
6. Press **[EXE]** to start conversion of the program.
 - The message “Complete!” appears when conversion is complete. To clear the message, press **[EXE]** or **[EXIT]**.

8. Starting a Sampling Operation

This section describes how to use a setup configured using the **E-CON3** mode to start a Data Logger sampling operation.

■ Before getting started...

Be sure to perform the following steps before starting sampling with a Data Logger.

1. Connect the calculator to a Data Logger.
2. Turn on Data Logger power.
3. In accordance with the setup you plan to use, connect the proper sensor to the appropriate Data Logger channel.
4. Prepare the item whose data is to be sampled.

■ Starting a Sampling Operation

A sampling operation can be started when any one of the following conditions exist.

- After configuring a new setup with Setup Wizard (page ε-2)
- After configuring a new setup with Advanced Setup (page ε-8)
- While the E-CON3 main menu (page ε-1) is on the display
- While the setup memory list is on the display

The following procedures explain the first three conditions described above. See “To recall a setup and use it for sampling” on page ε-25 for information about starting sampling from the setup memory list.

• To start sampling

1. Start the sampling operation by performing one of the function key operations described below.
 - If the final Setup Wizard screen is on the display, press **[1]** (Start Setup).
 - If the Advanced Setup menu (page ε-8) is on the display, press **[F1]** (START).
 - If the E-CON3 main menu (page ε-1) is on the display, press **[F4]** (START).
- After you perform any one of the above operations, a sampling start confirmation screen like the one shown nearby will appear on the display.

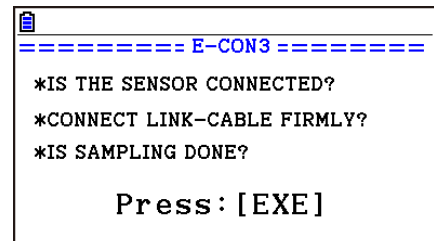

2. Press **[EXE]**.

- This sets up the Data Logger using the setup data in the current setup memory area.
- The message “Setting Data Logger...” remains on the display while Data Logger setup is in progress. You can cancel the setup operation any time this message is displayed by pressing **[AC]**.
- The screen shown nearby appears after Data Logger setup is complete.

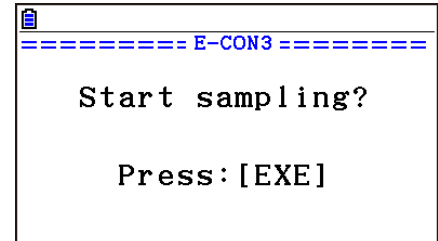

3. Press **[EXE]** to start sampling.

- The screens that appear while sampling is in progress and after sampling is complete depend on setup details (sampling mode, trigger setup, etc.). For details, see “Operations during a sampling operation” below.

• Operations during a sampling operation





Sending a sample start command from the calculator to a Data Logger causes the following sequence to be performed.

Setup Data Transfer → Sampling Start → Sampling End →

Transfer of Sample Data from the Data Logger to the Calculator

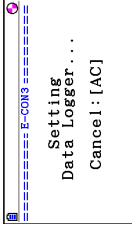
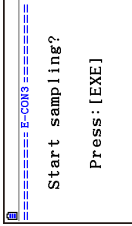
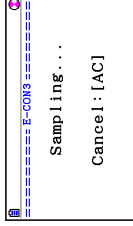
The table on the next page shows how the trigger conditions and sensor type specified in the setup data affects the above sequence.

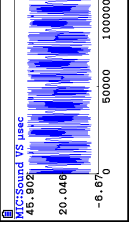
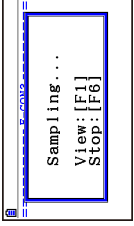
Starts Sampling

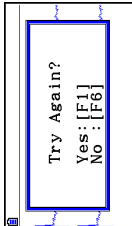
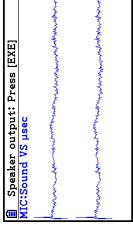
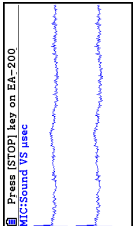
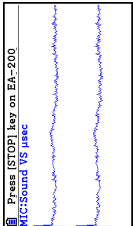
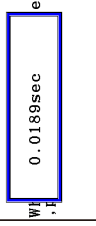
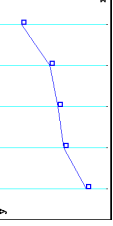
| Mode | 1. Data Logger Setup | 2. Start Standby | 3. Sampling | 4. Graphing |
|------------------|-------------------------------------------------------------------------------------|-------------------------------------------------------------------------------------|-----------------------------------------------------------------------------------------------------------------------------------------------------------------------------------------------------------------------------------------------------------------|----------------------------------------------------------------------------------------------------------------------------------------------------------------------------------------------------------------------------------------------------------------------------------------------------------------------------------------------------------------------------------------------------------------------------------------------------------------------------------------------------------------------------------------------------------------------------------------------------------------------------------------------------------------------------------------------------------------------------------------------------------------------------------------------------------------------------|
| Real-time |  |  |  <p>• The screen shown below appears when CH1, SONIC, or Mic is used as the trigger.</p>  |  <p>Sampled values are saved as Current Sample Data.</p> |
| Fast | | | | |
| Normal | | | | |
| Sound | | | | |
| Extended | | | <p>Pressing [F1] advances to "4. Graphing".
Pressing [EXE] there returns to "3. Sampling".</p>  | <p>Graph screen does not show all sampled values, but only a partial preview.</p>  <p>Pressing [F1] leads to 'Try Again?' dialog box with 'Yes: [F1]' and 'No: [F6]'.</p>  <p>Pressing [EXE] leads to 'Speaker output: Press [EXE]' dialog box.</p>  <p>Pressing [EXE] leads to a graph showing sampled data.</p>  <p>Pressing [STOP] key on Ea-200 MICSound V5 piece leads to another graph.</p>  |
| Period | | | | <p>The following three graph types can be produced when Photogate-Pulley is being used.</p> <ol style="list-style-type: none"> 1. Time and distance graph 2. Time and velocity graph 3. Time and acceleration graph <p>Sample values are stored as List data only.</p> <p>• When Number of Samples = 1</p>  <p>• When Number of Samples > 1</p>  |
| Clock | | | | |

9. Using Sample Data Memory

Performing a Data Logger sampling operation from the **E-CON3** mode causes sampled results to be stored in the “current data area” of E-CON3 memory. Separate data is saved for each channel, and the data for a particular channel in the current data area is called that channel’s “current data”.

Any time you perform a sampling operation, the current data of the channel(s) you use is replaced by the newly sampled data. If you want to save a set of current data and keep it from being replaced by a new sampling operation, save the data in sample data memory under a different file name.

■ Managing Sample Data Files

- **To save current sample data to a file**

1. On the E-CON3 main menu (page ε-1), press **[F5]** (GRAPH).
 - This displays the Graph Mode screen.

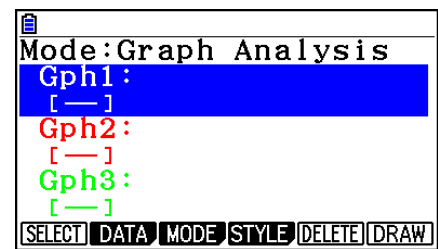

Graph Mode Screen

- For details about the Graph Mode screen, see “Using the Graph Analysis Tools to Graph Data” (page ε-35).
2. Press **[F2]** (DATA).
 - This displays the Sampling Data List screen.

List of current data files —————
 “cd” stands for “current data”. The text on the right side of the colon indicates the channel name.

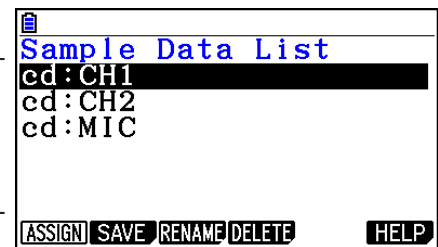

Sampling Data List Screen

3. Use the **▲** and **▼** cursor keys to move the highlighting to the current data file you want to save, and then press **[F2]** (SAVE).
 - This displays the screen for inputting a data name.

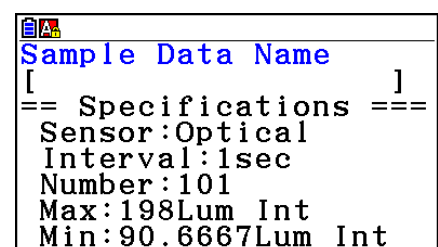

Using Sample Data Memory

4. Enter up to 18 characters for the data file name, and then press **[EXE]**.
 - This displays a dialog box for inputting a memory number.
5. Enter a memory number in the range of 1 to 99, and then press **[EXE]**.
 - This saves the sample data at the location specified by the memory number you input.

The sample data file you save is indicated on the display using the format:
<memory number>:<file name>.

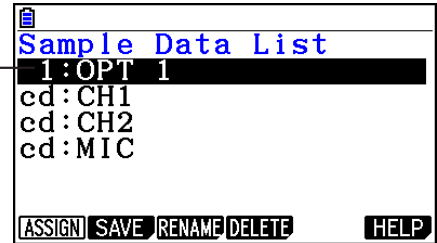

- If you specify a memory number that is already being used to store a data file, a confirmation message appears asking if you want to replace the existing file with the new data file. Press **[F1]** to replace the existing data file, or **[F6]** to return to the memory number input dialog box in step 4.
6. To return to the E-CON3 main menu (page ε-1), press **[EXIT]** twice.

Note

- You could select another data file besides a current data file in step 3 of the above procedure and save it under a different memory number. You do not need to change the file's name as long as you use a different file number.

10. Using the Graph Analysis Tools to Graph Data

Graph Analysis tools make it possible to analyze graphs drawn from sampled data.

■ Accessing Graph Analysis Tools

You can access Graph Analysis tools using either of the two methods described below.

- **Accessing Graph Analysis tools from the Graph Mode screen, which is displayed by pressing **F5** (GRAPH) on the E-CON3 main menu (page ε-1)**

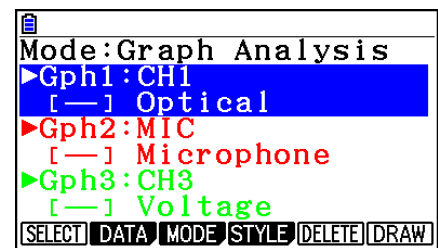

Graph Mode Screen

- The main menu appears after you perform a sampling operation. Press **F5** (GRAPH) at that time.
- When you access Graph Analysis tools using this method, you can select from among a variety of other Analysis modes. See “Selecting an Analysis Mode and Drawing a Graph” (page ε-36) for more information about the other Analysis modes.
- **Accessing Graph Analysis tools from the screen of a graph drawn after a sampling operation is executed from the Setup Wizard or from Advanced Setup (Real-time Mode)**

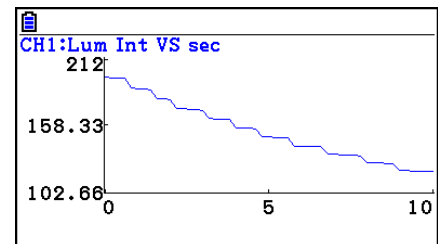

Graph Screen

- In this case, data is graphed after the sampling operation is complete, and the calculator accesses Graph Analysis tools automatically. See “Graph Screen Key Operations” on page ε-39.

■ Selecting an Analysis Mode and Drawing a Graph

This section contains a detailed procedure that covers all steps from selecting an analysis mode to drawing a graph.

Note

- Step 4 through step 7 are not essential and may be skipped, if you want. Skipping any step automatically applies the initial default values for its settings.
- If you skip step 2, the default analysis mode is the one whose name is displayed in the top line of the Graph Mode screen.

• To select an analysis mode and draw a graph

1. On the E-CON3 main menu (page ε-1), press **[F5]** (GRAPH).
 - This displays the Graph Mode screen.
2. Press **[F3]** (MODE), and then select the analysis mode you want from the menu that appears.

| To do this: | Perform this menu operation: | To select this mode: |
|------------------------------------------------------------------------------------------------------------------------------------------------------|------------------------------------------------|-----------------------------------------|
| Graph three sets of sampled data simultaneously | [Norm] | Graph Analysis |
| Graph sampled data along with its first and second derivative graph | [diff] | d/dt & d ² /dt ² |
| Display the graphs of different sampled data in upper and lower windows for comparison | [COMPARE] → [GRAPH] | Compare Graph |
| Output sampled data from the speaker, displaying graph of the raw data in the upper window and the output waveform in the lower window (EA-200 only) | [COMPARE] → [Sound] | Compare Sound |
| Display the graph of sampled data in the upper window and its first derivative graph in the lower window | [COMPARE] → [d/dt] | Compare d/dt |
| Display the graph of sampled data in the upper window and its second derivative graph in the lower window | [COMPARE] → [d ² /dt ²] | Compare d ² /dt ² |

- The name of the currently selected mode appears in the top line of the Graph Mode screen.

Analysis mode name

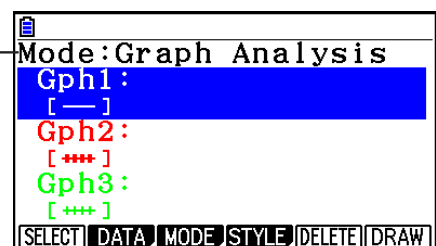

Using the Graph Analysis Tools to Graph Data

3. Press **F2** (DATA).
 - This displays the Sampling Data List screen.
4. Specify the sampled data for graphing.
 - a. Use the **▲** and **▼** cursor keys to move the highlighting to the name of the sampled data file you want to select, and then press **F1** (ASSIGN) or **EXE**.
 - This returns to the Graph Mode screen, which shows the name of the sample data file you selected.

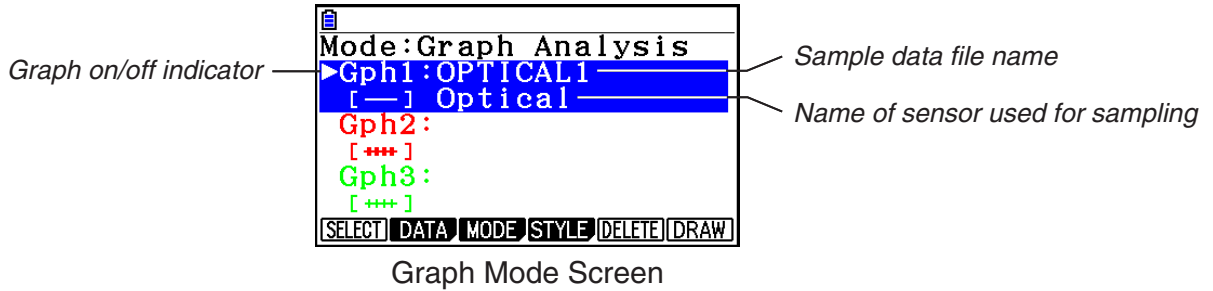

- b. Repeat step a above to specify sample data files for other graphs, if there are any.
 - If you select “Graph Analysis” as the analysis mode in step 2, you must specify sample data files for three graphs. If you select “Compare Graph” as the analysis mode in step 2, you must specify sample data files for two graphs. With other modes, you need to specify only one sample data file.
 - For details about Sampling Data List screen operations, see “Using Sample Data Memory” (page ε-33).
5. Turn on graphing for each of the graphs listed on the Graph Mode screen.
 - a. On the Graph Mode screen, use the **▲** and **▼** cursor keys to select a graph, and then press **F1** (SELECT) to toggle graphing on or off.

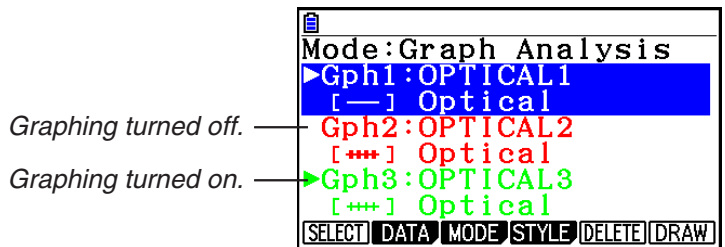

- b. Repeat step a to turn each of the graphs listed on the Graph Mode screen on or off.
6. Select the graph style you want to use.
 - a. On the Graph Mode screen, use the **▲** and **▼** cursor keys to move the highlighting to the graph (Gph1, Gph2, etc.) whose style you want to specify, and then press **F4** (STYLE). This will cause the function menu to change as shown below.

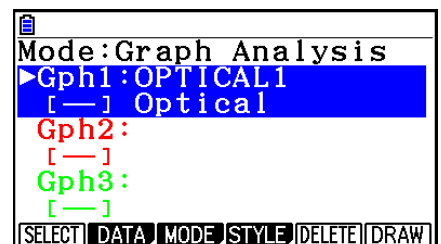

Using the Graph Analysis Tools to Graph Data

b. Use the function keys to specify the graph style you want.

| To specify this graph style: | Press this key: |
|----------------------------------------------|---------------------|
| Line graph with dot (•) data markers | F1 (—) |
| Line graph with square (□) data markers | F2 (■■■■) |
| Line graph with X (×) data markers | F3 (××××) |
| Scatter graph with dot (•) data markers | F4 (.....) |
| Scatter graph with square (□) data markers | F5 (■■■■) |
| Scatter graph with X (×) data markers | F6 (××××) |

c. Repeat a and b to specify the style for each of the graphs on the Graph Mode screen.

7. On the Graph Mode screen, press **F6** (DRAW) or **EXE**.

- This draws the graph(s) in accordance with the settings you configured in step 2 through step 6.

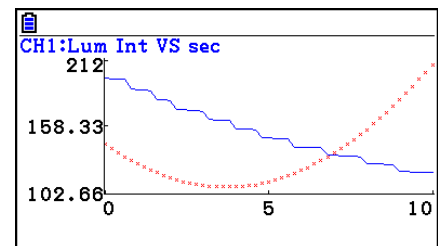

Graph Screen

- When a Graph screen is on the display, the function keys provide you with zooming and other capabilities to aid in graph analysis.

For details about Graph screen function key operations, see the following section.

• **To deselect sampled data assigned for graphing on the Graph Mode screen**

1. On the Graph Mode screen, use the **▲** and **▼** cursor keys to move the highlighting to the graph (Gph1, Gph2, etc.) whose sampled data you want to deselect.
2. Press **F5** (DELETE).
 - This will deselect sample data assigned to the highlighted graph.

11. Graph Analysis Tool Graph Screen Operations

This section explains the various operations you can perform on the graph screen after drawing a graph.

You can perform these operations on a graph screen produced by a sampling operation, or by the operation described under “Selecting an Analysis Mode and Drawing a Graph” on page ε-36.

■ Graph Screen Key Operations

On the graph screen, you can use the keys described in the table below to analyze (CALC) graphs by reading data points along the graph (Trace) and enlarging specific parts of the graph (Zoom).

| Key Operation | Description |
|---------------------------------|----------------------------------------------------------------------------------------------------------------------------------------------------------------------------------------------------------------------------------------------------------------------------------------------------------------|
| SHIFT F1 (TRACE) | Displays a trace pointer on the graph along with the coordinates of the current cursor location. Trace can also be used to obtain the periodic frequency of a specific range on the graph and assign it to a variable. See “Using Trace” on page ε-40. |
| SHIFT F2 (ZOOM) | Starts a zoom operation, which you can use to enlarge or reduce the size of the graph along the x -axis or the y -axis. See “Using Zoom” on page ε-41. |
| SHIFT F3 (V-WIN) | Displays a function menu of special View Window commands for the E-CON3 mode graph screen.
For details about each command, see “Configuring View Window Parameters” on page ε-49. |
| SHIFT F4 (SKETCH) | Displays a menu that contains the following commands: Cls, Plot, F-Line, Text, PEN, Vertical, and Horizontal. For details about each command, see “Drawing Dots, Lines, and Text on the Graph Screen (Sketch)” on page 5-50. |
| OPTN F1 (PICTURE) | Saves the currently displayed graph as a graphic image. You can recall a saved graph image and overlay it on another graph to compare them. For details about these procedures, see “Saving and Recalling Graph Screen Contents” on page 5-20. |
| OPTN F2 (LISTMEM) | Displays a menu of functions for saving the sample values in a specific range of a graph to a list. See “Transforming Sampled Data to List Data” on page ε-42. |
| OPTN F3 (EDIT) | Displays a menu of functions for zooming and editing a particular graph when the graph screen contains multiple graphs. See “Working with Multiple Graphs” on page ε-46. |
| OPTN F4 (CALC) | Displays a menu that lets you transform a sample result graph to a function using Fourier series expansion, and to perform regression to determine the tendency of a graph. See “Using Fourier Series Expansion to Transform a Waveform to a Function” on page ε-43, and “Performing Regression” on page ε-44. |

| Key Operation | Description |
|---------------------------------|------------------------------------------------------------------------------------------------------------------------------------------------------------------------------------------------|
| OPTN F5 (Y=fx) | Displays the graph relation list, which lets you select a Y=f(x) graph to overlay on the sampled result graph. See “Overlaying a Y=f(x) Graph on a Sampled Result Graph” on page ε-45. |
| OPTN F6 (SPEAKER) | Starts an operation for outputting a specific range of a sound data waveform graph from the speaker (EA-200 only). See “Outputting a Specific Range of a Graph from the Speaker” on page ε-48. |

■ Scrolling the Graph Screen

Press the cursor keys while the graph screen is on the display scrolls the graph left, right, up, or down.

Note

- The cursor keys perform different operations besides scrolling while a trace or graph operation is in progress. To perform a graph screen scroll operation in this case, press **EXIT** to cancel the trace or graph operation, and then press the cursor keys.

■ Using Trace

Trace displays a crosshair pointer on the displayed graph along with the coordinates of the current cursor position. You can use the cursor keys to move the pointer along the graph. You can also use trace to obtain the periodic frequency value for a particular range, and assign the range (time) and periodic frequency values in separate Alpha memory variables.

• To use trace

1. On the graph screen, press **SHIFT** **F1** (TRACE).
 - This causes a trace pointer to appear on the graph. The coordinates of the current trace pointer location are also shown on the display.

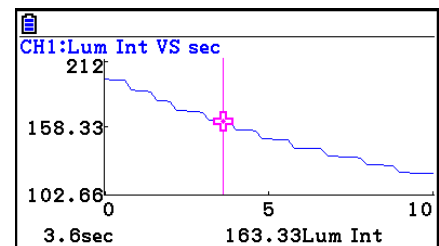

2. Use the **◀** and **▶** cursor keys to move the trace pointer along the graph to the location you want.
 - The coordinate values change in accordance with the trace pointer movement.
 - You can exit the trace pointer at any time by pressing **EXIT**.

• To obtain the periodic frequency value

1. Use the procedure under “To use trace” above to start a trace operation.
2. Move the trace pointer to the start point of the range whose periodic frequency you want to obtain, and then press **EXE**.

3. Move the trace pointer to the end point of the range whose periodic frequency you want to obtain.

- This causes the period and periodic frequency value at the start point you selected in step 2 to appear along the bottom of the screen.

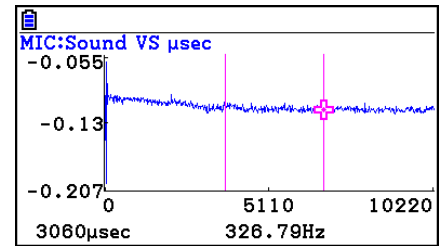

4. Press **[EXE]** to assign the period and periodic frequency values to Alpha memory variables.

- This displays a dialog box for specifying variable names for [Period] and [Frequency] values.
- The initial default variable name settings are “S” for the period and “H” for the periodic frequency. To change to another variable name, use the up and down cursor keys to move the highlighting to the item you want to change, and then press the applicable letter key.

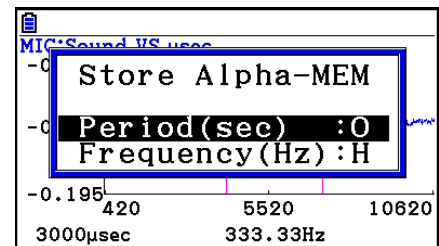

5. After everything is the way you want, press **[EXE]**.

- This stores the values and exits the trace operation.
- For details about using Alpha memory, see Chapter 2 of this manual.

■ Using Zoom

Zoom lets you enlarge or reduce the size of the graph along the *x*-axis or the *y*-axis.

Note

- When there are multiple graphs on the screen, the procedure below zooms all of them. For information about zooming a particular graph when there are multiple graphs on the screen, see “Working with Multiple Graphs” on page ε-46.

• To zoom the graph screen

1. On the graph screen, press **[SHIFT] [F2]** (ZOOM).

- This causes a magnifying glass cursor () to appear in the center of the screen.

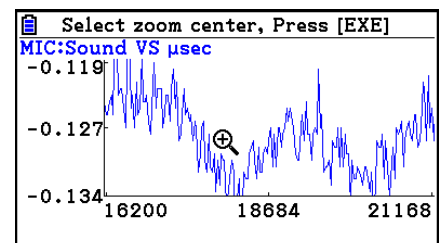

2. Use the cursor keys to move the magnifying glass cursor to the location on the screen that you want at the center of the enlarged or reduced screen.

3. Press **[EXE]**.
 - This causes the magnifying glass to disappear and enters the zoom mode.
 - The cursor keys perform the following operations in the zoom mode.

| To do this: | Press this cursor key: |
|-------------------------------------------------|------------------------|
| Enlarge the graph image horizontally | |
| Reduce the size of the graph image horizontally | |
| Enlarge the graph image vertically | |
| Reduce the size of the graph image vertically | |

4. To exit the zoom mode, press **[EXIT]**.

■ Transforming Sampled Data to List Data

Use the following procedure to transform the sampled data in a specific range of a graph into list data.

• To transform sampled data to list data

1. On the graph screen, press **[OPTN]**, and then **[F2]** (LISTMEM).
 - This displays the LISTMEM menu.
2. Press **[F2]** (SELECT).
 - This displays the trace pointer for selecting the range on the graph.
3. Move the trace pointer to the start point of the range you want to convert to list data, and then press **[EXE]**.

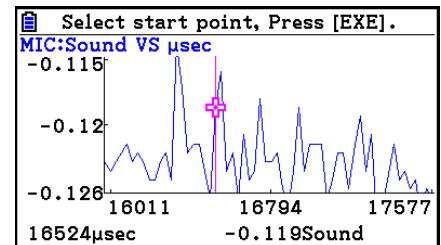

4. Move the trace pointer to the end point of the range you want to convert to list data, and then press **[EXE]**.
 - This displays a dialog box for specifying the lists where you want to store the time data and the sampled data.

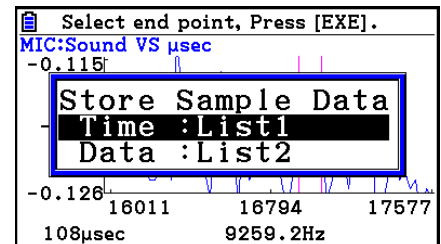
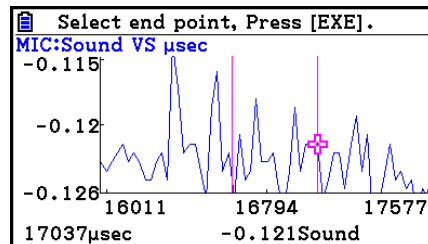

- The initial default lists are List 1 for the time and List 2 for sample data. To change to another list (List 1 to List 26), use the up and down cursor keys to move the highlighting to the list you want to change, and then input the applicable list number.

5. After everything is the way you want, press **[EXE]**.
 - This saves the lists and the message “Complete!” appears. Press **[EXE]** to return to the graph screen.
 - For details about using list data, see Chapter 3 of this manual.

Note

- Pressing **[F1]**(All) in place of **[F2]**(SELECT) in step 2 converts the entire graph to list data. In this case, the “Store Sample Data” dialog box appears as soon as you press **[F1]**(All).

■ Using Fourier Series Expansion to Transform a Waveform to a Function

Fourier series expansion is effective for studying sounds by expressing them as functions. The procedure below assumes that there is a graph of sampled sound data already on the graph screen.

• **To perform Fourier series expansion**

1. On the graph screen, press **[OPTN]**, and then **[F4]**(CALC).
 - The CALC menu appears at the bottom of the display.

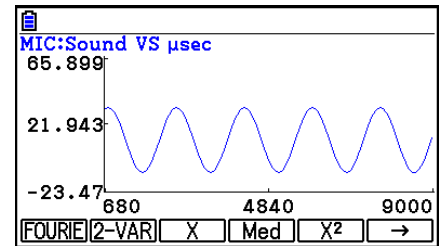

2. Press **[F1]**(FOURIE).
 - This displays the trace pointer for selecting the graph range.
3. Move the trace pointer to the start point of the range for which you want to perform Fourier series expansion, and then press **[EXE]**.

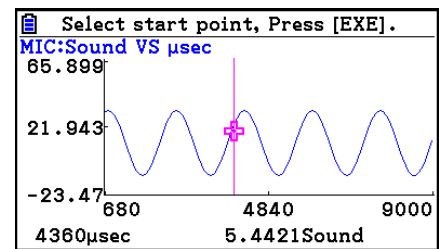

4. Move the trace pointer to the end point of the range for which you want to perform Fourier series expansion, and then press **[EXE]**.
 - This displays a dialog box for specifying the start degree of the Fourier series.

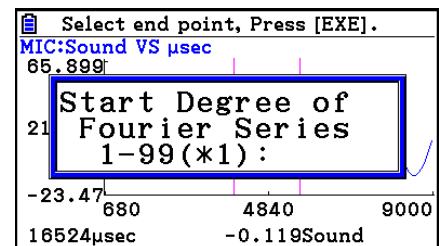
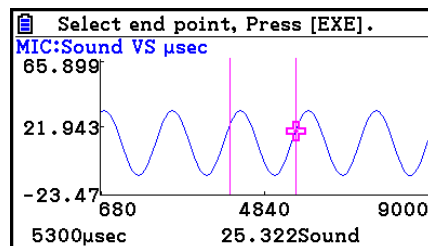

5. Input a value in the range of 1 to 99, and then press **[EXE]**.

- This displays a dialog box for inputting the degree of the Fourier series.

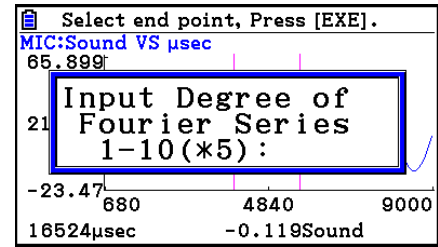

6. Input a value in the range of 1 to 10, and then press **[EXE]**.

- The graph relation list appears with the calculation result.

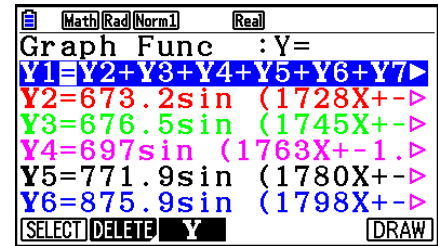

7. Pressing **[F6]** (DRAW) here graphs the function.

- This lets you compare the expanded function graph and the original graph to see if they are the same.

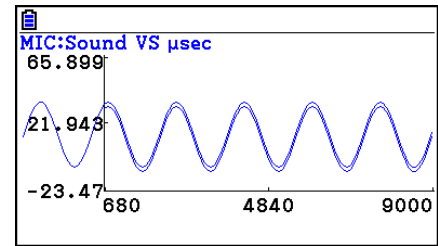

Note

- When you press **[F6]** (DRAW) in step 7, the graph of the result of the Fourier series expansion may not align correctly with the original graph on which it is overlaid. If this happens, shift the position the original graph to align it with the overlaid graph.

For information about how to move the original graph, see “To move a particular graph on a multi-graph display” (page ε-47).

■ Performing Regression

You can use the procedure below to perform regression for a range specified using the trace pointer. All of the following regression types are supported: Linear, Med-Med, Quadratic, Cubic, Quartic, Logarithmic, Exponential, Power, Sine, and Logistic.

For details about these regression types, see Chapter 6 of this manual.

The following procedure shows how to perform quadratic regression. The same general steps can also be used to perform the other types of regression.

• **To perform quadratic regression**

1. On the graph screen, press **[OPTN]**, and then **[F4]** (CALC).
 - The CALC menu appears at the bottom of the display.
2. Press **[F5]** (X^2).
 - This displays the trace pointer for selecting the range on the graph.

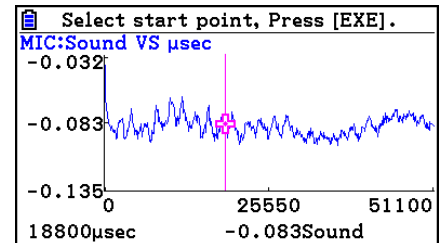

3. Move the trace pointer to the start point of the range for which you want to perform quadratic regression, and then press **[EXE]**.
4. Move the trace pointer to the end point of the range for which you want to perform quadratic regression, and then press **[EXE]**.
 - This displays the quadratic regression calculation result screen.

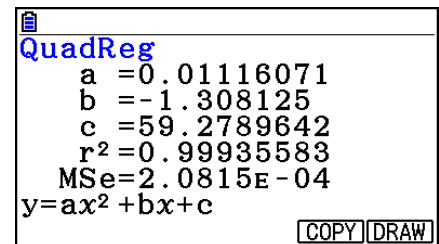

5. Press **[F6]** (DRAW).
 - This draws a quadratic regression graph and overlays it over the original graph.
 - To delete the overlaid quadratic regression graph, press **[SHIFT]** **[F4]** (SKETCH) and then **[F1]** (Cls).

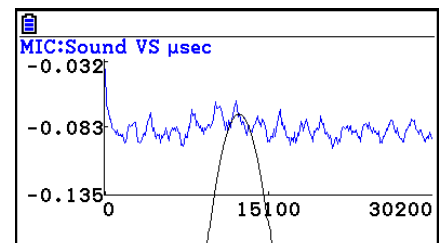

■ **Overlaying a $Y=f(x)$ Graph on a Sampled Result Graph**

You can use the **E-CON3** mode to graph equations based on the form $Y=f(x)$. From the graph screen, press **[OPTN]** **[F5]** ($Y=fx$) to display the graph relation list screen. From there, operations are identical to those in the **Graph** mode.

Note

- The data on the graph relation list screen is shared with the **Graph** mode. Note, however, that only $Y=$ type graphs can be used in the **E-CON3** mode. Because of this, calling up the graph relation list screen from the **E-CON3** mode will display a “ Y ” ($Y=$ type) item for function menu key **[F3]**. Also, **[F5]** (MODIFY) is not displayed, because it is not used in the **E-CON3** mode.

■ Working with Multiple Graphs

The procedures in this section explain how you can zoom or move a particular graph when there are multiple graphs on the display.

• To zoom a particular graph on a multi-graph display

1. When the graph screen contains multiple graphs, press **[OPTN]**, and then **[F3]** (EDIT).
 - The EDIT menu appears at the bottom of the display.

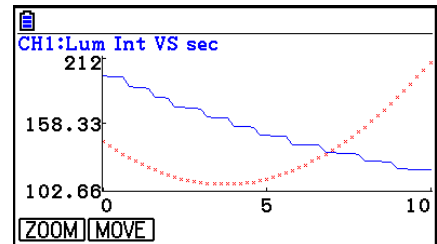

2. Press **[F1]** (ZOOM).
 - This displays only one of the graphs that were originally on the graph screen.

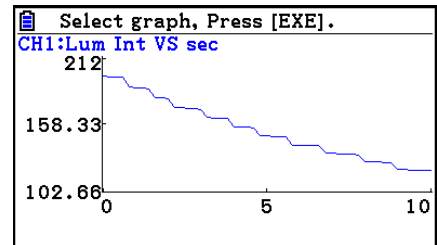

3. Use the **▲** and **▼** cursor keys to cycle through the graphs until the one you want is displayed, and then press **[EXE]**.
 - This enters the zoom mode and causes all of the graphs to reappear, along with a magnifying glass cursor (🔍) in the center of the screen.

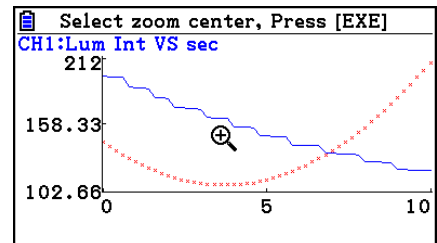

4. Use the cursor keys to move the magnifying glass cursor to the location on the screen that you want at the center of the enlarged or reduced screen.

Graph Analysis Tool Graph Screen Operations

5. Press **[EXE]**.

- This causes the magnifying glass to disappear and enters the zoom mode.
- The cursor keys perform the following operations in the zoom mode.

| To do this: | Press this cursor key: |
|-------------------------------------------------|------------------------|
| Enlarge the graph image horizontally | ▶ |
| Reduce the size of the graph image horizontally | ◀ |
| Enlarge the graph image vertically | ▲ |
| Reduce the size of the graph image vertically | ▼ |

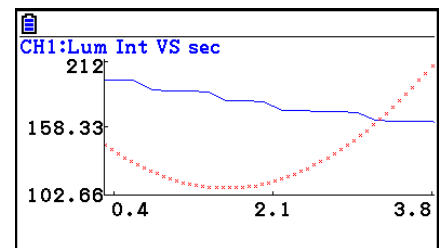
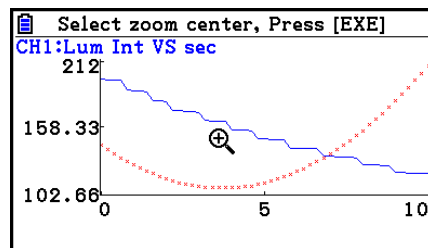

6. To exit the zoom mode, press **[EXIT]**.

• **To move a particular graph on a multi-graph display**

1. When the graph screen contains multiple graphs, press **[OPTN]**, and then **[F3]** (EDIT).
 - This displays the EDIT menu.
2. Press **[F2]** (MOVE).
 - This displays only one of the graphs that were originally on the graph screen.
3. Use the **▲** and **▼** cursor keys to cycle through the graphs until the one you want is displayed, and then press **[EXE]**.
 - This enters the move mode and causes all of the graphs to reappear.
4. Use the **◀** and **▶** cursor keys to move the graph left and right, or the **▲** and **▼** cursor keys to move the graph up and down.

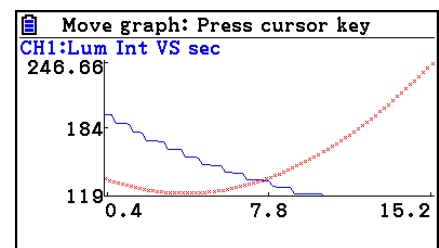
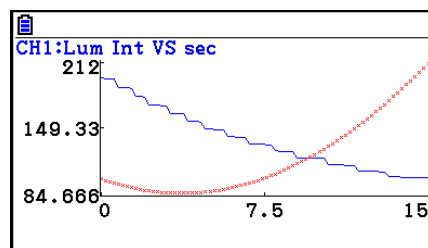

5. To exit the move mode, press **[EXIT]**.

■ Outputting a Specific Range of a Graph from the Speaker (EA-200 only)

Use the following procedure to output a specific range of a sound data waveform graph from the speaker.

• To output a graph from the speaker

1. On the graph screen, press **[OPTN]**, and then **[F6]** (SPEAKER).

- This displays the trace pointer for selecting the range on the graph.

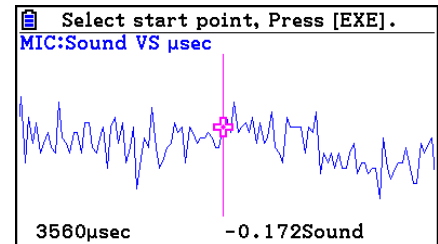

2. Move the trace pointer to the start point of the range you want to output from the speaker, and then press **[EXE]**.
3. Move the trace pointer to the end point of the range you want to output from the speaker, and then press **[EXE]**.
 - After you specify the start point and end point, an output frequency dialog box shown below appears on the display.

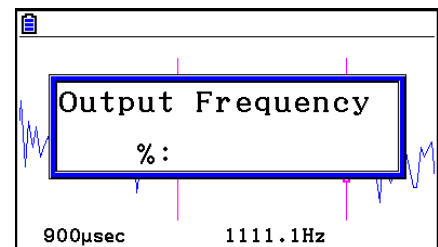
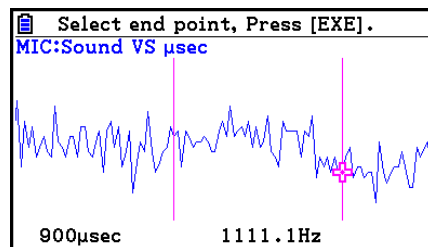

4. Input a percent value for the output frequency value you want.
 - The output frequency specification is a percent value. To output the original sound as-is, specify 100%. To raise the original sound by one octave, input a value of 200%. To lower the original sound by one octave, input a value of 50%.
5. After inputting an output frequency value, press **[EXE]**.
 - This outputs the waveform between the start point and end point from the EA-200 speaker.
 - If the sound you configured cannot be output for some reason, the message "Range Error" will appear. If this happens, press **[EXIT]** to scroll back through the previous setting screens and change the setup as required.
6. To terminate sound output, press the EA-200 **[START/STOP]** key.
7. Press **[EXE]**.
 - This displays a screen like the one shown nearby.

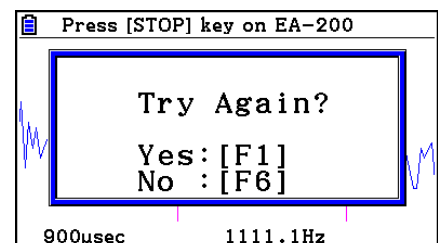

8. If you want to retry output from the speaker, press **[F1]** (Yes). To exit the procedure and return to the graph screen, press **[F6]** (No).
 - Pressing **[F1]** (Yes) returns to the “Output Frequency” dialog box. From there, repeat the above steps from step 4.

■ Configuring View Window Parameters

Pressing **[SHIFT]** **[F3]** (V-Window) while the graph screen is on the display displays a View Window function key menu along the bottom of the display.

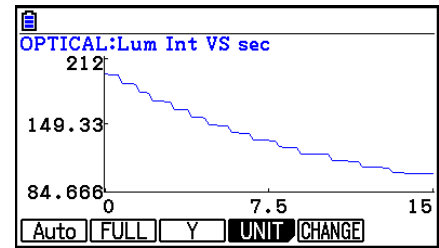

Press the function key that corresponds to the View Window parameter you want to configure.

| Function Key | Description |
|----------------------|----------------------------------------------------------------------------------------------------------------------------------------------------------------------------------------------------------------------------------------------------------------------------------------------------------------------------------------------------------------------------|
| [F1] (Auto) | Automatically applies the following View Window parameters.
Y-axis Elements: In accordance with screen size
X-axis Elements: In accordance with screen size when 1 data item equals 1 dot; 1 data equals 1 dot in other cases |
| [F2] (FULL) | Resizes the graph so all of it fits in the screen. |
| [F3] (Y) | Resizes the graph so all of it fits in the screen along the Y-axis, without changing the X-axis dimensions. |
| [F4] (UNIT) | Specifies the unit of the numeric axis grid displayed by the Econ Axes setting of the graph setup screen (page ε-17).
[F1] (μsec): microseconds
[F2] (msec): milliseconds
[F3] (Sec): seconds
[F4] (DHMS): days, hours, minutes, seconds (1 day, 2 hours, 30 minutes, 5 seconds = 1d2h30m5s)
[F5] (Auto): Auto selection |
| [F5] (CHANGE) | Toggles display of the source data on the graph screen on and off. |

To exit the View Window function key menu and return to the standard function key menu, press **[EXIT]**.

12. Calling E-CON3 Functions from an eActivity

You can call E-CON3 functions from an eActivity by including an “Econ strip” in the eActivity file. The following describes each of the four available Econ strips.

- **Econ SetupWizard strip**

This strip calls the E-CON3 Setup Wizard. The Econ SetupWizard strip makes it possible to perform the following series of operations from the eActivity: Data Logger setup using the Setup Wizard → Sampling → Graphing.

Note

- In the case of the Econ SetupWizard strip, the “3: Convert Program” is not available on the “Complete!” dialog box.

- **Econ AdvancSetup strip**

This strip calls the E-CON3 Advanced Setup screen. The Advanced Setup provides access to almost all executable functions (except for the program converter), including detailed Data Logger setup and sampling execution; graphing and Graph Analysis Tools; simultaneous sampling with multiple sensors using the MULTIMETER mode, etc.

Note

- Using an Econ AdvancSetup strip to configure a setup causes the setup information to be registered in the applicable strip. This means that the next time you open the strip, sampling can be performed in accordance with the previously configured setup information.

- **Econ Sampling strip**

This strip executes Data Logger measurement. To store Data Logger setup information for this strip, perform the Econ Advance Setup operation the first time the strip is executed.

- **Econ Graph strip**

This strip graphs sampled data that is recorded in the strip. The sampled data is recorded to the strip the first time the strip is executed.

- **Econ Strip Memory Capacity Precautions**

- The memory capacity of each Econ strip is 25 KB. An error will occur if you perform an operation that causes this capacity to be exceeded. Particular care is required when handling a large number of samples, which can cause memory capacity to be exceeded.
- Always make sure that FFT Graph is turned off whenever performing sampling with the microphone. Leaving FFT Graph turned on cause memory capacity to be exceeded.
- If an error occurs, press **SHIFT** **→** () to return to the eActivity workspace screen and perform the procedure again.
- For information about checking the memory usage of each strip, see “To display the strip memory usage screen” on page 10-21.

For details about eActivity operations, see Chapter 10 of this manual.

EAC

NL

**Batterij niet weggooien,
maar inleveren als
KCA**

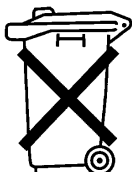

CE

Manufacturer:
CASIO COMPUTER CO., LTD.
6-2, Hon-machi 1-chome
Shibuya-ku, Tokyo 151-8543, Japan

Responsible within the European Union:
Casio Europe GmbH
Casio-Platz 1
22848 Norderstedt, Germany
www.casio-europe.com

CASIO®

CASIO COMPUTER CO., LTD.

6-2, Hon-machi 1-chome
Shibuya-ku, Tokyo 151-8543, Japan

One or more of the following patents may be used in the product.

U.S.Pats. 5,901,074 7,927,221 8,214,413 8,576,230 8,817,027 9,007,376

SA1511-G

© 2013 CASIO COMPUTER CO., LTD.

Free Manuals Download Website

<http://myh66.com>

<http://usermanuals.us>

<http://www.somanuals.com>

<http://www.4manuals.cc>

<http://www.manual-lib.com>

<http://www.404manual.com>

<http://www.luxmanual.com>

<http://aubethermostatmanual.com>

Golf course search by state

<http://golfingnear.com>

Email search by domain

<http://emailbydomain.com>

Auto manuals search

<http://auto.somanuals.com>

TV manuals search

<http://tv.somanuals.com>