

Palsonic

DVD7000 User's Manual

DVD Player



Introduction

■ Safety Precautions	2
■ Important Safety Instructions.....	3
■ Caution	4
■ Features	5
■ Front Panel and Rear Panel Illustration	6
■ VFD Illustration	7
■ Remote Controller	8

Connections

■ Connecting to a TV Set	9
■ Connecting to an AV Amplifier with 2 Channels Analog Audio Input	10
■ Connecting to an AV Amplifier with 5.1 Channels Analog Audio Input	11
■ Connecting to a AV Amplifier with Digital Audio Input	12

Basic Playback

■ Basic Operation	13
-------------------------	----

Function Illustrations

■ Modes and Features Setup	14
■ Remote Controller Operation	21
■ Enjoying Karaoke	32
■ MP3 Playback	33
■ Kodak Picture CD Playback	34

Others

■ Trouble Shooting	36
■ Specifications	37
■ Remote Controller Preparation	38

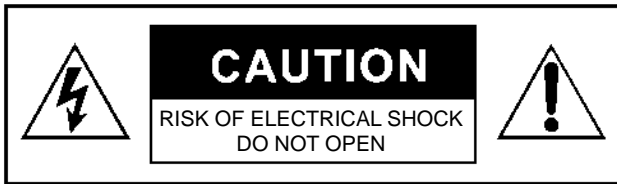

THE LIGHTNING FLASH WITH ARROWHEAD SYMBOL WITHIN AN EQUILATERAL TRIANGLE IS INTENT TO ALERT THE USER TO THE PRESENCE OF UNINSULATED "DANGEROUS VOLTAGE" WITHIN THE UNIT'S CABINET THAT MAY BE OF SUFFICIENT MAGNITUDE TO CONSTITUTE A RISK OF ELECTRIC SHOCK TO PERSONS.



THE EXCLAMATION POINT WITHIN AN EQUILATERAL TRIANGLE IS INTENDED TO ALERT THE USER TO THE PRESENCE OF IMPORTANT OPERATING AND MAINTENANCE (SERVICING) INSTRUCTIONS IN THE MANUAL ACCOMPANYING THE UNIT.

WARNING:

TO PREVENT FIRE OR ELECTRIC SHOCKS, DO NOT EXPOSE THE UNIT TO RAIN OR MOISTURE. NEVER ATTEMPT TO OPEN THE CABINET, DANGEROUS HIGH VOLTAGES ARE PRESENT IN THE UNIT. REFER SERVICING TO QUALIFIED SERVICE PERSONNEL.

CAUTION:

TO PREVENT ELECTRIC SHOCKS, MATCH WIDE-BLADE PLUG WITH WIDE SLOT, FULLY INSERT. THE APPARATUS SHALL NOT BE EXPOSED TO DRIPPING OR SPLASHING AND THAT NO OBJECTS FILLED WITH LIQUIDS SUCH AS VASES SHALL BE PLACED ON THE APPARATUS.

CAUTION:

THE UNIT EMPLOYS A LASER SYSTEM. TO ENSURE THE PROPER USE OF THE UNIT, READ THIS MANUAL CAREFULLY AND KEEP IT FOR FUTURE REFERENCE.

IF THE UNIT REQUIRES SERVICING, CONTACT THE SELLER OR OUR SERVICE CENTRE - SEE "TROUBLE SHOOTING".

TO PREVENT DIRECT EXPOSURE TO THE LASER RADIATION, DO NOT OPEN THE CABINET. VISIBLE LASER MAY RADIATE WHEN THE CABINET OPENED OR THE INTERLOCKS ARE DEFEATED. DO NOT STARE INTO THE LASER BEAMS.

CAUTION:

THE DVD VIDEO PLAYER IS A CLASS 1 LASER PRODUCT. USE OF CONTROLS OR ADJUSTMENTS OR PERFORMANCE OF PROCEDURES OTHER THAN THOSE SPECIFIED HEREIN MAY RESULT IN HAZARDOUS RADIATION EXPOSURE.

AS THE LASER BEAM USED IN THIS DVD VIDEO PLAYER IS HARMFUL TO THE EYES, DO NOT ATTEMPT TO DISASSEMBLE THE CABINET. REFER SERVICING TO QUALIFIED PERSONNEL ONLY.

WARNING:

FCC REGULATIONS STATE THAT ANY CHANGE OR MODIFICATION TO THE EQUIPMENT, NOT EXPRESSLY APPROVED BY MAKER OR ITS AUTHORISED PARTIES, COULD VOID USERS AUTHORITY TO OPERATE THIS EQUIPMENT.

Remark

PLEASE WRITE DOWN THE MODEL NO. AND SERIAL NO. PRINTED ON THE REAR PANEL AT THE BLANK BELOW.

Model No. _____

Serial No. _____

- 1) Read these instructions.
- 2) Keep these instructions.
- 3) Heed all warnings.
- 4) Follow all instructions.
- 5) Do not use this apparatus near water.
- 6) Clean only with dry cloth.
- 7) Do not block any ventilation openings. Install in accordance with the manufacturer's instructions.
- 8) Do not install near any heat sources such as radiators, heat registers, stoves, or other apparatus (including amplifiers) that produce heat.
- 9) Do not defeat the safety purpose of the polarised or grounding-type plug. A polarised plug has two blades with one wider than the other. A grounding type plug has two blades and a third grounding prong. The wide blade or the third prong are provided for your safety. If the provided plug does not fit into your outlet, consult an electrician for replacement of the obsolete outlet.
- 10) Protect the power cord from being walked on or pinched particularly at plugs, convenience receptacles, and the point where they exit from the apparatus.
- 11) Only use attachments/accessories specified by the manufacturer.
- 12) Use only with the cart, stand, tripod, bracket, or table specified by the manufacturer. or sold with the apparatus. When a cart is used, use caution when moving the cart/apparatus combination to avoid injury from tip-over.
- 13) Unplug this apparatus during lightning storms or when unused for a long periods of time.
- 14) Refer all servicing to qualified service personnel. Servicing is required when the apparatus has been damaged in any way, such as power-supply cord or plug is damaged, liquid has been spilled or objects have fallen into the apparatus, the apparatus has been exposed to rain or moisture, does not operate normally, or has been dropped.

- For safety, please use the original box and packing materials, and keep the mode of packing same as the original.

- When you repackage this product. Do not place this product near the volatile liquid such as insecticide.













- It is normal for the cover and rear panel become warm after the player has been operating for a long time.

- Do not move this product during playback. Otherwise, it may cause damage to the pick-up and the disc.

- Press **OPEN/CLOSE** on the front panel or remote to open or close the disc tray. While it is opening or closing, do not push, or touch the tray.

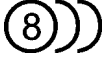
- **Dual Decoding: Dolby Digital AC-3 and DTS Decoding**
- **Full compatibility with DVD, SVCD, VCD, CD, MP3, and Kodak picture CD on CD-RW & CD-RW (finalised)**
- **Screensaver**
- **Multiple playback modes: Memory, Program, Search, 10-Second Review**
- **Dynamic spectrum display and 6 frequency bands adjustable**
- **5.1 CH, 2 CH, Optical and Coaxial digital output**
- **Composite Video, S-Video and Component (YCbCr) video outputs**

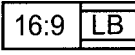
Disc formats supported by this player:

	Digital Theatre System		MP3 files on CD-R/CD-RW
	Dolby Digital		Multi-angle
	Kodak Picture CDs		Close Caption
	Audio CDs		Subtitle choices
	Video CDs		Audio choices
	DVD video		TV Aspect Ratio mode
	Parental Lock		

This product incorporates copyright protection technology that is protected by method claims of certain U.S. patents and other intellectual property rights owned by Macrovision Corporation and other rights owners. Use of this copyright protection technology must be authorised by Macrovision Corporation, and is intended for home and other limited viewing uses only unless otherwise authorised by Macrovision Corporation. Reverse engineering or disassembly is prohibited.

The product complies with KODAK Picture CD format and will display KODAK Picture CDs. The "KODAK Picture CD Compatible" logo is a trademark of Eastman Kodak Company and is used with permission.

Manufactured under licences from Digital Theater Systems, Inc. US Pat No. 5, 451, 942 and other world wide patents issued and pending. "DTS" and "DTS Surround" are trademarks of Digital Theatre Systems, Inc. Copyright 1996 Digital Theater Systems Inc. All rights reserved.

Manufactured under license from Dolby Laboratories. "Dolby" and the double-D symbol are trademarks of Dolby Laboratories. Confidential Unpublished Works. © 1992-1997 Dolby Laboratories, Inc. All right reserved.

Front panel and Rear panel illustrations

Front panel

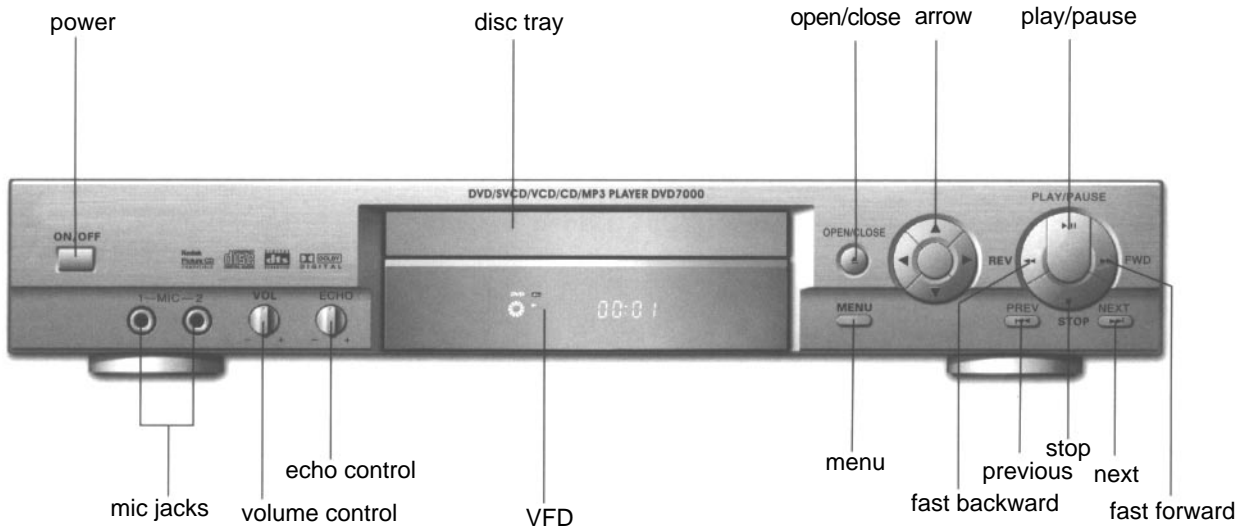

Rear panel

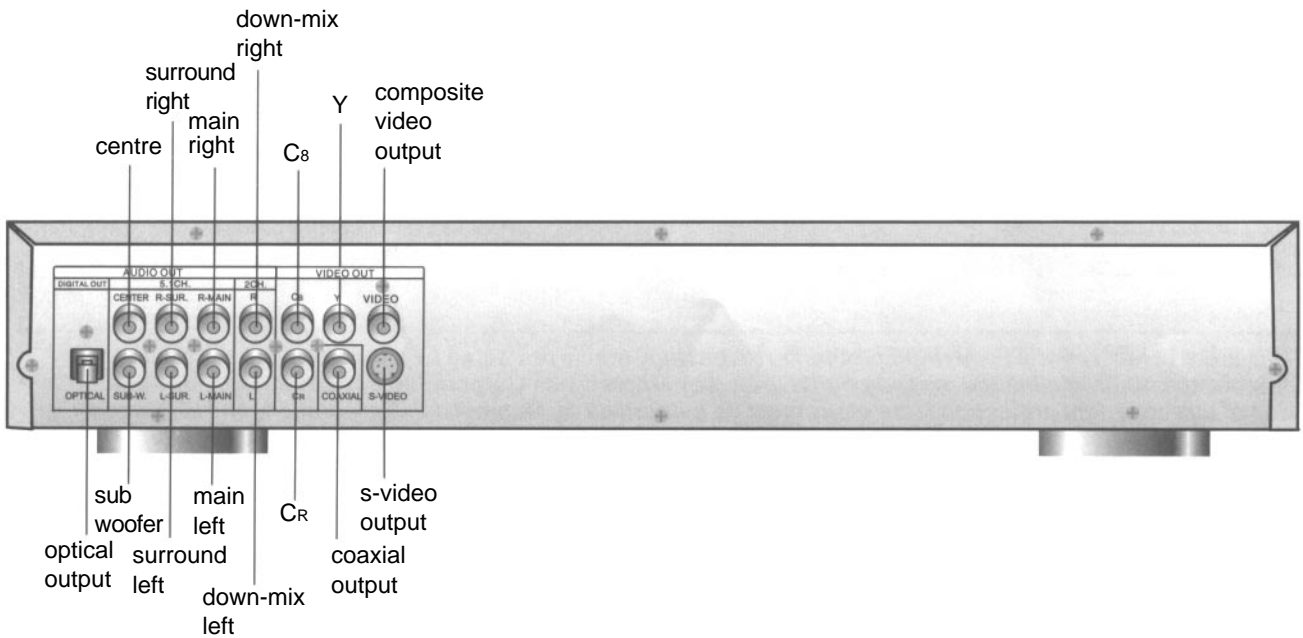

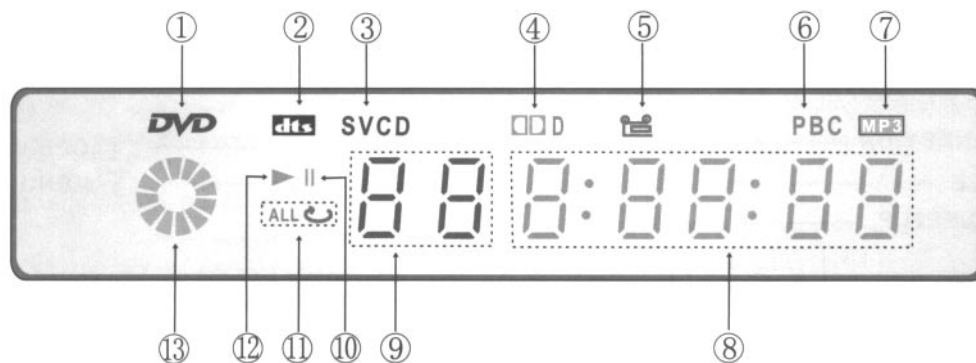

The figure above shows the front panel with all the displays on.

- | | |
|---|--|
| <ul style="list-style-type: none"> 1. DVD indicator 2. DTS indicator 3. SVCD-VCD indicator 4. DOLBY indicator 5. Multi-angle indicator 6. PBC indicator 7. MP3 indicator 8. Time indicator 9. Track indicator 10. Pause indicator 11. Repeat indicator 12. Play indicator 13. Play indicator | <ul style="list-style-type: none"> Illuminates when a DVD disc is loaded. Illuminates when audio is DTS out. Illuminates VCD when a VCD disc is loaded, SVCD when Super-VCD disc is loaded and CD when a CD disc is loaded. Illuminates when audio is DOLBY out. Illuminates when the disc has multi-angle function. Illuminates during menu play (VCD/SVCD). Illuminate when an MP3 disc is loaded. Illuminates the total playing time on a disc. (CD/VCD/SVCD).
When playing DVD, indication will show played time if it is in time mode.
When playing DVD, indication will title/chapter if it is in title/chapter mode.
(Refer to setup menu [other] item) Indicate the track number (CD/VCD/SVCD). Illuminates during still picture. Illuminates during repeat playback.
 <ul style="list-style-type: none"> Repeat of chapter (DVD) / track (CD, VCD/SVCD). Repeat of title (DVD) / entire disc contents (CD/VCD/SVCD). Illuminate during playback. Rotates during playback. |
|---|--|

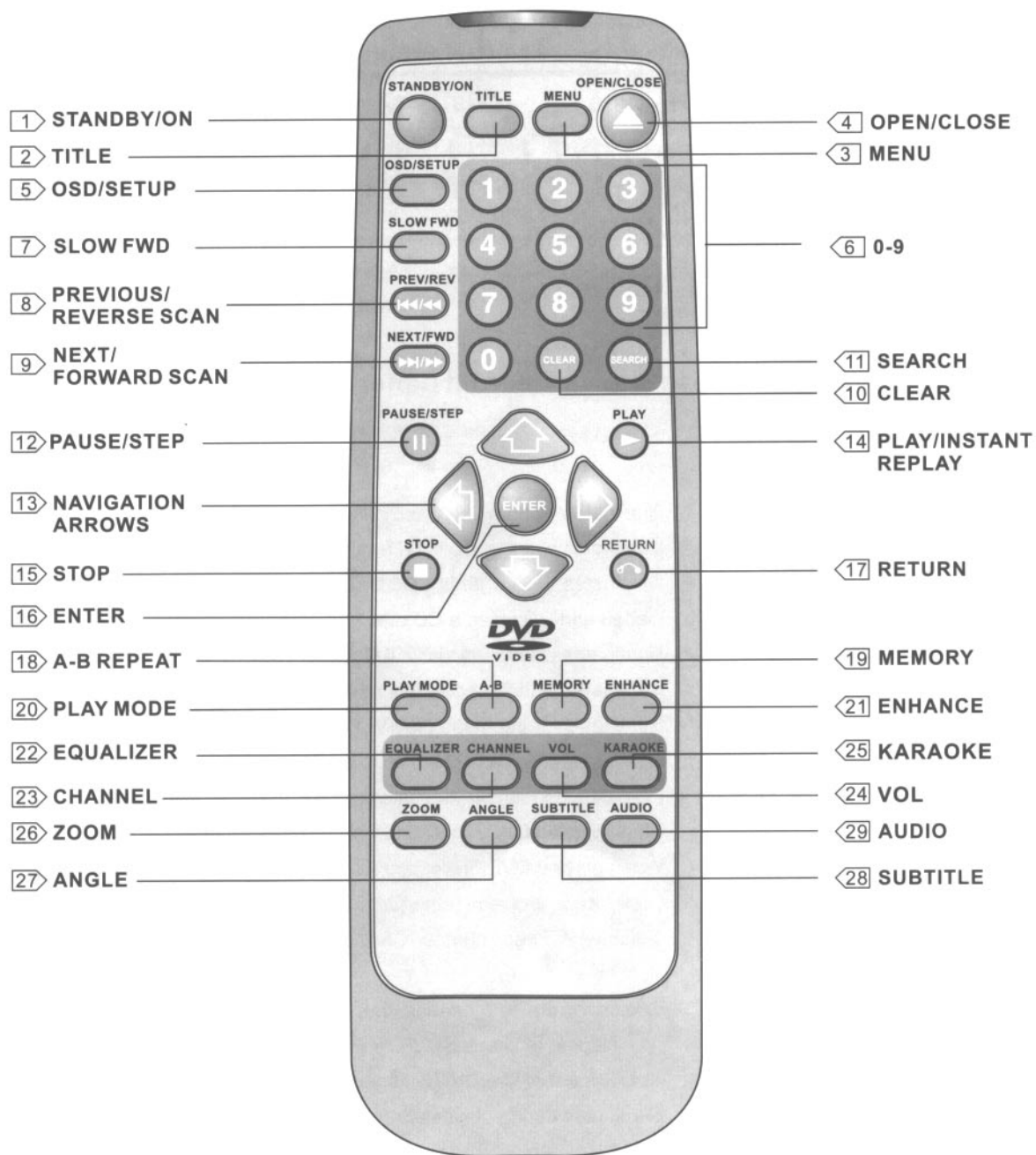

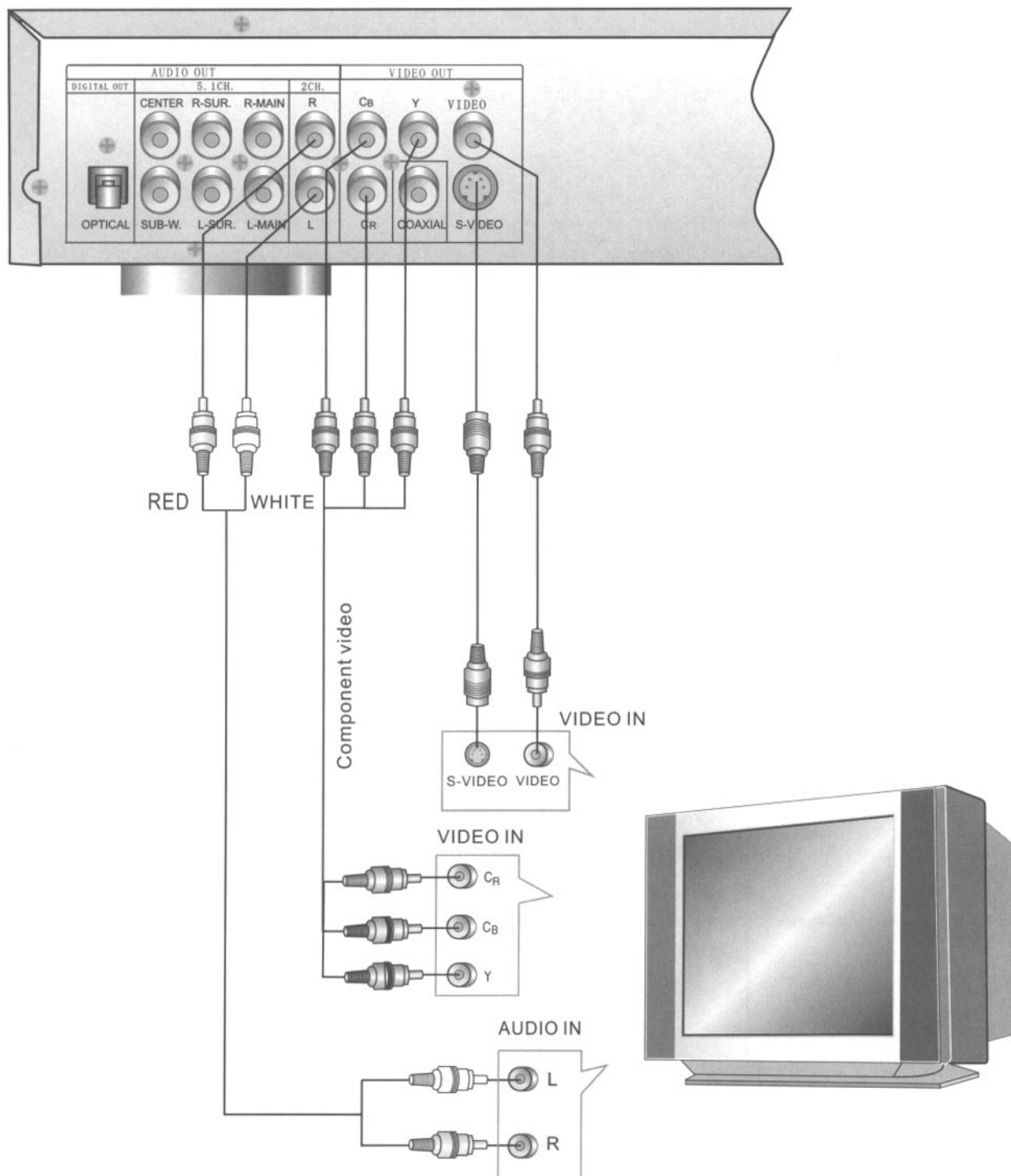

Notes:

Set player's Analog Out mode to **"2 Channel"** in the audio setup page. (See page 17)

There are three ways of connecting the player's AV output to the TV set.

1. S-video cable and left/right audio cable. (Set the [Video Type] to **[CVBS S-Video]**)
2. Composite video cable and left/right audio cable.
3. Component video cable and left/right audio cable. (Set the [Video Type] to **[CVBS YCbCr]**)

Connecting to an AV amplifier with 2 channel analog audio input

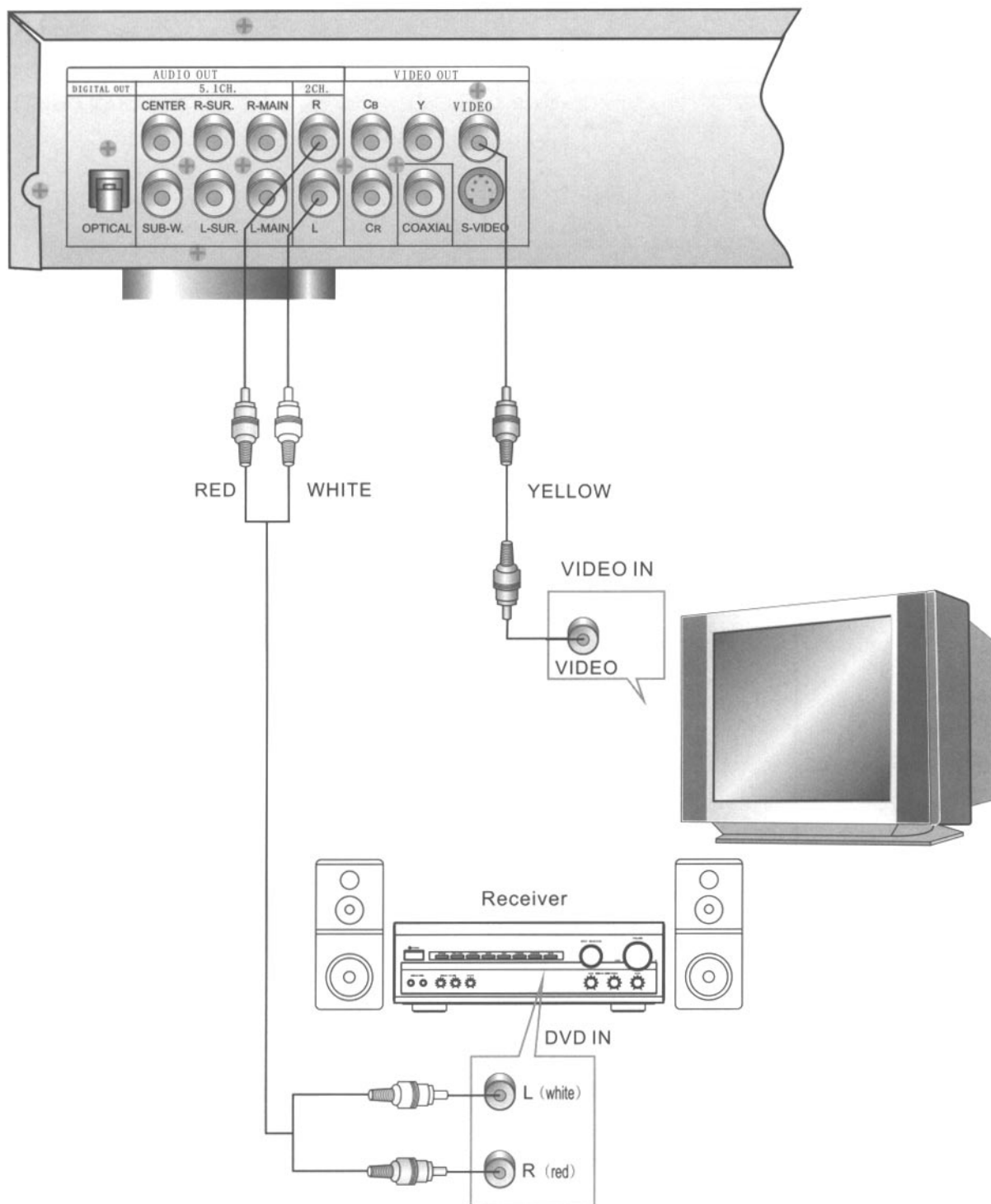

Notes:

1. Set player's Analog Out mode to **"2 Channel"** in the audio set up page (See page 17).
2. Set the TV set's AV input to the channel you have connected.
3. Set the amplifier's audio input to the channel you have connected.

Connecting to an AV amplifier with 5.1 channel analog audio input

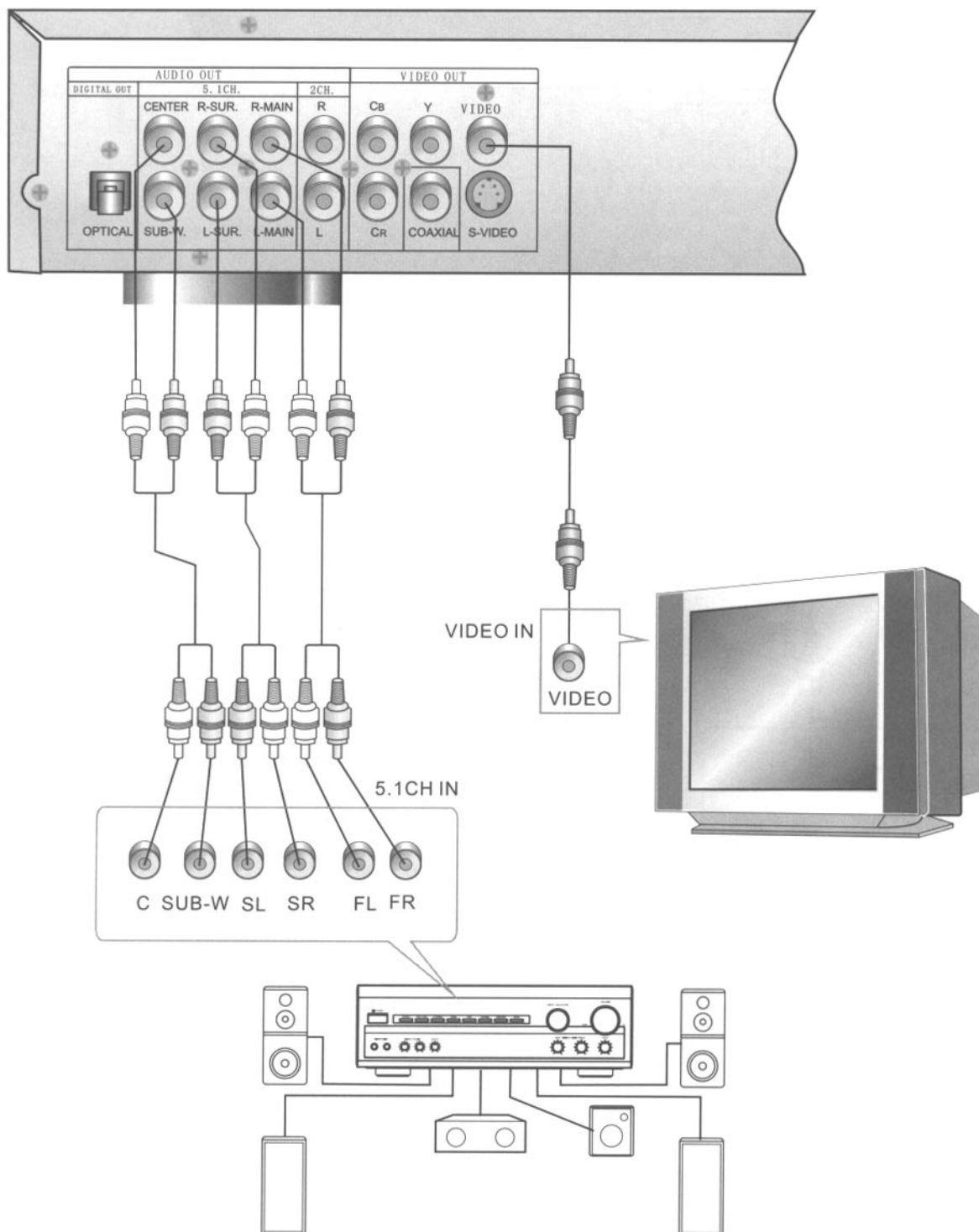

Notes:

1. Set player's Analog Out mode to **"5.1 Channel"** in the audio set up page (See page 17).
2. Set the TV set's AV input to the channel you have connected.
3. Set the amplifier's audio input to the channel you have connected.

Connecting to an AV amplifier with digital audio input

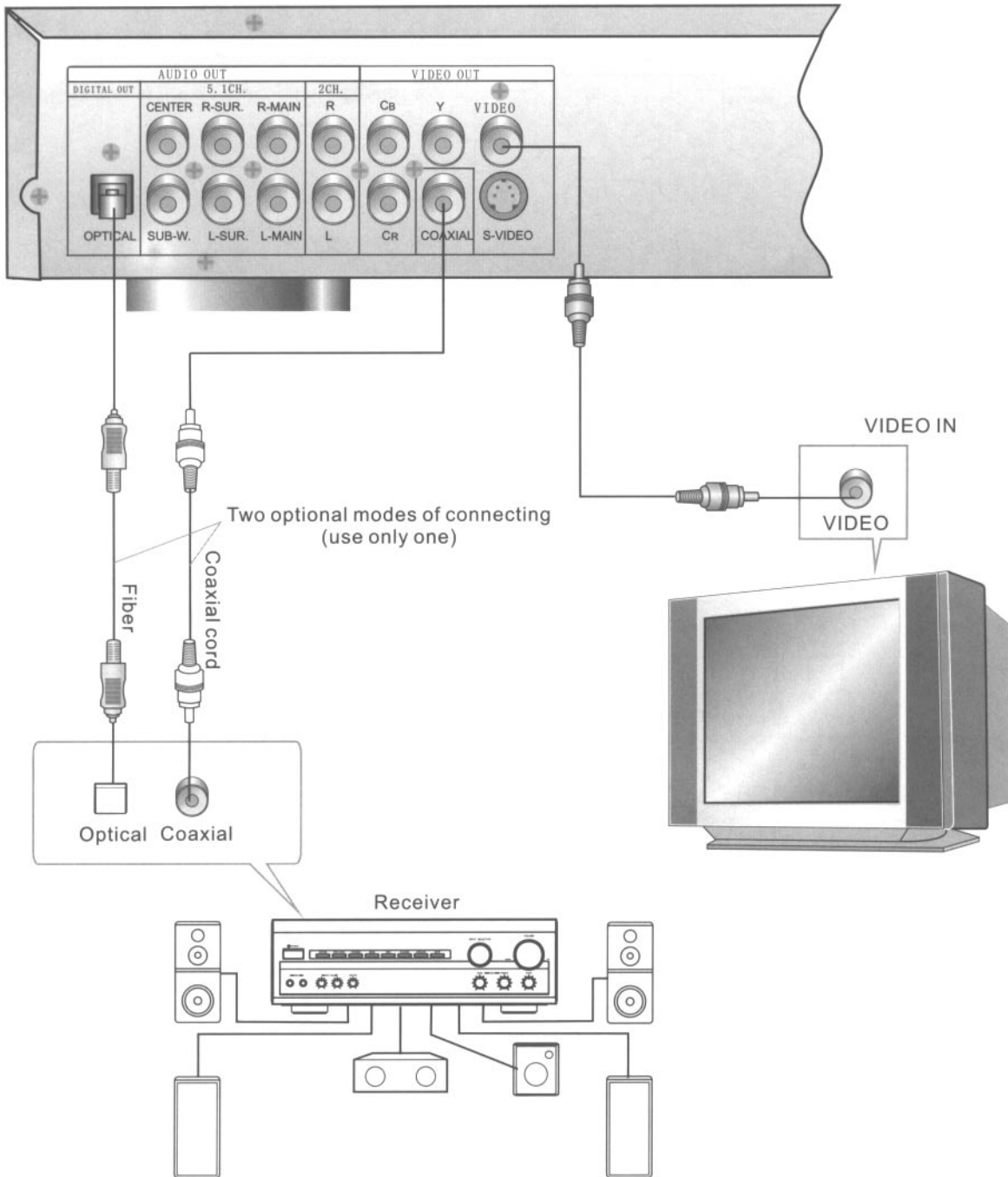

Two optional modes of connecting (use only one)

Fiber
Coaxial cord

Optical Coaxial

Receiver

Notes:

1. Set player's Digital Out mode to **"PCM"** or **"Raw"** in the audio set up page (See page 18).
2. Set either the Optical or the Coaxial digital audio output.
3. Set the amplifier to the AV input connected to the DVD player.

Preparation before playing:

1. Connect your DVD player to the TV and amplifier.
2. Turn on the TV.
3. Set the TV to the AV input connected to the DVD Player.
4. Turn down the volume on your amplifier, then power it on.
5. Set the amplifier to the AV input connected to the DVD Player.

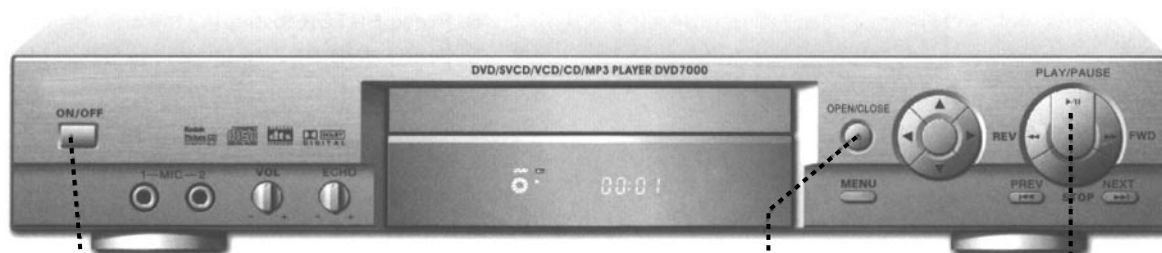

Step 1 - Press the **POWER** switch, the player will start. Then "LOAD" is illuminated on the display and the logo is displayed on TV screen.

Step 2 - Press **OPEN/CLOSE** on front panel or remote control. The player displays "OPEN" on the display. When the tray is open, place the disc on the tray, with the label side up. Press **OPEN/CLOSE** again to close the disc tray.

Step 3 - Press the **PLAY** button on the front panel or remote control. The player will automatically read and identify the disc, display the type and total time, and begin playback.

ON SCREEN DISPLAY (OSD)/SETUP



In stop mode, press **OSD/SETUP**, and the TV screen will display the setup menu as the following:

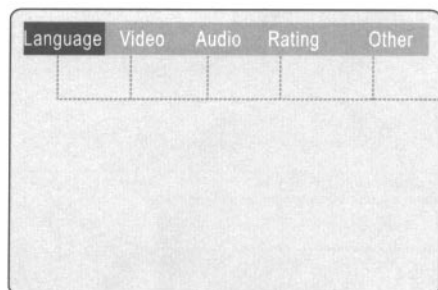

Setup Menu

- A. Press to change the items.
- B. Press **ENTER** to display the submenu.
- C. Press **OSD/SETUP** to exit the Setup Menu.

Language Setup

Select [Language] in the Setup Menu, and press **ENTER** to display the [Language] submenu:

Press to select the menu items.

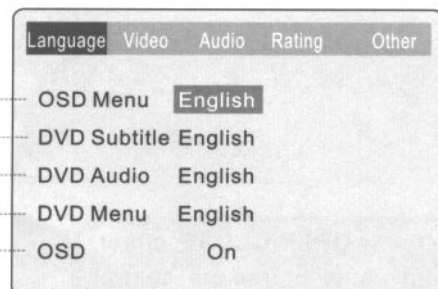

- A. Press **ENTER** or to setup.
- B. Press **RETURN** or to return to the Setup Menu.

1. Select [OSD Menu], and press **ENTER** or to display the [OSD Menu] submenu:

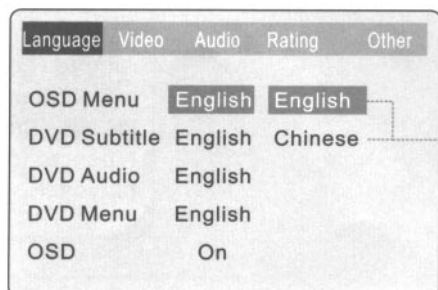

- A. Press to change your selection
- B. Press **ENTER** to confirm.
- C. Press **OSD/SETUP** to exit the Setup Menu.

Language Setup

2. Select [DVD Subtitle], and press **ENTER** or \rightarrow to display the [DVD Subtitle] submenu:

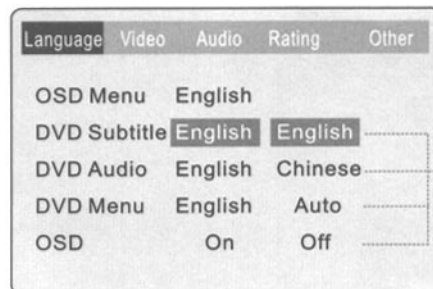

- A. Press \leftarrow to change your selection.
- B. Press **ENTER** to confirm.
- C. Press **OSD/SETUP** to exit the Setup Menu.

Note: Subtitle languages vary by disc.

3. Select [DVD Audio], and press **ENTER** or \rightarrow to display the [DVD Audio] submenu:

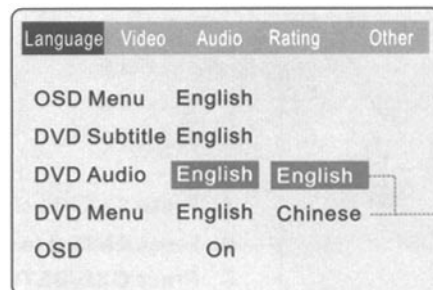

- A. Press \leftarrow to change your selection.
- B. Press **ENTER** to confirm.
- C. Press **OSD/SETUP** to exit the Setup Menu.

Note: Audio languages vary by disc.

4. Select [DVD Menu], and press **ENTER** or \rightarrow to display the [DVD Menu] submenu:

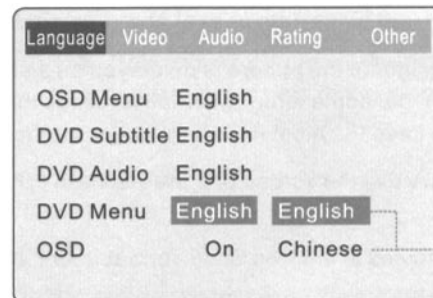

- A. Press \leftarrow to change your selection.
- B. Press **ENTER** to confirm.
- C. Press **OSD/SETUP** to exit the Setup Menu.

Note: Menu languages may vary by disc.

5. Select [OSD], and press **ENTER** or \rightarrow to display the [OSD] submenu:

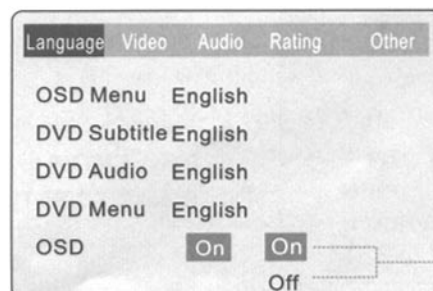



- A. Press \leftarrow to change your selection.
- B. Press **ENTER** to confirm.
- C. Press **OSD/SETUP** to exit the Setup Menu.

Video Setup

Select [Video] in the Setup Menu, and press **ENTER** to display the [Video] submenu:

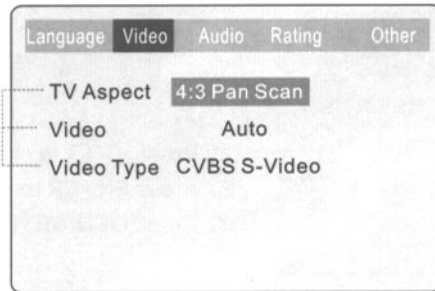
Press  to select the menu item.



- A. Press **ENTER** or  to setup.
- B. Press **RETURN** or  to return to the Setup Menu.

1. Select [TV Aspect], and press **ENTER** or  to display the [TV Aspect] submenu:

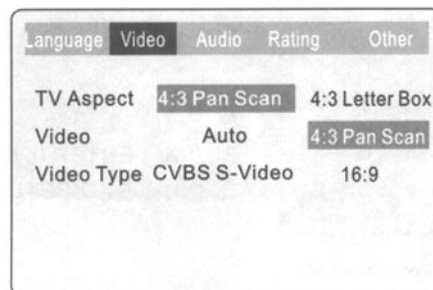

- A. Press  to change your selection.
- B. Press **ENTER** to confirm.
- C. Press **OSD/SETUP** to exit the Setup Menu.

[4:3 Letter Box] - The full width of the picture is displayed on a standard 4:3 television, but black bars appear above and below the picture.

[4:3 Pan Scan] - The full height of the picture is displayed on a standard 4:3 television, but some left/right detail is lost and as the movie *pans and scans*, to keep the most important action on the screen.

[16:9] ----- The picture fills the screen of a wide screen (16:9) television.

Note: Not all DVDs offer movies in 4:3 Pan Scan format. If not, the disc will override your TV Display setting and some movies will be displayed in 4:3 Letter Box format.

2. Select [Video], and press **ENTER** or  to display the [Video] submenu:

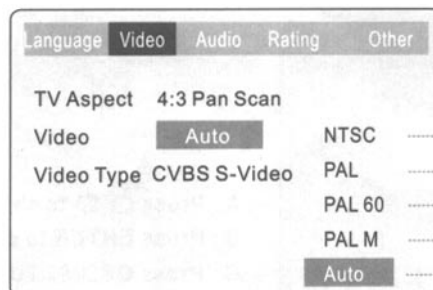

- A. Press  to change your selection.
- B. Press **ENTER** to confirm.
- C. Press **OSD/SETUP** to exit the Setup Menu.

Video Setup

3. Select [Video Type], and press **ENTER** or \rightarrow to display the [Video Type] submenu:

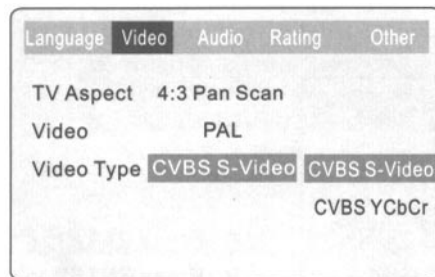

- A. Press \uparrow / \downarrow to change your selection.
- B. Press **ENTER** to confirm.
- C. Press **OSD/SETUP** to exit the Setup Menu.

[CVBS S-Video] ---- S-Video output.

[CVBS YCbCr] ---- Component video output.

Note: The Composite video output is always available.

Audio Setup

Select [Audio] in the Setup Menu, and press **ENTER** to display the [Audio] submenu:

Press \uparrow / \downarrow to select the menu item.

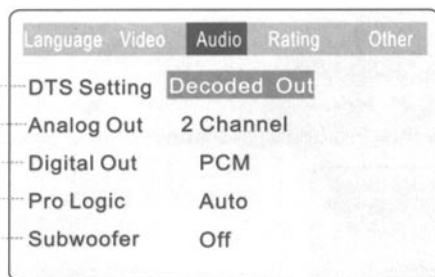

- A. Press **ENTER** or \rightarrow to setup.
- B. Press **RETURN** or \leftarrow to return to the Setup Menu

1. Select [DTS Setting], and press **ENTER** or \rightarrow to display the [DTS Setting] submenu:

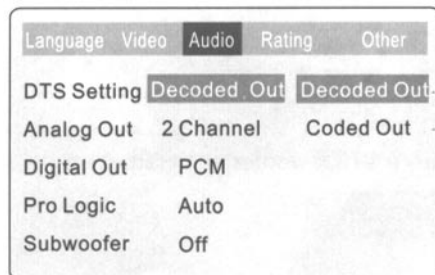

- A. Press \uparrow / \downarrow to change your selection.
- B. Press **ENTER** to confirm.
- C. Press **OSD/SETUP** to exit the Setup Menu.

2. Select [Analog Out], and press **ENTER** or \rightarrow to display the [Analog Out] submenu:

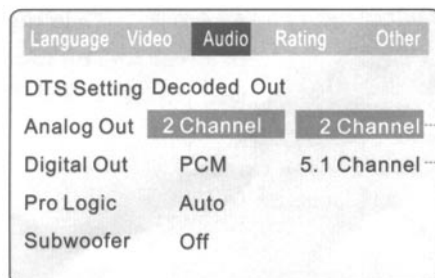

- A. Press \uparrow / \downarrow to change your selection.
- B. Press **ENTER** to confirm.
- C. Press **OSD/SETUP** to exit the Setup Menu.

Audio Setup

3. Select [Digital Out], and press **ENTER** or \rightarrow to display the [Digital Out] submenu:

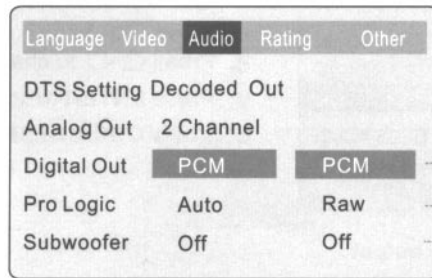

- A. Press \uparrow / \downarrow to change your selection.
- B. Press **ENTER** to confirm.
- C. Press **OSD/SETUP** to exit the Setup Menu.

[PCM] --- Digital audio output in PCM (pulse code modulation) format; use for stereo or CD playback.

[Raw] --- Digital audio out in original format; use if you connect to an AV receiver with a Dolby Digital or DTS decoder.

[Off] ----- No digital audio out.

4. Select [Pro Logic], and press **ENTER** or \rightarrow to display the [Pro Logic] submenu:

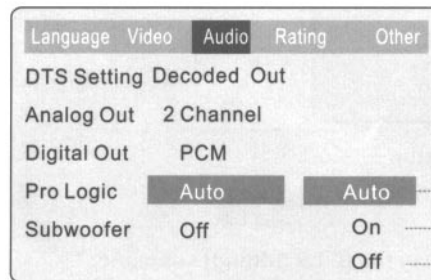

- A. Press \uparrow / \downarrow to change your selection.
- B. Press **ENTER** to confirm.
- C. Press **OSD/SETUP** to exit the Setup Menu.

5. Select [Subwoofer], and press **ENTER** or \rightarrow display the [Subwoofer] submenu:

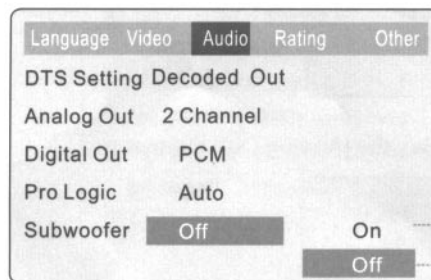



- A. Press \uparrow / \downarrow to change your selection.
- B. Press **ENTER** to confirm.
- C. Press **OSD/SETUP** to exit the Setup Menu.

Rating Setup

Select [Rating] in the Setup Menu, and press **ENTER** to display the [Rating] submenu:

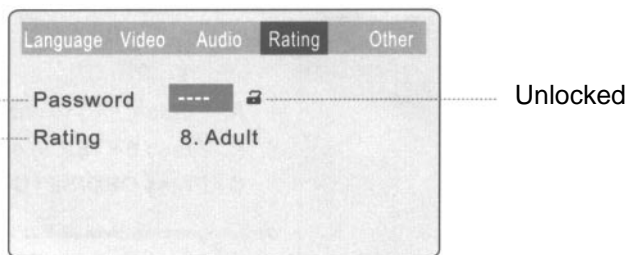
Press  to select the menu item.



A. Press **ENTER** or  to Setup Menu.

Note: Not all DVDs support ratings.

1. Use the 0-9 keys to input four digits, then press **ENTER** to confirm. The [Rating] submenu displays as follows:

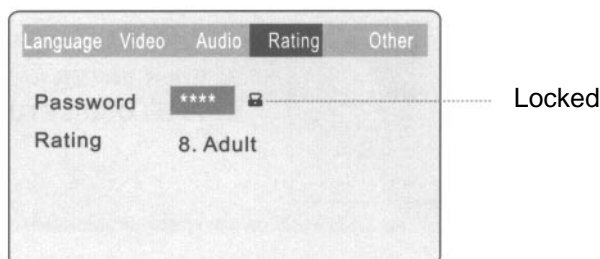

Note: If you forget your password, please use the universal password (listed on the last page of this manual) to unlock.

2. Select [Rating], and press **ENTER** to change [Rating] mode.

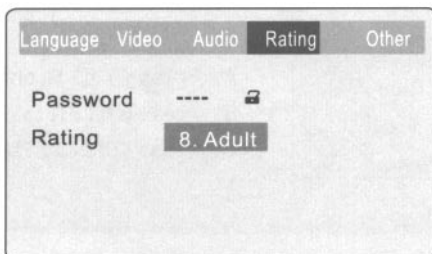

A. Press **ENTER** repeatedly to select: 1. Kid Safe, 2. G, 3. PG, 4. PG-13, 5. PG-R, 6. R, 7. NC-17, 8. Adult.

B. Press **RETURN** to return to the Setup Menu

Note: Unlock the password before setting [Rating].

Other Setup Items

Select [Other] in the Setup Menu, and press **ENTER** to display the [Other] submenu:

Press  to select the menu item.

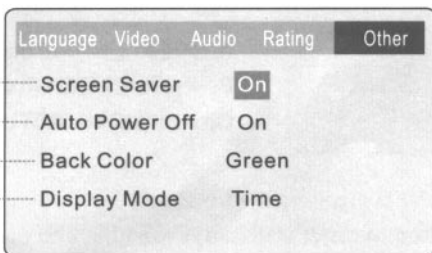

A. Press **ENTER** or  to setup.

B. Press **RETURN** or  to return to the Setup Menu

Other Setup Items

1. Select [Screen Saver], and press **ENTER** or \square to display the [Screen Saver] submenu:



- A. Press \square to change your selection.
- B. Press **ENTER** to confirm.
- C. Press **OSD/SETUP** to exit the Setup Menu.

2. Select [Auto Power Off], and press **ENTER** or \square to display the [Auto Power Off] submenu:

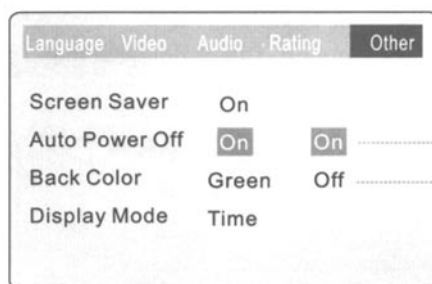

- A. Press \square to change your selection.
- B. Press **ENTER** to confirm.
- C. Press **OSD/SETUP** to exit the Setup Menu.

3. Select [Back Color], and press **ENTER** or \square to display the [Back Color] submenu:



- A. Press \square to change your selection.
- B. Press **ENTER** to confirm.
- C. Press **OSD/SETUP** to exit the Setup Menu.

4. Select [Display Mode], and press **OK** or \square to display the [Display Mode] submenu:

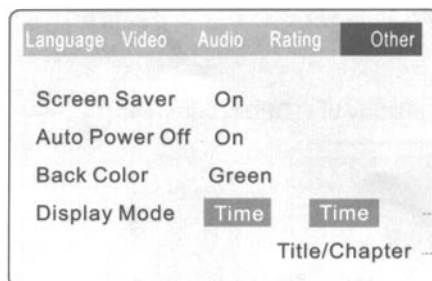

- A. Press \square to change your selection.
- B. Press **ENTER** to confirm.
- C. Press **OSD/SETUP** to exit the Setup Menu.

[Time] ---- Time indicator on VFD displays the time.

[Title/Chapter] ---- Track indicator on VFD displays the title, and the time indicator displays the chapter.

Note: This setup is available only during DVD playback.

STANDBY/ON



- During the playback, press **STANDBY/ON** to stop the player and return to standby mode.
- While the player is in standby, press **STANDBY/ON** or any key on the front panel to resume normal operation.

TITLE



- During DVD playback, press **TITLE** to display the DVD title menu, or play from the first title.

Note: This function is subject to the disc.

MENU



- During DVD playback, press **MENU** to display the menu of the current title.

Note: This function is subject to the disc.

OPEN/CLOSE



- To open the disc tray, press **OPEN/CLOSE**.
- To close the disc tray, press **OPEN/CLOSE** again.

OSD/SETUP



During playback, press **OSD/SETUP** key to display the current time of the disc playing.

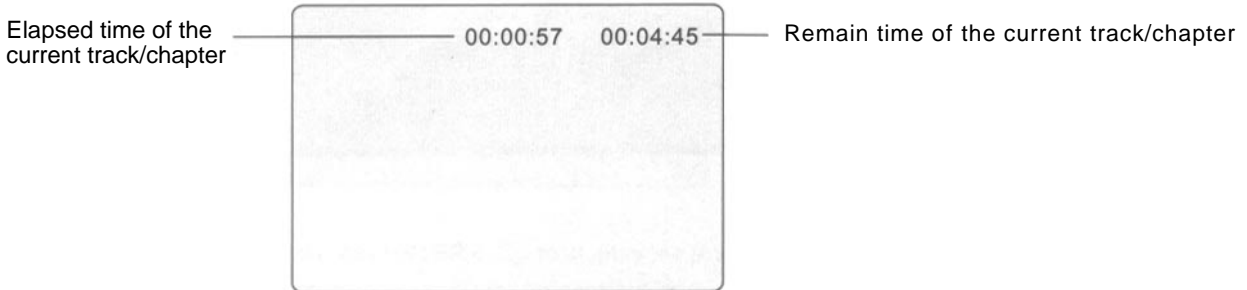

Press **OSD/SETUP** again to display the additional information of the disc playing.

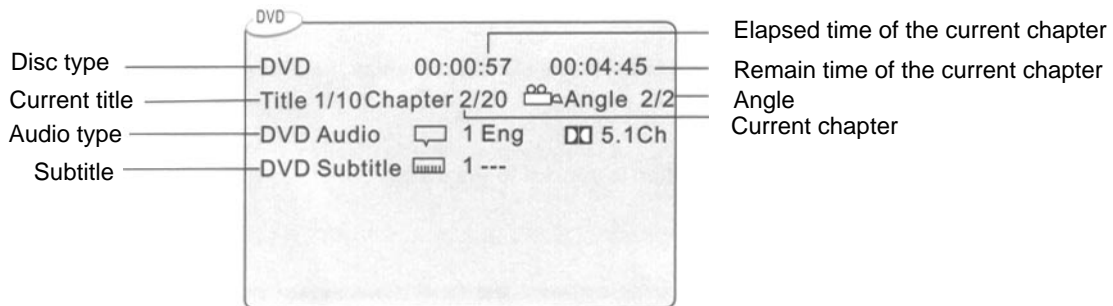
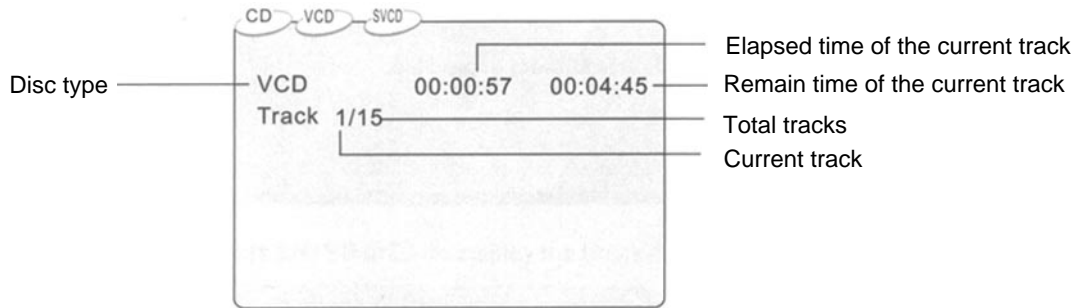

For CDs, press **OSD/SETUP** a third time to display the dynamic frequency spectrum. Press it again to turn off the spectrum.

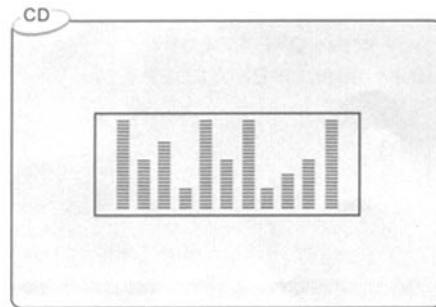

Note: Press stop to access other modes.

0-9 Keys

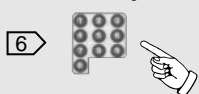

- These keys are used to input the time, as well as title, chapter and track numbers.
- When a numeric item is displayed on the screen, press 0-9 keys to select the desired entry, and press **ENTER** to confirm.
- When a CD and VCD is playing (with PBC off), press 0-9 keys to select a track directly, then press **ENTER** to confirm.

SLOW FWD



- During DVD, VCD or SVCD playback, press **SLOW FWD** for slow motion playback.
- Once you press **SLOW FWD**, the disc at will play at 1/2, 1/4, 1/6, and 1/7 normal speed as follows:

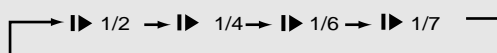

- Press **PLAY** to resume normal playback.

PREV/REV



- During DVD, CD or VCD playback, press **PREV/REV** once to play the previous chapter, title or track.
- During DVD, CD, VCD playback, press and hold **PREV/REV** to scan in reverse. The player will review the disc at 2, 4, 8 and 20 times normal speed as the follows:

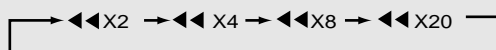

- Press **PLAY** to resume normal playback.

NEXT/FWD



- During DVD, CD or VCD playback, press **NEXT/FWD** key to play the next chapter, title or track.
- During DVD, CD, VCD, playback, press and hold **NEXT/FWD** to scan forward. The player will cue the disc at 2, 4, 8 and 20 times of the normal speed as the follows:

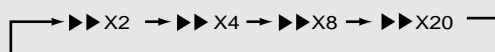

- Press **PLAY** to resume normal playback.

SEARCH



Use the number keys to input the desired [Time], [Relative-Time] or [Title/Chapter] then press **ENTER** to confirm.

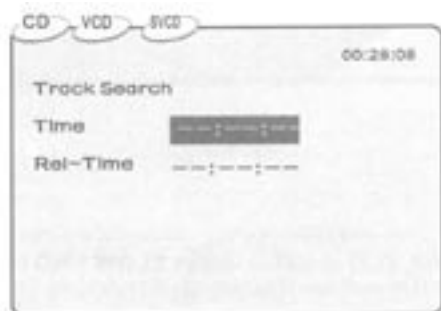

- Notes:**
1. During CD playback, press **SEARCH** to display the [Track Search] menu, and press it again to display the [Disc Search] menu.
 2. During VCD and SVCD playback (with PBC off), press **SEARCH** twice to display the [Disc Search] menu.

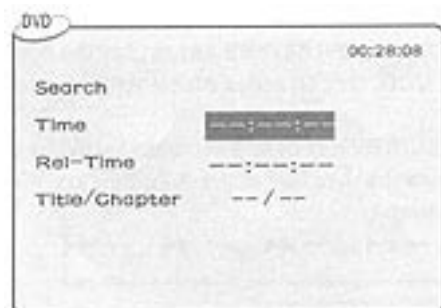

- Notes:**
1. Time searches for an exact time in a movie. Relative time searches relative to the current counter position.
 2. In [Title/Chapter] mode, you cannot enter a value outside the range of the total number of titles/chapters.
 3. While searching by using [Rel-Time], press and hold "0" to change [Rel-Time] to negative. (search backward)
 4. For some DVD disc, the Search function is unavailable.

CLEAR



- Press **CLEAR** key to delete the number you have entered.
- Press once to delete one digit, Press and hold to delete all digits.

PAUSE/STEP



- Press **PAUSE/STEP** during playback to pause playback.
 - Press **PAUSE/STEP** again to step forwards one frame.
 - Press **PLAY** to resume normal playback.
- Note:** The step function is not available during CD playback.

PLAY



- Press **PLAY** from stop mode to start playback.
- Press **PLAY** during playback to replay the last 10 seconds.
- If the elapsed time of the current track is less than 10 seconds, the player skip ahead 10 seconds.

Note: MP3 disc and some DVD discs do not have a 10 seconds review feature.

STOP



- Press **STOP** once during playback to stop and hold playback.
- Press **PLAY** to resume playback from the point you pressed **STOP**.
- Press **STOP** twice to stop playback completely.

Note: The screen saver will automatically turn on if playback is stopped for more than 5 minutes.

RETURN

17



- During VCD or SVCD playback (with PBC on), press **RETURN** to return to the program menu.
- In the Setup Menu, press **RETURN** to return to the main menu.
- Press it in some menus, pressing **RETURN** cancels the current display.

A-B

18



- During playback, press **A-B** key to select point A.
- Press it again to select point B. The player will repeat the section from A to B automatically.
- Press **A-B** a third time to cancel A-B repeat and clear points A and B.

Note: During CD/VCD/SVCD playback, points A and B must be within same track.
During DVD playback, points A and B can be selected at two different chapters.

MEMORY

19



- During disc playback, press **MEMORY** bookmark the current the disc position.
- Press **MEMORY** again to play the disc from the bookmarked position. (this also clears the bookmark so that you can set a new one).

Note: The bookmark will be saved even if the player is powered off.
The player can save the bookmark for CD, VCD, SVCD and DVD independently, but only one bookmark can be saved for each type of disc. This function is unavailable for MP3.

PLAY MODE



Press **PLAY MODE** to display the [Play Mode] menu:

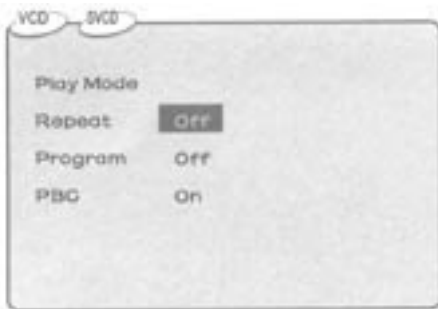

Press to change the items

1. Select [Repeat], and press **ENTER** or to display the [Repeat] submenu:

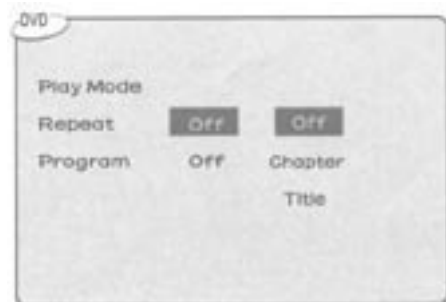
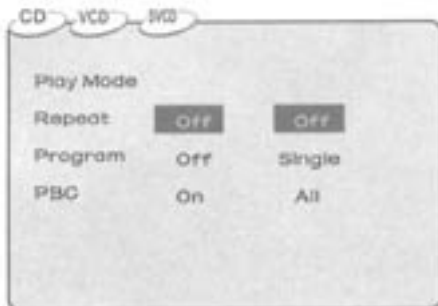

Press to change your selection.

A. Press **ENTER** to confirm.

B. Press **PLAY MODE** or **RETURN** to exit the menu.

Note: PBC (Playback Control used to navigate VCDs) is not available for CDs.

2. Select [Program], and press **ENTER** or to display [Program] submenu:

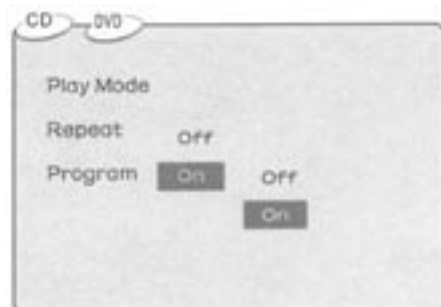
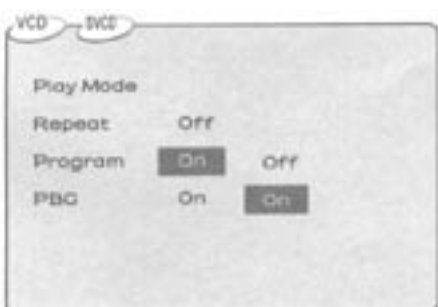

Press to change your selection

A. Press **ENTER** to confirm

B. Press **PLAY MODE** or **RETURN** to exit the menu

While [Program] is on, press **ENTER** to display the [Program] submenu:

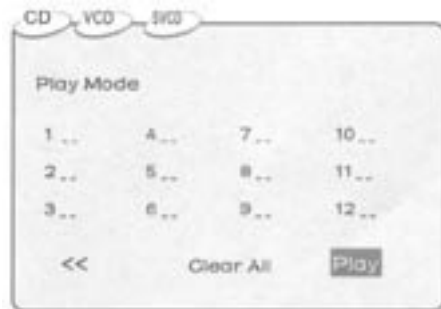

Input the track numbers in the order you would like them to play. When finished select [Play] and press **ENTER** to play the tracks in the new programmed order. To clear all the numbers you have entered select [Clear All] and press **ENTER**. To return to the [Play Mode] menu select [<<] and press **ENTER**.



Input the title number and the chapter number in the desired order. Then select [Play] and press **ENTER** to play the chapters in the order you have set. Select [Clear All] and press **ENTER** to clear all the numbers you have input. Select [<<] and press **ENTER** to return to the [Play Mode] menu.

3. Select [PBC], and press **ENTER** or $\square \rightarrow$ to display the [PBC] submenu:
(PBC, or playback control, provides advanced track selection options during VCD playback).

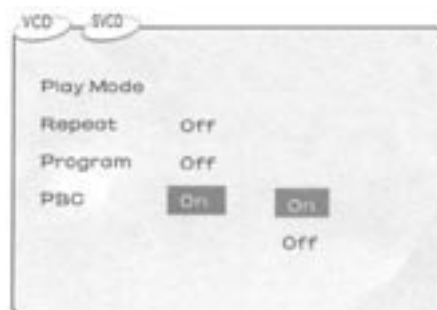

- A. Press **ENTER** to confirm
- B. Press **PLAY MODE** or **RETURN** to exit the menu

ENHANCE



Enhanced Features	-- -- --	The Timer feature allows you to automatically power off the player after a specified length of time (up to 99:59:59). If not to input, please press ENTER key, the timer function is disabled.
Timer	-- -- --	The time remaining until the power is turned off is shown here.
Edge Enhance	Off	Edge Enhance sharpens or softens edges during DVD, VCD or SVCD playback. Press ENTER to select Off, Sharpen or Soften.
Bright Enhance	Off	Bright Enhance increases the contrast during DVD, VCD or SVCD playback. Press ENTER to select Off or On.

Note: Enhanced Features are not available during MP3 playback.

EQUALIZER



The equalizer allows you to adjust 6 frequency bands independently.

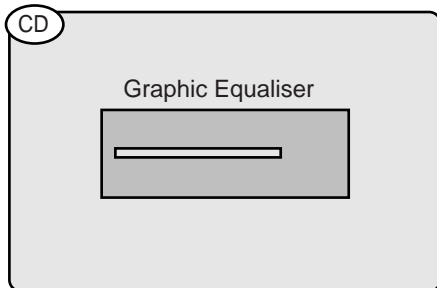

Note: Not available for DVD, MP3, VCD or SVCD playback.

- A. Press or to select the desired frequency band.
- B. Press or to adjust the level for each frequency.

CHANNEL



Press **CHANNEL**, and the [Channel Setup] menu will display as follows:



Press **ENTER** repeatedly to change the selection.

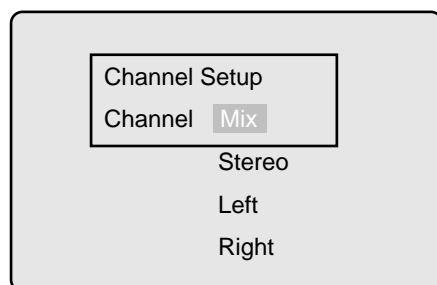

When Karaoke is off:

You can change four channel modes: Stereo/Left/Right/Mix.

When Karaoke is on:

- (1) You can select: Stereo/Left/Right/Mix/Partner Left/Partner Right, during CD/VCD/SVCD playback.
- (2) You can select: Stereo/Left/Right/No Vocal/Partner Stereo/Partner Left/Partner Right, during DVD playback.

Press **CHANNEL** again to exit the menu.

VOL



Press **VOL** and the [Volume Setup] menu will display as follows:

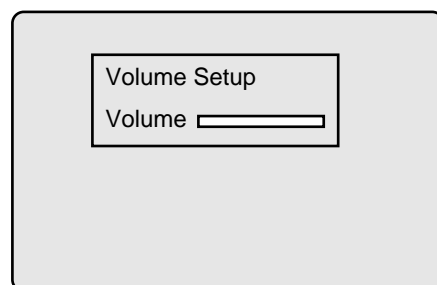

Press   to adjust the volume.

Press **VOL** key to exit the menu.

ZOOM

26



- During VCD/SVCD/DVD playback, press **ZOOM** to magnify the image as follows:

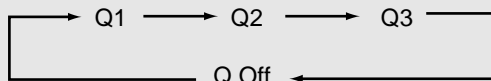

ANGLE

27



During DVD playback

- Press **ANGLE** to view scenes from different camera angles.
- Press **ANGLE** repeatedly to change from one camera angle to another.

Note: This function is disc specific.

SUBTITLE

28



During DVD playback

- Press **SUBTITLE** repeatedly to select from up to 32 subtitle languages.

Note: This function is disc specific (languages will vary).

AUDIO

29



During DVD playback

- Press **AUDIO** repeatedly to select from up to 8 audio languages/formats.

During SVCD playback

- Press **AUDIO** repeatedly to select from up to 4 audio languages/formats.

Note: This function is disc specific.

KARAOKE



Press **KARAOKE** key, the screen will display as the following:

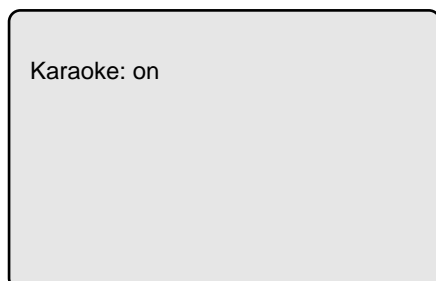

Note: When Karaoke is off, press **KARAOKE** key, and Karaoke will be on.
When Karaoke is on, press **KARAOKE** key, and Karaoke will be off.

Set the player as the following, then you can enjoy Karaoke.

1. Connect the microphones to the MIC1/MIC2 jacks.
2. Put the disc in the tray.
3. Select the track/chapter in the program menu.
4. Press **KARAOKE** key and set Karaoke on.
5. Turn the knob **MIC VOL** to adjust the microphone volume.
6. Turn the knob **ECHO** to adjust the microphone echo level.
7. Select the partner mode in **[Channel]** menu using the remote controller.

* If you hear strange noise (squealing or howling):

1. Avoid moving the microphone near the TV set or speaker.
2. Turn down the microphone volume.
3. Reduce the echo level.

Note: When Analog Out is set to [5.1 Channel] Karaoke is invalid.

Remove the voice:

When you enjoy Karaoke, and if you want to remove the voice, press **CHANNEL** key to select the right mode, and it will remove the voice.

Note: This function is disc specific.

Supported formats

- Disc format: ISO 9660, Joliet
- Music file formats: MP3
- MP3 bit rate (data rate): 32--320kbps
- Total number of music files and albums: around 350 per disc
- Sampling rate: 32kHz/44.1kHz/48kHz

Note: The player will not identify or play MP3 discs under the following conditions: recording format is not supported, badly scratched or deformed disc, MP3 recorded in CD-R or CD-RW which is not finalised, or a dirty pick-up

When an MP3 disc is loaded, the screen will display as follows:

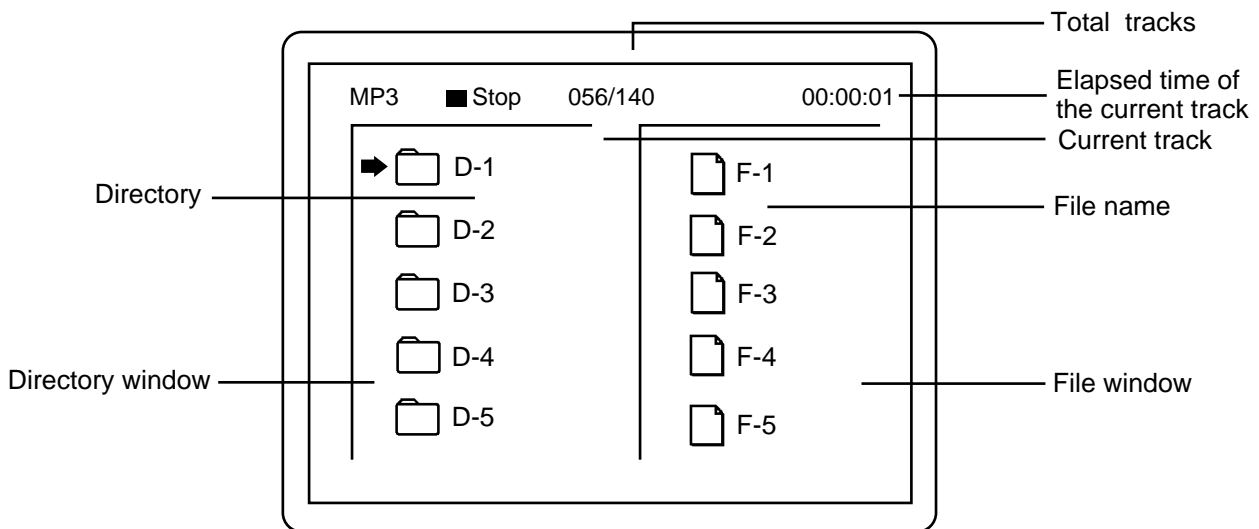

Press to select the directory.

Press **PLAY** to play the first file in the directory selected by the cursor in the directory window. The cursor will automatically move to the file playing in the file window.

Note: The player supports English directory and file names only. Other languages will display as "D-X" for the directory name and "F-X" for the file name, where X is the next number of the directory or file in sequential order.

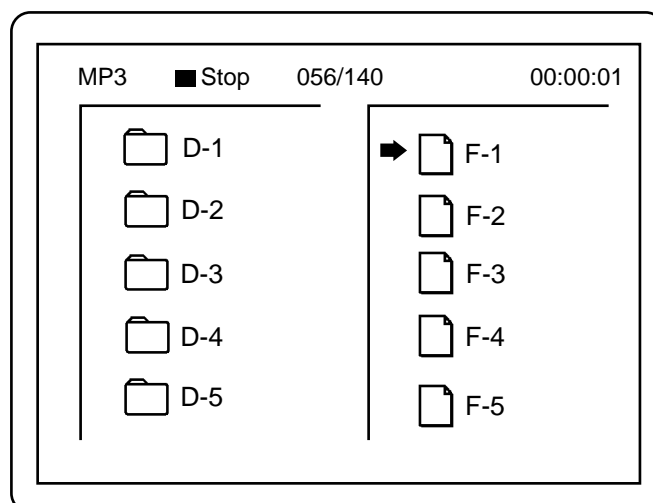

Press to select the file when the cursor appears in the file window.

Press **PLAY** to play the current file selected by cursor in the file window.

Press to switch between the directory window and the file window.

Note: During MP3 playback, **PREV/REV** and **NEXT/FWD** are not available.

The introduction of KODAK PICTURE CD

A Kodak Picture CD has the size and shape of a regular CD. You can order a KODAK Picture CD simply by checking the box on the photo finishing envelope when you drop off a roll of film (35mm or Advanced Photo System (APS) colour print film) at the time of processing in Kodak Express store displaying "Kodak Picture CD" sign. When your order is returned, you receive your prints, negatives, and your full roll of pictures safely stored on your KODAK Picture CD. Each KODAK Picture CD brings you the tools to enhance, share and manage your pictures on your computer.

- Note:** 1. The Max. Size of JPEG Picture can be supported: 3840 x 3840 pels.
 2. JPEG stands for Joint Picture Experts Group. It is the first International Standard on Still Picture Compressing: ISO 10918-1, constituted by the Committee on Still Picture Compressing Standard of ISO. The pictures on KODAK Picture CD are stored in this format (JPEG). This player can decode the JPEG pictures in KODAK Picture CD and playback the pictures in different modes.

Now, you can playback Kodak Picture CDs on this player and view your wonderful pictures on your TV in the comfort of your living room.

This player provides 7 different slideshow transition modes. Press **PLAY MODE** key in play mode to select the slideshow transition models in turn as following:

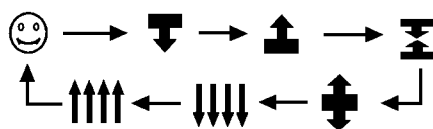

- | | |
|--|-----------------------------------|
| -- no special transition effect (by default) | -- wipe from centre to top/bottom |
| -- wipe from top to bottom | -- vertical blind |
| -- wipe from bottom to top | -- horizontal blind |
| -- wipe from top/bottom to centre | |

General function:

- You can set slideshow transition modes for any pictures.
- Press **PAUSE/STEP** key to stop playing.
- Press **PREV/REV** or **NEXT/FWD** key to continue slideshow transition.
- Press **PLAY** key to continue slideshow transition.

Image Rotation

There are four modes to rotate a picture: Invert, Mirror, left, and right. These operations are allowed only when a picture is being displayed normally and will be cancelled automatically when a new picture is displayed. The arrow key is used to select the different rotation modes:

- Press key -- Invert/Normal OSD display 1/4
- Press key -- Mirror/Normal OSD display 3/4 ,press it again to resume normal.
- Press key -- Turn left OSD display 2/4 ,press it again to resume normal.
- Press key -- Turn right OSD display 4/4 ,press it again to resume normal.

Zoom Function:

The player provides both Zoom in/out and pan function, The picture will zoom in/out as follows:

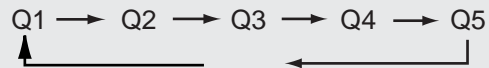

Note: During the ZOOM function, slideshow transitions and image rotation are disabled.

Q off: close zoom, press **PLAY** key to resume slideshow transitions.

Q1, Q2, Q3: zoom in; Q4, Q5: zoom out.

Digest function

- Press the **MENU** key to display up to 12 pictures at a time.
- Press the arrow keys to select any picture displayed on the screen, then press the **PLAY** key. The selected picture will zoom in and start slideshow transitions.

Note: the quality of the pictures displayed on your screen will depend on the quality of your display equipment.

Setting the time interval between slides

- In playback mode, press the **SEARCH** key to open the Timer menu.
- Use the $\leftarrow \rightarrow$ keys to adjust the time interval, which will display on the top-right corner of the menu.
- Press the **SEARCH** key again to close this function.

Please read the user's manual carefully before using the DVD player. If you have any troubles in using this player, try to solve the problems by the suggestions mentioned below. If you can not remove the trouble after using all the suggestions, please contact our company or the technical service centre authorised by us. For the sake of your safety, please do not open the cover and repair the player by yourself, if that, it may cause electric shock.

NO PICTURE, SOUND AND INDICATION

- Ensure that the power switch is on.
- Ensure that the wall inlet is ok.
- Ensure that the power cord is not damaged.
- Ensure that the power plug is connected to the inlet tightly.

NO SOUND BUT HAVE PICTURE

- Ensure that the player's audio output has a right connection with TV's audio input.
- Check whether the audio connector is damaged.
- Check whether you have turned down the volume.
- Ensure that you have set the right AUDIO setting of the player.
- Ensure that you have turn your TV to the AV input channel connecting to your player.
- Ensure that the Audio is not out mute.

NO PICTURE BUT HAVE SOUND

- Ensure that the player's video output has a good connection with TV's video input.
- Ensure that you have turn your TV to the AV input channel connecting to your player.
- Check whether the video connector is damaged.
- Ensure that you have set the right VIDEO settings of the player.

BLACK AND WHITE PICTURE OR SCREEN ROLLING

- Ensure that you have set the right TV SYSTEM (e.g. PAL, NTSC) setting

FLAWS OF PICTURE OR SOUND

- Check whether the setting of AUDIO is right.
- Check whether the disc is scratched or stained.
- Check whether the AV connector and the output terminal is stained.

DISPLAY NO DISC

- Ensure that you have put the disc on the tray.
- Check whether the disc is put in the reverse side.
- Check whether the disc is distorted.
- Check whether the disc is stained or scratched badly.

DISPLAY BAD DISC

- Check whether the disc is bad.
- Ensure that the disc is not stained or damaged badly.
- Ensure that the disc format is compatible to the player.
- Ensure that the disc is not deformed.

MICROPHONE HAS NO SOUND

- Ensure that the TV volume is turned on.
- Ensure that the microphone is turned on.
- Ensure that the microphone volume is not set to min.
- Ensure that Karaoke is set to ON.
- Ensure that the connection between microphone and Mic. jack is good.
- Ensure that the microphone is good.

HOWLING WHEN USING MICROPHONE

- Ensure that the microphone is far away from speaker.
- Turn down the volume of speaker and microphone.
- Turn down the echo level.

BAD QUALITY MICROPHONE SOUND

- Check whether microphone is defective.
- The connection between microphone and Mic jack is not good.

REMOTER IS INSENSITIVE OR DOES NOT WORK

- Check the batteries of remoter and make sure that they are to be powerful and good conductivity.
- Direct the remote controller to the IR sensor of the player.
- Check whether there are some obstacles between the remoter and IR sensor.

ABNORMAL FUNCTION OPERATION

- Turn off the power, and then turn on again

UNFINALISED CD-R OR CR-RW IS LOCKED IN THE TRAY

- Unfinalised CD-R or CD-RW is not supported. The disc can not be taken out of the tray when the player is reading. So you have to turn off the power and turn on again, and press OPEN/CLOSE key immediately to open the tray.

Specifications

Other

Power requirements: 110-240V 50/60Hz

Power consumption: 25W

Video Standard: Auto

Unit Weight: 2.9 kg

Unit Dimensions: 430mm (W) x 260mm (D) x 65 mm (H)

Video out

Video out: 1.0V(p-p)/75 Ω sync, negative polarity, RCA pin Jack x 1

S-video output connector (separate Y, C signal output connector):

Y output: 1.0V(p-p)/75 Ω sync, negative polarity

C output: 0.286V(p-p)/75 Ω

4 pin mini DIN x 1

Audio out

Analog out: 1.85V(rms)/10k Ω , RCA pin Jack (L,R) x 1

Coaxial out: 0.5V(p-p)/75 Ω , RCA pin Jack x 1

Optical out: Optical Fibre Transmitter

Frequency response: 20Hz to 20kHz

S/N ratio: > 90db

Total harmonic distortion: < 0.05%

Accessories

Audio/Video cord 1

Remote Controller 1

Battery (AAA) 2

Specifications are subject to change without notice.

Weight and dimensions are approximate.

Remote Control Preparation

Other

Insert batteries

1

1. Open the cover.

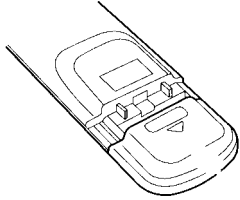

2

2. Insert batteries.

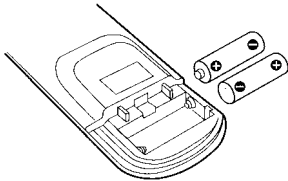

Make sure to match the "+" and "-" of the batteries with the marks inside the battery compartment.

3

3. Close the cover.

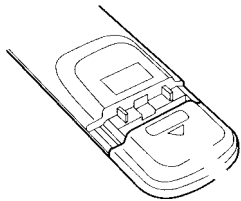

Notes:

Improper use of batteries may cause battery leakage and corrosion. To operate the remote controller correctly, follow the instruction below.

- Do not insert batteries in the wrong direction.
- Do not charge, heat, open, or short-circuit the batteries.
- Do not throw batteries into a fire.
- Do not leave dead batteries in the Remote Control.
- Do not use different types of batteries together or mix old and new batteries.
- If you do not use the remote control for a long period of time, remove the batteries to avoid possible damage from battery corrosion.
- If the remote control does not function correctly or the operating range become reduced, replace all batteries with new ones.
- If battery leakage occurs, clean the battery compartment, then insert new ones.

Using the remote control

Point the remote control at the remote sensor.

(The pictures are only for reference)

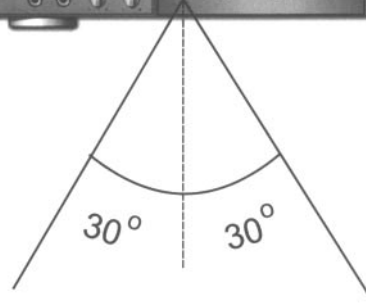

Remarks: Do not expose the remote sensor of the DVD player to strong light source such as direct sunlight.

Notes:

- Point the remote control at the players remote sensor.
- Do not leave the remote control near an extremely hot or humid place.
- Do not spill water or put anything wet on the remote control.
- Battery is -1 year under normal conditions.

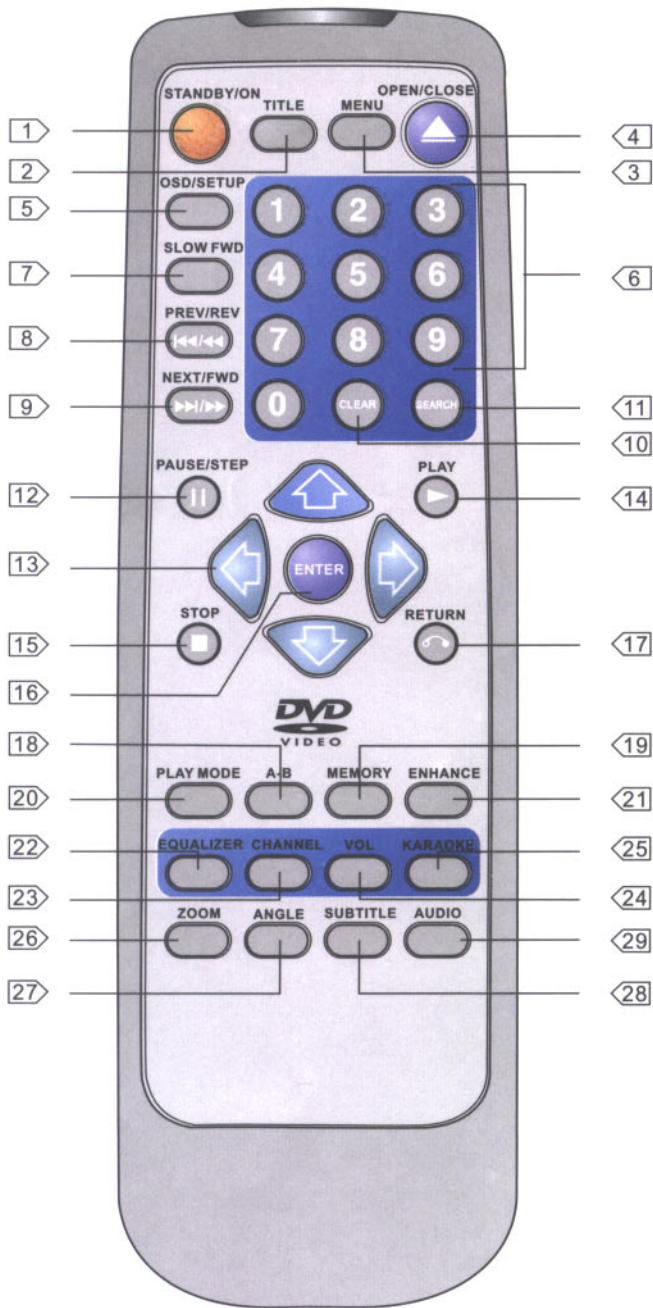

Warning

To prevent children from watching programs which have a rating above their age, please be sure to set the rating in the set up menu appropriately. Before you set this rating, the password must be unlocked. If you forget your unique password, then please use the universal password as set by the manufacturer. The universal password is "0106". Please detach this sheet and keep it in a safe place, away from children."

PALSONIC CORPORATION PTY LTD
1 JOYNTON AVENUE
WATERLOO NSW 2017 AUSTRALIA
TEL: (02) 9313 7111
FAX: (02) 9313 7555
www.palsonic.com.au

**PALSONIC CUSTOMER SERVICE
TELEPHONE
AUSTRALIA: 1300 657 888**

Free Manuals Download Website

<http://myh66.com>

<http://usermanuals.us>

<http://www.somanuals.com>

<http://www.4manuals.cc>

<http://www.manual-lib.com>

<http://www.404manual.com>

<http://www.luxmanual.com>

<http://aubethermostatmanual.com>

Golf course search by state

<http://golfingnear.com>

Email search by domain

<http://emailbydomain.com>

Auto manuals search

<http://auto.somanuals.com>

TV manuals search

<http://tv.somanuals.com>