



PDV-70X

7" Portable DVD Player

User's Manual





Protron PDV-70X Portable DVD Player User's Manual.

© 2006 Protron Digital Corporation. All rights reserved.

Under copyright law, this manual may not be reproduced in any form, in whole or in part, without the prior written consent of Protron Digital Corporation.

Disclaimer

Protron Digital Corporation has reviewed this manual and provides it only as a guide to operation. All statements, technical information, and recommendations in this manual and in any guides or related documents are believed reliable, but the accuracy and completeness thereof are not guaranteed or warranted, and they are not intended to be, nor should they be understood to be, representations or warranties concerning the products described.

Specifications are subject to change without notice.

Protron Digital Corporation
2133 S. Green Privado
Ontario, CA 91761

Printed in China

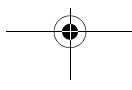
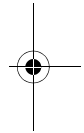
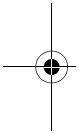

Product Cautions



TO PREVENT POSSIBLE DANGER, ELECTRIC SHOCK, AND INJURY WHEN HANDLING YOUR PORTABLE DVD PLAYER, PLEASE BE AWARE OF ALL WARNINGS AND SAFETY PRECAUTIONS LISTED BELOW.



Never spill any liquid of any kind on the device.

Never insert anything into the device, where objects can come into contact with high voltage nodes or damage internal components.



Do not attempt to service the device yourself. Opening or removing covers exposes high voltage nodes and other hazards. Refer all servicing to qualified service personnel.

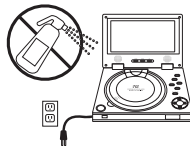

Before cleaning the device, turn it off, unplug it from the wall, and remove the battery. Use a damp cloth for cleaning. Never use liquid or aerosol cleaners.



To prevent overheating and ensure reliable operation, place the device only in a well ventilated location. Avoid cramped or inadequately ventilated locations.

Note: Read all safety and operating instructions before operating your new portable DVD player.

Conformity and Compliance

FCC Compliance Statement

This equipment has been tested and found to comply with the limits for a Class B digital device, pursuant to Part 15 of the FCC Rules. These limits are designed to provide reasonable protection against harmful interference when the equipment is operated in a residential installation. This equipment generates, uses, and can radiate radio frequency energy and, if not installed and used in accordance with the instructions, may cause harmful interference to radio communications. However, there is no guarantee that interference will not occur in a particular installation. If this equipment does cause harmful interference to radio or television reception (this can be determined by turning the device off and on), the user is encouraged to try to correct the interference by one or more of the following measures:



- Reorient or relocate the receiving antenna.
- Increase the separation between the equipment and the receiver.
- Connect the equipment to an outlet on a circuit different from that to which the receiver is connected.
- Consult the dealer or an experienced radio/TV technician for help.

Caution:

To comply with the limits for an FCC Class B computing device, the user should use the shielded signal cable and power cord supplied with the unit. The FCC warns that changes or modifications of the unit not expressly approved by the party responsible for compliance could void the user's authority to operate the equipment.

Radio Frequency Interference Statement

Warning:

This is a Class B product. In a domestic environment this product may cause radio interference, in which case the user may be required to take adequate measures.

UL Mark and Statement

This device is a UL Listed product. UL has found that representative samples of this product met UL's safety requirements.



Canadian DOC Notice for Class B Computing Devices

This digital apparatus does not exceed the Class B limits for radio noise emissions from a digital apparatus as set out in the Radio Interference Regulations of the Canadian Department of Communications.

CE Mark and Declaration of Conformity

This device complies with the requirements of related European standards, which include the following:

- Emission: EN 55022, EN 61000-3-2, EN 61000-3-3
- Immunity: EN 50082-1

Safety: EN 60950 Low-Voltage Directive (73/23/EEC)



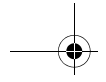

Table of Contents

Introduction	1
Features	1
Unpacking Your New DVD Player	2
Operating the Player	4
Turning the Player On and Off	4
Inserting a Disc	5
Adjusting the Volume	5
Using Headphones	5
Adjusting Color Settings	5
Bringing Up the On-Screen Display	5
Accessing the Setup Menu	5
Playing DVDs	6
The On-Screen Display	6
Navigating Menus	6
Controlling Playback	6
Searching to a Location	7
Repeating Chapters	7
Programming Playback Sequence	7
Playing Video CDs	8
The On-Screen Display	8
Navigating Menus	8
Controlling Playback	8
Searching to a Location	9
Repeating Tracks	9
Programming Playback Sequence	9
Playing Audio CDs	10
The On-Screen Display	10
Controlling Playback	10
Searching to a Location	10
Repeating Tracks	10
Programming Playback Sequence	11
Playing Kodak Picture CDs	12
The On-Screen Display	12
Controlling Playback	12
Navigating Menus	12
Transforming Images	13
Enabling Slideshow Transition Effects	13
Repeating Images	13
Programming Playback Sequence	14
Playing Media on Data CDs	15
The On-Screen Display	15
Using the Menu	15
Controlling Audio File Playback	16

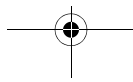
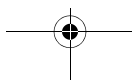
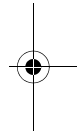
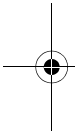
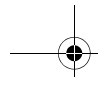



Table of Contents

Controlling Image File Playback	16
Controlling Video File Playback	17
Repeating Files	17
Programming Playback Sequence	18
Using the Remote Control	19
Replacing the Remote Battery	22
Configuring the Player	23
System Setup	23
Language Setup	24
Audio Setup	25
Video Setup	25
Using the Player in a Vehicle	26
Connecting Power	26
Attaching to a Seatback	26
Connecting the Player to Other Devices	28
Connecting to a Separate Display	28
Connecting to a Peripheral Audio System	28
Using the Battery Pack	30
Connecting the Battery	30
Disconnecting the Battery	30
Charging the Battery	30
Troubleshooting	32
Support Information	34
Specifications	35
General	35
Display	35
Audio/Video	35
Battery	35
Limited Warranty	36





Introduction

Congratulations on purchasing your new Protron Portable DVD Player!

With a large 7" screen and over two and a half hours of battery life, your new player allows you to watch movies on the road, in the air—anywhere. In addition, it can play music and photo CDs so you can listen to music or browse photo albums wherever you are.

Audio and video outputs allow you to connect your player to a television and/or stereo system for the highest audio and video quality. A car power adapter allows you to use your player on the road for as long as you want.

Features

- Large 7" screen
- Fully compatible with DVD±RW, Audio CD, MP3 CD, Video CD, Super Video CD, Kodak Picture CD, CD-ROM, CD-R, and CD-RW media
- Superlative error correction
- Displays JPEGs stored on data CDs
- 10-bit, 525-line digital video converter
- 24-bit, 96kHz digital audio converters for high fidelity sound
- Dolby Digital surround sound
- Composite video output
- Digital coaxial audio output
- Stereo audio output
- Headphones output
- Dual earphones with earphones splitter
- 3 languages: English, Spanish, and French
- 32 DVD subtitle channels supported
- Multi-angle video playback

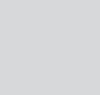
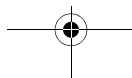

Unpacking Your New DVD Player

Before using your new portable DVD player, you should unpack the contents of the box and check to make sure everything is present and undamaged.

To unpack the player:

1. Open the box. Remove the carrying case, which holds the player in one pocket and the accessories in the other.
2. Open the carrying case and remove the player and accessories.
3. Open the player and peel the protective plastic cover from the screen.
4. Check to ensure the accessories indicated below are included. If any items are missing or damaged, contact the seller immediately.

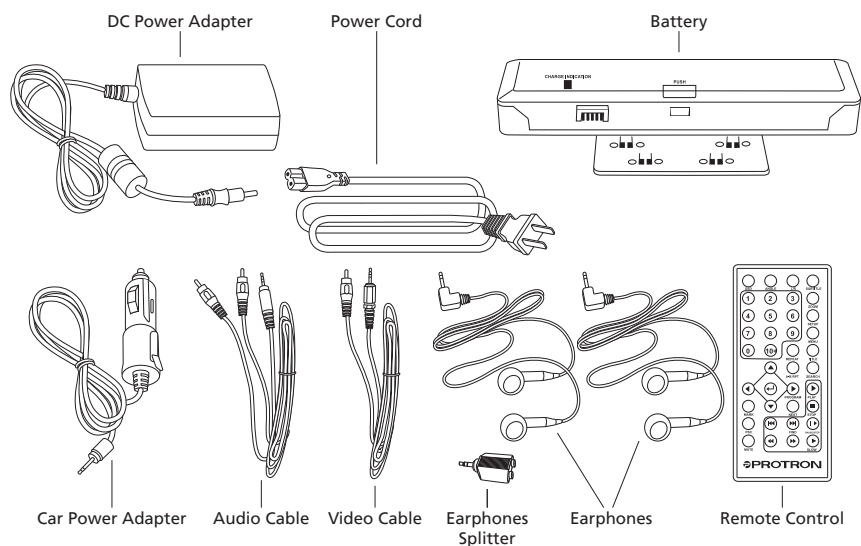
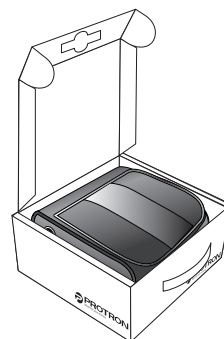

5. Open the disc receptacle by pressing the **OPEN** button, remove the paper laser protector, then close the receptacle.

Unpacking Your New DVD Player

6. Pull the plastic tab out of the battery slot on the remote.

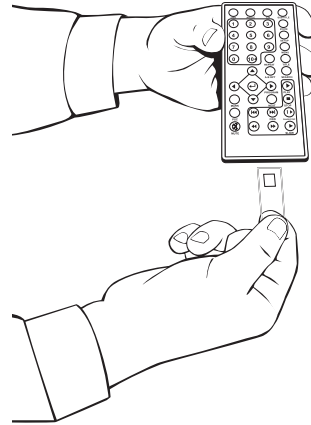

7. Attach the battery to the rear of the player: Line up the four tabs on the battery with the four corresponding slots on the player, drop the tabs into the slots, then slide the battery toward the front of the display.

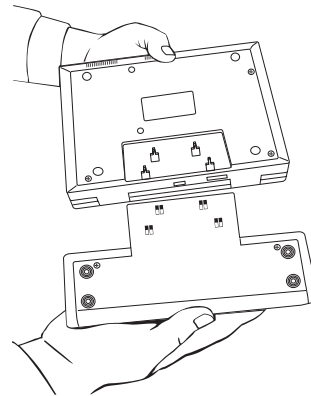

8. Connect one end of the power cord to a wall socket, and the other end to the power adapter.
9. Connect the power adapter to the IN 12V jack on the side of the player. The CHARGE INDICATION light on the battery should come on, indicating that the battery is charging.

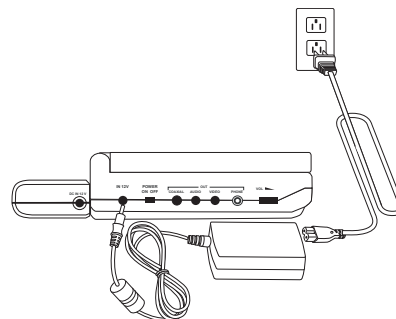

Operating the Player

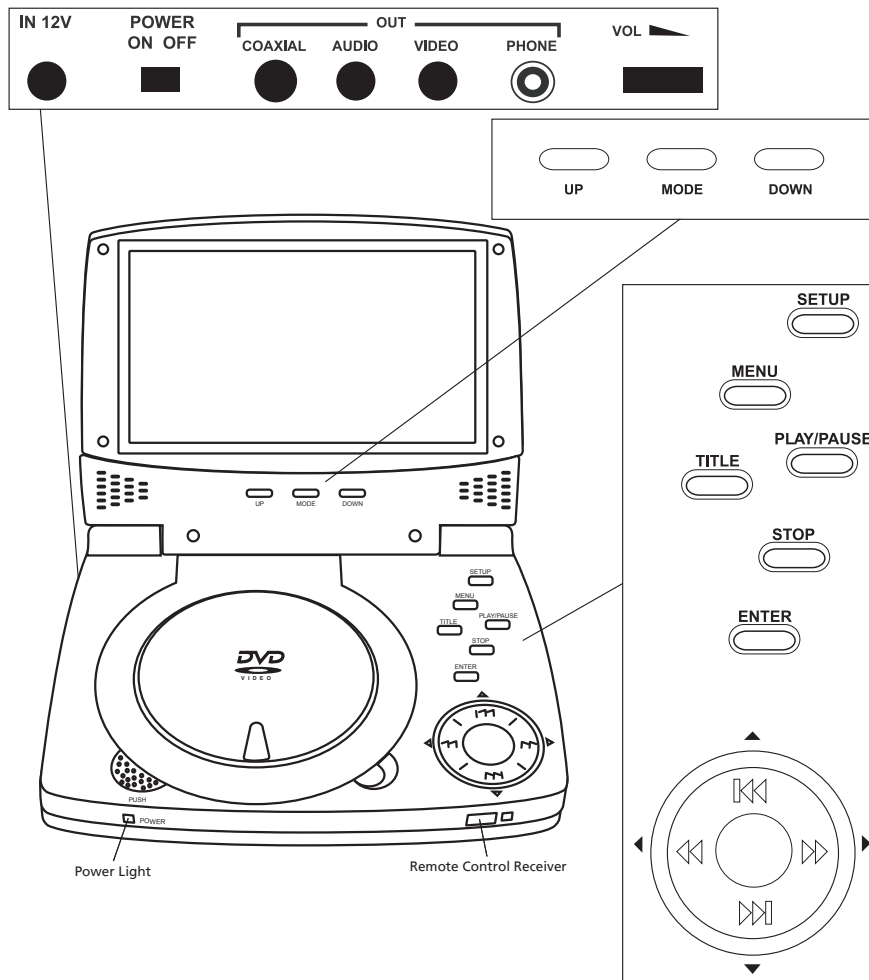

Turning the Player On and Off

Once a charged battery is attached to the player or the player is attached to a power outlet with the power adapter, turn the player on and off by sliding the POWER switch on the left side of the player to the appropriate position.

Inserting a Disc

The receptacle for DVDs and CDs is located directly beneath the screen.

To insert a disc:

1. Press the **OPEN** button to open the receptacle.
2. Snap the disc onto the spindle in the center.
3. Close the receptacle cover. The player will begin to play the disc.

Adjusting the Volume

The **VOL** knob on the left side of the player sets the speaker and headphones volume. To adjust the volume, swivel the knob in the appropriate direction.

Using Headphones

To listen to the audio using headphones, plug them into the **PHONE** jack on the left side of the player. The speakers will mute when headphones are plugged in.

To use two sets of headphones simultaneously, plug the earphones splitter (shown on page 2) into the **PHONE** jack, and then plug both sets of headphones into the splitter.

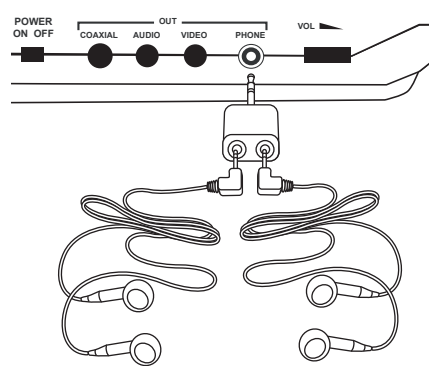

Adjusting Color Settings

You can adjust display color settings with the buttons directly below the player's screen. There are three color settings: Brightness, Contrast, and Color.

Press the **MODE** button to cycle through these, and press the **DOWN** and **UP** buttons to adjust the selected setting.

To reset the color settings, press **MODE** until **RESET** is highlighted and press either **DOWN** or **UP**.

The menu will disappear after a few seconds of inactivity.

Bringing Up the On-Screen Display

The On-Screen Display (OSD) gives information about the current disc and playback. To bring up the OSD, press the **OSD** button on the remote.

Accessing the Setup Menu

The Setup menu allows you to configure the operation of the player. You can change video, audio, and language settings, control access to mature programming, and configure other general display behavior. See "Configuring the Player" on page 23 for more information. To access the Setup menu, press the **SETUP** button.

Playing DVDs

DVDs will play upon insertion. The player can perform all standard DVD playback and search functions.

The On-Screen Display

The DVD OSD has two modes:

The first mode (press **OSD** once) shows the current title, chapter, and playback time.

DVD TT 2/18 CH 2/40 ⌚ 00 : 00 : 31

The second mode (press **OSD** a second time) shows the current audio channel, subtitle channel, and camera angle.

⌂ 1/1ENG 📺 1CH 🗣️ OFF 📷 OFF

Press **OSD** a third time to exit the OSD.

Navigating Menus

When in a DVD menu, use the arrow controls to navigate.

Press **ENTER** to select an item.

Press **MENU** to return to the previous menu.

Controlling Playback

Press **■** once to stop the DVD at the current location, and twice to stop the DVD completely.

When the DVD is playing, press **⏸** to pause it.

When the DVD is paused, press **⏸** to step forward one frame at a time.

Press **⏮** to return to the previous chapter.

Press **⏭** to skip to the next chapter.

Press **⏪** to fast reverse the DVD. Press **⏩** to fast forward the DVD. Repeated presses cycle through the speed options: x2, x4, x8, x20, and normal speed.

Press **⏮** to play the video at a slower speed. Repeated presses cycle through the speed options: x1/2, x1/3, x1/4, x1/5, x1/6, x1/7, and normal speed.

Press **▶** to return to normal play mode or to start playing the DVD again when it is stopped or paused.

Press **MENU** to return to the last DVD menu.

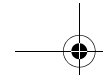

Searching to a Location

You can search to a title, chapter, or time on the current disc using the **SEARCH** button.

To search to a location:

1. Press **SEARCH** to bring up the Search menu.
2. Use ◀ and ▶ to select title, chapter, or time.
3. Enter the desired location.
4. Press ↵.

Repeating Chapters

Press **REPEAT** to cycle through the repeat modes: Off, Chapter, Title, and All. You can repeat an arbitrary section of video using the **A-B RPT** button.

To repeat an arbitrary selection:

1. Press **A-B RPT** once. "REPEAT A-" shows to mark the beginning of the section.
2. Press **A-B RPT** once more to mark the end of the section. "REPEAT A-B" will display on the screen.

The section will begin repeating and will continue until you press **A-B RPT** again.

Programming Playback Sequence

The **PROGRAM** button brings up the Program menu, which allows you to program playback sequence. There are 16 slots available.

To program playback sequence:

1. Press **PROGRAM** to bring up the Program menu.
2. Select the first slot using the arrow controls, and enter the desired title (under the "T" column) and chapter (under the "C" column) numbers using the keypad.
3. Proceed in the same manner through the next slots until the whole sequence is programmed.
4. Select "PLAY" using the arrow controls and then press ↵ to begin playing back the sequence.

PROG		T C		T C		T C		T C	
1	--:--	5	--:--	9	--:--	13	--:--		
2	--:--	6	--:--	10	--:--	14	--:--		
3	--:--	7	--:--	11	--:--	15	--:--		
4	--:--	8	--:--	12	--:--	16	--:--		
				PLAY		CLEAR			

Select "CLEAR" and press ↵ to clear the playback sequence and start over.

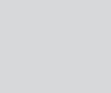
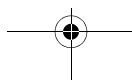

Playing Video CDs

Video CDs can contain video or still images such as photos. Your DVD player will play all standard Video CD formats.



Upon insertion, the player will read and begin to play the CD.

If there is a menu on the CD, it will appear, allowing you to navigate through the tracks stored on the CD. Otherwise, the player will begin playing the video back beginning with the first track.

If the CD contains still pictures, the player will display them as a slideshow.

The On-Screen Display

The Video CD OSD displays the current track, mute status, playback control status (PBC—the playback control status determines whether the disc menu is available), repeat mode, and playback time.

VCD TRK 2/18  PBC   00 : 00 : 31

Navigating Menus

Press **◀** and **▶** to scroll through menu pages.

To view an item, enter its number on the keypad.

Note: To view an item, the menu page containing the item must be visible before you enter the item's number.

Controlling Playback

Press **■** once to stop the disc at the current location, and twice to stop the disc completely.

When the disc is playing, press **⏸** to pause it.

When the disc is paused, press **⏸** to step forward one frame at a time.

Press **◀** to return to the previous track.

Press **▶** to skip to the next track.

Press **⏮** to fast reverse the video. Press **⏭** to fast forward the video. Repeated presses cycle through the speed options: x2, x4, x8, x20, and normal speed.

Press **⏪** to play the video at a slower speed. Repeated presses cycle through the speed options: x1/2, x1/3, x1/4, x1/5, x1/6, x1/7, and normal speed.

Press **▶** to return to normal play mode or to start playing the disc again when it is stopped or paused.

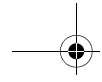

Searching to a Location

You can search to a track or time on the current disc using the **SEARCH** button.

To search to a location:

1. Press **SEARCH** to bring up the Search menu.
2. Use ◀ and ▶ to select track or time.
3. Enter the desired location.
4. Press ↵.

Repeating Tracks

Press **REPEAT** to cycle through the repeat modes: Off, Repeat One, and Repeat All. You can repeat an arbitrary section of video using the **A-B RPT** button.

Note: To repeat tracks on a Video CD, playback control must be off. Press **PBC** to turn playback control on and off.

To repeat an arbitrary selection:

1. Press **A-B RPT** once. "REPEAT A-" shows to mark the beginning of the section.
2. Press **A-B RPT** once more to mark the end of the section. "REPEAT A-B" will display on the screen.

The section will begin repeating and will continue until you press **A-B RPT** again.

Programming Playback Sequence

The **PROGRAM** button brings up the Program menu, which allows you to program playback sequence. There are 16 slots available.

To program playback sequence:

1. Press **PROGRAM** to bring up the Program menu.
2. Select the first slot using the arrow controls, and enter the desired track number using the keypad.
3. Proceed in the same manner through the next slots until the whole sequence is programmed.
4. Select "PLAY" using the arrow controls and then press ↵ to begin playing back the sequence.

PROG			
1 [--]	5 [--]	9 [--]	13 [--]
2 [--]	6 [--]	10 [--]	14 [--]
3 [--]	7 [--]	11 [--]	15 [--]
4 [--]	8 [--]	12 [--]	16 [--]
PLAY		CLEAR	

Select "CLEAR" and press ↵ to clear the playback sequence and start over.

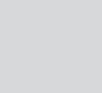
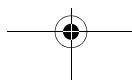

Playing Audio CDs

Audio CDs will play upon insertion. All standard Audio CD navigation features are available.

The On-Screen Display

The Audio CD OSD displays the current track, mute status, repeat mode, and playback time.

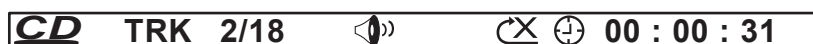

Controlling Playback

Press **■** once to stop the disc at the current location, and twice to stop the disc completely.

When the disc is playing, press **⏸** to pause it.

Press **⏮** to return to the previous track.

Press **⏭** to skip to the next track.

Press **⏮** to fast reverse the audio. Press **⏭** to fast forward the audio. Repeated presses cycle through the speed options: x2, x4, x8, x20, and normal speed.

Press **▶** to return to normal play mode or to start playing the disc again when it is stopped or paused.

To skip directly to a track, enter the track number on the keypad.

Searching to a Location

You can search to a track or time on the current disc using the **SEARCH** button.

To search to a location:

1. Press **SEARCH** to bring up the Search menu.
2. Use **◀** and **▶** to select track or time.
3. Enter the desired location.
4. Press **↵**.

Repeating Tracks

Press **REPEAT** to cycle through the repeat modes: Off, Repeat One, and Repeat All. You can repeat an arbitrary section of audio using the **A-B RPT** button.

To repeat an arbitrary selection:

1. Press **A-B RPT** once. "REPEAT A—" shows to mark the beginning of the section.

2. Press **A-B RPT** once more to mark the end of the section. "REPEAT A-B" will display on the screen.

The section will begin repeating and will continue until you press **A-B RPT** again.

Programming Playback Sequence

The **PROGRAM** button brings up the Program menu, which allows you to program playback sequence. There are 16 slots available.

To program playback sequence:

1. Press **PROGRAM** to bring up the Program menu.
2. Select the first slot using the arrow controls, and enter the desired track number using the keypad.
3. Proceed in the same manner through the next slots until the whole sequence is programmed.
4. Select "PLAY" using the arrow controls and then press \leftarrow to begin playing back the sequence.

PROG			
1 [--]	5 [--]	9 [--]	13 [--]
2 [--]	6 [--]	10 [--]	14 [--]
3 [--]	7 [--]	11 [--]	15 [--]
4 [--]	8 [--]	12 [--]	16 [--]
PLAY		CLEAR	

Select "CLEAR" and press \leftarrow to clear the playback sequence and start over.

Playing Kodak Picture CDs

Upon insertion, the player will read and begin to play your Kodak Picture CD, displaying a slideshow of the images on the disc.

The On-Screen Display

The OSD shows the current image number and repeat mode.

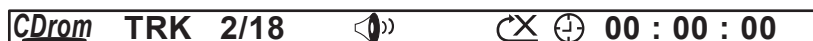

Controlling Playback

Press **■** to stop slideshow playback and return to the menu.

When the disc is playing, press **⏸** to pause it.

Press **▶** to start playing the slideshow again when it is stopped or paused.

Press **◀◀** to return to the previous image.

Press **▶▶** to skip to the next image.

To skip directly to an image, enter the image number on the keypad.

Navigating Menus

Press **■** while the slideshow is playing to bring up the thumbnail menu, which displays thumbnails of the images on the disc.

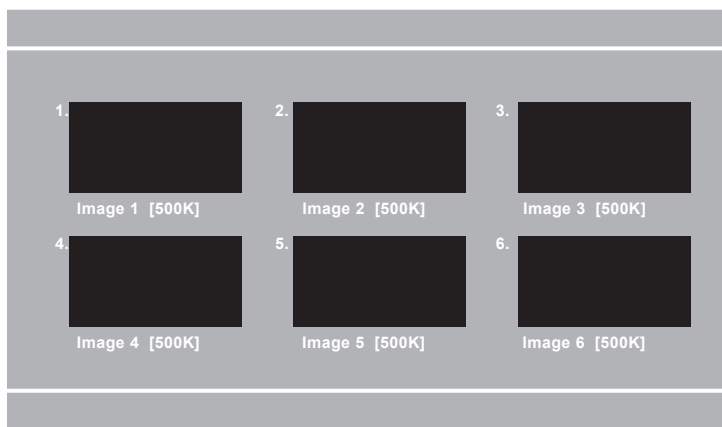

Note: If you press **■** a second time while viewing the thumbnail menu, the player will display a list of media on the disc, as described in "Playing Media on Data CDs" on page 15. When this occurs, the thumbnail view will be unavailable until you eject and re-insert the disc.

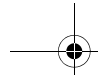

Playing Kodak Picture CDs

Press **⏪** and **⏩** to scroll through menu pages.

Use the arrow controls to select the desired image and press **↵**. Alternatively, enter the number of the desired image on the keypad. The selected image will display on the screen. Press **▶** to start a slideshow beginning with the selected image.

Transforming Images

Press **▶** to rotate the image 90° clockwise.

Press **◀** to rotate the image 90° counterclockwise.

Press **▲** to flip the image vertically.

Press **▼** to flip the image horizontally.

Enabling Slideshow Transition Effects

Press **PROGRAM** to cycle through the slideshow transition effects:

- None
- Wipe Top
- Wipe Bottom
- Wipe Left
- Wipe Right
- Diagonal Wipe Left Top
- Diagonal Wipe Right Top
- Diagonal Wipe Left Bottom
- Diagonal Wipe Right Bottom
- Extend from Center Horizontally
- Extend from Center Vertically
- Compress to Center Horizontally
- Compress to Center Vertically
- Window Horizontally
- Window Vertically
- Wipe from Edge to Center
- Random

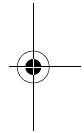
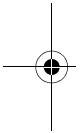

Repeating Images

Press **REPEAT** to cycle through the repeat modes: Off, Repeat One, Repeat Directory, and Repeat All.

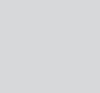
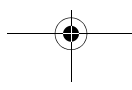

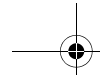

Playing Kodak Picture CDs

Programming Playback Sequence

The **PROGRAM** button brings up the Program menu, which allows you to program playback sequence. There are 16 slots available.

To program playback sequence:

1. Press **PROGRAM** to bring up the Program menu.
2. Select the first slot using the arrow controls, and enter the desired folder (under the "T" column) and file (under the "C" column) numbers using the keypad.
3. Proceed in the same manner through the next slots until the whole sequence is programmed.
4. Select "PLAY" using the arrow controls and then press \leftarrow to begin playing back the sequence.

PROG		T	C	T	C	T	C	T	C
1	--:--	5	--:--	9	--:--	13	--:--		
2	--:--	6	--:--	10	--:--	14	--:--		
3	--:--	7	--:--	11	--:--	15	--:--		
4	--:--	8	--:--	12	--:--	16	--:--		
				PLAY	CLEAR				

Select "CLEAR" and press \leftarrow to clear the playback sequence and start over.

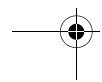
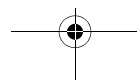
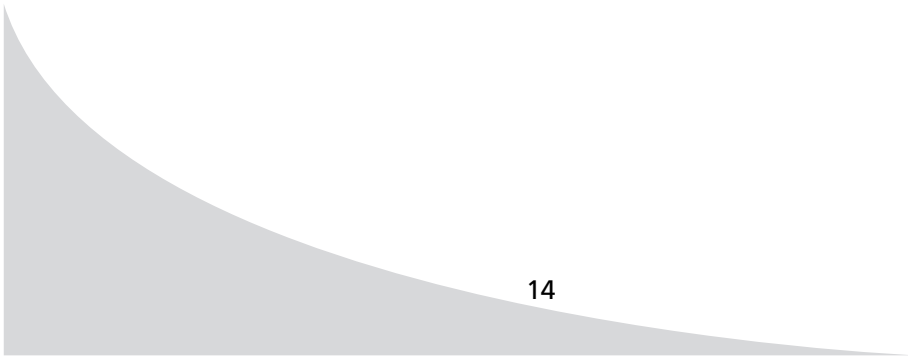
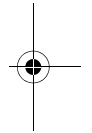
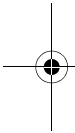

Playing Media on Data CDs

Upon inserting a data CD, the player will display a menu showing all media files on the disc and allowing you to select files for playback.

The On-Screen Display

The OSD displays the current file number, mute status, repeat mode, and playback time.

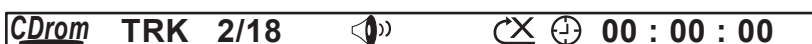

Using the Menu

The menu allows you to navigate tracks and program playback sequence.

There are three views within the menu, listed at the bottom right of the screen, which allow playback of different types of media: audio (MP3), image (JPEG), and video (MPEG).

The top of the menu shows the path and filename of the currently selected file.

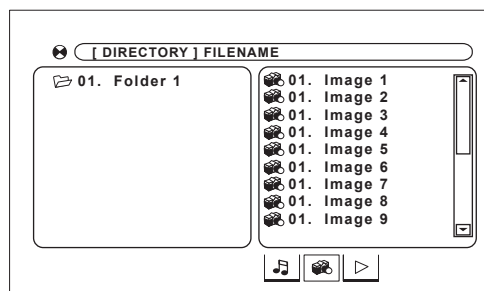

The left column gives a list of folders on the disc. When an image is selected in the right column, the left column shows a preview of the image.

The right column gives a list of files in the current folder.

To use the menu:

1. Use ► and ◀ to navigate to the media types at the bottom right of the screen and highlight the desired media type.
2. Press ↵ to select it.
3. Press ◀ until the left column is highlighted.
4. Use ▲ and ▼ to highlight the desired folder.
5. Press ↵ to enter the folder.
6. Press ► to highlight the right column.
7. Use ▲ and ▼ to highlight the desired file.
8. Press ↵ to play back the audio/video or display the image. If the file is an image, you can press ► to start playback of a slideshow beginning with that image.

Playing Media on Data CDs

Controlling Audio File Playback

Press **II▶** to pause playback. Press **▶** to resume playback.

Press **■** once to stop CD playback at the current location, and twice to stop the CD completely.

Press **◀◀** to return to the previous file.

Press **▶▶** to skip to the next file.

Press **◀◀** to fast reverse playback. Press **▶▶** to fast forward playback. Repeated presses cycle through the speed options: x2, x4, x8, and x20.

Press **▶** to return to normal play mode or to start playing the disc again when it is stopped.

To skip directly to a file, enter the file number on the keypad.

Controlling Image File Playback

Press **II▶** to pause playback. Press **▶** to resume playback.

Press **■** to stop the slideshow and return to the menu.

Press **◀◀** to return to the previous image.

Press **▶▶** to skip to the next image.

Press **▶** to rotate the image 90° clockwise.

Press **◀** to rotate the image 90° counterclockwise.

Press **▲** to flip the image vertically.

Press **▼** to flip the image horizontally.

Press **PROGRAM** to cycle through the slideshow transition effects:

- None
- Wipe Top
- Wipe Bottom
- Wipe Left
- Wipe Right
- Diagonal Wipe Left Top
- Diagonal Wipe Right Top
- Diagonal Wipe Left Bottom
- Diagonal Wipe Right Bottom
- Extend from Center Horizontally
- Extend from Center Vertically
- Compress to Center Horizontally
- Compress to Center Vertically
- Window Horizontally



Playing Media on Data CDs

- Window Vertically
- Wipe from Edge to Center
- Random

Controlling Video File Playback

When video is playing, press **II▶** to pause it.

When the video is paused, press **II▶** to step forward one frame at a time.

Press **■** to stop playback and return to the menu.

Press **◀◀** to return to the previous file.

Press **▶▶** to skip to the next file.

Press **◀◀** to fast reverse playback. Press **▶▶** to fast forward playback. Repeated presses cycle through the speed options: x2, x4, x8, and x20.

Press **▶** to play the video at a slower speed. Repeated presses cycle through the speed options: x1/2, x1/3, x1/4, x1/5, x1/6, x1/7, and normal speed.

Press **▶** to return to normal play mode or to start playing the disc again when it is stopped or paused.

Repeating Files

Press **REPEAT** to cycle through the repeat modes: Off, File, Directory, and All. You can repeat an arbitrary section using the **A-B RPT** button.

To repeat an arbitrary selection:

1. Press **A-B RPT** once. "REPEAT A-" shows to mark the beginning of the section.
2. Press **A-B RPT** once more to mark the end of the section. "REPEAT A-B" will display on the screen.

The section will begin repeating and will continue until you press **A-B RPT** again.

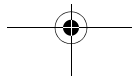

Playing Media on Data CDs

Programming Playback Sequence

The **PROGRAM** button brings up the Program menu, which allows you to program playback sequence. There are 16 slots available.

To program playback sequence:

1. Press **PROGRAM** to bring up the Program menu.
2. Select the first slot using the arrow controls, and enter the desired folder (under the "T" column) and file (under the "C" column) numbers using the keypad.
3. Proceed in the same manner through the next slots until the whole sequence is programmed.
4. Select "PLAY" using the arrow controls and then press \leftarrow to begin playing back the sequence.

PROG			
T	C	T	C
1	--:--	5	--:--
2	--:--	6	--:--
3	--:--	7	--:--
4	--:--	8	--:--
		9	--:--
		10	--:--
		11	--:--
		12	--:--
		13	--:--
		14	--:--
		15	--:--
		16	--:--
PLAY		CLEAR	



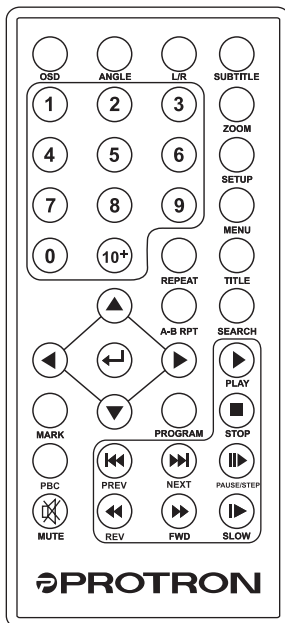

Select "CLEAR" and press \leftarrow to clear the playback sequence and start over.

Using the Remote Control









The remote control can be used to control every aspect of the display's operation and includes more functionality than the controls on the player itself.





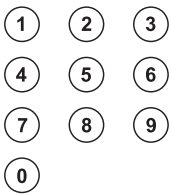



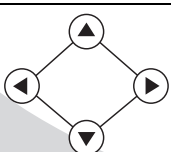





The following is a list of all buttons on the remote and their functions:

Button	Function
 OSD	Brings up the On-Screen Display (OSD), which shows current playback information
 ANGLE	Changes the filming angle when playing back a multi-angle DVD
 L/R	Cycles through the available audio channels on a DVD. When playing back a CD, this button cycles through stereo, mono (left channel), and mono (right channel) playback.
 SUBTITLE	Cycles through the available subtitle channels on a DVD

Using the Remote Control

Button	Function
 <p>ZOOM</p>	<p>Zooms in on the picture</p> <p>When viewing a DVD or Video CD, pressing this button repeatedly cycles through seven zoom levels: x2, x3, x4, x1/2, x1/3, x1/4, and x1.</p> <p>When viewing a data CD containing images, pressing the button cycles through five zoom levels: 25%, 50%, 100%, 150%, and 200%.</p>
 <p>SETUP</p>	<p>Brings up the Setup menu and pauses playback</p>
 <p>MENU</p>	<p>When playing a DVD or Video CD, returns to the previous menu</p>
 <p>TITLE</p>	<p>Returns to the main menu</p>
	<p>Used to enter numbers and navigate directly to a specified track (CDs and Video CDs), chapter (DVDs), or photo (photo CDs)</p>
 <p>10+</p>	<p>Used to access tracks, chapters, or photos numbered 10 or higher. To use, press repeatedly until the correct decade is selected, then use the keypad to enter the least significant digit.</p>
 <p>REPEAT</p>	<p>Cycles through the available repeat modes</p>
 <p>A-B RPT</p>	<p>Marks an arbitrary section to be repeated</p>
 <p>SEARCH</p>	<p>Brings up the search display, which you can use to skip to a specified location</p>
	<p>Used to navigate menus and displays</p>

Using the Remote Control

Button	Function
	Confirms the current selection or entry
 MARK	Brings up the mark display, which you can use to mark the current location and later return to it
 PROGRAM	Brings up the program display, which you can use to program playback sequences for CDs
 PBC	When playing DVDs or Video CDs, turns off playback control to enable playback sequence programming using the PROGRAM button. In addition, when playback control is off, the player will skip the root menu on a Video CD when the disc is inserted and begin playback with the first track.
 MUTE	Mutes the audio
 PLAY	Resumes normal playback mode
 STOP	Stops playback. Press twice to completely stop a disc.
 PREV	Returns to the previous chapter, track, or photo
 NEXT	Skips to the next chapter, track, or photo
 PAUSE/STEP	When in normal play mode, this button pauses playback. When a DVD is paused, this button steps forward one frame at a time. When a CD is paused, pressing the button resumes normal play mode.
 REV	Reverses DVD or CD playback. Pressing this button repeatedly cycles through the reverse speeds: x2, x4, x8, and x20.
 FWD	Fast forwards the DVD or CD. Pressing this button repeatedly cycles through the fast forward speeds: x2, x4, x8, and x20.

Using the Remote Control

Button	Function
 SLOW	Slows down the playback speed of a DVD. Pressing this button repeatedly cycles through the speeds: $\times 1/2$, $\times 1/3$, $\times 1/4$, $\times 1/5$, $\times 1/6$, and $\times 1/7$.

Note: If a hand icon appears upon pressing a button on the remote, it means that the button you have pressed does not function in the current mode or for the disc in the player.

Replacing the Remote Battery

The remote requires a CR2025 battery, which is held in a small enclosure at the bottom of the remote.

To replace the battery:

1. Release the tab and pull the enclosure out of the remote.
2. Remove the old battery and replace it with the new battery. The positive (+) terminal should face the bottom of the remote.
3. Slide the enclosure back into the remote.

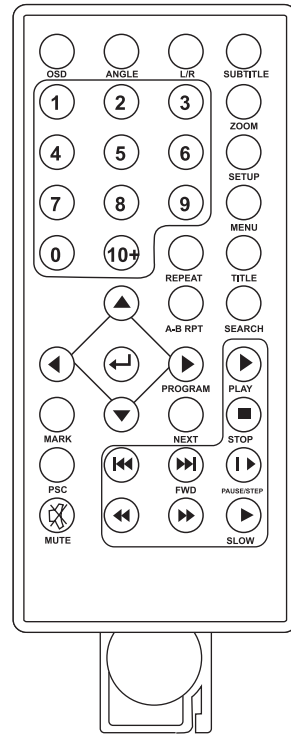

Configuring the Player

The Setup menu allows you to configure the operation of the player. You can change video, audio, and language settings, control access to mature programming, and configure other general display behavior.

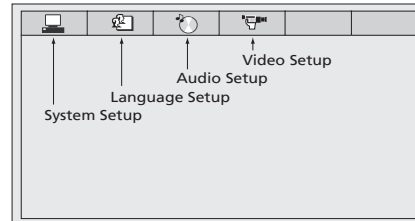

To use the Setup menu:

1. Press the **SETUP** button to bring up the menu.
2. Once the menu appears, use the ◀ and ▶ buttons to navigate the sub-menus listed at the top of the menu.
3. Press ▼ to enter a sub-menu. (Press ▲ repeatedly to leave a sub-menu.)
4. Use ▲ and ▼ to select an item. A list of the options available for the currently selected item will show to the right.
5. Press ▶ to enter the list of available options.
6. Use ▲ and ▼ to select the desired option and then press **ENTER** to select it.
7. Press the **SETUP** button to exit the menu.

The following is a description of the contents of the Setup menu and their use.

System Setup

The System Setup menu allows you to change general system parameters. This includes display parameters for the player's built-in screen, as well as any external display to which the player is connected (see "Connecting to a Separate Display" on page 28), and parental controls.

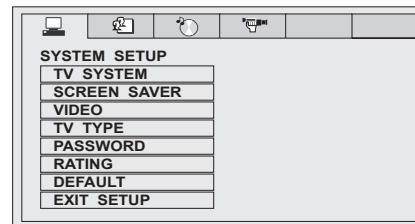

The sub-menus are as follows:

TV System

Selects the video format used to transmit video to an external display:

- **NTSC**—A format used primarily in North and Central America
- **PAL**—A format used in various parts of the world, including Europe, Asia, South America, and the Middle East

Screen Saver

Turns the screen saver on and off. When this is on, a screen saver will come on after a period of inactivity to save battery life.

Configuring the Player

Video

TV Type

Selects the aspect ratio used by the external display, as well as the mode used to display widescreen video (when 4:3 is selected):

- **4:3PS**—Crops the video image to fill the entire screen of a 4:3 format display
- **4:3LB**—Displays the full image on the screen, but does not fill the entire screen
- **16:9**—Native widescreen



4:3 PS



4:3 LB



16:9

Password

Sets the password for parental control. The factory default password is '0000'.

Rating

Selects the content rating above which a password will be required:

- 1 Kid Safe
- 2 G
- 3 PG
- 4 PG-13
- 5 PG-R
- 6 R
- 7 NC-17
- 8 Adult

Default

Resets all settings to factory defaults

Language Setup

The Language Setup menu allows you to change the language used by the player for menus, audio, and subtitles.

The menu items are as follows:

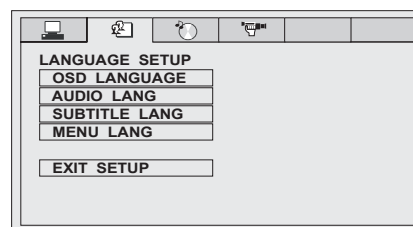

OSD Language

Changes the language of the Setup menu and the OSD, which displays information about the current media and settings.

Audio Lang

Changes the language used for audio.

Subtitle Lang

Changes the language used for subtitles.

Menu Lang

Changes the language used for disc menus.

Audio Setup

This menu configures the audio format used for audio output. The sub-menus are:

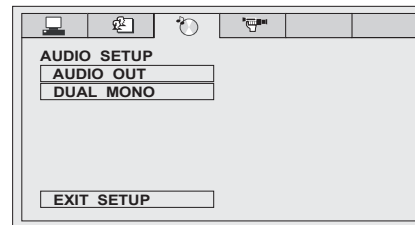

Audio Out

Selects the format used for digital audio output. The options are

- **SPDIF/PCM**
- **Off**

Dual Mono

Turns mono audio on and off and configures how it is mixed:

- **Stereo**—No mono
- **Mono Left**—Left channel only
- **Mono Right**—Right channel only
- **Mix Mono**—Left and right channels mixed

Video Setup

The Custom Setup menu configures other player parameters, as listed below:

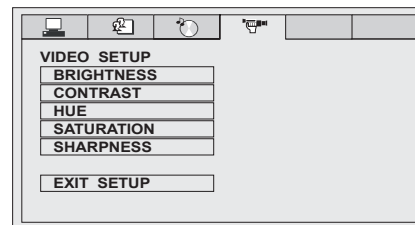

Brightness

Controls the brightness of the image.

Contrast

Controls the variance between light and dark in the image.

Using the Player in a Vehicle

Your portable DVD player is designed to accommodate usage in a vehicle. A vehicle power adapter is included to power the player from your vehicle, and the carrying case can be adapted to attach the player to a seatback.

Connecting Power

To connect the player to the vehicle's power supply, attach one end of the included vehicle power adapter to the IN 12V jack on the player, and the other end to a cigarette lighter power outlet.

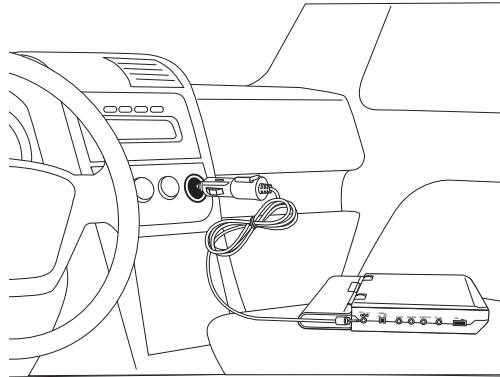

Attaching to a Seatback

The carrying case can be used to attach the player to a seatback, such as in a vehicle or airplane.

To attach the player to a seatback:

1. Slide the player (with battery attached) into the main pocket of the carrying case.
2. Open the player and secure the screen with the two small elastic straps on the flap of the carrying case.





Using the Player in a Vehicle

3. Attach the carrying case strap to the front set of plastic eyelets and tighten it around the base of the headrest.

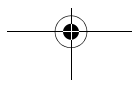
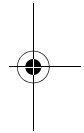
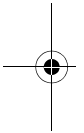
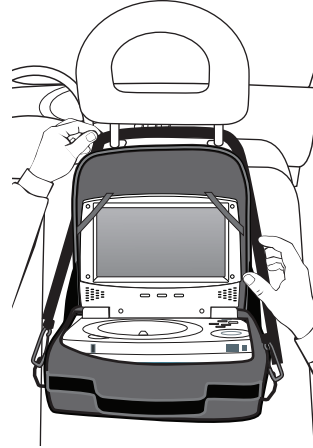

Connecting the Player to Other Devices

You can connect your portable DVD player to an external display for a larger picture, or to an external audio system for better sound.

Connecting to a Separate Display

To connect to a separate display, attach the yellow end of the included video adapter cable to the composite video input on the display, and attach the other end to the VIDEO jack on the player.

To connect the audio output to the display as well, attach the red (right) and white (left) connectors on the included audio adapter cable to the display's audio input, and connect the other end of the cable to the AUDIO jack on the player.

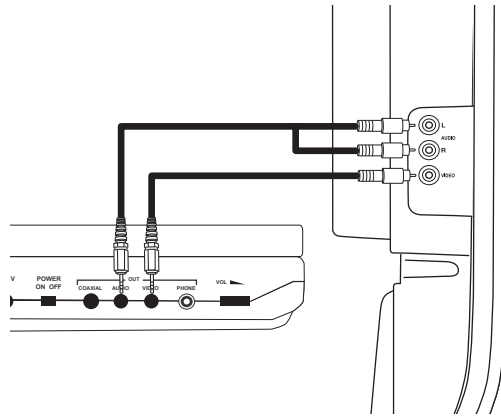

Once the player is connected to the display, select the appropriate TV Type setting under the System Setup menu on the player (see "Configuring the Player" on page 23).

Connecting to a Peripheral Audio System

There are two outputs that can be used to connect to an external audio system: analog and digital. If your audio system supports digital audio, use the digital output, as it will provide better sound quality.

To connect to a digital (S/PDIF) system, use a 1/8"-to-TOSLINK™ or 1/8"-to-coaxial audio cable to connect the COAXIAL output on the player to a digital audio input on the audio system.

Once the player is connected to the audio system, select the appropriate Digital Out setting under the Audio Setup menu on the player (see "Configuring the Player" on page 23).

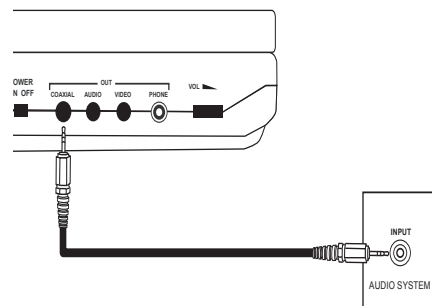

Connecting the Player to Other Devices

To connect to an analog system, attach the red (left) and white (right) connectors on the included audio adapter cable to an audio system input, and connect the other end of the cable to the AUDIO jack on the player.

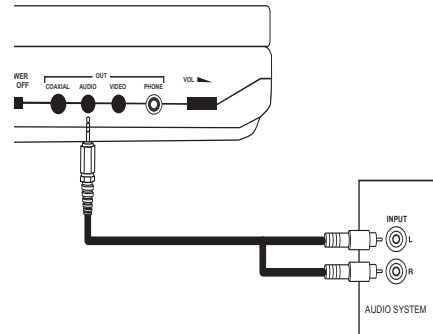

Using the Battery Pack

The battery life of the included battery pack is more than two and a half hours. It attaches to the rear of the player and may be charged separately or while connected to the player.

Connecting the Battery

To connect the battery to the player, align the notches on the battery with the holes on the bottom of the player, push the notches into the holes, and slide the battery and player together.

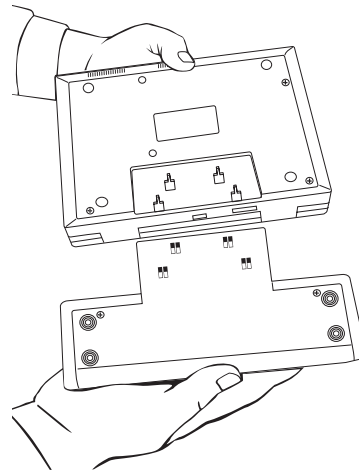

Disconnecting the Battery

To disconnect the battery, hold down the **PUSH** button on the top of the battery and slide the battery and player apart.

Charging the Battery

The battery may be charged while connected to the player or separately.

To charge the battery while connected, attach one end of the power adapter to the IN 12V jack on the player, and the other end to a power source.

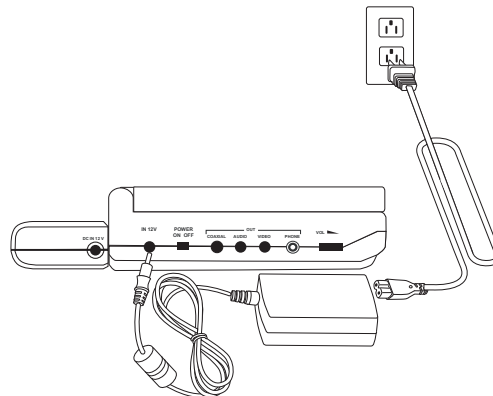



To charge the battery separately, attach the power adapter to the DC 12V IN jack on the battery itself.

Using the Battery Pack

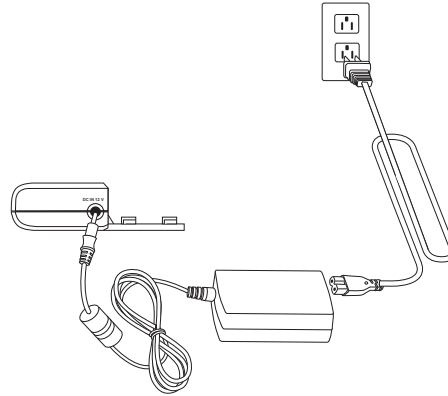

Troubleshooting

Symptom	Possible Cause	Resolution
Power light does not come on	Power cord(s) not securely connected	Make sure the power cable from the DC power adapter is firmly inserted into the socket on the display. Make sure the power cord from the wall is connected securely to the DC power adapter and wall outlet.
	Power outlet is off or not working	If the power outlet is working, the blue light on the DC power adapter will come on when it is plugged in. If it doesn't, try plugging a different device into the outlet and see if it turns on. If not, check that the outlet is on or use a different outlet.
	Battery is discharged	Recharge the battery and/or plug in the player.
Screen flashing on and off	The battery is low on energy	Plug in the player and/or recharge the battery.
Unclear or noisy picture on external display	Signal cable(s) not securely connected	Make sure the signal cable(s) are firmly connected.
	Radio interference	Check for any electronic devices nearby that might be interfering with the video signal or the player's operation.
No picture	Player is in power saving mode	Press PLAY to bring the player out of power saving mode.
No picture on external display	No signal	Make sure the proper source is selected on the external display. If there is still no picture, check the signal cable(s) and ensure the player is on and working.

Symptom	Possible Cause	Resolution
No sound	Audio cable(s) not securely connected	Make sure the audio signal cable(s) are firmly connected.
	Headphones plugged in	Unplug the headphones.
	Audio muted	Unmute the audio by pressing the MUTE button on the remote.
Display is too dark or too bright	Contrast or brightness too low or too high	Adjust the contrast and/or brightness to desired setting.
Remote control not functioning	Battery inserted improperly	Make sure the battery is inserted and oriented properly.
	Battery low on energy	Replace the battery.
	A button is stuck	Jog any stuck buttons on the remote to unstick them.
	Obstacle between remote and display	Remove the obstacle.
	The remote is too far from the display	Move closer to the display.
After-image remains on screen after display is turned off	Inherent LCD characteristics	This is characteristic of an LCD. The after-image will disappear after a few minutes.
Distorted image	Display format set incorrectly	Check that the correct display format is selected in the Setup menu.
Red, green, blue, or white dots on screen	Inherent LCD characteristics	This is characteristic of an LCD and will not cause a malfunction.

Troubleshooting

Symptom	Possible Cause	Resolution
"Wrong disc" displays upon disc insertion	Unreadable disc	Ensure disc is not scratched or dirty. Clean and re-insert as necessary.
	Disc format not supported	Ensure the disc has a format compatible with the player (see "Specifications" on page 35).

Note: Further troubleshooting information may be found on the Protron website at www.protronusa.com.

Support Information



Do not return this product to your retailer until you have performed the steps laid out in "Unpacking Your New DVD Player" on page 2 and contacted the customer service center. Merchandise may not be returned to Protron without a return form authorization.

Before contacting Protron customer service, please record the following information, which may be found on the bottom of your portable DVD player:

- Model Number
- Serial Number

The Protron customer service center may be contacted 24 hours a day, 7 days a week at the following number:

1-888-257-8899

Specifications

General

Dimensions	7.7" W × 1.7" H × 5.9" D 194mm (W) × 43mm (H) × 148mm (D)
Weight	3.3lbs
Playback Formats	DVD±RW, Audio CD, VCD, SVCD, MP3 CD, Kodak Picture CD, CD-ROM, CD-R/RW
Outputs	1 × composite video (1/8" TS) 1 × digital coaxial audio (1/8" TS) 1 × stereo audio (1/8" TRS) 1 × headphone (1/8" TRS)
DC Power Adapter	Input: AC100–240V, 50–60Hz Output: DC12V, 2A
Power Consumption	<25W
Storage Temperature	0 to 60°C
Operating Temperature	5 to 35°C

Display

Panel Type	Active Matrix TFT LCD
Screen Size	7" widescreen (16:9)
Resolution	480 × 234
Pixel Pitch	0.107mm (H) × 0.370mm (V)
Contrast Ratio	200:1
Brightness	250cd/m ²
Viewing Angle	Vertical: +60/–40° Horizontal: +/-60°
Response Time	Rise/Fall: 12ms/18ms

Audio/Video

Video Resolution	525 lines (NTSC) / 625 lines (PAL)
Video S/N Ratio	55dB
Audio Frequency Response	±3dB, 20Hz–20kHz
Audio Dynamic Range	>80dB
Audio Harmonic Distortion	<0.1%
Speakers	2 × 1W

Battery

Type	Li Ion
Capacity	3500mAH
Running Time	Approximately 2.5hrs
Charging Time	3–4hrs
Life	>300 cycles (80% capacity)



Limited Warranty

Protron warrants this product to be free from manufacturing defects in material and workmanship under normal use for the period listed at the bottom of this document.

How to obtain service:

- Call the Protron Customer Support line at 1-888-257-8899. If the issue cannot be resolved over the phone, a service tag number will be issued and the product must be returned to Protron, at your expense, for assessment and repair/replacement. To request warranty repair, you may also contact us by e-mail at service@protronusa.com. For all other customer service related inquiries, please email us at customerservice@protronusa.com.
- Proof of purchase in the form of a bill of sale or receipted invoice with product name, model and serial #, which provides evidence that the product is within the warranty period, must accompany the product to obtain warranty service.

This warranty does not cover:

- Physical or cosmetic damages.
- Damage caused by abuse and/ or neglect.
- Ordinary adjustments as outlined in the owners manual that can be performed by the customer.
- Damage to equipment not properly connected to the product.
- Any cost incurred in shipping the product for repair.
- Signal reception problems caused by external antenna, cable systems or interference.
- Incompatibility due to a change in TV/CATV broadcast systems after the product was sold.
- Batteries.
- Images burnt onto the screen.
- Initial installation and related adjustments.
- Power surge and/or damage by lightning.
- Force majeure or uncontrollable external force damage.
- Product shipped for service with inadequate packaging or packaging materials

Limited Warranty

What we will do:

- Protron will assess the product and cover all labor charges to repair your product.
- Protron will provide new, or at our discretion, refurbished replacement parts required to repair your product.

This warranty is void if:

- Product is used in a commercial application or rental.
- Damaged through misuse, negligence or abuse.
- Modified or repaired by anyone other than an authorized PROTRON service center.
- Damaged because it is improperly connected to any other equipment.
- If the original proof of purchase cannot be supplied.
- If the identifiable markings on the product such as Serial # are defaced, unrecognizable, or missing.
- The product is used outside the country in which it was originally sold.

This warranty is non-transferable and only applies to the original purchase. Any implied warranties, including the warranty of merchantability, are limited in duration to the period of this expressed warranty and no warranty whether expressed or implied shall apply to the product thereafter. Under no circumstance shall PROTRON be liable for any loss or consequential damage arising out of the use of this product. This warranty gives specific legal rights. However, you may have other rights that may vary from state/province to state/province. Some states/provinces do not allow limitations on implied warranties or exclusions of consequential damage. Therefore these restrictions may not apply to you.

90 days Labor and Parts

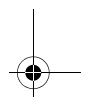
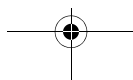
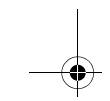
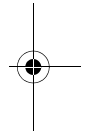
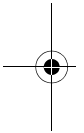
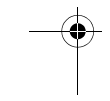

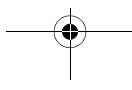
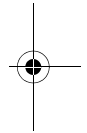
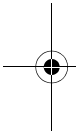

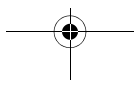
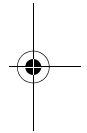
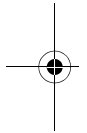

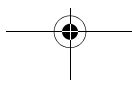
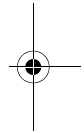
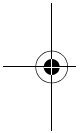

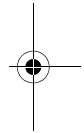
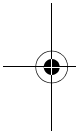

Protron Digital Corporation

<http://www.protronusa.com/>

PDV-70X

OMP DV70X

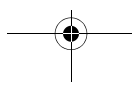

Free Manuals Download Website

<http://myh66.com>

<http://usermanuals.us>

<http://www.somanuals.com>

<http://www.4manuals.cc>

<http://www.manual-lib.com>

<http://www.404manual.com>

<http://www.luxmanual.com>

<http://aubethermostatmanual.com>

Golf course search by state

<http://golfingnear.com>

Email search by domain

<http://emailbydomain.com>

Auto manuals search

<http://auto.somanuals.com>

TV manuals search

<http://tv.somanuals.com>