KODAK EASYSHARE TOUCH Camera / M577



Extended user guide

www.kodak.com

Help: www.kodak.com/go/m577support

Tutorials: www.kodak.com/go/m577demos

Kodak

Eastman Kodak Company

Rochester, New York 14650

© Eastman Kodak Company, 2011

All screen images are simulated.

Kodak, EasyShare Touch, Ektachrome, Kodachrome, Kodacolor, Max, Perfect Touch, Pulse, T-Max, and Tri-X are trademarks of Eastman Kodak Company.

4H8644_en

Quick start

① Load the battery.



② Charge until the light stops blinking.



③ Set language, date/time.

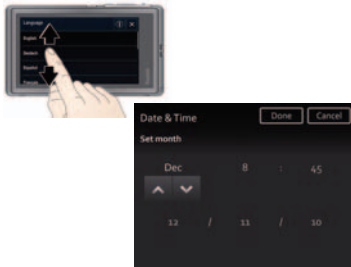

④ Take pictures, videos.



⑤ Install software, then share.



Keep learning!
Take and share your
best pictures, videos!



Front, top view

IR Receiver for optional remote control

Flash

AF Assist/
Self-timer/
Video light

Lens



Power

Power/Battery Charging light

Shutter button (for pictures)

Record Video

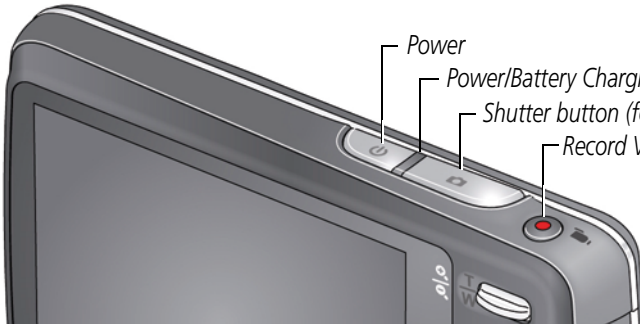

Side, bottom view

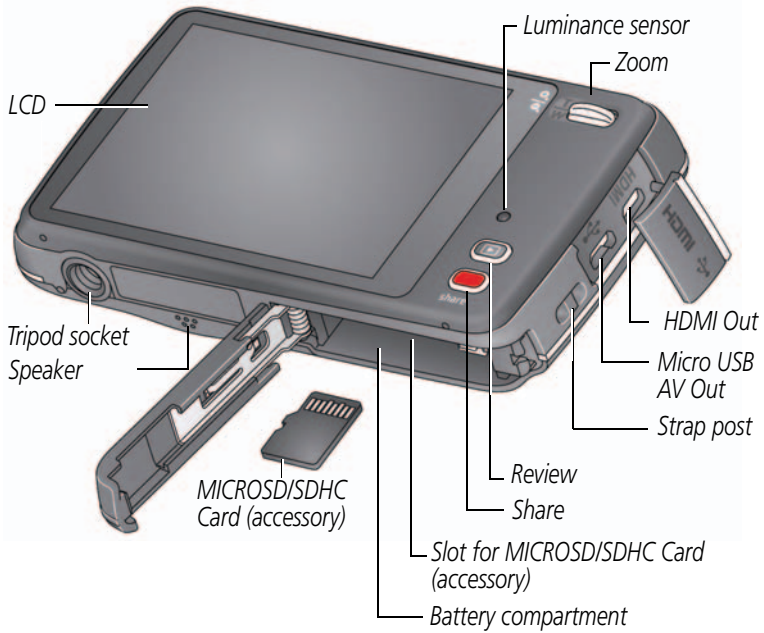

Touchscreen gestures

Tap
(or tap and hold)



Swipe
(Drag and quickly release)



Drag or scroll
(Pull down or push up)



Table of contents

1	Setting up your camera	1
	Attaching the strap	1
	Loading the KLIC-7006 battery	1
	Charging the battery	2
	Turning on the camera	5
	Setting the language, date/time	6
	Storing pictures on a MICROSD/SDHC Card	7
2	Taking pictures/videos	8
	Taking pictures in Smart Capture mode	8
	Your camera, the way you want it	11
	Using Tools to choose actions, preferences	12
	Understanding the picture-taking icons	13
	Watch the battery level	13
	Taking a video	14
	Using the zoom	15
	Using the flash	16
	Using different modes	17
	Using Film Effects	18
	Using Scene modes	19
	Using Program mode	20
	Taking self-timer pictures/videos	21
	Taking burst pictures	21
	Taking panoramic pictures	22
3	Reviewing and editing	23
	Reviewing pictures/videos	23
	Playing a video	25
	Deleting pictures/videos	25
	Viewing pictures/videos in different ways	26
	A smarter way to find and enjoy your pictures	27

Understanding the review icons.....	28
Cropping a picture	29
Using effects	30
Using decorative effects	30
Trimming a video	31
Adding a date stamp.....	32
Making a picture from a video.....	33
Making an action print from a video.....	34
Selecting multiple pictures/videos	35
Displaying pictures/videos on a television.....	36
Running a slide show	37
Using the optional remote control	38
4 Sharing pictures/videos	39
Sharing through email and social networks.....	39
Tagging pictures	42
Marking pictures/videos as favorites	45
5 Using the Settings menu	46
Changing settings	46
6 Install software	49
Install software, transfer pictures, and share	49
Printing pictures.....	50
Marking pictures for print.....	51
7 Troubleshooting	52
Getting help on the Web.....	56

8 Appendix	57
Specifications	57
Care and maintenance	59
Upgrading your software and firmware	59
Storage capacities	60
Important safety instructions	60
Battery replacement, battery life	61
Limited warranty	62
Regulatory compliance	63

1

Setting up your camera

Attaching the strap



Loading the KLIC-7006 battery

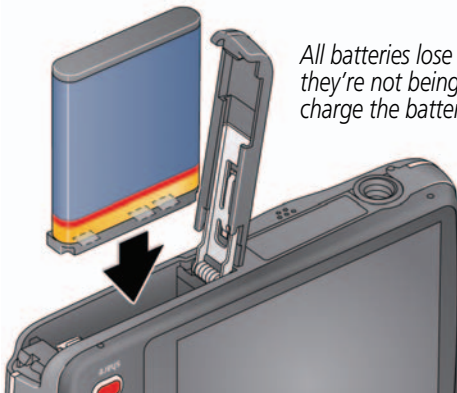

All batteries lose power over time—even if they're not being used. For longer life, fully charge the battery prior to use.

Charge the battery

[See page 2](#)

Purchase extra batteries

www.kodak.com/go/accessories

Watch the battery level

[See page 13](#)

Charging the battery

If your package included	Then see
An in-camera battery charger	Using the in-camera battery charger
An external battery charger	Using the external battery charger

Using the in-camera battery charger

You can charge the Li-ion battery whenever necessary.

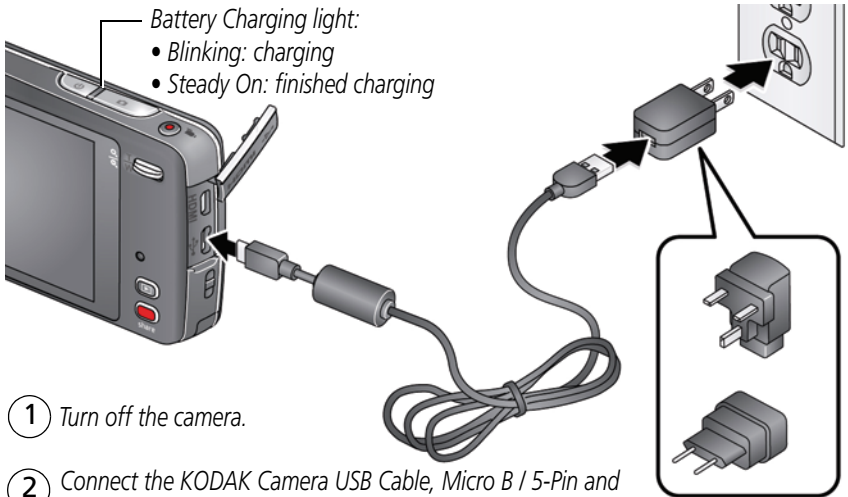

- 1 Turn off the camera.
- 2 Connect the KODAK Camera USB Cable, Micro B / 5-Pin and charger. (Use only the cable included with this camera.)

NOTE: You can use the camera while it's plugged in.

Watch the battery level [See page 13](#)

Purchase extra batteries www.kodak.com/go/accessories

Using the external battery charger

You can charge the Li-ion battery whenever necessary.

If you have this charger...

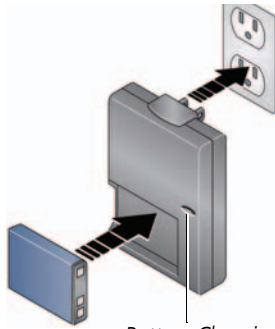
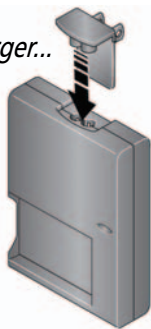

Battery Charging light:
• Orange: charging
• Green: finished charging

If you have this charger...

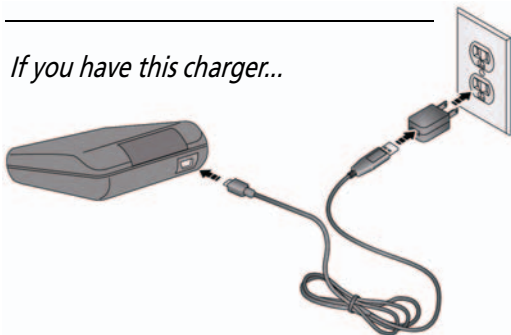

Battery Charging light:
• Flashing green: charging
• Steady On green: finished charging

Watch the battery level [See page 13](#)

Purchase extra batteries www.kodak.com/go/accessories

Charge via your computer's USB port

You can charge the Li-ion battery whenever necessary.

IMPORTANT: *The camera charges when the computer is on and awake. Turn off the computer's hibernation, sleep, and standby modes.*

- 1 Turn off the camera.
- 2 Connect the KODAK Camera USB Cable, Micro B / 5-Pin and charger. Use only the cable included with this camera.

Battery Charging light:

- *Blinking: charging*
- *Steady: finished charging*



Watch the battery level [See page 13](#)

Purchase extra batteries www.kodak.com/go/accessories

Turning on the camera



Setting the language, date/time

The first time you turn on the camera, you're prompted to choose your language and set the date/time.



Set the language:

- 1 Drag or swipe up/down to view your language. (For more information on using touchscreen gestures, [see page iv.](#))
- 2 Tap your language, then tap Done.

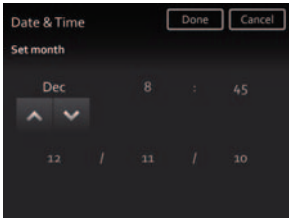

Set the date and time:

- 1 Tap the Month, Date, or Year that you want to change, then tap ▲▼ to change it. (Tap MDY to change the date format.)
- 2 Tap the Hour or Minutes, then tap ▲▼ to change it.
- 3 Tap Done.

NOTE: To change your language or date/time in the future, [see page 47.](#)

Storing pictures on a MICROSD/SDHC Card

Your camera has internal memory. We recommend purchasing a MICROSD/SDHC Card to conveniently store more pictures/videos.



CAUTION:

A card can only be inserted one way; forcing it may cause damage. Inserting or removing a card while the camera is on may damage the pictures, the card, or the camera.

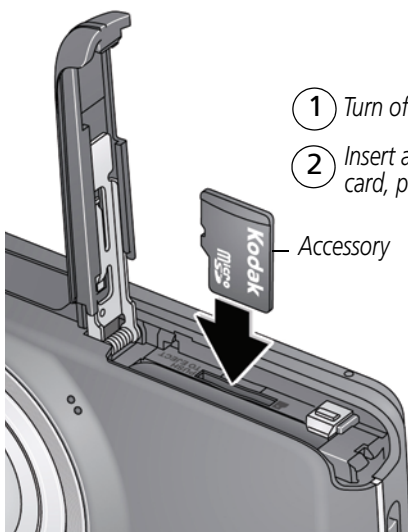

- ① Turn off the camera, then open the door.
- ② Insert a card until it clicks. To remove a card, press and release it.

IMPORTANT: When you turn on the camera, it checks to see if a card is inserted. If so, new pictures/videos are stored on the card. If no card is inserted, new pictures/videos are stored in the camera's internal memory. If pictures/videos are detected in internal memory and a card is inserted, the camera prompts you to move the pictures to the card (and erase those in internal memory).

Purchase cards www.kodak.com/go/accessories

2

Taking pictures/videos

Taking pictures in Smart Capture mode

When you turn on the camera the first time, it's ready to take pictures in Smart Capture mode . After that, it remembers the last mode you used. To choose a different mode ([page 17](#)), tap **MODE**. You can also take pictures using the Touch Shutter feature ([page 9](#)).

- 1 Use the LCD to compose the picture.
- 2 Press the Shutter button **halfway** to focus and set exposure. *Framing marks indicate the camera focus area. If the camera is not focusing on the desired subject, release the Shutter button and recompose the scene.*



- 3 Press the Shutter button **completely down**. The new picture is briefly displayed.
- IMPORTANT:** Press the Share button to share anytime. To learn more, see [page 39](#).

In Liveview



Most recent picture/video

In Quickview



In Review



Taking pictures using the Touch Shutter feature

For convenience, you can take pictures using the Touch Shutter feature. The camera focuses on the area you touch, then takes a picture.

NOTE: When the touch shutter is off, the icon shown is .

- 1 Tap Touch Shutter .

The LCD displays the Touch Shutter square.

- 2 Use the LCD to compose the picture.



— Touch Shutter square

- 3 To take a picture, tap the desired area of focus inside the Touch Shutter square.

The camera focuses on the area you touched and takes a picture. The camera stays in Touch Shutter mode until you turn it off. You can also use the Shutter button to take a picture.

NOTE: You can also use Touch Shutter in Self-timer and Burst modes, but not in Panorama.

Reviewing the picture/video just taken

After you take a picture/video, the LCD displays a quickview for several seconds. The picture/video is saved unless you tap Delete . (To dismiss the quickview and get back to taking pictures right away, press the Shutter button halfway.)

Review a picture



Play a video



To review pictures/videos anytime, see [page 23](#).

Your camera, the way you want it

Sometimes, you want to see everything available. (Other times, you want everything out of your way!) Tap anywhere on the LCD to change between Clean view and Tools view.

Clean view



*Tools view
(Tools vary by
camera mode.)*

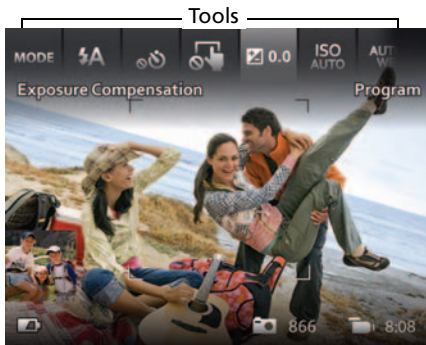

Using Tools to choose actions, preferences

In Liveview, tap a tool at the top of the LCD to adjust settings. Tap the most recent picture thumbnail to see it in Review.

or

Most recent picture

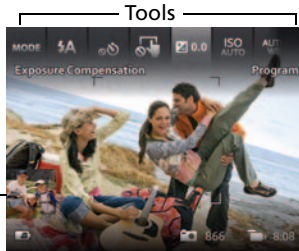

In Review, tap a tool or ◀▶ to see the previous or next picture/video.



NOTE: If you choose , you get a scrollable menu. Tap a setting to view and choose its options. (Some settings let you tap ◀▶ to change a setting.)

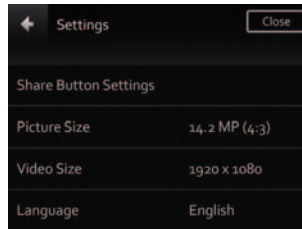



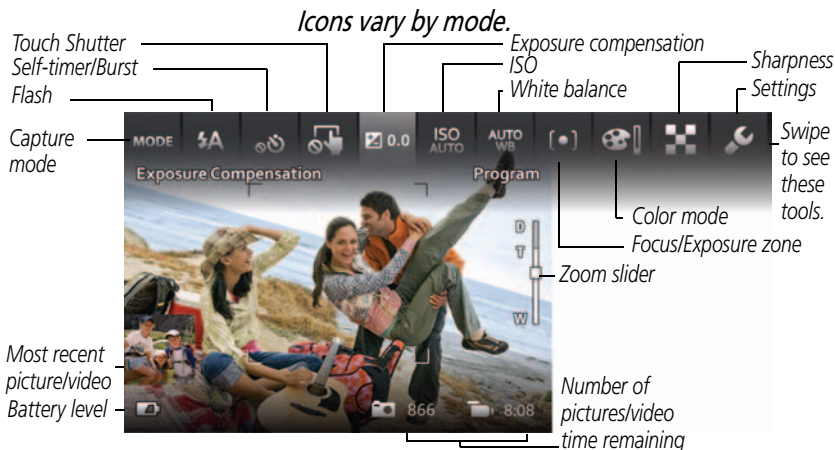

Understanding the picture-taking icons



Watch the battery level

Don't miss out on great pictures and videos—keep your battery fully charged.

Full	
Three quarters	
Half	
Critical	
AC Power	

Charge the battery

[See page 2](#)

Purchase extra batteries

www.kodak.com/go/accessories

Taking a video

The camera is always ready to take a video—just press the Video Record button!



- 1 Use the LCD to compose the video.
- 2 To start recording, press and release the Video Record button . To stop recording, press and release the button again.

The first frame of the new video and the play button are displayed for a few seconds.

- To play/pause the video, tap the Play button.
- If you don't like the video, tap Delete , then follow the prompts. (To delete a video later, [see page 25.](#))

Using the zoom

Use optical zoom to get closer to your subject before taking a picture or video. (If the zoom button is pressed during video recording, then digital zoom is used.)







- 1 Use the LCD to frame your subject. (For focus distances, see [Specifications, page 57.](#))
- 2 Press the zoom button toward Telephoto (T) to zoom in. Press toward Wide Angle (W) to zoom out.
- 3 Take the picture or video.

NOTE: To get a focused picture every time, use the framing marks ([page 8](#)).

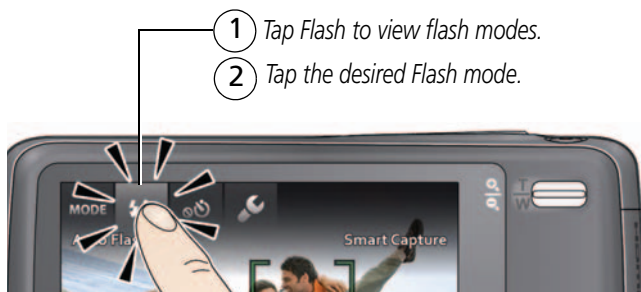
Using the flash

Use the flash when you take pictures at night, indoors, or outdoors in heavy shadows. Flash settings are limited in some capture modes.



Flash modes	The flash fires
Auto 	When the lighting conditions require it.
Fill 	Every time you take a picture, regardless of the lighting conditions. Use when the subject is in shadow or is "backlit" (when the light is behind the subject). In low light, hold the camera steady or use a tripod.
Red-eye Reduction 	A preflash fires, shrinking the eye pupil, before the picture is taken.
Off 	Never.

Using different modes

Tap **MODE**



Then tap the mode that suits your subject.

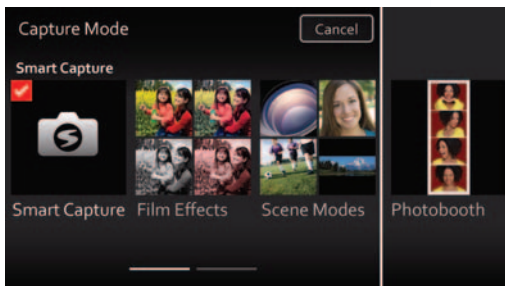

Capture mode

For



Smart Capture

General picture taking—it offers excellent image quality and ease of use.

- Faces are detected.
- The scene is analyzed for other content and for lighting. You can choose the best picture size and aspect ratio for your needs—tap Settings and choose Picture Size.

Film Effects

Film-like effects that make your pictures/videos more interesting (see [page 18](#)).

Scene Modes

Point-and-shoot simplicity when taking pictures under special conditions (see [page 19](#))—including Program mode (see [page 20](#)).

Photo Booth

Taking 4 pictures and combining them into single strip, like a vintage photo booth. For best results, place the camera on a tripod or steady surface.

Video

Video with sound. (See [page 14](#).)

Using Film Effects

Choose a film effect before taking a picture/video.

- 1 Tap **MODE**, then tap Film Effects.
- 2 Tap an effect to read its description and see an example.
- 3 Tap Apply to choose that effect.

Film Effect	For
KODACOLOR	Nostalgic color
EKTACHROME Vivid	Vibrant saturated color
KODACHROME 25 1970's	Bright natural color
T-MAX Art	Lustrous tone and fine grain
TRI-X Photojournalism	Dramatic contrast and grain
Sepia	Vintage reddish-brown tint

Using Scene modes

Choose a Scene mode before taking a picture.

- 1 Tap **MODE**, then tap Scene.
- 2 Tap a Scene mode to read its description.
- 3 Tap Apply to choose that Scene mode.

Scene mode	For
Program	More creative control than Smart Capture.
Portrait	Full-frame portraits of people.
Sport	Subjects that are in motion. Shutter speed is fast.
Landscape	Distant scenes.
Close-up	Close range. Use available light instead of flash, if possible.
Sunset	Subjects at dusk.
Backlight	Subjects that are in shadow or “backlit.”
Candle Light	Subjects illuminated by candle light.
Children	Action pictures of children in bright light.
Bright	Bright beach or snow scenes.
Fireworks	Fireworks. For best results, place the camera on a steady surface or tripod.
Self-Portrait	Close-ups of yourself. Assures proper focus and minimizes red eye.
Night Portrait	Reduces red eye of people in night scenes or low-light conditions.
Night Landscape	Distant scenery at night. Flash does not fire.
Blur Reduction	Reducing blur caused by camera shake or subject motion.
High ISO	People indoors, in low-light scenes.
Panorama	“Stitching” 2 or 3 pictures into 1 panoramic scene. (See page 22.)
Long Exposure	Imparting a sense of motion (0.5 Sec., 1.0 Sec., 2.0 Sec., 4.0 Sec., 8.0 sec.)

Using Program mode

The Program Scene mode gives access to the greatest number of settings.

- 1 Tap **MODE**, then tap Scene.
- 2 Tap Program, then tap Apply.

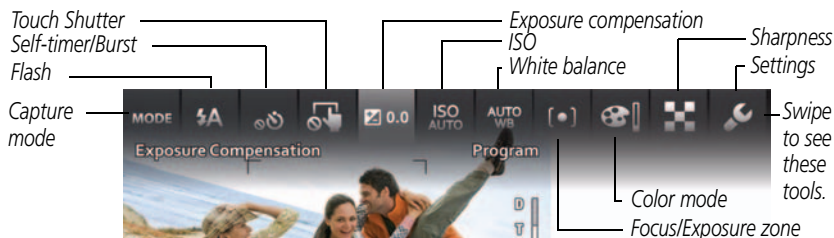

NOTE: Settings that you change in Program mode apply only to pictures taken in Program mode. Use Reset Camera (see page 47) to reset Program mode to its default settings.

Changing Program mode settings

In Program Scene mode, tap a setting. Then change its value.

Using exposure compensation to adjust brightness

In Program and Panorama modes, you can adjust exposure compensation before you take a picture to make your pictures darker or lighter. (Only the first picture in Panorama mode can be adjusted—that adjustment is applied to the remaining pictures.)

- 1 Tap Exposure Compensation to access the exposure compensation setting.
- 2 Drag the slide to increase or decrease exposure compensation.

The scene in the LCD gets lighter or darker.

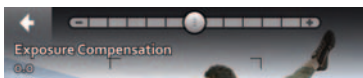

- 3 Take the picture when you are satisfied with the exposure compensation level.

www.kodak.com/go/support

Taking self-timer pictures/videos

Use the self-timer when you want to be included in a picture, or to ensure a steady Shutter button press. Place the camera on a tripod or flat surface.

NOTE: When the self-timer is off, the icon shown is .

1 Tap Self-timer/Burst , then tap a self-timer setting:

10 seconds— A picture is taken after a 10-second delay (so you have time to get into the scene).

2 seconds— A picture is taken after a 2-second delay (for a steady, shutter release).

2 shot— The first picture is taken after a 10-second delay. A second picture is taken 8 seconds later.

2 Compose the scene. Press the Shutter button **halfway**, then **completely down**.

The camera takes the picture/pictures after the delay. You can also use Touch Shutter in Self-timer mode (page 9).

Use the same procedure to take a 2- or 10-second self-timer video, but press the Shutter button **completely down**.

Taking burst pictures

In Burst mode, the camera takes up to 3 pictures while the Shutter button is pressed.

1 Tap Self-timer/Burst , then tap Burst .

2 Compose the scene. Press the Shutter button **halfway**, then **completely down**.

The camera stops taking pictures when you release the Shutter button, when the pictures are taken, or when there is no more storage space. You can also use Touch Shutter in Burst mode (page 9). Burst is unavailable in some modes.



Taking panoramic pictures

Use panorama to “stitch” up to 3 pictures into a panoramic scene.

NOTE: Individual pictures are not saved, even if panorama capture is cancelled before stitching occurs. (Exposure Compensation, White Balance, Focus/Exposure Zone, AF Control, Color Mode, and Sharpness are set with the first picture. The flash is set to Off.) You can use the self-timer (2- and 10-second delays) while taking panoramic pictures (see page 21). Touch Shutter is not available in Panorama mode.

1 Tap **MODE**, then tap Scene Modes.

2 Tap Panorama, then tap done.

You can take pictures from left to right. To take pictures from right to left, tap , then tap .

3 Take the first picture.

After a quickview, the LCD displays the Liveview and an “overlay” from the first picture.

4 Compose the second picture. Make the overlay from the first picture cover the same portion in the new picture.

5 If you are taking/stitching only 2 pictures, tap Stitch to stitch them together.

After you take 3 pictures, the pictures are automatically stitched together.

Take
2 or 3
pictures.



Get 1
panoramic
picture.



NOTE: To use the self-timer 10-second or 2-second setting, see page 21.

3

Reviewing and editing

Reviewing pictures/videos



- 1 Press the Review button  to enter Review.
- 2 Tap All, People, Date, Keywords, or Videos.

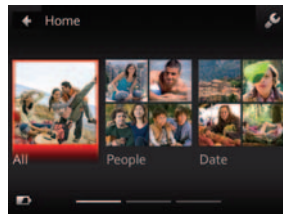

Swipe to access Keywords and Videos or tap the paging bar.

Paging bar

- 3 If you chose People, Date, or Keywords, tap a name, date, or keyword.

You can review the most recent picture/video by:

- Tapping the thumbnail (bottom left of LCD) in Liveview, or
- Pressing  during Quickview, while reviewing a new picture/video

IMPORTANT: Press the Share button to share anytime.



Other things you can do in Review

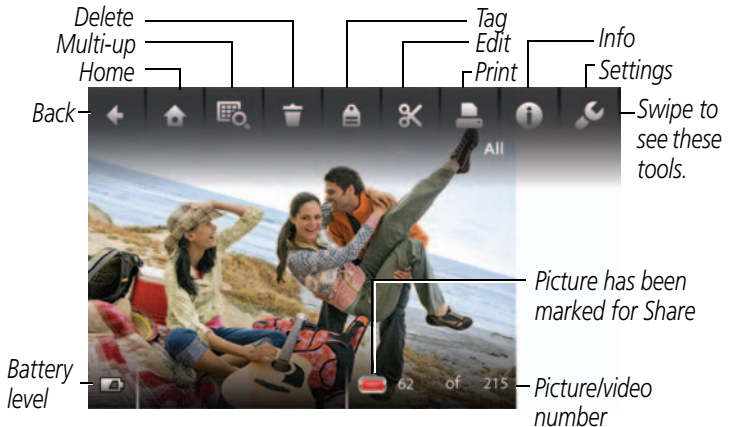

- *Swipe a picture ◀▶ to see the previous or next.
(Touch and hold the left/right side of the LCD to fast-forward or fast-reverse.)*
- *Tap Play to play videos.*
- *Tap  to delete pictures/videos.*





IMPORTANT: *Remember that you can take a video anytime!
Just press the Video Record button.*

Playing a video



- 1 Press the Review button .
- 2 Swipe the LCD right or left to find a video.
- 3 Tap Play  to play the video.
 - To pause/resume, tap Play or Pause. (While paused, tap the left/right side of the LCD for previous/next frame.)
 - To adjust the volume, tap Volume, then drag the slider. (If tools are hidden, tap anywhere on the LCD to show them.)
 - You can drag the timeline slider or tap the timeline bar.

Deleting pictures/videos

- 1 Press the Review button .
- 2 Swipe the LCD right or left to find a picture/video.
- 3 Tap Delete , then follow the screen prompts. (If tools are hidden, tap anywhere on the LCD to show them.)





To return to picture-taking mode, press the Shutter button halfway down.

Viewing pictures/videos in different ways

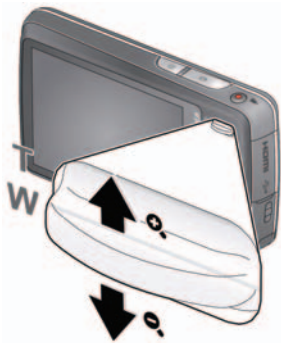
Magnifying a picture

You can magnify a picture while in review.



- 1 Press the Review button , then locate a picture.
- 2 Press the zoom button toward Telephoto (T) to magnify 2X–8X. Press toward Wide Angle (W) to zoom out.
- 3 Drag the picture     to view other parts of the picture.

Viewing as thumbnails

- 1 Press the Review button .
- 2 Tap All to view all pictures/videos, or tap Date, People, Keywords or Videos.

If you chose All, a single-up picture is shown. Go to the next step. (If you choose People, Date, Keywords, tap the desired person, date, or keyword to show thumbnails. If you choose Videos, thumbnails are displayed.)

- 3 Tap Multi-up .

Thumbnails are shown.

To select multiple pictures/videos, [see page 35](#).

To return to picture-taking mode, press the Shutter button halfway down.

A smarter way to find and enjoy your pictures

Tag pictures—by people or keywords—to make them easy to find, later. For example, the camera can find all pictures that contain “Mary” or “Nature.” (See [Tagging people](#), page 42 or [Tagging with keywords](#), page 44.)

- 1 Press the Review button .
- 2 Tap All to view all pictures/videos, or tap Date, People, Keywords or Videos.
If you chose All, a single-up picture is shown. (If you choose People, Date, Keywords, tap the desired person, date, or keyword. If you choose Videos, thumbnails are displayed.)

To return to picture-taking mode, press the Shutter button halfway down.

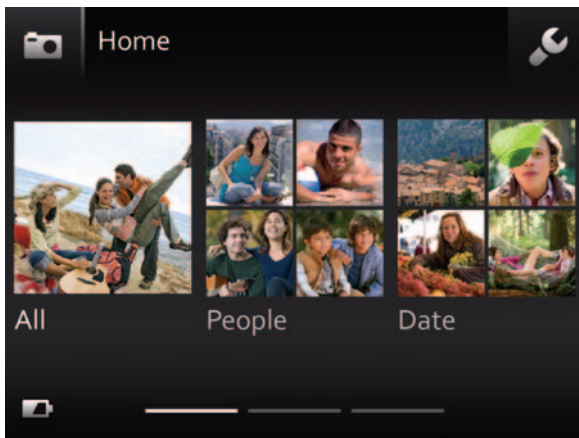

Swipe to access Keywords and Videos or tap the paging bar.

Tip: For best results, make sure the camera date/time is current ([see page 47](#)).

Understanding the review icons

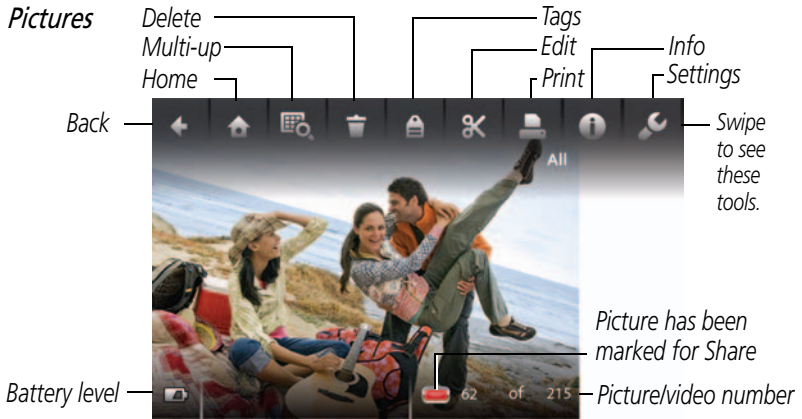



Videos



Cropping a picture

You can crop a picture so that only the desired portion of the picture remains.

- 1 Press the Review button .
- 2 Swipe the LCD right or left to find a picture.
- 3 Tap Edit , then tap Crop .
- 4 Drag the crop box to the desired portion of the picture. Drag a corner of the box to resize it.



Drag the box to position it.

Drag a corner to change its size.

- 5 Double-tap the crop box, then follow the screen prompts.

The picture is cropped and the original picture is saved. (Cropped pictures cannot be cropped again.)

To return to picture-taking mode, press the Shutter button halfway down.

Using effects

You can apply effects to pictures.







- 1 Press the Review button .
- 2 Swipe the LCD right or left to find a picture.
- 3 Tap Edit , then tap Effects .
- 4 Tap Photo Effects, then tap an effect:

Photo Effect	Steps and Result
Spot Color	Your picture begins as black and white. Tap a brush, then use your finger to "paint" (restore) color to an area of the picture. If necessary, use the Zoom button to magnify the picture. Use the hand tool to drag the picture.
Tint	Tap a color tint to apply to your entire picture.
Blur Background	Blur the background and make the foreground appear more prominent. Tap a brush, brush size, or blur tool, then "paint" the area to sharpen. Use the hand tool to drag the picture.

- 5 Follow the screen prompts to save the picture.

Using decorative effects





You can apply borders and captions to pictures.

- 1 Press the Review button .
- 2 Swipe the LCD right or left to find a picture.
- 3 Tap Edit , then tap Effects .
- 4 Tap Decorative Effects.
- 5 Tap Border or tap Caption.
- 6 Follow the prompts to choose a border style or a caption.
- 7 Follow the screen prompts to save the picture.

Trimming a video

You can remove the start or end from a video, saving only the desired portion.

NOTE: This feature is also available during video playback.

- 1 Press the Review button .
- 2 Tap Videos, then find the video you want to trim.
- 3 Tap Edit , then tap Trim .
- 4 Drag the Start trim mark  to choose the new start of the video.
Drag the End trim mark  to choose the new end of the video.





- 5 When satisfied, tap Done, then follow the prompts to Save as New, Cancel, or Replace Original.

To return to picture-taking mode, press the Shutter button halfway down.

Adding a date stamp

You can add a stamp—showing the date taken—to a picture.

NOTE: Once a date stamp is applied, it cannot be removed on the camera. A date stamp can also be applied in multi-select mode ([page 35](#)).



- 1 Press the Review button .
- 2 Tap All to view all pictures/videos, or tap Date, People, Keywords or Videos.
If you chose All, a single-up picture is shown. (If you choose People, Date, Keywords, tap the desired person, date, or keyword. If you choose Videos, thumbnails are displayed.)
- 3 Tap Edit , then tap Date Stamp.
The date/time is added to the picture.

To return to picture-taking mode, press the Shutter button halfway down.

Making a picture from a video

You can choose a single frame from a video, then make it into a picture. (Quality depends on video resolution.)

NOTE: This feature is also available during video playback.

- 1 Press the Review button .
- 2 Tap Videos, then find the video you want to trim.
- 3 Tap Edit .
- 4 Tap Make Picture .



- 5 Tap Play to play the video. When you reach the desired frame, tap Pause.
- 6 Tap Make Picture.



The picture is created. (The original video is saved.)

To return to picture-taking mode, press the Shutter button halfway down.

Making an action print from a video

From a video, you can make a 9-up picture. (Quality depends on video resolution.)

NOTE: This feature is also available during video playback.



- 1 Press the Review button .
- 2 Tap Videos, then find the video from which you want to make an action print.
- 3 Tap Edit .
- 4 Tap Action Print .

A 9-up picture is created.

To return to picture-taking mode, press the Shutter button halfway down.

Selecting multiple pictures/videos

Use the multi-select feature when you have two or more pictures to print, share, delete, protect/unprotect, tag with keyword, etc. Multi-select is only available in thumbnail view (see [page 26](#)).

- 1 Press the Review button .
- 2 Tap All to view all pictures/videos, or tap Date, People, Keywords or Videos.
If you choose All, a single-up picture is shown. Tap Multi-up  to view by thumbnails.
- 3 Tap Select Images, then tap the desired pictures/videos.

A check mark appears. You can tap a second time to remove a check mark. You can now apply a command to multiple pictures/videos.



NOTE: You can also share multiple pictures/videos using the Share button (see [page 39](#)).

Displaying pictures/videos on a television

You can display pictures/videos on a television, computer monitor, or any device equipped with a composite video input. If you have an HD television, use an HDMI cable—and get the richest playback experience.

HDMI Cable



AV Cable

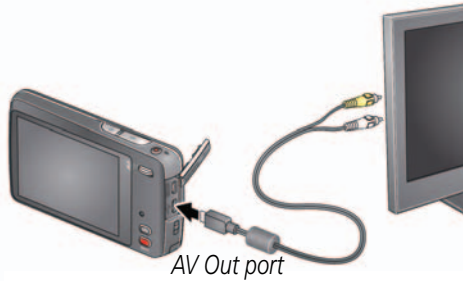

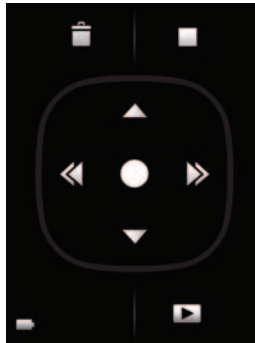

Use the camera controls to navigate through pictures/videos on the television.



Purchase cables www.kodak.com/go/accessories

Running a slide show

Use Slide Show to display your pictures/videos on the LCD. You can play all pictures/videos, or select pictures to include in the slide show.

- 1 Press the Review button .
- 2 To play all pictures/videos, choose All. Then tap Slide Show.
To play pictures or videos that you select:
 - a Tap People, Date, Keywords, or Videos.
 - b Tap Select Images, then tap the containers that hold the desired pictures/videos.
- 3 Tap Slide Show .

Each picture/video is displayed once. To interrupt the slide show, tap the LCD.

Using the optional remote control

Use the optional remote control to start/stop recording and to review videos and pictures. Go to www.kodak.com/go/accessories.

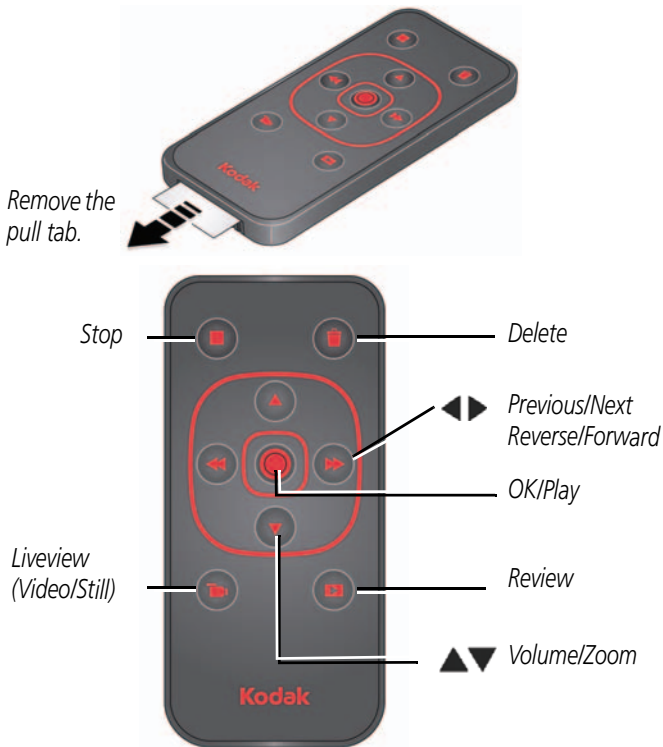

4

Sharing pictures/videos

Sharing through email and social networks

It's never been easier to share pictures on your favorite social networking sites.

IMPORTANT: *To use the sharing and social networking features, you must install the KODAK Share Button App (page 49).*

As new sites become available, they'll be offered when you connect the camera to a networked computer.

Press the Share button anytime

In Liveview



In Quickview



In Review

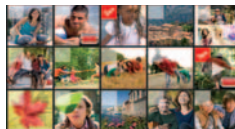

Most recent picture/video



Using the Simple Share feature

Use the Simple Share feature for basic sharing.



1 In Liveview: Press the Share button. Tap Select Images, then tap the pictures/videos you want to share. (To share only the most recent picture/video, tap the thumbnail in the bottom left corner of the LCD.)

In Quickview: During a Quickview, press the Share button. Then go to Step 3.

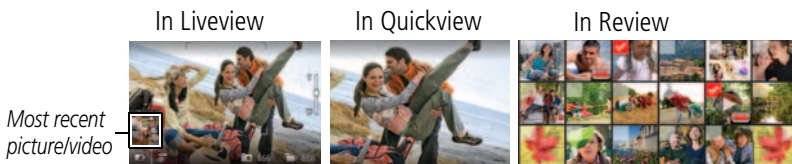
In Review: Find a picture/video. (To share more than one, tap Multi-up  to view thumbnails. Tap Select Images, then tap the pictures/videos to share.)



2 Press the Share button.

3 Tap desired social networking sites or email addresses. (Tap again to remove a check mark. Drag   to scroll through the list.)

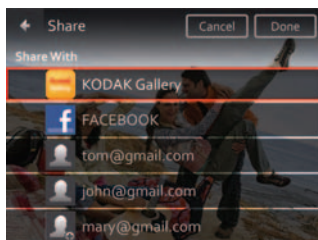

4 Tap Done.

When you transfer these pictures/videos to your computer, they are sent to the sharing destinations you chose.

Choose which social networking sites to display on your camera

You can show/hide networking sites on your camera so that only your favorite sites appear.

- 1 Tap Settings .
- 2 Tap Share Button Settings.
- 3 Tap to check/uncheck each social networking site, then tap Done.

When you are in Review and press the Share button, your chosen sites appear.

To return to picture-taking mode, press the Shutter button halfway down.

Manage email addresses and KODAK PULSE Digital Frames

You can add, edit, or delete email addresses and KODAK PULSE Digital Frames on your camera. (To use the keyboard, see [page 44.](#))

- 1 Press the Share button.
- 2 Tap Manage Email Addresses or Manage Picture Frames, then.
- 3 Tap a choice to add, delete, or edit an email address or frame.

The keyboard appears when you need to type. See [page 44.](#)

- 4 Tap Done or Next, then tap OK.

To return to picture-taking mode, press the Shutter button halfway down.



Tagging pictures

Tag pictures to make them easy to find, later. You can tag pictures in 2 ways:

- **People**, and then find all pictures of “Mary.”
- **Keywords**, and then find all pictures from “Nature.”



Tagging people

When you tag faces, you’re helping your camera to recognize people by name. Then it matches names and faces in pictures you’ve taken—and those you take in the future!

- 1 Press the Review button .
- 2 Tap All to view all pictures, or tap Date, People, Keywords.
If you chose All, a single-up picture is shown. (If you chose People, Date, Keywords, tap the desired person, date, or keyword. If you chose Videos, thumbnails are displayed.)
- 3 Tap the LCD to display the tools.
- 4 Tap Tags .
- 5 Tap Tag People.
- 6 Tap an existing name or tap Enter New Name to add a new one (see [page 44](#)), then tap OK.

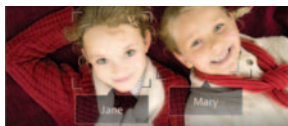
If more than one face is detected, a name or question mark is assigned to each detected face. To resolve an incorrect name or a question mark, tap a face, then tap a name or tap Enter New Name.



- 7 If prompted to Update People Tags, tap Yes.
Other pictures are scanned and updated with the name(s) you applied here. Tap   to add names to other pictures. Tap Done.

Manually add a face tag

If a face is not detected, you can identify and name it.

- 1 Press the Review button .
- 2 Swipe the LCD right or left to find the desired picture.
- 3 Tap Tags.
- 4 Tap Tag People.

If no faces were detected, the Manual Tag menu appears. (If faces were detected, tap Manual Tag.)

- 5 Follow the prompts to enter a new name, or choose one from the list. (The keyboard appears when you need to type. [See page 44.](#))
- 6 When finished typing, tap Done.

Need to update a name?

If you meet a new friend—James—but you already have pictures tagged with your old friend, James, you can:

- Tag the new James with “James Smith” and/or
- Update the old James to “James Monroe”

Here’s how:

- 1 Tap Settings .
- 2 Tap People Tag Settings (or Keyword Tag for videos).
- 3 Tap Modify Names List.
- 4 Tap the name you want to modify. (The keyboard appears when you need to type. [See page 44.](#))
- 5 Edit the name, then tap OK. (If prompted to Update People Tags, tap Yes.)

NOTE: You can have up to 20 names.

Tagging with keywords

Tag pictures to make them easy to find, later.

- 1 Press the Review button .
- 2 Tap All to view all pictures, or tap Date, People, Keywords.

If you chose All, a single-up picture is shown. (If you chose People, Date, Keywords, tap the desired person, date, or keyword. If you chose Videos, thumbnails are displayed.)

- 3 Tap the LCD to display tools.
- 4 Tap Tags .
- 5 Tap Keyword Tag.
- 6 Tap a tag (or tap "+" to add a new keyword).
- 7 Tap Done.



Using the keyboard

The keyboard appears when you need to type.

- 1 Tap letters.
- 2 When finished, tap Done.

Marking pictures/videos as favorites

Mark pictures as favorites to make them easy to find, later.

- 1 Press the Review button .
- 2 Tap All to view all pictures, or tap Date, People, Keywords.
If you chose All, a single-up picture is shown. (If you chose People, Date, Keywords, tap the desired person, date, or keyword. If you chose Videos, thumbnails are displayed.)
- 3 Tap the LCD to display tools.
- 4 Tap Tags .
- 5 Tap Keyword Tag.
- 6 Tap Favorite.
- 7 Tap Done.

5

Using the Settings menu

Changing settings

You can change settings to get the best results from your camera.



NOTE: Some modes offer limited settings. Some settings remain until you change them; others, until you change modes or turn off the camera.

1 In Liveview or Review mode, tap the LCD to display tools.

2 Tap Settings .

The Settings list appears. Drag   to scroll through the list.

3 Tap a setting, then choose an option within that setting.

NOTE: Some settings let you press   to change a setting.

4 Tap Done.

Setting	Options
Share Button Settings Choose what is displayed when the Share button is pressed.	Show or hide: <ul style="list-style-type: none">■ Individual social networking sites■ E-mail addresses (all or none)■ KODAK PULSE Digital Frames (all or none)
People Tag Settings Maintain names and faces.	Update People Tags —Matches recently tagged people with other pictures that may include these people. Modify Names List —Edit or delete existing names.
Picture or Video Size Choose a picture or video resolution.	See Specifications, starting on page 57 .

Setting	Options
Slide Show Settings Set your slide show preferences.	Transitions —Choose how one slide transitions to the next. Loop —Repeat a slide show until you stop it. Intervals —Choose the duration of each slide.
AF Control (Still) Choose an auto-focus setting.	Continuous AF —Because the camera is always focusing, there is no need to press the Shutter button halfway down to focus. Single AF —Focuses when the Shutter button is pressed halfway down. (This setting uses less battery power.)
LCD Brightness Choose LCD brightness during picture/video capture. (During Review, the LCD is set to High Power.)	High Power —Brighter LCD; uses more battery power. Power Save —Dimmer LCD; uses less power. Auto —LCD brightness is automatically adjusted according to environment.
Camera Sounds Choose volume.	High Medium Low Mute
Date & Time	Set date and time.
Language	Choose your language.
Reset All Camera Settings	Reset settings to their default.
Computer Connection Choose which application is downloaded or launched when you connect the camera to the computer.	KODAK Software Other Application (APPLE IPHOTO, etc.) IMPORTANT: <i>To use the social networking features, you must install the KODAK Share Button App (see page 49).</i>
Safe Mode In Safe mode, pictures/videos cannot be deleted or modified.	On —Pictures/videos cannot be deleted or modified. Off —Pictures/videos can be deleted and modified.

Setting	Options
Video Out Choose the regional setting that lets you connect the camera to a television or other external device.	NTSC —Used in North America and Japan; most common format. PAL —Used in Europe and China.
Format  CAUTION: Formatting deletes all pictures/videos, including those that are protected. Removing a card during formatting may damage the card.	Memory Card —Deletes everything on the card; formats the card. Cancel —Exits without making a change. Internal Memory —Deletes everything in internal memory including email addresses and keyword tags; formats the internal memory.
About	View camera information.

6

Install software

Install software, transfer pictures, and share

IMPORTANT: To use the sharing and social networking features, you must install the KODAK Share Button app.

Make sure the computer is connected to the Internet. When you connect the camera to the computer, the KODAK Camera Setup App automatically runs. Follow the prompts to install the KODAK Share Button App.



- 1 Turn off the camera.
- 2 Use the KODAK Camera USB Cable, Micro B / 5-Pin to connect the camera to the computer. Use only the cable included with this camera.
- 3 Turn on the camera.
- 4 After the software is installed, follow the prompts to transfer pictures and videos to your computer.

IMPORTANT: If the installer does not run, choose and install the right version for your computer: www.kodak.com/go/camerasw.

NOTE: You can also use a card reader to transfer pictures/videos.

Download KODAK Software later	www.kodak.com/go/camerasw
Get Software help	www.kodak.com/go/support
See How-To videos	www.kodak.com/go/m577demos

Printing pictures

Direct printing with a KODAK All-in-One Printer

IMPORTANT: *To print using PICTBRIDGE Technology, you must change the Computer Connection setting (in the Settings menu) to Other Application (see page 47).*

You need a camera, a PICTBRIDGE enabled Printer, and a USB cable.

Connecting the camera to a KODAK All-in-One Printer

- 1 Turn off the camera and printer.
- 2 Use the KODAK Camera USB Cable, Micro B / 5-Pin (included with the camera) to connect the camera to the printer.

Printing from a KODAK All-in-One Printer

- 1 Turn on the printer. Turn on the camera.

The PictBridge logo is displayed, followed by the current picture and menu. (If no pictures are found, a message is displayed.) If the menu turns off, press any button to redisplay it.

- 2 Tap a printing option.

Current Picture—Tap ◀▶ to choose a picture.

Tagged Pictures—If your printer is capable, print pictures that you marked for printing.

Index Print—Print thumbnails of all pictures. (This option requires one or more sheets of paper.)

All Pictures—Print all pictures in internal memory or on a card.

NOTE: During direct printing, pictures are not permanently transferred or saved to the printer. To transfer pictures to your computer, see page 49.

Purchase cables, accessories www.kodak.com/go/accessories

Ordering prints online



KODAK Gallery (www.kodakgallery.com) makes it easy to:

- Upload your pictures.
- Edit, enhance, and add borders to your pictures.
- Store pictures, and share them with family and friends.
- Have prints, photo greeting cards, frames, and albums delivered to your door.

Printing from an optional MICROSD/SDHC Card

- Automatically print tagged pictures when you insert your card into a printer. See your printer user's guide for details.
- Make prints at a KODAK Picture Kiosk. Go to www.kodak.com/go/picturemaker.
- Take the card to your local photo retailer for professional printing.

Marking pictures for print

- 1 Press the Review button .
- 2 Tap All to view all pictures, or tap Date, People, Keywords.
If you chose All, a single-up picture is shown. (If you chose People, Date, Keywords, tap the desired person, date, or keyword. If you chose Videos, thumbnails are displayed.)
- 3 Tap the LCD to display tools.
- 4 Tap Print.
- 5 Tap   to choose the number of copies, then tap OK.

The pictures are printed when you transfer them to your computer.;

7

Troubleshooting

Camera problems

Status	Solution
Camera does not turn on, off; buttons do not function	<ul style="list-style-type: none">■ Remove then reinsert or replace the battery (see page 1).■ Charge the rechargeable battery (see page 2).
Camera freezes up when a card is inserted or removed.	<ul style="list-style-type: none">■ Turn the camera off, then back on. Make sure the camera is turned off before inserting or removing a card.
LCD is too dark.	<ul style="list-style-type: none">■ Adjust the LCD Brightness setting (see page 47).
In Review, a blue or black screen is displayed instead of a picture	<ul style="list-style-type: none">■ Transfer the picture to the computer (see page 49), then format the card or internal memory.■ Take another picture.
In Review, you do not see a picture (or the expected picture) on the LCD	<ul style="list-style-type: none">■ Format the card in the camera (see page 48) Caution: Formatting a card deletes all pictures and videos, including protected files.
Pictures remaining number does not decrease after taking a picture	<ul style="list-style-type: none">■ Continue taking pictures. The camera is operating normally. (The camera estimates the number of pictures remaining after each picture is taken, based on picture size and content.)
Camera displays a High Temperature error	<ul style="list-style-type: none">■ If camera temperature rises to a certain level, a high temperature error (Video recording will stop in 5 seconds) appears. Turn the camera off as soon as possible and let it cool down. The camera cannot capture more videos until it has cooled down. (Captured videos are not lost.)

Status	Solution
Flash does not fire	<ul style="list-style-type: none">■ Check the flash setting, and change as needed (see page 16). NOTE: The flash does not fire in all modes.
Memory card is almost or entirely full	<ul style="list-style-type: none">■ Transfer the pictures to the computer (see page 49).■ Delete pictures from the card (see page 25) or insert a new card.
The Reset Camera feature did not take effect.	<ul style="list-style-type: none">■ After using the Reset Camera feature (see page 47), turn the camera off and then on again.
Battery life is short	<ul style="list-style-type: none">■ Make sure the correct battery type is installed (see page 61).■ Charge the battery (see page 2).■ Use a power-saving LCD Brightness setting (see page 47).
Shutter button does not work.	<ul style="list-style-type: none">■ Turn on the camera (see page 5).■ Transfer pictures to the computer (see page 49), delete pictures from the camera (see page 25), or insert a card with available memory (see page 7).
Memory card not recognized or camera freezes with card	<ul style="list-style-type: none">■ Card may be corrupted. Format the card in the camera (see page 48). Caution: Formatting a card deletes all pictures and videos, including protected files.■ Use another memory card. Only MICROSD/SDHC Cards are supported.
Pictures on card (or in internal memory) are corrupted	<ul style="list-style-type: none">■ Retake pictures.■ Do not remove card while the camera is on.■ Keep the rechargeable battery charged.■ Transfer pictures to the computer (see page 49), then format the card or internal memory (see page 48). Caution: Formatting a card deletes all pictures and videos, including protected files.

Computer/connectivity problems

Status	Solution
The software installer does not start	<ul style="list-style-type: none"> Choose and install the right version for your computer at www.kodak.com/go/camerasw.
Slide Show does not run on an external video device	<ul style="list-style-type: none"> Adjust the camera Video Out setting to NTSC or PAL (see page 48). Make sure the external device settings are correct. (See the device's user guide.)
Computer does not communicate with the camera	<ul style="list-style-type: none"> Turn off the camera, then turn it back on. Make sure the battery is charged and installed correctly (see page 1). Make sure the KODAK Camera USB Cable, U-8 is connected to the camera and the computer (see page 49). Then turn on the camera. See KODAK Software Help at www.kodak.com/go/camerasw.

Picture quality problems

Status	Solution
Picture is not clear	<ul style="list-style-type: none"> To automatically set exposure and focus, press the Shutter button halfway. When the framing marks turn green, press the Shutter button completely down to take the picture. Clean the lens (see page 59). Place the camera on a flat, steady surface or use a tripod (especially in high-zoom settings or in low light). Use a larger picture size (see page 46). If you're manually adjusting the ISO speed, realize that high ISO setting may cause grainy pictures.

Status	Solution
Picture is too dark	<ul style="list-style-type: none">■ Reposition the camera for more available light.■ Use Fill flash (see page 16) or change your position so light is not behind the subject.■ Move so that the distance between you and the subject is within the effective flash range. (See Specifications, starting on page 57.)■ To automatically set exposure and focus, press the Shutter button halfway. When the framing marks turn green, press the Shutter button completely down to take the picture.■ In Program mode, adjust the Exposure Compensation (see page 20).
Picture is too light	<ul style="list-style-type: none">■ Reposition the camera to reduce the amount of available light.■ Turn the flash off (see page 16).■ Move so that the distance between you and the subject is within the effective flash range. (See Specifications, starting on page 57.)■ To automatically set exposure and focus, press the Shutter button halfway. When the framing marks turn green, press the Shutter button completely down to take the picture.■ In Program mode, adjust the Exposure Compensation (see page 20).
Pictures that have KODAK PERFECT TOUCH Technology applied (twice) are of lower image quality.	<ul style="list-style-type: none">■ If PERFECT TOUCH Technology has been applied to a picture on the camera, do not apply it again when the picture is on the computer (or on a KODAK Picture Kiosk). <p>NOTE: PERFECT TOUCH Technology is automatically applied to Pictures taken in Smart Capture mode.</p>

Direct printing (PICTBRIDGE enabled printer) problems

Status	Solution
Cannot find the desired picture	<ul style="list-style-type: none">■ Use the Direct printing menu to change the image storage location.
The Direct printing menu interface turns off	<ul style="list-style-type: none">■ Press any camera button to redisplay the menu.

Status	Solution
Cannot print pictures	<ul style="list-style-type: none"> ■ Make sure there is a connection between the camera and the printer (see page 50). ■ Make sure the printer and the camera have power.
Camera or printer displays an error message	<ul style="list-style-type: none"> ■ Follow the prompts to resolve the issue.

Getting help on the Web

Get support for your product (FAQs, troubleshooting information, etc.)	www.kodak.com/go/m577support
Purchase camera accessories	www.kodak.com/go/accessories
Download the latest camera firmware	www.kodak.com/go/m577downloads
Download the latest software	www.kodak.com/go/camerasw
Register your camera	www.kodak.com/go/register
Chat, email, write, or phone Kodak (Chat not available in all languages)	www.kodak.com/go/contact

Specifications

CCD—1/2.3-type

Effective pixels—14 MP (4320 x 3240)

LCD—3.0 in. (7.6 cm) LCD; 460K dots; 30 fps; 4:3 aspect ratio

Image storage—Optional MICROSD/SDHC Card  (The SD logo is a trademark of the SD Card Association.) Maximum supported card size: 32 GB

Internal storage capacity—64 MB internal memory (10.9 MB available for image storage. 1 MB equals one million bytes.)

Taking lens—5X optical zoom; f/3.9–f/5.7; 35 mm equivalent: 28–140 mm

Digital zoom—5X continuous

Focus system—TTL-AF (through-the-lens auto focus); Multi-Zone, Center-Zone, Face Priority. Working range:

0.5 m (1.6 ft)—infinity @ wide, normal

1.5 m (4.9 ft)—infinity @ telephoto, normal

0.05–.8 m (0.2–2.6 ft) @ wide, Macro mode

1.0–1.8 m (3.3–5.9 ft) @ telephoto, Macro mode

Auto focus control—Continuous and Single AF

Face detection—Yes

Face recognition—Yes

Shutter speed—1/8–1/1600 seconds

Long time exposure—1/2–8 seconds

ISO speed—80, 100, 200, 400, 800, 1600

Focus/Exposure Zone—TTL-AE; Face Priority, Multi-Zone, Center-Zone

Exposure compensation—+/-2.0 EV with 1/3 EV step

White Balance—Auto, Daylight, Tungsten, Fluorescent, Open Shade

Electronic Flash—Auto flash; Auto, Fill, Red Eye, Off; Guide No. 6.4 (m) @ ISO 100; working range in Smart Capture mode: 0.5–3.2 m (1.6–10.5 ft) @ wide; 1.0–2.2 m (3.3–7.2 ft) @ telephoto

Self-timer mode—2 seconds, 10 seconds, 2 picture timer

Burst modes—See [page 21](#)

Capture modes—Smart Capture, Scene modes, Film Effects, Photo Booth, Video (see [page 17](#))

Image file format—

Still: EXIF 2.3 (JPEG compression); file organization DCF

Video: MP4, CODEC H.264

Picture size—14 MP (4:3): 4288 x 3216 pixels

12 MP (3:2): 4288 x 2848 pixels

10 MP (16:9): 4288 x 2416 pixels

6 MP (4:3): 2880 x 2160 pixels

3 MP (4:3): 2048 x 1536 pixels

Video size—HDV (1280 x 720) @ 30 fps

VGA (640 x 480) @ 30 fps

Recording limit —HDV: < 4GB or < 29 mins

VGA: < 4GB

Color modes—Vivid Color, Full Color, Basic Color, Black & White, Sepia

Film effects—None, KODACOLOR, KODACHROME, EKTACHROME, T-MAX, TRI-X, Sepia

Sharpness modes—Sharp, Normal, Soft

Communication with computer—USB 2.0 high speed (PIMA 15740 protocol); via KODAK Camera USB Cable, Micro B / 5-Pin; HDMI, type D (for television)

Microphone—Mono

Speaker—Mono

PICTBRIDGE support—Yes

Power—KODAK Li-ion Rechargeable Digital Camera Battery KLIC-7006; 5V AC-to-USB battery charging; USB charging via computer

Tripod mount—1/4 inch

Size— 99.8 x 57.4 x 20.1 mm (3.9 x 2.3 x 0.8 in.) @ power off

Weight—150 g (5.3 oz) with battery and card

Operating temperature—0–40° C (32–104° F)

Care and maintenance

- If you suspect water has gotten inside the camera, remove the battery and card. Allow all components to air-dry for at least 24 hours before using the camera.
- Blow gently on the lens or LCD to remove dust and dirt. Wipe gently with a soft, lint-free cloth or an untreated lens-cleaning tissue. Do not use cleaning solutions unless designed specifically for camera lenses. Do not allow chemicals, such as suntan lotion, to contact painted surfaces.
- Service agreements may be available in your country. Contact a dealer of KODAK Products for more information.
- For digital camera disposal or recycling information, contact your local authorities. In the US, go to the Electronics Industry Alliance site at www.eiae.org or go to www.kodak.com/go/support.

Upgrading your software and firmware

We occasionally update KODAK Software and firmware (the software that runs on the camera). For instructions on installing the latest version, go to www.kodak.com/go/m577downloads.

Storage capacities

The LCD displays the approximate number of pictures (or minutes/seconds of video) remaining. Actual storage capacity varies depending on subject composition, card size, and other factors. You may be able to store more or fewer pictures and videos.

Important safety instructions



CAUTION:

Do not disassemble this product; there are no user-serviceable parts inside. Refer servicing to qualified service personnel. KODAK AC Adapters and Battery Chargers are intended for indoor use only. The use of controls, adjustments, or procedures other than those specified herein may result in exposure to shock and/or electrical or mechanical hazards. If the LCD breaks, do not touch the glass or liquid. Contact Kodak customer support.

- The use of an accessory that is not recommended by Kodak may cause fire, electric shock, or injury. For approved accessories, go to www.kodak/go/accessories.
- Use only a USB-certified computer equipped with a current-limiting motherboard. Contact your computer manufacturer if you have questions.
- If using this product in an airplane, observe all instructions of the airline.
- When removing the battery, allow it to cool; it may be hot.
- Follow all warnings and instructions supplied by the battery manufacturer.
- Use only batteries approved for this product to avoid risk of explosion.
- Keep batteries out of the reach of children.
- Do not allow batteries to touch metal objects, including coins. Otherwise, a battery may short circuit, discharge energy, become hot, or leak.
- Do not disassemble, install backward, or expose batteries to liquid, moisture, fire, or extreme temperature.

- Remove the battery when the product is stored for an extended period of time. In the unlikely event that battery fluid leaks inside the product, contact Kodak customer support.
- In the unlikely event that battery fluid leaks onto your skin, wash immediately with water and contact your local health provider. For additional health-related information, contact your local Kodak customer support.
- Go to www.kodak.com/go/reach for information about the presence of substances included on the candidate list according to article 59(1) of Regulation (EC) No. 1907/2006 (REACH).
- Dispose of batteries according to local and national regulations. Go to www.kodak.com/go/kes.
- Do not charge non-rechargeable batteries. For more information on batteries, go to www.kodak.com/go/batterychart.

Battery replacement, battery life

KODAK Li-ion Rechargeable Digital Camera Battery KLIC-7006: 200 pictures per charge. Battery life per CIPA testing method. (Approximate number of pictures in Smart Capture mode, using a MICROSD Card.) Actual life may vary based on usage.

Extending battery life

- Use a power-saving LCD Brightness setting ([see page 47](#)).
- Dirt on the battery contacts can affect battery life. Wipe the contacts with a pencil eraser before loading the battery in the camera.
- Battery performance is reduced at temperatures below 41° F (5° C). When using your camera in cold weather, carry spare batteries and keep them warm. Do not discard cold batteries that do not work; when they return to room temperature, they may be usable.

Limited warranty

Kodak warrants its digital cameras and accessories (excluding batteries) to be free from malfunctions and defects in both materials and workmanship for the warranty period specified on your KODAK Product packaging. Retain the original dated sales receipt. Proof of purchase date is required with any request for warranty repair.

Limited warranty coverage

Warranty service is only available from within the country where the Products were originally purchased. You may be required to ship Products, at your expense, to the authorized service facility for the country where the Products were purchased. Kodak will repair or replace Products if they fail to function properly during the warranty period, subject to any conditions and/or limitations stated herein. Warranty service will include all labor as well as any necessary adjustments and/or replacement parts. If Kodak is unable to repair or replace a Product, Kodak will, at its option, refund the purchase price paid for the Product provided the Product has been returned to Kodak along with proof of the purchase price paid. Repair, replacement, or refund of the purchase price are the sole remedies under the warranty. If replacement parts are used in making repairs, those parts may be remanufactured, or may contain remanufactured materials. If it is necessary to replace the entire Product, it may be replaced with a remanufactured Product. Remanufactured Products, parts and materials are warranted for the remaining warranty term of the original Product, or 90 days after the date of repair or replacement, whichever is longer.

Limitations

This warranty does not cover circumstances beyond Kodak's control. This warranty does not apply when failure is due to shipping damage, accident, alteration, modification, unauthorized service, misuse, abuse, use with incompatible accessories or attachments (such as third party ink or ink tanks), failure to follow Kodak's operation, maintenance or repacking instructions, failure to use items supplied by Kodak (such as adapters and cables), or claims made after the duration of this warranty. Kodak makes no other express or implied warranty for this product. In the event that the exclusion of any implied warranty is ineffective under the law, the duration of the implied warranty will be the length of the express warranty period

www.kodak.com/go/support

specified on your Kodak product packaging. The option of repair, replacement, or refund is Kodak's only obligation. Kodak will not be responsible for any special, consequential or incidental damages resulting from the sale, purchase, or use of this product regardless of the cause. Liability for any special, consequential or incidental damages (including but not limited to loss of revenue or profit, downtime costs, loss of the use of the equipment, cost of substitute equipment, facilities or services, or claims of your customers for such damages resulting from the purchase, use, or failure of the Product), regardless of cause or for breach of any written or implied warranty is expressly disclaimed. The limitations and exclusions of liability set forth herein apply to both Kodak and its suppliers.

Your rights

Some states or jurisdictions do not allow exclusion or limitation of incidental or consequential damages, so the above limitation or exclusion may not apply to you. Some states or jurisdictions do not allow limitations on how long an implied warranty lasts, so the above limitation may not apply to you. This warranty gives you specific rights, and you may have other rights which vary from state to state or by jurisdiction.

Outside the United States and Canada

In countries other than the United States and Canada, the terms and conditions of this warranty may be different. Unless a specific Kodak warranty is communicated to the purchaser in writing by a Kodak company, no warranty or liability exists beyond any minimum requirements imposed by law, even though defect, damage, or loss may be by negligence or other act.

Regulatory compliance

FCC compliance and advisory

This equipment has been tested and found to comply with the limits for a Class B digital device, pursuant to Part 15 of the FCC Rules. These limits are designed to provide reasonable protection against harmful interference in a residential installation. This equipment generates, uses, and can radiate radio frequency energy and, if not installed or used in accordance with the instructions, may cause harmful

interference to radio communications. However, there is no guarantee that interference will not occur in a particular installation. If this equipment does cause harmful interference to radio or television reception, which can be determined by turning the equipment off and on, the user is encouraged to try to correct the interference by one or more of the following measures: 1) reorient or relocate the receiving antenna; 2) increase the separation between the equipment and the receiver; 3) connect the equipment to an outlet on a circuit different from that to which the receiver is connected; 4) consult the dealer or an experienced radio/TV technician for additional suggestions. Any changes or modifications not expressly approved by the party responsible for compliance could void the user's authority to operate the equipment. Where shielded interface cables have been provided with the product or specified additional components or accessories elsewhere defined to be used with the installation of the product, they must be used in order to ensure compliance with FCC regulation. The KODAK High Performance USB AC Adapter K20-AM complies with part 15 of the FCC Rules. Operation is subject to the following two conditions: (1) This device may not cause harmful interference, and (2) this device must accept any interference received, including interference that may cause undesired operation.

Waste Electrical and Electronic Equipment/Battery disposal



In Europe: For human/environmental protection, it is your responsibility to dispose of this equipment and batteries at a collection facility established for this purpose (separate from municipal waste.) For more information, contact your retailer, collection facility, or appropriate local authorities; or go to www.kodak.com/go/recycle. Product weight: 150 g (5.3 oz) with battery



Canadian DOC statement

DOC Class B Compliance—This Class B digital apparatus complies with Canadian ICES-003.

Observation des normes-Classe B—Cet appareil numérique de la classe B est conforme à la norme NMB-003 du Canada.

CE

Hereby, Eastman Kodak Company declares that this KODAK Product is in compliance with the essential requirements and other relevant provisions of Directive 1999/5/EC.

Australian C-Tick



VCCI Class B ITE

この装置は、クラスB情報技術装置です。この装置は、家庭環境で使用することを目的としていますが、この装置がラジオやテレビジョン受信機に近接して使用されると、受信障害を引き起こすことがあります。

取扱説明書に従って正しい取り扱いをして下さい。 VCCI-B

Russian GOST-R



Eastman Kodak Company
Rochester, NY 14650

Фотокамера изготовлена в Китае; остальные элементы -
АЮ-40 в соответствии с маркировкой.

Korean Class B ITE

<p>B급 기기 (가정용 방송통신기기)</p>	<p>이 기기는 가정용(B급)으로 전자파적합등록을 한 기기로서 주로 가정에서 사용하는 것을 목적으로 하며, 모든 지역에서 사용할 수 있습니다.</p>
-------------------------------	---

Korean Li-ion Regulatory

취급상의 주의사항

- < 경고 > 발열, 화재, 폭발 등의 위험을 수반할 수 있으니 다음 사항을
- 육안으로 식별이 가능할 정도의 부풀음이 발생한 전지는 위험할 수 있으므로 제조자 또는 판매자로 즉시 문의할 것
 - 지정된 정품 충전기만을 사용할 것
 - 화기에 가까이 하지 말 것 (전자레인지에 넣지 말 것)
 - 여름철 자동차 내부에 방치하지 말 것
 - 찜질방 등 고온다습한 곳에서 보관, 사용하지 말 것
 - 이불, 전기장판, 카펫 위에 올려 놓고 장시간 사용하지 말 것
 - 전원을 켜 상태로 밀폐된 공간에 장시간 보관하지 말 것
 - 전지 단자에 목걸이, 동전, 열쇠, 시계 등 금속 제품이 닿지 않도록 주의할 것
 - 휴대 기기, 제조 업체가 보증한 리튬2차전지 사용할 것
 - 분해, 압착, 관통 등의 행위를 하지 말 것
 - 높은 곳에서 떨어뜨리는 등 비정상적 충격을 주지 말 것.
 - 60°C 이상의 고온에 노출하지 말 것
 - 습기에 접촉되지 않도록 할 것

기타정보

- 폐기지침 : 각 지방자치단체의 법규에 의거하여 폐기할 것
- 충전방법에 대한 권고지침
 - 본 충전지와 함께 사용할 디지털카메라 사용자 설명서의 충전설명 참조하세요.
 - 코닥 정품 충전기 및 카메라에서만 충전하세요. (타사 충전셋 사용 금지)

제조년월 : Y = Year(제조년도의 마지막 숫자), WW = Week(제조년도의 주)

제조년월 표시 예 : 901 = 9 (2009년), 01 (첫째주)

China RoHS

环保使用期限 (EPUP)

在中国大陆，该值表示产品中存在的任何危险物质不得释放，以免危及人身健康、财产或环境的时间期限（以年计）。该值根据操作说明中所规定的产品正常使用而定。

有毒有害物质或元素名称及含量标识表						
部件名称	有毒有害物质或元素					
	铅	汞	镉	六价铬	多溴联苯	多溴二苯醚
数码相机电路板元件	×	○	○	○	○	○
锂电池	×	○	○	○	○	○
交流变压器	×	○	○	○	○	○
电池充电器	×	○	○	○	○	○

○：表示该有毒有害物质在该部件所有均质材料中的含量均在SJ/T 11363-2006规定的限量要求以下。
 ×：表示该有毒有害物质至少在该部件的某一均质材料中的含量超出SJ/T 11363-2006规定的限量要求。



USB 数据线

Index

A

- A/V out, 36
- about this camera, 48
- accessories
 - batteries, 61
 - buying, 56
 - MICROSD/SDHC Card, 7
- action print, 34
- add keywords, names, 44
- AF control, 47
- auto
 - flash, 16
 - focus control, 47
 - focus framing marks, 8

B

- background blur, 30
- backlight, 18, 19
- battery
 - charging, 2
 - expected life, 61
 - icons, 13
 - loading, 1
 - types, 61
- blur background, 30
- bright, 19
- burst, use, 21
- button
 - Burst, 21
 - Delete, 25
 - Flash, 16
 - Review, 46

- Share, 39
- Zoom, 15

C

- cable
 - audio/video, 36
 - USB, 49
- Camera Setup App, 49
- camera sounds, 47
- Canadian compliance, 64
- capture grid view, 11
- care and maintenance, 59
- charging
 - battery icon, 13
 - USB, 4
- charging the battery, 2
- children, 19
- clean view, 11
- clock, setting, 6
- computer
 - connect camera, 49
 - transfer to, 49
- computer connection, 47
- connector, USB / A/V, 36
- copy pictures to computer, 49
- Creative mode, 17
- cropping pictures, 29

D

- date, setting, 6
- date/time stamp, 32
- Delete button, 25

delete pictures
 from internal memory, 25
 from MICROSD/SDHC Card, 25

deleting
 during quickview, 10
display a slide show, 37
disposal, recycling, 59
download
 KODAK Software, 49
download pictures, 49

E
edit videos, 31
effects, 18, 30
EKTACHROME Vivid, 18
email, 39
email pictures, videos, 45
erase, 48
expected battery life, 61
exposure
 compensation, 20
 long time, 46
external video device
 viewing pictures, videos, 36

F
faces, tagging, recognition, 42
FCC compliance, 63
film effects, 18
find pictures, 27
fireworks, 19
firmware, upgrading, 59
flash settings, 16
flower, 18, 19

focus framing marks, 8
format, 48
framing marks, 8

G
grid view, 11
guidelines, battery, 61

H
HDR mode, 17
help
 Web links, 52
High ISO, 19
histogram view, 11

I
icons
 battery, 13
 mode dial, 17
icons, picture-taking, 13
install
 MICROSD/SDHC Card, 7
installing
 battery, 1

K
keyboard, 44
keywords, 44
KODACHROME 25 1970s, 18
KODACOLOR, 18
KODAK Camera Setup App, 49
KODAK EASYSHARE Software
 upgrading, 59
KODAK Software, download, 49
Kodak Web sites, 52

L

language, 47

LCD

brightness, 47

reviewing pictures, 23

reviewing videos, 23

lens, i

lens, clean, 59

load

MICROSD/SDHC Card, 7

loading

battery, 1

locate pictures, 27

long time exposure, 46

M

magnify a picture, 26

maintenance, camera, 59

make picture from video, 33

mark

for email, 45

memory

insert card, 7

menu settings, 46

microphone, i

MICROSD/SDHC Card

insert, 7

printing from, 51

mode

safe, 47

mode dial, 17

modes

backlight, 18, 19

bright, 19

children, 19

fireworks, 19

flower, 18, 19

High ISO, 19

Night Landscape, 19

night portrait, 19

self-portrait, 19

modes, capture

smart capture, 17

video, 17

modes, picture-taking, 17

multiple selections, 35

multi-up, thumbnail, 26

N

Night Landscape, 19

night portrait, 19

O

online prints, ordering, 51

optical zoom, 15

P

panoramic pictures, 22

PASM mode, 17

people, tagging, 42

photo effects, 30

PICTBRIDGE enabled printer, 50

picture size, 46

picture taking, 8

pictures

adding date/time stamp, 32

cropping, 29

email marked, 45

marking, 51

- review icons, 28
- reviewing, 23
- taking, modes, 17
- transfer to computer, 49
- pictures/video
 - deleting, 25
- picture-taking icons, 13
- Portrait mode, 17
- power icon, 13
- power, camera, 5
- print from a video, 34
- printing
 - from a card, 51
 - optimizing printer, 52
 - order online, 51
 - PICTBRIDGE, 50
 - tagged pictures, 51
- Program mode, 20

Q

- quickview
 - using, 10

R

- record button, 14
- recording light, i
- recycling, disposal, 59
- red-eye, flash, 16
- regulatory information, 63
- remote control, 38
- reset camera, 47
- Review button, 46
- reviewing pictures/video
 - deleting, 25

- LCD, 23
 - slide show, 37
- reviewing pictures/videos
 - as you take them, 10
- running slide show, 37

S

- safe mode, 47
- safety, 60
- Scene mode, 17
- Scene modes, 19
- search pictures, 27
- select multiple pictures/videos, 35
- self-portrait, 19
- sepia, 18
- setting
 - about this camera, 48
 - auto focus, 47
 - camera sounds, 47
 - computer connection, 47
 - date and time, 6
 - flash, 16
 - format, 48
 - language, 47
 - LCD brightness, 47
 - long time exposure, 46
 - picture size, 46
 - picture taking modes, 17
 - reset all settings, 47
 - safe mode, 47
 - slide show, 47
 - tag people, 46
 - video out, 48
- setting up the camera, 1

settings
 picture, video size, 46
settings menu, 46
Share button, 39, 46
shutter
 problems, 53
shutter button, 8
single frame, 34
slide show
 running, 37
slide show settings, 47
smart capture, 17
Smart Capture mode, 17
smart find, 27
social networks, 39
software
 upgrading, 59
software downloader, 49
sounds, 47
specifications, camera, 57
Sport mode, 17
spot color, 30
strap, 1

T

tag people setting, 46
tagging
 keywords, 44
 people, faces, 42
taking a picture, 8
taking a video, 14
taking pictures, videos, 8
television, slide show, 36
thumbnail view, 26

time, setting, 6
tint, 30
tips
 battery guidelines, 61
 care & maintenance, 59
T-MAX Art, 18
tools view, 11
transfer pictures, 49
trash can, deleting, 10
trimming a video, 31
TRI-X Photojournalism, 18
troubleshooting, 52
turning camera on/off, 5
typing, 44

U

upgrading software, firmware, 59
URLs, Kodak Web sites, 52
USB
 transfer pictures, 49
USB charging, 4

V

VCCI compliance, 65
video, 17
 edit, 31
 email marked, 45
 out, 48
 recording, 14
 review icons, 28
 transfer to computer, 49
 viewing, 23
video action print, 34
video out, 48

video record button, 14
video size, 46
viewing
 by multi-up, thumbnails, 26
 picture, after taking, 23
viewing picture/video
 after taking, 10

W

warranty, 62

Z

zoom
 optical, 15

Free Manuals Download Website

<http://myh66.com>

<http://usermanuals.us>

<http://www.somanuals.com>

<http://www.4manuals.cc>

<http://www.manual-lib.com>

<http://www.404manual.com>

<http://www.luxmanual.com>

<http://aubethermostatmanual.com>

Golf course search by state

<http://golfingnear.com>

Email search by domain

<http://emailbydomain.com>

Auto manuals search

<http://auto.somanuals.com>

TV manuals search

<http://tv.somanuals.com>