

User Guide

KODAK DP2900 Digital Projector

**with Kodak's Exclusive
Image Manager**

FCC Warning

This equipment has been tested and found to comply with the limits for a Class A digital device, pursuant to part 15 of the FCC Rules. These limits are designed to provide reasonable protection against harmful interference when the equipment is operated in a commercial environment. This equipment generates, uses, and can radiate radio frequency energy and, if not installed and used in accordance with the instruction manual, may cause harmful interference to radio communications. Operation of this equipment in a residential area is likely to cause harmful interference in which case the user will be required to correct the interference at his own expense.

Canada

This Class A digital apparatus complies with Canadian ICES-003.
Cet appareil numérique de la classe A est conforme à la norme NMB-003 du Canada.

Safety Certifications

UL, CUL, TÜV, NOM

EN 55022 Warning

This is a Class A product. In a domestic environment it may cause radio interference, in which case the user may be required to take adequate measures. The typical use is in a conference room, meeting room or auditorium.

Declaration of Conformity

Manufacturer: Eastman Kodak Company
Rochester, New York 14650 USA

We declare under our sole responsibility that the KODAK DP2900 Digital Projector conforms to the following directives and norms:

Directive 89/336/EEC, Amended by 93/68/EEC

EMI: EN 55022 (1992) Class A

EMC: EN 50082-1 (1992)

IEC 801-2, IEC 801-3, IEC 801-4

Directive 73/23/EEC, Amended by 93/68/EEC

Safety: EN 60950: 1992 + A1 + A2 + A3: 1995 +A4: 1997

May, 2000

Australian Certification C-tick mark



Table of Contents

Safety Instructions	vii
Introduction	11
Image Resolution	11
Compatibility	11
Unpacking the Projector	12
Projector Features	13
Usage Guidelines	13
If You Need Assistance	14
Setting up the Projector	17
Connecting the Projector	18
Starting the Projector	22
Turning Off the Projector	23
Using the Projector	25
Basic Image Adjustment	25
Adjusting the Projector	26
Using the Remote Control	27
Using the Keypad and Remote Buttons	29
Using the On-Screen Menus	32
Display Menu	33
Audio Menu	35
Image Menu	35
Controls Menu	38
Language Menu	40
Status Menu	41
Using KODAK Image Manager	43
Maintenance & Troubleshooting	45
Cleaning the Lens	45
Replacing the Projection Lamp	46
Replacing the Batteries in the Remote Control	49
Using the Security Lock	49
Troubleshooting	50

Appendix A	55
Appendix B	57
Portable and Laptop Activation Chart	57
Appendix C	67
Using Video Mirroring with a PowerBook Computer	67
Appendix D	69
Projected Image Size	69
Index	71
Warranty	75

Safety Instructions

Please read and follow all safety instructions provided before using your new projector. Failure to comply with safety instructions may result in fire, electrical shock, or personal injury and may damage or impair protection provided by equipment. *Please save all safety instructions.*

Safety Definitions

- **Warning:** Statements identify conditions or practices that could result in personal injury.
- **Caution:** Statements identify conditions or practices that could result in damage to your equipment.

Safety Symbols



Attention: For information about usage of a feature, please refer to the User's Guide.





Warning: Hot surface. Do not touch.



An arrow pointing to the lamp door on the projector.

Safety Issues

- **Warning:** Don't look directly into the lens when the lamp is turned on.
-  **Warning:** To replace the lamp, turn the projector off by unplugging the power cord. To avoid burns, wait 30 minutes before opening the lamp door. Follow all instructions provided in this User's Guide.
-  **Warning:** Please use the power cord provided. Connect the power cord to a receptacle with a protective safety (earth) ground terminal.
- **Warning:** Refer all service to qualified service personnel. Servicing your own projector will void the warranty. See the following page for the customer service contact information.
- **Caution:** Don't block ventilation openings.
- **Caution:** Don't set liquids on the projector. Spilled liquids may damage your projector.
- **Caution:** Don't place the projector on a hot surface or in direct sunlight.
- **Caution:** Do not drop the projector. Transport the projector in an KODAK-approved case. For accessory information go to our Web site at www.kodak.com/go/projectors.

Important Operating Considerations

Do not place the projector on a tablecloth or other soft covering that may block the vents. In the unlikely event of the bulb rupturing, thoroughly clean the area behind the projector and discard any edible items placed in that area.

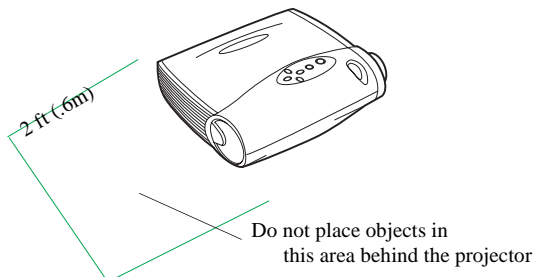

Battery Use

Read and follow all warnings and instructions supplied by the battery manufacturer.

Keep batteries away from children.

Store batteries in their original packaging.

When inserting batteries, verify that the (+) and (-) terminals are aligned correctly.

Replace all batteries of a set at the same time.

Do not mix new batteries with used ones.

Do not use batteries of different chemistries, capacities, brands or sizes together. Leakage could result.

Do not disassemble, recharge, or short-circuit batteries.

Do not subject batteries to high temperature or fire.

Discard used batteries according to all applicable local and national regulations.

In the unlikely event of contact with battery electrolyte, customers in the U.S. can contact the Kodak Information Center (KIC) at 1-800-242-2424. U.S. customers can also contact KIC for information regarding electrolyte removal from KODAK product components. Customers outside the U.S. can contact their local Kodak Customer Service representative.

Introduction

The KODAK DP2900 Digital Projector is specifically designed for the mobile presenter. It packs XGA 1024x768 graphics with 16.7 million colors into a small, 4.8 pound package. It generates crisp, clear images using Digital Light Processing™ (DLP) technology, and features an M1-DA connector for easy, built-in digital/analog and USB connectivity. The DP2900 is easy to connect, easy to use, easy to transport, and easy to maintain.

Included with the DP2900 is Kodak's exclusive Image Manager feature. With this feature you can select the image display setting best suited for your specific presentation material and projection environment.

Image Resolution

The XGA resolution of the DP2900 projected image is 1024x768. The projector cannot compress screen resolutions above 1024x768. If your computer's screen resolution is higher than 1024x768, reset it to a lower resolution before you connect the projector.

Note: The DP2900 automatically expands 640x480 and 800x600 images to 1024x768. You can display these images at their native resolutions by turning off the Auto Resize feature. See "Resize" on page 36 for more information.

Compatibility

The projector is compatible with a wide variety of computers and video devices, including:

- IBM-compatible computers, including laptops, up to 1024x768 resolution.
- Apple, Macintosh, and PowerBook computers up to 1024x768 resolution.
- Most standard VCRs, DVD players, HDTV sources, camcorders and laser disc players.

Note: The projector is compatible with 1080i HDTV format.

Unpacking the Projector

The projector comes with the items shown. Check to make sure all are included. **Contact your dealer of KODAK products immediately if anything is missing.**

A registration card is included in the box. Register to receive product updates, announcements, and special offers from Kodak.

The contents of your shipping box may vary depending on the projector configuration you've ordered.

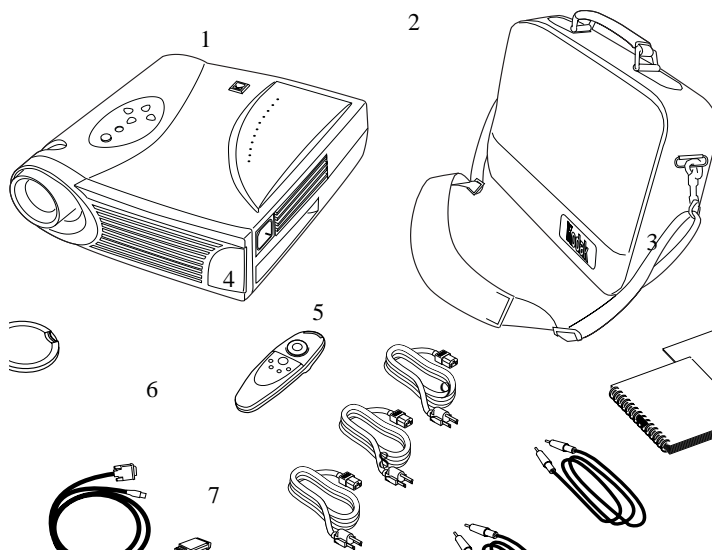

1. DP2900 projector and lens cap
2. Soft carry case
3. User Guide, Quick Start Card and Online User Guide CD
4. 3 Power cords
5. Remote control
6. M1-DA analog computer cable
7. Audio cable adapter
8. Audio cable
9. Composite video cable

Projector Features

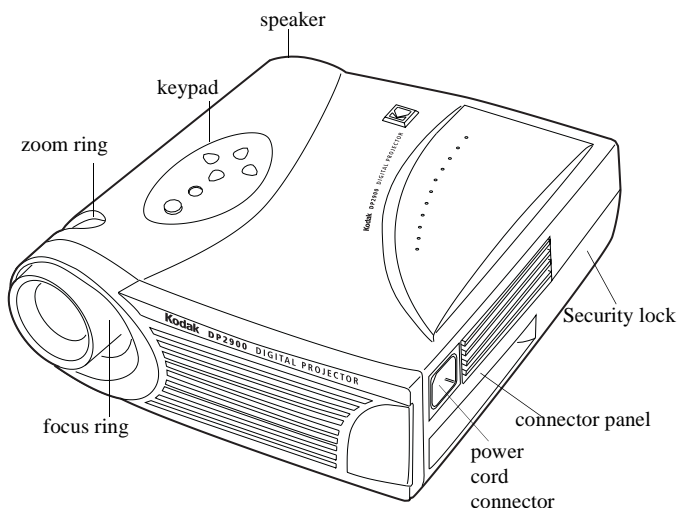

Usage Guidelines

- Do not look directly into the projection lens when the lamp is turned on. The bright light may harm your eyes.
- Do not block the grills on the projector. Restricting the air flow can cause it to overheat and turn off. If this happens, you must wait a minute before attempting to turn it back on.
- Handle the projector as you would any product with glass components. Be especially careful not to drop it.
- Avoid leaving the projector in direct sunlight or extreme cold for extended periods of time. If this happens, allow it to reach room temperature before use.
- Transport the projector in a KODAK-approved case. For accessories, visit our Web site at www.kodak.com/go/projectors.

If You Need Assistance

The first place to look for help is in “Maintenance & Troubleshooting” on page 37. But you can also get help online, by fax, or by phone.

Before calling your dealer or Kodak Technical Support for assistance, please have the following information available:

- the projector’s serial number (located on the bottom label)
- the resolution of your computer.

Online Services

Contact Kodak via:

World Wide Web	http://www.kodak.com (click on Service and Support)
America Online	(keyword) KODAK
CompuServe	GO KODAK
Kodak Internet List Server	photo-cd@info.kodak.com; or ftp.kodak.com

Faxed Information

Kodak offers automated support by fax:

U.S. and Canada	1-800-508-1531
Europe	44-0-131-458-6962
U.K.	44-0-131-458-6962

Telephone Customer Support

If you have questions concerning the operation of your KODAK projector, you can speak directly to a customer support representative. Have the projector serial number ready, and be at your computer with your projector when you call.

In the U.S. and Canada call toll free, 1-800-23K-ODAK, between the hours of 9:00 a.m. and 8:00 p.m. (Eastern Standard Time) Monday through Friday.

The International Toll Line is +44 (0) 131 458 6714.

In Europe call

Austria/Osterreich	01 795 67000
Germany/Deutschland	069 9509 6055
Spain/Espana	91 4069130
Belgium/Belgique	02 713 1398
Ireland/Eire	01 402 6815
Sweden/Sverige	08 587 70305
Denmark/Danmark	38 48 7088
Italy/Italia	02 696 33205
Switzerland/Schweiz/Suisse	01 838 5358
Finland/Soumi	0800 11 8043
Netherlands/Nederland	020 346 9128
UK (National Line)	0870 6061031
France	0141 918578
Norway/Norge	23 16 2041
Int. Fax Line	+44 (0) 131 458 6962

In other regions call:

Australia	613 9353-2261 Fax 613 9353-2567
Singapore/Malaysia/Indonesia/ India	65 4736 611 Fax 65 4798 397
Thailand	662 2713 040 Fax 662 6161 923
Philippines	632 8100 331 loc 223 or 416 Fax 632 8140 626
South Korea	822 7085 577 Fax 822 36721 450
HK/PRC	852 2564 9396 Fax 852 2562 4258
Taiwan	886 2-8938178 Fax 886 2-8951069

Setting up the Projector

This section describes how to:

- determine where to position the projector
- connect the projector to a computer or a video source
- turn on and turn off the projector

If you are experienced in setting up presentation systems, use the Quick Start card that came with the KODAK DP2900 Digital Projector. Otherwise, follow the procedures described here.

Positioning the Projector

Note: If you want to project from behind a translucent screen, set up the projector behind your screen. See “Rear Projection” on page 38 to reverse the image.

1. Make sure your projector is on a flat surface. It must be within 10 feet (3 m) of your power source and within 6 feet (1.8 m) of your image source.
2. Position the projector the desired distance from the screen.
 - The distance from the lens of the projector to the screen and the zoom setting determine the size of the projected image. Three projected image sizes are shown here. For more information about image size, see “Projected Image Size” on page 69.

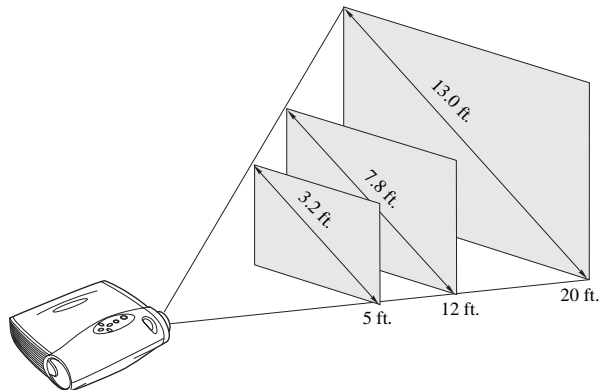

3. Make sure the projector is unplugged and your computer is turned off.

Connecting the Projector

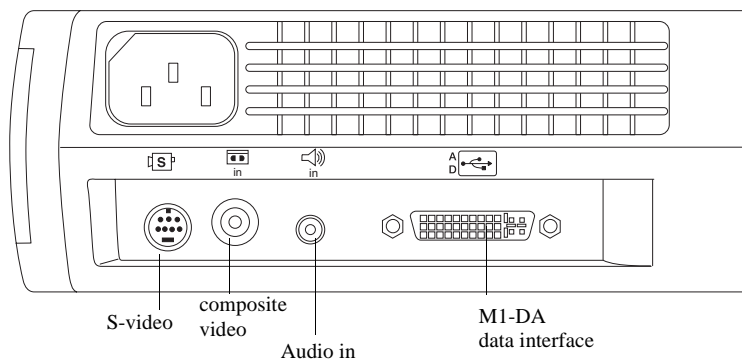



Icons on the projector will aid you when connecting the projector to a computer or video source.

Caution: Turn off the computer, monitor and projector whenever you connect the components.

Connecting a Computer

The projector ships with an M1-DA analog computer cable. If your computer has a digital output, you can order the optional M1-DA digital computer cable. For accessory information, visit our Web site at www.kodak.com/go/projectors.

Note: Many laptop computers do not automatically turn on their external video port when a secondary display device such as a projector is connected. Refer to your computer manual for the command that activates the external video port. Activation commands for some laptop computers are listed in “Portable and Laptop Activation Chart” on page 57.

1. Plug the  end of the M1-DA analog computer cable into the  connector on the projector.
2. Plug the  end of the M1-DA analog computer cable into the video connector on your computer.

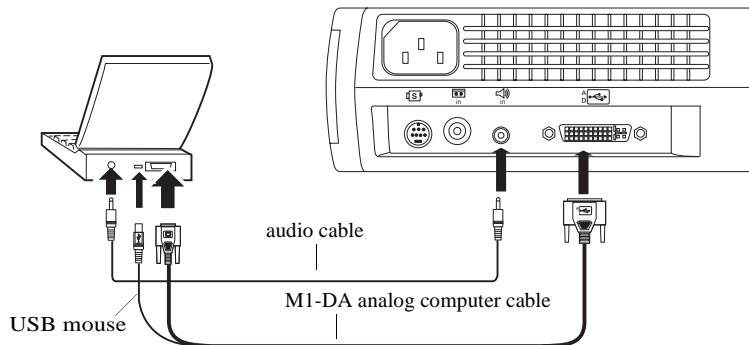

Note: If you are connecting an older MACINTOSH computer that does not have a 15-pin connector, you must use the MACINTOSH adaptor that came with the projector.

Do you want to control the computer's mouse from the projector's remote or keypad?

Note: The USB mouse is supported for use with Windows 98, Windows 2000, and Apple OS 8.5 and higher only. You do not need to restart your computer after connecting a USB mouse to use it (it is hot-pluggable).

1. Plug the  end of the M1-DA analog computer cable into the mouse connector on your computer.

Do you want to play your computer's audio on the projector?

1. Plug either end of the audio cable into the audio connector on your computer.
2. Plug the other end of the audio cable into the  connector on the projector.

Now you're ready to turn on the projector and your computer. Skip to "Starting the Projector" on page 22.

Connecting a Video Source

If your video source uses a round, one-prong composite video connector, you'll need only the audio cable, audio adapter, and composite video cable that shipped with the projector.



Note: HDTV sources are connected to the projector using the M1-DA computer cable. See the previous pages for details.

If your video source uses a round, four-prong S-video connector, you'll need an S-video cable in addition to the audio cable and audio adapter. The S-video cable is sold separately.

To connect to a video source:

1. Plug the composite video cable's yellow connector into the "video-out" connector on your video source. This connector may be labeled "To Monitor."
 - If you're using an S-video cable, connect it to the "S-video out" connector on the video source.

Caution: Your video source may also have a "Video Out" connector for a coaxial cable connection. DO NOT use this to connect to the projector.

2. Plug the other yellow connector into the composite video connector  on the projector.
 - If you're using S-video, plug the other end of the cable into the "S-video" connector  on the projector.

Connecting with a composite video cable:

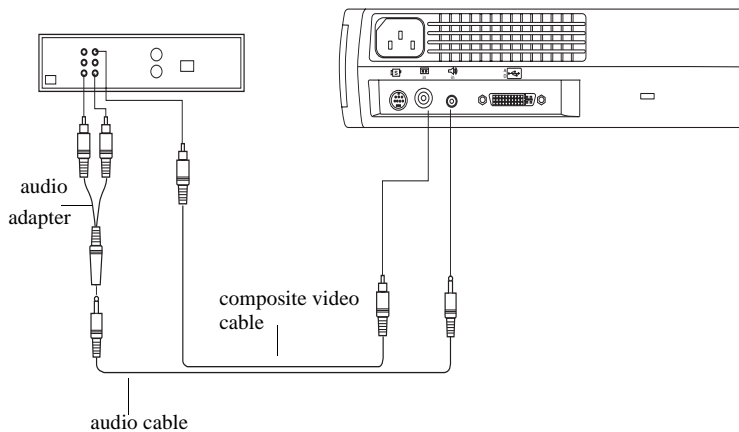

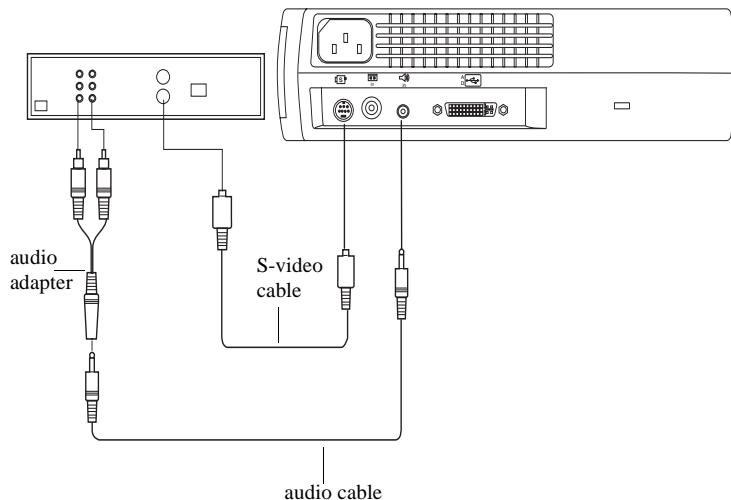
Connecting with an S-video cable:

3. Plug the audio adapter's white connector into the left "audio out" connector on your video source. Plug the adapter's red connector into the right "audio out" connector on the video source.
4. Plug the audio adapter's white connector into the left "audio out" connector on your video source. Plug the adapter's red connector into the right "audio out" connector on the video source. Plug the audio adapter's other end into the audio cable.
5. Plug the audio cable into the "audio in"  connector on the projector.

The projector is compatible with these major broadcast video standards: NTSC, NTSC 4.43, PAL, PAL-M, PAL-N, PAL-60, and SECAM. It automatically adjusts to optimize its performance for the incoming video. The input signal for SECAM video is similar to other video signals and cannot be automatically detected, therefore SECAM must be chosen manually. See "Video Standard" on page 38 for details.

Starting the Projector

We recommend using a surge protector power strip when connecting your projector.

Caution: Always use the power cord that shipped with the projector.

1. Remove the lens cap.
2. Plug the power cord into the side of the projector, then plug it into your electrical outlet.

The fans start to run, and the Lamp LED on the top of the projector lights orange until the software has initialized. When initialization is complete, the Lamp LED lights green. A green



Lamp LED indicates that you can press the **lamp on/off** button  to turn the lamp on and off.

Note: The first time you connect your computer to the projector, the computer may display a message stating that new hardware was found. The Add New Hardware Wizard may appear. Use the Wizard to load the correct driver (the computer considers the projector a Plug and Play Monitor).

3. Turn on the lamp by pressing the **lamp on/off** button  on the keypad.

The startup screen appears.



4. If you connected a video source, turn it on.

The video image should display on the projection screen. If a computer source is active, press the **source** button  on the keypad (page 30) or press the **video** button  on the remote to display your video image. You can select a default source to determine which source the projector examines first during power-up for active video; see “Default Source” on page 39.

Use the **volume** buttons   to adjust the volume.

5. Turn on your computer. Make sure your laptop's external video port is activated; see "Portable and Laptop Activation Chart" on page 57 for details.

Note: With some computers, the order in which you power up the equipment is very important. Most computers should be turned on last, after all other peripherals have been turned on. Refer to your computer's documentation to determine the correct order.

The computer image should display on the projection screen. If a video source is active, press the **source** button  on the keypad or the **computer** button  on the remote to display your computer's image.

If necessary, make adjustments to the image using the projector's on-screen menus. To open the menus, press the **menu** button  on the keypad or remote, then select the Display or Image sub-menu. For more information about the menus, see page 32.

Turning Off the Projector

If you want to turn off the projector for a short period of time, press the **standby** button on the keypad or remote. This blanks the screen for fifteen minutes, but keeps the projector running. (You can change the amount of time the projector stays in standby mode; see "Standby Time" on page 38 for details.) After 15 minutes, the lamp goes out but the projector keeps running. To exit standby mode, press the **standby** button again. (It may take several seconds for the projection lamp to reach full power and project the image again.)

Important: Lamp life will be extended if you turn the lamp off, then wait 1 minute while the lamp cools before unplugging the projector. The Lamp LED will light green when the lamp has cooled. See page 30 for details on the Lamp LED.

To completely turn off the projector, unplug it. If you want to turn the lamp back on immediately, you must allow about a minute for the lamp to cool. The lamp won't light if it's too hot.

Using the Projector

This section describes how to use and make adjustments to the projector. It also provides a reference to the keypad and remote buttons and the options available from the on-screen menus.

Basic Image Adjustment

- Make sure you have turned on your equipment in the right order (page 22).
- If the image doesn't display completely, zoom the image (page 26), adjust the height of the projector (page 26) or center the image by adjusting its horizontal or vertical position (page 37). Be sure the projector is at a 90 degree angle to the screen.
- If the image is out of focus, rotate the focus lens (page 26).
- If the image appears to shimmer or if it has blurry vertical bars after you have adjusted the focus, turn Auto Image (page 36) off and then back on to reset the automatic sync and tracking. If that doesn't clear up the image, turn Auto Image off and adjust the sync (page 37) and/or the tracking (page 37) manually.

- If the colors don't look right, check the KODAK Image Manager settings. See "Using KODAK Image Manager" on page 43.

Important: The KODAK Image Manager settings work best if you select Reset from the Adjust tab each time before selecting an Image Manager setting.

Or

Adjust the brightness (page 33) and the tint (page 34).

- If the computer source image is not rectangular, adjust the keystone (page 35).
- If the edges of the video source image appear jagged, adjust the overscan (page 35).

Adjusting the Projector

To focus the image, rotate the focus ring until the image is clear. To zoom the image, rotate the zoom ring. This adjusts the image size without affecting focus.

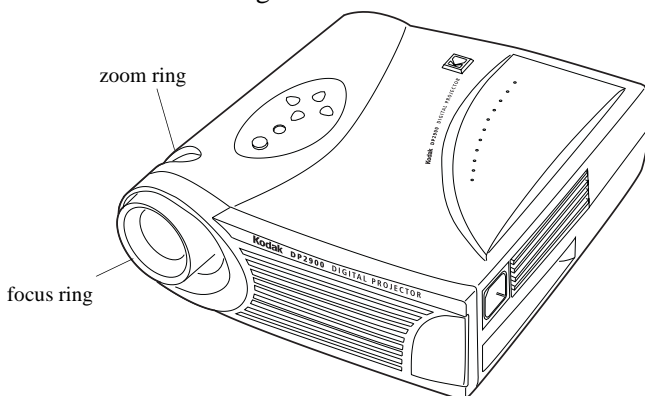

The projector is equipped with a self-locking, quick-release elevator foot and button.

To raise the projector:

1. Press and hold the elevator button.
2. Raise the projector to the height you want, then release the button to lock the elevator foot into position.

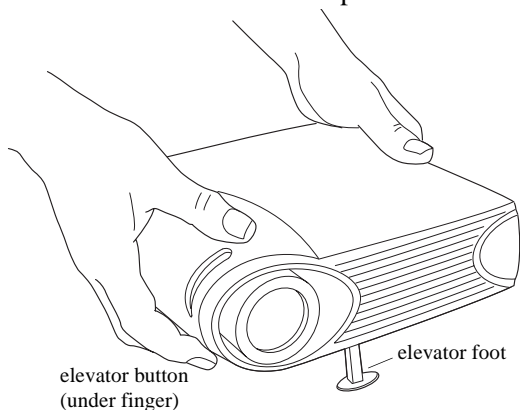

Using the Remote Control

Important: To control the computer's mouse from the projector's remote or keypad, you must connect the mouse connector on the computer cable to the computer. See page 19 for details.

The projector ships with a remote control that has four function buttons, a disk mouse and two mouse buttons—one on the top of the remote and one on the bottom.

Point the remote control at the projection screen or at the front of the projector. The range for optimum operation is about 25 feet. If you point the remote at the projection screen, the distance to the screen and back to the projector must be less than or equal to 25 feet. For best results, point the remote directly at the projector.

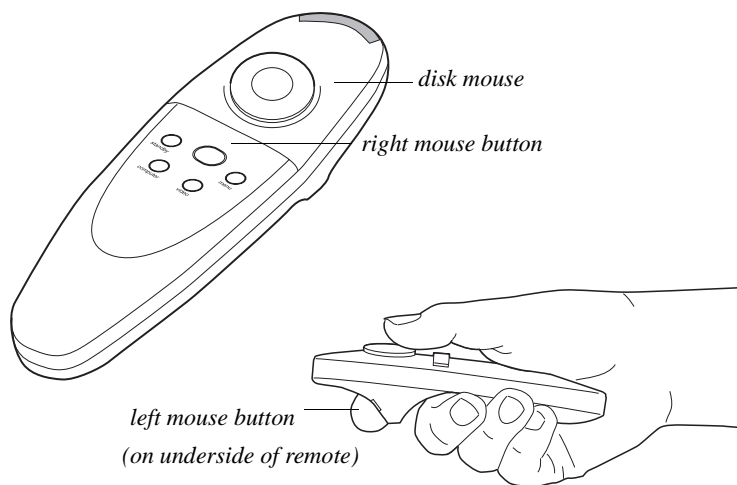

Note: If the remote is inactive for several minutes, it “sleeps” to conserve battery life. Press any button except the disk mouse to re-activate the remote.

Press anywhere on the edge of the disk mouse to move the cursor on the screen. You can move the cursor at any angle by pressing the corresponding edge of the disk. The mouse button on the top of the remote simulates your computer's right mouse button; the button on the bottom simulates your computer's left mouse button. See “Using the Keypad and Remote Buttons” on page 29 for a description of the four function buttons.

If you are creating presentations in MICROSOFT POWERPOINT, you can use the remote control mouse buttons to navigate through your presentation while in Slide Show mode. To configure the POWERPOINT program for this, choose Options from the Tools menu, click the View Tab, de-select the “Popup Menu on Right Mouse Click” option in the Slide Show section, then click OK. Then, when you’re in POWERPOINT Slide Show mode, a left click advances to the next slide and a right click returns to the previous slide (other POWERPOINT modes are not affected).

Using the Keypad and Remote Buttons

While the menus are displayed, the volume, source, and standby buttons on the keypad act as menu navigation buttons. See “Using the On-Screen Menus” on page 32 for details.

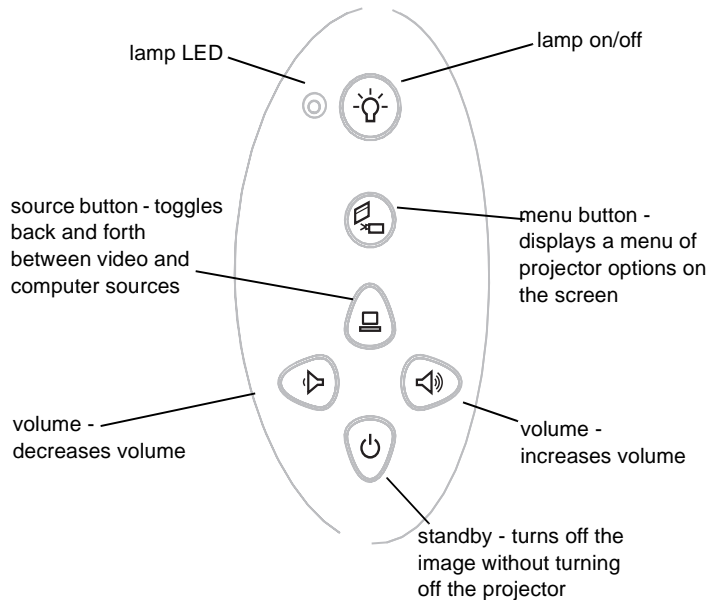

The Keypad Buttons



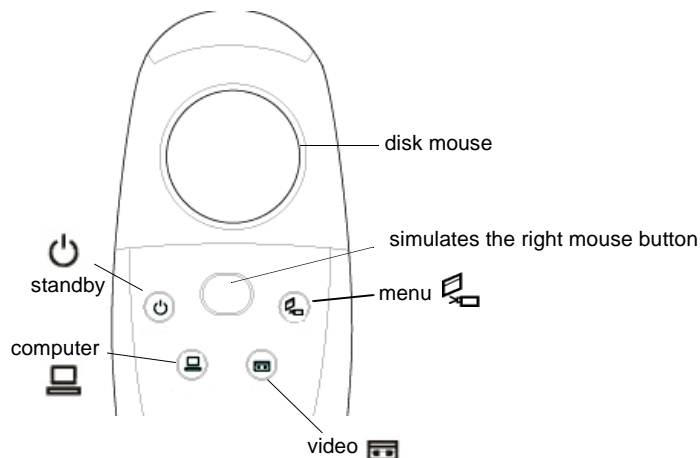

The Remote Control Buttons



Lamp on/off (keypad only)

Press the **lamp on/off** button  to turn the lamp on or off. The Lamp LED indicates the state of the lamp. A green Lamp LED indicates that you can turn the lamp on, or the lamp is currently on. An orange LED indicates the software is initializing or the lamp is cooling. Do not press the **lamp on/off** button  when the LED is orange.

Menu



Press the **menu** button  to open the on-screen menus. Press **menu**  again to close the menus. When you close the menus, the projector saves any changes you made. For more information about the on-screen menus, see page 32.

Source (keypad only) or Computer and Video (remote only)

When you have more than one source (computer and video) connected to the projector, select between them by pressing the **source** button on the keypad or the **computer** or **video** button on the remote.

Standby

When you press **standby**  , the display and audio turn off and a blank screen is displayed for 15 minutes. You can change the amount of time the projector stays in standby mode; see “Standby Time” on page 38 for details.

- If you press **standby**  again within 15 minutes, the projector returns to normal operations immediately.
- If you press **standby**  again after 15 minutes, there is about a 60 second delay before the lamp turns back on.
- If you don't press **standby**  again, the lamp turns off after 15 minutes.

Volume (keypad only)

To increase the volume, press **volume +** . To decrease the volume, press **volume -** .

Volume adjustments are saved for each source you have connected.

Using the On-Screen Menus

The projector has six drop-down menus that allow you to make image adjustments and change a variety of settings. Most of these adjustments aren't available directly from the keypad.

Note: Some menu items may be grayed out at certain times. This indicates the item is not applicable to your setup (for example, video standards do not apply to computer sources) or the item is not enabled until another selection is made (for example, Manual Tracking is not available until Auto Image is turned off).

To open the on-screen menus, press the **menu** button  on the keypad or remote. This changes the volume, source, and standby buttons on the keypad to menu navigation buttons. Press the corresponding buttons to move the cursor up, down, left, or right, or use the disk mouse on the remote. To select a menu, move the cursor left or right to highlight the menu you want. The drop-down menu appears.

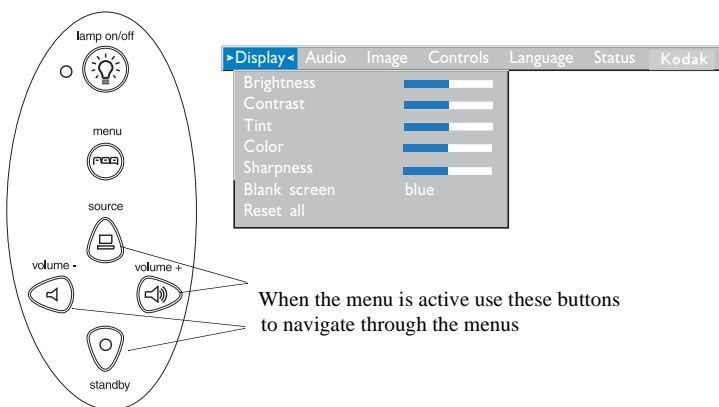

To change a menu setting, use the up and down navigation buttons on the keypad or the disk mouse on the remote to move the cursor up and down to the item you want to change (the selected item is highlighted), then use the left and right navigation buttons to adjust a setting.

Some submenus, such as Brightness, consist of a slider bar you use to increase or decrease a value; some submenus, such as Standby Time, consist of options you scroll through to select the desired one. All changes are saved when you close the menus.

To access another menu, use the up and down navigation buttons or the disk mouse to move back to the top of the current menu, then use the left and right navigation buttons to move to another menu.

Display Menu

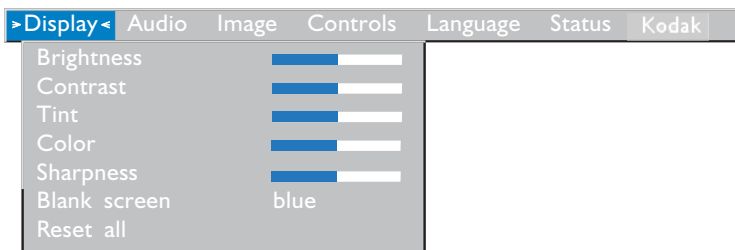

Brightness

Adjusting the brightness changes the intensity of the image.

- Press the left navigation button to darken the image.
- Press the right navigation button to lighten the image.

Contrast

The contrast controls the degree of difference between the lightest and darkest parts of the picture. Adjusting the contrast changes the amount of black and white in the image.

- Press the left navigation button to decrease the contrast.
- Press the right navigation button to increase the contrast, making the blacks appear blacker and the whites appear whiter.

Tint

The tint adjusts the red-green color balance in the projected image. Changing the Tint setting has no effect on PAL or SECAM video sources.

- Press the left navigation button to increase the amount of green in the image.
- Press the right navigation button to increase the amount of red in the image.

Color

The color setting adjusts a video image from black and white to fully saturated color.

- Press the left mouse button to decrease the amount of color in the image.
- Press the right mouse button to increase the amount of color in the image.

Sharpness

This setting adjusts the sharpness of a video image.

- Press the left mouse button to decrease the sharpness.
- Press the right mouse button to increase the sharpness.

Blank Screen

Blank Screen determines what color is displayed when there is no active source and when the projector is in standby. Click the left or right navigation button to toggle between blue and black.

Reset All

Click the left or right navigation button to reset all the options (except Language, Video Standard, Rear Projection, and Standby Time) in all the menus to their original settings.

Audio Menu



Volume

Note: Changing the volume using the menu is the same as changing it using the keypad.

- Press the left navigation button to decrease the volume.
- Press the right navigation button to increase the volume.

Volume adjustments you make are saved for each source.

Image Menu

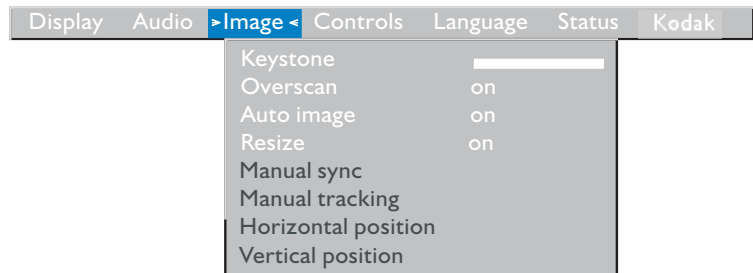

Keystone (computer source only)

This option helps to keep the image square as the angle of projection is changed. To adjust the keystone, highlight Keystone, then click the right navigation button.

Note: Keystone correction is only available for XGA signals.

Overscan (video source only)

This option crops all the edges of the image to remove noise generated on the edges by your source.

Auto Image

Note: Some screen savers interfere with the operation of Auto Image. If you're experiencing problems, turn off your screen saver, then turn Auto Image off and back on.

The projector automatically adjusts tracking, signal synchronization and vertical and horizontal position for most computers (Auto Image does not apply to video sources). If you want to adjust these features manually, you must turn off **Auto Image** first by highlighting Auto Image in the Image menu and clicking the left or right navigation button to select "off".

Resize

This option works differently for computer and video sources. For computer sources, **Resize** automatically resizes the image by scaling it up or down. It only affects computer images that are not the projector's native resolution. When **Resize** is on, the projector makes the best fit of the image to the computer screen. If you turn **Resize** off (by highlighting it in the Image menu and clicking the left or right navigation button to select "off"), the image may be either cropped or too small for the screen.

Note: When you connect an HDTV source, the projector automatically displays the image in 16x9 format.

For video sources, **Resize** allows you to select from among four different re-sizing options. The default is **Standard**, which resizes the image from its original version to fit a standard 4x3 aspect ratio screen. **Widescreen Letterbox** preserves the 16x9 aspect ratio of the original theater version, but the image is placed in a 4x3 space, so black bars appear at the top and bottom of the image. **Enhanced Widescreen** also preserves the aspect ratio of the original theater version and is designed to be used with content that is Enhanced for Widescreen TVs. This option yields more detail than Widescreen Letterbox. **Native** reduces the Standard size to match the height of Enhanced Widescreen.

Manual Sync (computer source only)

The projector adjusts signal synchronization automatically for most computers. But if the projected computer image looks fuzzy or streaked, try turning **Auto Image** off then back on again. If the image still looks bad, try adjusting the signal synchronization manually:

1. Turn Auto Image off.
2. Highlight Manual sync, then press the left or right navigation button repeatedly until the image is sharp and free of streaks.

Manual Tracking (computer source only)

The projector adjusts tracking automatically to match the video signal from your computer. However, if the display shows evenly spaced, fuzzy, vertical lines or if the projected image is too wide or too narrow for the screen, try turning **Auto Image** off then back on again. If the image is still bad, try adjusting the tracking manually:

1. Turn Auto Image off.
2. Highlight Manual tracking, then press the left or right navigation button repeatedly until the fuzzy vertical bars are gone.

Horizontal position (computer source only)

Follow these steps to manually adjust the horizontal position:

1. Turn off Auto Image.
2. Highlight Horizontal position, then press the left navigation button to move the image right or press the right navigation button to move the image left.

Positioning adjustments are saved when you power off the projector.

Vertical position (computer source only)

Follow these steps to manually adjust the vertical position.

1. Turn off Auto Image.
2. Highlight Vertical position, then press the left navigation button to move the image down or press the right navigation button to move the image up.

Positioning adjustments are saved when you power off the projector.

Controls Menu

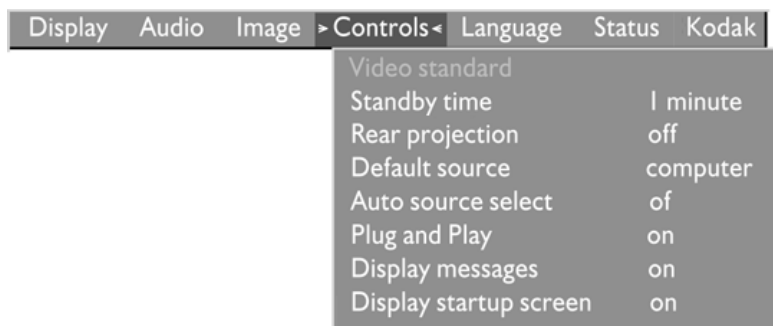

Video Standard

Note: If you already know the video standard used in your geographical area, it's often best to manually select it.

When Video standard is set to Auto, the projector attempts to pick the video standard (NTSC, NTSC 4.43, PAL, PAL-M, PAL-N, PAL-60, or SECAM) automatically based on the input signal it receives. (The video standard options may vary depending on your region of the world.) The input signal for SECAM video is similar to other video signals and cannot be automatically detected, therefore SECAM must be chosen manually. If the projector is unable to detect the correct standard, the colors might not look right or the image might appear "torn." If this happens, manually select a standard by clicking the left or right navigation button and cycling through the standards.

Standby Time

This option lets you select how long the lamp stays on and the blank screen is displayed when the projector enters standby mode before the projector turns off. Select among instant, 1, 5, 10, 15 and 30 minutes and 1 and 2 hours by clicking the left or right navigation button and cycling through the options.

Rear Projection

When you turn **Rear Projection** on, the projector reverses the image so you can project from behind a translucent screen. Highlight Rear

Projection, then click the left or right navigation button to turn this feature on and off.

Default Source

Default Source toggles among Computer analog, Computer digital, and Video. This determines which source the projector checks first for active video during power-up. Highlight Default Source and click the left or right navigation button to toggle among the options.

Auto Source Select

This setting toggles between On and Off. When this feature is Off, the projector defaults to the source selected in Default Source. To display another source, you must manually select one by pressing the **source** button on the keypad or the **computer** or **video** button on the remote. When this feature is On, the projector automatically finds the active source, checking the default source first. Highlight Auto Source Select and click the left or right navigation button to turn this feature on and off.

Plug and Play

This setting toggles between On and Off. When it is On, most new computers will automatically recognize the projector, then set the monitor resolution and refresh rate accordingly. You need to set the Plug and Play setting to Off for the projector to display properly on some older computers. The Plug and Play setting does not affect video images.

If the projector's display constantly changes between the computer image and the message, "Perfecting the image", you may need to turn Plug and Play Off.

Display Messages

This setting toggles between On and Off. When this feature is On, status messages such as "No signal detected" or "Standby Active" appear in the lower-right corner of the screen. Click the left or right navigation button to turn this feature off and not see status messages.

Display Startup Screen

This setting toggles between On and Off. When this feature is On, the startup screen appears when the projector starts up and remains until an active source is detected. Click the left or right navigation button to turn this feature off and display a plain black or blue screen instead of the startup screen.

Language Menu



You can display the on-screen menus in English, French, German, Spanish, Chinese or Japanese.

- Move the cursor to the language you want, then click the left or right navigation button. The menus redraw immediately.

Status Menu

This is a read-only window for informational purposes. To display the status window, select Show status from the menu, then click the left or right navigation button. To remove the window, click the left or right navigation button.

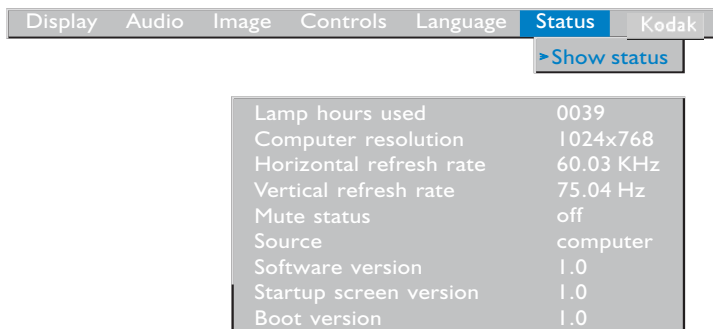

Lamp hours used

Indicates how many hours the current lamp has been in use. The counter starts at zero hours and counts each hour the lamp is in use. Change the bulb when the brightness is no longer acceptable. See “Replacing the Projection Lamp” on page 46 for details.

Computer resolution

Shows your computer’s resolution setting. To change this, go to your computer’s Control Panel and adjust the resolution in the Display tab. See your computer’s user’s guide for details.

Horizontal refresh rate

The time period that one horizontal line is displayed.

Vertical refresh rate

The time period that one video frame is displayed.

Mute status

Indicates if the audio is muted.

Source

Indicates the active source, Computer analog, Computer digital, or Video.

Software version

Indicates the projector's software version. This information is useful when contacting Technical Support.

Startup screen version

Indicates the projector's splash screen version. This information is useful when contacting Technical Support.

Boot version

Indicates the projector's boot software version. This information is useful when contacting Technical Support.

Using KODAK Image Manager

With one click, Kodak's exclusive Image Manager lets you choose the best image settings for your presentation type.



Important: The KODAK Image Manager settings work best if you select Reset from the Adjust tab each time before selecting an Image Manager setting.

Move the cursor to the option you want, then click the left or right navigation button.

Photos (PC) matches the higher contrast found on a standard PC monitor.

This feature is best for:

- images created on a PC
- images from a KODAK digital camera
- a starting point for video input.

Photos (MAC) matches the lower contrast found on a standard MACINTOSH monitor. It is generally used for images created on or for a MACINTOSH. This setting also works well with a PC if you are using higher than normal contrast PC images.

Rich Colors results in an image with deep contrast and saturated vibrant colors. It is generally used under bright lighting conditions. This setting works well to enhance colors of certain graphics and it may be useful when images created for a MACINTOSH are displayed from a PC.

Spreadsheets results in an image with contrast between a PC and MACINTOSH monitor. It is generally used for text-rich tables, such as financial displays. This setting factors in ambient light, subject matter, and personal preferences to deliver the right balance of contrast and brightness.

Graphics delivers the high contrast needed to project graphics and text against solid colored backgrounds.

Maintenance & Troubleshooting

This section describes how to:

- clean the lens
- replace the projection lamp
- replace the batteries in the remote
- use the security lock feature
- troubleshoot the projector

Cleaning the Lens

Follow these steps to clean the projection lens:

1. Apply a non-abrasive camera lens cleaner to a soft, dry cloth.
 - Avoid using an excessive amount of cleaner.
 - Abrasive cleaners, solvents or other harsh chemicals might scratch the lens.
2. Lightly wipe the cleaning cloth over the lens in a circular motion.
3. If you don't intend to use the projector immediately, replace the lens cap.

Replacing the Projection Lamp

Warning: *To avoid burns, allow the projector to cool for at least 30 minutes before you open the lamp module door. Never extract the lamp module while the lamp is operating.*

Important: *The lamp in the KODAK DP2900 contains trace amounts of mercury. Some governments require special disposal of lamps containing mercury. Dispose of lamps in accordance with the law and any applicable local regulations.*

The lamp hour counter in the Status menu counts the number of hours the lamp has been in use. Replace the lamp when the brightness is no longer acceptable. To order replacement lamp modules contact your dealer of KODAK products or visit our Web site at www.kodak.com/go/projectors.

Follow these steps to replace the projection lamp:

1. Turn off the projector by unplugging the power cord.
2. Wait 30 minutes to allow the projector to cool thoroughly.
3. Invert the projector on a soft flat surface, then insert a small screwdriver or other flat object into the tab on the lamp module door..

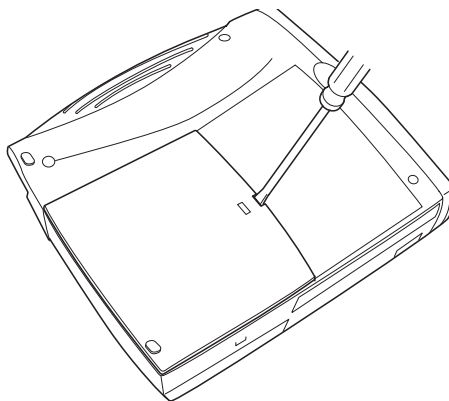

4. Pull the lamp door up and remove it.

Warning: *Be extremely careful when removing the lamp module. In the unlikely event that the bulb ruptures, small glass fragments may be generated. The lamp module is designed to contain these fragments, but use caution when removing the lamp module*

Caution: Never operate the projector with the lamp door open or removed. This disrupts the air flow and causes the projector to overheat.



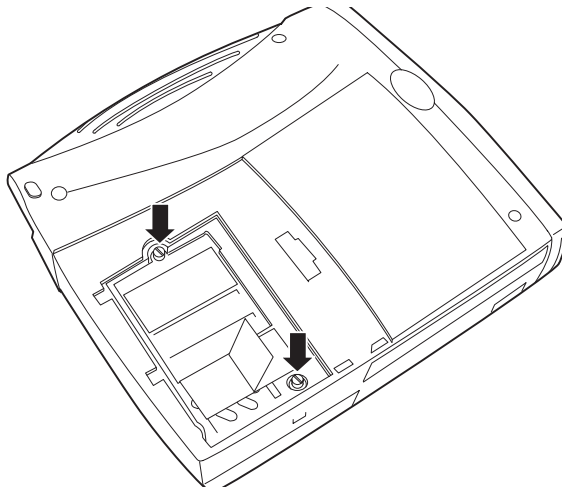

5. Loosen the two non-removable screws on the outside of the module.

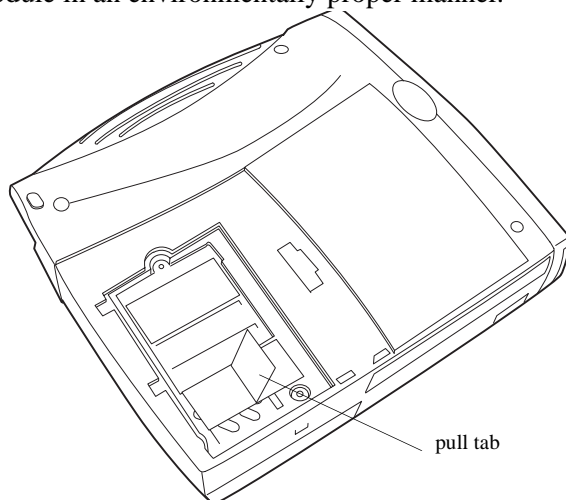

6. Lift and grasp the pull tab and lift the module out. Dispose of the lamp module in an environmentally proper manner.



***Warning: Do not drop the lamp module or touch the glass bulb!
The glass may shatter and cause injury.***

7. Install the new lamp module, being sure to align the connectors properly.
8. Push the module in until it is flush with the bottom case of the projector.
9. Tighten the screws on the outside of the module.
10. Replace the lamp door by inserting the hooks on the rear of the lamp door into the projector and pressing the lamp door into place. If the lamp door does not fit properly or bulges out, remove the door and re-seat the lamp module.
11. Plug in the power cord to turn the projector back on.
12. To reset the lamp hour counter in the Status window, press and hold the **volume -** button , then press the **menu** button  (while still holding down the **volume -** button ) for 5 seconds. Verify that the counter was reset by pressing the **menu** button  and viewing the counter in the Status window.

Replacing the Batteries in the Remote Control

The life of the batteries depends on how often and how long you use the remote. Symptoms of low battery charge include erratic responses when using the remote and a reduced range of operation.

Follow these steps to replace the batteries:

1. Turn the remote face down in your hand.
2. Slide the battery cover off the end of the remote.
3. Remove the old batteries and dispose of them in an environmentally proper manner.
4. Install two new AAA alkaline batteries. Make sure you install each in the correct direction.
5. Slide the battery cover back on the remote.

Using the Security Lock

The projector has a security connector for use with a PC Guardian Cable Lock System. (This Lock System must be purchased separately.) Refer to the information that came with the lock for instructions on how to use it to secure the projector.

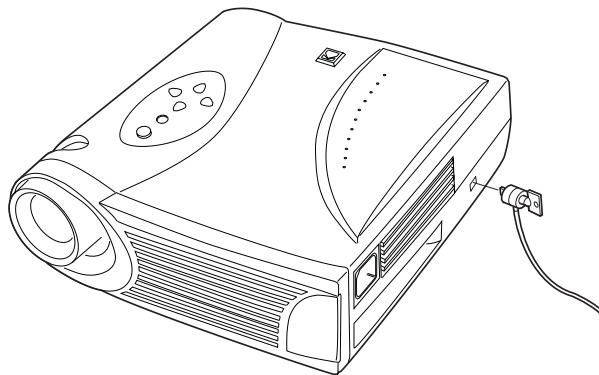

Troubleshooting

If you don't find the answer to your problem here, visit our Web site at www.kodak.com/go/projectors for the latest updates on troubleshooting.

Sound

Problem	Cause and Solution
No sound.	<ul style="list-style-type: none"> • Adjust volume. • Verify audio / input connections. • Adjust audio source.
Poor sound quality.	<ul style="list-style-type: none"> • Make sure you are connected to the earphone jack on your laptop or line out jack on your desktop. • Make sure the volume setting on your computer is halfway.
No audio-out port on the image source.	You are not able to connect audio to the projector.

Remote Control

Problem	Cause and Solution
Projector responds poorly or not at all to the remote control.	<ul style="list-style-type: none"> • Make sure that the total distance from the remote to the projector is no more than 25 feet (7.6 m). • Point the remote control at the screen or at the front of the projector. • Make sure nothing is blocking the infrared sensor on the front of the projector. • Darken the room. The lighting might be effecting the remote control. • Replace the remote control batteries.

Image Quality

Problem	Solution
Color or text is not projected.	Adjust the brightness up or down until the text is visible.
Some text or fonts are not sharp with a computer as an image source.	For optimal results, set the computer's resolution to 1024 x 768. (Refer to your computer user manual.) It may be necessary to reduce the keystone correction for optimum results.
Image isn't centered on the screen.	<ul style="list-style-type: none"> • Be sure that the projector is at a 90° angle to the screen. • Use the software to reposition the image. "Horizontal position (computer source only)" on page 37 and "Vertical position (computer source only)" on page 37.
Image is out of focus.	<ul style="list-style-type: none"> • Turn the projection lens to focus the image. • Make sure that the projection screen is at least 3 ft (.9 m) from the projector. • Check the projection lens to see if it needs cleaning.
Image and menus are reversed from left to right.	<ul style="list-style-type: none"> • If projecting from behind a screen, make sure that Rear Projection is selected. • If projecting from in front of a screen, make sure that Front Projection is selected.
Image appears flat with no contrast	Adjust the contrast. See "Contrast" on page 33.
Image appears washed out or dark.	<ul style="list-style-type: none"> • Check the projection lens to see if it needs cleaning. • Adjust the brightness. See "Brightness" on page 33.

Problem	Solution
Image is "noisy" or streaked.	<p>Try these steps in this order.</p> <ol style="list-style-type: none"> 1. Deactivate the screen saver on your computer. 2. Turn Auto Image off and then back on again. See “Auto Image” on page 36. 3. Turn Auto Image off and adjust the synchronization and tracking manually to find an optimal setting. See “Manual Sync (computer source only)” on page 37 and “Manual Tracking (computer source only)” on page 37. <ul style="list-style-type: none"> • Try connecting to another computer. The problem could be with your computer's video card.
Image is wider at the top or bottom of the screen.	This keystone effect is caused by the projection angle not being perpendicular to the screen. Adjust the keystone. See “Keystone (computer source only)” on page 35.
Image is wider at one side than the other	Make sure the projector is at a 90 degree angle to the screen.
Projected colors don't match the computer or video source colors.	<p>Use the KODAK Image Manager to select a setting that is more acceptable.</p> <p><i>Important: The KODAK Image Manager settings work best if you select Reset from the Adjust Tab each time before selecting an Image Manager setting.</i></p> <p>If further adjustment is needed, optimize the brightness, tint, color and contrast from the Image Menu.</p>

Lamp

Problem	Cause and Solution
No light is coming from the lamp.	<ul style="list-style-type: none"> • Make sure that the power cord is properly connected to a fully functional AC electric outlet. The Power light blinks when the power is connected but the projector is not turned on. The Power light is a steady green when the lamp is running. • Make sure that the power cord is properly connected to the projector. • Make sure that you have removed the lens cap on the projector lens at the front of the projector. • Make sure you have pressed the Power button and the Power light is a steady green. • Check the projector's lamp to make sure that it is securely connected to the projector. • Make sure that the lamp module door is fully closed. • Make sure that the cable connectors do not have any bent pins. • Replace the lamp.
Lamp shuts off.	<ul style="list-style-type: none"> • A minor power surge may cause the lamp to shut off. Unplug the projector, wait at least a minute, then plug it back in. • Make sure the vents are not blocked. • Replace the lamp module.
Lamp seems to be getting dimmer	<p>The lamp begins to lose brightness when it has been in use for a long time. Replace the lamp as described in “Replacing the Projection Lamp” on page 46.</p>

Image Source

Problem	Cause and Solution
The S-Video image source does not appear.	Some inexpensive cables are not compatible with the projector. Be sure to use a high quality cable.
Only the start-up screen appears and not the image from the image source.	<ul style="list-style-type: none"> • Verify that the cables are connected correctly. • Verify that the proper image source is connected and that it is selected on the Setup tab of the menus. • Make sure that the image source is turned on. • Turn off everything and power up again in the proper order. • Make sure that your laptop's external video port is turned on. See the computer manual for details. • Make sure your computer's video board is installed and configured correctly. • Make sure your computer has a compatible video board. The projector isn't CGA, EGA or SXGA compatible. • If you're using Windows 98: <ol style="list-style-type: none"> 1. Open "My Computer" icon, the Control Panel folder and then the Display icon. 2. Click the Settings tab. 3. Verify that the Desktop area is set to 1024x768 or less.
No image is displayed	<ul style="list-style-type: none"> • Make sure that you have removed the lens cap. • Make sure that the lamp is switched on.

Appendix A

Specifications

The KODAK DP2900 Digital Projector must be operated and stored within the temperature and humidity ranges specified.

Temperature

Operating 50 to 104° F (10 to 40° C)

Non-operating -4 to 158° F (-20 to 70° C)

Humidity

Operating and non-oper. 5% to 95% relative humidity, non-condensing

Dimensions

8.75 x 9.75 x 2.5 inches (22.2 x 24.8 x 6.4 cm)

Weight

4.8 lbs. (2.2 kg) unpacked

Altitude

Operating 0 to 10,000 feet (3,048 meters)

Non-operating 0 to 40,000 feet (12,192 meters)

Optics

Focus Range 4.9 - 16 feet (1.5-5 m)

Lamp

Type 120-watt VHP lamp

Input Power Requirements



100-120VAC 6A;50/60Hz
200-240VAC 3A; 50Hz

Audio Input

Input Impedance	10K ohm nominal, AC coupled
Maximum Input Voltage	$(L_{IN} + R_{IN})_{PEAK} < 4.5 \text{ V}$ for THD \leq 0.3% L_{IN} or $R_{IN} < 2.0 \text{ Vrms}$ for THD \leq 0.3%
Sensitivity	100 mV at 1 KHz for 88 dB SPL at 1 meter
Connector Type	3.5 mm (1/8 inch) stereo phone mini

Appendix B

Portable and Laptop Activation Chart

Many laptop computers do not automatically turn on their external video port when a projector is connected. Activation commands for some laptop computers are listed in the following table. (If your computer is not listed or the given command does not work, refer to the computer's documentation for the appropriate command.) On many laptops, the activation function key is labeled with an icon, for example / or the text CRT/LCD.

Note: Usually, pressing the key commands once activates the external video port, pressing it again activates both the external and internal ports, and pressing it a third time activates the internal port. Refer to your computer documentation for details on your specific model.

Computer	Key command to activate port	Key command to de-activate port
Acer	Ctrl-Alt-Esc (for setup)	Ctrl-Alt-Esc (for setup)
AST* **	FN-D or Ctrl-D	FN-D or Ctrl-D
	Ctrl-FN-D	Ctrl-FN-D
	FN-F5	FN-F5
	type from A:/IVGA/ CRT FN-F12	type from A:/IVGA/ CRT FN-F12

Computer	Key command to activate port	Key command to de-activate port
AMS	FN-F2	FN-F2
AMT	setup screen	setup screen
AT&T	FN-F3 FN-F6	FN-F3 FN-F6
Advanced Logic Research	Ctrl-Alt-V	Ctrl-Alt-V
Altima	Shift-Ctrl-Alt-C setup VGA/ Conf.Simulscan	Shift-Ctrl-Alt-L setup VGA/ Conf.Simulscan
Ambra**	FN-F12 FN-F5 F2/Choose Option/ F5	FN-F12 FN-F5 F2/Choose Option/ F5
Amrel* **	setup menu Shift-Ctrl-D	setup menu Shift-Ctrl-D
Apple	see Mac Portable and Mac PowerBook	
Aspen	automatic	automatic
Award	FN-F6	FN-F6

Computer	Key command to activate port	Key command to de-activate port
BCC*	automatic	reboot computer
Bondwell	LCD or CRT options after bootup	reboot for LCD or CRT options to appear
Chaplet**	setup screen FN-F6 FN-F4	setup screen FN-F6 FN-F4
Chembook	FN-F6	FN-F6
Commax	Ctrl-Alt-#6	Ctrl-Alt-#5
Compaq* **	Ctrl-Alt-< FN-F4 automatic mode/? (for setup option)	Ctrl-Alt-> FN-F4 automatic mode/? (for setup option)
Compuadd* **	automatic Alt-F for screen setup option	automatic Alt-F for screen setup option
Data General	Ctrl-Alt-Command	Ctrl-Alt-Command

Computer	Key command to activate port	Key command to de-activate port
Data General Walkabout	2 CRT/X at DOS prompt	reboot
Datavue	Ctrl-Shift-M	Ctrl-Shift-M
DEC**	FN-F5 FN-F4	FN-F5 FN-F4
Dell**	Ctrl-Alt-< Ctrl-Alt-F10 FN-F8 (CRT/LCD) FN-D FN-F12	Ctrl-Alt-> Ctrl-Alt-F10 FN-F8 FN-D FN-F12
Digital*	automatic FN-F2	reboot FN-F2
Dolch	dip switch to CRT	dip switch to LCD
Epson	dip switch to CRT	dip switch to LCD
Everex*	setup screen option	setup screen option
For-A	Ctrl-Alt-Shift-C	Ctrl-Shift-Alt-L
Fujitsu	FN-F10	

Computer	Key command to activate port	Key command to de-activate port
Gateway	FN-F3 FN-F1/FN-F1 again simultaneous	FN-F3 FN-F1
Grid* **	FN-F2, choose auto or simultaneous Ctrl-Alt-Tab	FN-F2 Ctrl-Alt-Tab
Hitachi	FN-F7	FN-F7
Honeywell	FN-F10	FN-F10
Hyundai	setup screen option	setup screen option
IBM 970*	automatic	warm reboot
IBM ThinkPad**	reboot, enter setup menu FN-F7, select choice from setup menu FN-F1, select choice FN-F5, select choice PS/2 SC select choice (CRT, LCD, etc.)	FN-F2

Computer	Key command to activate port	Key command to de-activate port
Infotel	FN-F12	FN-F12
Kaypro	boot up, monitor plugged in	unplug monitor
Kris Tech	FN-F8	FN-F8
Leading Edge	FN-T	FN-T
Mac Portable 100	no video port: not compatible	
Mac PowerBook 140, 145, 150, 170	no video port: requires a 3rd-party interface	
160, 165, 180, 520, 540, 5300 210, 230, 250, 270, 280, 2300	Control Panel folder, PowerBook Display folder; Activate Video Mirroring	warm reboot
	requires Apple Docking Station or Mini Dock	
Magitronic	FN-F4	FN-F4
Mastersport	FN-F2	FN-F1
Micro Express*	automatic	warm reboot

Computer	Key command to activate port	Key command to de-activate port
Micron	FN-F2	FN-F2
Microslate*	automatic	warm reboot
Mitsubishi	SW2 On-Off-Off-Off	SW2 Off-On-On-On
NCR	setup screen option	setup screen option
NEC* **	setup screen option CRT at the DOS prompt FN-F3	setup screen option LCD at the DOS prompt FN-F3
Olivetti*	automatic FN-O/*	automatic FN-O/*
Packard Bell* **	FN-F0 Ctrl-Alt-<	FN-F0 Ctrl-Alt->
Panasonic	FN-F2	FN-F2
Prostar	Ctrl-Alt-S at bootup	Ctrl-Alt-S at bootup
Samsung*	setup screen option	setup screen option
Sanyo	setup screen option	setup screen option

Computer	Key command to activate port	Key command to de-activate port
Sharp	dip switch to CRT	dip switch to LCD
Sun SPARC-Dataview	Ctrl-Shift-M	Ctrl-Shift-M
Tandy**	Ctrl-Alt-Insert setup screen option	Ctrl-Alt-Insert setup screen option
Tangent	FN-F5	FN-F5
Texas Instruments*	setup screen option	setup screen option
Top-Link* **	setup screen option FN-F6	setup screen option FN-F6
Toshiba* **	Ctrl-Alt-End FN-End FN-F5 setup screen option	Ctrl-Alt-Home FN-Home FN-F5 setup screen option
Twinhead*	FN-F7 FN-F5	FN-F7 FN-F5

Computer	Key command to activate port	Key command to de-activate port
	Automatic	Automatic
WinBook	Ctrl-Alt-F10	Ctrl-Alt-F10
Wyse	software driven	software driven
Zenith**	FN-F10 FN-F2 FN-F1	FN-F10 FN-F2 FN-F1
Zeos**	Ctrl-Shift-D FN-F1	Ctrl-Shift-D FN-F1

* These manufacturers have models that automatically send video to the external CRT port when some type of display device is attached.

** These manufacturers offer more than one key command depending on the computer model

Appendix C

Using Video Mirroring with a PowerBook Computer

When you turn video mirroring (called SimulScan in newer PowerBooks—see below) on, the projector displays the same information that appears on your PowerBook's built-in screen. When video mirroring is off, the projector acts like a separate display.

To turn on video mirroring for the first time:

1. Open the Monitors control panel; click on Monitor 2.
2. Set the number of colors you want.
3. Open the Control Strip, then click on the monitor icon.
4. Select "Turn Video Mirroring On."

Now you can turn video mirroring on and off from the Control Strip without having to open the Monitors control panel again.

When using video mirroring and high color graphics such as slide shows, the projected image occasionally might turn black and white. If this happens, perform the following steps:

1. Turn off video mirroring.
2. Open the Monitors control panel.
3. Move the white menu bar to Monitor 2 to set the projector as the primary monitor.
4. Restart the PowerBook.

Using SimulScan

Some newer PowerBooks display images on an external monitor or projector differently than previous ones. When using SimulScan, the projector displays the same information that appears on your PowerBook

To select SimulScan:

1. Open the Control Panel, then double-click Monitors and Sound.
2. In the Resolution list, choose the SimulScan mode, then click OK.
3. If this changes your display settings, a dialog box appears. Click OK to confirm the change.

Appendix D

Projected Image Size

Use the graph and tables to help you determine projected image sizes.

Note: Image sizes shown are based on a digital keystone correction of zero.

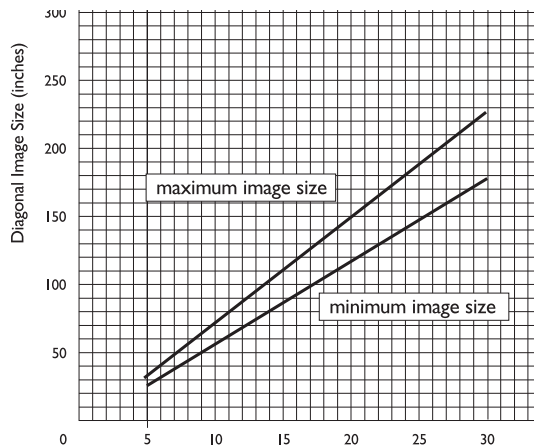

Image Size, Width and Height for DP2900 maximum image size

Distance to Screen (feet)	Diagonal (feet)	Width (feet)	Height (feet)
4.9	3.2	2.6	1.9
8	5.2	4.2	3.1
12	7.8	6.3	4.7
16	10.4	8.3	6.3
20	13.0	10.4	7.8
30	19.5	15.6	11.7

Image Size, Width and Height for DP2900 minimum image size

Distance to Screen (feet)	Diagonal (feet)	Width (feet)	Height (feet)
4.9	2.5	2.0	1.5
8	4.1	3.3	2.5
12	6.2	4.9	3.7
16	8.2	6.6	4.9
20	10.3	8.2	6.2
30	15.4	12.3	9.2

Index

A

- activation commands for laptops 57
- adjusting
 - brightness 33
 - color 34
 - contrast 33
 - height 26
 - tint 34
 - volume 31, 35
- altitude limits 55
- assistance 14
- audio cable, connecting 19
- Audio menu 35
- Audio menu options
 - Volume 35
- Auto Source Select 39

B

- battery use ix
- Blank Screen 34
- brightness, adjusting 33
- buttons on keypad
 - Lamp on/off 30
 - Menu 30
 - Source 30
 - Standby 31
 - Volume 31

C

- cables
 - audio 19
 - composite video 20
 - M1-DA analog 12
 - M1-DA analog computer cable 18
 - S-video 20

- cleaning the projection lens 45
- color, adjusting 34
- compatibility
 - IBM-compatible 11
 - Macintosh 11
- composite video cable
 - connecting 20
- computer cable, analog 12
- computers, compatible 11
- connecting
 - audio cable 19
 - IBM-compatible computer 18
 - power cord 22
 - video player 20–21
- contrast, adjusting 33
- Controls menu options
 - Auto Source Select 39
 - Default Source 39
 - Display Messages 39
 - Display Startup Screen 40
 - Plug and Play 39
 - Rear Projection 38
 - Standby Time 38
 - Video Standard 38
- customer support numbers 15

D

- Default Source 39
- Display menu 33
- Display menu options
 - Blank Screen 34
 - Brightness 33
 - Color 34
 - Contrast 33
 - Reset All 34

- Tint 34
- Display Messages 39
- Display Startup Screen 40
- displaying
 - on-screen menus 30
 - startup screen 40
 - status messages 39

E

- elevator button/foot 26

F

- foot 26
- fuzzy lines 37

H

- HDTV 11, 20, 36
- help
 - customer support numbers 15
 - fax 14

I

- IBM-compatible computers
 - compatibility 11
 - connecting 18
- image
 - adjusting 25
 - centering 37
 - focusing 26
 - fuzzy lines 37
 - quality ??–53
 - resolution 11
 - reversed 38
 - size 17, 69
 - zooming 26
- Image menu 35
- Image menu options

- Auto Image 36
- Horiz. Position 37
- Keystone 35
- Manual Sync 37
- Manual Tracking 37
- Resize 36
- Vert. Position 37

K

- keypad
 - using 29
- keystone correction 35

L

- lamp
 - replacing 46
- lamp hour counter 41
- Lamp on/off button 30
- Language menu 40
- language, selecting for menus 40
- laptop activation sequence 57
- laptop computers
 - compatibility 18
 - connecting IBM-compatible 18
- lens
 - cleaning 45

M

- M1-DA analog computer cable 12, 18
- Macintosh computers
 - compatibility 11
 - connecting 19
- Menu button 32
- menus. See on-screen menus
- mouse, connecting 19

N

NTSC video 38

O

on-screen menus

- Audio menu 35
- changing language of 40
- changing menu functions 32
- Controls menu 38
- Display menu 33
- displaying 32
- Image menu 35
- Language menu 40
- Status menu 41

overscan 35

P

PAL video 34, 38

Plug and Play 39

positioning projector viii

power cord

- connecting 22

power up sequence 23

PowerBook video mirroring 67

R

rear projection 38

remote control

- replacing the batteries 49
- using 27, 29

replacing projection lamp module 46

re-positioning image 37

resetting adjustments 34

resizing video 36

resolution 11

S

safety guidelines vii

screen

- projecting behind 38

- sizes 17, 69

SECAM video 34, 38

security lock 49

service numbers 15

setting up 17

SimulScan, with PowerBooks 68

Source button 30

specifications 55

Standby

- button 31

- Time 38

startup screen 40

Status menu 41

support numbers 15

S-video

- connecting 20

T

Technical Support

- information to have on hand
before you call 14

technical support 14

temperature limits 55

tint, adjusting 34

turning off the projector 23

U

USB mouse 19

V

vertical lines 37

video

- mirroring 67

resizing 36

standards 38

Volume buttons 31

volume, adjusting 31

W

widescreen video 36

Z

zooming the image 26

Warranty

WARRANTY TIME PERIOD

Kodak warrants the KODAK DP2900 Digital Projector (excluding lamps, which have an initial 90-day warranty from the date of purchase) to be free from malfunctions and defects in both materials and workmanship for two years from the date of purchase.

WARRANTY REPAIR COVERAGE

This warranty will be honored within the geographical location that the product was purchased.

If the equipment does not function properly during the warranty period due to defects in either materials or workmanship, Kodak will, at its option, either repair or replace the equipment without charge, subject to the conditions and limitations stated herein. Such repair will include all labor as well as any necessary adjustments and/or replacement parts.

If replacement parts are used in making repairs, these parts may be remanufactured, or may contain remanufactured materials. If it is necessary to replace the entire system, it may be replaced with a remanufactured system.

Kodak will also provide telephone assistance during the warranty period.

LIMITATIONS

WARRANTY SERVICE WILL NOT BE PROVIDED WITHOUT DATED PROOF OF PURCHASE.

THIS WARRANTY BECOMES NULL AND VOID IF YOU FAIL TO PACK YOUR DIGITAL PROJECTOR IN A MANNER CONSISTENT WITH THE ORIGINAL PRODUCT PACKAGING AND DAMAGE OCCURS DURING PRODUCT SHIPMENT.

THIS WARRANTY DOES NOT COVER: CIRCUMSTANCES BEYOND KODAK'S CONTROL; SERVICES OR PARTS TO CORRECT PROBLEMS RESULTING FROM THE USE OF ATTACHMENTS, ACCESSORIES, OR ALTERATIONS NOT MARKETED BY KODAK; SERVICE REQUIRED AS THE RESULT OF UNAUTHORIZED MODIFICATIONS OR SERVICE; MISUSE, ABUSE; FAILURE TO FOLLOW KODAK'S OPERATING, MAINTENANCE, OR REPACKAGING INSTRUCTIONS; OR FAILURE TO USE ITEMS SUPPLIED BY KODAK (SUCH AS ADAPTORS AND CABLES).

KODAK MAKES NO OTHER WARRANTIES, EXPRESS, IMPLIED, OR OF MERCHANTABILITY OR FITNESS FOR A PARTICULAR PURPOSE FOR THIS EQUIPMENT OR SOFTWARE.

REPAIR OR REPLACEMENT WITHOUT CHARGE ARE KODAK'S ONLY OBLIGATION UNDER THIS WARRANTY. KODAK WILL NOT BE RESPONSIBLE FOR ANY SPECIAL, CONSEQUENTIAL OR INCIDENTAL DAMAGES RESULTING FROM THE PURCHASE, USE, OR IMPROPER FUNCTIONING OF THIS EQUIPMENT REGARDLESS OF THE CAUSE. SUCH DAMAGES FOR WHICH KODAK WILL NOT BE RESPONSIBLE INCLUDE, BUT ARE NOT LIMITED TO, LOSS OF REVENUE OR PROFIT, DOWNTIME COSTS, LOSS OF USE OF THE EQUIPMENT, COST OF ANY SUBSTITUTE EQUIPMENT, FACILITIES OR SERVICES, OR CLAIMS OF YOUR CUSTOMERS FOR SUCH DAMAGES.

Depending on your geographical location, some limitations and exclusions may not apply.

Shipment of a unit from the customer to the kodak service center will be at the customer's expense.

This warranty is not transferable from the original purchaser of the equipment.

HOW TO OBTAIN SERVICE

Please refer to the Service and Support section of your User's Guide for the support hotline designated to your location.

When returning a digital projector for repair, the unit shall be packed in its original packing materials. A problem report should also be enclosed with the equipment. If the original packaging has been discarded or is not available, packing will be at the owner's expense.

The repaired or replaced unit will be shipped from Kodak within five business days from the date of the digital projector receipt at the service center.

Unless a specific Kodak warranty is communicated to the purchaser in writing by a Kodak company, no other warranty or liability exists beyond the information contained above, even though defect, damage, or loss may be caused by negligence or other act.

To obtain warranty repair service contact your local Kodak representative. For assistance, refer to the Service and Support information in the KODAK Digital Projector User's Guide.

Eastman Kodak Company
343 State Street
Rochester, New York 14650

Kodak is a trademark of
Eastman Kodak Company.



Free Manuals Download Website

<http://myh66.com>

<http://usermanuals.us>

<http://www.somanuals.com>

<http://www.4manuals.cc>

<http://www.manual-lib.com>

<http://www.404manual.com>

<http://www.luxmanual.com>

<http://aubethermostatmanual.com>

Golf course search by state

<http://golfingnear.com>

Email search by domain

<http://emailbydomain.com>

Auto manuals search

<http://auto.somanuals.com>

TV manuals search

<http://tv.somanuals.com>