



Everio

Easy Start Guide

Accessories

This easy start guide is designed to navigate you to using your new Everio quickly. Please refer to the owner's manual for a detailed listing of features.

For our online tutorials please visit:
<http://camcorder.jvc.com/tutorials.jsp>

SUPPLIED ACCESSORIES FOR THE CAMERA

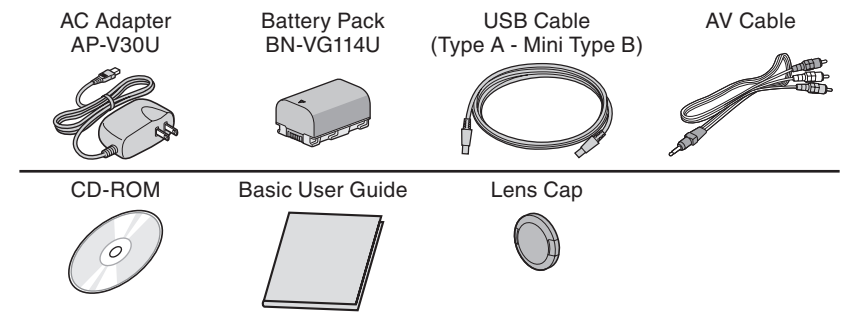

AVAILABLE ACCESSORIES FOR THE CAMERA

Product Name	Description
Battery Pack • BN-VG114U • BN-VG121U	• Provides a longer recording time than the battery pack that comes with this unit or it can also be used as a spare battery pack.
Battery Charger • AA-VG1U	• Enables the battery pack to be charged without using this unit.

To order any of these accessory please visit www.JVC.com or call 1-800-858-6442

TYPES OF USABLE SD CARDS

Memory Cards	Capacity	Video (UXP)		Still images (1920x1080/FINE)
		Video (UXP)	Still images (1920x1080/FINE)	
SDHC Cards <SD High-capacity>	Supports 4GB to 32GB	32GB	2hr.40min.	9999
		16GB	1hr.20min.	9999
		8GB	40min.	8330
		4GB	20min.	4140
SD Cards	Supports 256MB to 2GB	2GB	-	2100
		1GB	-	1030
		512MB	-	510
		256MB	-	260

Note: Operations are confirmed on the following SD cards.

Manufacturer	Panasonic, TOSHIBA, SanDisk, ATP
Video	Class 4 or higher compatible SDHC card (4 GB to 32 GB)
Still image	SD card (256 MB to 2 GB), SDHC card (4 GB to 32 GB)

• Using cards other than those specified above may result in recording failure or data loss.

CHARGING THE BATTERY

- Close the LCD to turn Off the Power
- Attach battery
- Connect AC adapter into DC Terminal

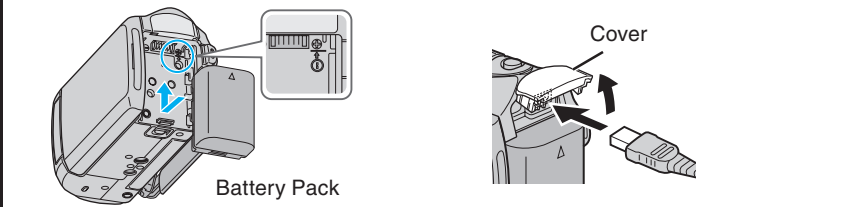

- Connect the AC adapter to outlet

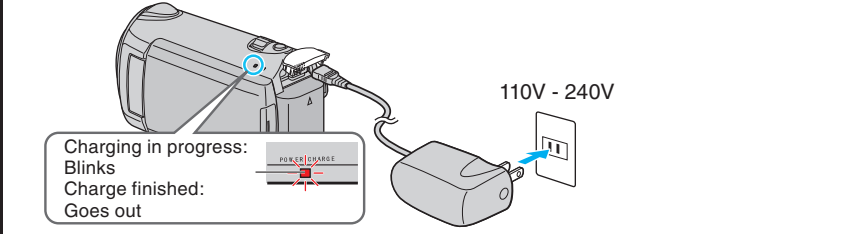

Battery Type	Charging Time	Continuous Recording	Actual Recording
BN-VG114U (Supplied)	2hr.30min.	1hr.45min.	1hr.
BN-VG121U	3hr.30min.	2hr.40min.	1hr.30min.

Note: The battery pack is not charged at the time of purchase

CAUTION

- Be sure to use JVC battery packs. If you use any other battery packs besides JVC battery packs, safety and performance cannot be guaranteed.

INSERTING THE SD CARD*

- Open the card slot cover
• Turn off the power before inserting or removing a card
- Install an SD Card

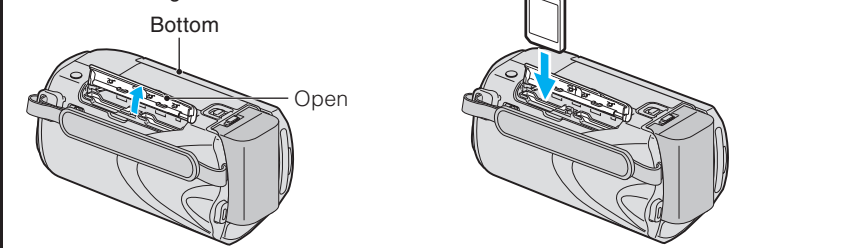

* SD card not included

Download from Www.Somanuals.com. All Manuals Search And Download.



Customer Service
 TOLL FREE: 1-800-252-5722

For our online tutorials please visit:
<http://camcorder.jvc.com/tutorials.jsp>

Register your EVERIO online at:
REGISTER.JVC.COM
 and receive a special offer.

JVC U.S.A.
 A Division of JVC Americas Corp.
 1700 Valley Road, Wayne, NJ 07470
www.jvc.com

C0S4 0110ASR-SW-VM

RECORDING FILES

- Open the LCD monitor to turn on the unit.
• Remove the lens cap.
- Press button to select the recording mode.
- Press button to select the video or still image mode.

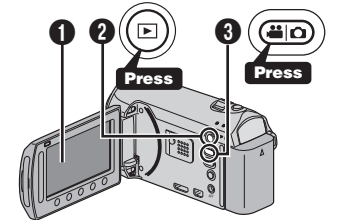

The Mode will be displayed in the LCD

VIDEO RECORDING

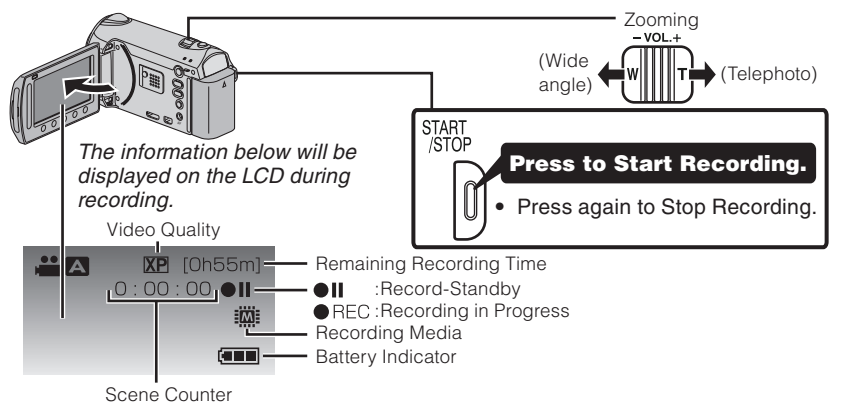

STILL IMAGE RECORDING

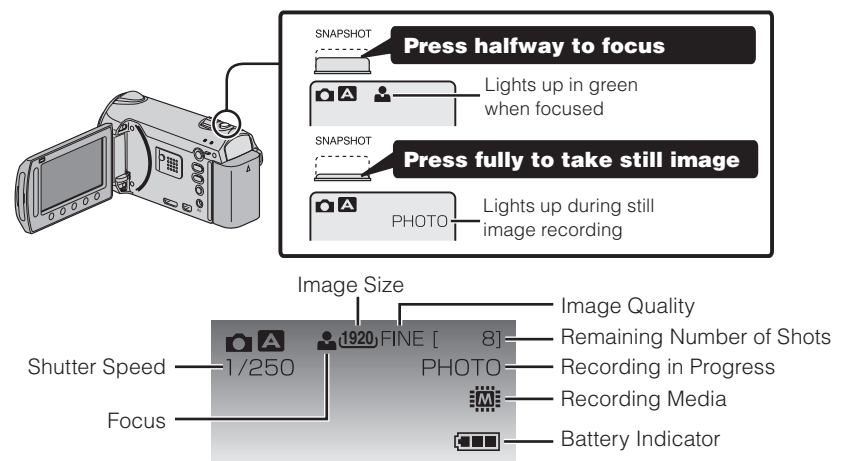

PLAYBACK VIDEOS

- Open the LCD monitor to turn on the unit.
- Press button to select the playback mode.
- Press button to select the video or still image mode.

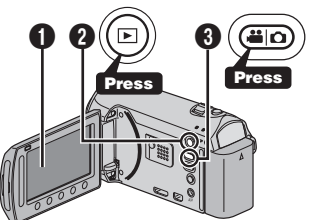

- Select from the index screen (highlight thumbnails) using the Slider.
- Touch the button.

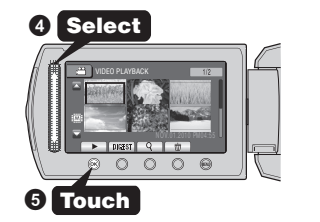

PLAYBACK ON A TV

- Preparation:
- Turn off both camera and TV.
 - To connect using the HDMI mini connector
 • When connecting to a 1080p compatible TV, set [HDMI OUTPUT] to [AUTO 1].

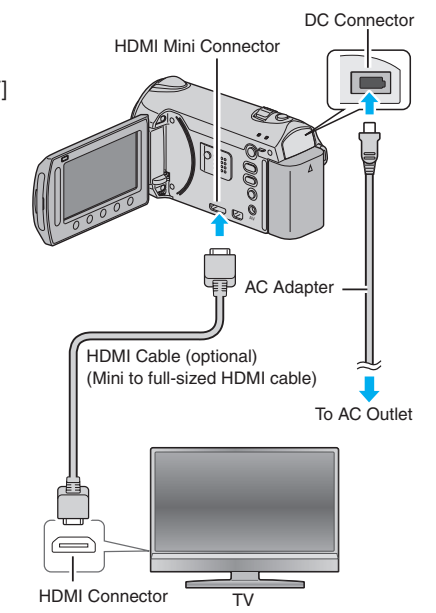

Recording Files

Playing Back Files

PLAYBACK ON A TV (CONT.)

- **To connect using the COMPONENT/AV connector**
- Change the settings in [COMPONENT OUTPUT]/[VIDEO OUTPUT] according to the connection.

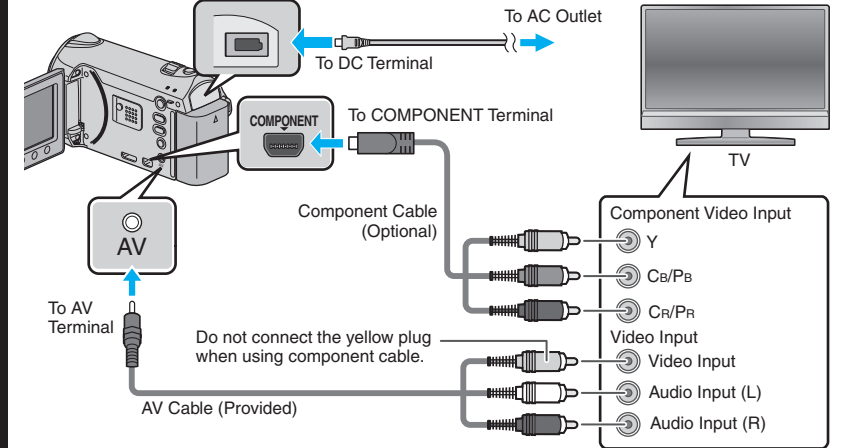

- **Playback Operation**
After the connection with TV is completed
- Turn on the camera and the TV.
 - Select the TV input switch.
 - Start playback on the camera.

Using the Slider and Operation Buttons

USING THE OPERATION BUTTONS

- A** To select an Operation icon appearing on the left side, touch the portion of the Slider next to Operation icon.
- B** To select an Operation icon appearing at the bottom of the screen, touch the buttons underneath them.

CHANGING MENU SETTINGS

- Select an item from the menu screen.
- Touch the button.
 - Slide your finger up and down on the Slider.
 - Touch the button.

How to Install Software

PC USERS

- Preparation:**
- Load the provided CD-ROM into the PC.
 - In Windows Vista, the auto play dialog box appears.

- Click [Easy Installation]. Follow the on-screen instructions.
- Click [Next].
- Click [Finish].

Everio Software Setup
Easy Installation
Custom Installation
User License Agreement

Everio MediaBrowser icons are created on the desktop.

Mac USERS

- You may use the software supplied with the Mac Computer to view and edit files from the Everio Camera.
- Connect the Everio Camera to the Mac Computer using a USB Cable.

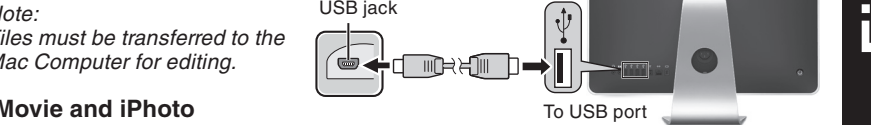

- iMovie and iPhoto**
- You can import files from this unit to a PC using Apple's iMovie '09 (video) or iPhoto (still image). To verify the system requirements, select "About This Mac" from the Apple menu. You can determine the operating system version, processor and amount of memory.
- Note:**
- For the latest information on iMovie or iPhoto, refer to the Apple website.
 - For details on how to use iMovie or iPhoto, refer to the help file of the respective software.
 - There is no guarantee that the operations will work with all computer environments.

File Backup to Computer

FILE BACKUP (Windows PC)

- Preparation:**
- Install the Everio MediaBrowser software onto the PC.
 - Make sure that enough space is left in the PC's HDD.
 - Close the LCD monitor to turn off the camera.
 - Connect the camera to the PC with the USB cable.

- Open the LCD monitor to turn on the camera.
- Select [BACK UP] on the Camera. Everio MediaBrowser starts on the PC.

USB MENU
PLAYBACK ON PC
CREATE DISC
DIRECT DISC
UPLOAD
BACK UP
SET
QUIT

BACK-UP

Click [All volume in camcorder] and click [Next].

Click [Start]. The Backup starts.

Saving destination (PC)

Click

FILE BACKUP (Mac Computer)

- Preparation:**
- Make sure that enough space is left in the Mac's HDD.
 - Close the LCD Monitor to turn off the camera.
 - Connect the camera to the Mac Computer with the USB cable.

- Open the LCD monitor to turn on the camera.
- Select [PLAYBACK ON PC] on the Camera.

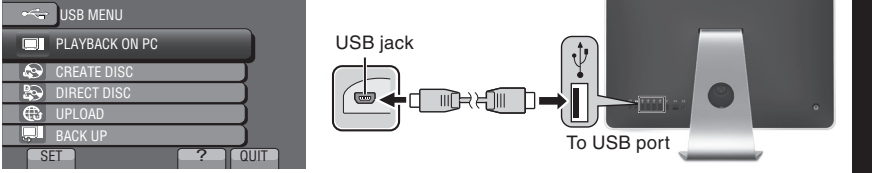

- Copy and Paste the files to the Mac Computer for backup.

HOW TO RECORD A FILE (VIDEO CLIP) FOR YouTube™

- Press the button to select the recording mode.
- Press the button to select the video mode.
- Press the UPLOAD button and switch on the function.
 - The mode switches between ON and OFF with every press.
- Press the START/STOP button to start recording.
 - Recording stops automatically after 10 minutes.

HOW TO UPLOAD A FILE(VIDEO CLIP) TO YouTube™ (Windows PC only)

- Uploading Videos**
- You can upload your videos to YouTube™ using the provided software "Everio MediaBrowser".
- Install the software on your PC and connect this unit to the PC.
- For details on how to use the software, refer to the help file. "Installing the Provided Software" "Connecting this Unit to PC"
- Trouble with Uploading Videos**
- Check if you have created an account with YouTube™.
- Trouble with Using the Provided Software Everio MediaBrowser**
- Consult the customer service center below.
- Pixela User Support Center

Region	Language	Phone #
USA and Canada	English	+1-800-458-4029 (toll-free)
Europe (UK, Germany, France, and Spain)	English/German/French/Spanish	+800-1532-4865 (toll-free)
Other Countries in Europe	English/German/French/Spanish	+44-1489-564-764
Asia (Philippines)	English	+63-2-438-0090
China	Chinese	10800-163-0014 (toll-free)

• For details on how to upload to YouTube™, refer to "MediaBrowser Help".

Help(H)
MediaBrowser Help(H) F1
Check the latest version online
Click For Latest Product Info
Version info(A)

TRADEMARK

- Windows® is either registered trademark or trademark of Microsoft Corporation in the United States and/or other countries.
- Macintosh is a registered trademark of Apple Inc.
- iMovie, iPhoto are trademarks of Apple Inc., registered in the U.S. and other countries.
- YouTube and the YouTube logo are trademarks and/or registered trademarks of YouTube LLC.

Recording Techniques

- Preparation**
- Always check available memory space and battery power in advance.
 - Make sure your battery is fully charged.
 - A spare battery may be useful.
- Stabilizing Your Picture**
- Try these tips to improve the image:
- Look for a place to sit down and take your video.
 - Look for something you can set your camera on.
 - Consider using a tripod or a monopod to further steady your video.
- Camera Movement**
- The most enjoyable and professional looking videos generally have very little camera movement
- Treat all movements as a special effect.
 - If you must move the camera, do it slowly.
- Zooming**
- As a general rule, your video will look better if you zoom the lens before you start your recording:
- Focus on the subject first, then begin recording.
 - If you must zoom during a recording, treat it as a special effect and zoom slowly.
- Exposure**
- Remember to shoot with the sun or the primary light source behind you.
 - Keeping the range of contrast in your scene to a reasonable level is the easiest way to improve the picture quality.
 - Pay special attention to objects in the LCD screen that appear very washed out or over exposed.
 - Making a simple change in how the camera is aimed or by zooming in slightly, you may reduce contrast to a reasonable range.
- Length of Recording**
- Many recordings are ruined by stopping the recording too soon and missing the best moment:
- Always try for at least a 10 second recording.
 - When in doubt, let the recording continue longer.
 - It is much easier to edit unneeded material later.

Free Manuals Download Website

<http://myh66.com>

<http://usermanuals.us>

<http://www.somanuals.com>

<http://www.4manuals.cc>

<http://www.manual-lib.com>

<http://www.404manual.com>

<http://www.luxmanual.com>

<http://aubethermostatmanual.com>

Golf course search by state

<http://golfingnear.com>

Email search by domain

<http://emailbydomain.com>

Auto manuals search

<http://auto.somanuals.com>

TV manuals search

<http://tv.somanuals.com>