



PROFESSIONAL

Model PMD671 User Guide

Portable Solid State Recorder

marantz®

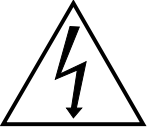
Warnings and Cautions

	CAUTION RISK OF ELECTRIC SHOCK DO NOT OPEN	
CAUTION: TO REDUCE THE RISK OF ELECTRIC SHOCK, DO NOT REMOVE COVER (OR BACK). NO USER-SERVICEABLE PARTS INSIDE. REFER SERVICING TO QUALIFIED SERVICE PERSONNEL.		

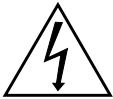

The lightning flash with arrowhead symbol within an equilateral triangle is intended to alert the user to the presence of uninsulated "dangerous voltage" within the product's enclosure that may be of sufficient magnitude to constitute a risk of electric shock to persons.



The exclamation point within an equilateral triangle is intended to alert the user to the presence of important operating and maintenance (servicing) instructions in the literature accompanying the product.

WARNING

**TO REDUCE THE RISK OF FIRE OR ELECTRIC SHOCK,
DO NOT EXPOSE THIS APPLIANCE TO RAIN OR MOISTURE.**

CAUTION: TO PREVENT ELECTRIC SHOCK, MATCH WIDE BLADE OF PLUG TO WIDE SLOT, FULLY INSERT.

ATTENTION: POUR ÉVITER LES CHOC ÉLECTRONIQUES, INTRODUIRE LA LAME A PLUS LARGE DE LA FICHE DANS LA BORNE, CORRESPONDANTE DE LA PRISE ET POUSSER JUSQU'A FOND.

NOTE TO CATV SYSTEM INSTALLER:

This reminder is provided to call the CATV (Cable-TV) system installer's attention to Article 820-40 of the NEC, which provides guidelines for proper grounding and, in particular, specifies that the cable ground shall be connected to the grounding system of the building, as close to the point of cable entry as practical.

NOTE:

This equipment has been tested and found to comply with the limits for a Class B digital device, pursuant to Part 15 of the FCC Rules. These limits are designed to provide reasonable protection against harmful interference in a residential installation. This equipment generates, uses and can radiate radio frequency energy and, if not installed and used in accordance with the instructions, may cause harmful interference to radio communications. However, there is no guarantee that interference will not occur in a particular installation. If this equipment does cause harmful interference to radio or television reception, which can be determined by turning the equipment off and on, the user is encouraged to try to correct the interference by one or more of the following measures:

- Reorient or relocate the receiving antenna.
- Increase the separation between the equipment and receiver.
- Connect the equipment into an outlet on a circuit different from that to which the receiver is connected.
- Consult the dealer or an experienced radio/TV technician for help.

NOTE:

Changes or modifications may cause this unit to fail to comply with Part 15 of the FCC Rules and may void the user's authority to operate the equipment.

This Class B digital apparatus complies with Canadian ICES-003.

Cet appareil numérique de la Classe B est conforme à la norme NMB-003 du Canada.

Important Safety Instructions

READ BEFORE OPERATING EQUIPMENT

This product was designed and manufactured to meet strict quality and safety standards. There are, however, some installation and operation precautions which you should be particularly aware of.

1. Read these instructions.
2. Keep these instructions.
3. Heed all warnings.
4. Follow all instructions.
5. Do not use this apparatus near water.
6. Clean only with dry cloth.
7. Do not block any ventilation openings. Install in accordance with the manufacturer's instructions.
8. Do not install near any heat sources such as radiators, heat registers, stoves, or other apparatus (including amplifiers) that produce heat.
9. Do not defeat the safety purpose of the polarized or grounding-type plug. A polarized plug has two blades with one wider than the other. A grounding type plug has two blades and a third grounding prong. The wide blade or the third prong are provided for your safety. If the provided plug does not fit into your outlet, consult an electrician for replacement of the obsolete outlet.
10. Protect the power cord from being walked on or pinched particularly at plugs, convenience receptacles, and the point where they exit from the apparatus.
11. Only use attachments/accessories specified by the manufacturer.
12. Use only with the cart, stand, tripod, bracket, or table specified by the manufacturer, or sold with the apparatus. When a cart is used, use caution when moving the cart/apparatus combination to avoid injury from tip-over.
13. Unplug this apparatus during lightning storms or when unused for long periods of time.
14. Refer all servicing to qualified service personnel. Servicing is required when the apparatus has been damaged in any way, such as power-supply cord or plug is damaged, liquid has been spilled or objects have fallen into the apparatus, the apparatus has been exposed to rain or moisture, does not operate normally, or has been dropped.



Additional Safety Information!

- This product should not be placed in a built-in installation such as a bookcase or rack unless proper ventilation is provided or the manufacturer's instructions have been adhered to.
- Apparatus shall not be exposed to dripping or splashing and that no objects filled with liquids, such as vases, shall be placed on the apparatus.
- When the switch is in the OFF position, the apparatus isn't completely switched-off from the MAINS.

WARNINGS

- Do not expose the equipment to rain or moisture.
- Do not remove the cover from the equipment.
- Do not insert anything into the equipment through the ventilation holes.
- Do not handle the mains lead with wet hands.
- Do not cover the ventilation with any items such as tablecloths, newspapers, curtains, etc.
- No naked flame sources, such as lighted candles, should be placed on the equipment.
- When disposing of used batteries, please comply with governmental regulations or environmental public instruction's rules that apply in your country or area.
- Do not place anything about 0.1 meter above the top panel.
- Make a space of about 0.1 meter around the unit.
- No objects filled with liquids, such as vases, shall be placed on the apparatus.
- When the switch is in the OFF position, the equipment is not completely switched off from MAINS.

When setting up the recorder ensure that:

- it will not be exposed to interference from external equipment.
- it will not be exposed to electrostatic discharges.
- it will not be exposed to direct sunlight.
- heavy objects are not placed on the recorder.

Copyright

Recording and playback of any material may require consent. For further information refer to the following US ordinances:

- Copyright act of 1956
- Dramatic and Musical Performance Act 1958
- Performers Protection Acts 1963 and 1972
- any subsequent statutory enactments and orders

CE MARKING

- English**
The PMD671 is in conformity with the EMC directive and low-voltage directive.
- Français**
Le PMD671 est conforme à la directive EMC et à la directive sur les basses tensions.
- Deutsch**
Das Modell PMD671 entspricht den EMC-Richtlinien und den Richtlinien für Niederspannungsgeräte.
- Nederlands**
De PMD671 voldoet aan de EMC eisen en de vereisten voor laag-voltage.
- Español**
El PMD671 está de acuerdo con las normas EMC y las relacionadas con baja tensión.
- Italiano**
Il PMD671 è conforme alle direttive CEE ed a quelle per i bassi voltaggi.
- Português**
O PMD671 conforma com as diretrizes EMC e de baixa voltagem.
- Svenska**
PMD671 är tillverkad i enlighet med EMC direktiven och direktiven för lågvoltsutrustning.

English

WARNINGS

- Do not expose the equipment to rain or moisture.
- Do not remove the cover from the equipment.
- Do not insert anything into the equipment through the ventilation holes.
- Do not handle the mains lead with wet hands.
- Do not cover the ventilation with any items such as tablecloths, newspapers, curtains, etc.
- No naked flame sources, such as lighted candles, should be placed on the equipment.
- When disposing of used batteries, please comply with governmental regulations or environmental public instruction's rules that apply in your country or area.
- Do not place anything about 0.1 meter above the top panel.
- Make a space of about 0.1 meter around the unit.
- No objects filled with liquids, such as vases, shall be placed on the apparatus.
- When the switch is in the OFF position, the equipment is not completely switched off from MAINS.

Français

AVERTISSEMENTS

- Ne pas exposer l'appareil à la pluie ni à l'humidité.
- Ne pas essayer de retirer le boîtier de l'appareil.
- Ne rien insérer dans l'appareil par les orifices de ventilation.
- Ne pas manipuler le cordon d'alimentation avec les mains mouillées.
- Ne pas recouvrir les ouïes de ventilation avec un objet quelconque comme une nappe, un journal, un rideau, etc.
- Ne placer aucune source de flamme nue, comme une bougie allumée, sur l'appareil.
- Pour mettre au rebut les piles usées, respecter les lois gouvernementales ou les règlements officiels concernant l'environnement qui s'appliquent à votre pays ou région.
- Ne placez aucun objet à moins de 0,1 mètre environ du panneau supérieur.
- Veiller à ce qu'aucun objet ne soit à moins de 0,1 mètre des côtés de l'appareil.
- Aucun objet rempli de liquide, un vase par exemple, ne doit être placé sur l'appareil.
- Lorsque l'interrupteur est sur la position OFF, l'appareil n'est pas complètement déconnecté du SECTEUR (MAINS).

Deutsch

WARNHINWEISE

- Das Gerät nicht Regen oder Feuchtigkeit aussetzen.
- Die Abdeckung nicht vom Gerät abnehmen.
- Keine Gegenstände durch die Belüftungsschlitze stecken.
- Das Netzkabel nicht mit feuchten oder nassen Händen anfassen.
- Decken Sie die Lüftungsöffnungen nicht mit einem Tischtuch, einer Zeitung, einem Vorhang usw. ab.
- Es dürfen keine Gegenstände mit offener Flamme, wie etwa brennende Kerzen, auf dem Gerät aufgestellt werden.
- Beachten Sie bei der Entsorgung der verbrauchten Batterien alle geltenden lokalen und überregionalen Regelungen.
- Darauf achten, daß über dem Gerät ein Freiraum von mindestens 0,1 meter vorhanden ist.
- Auf allen Geräteseiten muß ein Zwischenraum von ungefähr 0,1 meter vorhanden sein.
- Auf das Gerät dürfen keine mit Flüssigkeiten gefüllte Behälter, wie etwa eine Vase, gestellt werden.
- Wenn der Schalter ausgeschaltet ist (OFF-Position), ist das Gerät nicht vollständig vom Stromnetz (MAINS) abgetrennt.

Nederlands

WAARSCHUWINGEN

- Stel het apparaat niet bloot aan regen of vocht.
- Verwijder de afdekplaat van het apparaat niet.
- Duw niets door de ventilatieopeningen in het apparaat.
- Raak het netsnoer niet met natte handen aan.
- Bedek de ventilatieopeningen niet met enige voorwerpen, zoals tafelkleden, kranten, gordijnen, enz.
- Plaats geen brandende voorwerpen, zoals kaarsen, op het apparaat.
- Volg bij het weggooien van verbruikte batterijen de overheidswetgeving of milieuvorschriften op die van kracht zijn in het land of de regio waarin u zich bevindt.
- Zorg dat er tenminste 0,1 meter vrije ruimte boven het toestel is.
- Zorg dat er 0,1 meter vrije ruimte rond het toestel is.
- Plaats geen voorwerpen met een vloeistof erin, zoals een bloemenvaas, op het apparaat.
- Als de schakelaar op OFF staat, is het apparaat niet volledig losgekoppeld van de netspanning (MAINS).

Español

ADVERTENCIAS

- No exponga el equipo a la lluvia ni a la humedad.
- No extraiga la tapa del equipo.
- No introduzca nada en el interior del equipo a través de los orificios de ventilación.
- No maneje el cable de alimentación con las manos mojadas.
- No cubra la ventilación con objetos como manteles, periódicos, cortinas, etc.
- No deben colocarse sobre el equipo elementos con fuego, por ejemplo velas encendidas.
- Cuando se eliminen baterías usadas, deben cumplirse las reglamentaciones oficiales o las normas de protección medioambiental aplicables en su país o en su zona.
- No ponga nada a menos de 0,1 metro por encima del panel superior.
- Deje un espacio de unos 0,1 metro alrededor de la unidad.
- No se deben colocar sobre el aparato recipientes que contengan líquidos, como por ejemplo jarrones.
- Cuando el interruptor está en la posición OFF, el equipo no está completamente desconectado de la alimentación MAINS.

Italiano

AVVERTENZE

- Non esporre l'apparecchio alla pioggia o all'umidità.
- Non rimuovere il coperchio dell'apparecchio.
- Non introdurre oggetti all'interno dell'apparecchio attraverso i fori di ventilazione.
- Non toccare il cavo di alimentazione con le mani bagnate.
- Non coprire le fessure di ventilazione con tovaglie, giornali, tende od oggetti analoghi.
- Non posare sull'apparecchio sorgenti di fiamme scoperte quali candele accese.
- Smaltire le pile usate in conformità alle norme governative o disposizioni ambientali vigenti nel proprio paese o zona.
- Non posare alcun oggetto sopra il pannello superiore, lasciando libero uno spazio di circa 0,1 m.
- Lasciare 0,1 metro liberi tutto intorno l'unità.
- Non mettere sull'apparecchiatura alcun contenitore di liquido, come ad esempio dei vasi.
- Quando l'interruttore è nella posizione OFF, l'apparecchiatura non è completamente scollegata da MAINS.

Português

ADVERTÊNCIAS

- Não exponha o equipamento à chuva nem à humidade.
- Não retire a tampa do equipamento.
- Não atire nada para dentro do equipamento através dos orifícios de ventilação.
- Não manuseie o cabo de alimentação com as mãos molhadas.
- Não cobrir os orifícios de ventilação com objectos tais como toalhas de mesa, jornais, cortinas, etc.
- Não colocar chamas abertas tais como velas acesas, sobre o aparelho.
- Ao deitar foras as pilhas usadas, favor observar os regulamentos governamentais ou as regras com respeito ao meio ambiente que se aplicam no seu país ou área de residência.
- Deixar um espaço completamente livre de cerca de 0,1 metro acima do painel superior.
- Deixar um espaço de cerca de 0,1 metro ao redor do aparelho.
- Não colocar recipientes com água, tal como vasos, sobre o aparelho.
- Quando o interruptor está na posição OFF, o equipamento não fica totalmente desligado de MAINS.

Svenska

VARNINGAR

- Utsätt inte utrustningen för regn eller fukt.
- Ta inte bort utrustningens hölje.
- För inte in föremål i utrustningen genom ventilationshålen.
- Hantera inte nätsladden med våta händer.
- Täck inte för ventilationsöppningarna med några föremål som till exempel bordsdukar, dagstidningar, gardiner e.d.
- Inga föremål med öppen låga, som till exempel tända stearinljus, bör placeras på utrustningen.
- Följ de lagar och miljöskyddsråd som gäller i det land eller område där du bor när du gör dig av med batterier.
- Placera inte någonting närmare än 0,1 meter ovanför apparaten eller enheten.
- Se till att det finns omkring 0,1 meter fri plats runt omkring enheten.
- Inga objekt som är fyllda med någon vätska, till exempel blomstervaser, bör placeras på apparaten.
- Även om strömbrytaren står i det avstängda läget OFF, så är utrustningen inte helt bortkopplad från det elektriska nätet (MAINS).

Quick Start

Follow the instructions on this page to Quick Start your new PMD671 Portable Solid State Recorder and begin recording.

Note: Outside of the USA, a CF card is not included. See page 49 for installing a CF card and page 21 to format a CF card.

Quick Start Basic Instructions

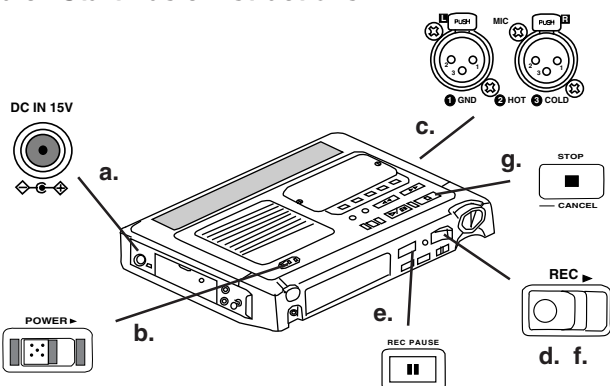

- Plug the AC adapter in.
- Slide the POWER switch to turn on.
- Connect your microphones.
- Slide the REC switch to start recording.
- Push and release REC PAUSE when recording is not necessary.
- Slide the REC switch to resume recording.
- Push the STOP button to stop recording.

Quick Start Detailed Instructions

The PMD671 comes with factory preset defaults for MP3 recording using external microphones. These settings are for recording a vocal or musical performance. Quick Start ignores changing any of these presets. Battery installation is not required.

- Unpack the AC power pack, power cord and the PMD671.

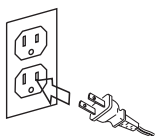

- Plug the AC power pack into household power.

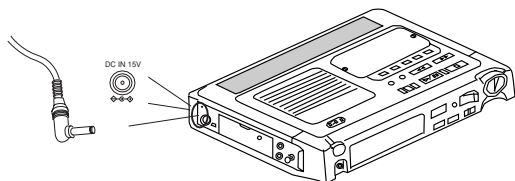

- Plug the power jack into the PMD671 at DC IN 15V.

- Slide the POWER switch to the right and release.

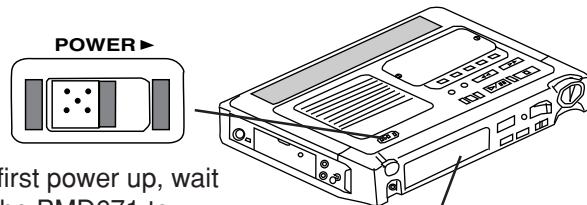

On first power up, wait for the PMD671 to initialize.

A full display will appear momentarily.

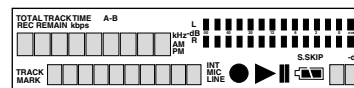

The display will change to Loading then to Reading.

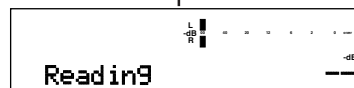

The display will change to BlankCard for a newly formatted CF card.



- Connect your microphones (see p 53), then slide the REC button to the right and release. Recording begins.

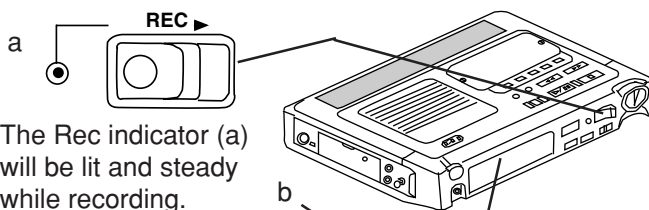

The Rec indicator (a) will be lit and steady while recording.

The display will show the recording time (b) of the current track (c).

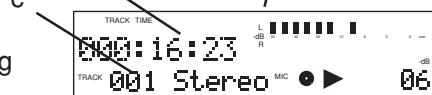

- Push and release the STOP button to stop recording and end the track (close the audio file).

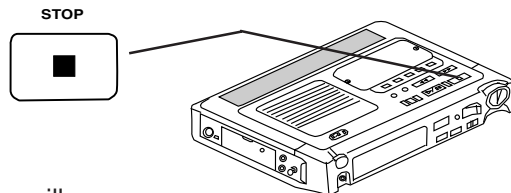

















The display will show the remaining recording time at current settings for the CF card.



example shows 4 hours 21 minutes and 02 seconds remaining

To transfer audio files to your computer: transfer the CF card, see page 49, or connect via USB, see page 51.

Table of Contents

Precautions		
Warnings and Cautions	2	
Important Safety Instructions	3	
CE markings	4a/4b	
Quick Start	5	
Table of Contents	6	
US/Europe models	7	
Package Contents	7	
Control and Connection Diagrams		
Top	8	
Front	9	
Left side	9	
Right side	9	
Bottom	9	
Display	10	
Introduction	10	
Features	12	
Controls and Connections		
Top	13	
Speaker	13	
MIC (internal microphone)	13	
POWER switch	13	
Security cover	13	
Recording setup controls		
MONITOR switch	13	
PRE REC switch	15	
INPUT LOCK switch	15	
AUDIO OUT switch	15	
MIC ATTEN switch	15	
REPEAT switch	15	
ANC switch	16	
EDL PLAY switch	16	
LEVEL CONT. switch	16	
INPUT button	17	
What the Input selections do	17	
Inputs / channels recorded	17	
A-B REPEAT button	18	
A-B Repeat playback	18	
MARK/  EDIT buttons	18	
EDL Marks	18	
Adding EDL Marks	18	
Locating EDL Marks	18	
Custom playback sequences	19	
Editing EDL Marks	19	
EDL A-B looping	19	
 EDIT button	20	
Edit mode	20	
How to renumber tracks	20	
How to erase tracks	20	
How to erase all EDL marks		
within one track	21	
How to erase all EDL marks	21	
How to format a CF card	21	
How to check a CF card	22	
TRACK JUMP buttons	23	
TRACK JUMP reverse button 	23	
REC UNDO button	23	
TRACK JUMP forward button 	23	
-/F.REV button 	23	
F.FWD/+ button 	23	
MARGIN RESET/ USB  MENU/STORE button	24	
MARGIN RESET button	24	
USB button	24	
 MENU/STORE button	24	
MENU operations	24	
Select Preset	24	
Menu settings	25	
How to set or change the		
Date / time	26	
Date Form	27	
Beep	28	
A.PowOff	28	
Batt Type	29	
RecFormat	30	
Digi-IN Rec Format	34	
RAW Mode	34	
Verify	35	
PupPreRec	35	
St Mode	36	
Mono Mode	37	
Auto Mark	37	
Manual TR	38	
Auto TRK	39	
SeamlsPly	40	
SilentSkp	40	
Auto Cue	41	
S.Monitor	42	
SinglePly	43	
Remote Mode	44	
Broadcast Wave ID numbers	44	
Default	45	
PLAY/PAUSE /		
ENTER button  	46	
PLAY/PAUSE button  	46	
ENTER button  	46	
STOP/CANCEL button 	46	
Front		
HP/SP VOLUME control	47	
Display	47	
REC PAUSE button 	47	
REC indicator	47	
REC switch	47	

REC LEVEL controls 47
 PHONES jack 48
 DISPLAY button 48
 LIGHT button 48
 KEY LOCK switch 49

Left side

CHARGE indicator 49
 CF card compartment 49
 To eject a CF card 49
 To insert a CF card 49
 Security 50
 DIGITAL IN/OUT jacks 50
 DC IN 15V jack 50
 USB port 50

How to connect via USB port 51

Right side

REMOTE1 jack 52
Remote Mode 52
 REMOTE2 jack 52
 LINE OUT/IN jacks 52
 MIC IN jacks 53
 PHANTOM +48V switch 53

Microphone recommendations 53

Carry studs 53

Installing the carry strap 53

Bottom

Battery compartment 53
Battery power 54
Installing AA size batteries 54
Installing/Changing an optional Ni-Cd or Ni-MH battery 54

Display 55
 Care and maintenance 56
 Recording time chart 57
 Rec Format charts 58
 Menu defaults 59
 Troubleshooting 60
 Error Messages 60
 Specifications 61
 Optional accessories 61
 Record setting recommendations 61
 Warranty 62

US/Europe models
 The US model PMD671/UIB distributed in the USA, and European model PMD671/N1B distributed elsewhere, differ slightly in supplied accessories and default settings. Those differences are noted in this User Guide.

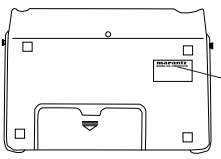

MODEL NO. PMD671/UIB
 or
 MODEL NO. PMD671/N1B

Package contents

- PMD671

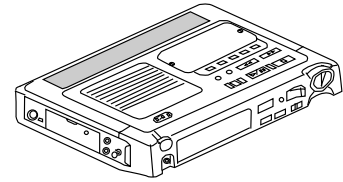

- 64MB CF card (US only) (shipped formatted and installed)



- AC power pack

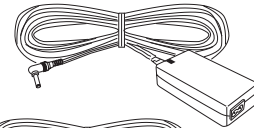

- power cord

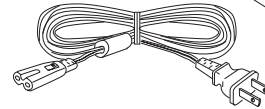

Europe models include 2 power cords

CEE

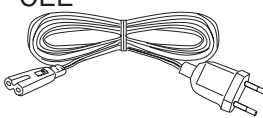

BS

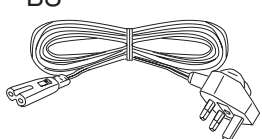

- USB cable (3 ft)

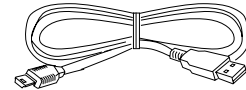

- AA battery carrier

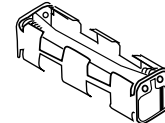

- Carry strap



- Carry strap retainers (2)



- Security screws (3)
 ISO 3x10 (3mm x 10mm long)
 For Memory compartment door (1)
 or Security cover (2 spares)



- Plastic pin and retainer (spare - for Memory compartment door)



- CD
 Contents of the CD may vary. Contents usually include:
 - PDF format manual(s)
 Several languages may be included.
 - Demonstration copy of PMDEdit software
 - Instructions for obtaining full copy of PMDEdit
- This User Guide
- Customer Registration Document

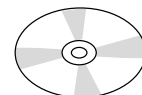

Control and Connection Diagrams

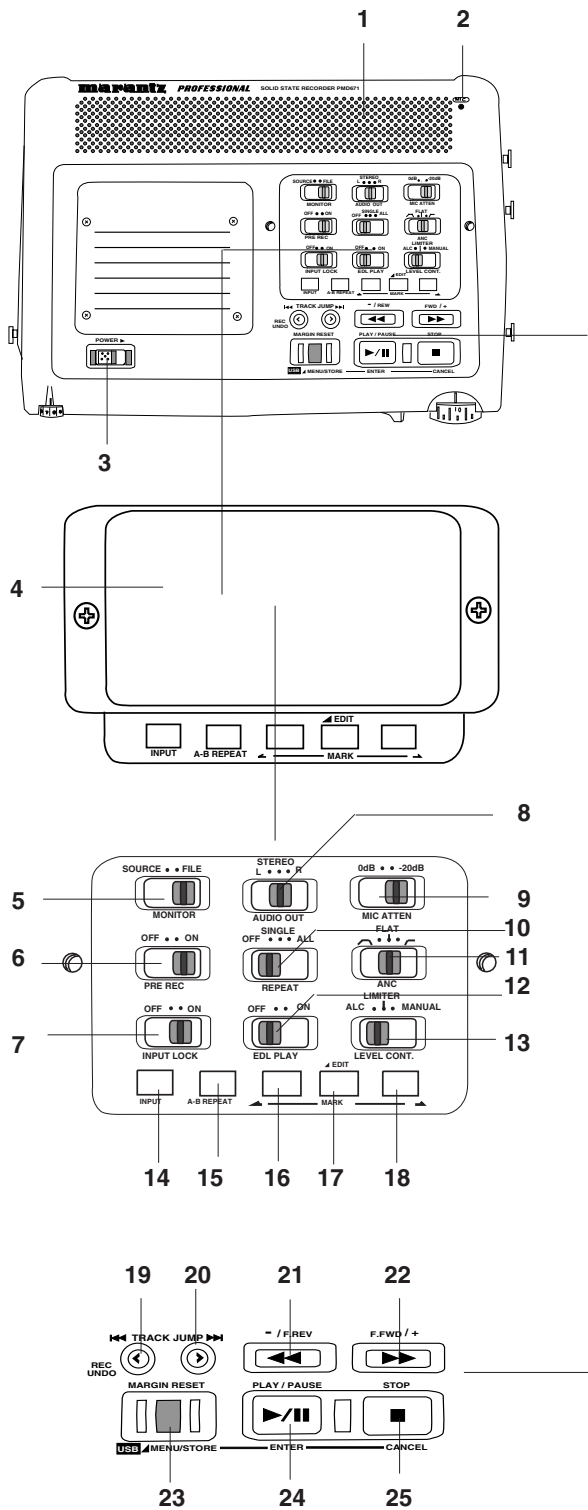

#	Control	Page
Top		
1	Speaker	13
2	MIC (internal microphone)	13
3	POWER switch	13
4	Security cover	13
Setup controls		
5	MONITOR switch	13
6	PRE REC switch	15
7	INPUT LOCK switch	15
8	AUDIO OUT switch	15
9	MIC ATTEN switch	15
10	REPEAT switch	15
11	ANC switch	16
12	EDL PLAY switch	16
13	LEVEL CONT.	16
14	INPUT button	17
15	A-B REPEAT button	18
MARK/ ▲ EDIT controls		
16	Mark reverse button	18
17	MARK/ ▲ EDIT button	18
18	Mark forward button	18
Record/Playback controls		
19	TRACK JUMP reverse button ◀◀ (playback)	23
20	TRACK JUMP forward button ▶▶ (playback)	23
21	-/F.REV button ◀◀	23
22	F.FWD/+ button ▶▶	23
23	MARGIN RESET/ USB ▲ MENU/STORE button MARGIN RESET button (playback)	24
	USB button	24
	▲ MENU/STORE button	24
24	PLAY/PAUSE button ▶/ (playback)	46
	ENTER button ▶/ (menu)	46
25	STOP/CANCEL button ■	46

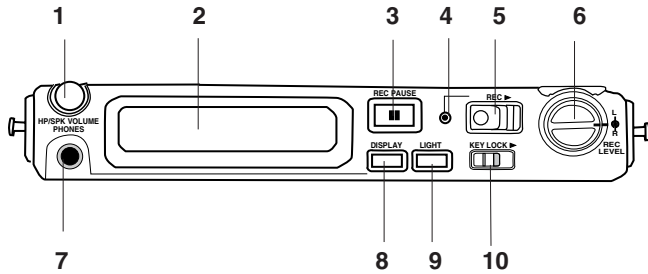

Control Page

Front

1	HP/SPK VOLUME control	47
2	Display (see next page)	47
3	REC PAUSE button 	47
4	REC indicator.	47
5	REC switch	47
6	REC LEVEL controls	47
7	PHONES jack	48
8	DISPLAY button	48
9	LIGHT button	48
10	KEY LOCK switch	49

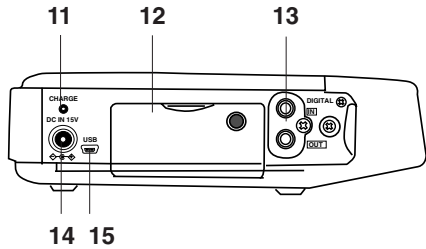

Left side

11	CHARGE indicator	49
12	CF card compartment	49
13	DIGITAL IN/OUT jacks	50
14	DC IN 15V jack	50
15	USB port	50

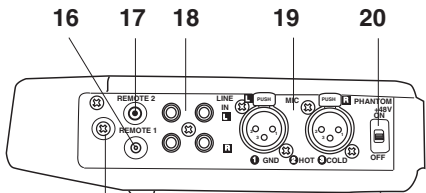

Right side

16	REMOTE 1 jack	52
17	REMOTE 2 jack	52
18	LINE IN/OUT jacks	52
19	MIC IN jacks	53
20	PHANTOM power switch	53
21	Carry studs	53

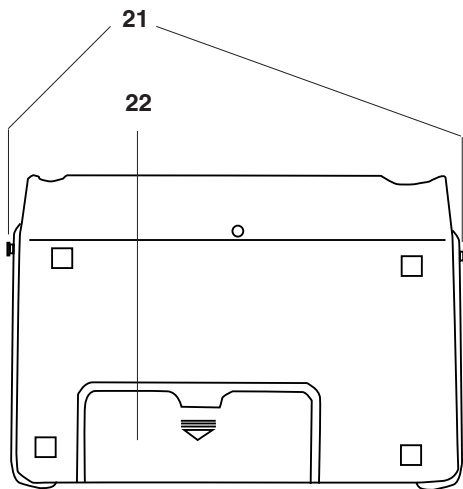

Bottom

22	Battery compartment	53
----	---------------------------	----

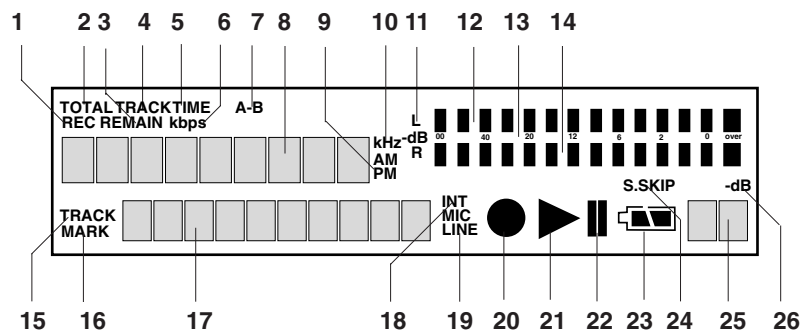

Control Page

Display

1	REC label	55
2	TOTAL label	55
3	REMAIN label	55
4	TRACK label	55
5	TIME label	55
6	kbps label	55
7	A-B label	55
8	Upper alphanumeric display	55
9	AM/PM label	55
10	kHz label	55
11	L -dB R level meter labels	55
12	Left level meter	55
13	-dB over scale	55
14	Right level meter	55
15	TRACK label	55
16	MARK label	55
17	Lower alphanumeric display	55
18	INT MIC label	56
19	LINE label	56
20	Record ●	56
21	Play ►	56
22	Pause 	56
23	Battery [Battery Icon]	56
24	S. SKIP label	56
25	Margin level	56
26	-dB label	56

Introduction

Thank you for selecting the Marantz Professional PMD671 Portable Solid State Recorder. The PMD671 is an audio recorder that records in digital audio formats onto a Compact Flash™ memory card (CF card) or Microdrive™.

Compact flash memory cards, also used in digital cameras, are widely available at consumer electronics retailers and computer resellers.

Audio inputs may be from:

- the built-in microphone,
- condenser or dynamic microphone(s) connected to the XLR jacks,
- line level audio sources connected to the LINE IN jacks, or
- digital audio sources in SP/DIF format connected to the DIGITAL IN jack.

Audio outputs may be from:

- the built-in speaker,
- headphones connected to the PHONES jack,
- analog audio devices such as an amplifier or other device connected to the LINE OUT jacks, and/or
- digital audio devices using SP/DIF format connected to the DIGITAL OUT jack.

Computer compatible

The PMD671 records directly onto CF cards. Recordings can be transferred to your desktop or laptop computer by removing the CF card from the PMD671. You may also use the supplied cable to connect the PMD671 to your computer via the USB port. Audio recorded in the popular MP3 compression format is directly available for intranet or internet file sharing.

You can:

- log and archive audio files

Hint:

When making major changes to your recording setup, we suggest the following procedure:

1. Identify the appropriate input device (internal microphone, microphone(s), Line input, Digital input).
2. Select the input menu choice corresponding to your input device selection. (See page 17.)
3. If necessary, set or change the Rec Format parameters for your recording situation. (See page 30.)

- play audio files on your computer
- save audio files to:
 - your hard drive
 - a floppy
 - a CD-R disc
- post streaming audio files on your web site
- use software and your computer to transcribe digital recordings

An editing program (PMDEdit, available from Marantz Professional for PC users) lets you convert and edit audio files that were recorded on the PMD671.

Presets

The PMD671 has three selectable Presets for commonly used recording situations.

Preset 1, MP3 Stereo using your microphones, for recording with relatively small files.

Preset 2, MP3 Mono using the internal microphone, for recording meetings or voice with very small files.

Preset 3, PCM Stereo using your microphones, for very high quality audio recording.

• Security – recording

The PMD671 has several security features, not previously available on Marantz Professional digital recorders, that confirm recording is accurately written to the CF card.

• Verify

Verify is electronic file verification. When turned on in the Preset menu, Verify runs a check between the audio at the source and information written to the CF card.

• RAW

RAW (Read After Write / VTH - Virtual Third Head) digitally mimics the third head of a three head tape deck. While recording, audio at the PMD671's outputs is audio that has already been written to the CF card. With about a 2 second delay, you can listen to the audio written to the CF card, monitoring that recording is actually taking place.

• Time Shift Playback

Time Shift Playback allows you to listen to audio from anywhere on the CF card while simultaneously recording the current source.

Note:

These recording security features are not available when

making 24 bit recordings. Simultaneous availability depends on recording conditions. See page 14.

• Security – CF cards

For added security, the CF card compartment door can be secured with a screw. This is especially recommended if you transfer audio files via the USB cable.

• Security – Input settings

After you have set up the input settings* for your application, the settings can be set to ON with the INPUT LOCK switch.

As an added precaution, the input setting switches (including the ability to change input devices) can be protected with the supplied screw-on cover preventing unintentional changes.

*Settings for recording meetings for example, will usually be the same from meeting to meeting.

Voice recording

The PMD671 has several helpful features for voice recording in situations such as meetings, conferences or other events.

• Use less memory (longer recording time)

For voice recording, the recording quality level (bit rate recorded and/or sampling frequency) can be set to the lowest levels. This permits more time recorded on the CF card.

• Easy recording

One control begins recording. Simply slide and release the red REC switch.

Playback aids

A common problem with lengthy voice or other recordings is difficulty in locating one or more specific passages for playback. The PMD671 has several ways to mark or tag specific record starting points.

• Date and time

A built-in date and time generator marks the beginning of each track.

• Tracks

An audio recording is called a "track" when on the PMD671 and an audio "file" when on your computer.

Tracks are numbered from 01 to a maximum of 999.

A new track (file) is automatically started each time recording is stopped using the STOP button.

Using the "Auto TRK" feature, PMD671 can be set to start a new track at specific time intervals during recording (for example every minute).

Using the "Manual TR" feature, you can start a new track during recording by sliding and releasing the REC switch.

- **Automatic recording**

The PMD671 can be set to stop recording when there is silence (SilentSkp feature) and automatically start when sound resumes. The PMD671 can be set to automatically add an EDL mark (Auto Mark feature) to the track at each such starting point.

- **EDL marks***

EDL (Edit Decision List) marks can be created during recording manually or automatically. EDL marks help you find those specific points in the recording.

*The EDL marking system is proprietary to Marantz Professional solid state recorders.

- During playback, you can search for EDL marks in forward or reverse.
- You can change an EDL mark into a skip mark or an A-B repeating point. That option allows you to create custom playback sequences which include skipping or repeating audio between EDL marks.
- Up to 255 EDL marks can be added to a CF card. EDL marks are numbered consecutively starting at one. During recording, you can manually add an EDL mark by pressing MARK. EDL marks can be added automatically, for example, at the beginning of each track.
- PMDEdit computer software is specifically designed for the PMD671. PMDEdit recognizes EDL marks generated by the PMD671. This is especially useful for editing audio files on your PC. Visit www.d-mpro.com for more information.

Features

- Stereo (2 channels) and mono (1 channel) audio recording and playback.
- Records onto various types of CF cards. (Please refer to the Marantz Professional web site at www.d-mpro.com for a list of recommended cards.)
- Two different recording formats:
 - Compressed recording using MPEG1 Layer II (MP2) or MPEG1 Layer III (MP3) mono and stereo.
 - Uncompressed recording using 16-bit or 24-bit linear Pulse Code Modulation (PCM). 16-bit 44.1kHz PCM recordings are standard CD quality. 24-bit 96kHz PCM recordings are high quality recordings used in professional audio and film studios.
- MS-DOS™ and Windows compatible file system.
- Selectable file types:
 - Wave (.wav)
 - Broadcast Wave Format (.bwf or .wav)
 - MP2 (.mpg)/MP3 (.mp3).
- Recording bit rate is selectable:
 - .mpg/mp3 compressed at 32kbps (recommended for dictation), 32, 48 or 64kbps (recommended for voice recording), or 128 or 192 kbps (recommended for recording music)
 - PCM (.wav) uncompressed (very high quality mono audio recording)
 - PCM (.wav) uncompressed 24 bit/96kHz (stereo) (recommended for very high quality audio recording)
- Manual, manual with limiter and automatic record level control (ALC).
- An ANC (Ambient Noise Cancel) switch for reducing unwanted background noise.
- Electronic 'Read After Write' monitoring (time shift) feature.
- Automatic electronic file verification feature (Verify).
- CF card compatibility check feature (Card Check).
- Pre-Recording memory buffer that records 2 to 4 seconds* of audio before recording is started.
- Portions of multiple recordings can be played back in sequence using EDL marks.

*Normally 4 seconds. Depends on Rec Format settings.

- There are four ways to power the PMD671:
 - Included AC adapter
 - AA Alkaline batteries (~ 5 hours @ 1450 mAh usage)
 - Optional rechargeable Ni-Cd battery pack RB1100 (~ 4 hours @1100 mAh usage).
 - Optional rechargeable Ni-MH battery RB1651 (~ 6 hours @1650 mAh usage).
- Built-in Time and Date generator marks the beginning of each track.
- REMOTE1 jack permits a wired remote button for controlling the recording process.
- REMOTE2 jack permits using the optional RC600 remote for microphone interviews.

When first powered up, the PMD671 takes some time to initialize.

Loading is displayed, then the screen goes blank momentarily.



Reading is displayed while the CF card is read.



Controls and Connections

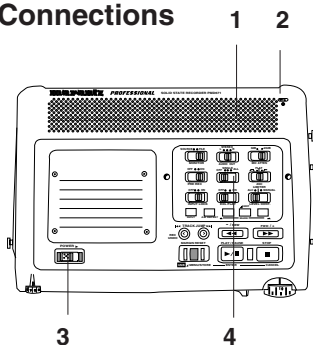

Top

1. Speaker

The played back audio signal is simultaneously output to the built-in speaker, the PHONES jack, LINE OUT jacks and DIGITAL OUT jack. Headphones plugged into the PHONES jack mute the internal speaker. The HP/SPK VOLUME control controls the built-in Speaker and Headphone volume.



2. MIC (internal microphone)

POWER ►

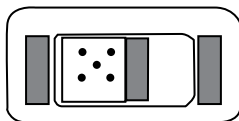

3. POWER switch

Slide to the right and release to turn Power on or off.

If the AC power pack is

connected at DC IN and plugged in, it powers the PMD671.

If power is not detected at DC IN, battery power is automatically used if available.

Security cover

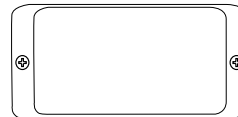

Use a small Phillips screw-driver to remove or replace the Security cover.

The Security cover makes setup controls relatively unavailable. The setup controls allow you to setup the PMD671 for your unique application. You can then have someone operate the PMD671 without concern that they might change something that could cause failure to record.

Note: Two 3mm machine screws 10mm long are used for the security cover.

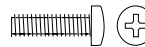

Recording setup controls

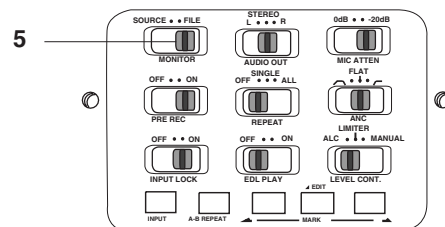

SOURCE • • FILE



5. MONITOR switch

This switch turns the Read After Write or Time Shift Playback* feature on or off.

*Depending on the setting of RAW mode in the Menu.

When RAW Mode is at **MONITOR**, and the **MONITOR switch is at FILE** when recording begins, **Read After Write** is on.

When RAW Mode is at **TimeShift**, and the **MONITOR switch is at FILE** when recording begins, the **Time Shift feature** is on.

continues

RAW (VTH - Virtual Third Head)

RAW (Read After Write / VTH - Virtual Third Head) digitally mimics the third head of a three head tape deck. When on and the PMD671 is recording, the audio that is output to the LINE OUT, DIGI OUT, PHONES and SPEAKER is audio that has already been written to the CF card and not audio from the source. This allows you to actually listen to audio written to the CF card, monitoring that the recording is actually taking place. When RAW is off, the audio to the LINE OUT, DIGI OUT, PHONES and SPEAKER is actually the source you are recording.

Time Shift (Time Shift Playback)

Time Shift Playback works just like RAW, in that it monitors audio that has already been recorded to the CF card. However, Time Shift allows you the ability to listen to audio from anywhere on the card while simultaneously recording the current audio source.

FILE: During recording, output to the PHONES and LINE OUT jacks is read from the CF card.

SOURCE: During recording, output to the PHONES and LINE OUT jacks is the audio source being recorded.

Factory defaults: MONITOR switch: SOURCE, Presets 1, 2, and 3: RAW at MONITOR.

Notes:

- Active level meters verify that an audio source is being received by the PMD671.
- Another way to verify that audio is being recorded is to turn on the VERIFY menu choice (see page 35). When VERIFY is ON, the PMD671 constantly compares the recorded information to the source input. It verifies that the file written to the card is exactly what was input.
- MONITOR is not available in 24 bit recording, or available for MP2.
- MONITOR is available for 16 bit PCM recording and MP3.
- An audio drop out may occur when using RAW at high bit rates in MP3.

Time Shift lets you select the Read After Write time delay. Time Shift playback allows you to play audio that has already been recorded from anywhere on the CF card while simultaneously recording the current audio. This is useful in applications such as court recording.

When the Time Shift feature is on and the MONITOR switch is set to file, as you begin recording the outputs (for example headphones) monitor the source. While recording is in progress, you can press and release the -/F.REV button ◀◀ to search back through and play the file that is being recorded (to the point you began the Time Shift).

Audio played back through the headphones can be anywhere on the CF card. You can use the TRACK JUMP reverse ◀◀ or TRACK JUMP forward ▶▶ buttons to change tracks.

Press and release the PLAY/PAUSE button ▶|| to return to monitoring the current recording.

Notes:

- In some instances, Verify and RAW or Time Shift are available simultaneously (see charts below).
- When using RAW (Read After Write) to monitor information already written to the CF card, the audio played back will be about 2 seconds behind current events.
- RAW and Time Shift are only available individually. Never at the same time.
- **Not available when making 24-bit recordings.** RAW and Time Shift are not available when making 24-bit recordings.

The chart below details which features are available during which RecFormats.

	PCM 16-bit	PCM 24-bit	MP3	MP2
Verify	•	•	•	n/a
RAW, Time Shift	•	n/a	•	n/a

Additionally, Verify is available for use at the same time as RAW (Read After Write) or Time Shift (Time Shift Playback) in the following circumstances:

	PCM 16-bit with RAW / Time Shift	PCM 24-bit	MP3 with RAW / Time Shift
Verify	•	•	•

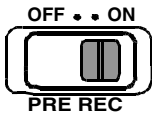
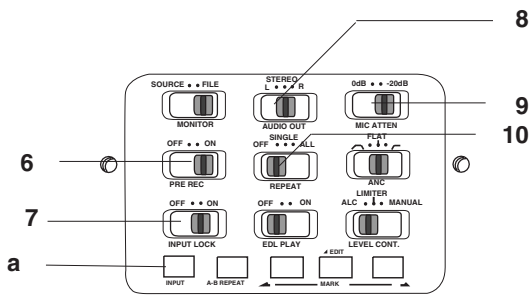

6. PRE REC switch

This switch lets you turn off pre record cache if it is not desired.

When power is on and the PMD671 is in REC/PAUSE the recorder is constantly saving about 4 seconds* of audio input. This is called pre record cache. When recording is resumed from REC PAUSE by sliding the REC switch, the pre-recorded seconds are recorded.

OFF: Turns the pre-record cache off.

ON: Leaves the pre-record cache on.

*Cache time varies with recording conditions:

- 24-bit PCM – 1 second
- 16-bit PCM, MP2, MP3 – 4 seconds
- 16-bit PCM, MP3 with RAW – 2 seconds.

Factory default: PRE REC switch at ON.

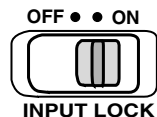

7. INPUT LOCK switch

The INPUT LOCK switch lets you lock your selected input settings with a switch covered by the Security cover.

OFF: When the INPUT LOCK switch is at OFF, push and release the INPUT button (a) to tab through the input choices. The selection “times out” to the displayed input choice in 3 seconds.

Example display



MIC

ON: When the INPUT LOCK switch is at ON, pushing the INPUT button (a) does nothing (skips the input selection choices).

Factory default: INPUT LOCK switch at OFF.



8. AUDIO OUT switch

This switch selects the audio output channel for playback.

Applies to playback output to LINE OUT, DIGITAL OUT, and Internal speaker or headphones.

L: Audio recorded on the Left channel is output to both the left and right output channels.

STEREO: Audio recorded on the Left channel is output to the left output channel, and audio recorded on the Right channel is output to the right output channel. Both channels are output to the internal speaker.

R: Audio recorded on the Right stereo channel is output to both the left and right output channels.

Factory default: ANALOG OUT switch at STEREO.

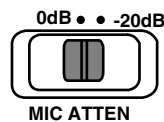

9. MIC ATTEN switch

The microphone attenuation switch permits the direct use of microphones that differ in sensitivity.

0dB: No microphone attenuation.

-20dB: Input from a microphone(s) connected to the XLR MIC IN jacks is cut by -20dB.

Factory default: MIC ATTEN switch at 0dB.

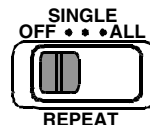

10. REPEAT switch

Lets you endlessly repeat playback of a track or entire memory card.

OFF: No repeat.

SINGLE: During playback, the current track is repeated. When playback reaches the end of the track, it automatically starts playback from the beginning of that track.

ALL: During playback, all tracks are repeated. When playback reaches the end of the last track, it automatically starts playback from the beginning of the first track.

Factory default: REPEAT switch at OFF.

Note:

For other methods of repeat playback, see the A-B REPEAT button and/or EDL A-B looping (pages 18 and 19).

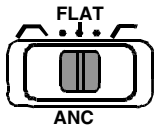
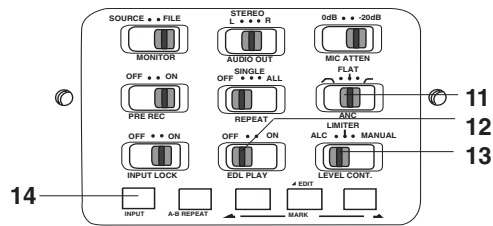

11. ANC switch

The ANC (Ambient Noise Cancel) switch lets you reduce ambient noise

before recording on the internal microphone or MIC inputs.

Ambient Noise Cancel positions do not change the memory used in recording. Examples of low ambient noise sources include: traffic, air conditioning hum and wind noise.

Band pass position reduces the lows and highs and passes (records) the center (voice level) audio frequencies. This reduces the recording of high and low frequency ambient noise.

FLAT: No filtering applied.

High pass position reduces low frequency ambient noise only.



12. EDL PLAY switch

The EDL PLAY switch turns EDL PLAY off or on.

OFF: When the EDL PLAY switch is at OFF, PMD671 playback does not respond to EDL mark instructions.

ON: When EDL PLAY is ON, PMD671 playback follows EDL mark instructions regarding playback order, skipping sections of recording on the memory card, or repeating a section of recording on the memory card.

Note:

If the EDL PLAY switch is at ON and there are no EDL marks on the CF card (recording was done with the AUTO

MARK switch at OFF, or no marks were placed manually), playback is not available. Switch to OFF for playback.

Factory default: EDL PLAY switch at OFF.



13. LEVEL CONT. switch

The LEVEL CONT(rol) switch lets you select the type of input level control.

MANUAL: At MANUAL, you control the input level with the REC LEVEL controls.

LIMITER: At LIMITER, peak sound levels that would distort the recording are limited.

ALC: At ALC (Automatic Level Control = Automatic Gain Control), the PMD671 automatically responds to changes in input level. If recording is quiet, the input level is increased. If recording is loud, the input level is decreased. This is a desirable feature when recording a meeting with several speakers. A speaker close to the microphone and/or with a loud voice will be automatically recorded at a reduced level and a quiet speaker will be recorded at an increased level. Both will be less likely to have their input missed.

ALC is usually undesirable when recording music (voice or instrument) because the transitions in input level may be audible in the recording. ALC can also make the recording 'hissy' by raising the level during quiet passages and recording ambient noise.

The REC LEVEL controls do not work when the LEVEL CONT. switch is set at ALC.



14. INPUT button

The INPUT button lets you select the audio input and audio channels for recording.

When the INPUT LOCK switch (a) is at OFF, press and release the INPUT button to tab through the input choices. When the desired input is displayed, switch the INPUT LOCK switch (a) to ON.

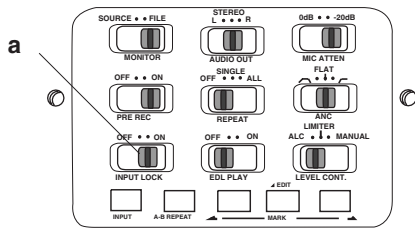

Example display

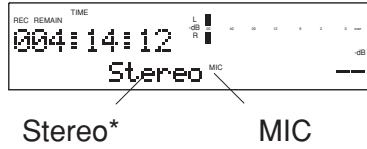

*The stereo or mono mode displayed and recorded depends on the St Mode and Mono Mode menu settings.

Note:

The PMD671 'listens' only to the selected input. For example if the input selected is LINE input, and no input source is connected to the LINE IN jacks, the PMD671 will record silence.

What the input selections do:

Selects the input device(s)

The input selection allows you to choose which input(s) the PMD671 uses for recording. **You must select the Preset parameters that are appropriate to the input.** The PMD671 will record with the Rec parameters you select, even if they are inappropriate for the input. You can use the default Presets for a quick and easy way to set up for recording. Use Preset 1 for Stereo recording using mic or line inputs.

Use Preset 2 when using the internal microphone. Use Preset 3 for digital input.

Input device(s) and channels:

Stereo with MIC input

The microphone connected to the L MIC IN XLR jack is recorded on the Left channel. The microphone connected to the R MIC IN XLR jack is recorded on the Right channel.

L-Ste with INT MIC input

Mono audio input from the internal microphone is recorded on the Left Channel, and the same audio input is recorded on the Right Channel as a "stereo" file.

Stereo with LINE input

Audio input from the L LINE IN jack is recorded on the Left channel. Audio input from the R LINE IN jack is recorded on the Right channel.

Digi-IN

Digital audio data at 44.1kHz, 48kHz or 96kHz input through the DIGITAL IN jack can be recorded. Digital input always includes two channels. They are recorded as Left and Right stereo channels.

Mono with MIC, INT MIC or LINE input

The input from the Left channel or internal microphone is recorded as a mono file.

Inputs / channels recorded

INPUT Button Selection	input (s) connected	Menu Selection				
		St. Mode		0-20db	Mono Mode	
		L Stereo	R Stereo	0-20db	L Mono (L CH.)	R Mono (Mix)
INT MIC	Internal Microphone	L INT MIC / R INT MIC	L INT MIC / R INT MIC	N/A defaults to L-Stereo	INT MIC	INT MIC
Line	L&R LINE IN	L L LINE IN / R R LINE IN	L L LINE IN / R L LINE IN	N/A defaults to L-Stereo	L LINE IN	L + R LINE IN
	L LINE IN only	L L LINE IN / R —	L L LINE IN / R L LINE IN	N/A defaults to L-Stereo	L LINE IN	L LINE IN
	R LINE IN only	L — / R R LINE IN	L — / R —	N/A defaults to L-Stereo	—	R LINE IN
Mic	L&R MIC IN	L L MIC IN / R R MIC IN	L L MIC IN / R L MIC IN	L L MIC IN / R L MIC IN (-20db)	L MIC IN	L + R MIC IN
	L MIC IN only	L L MIC IN / R —	L L MIC IN / R L MIC IN	L L MIC IN / R L MIC IN (-20db)	L MIC IN	L MIC IN
	R MIC IN only	L — / R R MIC IN	L — / R —	— / R —	—	R MIC IN
Digi-in	DIGITAL IN	L L DIGI IN / R R DIGI IN	L L DIGI IN / R R DIGI IN	L L DIGI IN / R R DIGI IN	L + R DIGI IN	L + R DIGI IN

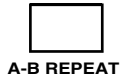
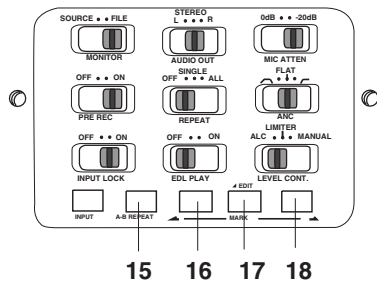

15. A-B REPEAT button
While in playback, press and release to start point A to point B repeat playback.

A-B Repeat playback

Point A (starting point) is set when the A-B REPEAT button is pressed and released. The next press and release sets point B (ending point). Playback repeats between A and B.

Note:

You can use the -/F.REV ◀◀ or F.FWD/+ ▶▶ buttons between setting the A and B points. You cannot use the TRACK JUMP forward ▶▶ or reverse ◀◀ buttons.

You can pause during A-B repeat playback by pressing and releasing the PLAY/PAUSE button ▶/||. Resume A-B playback by pressing the PLAY/PAUSE button ▶/|| again.

Exit and cancel A-B repeat by pressing the STOP button ■ or pressing the A-B REPEAT button.

Example display when an A point has been set.

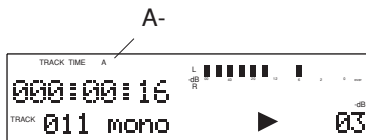

Example display during A-B repeat.

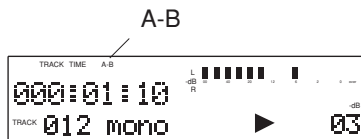

Note:
For other methods of repeat playback, see the REPEAT switch and/or EDL A-B looping.

16, 17, 18. MARK/EDIT buttons
This button group controls EDL Marks and Editing functions.

EDL Marks

Mark functions: manually adding and locating Marks.

Adding EDL Marks

Press and release the MARK/EDIT button during pause, recording, or playback to add an EDL Mark. During recording, adding an EDL Mark introduces an audible click in the recording when using the internal microphone.

Locating EDL Marks

From Stop, press and release the Mark forward button (18) or Mark reverse button (16) to tab through the EDL marks on the CF card.

EDL Mark location as recording time from the beginning of the track.

Example display.

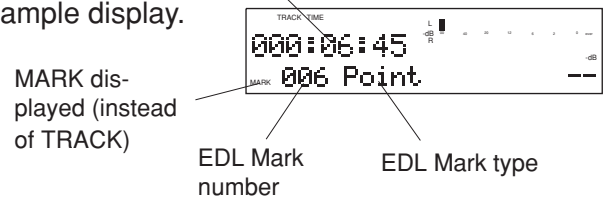

To start playback from the displayed EDL Mark, press and release the PLAY/PAUSE button ▶/||.

Edit functions: editing EDL Marks to create custom playback sequences, erasing and renumbering Tracks, and formatting the CF card.

Custom playback sequences

EDL Marks are numbered consecutively from 001 and automatically renumbered when an EDL Mark is added or erased. Playback is also consecutive from the point that playback begins.

EDL Mark custom playback can:

Skip playback from the beginning of a 'Skip' EDL Mark to the beginning of the next EDL Mark.

A-B loop from a 'Loop_A' EDL Mark to a 'Loop_B' EDL Mark.

EDL Marks are not automatically placed at the beginning of tracks. If you want your custom playback sequence to include track beginning points, add EDL Marks to coincide with track beginning points:

- a. Start playback by pressing and releasing PLAY/Pause ►||, and then pause playback by pressing and releasing PLAY/Pause ►|| again.
- b. Press and release TRACK JUMP forward ►► or TRACK JUMP reverse ◀◀ until the desired track number is displayed.
- c. Press and release the MARK/▲EDIT button.

Editing EDL Marks:

All EDL Marks are initially entered as 'Point' marks.

From Stop display the EDL Mark by pressing and releasing the Mark forward button (18) or Mark reverse button (16) to tab through the EDL marks on the CF card.

When the EDL mark to be edited is displayed, press and release the MARK/▲EDIT button. The current EDL Mark type will be flashing.

Example display



Press and release the MARK/▲EDIT button to tab through the EDL Mark types: Point, Skip, Loop_A, Loop_B and Erase. When the type you want is flashing, press and release the ENTER button ►||.

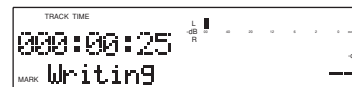

Writing will be displayed briefly, and the PMD671 will return to stop mode.

Skip

An EDL Mark changed to 'Skip' will be skipped during EDL playback (playback with EDL PLAY switch at ON). Playback will skip to the beginning of the next EDL Mark.

A skipped EDL recording is not erased. The recording is still on the CF card. The skipped EDL recording will play if the EDL PLAY switch is at OFF. You can change the type later.

EDL A-B looping

To playback an EDL A-B loop, press the PLAY/PAUSE button ►|| to begin playback, then press and release the A-B REPEAT button. If there is an error, for example there is an EDL Mark of type Loop_A but no EDL Mark of type Loop_B, an error message is displayed.

Example display



Only one EDL A-B loop can programmed. When a 'Loop_A' or 'Loop_B' exists on a CF card and another is created, the old mark automatically changes to a 'Skip'.

Erase

When an EDL mark is erased, the remaining EDL marks are automatically renumbered from 1 through the number of EDL marks on the CF card.



EDIT button
Press and hold the **EDIT** button for about 2 seconds to enter Edit mode.

Edit mode

Edit mode includes: Renumber (renumber tracks), TrkERASE (erase a track), TrkMkERASE (erase an EDL mark), AllMkERASE (erase all EDL marks), FORMAT (format the CF card), and CARD CHECK.

How to renumber tracks

If you have erased tracks from the CF card it is easier to locate recordings if the tracks are renumbered.

From stop, press and hold the MARK/ **EDIT** button for about 2 seconds to enter Edit mode.

Renumber is flashing in the display.



While Renumber is flashing (3 seconds) press and release the ENTER button **▶/||**. (Or press and release the STOP button **■** to cancel.)

Renum OK? will be flashing. Press and release the ENTER button **▶/||** to confirm.

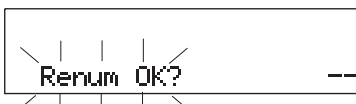

EXECUTING will be displayed, and the percentage executing will increase to 100%.



100% done will be displayed momentarily. The PMD671 and the display will return to stop mode.



How to erase tracks

From stop, press and hold the MARK/ **EDIT** button for about 2 seconds to enter Edit mode.

Renumber is flashing in the display.

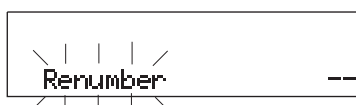

While Renumber is flashing (3 seconds) press and release the MARK/ **EDIT** button again.

TrkERASE is flashing in the display.

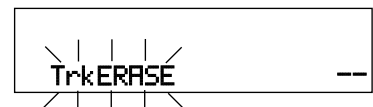

While TrkERASE is flashing (3 seconds) press and release the ENTER button **▶/||**.

Track number is flashing in the ERASE display.

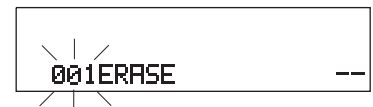

Press and release the F.FWD/+ button **▶▶** or the -/F.REV button **◀◀** to select the track number you want to erase.

Example track 34.



While the track to be erased is flashing (3 seconds), press and release the ENTER button **▶/||**. (Or press and release the STOP button **■** to cancel.)

EXECUTING will be displayed momentarily.



Done will be displayed momentarily.



The PMD671 and the display will return to the first track so you can choose to erase another track.



The recording time (file space on the CF card) used by the erased track is available for recording.

Press and release the STOP button **■** to exit.

How to erase all EDL marks within one track

From stop, press and hold the MARK/▲EDIT button for about 2 seconds to enter Edit mode.

Renumber is flashing in the display.



While the display is flashing (3 seconds) press and release the MARK/▲EDIT button two more times.

TrkMkERASE is flashing in the display.



While TrkMkERASE is flashing (3 seconds) press and release the ENTER button ►||.

Track number is flashing in the ERASE display



Press and release the F.FWD/+ button ►► or the -/F.REV button ◀◀ to select the track that contains the EDL Marks to erase.

Example to erase all EDL marks in Track 12.



While the track number is flashing, press and release the ENTER button ►||. (Or press and release the STOP button ■ to cancel.)

EXECUTING will be displayed momentarily.



Done will be displayed momentarily.



The PMD671 and the display will return to the first track, so you can choose another track to erase its EDL marks.



Press and release the STOP button ■ to exit.

How to erase all EDL marks

From stop, press and hold the MARK/▲EDIT button for about 2 seconds to enter Edit mode.

Renumber is flashing in the display.



While the display is flashing (3 seconds) press and release the MARK/▲EDIT button three more times.

AllMkERASE is flashing in the display.



While AllMkERASE is flashing (3 seconds), press and release the ENTER button ►||.

AllMkErOK? is flashing in the display.

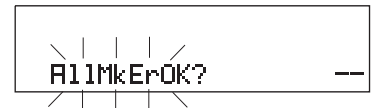

The display asks you to confirm that you want to erase all EDL Marks on the CF card. While AllMkErOK? is flashing, press and release the ENTER button ►|| to confirm. (Or press and release the STOP button ■ to cancel.)

EXECUTING will be displayed momentarily.



Done will be displayed momentarily.



The PMD671 and the display will return to stop mode.

How to format a CF card

From stop, press and hold the MARK/▲EDIT button for about 2 seconds to enter Edit mode.

Renumber is flashing in the display.

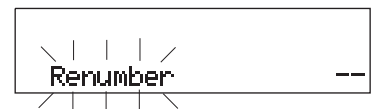

While the display is flashing (3 seconds) press and release the MARK/▲EDIT button four more times.

FORMAT is flashing in the display.



While FORMAT is flashing (3 seconds), press and release the ENTER button ►||.

FORMAT OK? is flashing in the display.

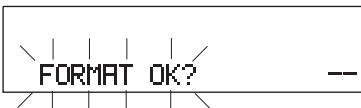

The display asks you to confirm that you want to format the CF card. Formatting the CF card will erase all recordings on the card.

While FORMAT OK? is flashing, press and release the ENTER button ►|| to confirm. (Or press and release the STOP button ■ to cancel.)

EXECUTING will be displayed momentarily.



Done will be displayed momentarily.



The PMD671 returns to stop mode.

BlankCard will be displayed.



The CF card formats used by the PMD671 are Windows compatible. You can copy audio files using a Windows compatible computer* that can read a CF card or be connected via the USB port.

*Or a Macintosh computer that can recognize Windows compatible removable drives.

CF cards with less than 2 GB capacity are automatically formatted FAT16 (FAT = File Allocation Table).

CF cards with 2 - 8 GB capacity are automatically formatted FAT32.

The maximum CF card that can be formatted in the PMD671 is 8 GB. If larger cards are used, please format in your computer.

How to check a CF card (CARD CHECK)

Although rare, manufacturing defects in CF cards occasionally prevent a CF card from being able to read and write at the speeds required by the PMD671. CARD CHECK does a sample read/write to check if a CF card has problems. If a CARD CHECK fails, you can usually return the CF card for a replacement.

From stop, press and hold the MARK/▲EDIT button for about 2 seconds to enter Edit mode.

Renumber is flashing in the display.

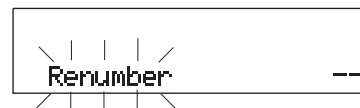

While the display is flashing (3 seconds) press and release the MARK/▲EDIT button five more times.

CARD CHECK is flashing in the display.



While CARD CHECK is flashing (3 seconds) press and release the ENTER button ►||.

EXECUTING will be displayed and the percentage will go to 100%.



Read: and Write: numbers will be displayed. If the read and write numbers are the same, the CF card check is successful.

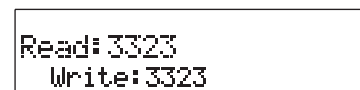

Example display

Note:

The number times 2 equals the actual read and write speed in kbps. For the example card, the total speed of the PMD671 and CF card was thus 6646 kbps. To read and write audio at 24-bit 96 kHz requires at least 4680 kbps.

Controls and Connections

Top continued

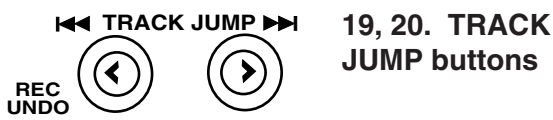
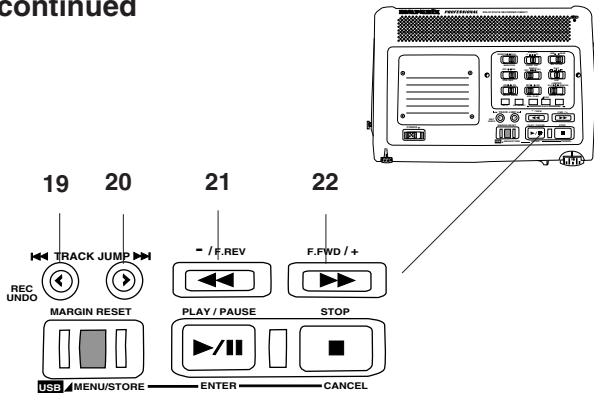

TRACK JUMP reverse button ◀◀
 REC UNDO button
 TRACK JUMP forward button ▶▶

19. TRACK JUMP reverse button ◀◀

During playback, press and release to jump to the previous track. If pressed while playing the first track, playback jumps to the last track on the CF card.

19. REC UNDO button

During recording, press and release twice to undo (erase) the recording and pause recording at the beginning of the track.

Example display during record.



Example display for 3 seconds after REC UNDO button is pressed.

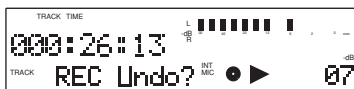

Example if REC UNDO button is pressed again within the 3 seconds.



Recording is at REC pause at the beginning of the track.

20. TRACK JUMP forward button ▶▶

During playback, press and release to jump to the next track. If pressed while playing the last track, playback jumps to the first track on the CF card.



21. -/F.REV button ◀◀

22. F.FWD/+ button ▶▶

During playback, press and hold the -/F.REV button ◀◀ to Fast Reverse and, do an audible search in the reverse direction. Press and hold the F.FWD/+ button ▶▶ to Fast Forward and, do a 2X speed audible search in the forward direction. Release to return to normal forward playback.

During play pause, press and hold the -/F.REV button ◀◀ or the F.FWD/+ button ▶▶ to Fast Reverse or Fast Forward quickly. The Fast Reverse or Fast Forward is at 10X speed for three seconds, then it automatically speeds up to 140X speed.

During Editing and Menu functions, press and release the -/F.REV button ◀◀ to increment a parameter in the - direction, and press and release the F.FWD/+ button ▶▶ to increment a parameter in the + direction.

Notes:

- If the -/F.REV button ◀◀ or the F.FWD/+ button ▶▶ is held past the beginning or end of a track, the Fast Reverse or Fast Forward will continue onto the previous or next track.
- If REPEAT SINGLE or REPEAT ALL is on, the Fast Reverse or Fast Forward will follow the repeat order.
- The buttons do not function in EDL playback or EDL A-B repeat.

Controls and Connections

Top continued

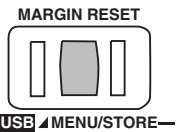
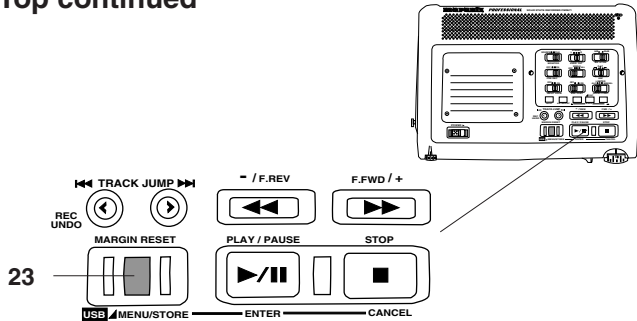

23. MARGIN RESET/ USB MENU/STORE buttons

Several functions depending on state of the PMD671.

MARGIN RESET button

During record, press and release to reset the peak level margin.

Example display with level margin at OV before pressing the MARGIN RESET button.



The level margin displays the highest level achieved since the track began, or the MARGIN RESET button was pressed and released. OV indicates a margin over 0dB.

USB button

Connects the CF card via the USB port to a connected device (usually a computer).

From power off, press and hold the USB button while you slide the PMD671's POWER switch to the right.

This display appears.



The CF card in the PMD671 appears as an external drive on a connected computer.

Power off to disconnect.

See page 51, How to connect via the USB port.

▲MENU/STORE button

Press and hold for about 2 seconds to enter menu mode.

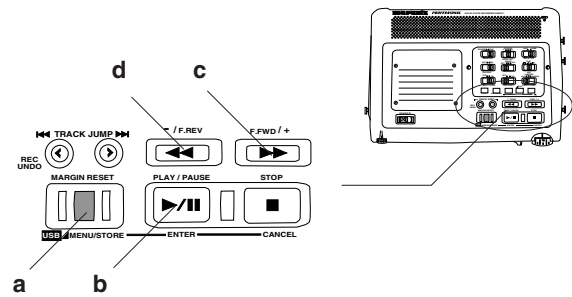

Press and release during menu operations to store the changed values.

Menu operations

Menu operations let you fine tune how the PMD671 is set up, including the recording parameters for your specific recording situation.

The PMD671 is always recording using Preset1, 2 or 3. To modify the recording setup, you modify one of those three presets.

The Menu procedure starts with selecting one of the Presets, then modifying either the settings within that Preset, or the General settings for Date and time, date format, beep and/or battery type.

Select Preset

Quick instructions

Press & hold ▲MENU/STORE 2 sec Preset
 Press ENTER ▶/|| Preset#
 Press F.FWD/+ ▶▶ set #
 Press ENTER ▶/|| save & switch to next item
 Press ▲MENU/STORE save & exit

1. Press and hold the ▲MENU/STORE button (a) for about 2 seconds. Preset will appear (flashing) in the display.

Example display

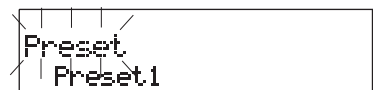

2. While Preset is flashing, press and release the ENTER button ▶/|| (b).

The flashing switches to the Preset choice.

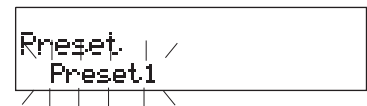

continues

- Press and release the F.FWD/+ button ►► (c) or the -/F.REV button ◀◀ (d) to tab through Preset1, Preset2 and Preset3.

Example display



- When the correct choice is displayed, press and release the ENTER button ►|| (b) to select your Preset choice.

The display switches to RecFormat flashing for your Preset choice.



You can:

- Press and release the ENTER button ►|| to switch to editing the Rec Format parameters of your Preset choice.
- Press and release the ▲MENU/STORE button to store your Preset choice and exit Menu mode.
- Press and release the CANCEL button ■ to exit menu mode without changing your Preset.
- Press and release the F.FWD/+ button ►► or the -/F.REV button ◀◀ to change menu settings that are not specific to a Preset. (The F.FWD/+ button ►► switches to MONITOR Mode, and the -/F.REV button ◀◀ switches to Default.)

Menu settings

- Press and hold the ▲MENU/STORE button (a) for about 2 seconds. Preset will appear (flashing) in the display.

Example display

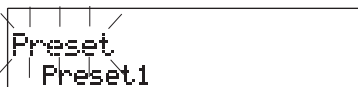

- While Preset is flashing, press and release the F.FWD/+ button ►►.

The display switches to Date/Time flashing.



The Menu choices are:

General settings

(common to Presets 1, 2 and 3)

Date/Time – For setting or changing the Date and Time associated with when an audio track (file) was created.

Date Form – For selecting the date order.

Beep – Turn the beep on or off.

A.PowOff – Enable or disable the Automatic Power Off feature.

Batt type – Set the battery type.

Preset - Choose 1, 2 or 3.

Within Preset choice:

RecFormat – For setting or changing the recording compression algorithm, bit rate, sampling frequency, audio file type, and if one or two input channels are to be recorded.

RAW Mode - Choose Monitor or TimeShft.

Verify - Set the automatic recording verify feature on or off.

PupPreRec - Set the power up pre record feature on* or off.

*If PupPreRec is on in the preset menu, AutoTrk will not work, even if it is set to on.

St Mode - If Stereo is set in RecFormat this sets how Left and Right input channels are recorded (Stereo, L-Stereo or 0-20dB).

Mono Mode - If Mono is set in RecFormat this sets how the source is recorded onto the MONO channel (Mono or L/R mix mono).

Auto Mark - Turn the automatic EDL mark feature on or off.

Manual TR – Turn manual track incrementing feature on or off.

Auto TRK - Turn the automatic track incrementing feature on or off, and if on, set the time interval.

SeamlsPly – Turn the Seamless play feature on or off.

SilentSkp – Turn Silent Skip feature ON, Off or ON with new track, set the number of seconds the dB level must meet or exceed the set threshold, and set the dB threshold level.

Auto Cue – Turn the Auto Cue feature on or off, set the number of milliseconds the dB level must meet or exceed the set threshold, and set the dB threshold level.

S.Monitor - Turn the Stop Monitor feature on or off.

SinglePly – Turn the single track play feature on or off.

Remote – Set the effect of the optional wired remote contact closure switch plugged into the REMOTE 1 jack.

ID1Dscprt – Set the description ID code for broadcast wave file recordings.

ID2Origin – Set the origin ID code for broadcast wave file recordings.

ID3OrgRef – Set the origin reference ID code for broadcast wave file recordings.

Default – Reset all Menu settings to factory default settings.

How to set or change the Date and time

The date and time are written on each audio track (file) when the track is started. When an audio track is viewed on a computer, this date and time appears as when the file was 'modified'. (US date format is illustrated.)

Quick instructions

Press & hold ▲MENU/STORE 2 sec Preset
 Press F.FWD/+ ►► Date/Time
 Press ENTER ►/|| month
 Press F.FWD/+ ►► repeatedly correct month
 Press ENTER ►/|| day
 Press F.FWD/+ ►► repeatedly correct day
 Press ENTER ►/|| year
 Press F.FWD/+ ►► repeatedly correct year
 Press ENTER ►/|| hour
 Press F.FWD/+ ►► repeatedly correct hour
 Press ENTER ►/|| minute
 Press F.FWD/+ ►► repeatedly correct minute
 Press ENTER ►/|| Date/Time
 Press ▲MENU/STORE store & exit

1. From stop, press and hold the ▲MENU/STORE button for about 2 seconds. Preset will appear (flashing) in the display.

Example display



2. With Preset flashing, press and release the F.FWD/+ button ►►.

The Date/Time Menu choice will most likely appear.



Note

If another Menu choice appears (Date Form, Beep, A.PowOff, Batt type) press and release the F.FWD/+ button repeatedly until Date/Time is displayed.

3. Press and release the ENTER button ►/||.

The current date and time information will be displayed with the month flashing.

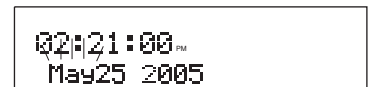

Example display

4. With the month flashing press and release the F.FWD/+ button ►► or the -/F.REV button ◀◀ to tab through the months. When the month is correct, press and release the ENTER button ►/||.



Example display

The day will be flashing.

5. With the day flashing press and release the F.FWD/+ button ►► or the -/F.REV button ◀◀ to tab through days. When the day is correct, press and release the ENTER button ►/||. The year will be flashing.

Example display



6. With the year flashing press and release the F.FWD/+ button ►► or the -/F.REV button ◀◀ to tab through years (2005 - 2099). When the year is correct, press and release the ENTER button ►/||.

The hour will be flashing.

Example display.

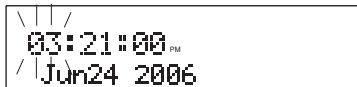

- With the hour flashing, press and release the F.FWD/+ button ►► or the -/F.REV button ◀◀ to tab through hours. AM, PM will change when you pass 12, check that it is correct. When the hour and AM/PM is correct, press and release the ENTER button ►||.
- The minute will be flashing.

Example display

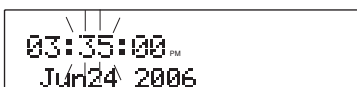

- With the minute flashing, press and release the F.FWD/+ button ►► or the -/F.REV button ◀◀ to tab through minutes. When the minute is correct*, press and release the ENTER button ►||.

Date/Time will be flashing.

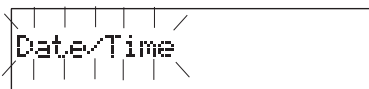

*To set time correct to the second, set to the next minute and wait for that minute to begin before pressing the ENTER button ►||.

- Press and release the ▲MENU/STORE button. If you have made changes to the date and/or time, Stored will be displayed briefly.



The display will return to stop mode.

Note:

The date and time settings will remain for about 5 years if the AC Adapter is not plugged in and no batteries are installed.

Date Form

The Date Form is the date order month/day/year or day/month/year.

The US default is M/D/Y (month/day/year).

The Europe default is D/M/Y (day/month/year).

How to set or change the Date Form

Quick instructions

Press & hold ▲MENU/STORE 2 sec Preset
 Press F.FWD/+ ►► 2X Date Form
 Press ENTER ►|| M/D/Y or D/M/Y
 Press F.FWD/+ ►► M/D/Y or D/M/Y
 Press ENTER ►|| Date Form
 Press ▲MENU/STORE store & exit

- From stop, press and hold the ▲MENU/STORE button for about 2 seconds. Preset will appear (flashing) in the display.

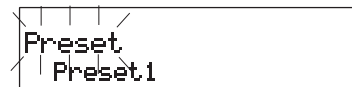

- With Preset flashing, press and release the F.FWD/+ button ►► repeatedly until Date Form is displayed.

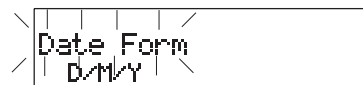

- Press and release the ENTER button ►|| again. The M/D/Y choice will flash.



- Press and release the F.FWD/+ button ►► or the -/F.REV button ◀◀ to toggle between M/D/Y and D/M/Y.



- When the desired form appears, press and release the ENTER button ►||. The display returns to Date Form flashing.



You can:

- Press and release the F.FWD/+ button ►► or the -/F.REV button ◀◀ to tab to another menu choice, or
- Press and release the ▲MENU/STORE button to write the menu changes and return to stop mode, or
- Press and release the CANCEL button ■ to cancel all menu changes and return to stop mode.

Beep

When battery charge can provide no more than 1-3 minutes of recording or playback and Beep is set to On, the CHARGE indicator, REC indicator and the battery indicator in the display will flash, and the PMD671 will beep through the headphones or speaker.

If the PMD671 is not operated for 30 minutes during stop or play pause, power can be automatically shut off to conserve battery life. (See A.PowOFF.) If A.PowOFF is set to Yes, and Beep is set to ON, the PMD671 will beep to alert you that the power is shutting off.

Default is Beep On.

How to set or change the Beep

Quick instructions

Press & hold ▲MENU/STORE 2 sec Preset
 Press F.FWD/+ ►► 3X Beep
 Press ENTER ►|| Off or On
 Press F.FWD/+ ►► Off or On
 Press ENTER ►|| Beep
 Press ▲MENU/STORE store & exit

1. From stop, press and hold the ▲MENU/STORE button for about 2 seconds. Preset will appear (flashing) in the display.

Example display

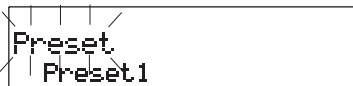

2. While Preset is flashing, press and release the F.FWD/+ button ►► repeatedly until Beep is displayed.

Example display



3. Press and release the ENTER button ►||. The On-Off choice will flash.

Example display



4. Press and release the F.FWD/+ button ►► or the -/F.REV button ◀◀ to toggle between On and Off.

Example display



5. When the desired state appears press and release the ENTER button ►||. The display returns to Beep flashing.

Example display



You can:

- Press and release the F.FWD/+ button ►► or the -/F.REV button ◀◀ to tab to another menu choice, or
- Press and release the ▲MENU/STORE button to write the menu changes and return to stop mode, or
- Press and release the CANCEL button ■ to cancel all menu changes and return to stop mode.

Automatic Power Off

If the PMD671 is not operated for 30 minutes during stop or play pause, power is automatically shut off to conserve battery life when A.PowOff is set to Yes.

Default is A.PowOFF Yes

How to set or change Automatic Power Off

Quick instructions

Press & hold ▲MENU/STORE 2 sec Preset
 Press F.FWD/+ ►► 4X A.PowOff
 Press ENTER ►|| Yes or No
 Press F.FWD/+ ►► Yes or No
 Press ENTER ►|| A.PowOff
 Press ▲MENU/STORE store & exit

1. From stop, press and hold the ▲MENU/STORE button for about 2 seconds. Preset will appear (flashing) in the display.

Example display



2. While Preset is flashing, press and release the F.FWD/+ button ►► repeatedly until A.PowOff is displayed.

Example display

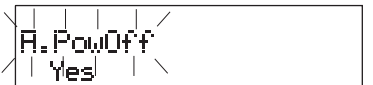

3. Press and release the ENTER button ►||. The Yes-No choice will flash.

Example display

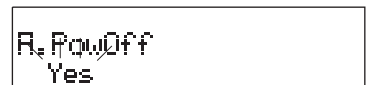

- Press and release the F.FWD/+ button ►► or the -/F.REV button ◀◀ to toggle between Yes and No.



- When the desired state appears, press and release the ENTER button ►||. The display returns to A.PowOff flashing.

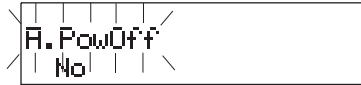

You can:

- Press and release the F.FWD/+ button ►► or the -/F.REV button ◀◀ to tab to another menu choice, or
- Press and release the ▲MENU/STORE button to write the menu changes and return to stop mode, or
- Press and release the CANCEL button ▲ to cancel all menu changes and return to stop mode.

Battery Type

The PMD671 can operate on 8 standard AA size Alkaline, Ni-Cd or Ni-MH batteries.

An optional Ni-Cd battery pack (Model RB1100 available from Marantz Professional) will be charged by the built-in charger when the AC adaptor is plugged in.

An optional Ni-MH battery pack (Model RB1651 available from Marantz Professional) will be charged by the built-in charger when the AC adaptor is plugged in.

The Battery Type setting is used for the battery indicator in the display and "Low Battery" warning. If the setting does not match installed batteries the PMD671 will not show the appropriate battery status.

Default is Alkaline.

How to set or change Battery Type

Quick instructions

Press & hold ▲MENU/STORE 2 sec Preset
 Press F.FWD/+ ►► 5X Batt type
 Press ENTER ►|| battery type flashing
 Press F.FWD/+ ►► tab thru battery types
 Press ENTER ►|| Batt type
 Press ▲MENU/STORE store & exit

- From stop, press and hold the ▲MENU/STORE button for about 2 seconds. Preset will appear (flashing) in the display.

Example display

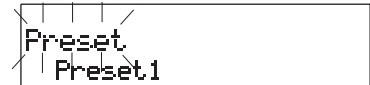

- With Preset flashing, press and release the F.FWD/+ button ►► repeatedly until Batt type is displayed.



- Press and release the MENU button ►||.

The Batt type choice will flash.

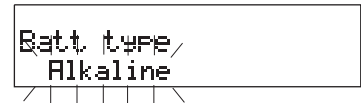

- Press and release the F.FWD+ button ►► to tab through the Battery type choices.



- With the desired battery type displayed, press and release the ENTER button ►||. The display returns to Batt type flashing.



You can:

- Press and release the F.FWD/+ button ►► or the -/F.REV button ◀◀ to tab to another menu choice, or
- Press and release the ▲MENU/STORE button to write the menu changes and return to stop mode, or
- Press and release the CANCEL button ■ to cancel all menu changes and return to stop mode.

Rec Format

The PMD671 can record from analog or digital inputs, on one channel (mono) or two (stereo), in PCM at 24 or 16 bits, and in MP2 or MP3 compression formats.

For given channels and formats the PMD671 can record at several bit rates and sample frequencies.

The file extension (.wav, .mpg, .mp3) is set by the file format chosen (PCM, MP2, MP3) except for BWF files (Broadcast Wave Format). The BWF file extension can be either .wav, or .bwf.

As audio quality goes up (more bits, less compression, higher sampling frequency, greater bit rate), the amount of information recorded increases so the amount of time that can be recorded on a CF card of a specific size goes down. See Recording time chart on page 57.

The PMD671 has a sizeable range of file format parameter choices available, but it does not present you with every possible combination.

Your decisions about which File Format parameters to use will depend on the quality level you need for the purpose(s) of your recording versus limitations in recording time.

Note:

At very high audio quality levels, processor power also becomes a limitation. The RAW (Read After Write) and Time Shift features are processor intensive, so in some instances the MONITOR and Verify features and 24-bit recording cannot be used simultaneously. See charts on page 14.

The File Format chart below follows the PMD671 File Format menu setting procedure as you read columns from left to right.

Note

A full size copy of this chart is on page 58.

Rec Format Chart

Channel(s)	Audio Format	Fs kHz and (Bit rate kbps)	File ext.	BWF ext.
Stereo	PCM	24 bit	96, 88.2, 48, 44.1	wav/bwf
		16 bit	48, 44.1, 32, 24, 22.05, 16, 12, 11.025, 8	
	MP2	48, 44.1, 32 (384, 256, 192, 128, 96, 64)	mpg/bwf	
	MP3	48, 44.1, 32 (320, 256, 160, 128, 80, 64)	mp3/bwf	
24, 22.05, 16 (160, 128, 80, 64, 40, 32)		mp3/bwf		
Mono	PCM	24 bit	96, 88.2, 48, 44.1	wav/bwf
		16 bit	48, 44.1, 32, 24, 22.05, 16, 12, 11.025, 8	
	MP2	48, 44.1, 32 (192, 128, 96, 64, 48, 32)	mpg/bwf	
	MP3	48, 44.1, 32 (160, 128, 80, 64, 40, 32)	mp3/bwf	
24, 22.05, 16 (80, 64, 40, 32, 24, 16)		mp3/bwf		

The RecFormat setting procedure is usually unnecessary for Digital Input. See page 34. The following applies to inputs from MIC, LINE IN, and the Internal mic.

Channel(s)

Choose between Stereo and Mono recording (two or one channel). For PCM recording, Stereo is about twice as time intensive as Mono.

Format

Choose between PCM (16 or 24 bit) or a compression format (MP2 or MP3).

Fs (Sampling Frequency)

Choose the Sample Frequency (in kHz).

Bit rate

You can select a bit rate in kilobits per second (kbps) for a compression format (MP2 or MP3).

File ext. (File extension)

In most cases, you have chosen the file extension by choosing the Format. If you desire a BWF file choose between .wav and .bwf for the file extension.

How to set or change the Rec Format parameters.

Quick instructions

Press & hold **▲MENU/STORE** 2 sec Preset
 Double Click **ENTER** ▶/|| RecFormat
 Press **ENTER** ▶/|| Mono or Stereo
 Press **F.FWD/+** ▶▶ Mono or Stereo
 Press **ENTER** ▶/|| PCM, MP2 or MP3
 Press **F.FWD/+** ▶▶ PCM, MP2 or MP3
 If MP2 or MP3 khz
 Press **F.FWD/+** ▶▶ select khz
 Press **ENTER** ▶/|| kbps
 Press **F.FWD/+** ▶▶ select kbps
 Press **ENTER** ▶/|| select file extension
 Press **F.FWD/+** ▶▶ mp3, mpg, wav, bwf
 If bwf Exten (.bwf, wav)
 Press **F.FWD/+** ▶▶ bwf, wav
 If PCM 24 or 16 bit
 Press **F.FWD/+** ▶▶ 24 or 16 bit
 Press **ENTER** ▶/|| khz
 Press **F.FWD/+** ▶▶ select khz
 Press **ENTER** ▶/|| select file extension
 Press **F.FWD/+** ▶▶ wav, bwf
 If bwf Exten (.bwf, wav)
 Press **F.FWD/+** ▶▶ bwf, wav
 Press **ENTER** ▶/|| RecFormat
 Press **▲MENU/STORE** store & exit

3. Press and release the **ENTER** button ▶/||.

Mono or Stereo will be flashing.



Note

The circled items in the chart below reflect the settings in the example.

Channel(s)	Audio Format	Fs kHz and (Bit rate kbps)	File ext.	BWF ext.
Stereo	PCM	24 bit	wav/bwf	wav/bwf
		16 bit		
	MP2	mpg/bwf		
	MP3	mp3/bwf		
mp3/bwf				
Mono	PCM	24 bit	wav/bwf	wav/bwf
		16 bit		
	MP2	mpg/bwf		
	MP3	mp3/bwf		
mp3/bwf				

continues

1. Press and hold the **▲MENU/STORE** button.



Preset flashing appears.

2. Double click the **ENTER** button ▶/|| so

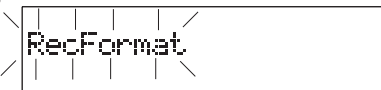

RecFormat is flashing.

Note

If another menu item is flashing, press and release the **F.FWD/+** button ▶▶ repeatedly until RecFormat is displayed and flashing.

4. Press and release the F.FWD/+ button ►► to toggle between Mono and Stereo. When correct, press and release the ENTER button ►/||. The display switches to Format flashing.

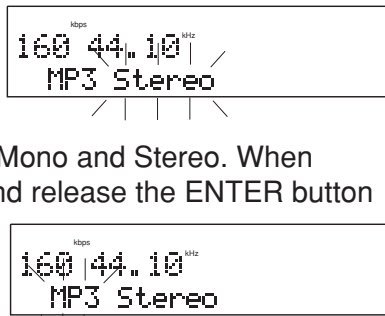

Note
In the example, the change from Mono to Stereo automatically doubled the bit rate. The change is illustrated in the chart below.

Channel(s)	Audio Format	Fs kHz and (Bit rate kbps)	File ext.	BWF ext.
Stereo	PCM	24 bit	96, 88.2, 48, 44.1	wav/bwf
		16 bit	48, 44.1, 32, 24, 22.05, 16, 12, 11.025, 8	
	MP2	48, 44.1, 32 (384, 256, 192, 128, 96, 64)	mpg/bwf	
	MP3	48, 44.1, 32 (320, 256, 160, 128, 80, 64)	mp3/bwf	
24, 22.05, 16 (160, 128, 80, 64, 40, 32)		mp3/bwf		
Mono	PCM	24 bit	96, 88.2, 48, 44.1	wav/bwf
		16 bit	48, 44.1, 32, 24, 22.05, 16, 12, 11.025, 8	
	MP2	48, 44.1, 32 (192, 128, 96, 64, 48, 32)	mpg/bwf	
	MP3	48, 44.1, 32 (160, 128, 80, 64, 40, 32)	mp3/bwf	
		24, 22.05, 16 (80, 64, 40, 32, 24, 16)	mp3/bwf	

Channel(s)	Audio Format	Fs kHz and (Bit rate kbps)	File ext.	BWF ext.
Stereo	PCM	24 bit	96, 88.2, 48, 44.1	wav/bwf
		16 bit	48, 44.1, 32, 24, 22.05, 16, 12, 11.025, 8	
	MP2	48, 44.1, 32 (384, 256, 192, 128, 96, 64)	mpg/bwf	
	MP3	48, 44.1, 32 (320, 256, 160, 128, 80, 64)	mp3/bwf	
24, 22.05, 16 (160, 128, 80, 64, 40, 32)		mp3/bwf		
Mono	PCM	24 bit	96, 88.2, 48, 44.1	wav/bwf
		16 bit	48, 44.1, 32, 24, 22.05, 16, 12, 11.025, 8	
	MP2	48, 44.1, 32 (192, 128, 96, 64, 48, 32)	mpg/bwf	
	MP3	48, 44.1, 32 (160, 128, 80, 64, 40, 32)	mp3/bwf	
		24, 22.05, 16 (80, 64, 40, 32, 24, 16)	mp3/bwf	

6. Press and release the F.FWD/+ button ►► to toggle between 16 bit and 24 bit PCM.

When correct, press and release the ENTER button ►/||.

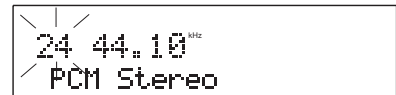

The display switches to the next RecFormat menu choice flashing.



Note
The chart below reflects the settings change.

5. Press and release the F.FWD/+ button ►► to tab through MP3, MP2 and PCM. Note that other changes occur when the format changes. When correct, press and release the ENTER button ►/||. The display switches to the next RecFormat menu choice flashing.



Note
In our example, we chose PCM. The chart below reflects the settings change.

Channel(s)	Audio Format	Fs kHz and (Bit rate kbps)	File ext.	BWF ext.
Stereo	PCM	24 bit	96, 88.2, 48, 44.1	wav/bwf
		16 bit	48, 44.1, 32, 24, 22.05, 16, 12, 11.025, 8	
	MP2	48, 44.1, 32 (384, 256, 192, 128, 96, 64)	mpg/bwf	
	MP3	48, 44.1, 32 (320, 256, 160, 128, 80, 64)	mp3/bwf	
24, 22.05, 16 (160, 128, 80, 64, 40, 32)		mp3/bwf		
Mono	PCM	24 bit	96, 88.2, 48, 44.1	wav/bwf
		16 bit	48, 44.1, 32, 24, 22.05, 16, 12, 11.025, 8	
	MP2	48, 44.1, 32 (192, 128, 96, 64, 48, 32)	mpg/bwf	
	MP3	48, 44.1, 32 (160, 128, 80, 64, 40, 32)	mp3/bwf	
		24, 22.05, 16 (80, 64, 40, 32, 24, 16)	mp3/bwf	

7. Press and release the F.FWD/+ button ►► to tab through the available bit rate settings. When correct, press and release the ENTER button ►||.



The display switches to the next RecFormat menu choice flashing.

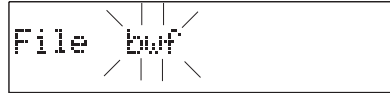

Notes

In the example there is no choice of sample frequency so the next RecFormat choice is displayed. The chart below reflects the settings change.

Channel(s)	Audio Format	Fs kHz and (Bit rate kbps)	File ext.	BWF ext.
Stereo	PCM	24 bit	96, 88.2, 48, 44.1	wav/bwf
		16 bit	48, 44.1, 32, 24, 22.05, 16, 12, 11.025, 8	
	MP2	48, 44.1, 32 (384, 256, 192, 128, 96, 64)	mpg/bwf	wav/bwf
	MP3	48, 44.1, 32 (320, 256, 160, 128, 80, 64)	mp3/bwf	
		24, 22.05, 16 (160, 128, 80, 64, 40, 32)	mp3/bwf	
Mono	PCM	24 bit	96, 88.2, 48, 44.1	wav/bwf
		16 bit	48, 44.1, 32, 24, 22.05, 16, 12, 11.025, 8	
	MP2	48, 44.1, 32 (192, 128, 96, 64, 48, 32)	mpg/bwf	
	MP3	48, 44.1, 32 (160, 128, 80, 64, 40, 32)	mp3/bwf	
		24, 22.05, 16 (80, 64, 40, 32, 24, 16)	mp3/bwf	

8. Press and release the F.FWD/+ button ►► to toggle between a bfw file and the other available file type.

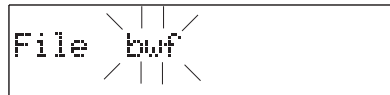

When correct, press and release the ENTER button ►||.

The display switches to the next RecFormat menu choice flashing.

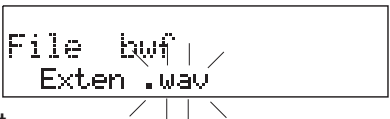

Notes

In the example bfw was chosen so the wav/bwf RecFormat choice is displayed. The chart below reflects this settings change.

Channel(s)	Audio Format	Fs kHz and (Bit rate kbps)	File ext.	BWF ext.
Stereo	PCM	24 bit	96, 88.2, 48, 44.1	wav/bwf
		16 bit	48, 44.1, 32, 24, 22.05, 16, 12, 11.025, 8	
	MP2	48, 44.1, 32 (384, 256, 192, 128, 96, 64)	mpg/bwf	wav/bwf
	MP3	48, 44.1, 32 (320, 256, 160, 128, 80, 64)	mp3/bwf	
		24, 22.05, 16 (160, 128, 80, 64, 40, 32)	mp3/bwf	
Mono	PCM	24 bit	96, 88.2, 48, 44.1	wav/bwf
		16 bit	48, 44.1, 32, 24, 22.05, 16, 12, 11.025, 8	
	MP2	48, 44.1, 32 (192, 128, 96, 64, 48, 32)	mpg/bwf	
	MP3	48, 44.1, 32 (160, 128, 80, 64, 40, 32)	mp3/bwf	
		24, 22.05, 16 (80, 64, 40, 32, 24, 16)	mp3/bwf	

9. Press and release the F.FWD/+ button ►► to toggle between a .wav and a .bwf file extension.

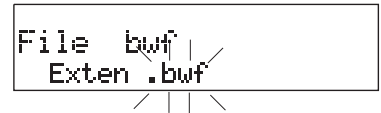

When correct, press and release the ENTER button ►||.

The display returns to the RecFormat menu choice flashing.



You can:

- Press and release the F.FWD/+ button ►► or the -/ F.REV button ◀◀ to tab to another menu choice, or
- Press and release the ▲ MENU/STORE button to write the menu changes and return to stop mode, or
- Press and release the CANCEL button ■ to cancel all menu changes and return to stop mode.

Digi-IN Rec Format

Most of the RecFormat parameters recorded from a digital input source are determined by the input source. They are not changed because of settings made in the RecFormat menu.

The shaded areas in the chart below are set by the input source and ignore RecFormat menu settings.

Digi-IN RecFormat chart

Channel(s)	Audio Format	Fs kHz and (Bit rate kbps)	File ext.	BWF ext.	
Stereo	PCM	24 bit	96, 88.2, 44, 44.1	wav/bwf	
		16 bit	48, 44.1		
	MP2	48, 44.1 (384, 256, 192, 128, 96, 64)	mpg/bwf	wav/bwf	
	MP3	48, 44.1 (320, 256, 160, 128, 80, 64)	mp3/bwf		
Mono	PCM	24 bit	96, 88.2, 44, 44.1		wav/bwf
		16 bit	48, 44.1		
	MP2	48, 44.1 (192, 128, 96, 64, 48, 32)	mpg/bwf	wav/bwf	
	MP3	48, 44.1 (160, 128, 80, 64, 40, 32)	mp3/bwf		

RAW Mode

RAW (Read After Write) mode sets the operation of the MONITOR switch.

RAW is an electronic Read After Write. In all modes except 24 bit recording, the PMD671 can read a recording on the CF Card while simultaneously recording onto the CF Card.

When RAW Mode is at Monitor and if the MONITOR switch is at FILE when recording begins, the monitoring signal sent to the PHONES jack and LINE OUT jacks is read from the CF card a maximum of 2 seconds after it is recorded. Thus, the monitored signal is not the source but is the recording.

When RAW Mode is at TimeShft and if the MONITOR switch is at FILE when recording begins, the monitoring signal sent to the PHONES jack and LINE OUT jacks is the same as the source until a playback button is activated. (PLAY/PAUSE, TRACK JUMP, F.FWD or F.REV) The recording before the playback button was activated, and previously recorded tracks, can then be monitored and reviewed using normal playback controls while recording continues.

Notes:

- An audio drop out of the monitoring signal may occur during RAW during high bit rate MP3 recording.
- RAW and 24-bit recording requires high CF card access speed (see CARD CHECK page 22).
- RAW is not available for 24-bit recording.
- Verify is simultaneously available with RAW or Time Shift for appropriate files (see charts on page 14).

How to set or change the RAW Mode

Quick instructions

Press & hold **MENU/STORE** 2 sec Preset
 Double Click **ENTER** ▶/|| RecFormat
 Press **F.FWD/+** ▶▶ RAW Mode
 Press **ENTER** ▶/|| Monitor/TimeShft
 Press **F.FWD/+** ▶▶ toggle Monitor/TimeShft
 Press **ENTER** ▶/|| RAW Mode
 Press **MENU/STORE** store & exit

1. From stop, press and hold the **MENU/STORE** button for about 2 seconds. Preset will appear (flashing) in the display.

Example display

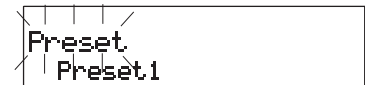

2. While Preset is flashing, double click the **ENTER** button ▶/||.

Example display

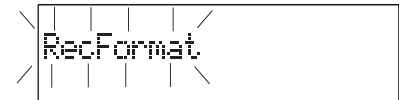

A menu choice will be flashing.

3. Press and release the **F.FWD/+** button ▶▶

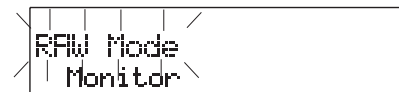

until RAW Mode is displayed.

4. With RAW Mode flashing, press and release the **ENTER** button ▶/||.

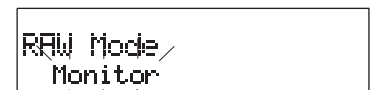

The RAW Mode menu choice is flashing.

5. Press and release the **F.FWD/+** button ▶▶ to toggle between Monitor and TimeShft.

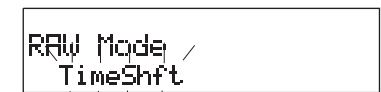

6. When the desired state is displayed, press and release the **ENTER** button ▶/||.

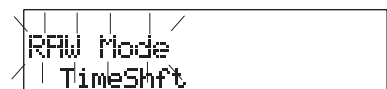

The display returns to RAW Mode flashing.

You can:

- Press and release the F.FWD/+ button ►► or the -/ F.REV button ◀◀ to tab to another menu choice, or
- Press and release the ▲MENU/STORE button to write the menu changes and return to stop mode, or
- Press and release the CANCEL button ■ to cancel all menu changes and return to stop mode.

Verify

Verify is an automatic, electronic, Read After Write check. With Verify On, the PMD671 continually reads the CF card about one second after the recording. It compares what is recorded to the source signal. A mismatch results in an error message.

Verify does not depend on the position of the MONITOR switch.

Verify does not function during MP2 recording.

See charts on page 14.

How to set or change Verify

Quick instructions

Press & hold ▲MENU/STORE 2 sec Preset
 Double Click ENTER ►|| RecFormat
 Press F.FWD/+ ►► until Verify
 Press ENTER ►|| Off/On
 Press F.FWD/+ ►► toggle Off/On
 Press ENTER ►|| Verify
 Press ▲MENU/STORE store & exit

1. From stop, press and hold the ▲MENU/STORE button for about 2 seconds. Preset will appear (flashing) in the display.

2. While Preset is flashing, double click the ENTER button ►||.

Example display

A menu choice will be flashing.

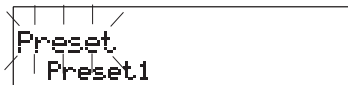

3. Press and release the F.FWD/+ button ►► until Verify is displayed.



4. With Verify flashing, press and release the ENTER button ►||. Verify menu choice is flashing.

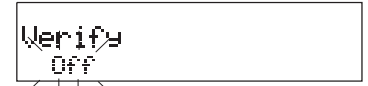

5. Press and release the F.FWD/+ button ►► to toggle between On and Off.



6. When the desired state is displayed, press and release the ENTER button ►||.



The display returns to Verify flashing.

You can:

- Press and release the F.FWD/+ button ►► or the -/ F.REV button ◀◀ to tab to another menu choice, or
- Press and release the ▲MENU/STORE button to write the menu changes and return to stop mode, or
- Press and release the CANCEL button ■ to cancel all menu changes and return to stop mode.

PupPreRec

Power Up Pre Record buffers (remembers) audio during REC PAUSE. When you slide the REC switch to engage record, CONT? is displayed.

- Press and release the PLAY button ►|| to record the buffered audio and continue recording.
- Slide and release the REC switch again to discard the buffered audio and continue recording from that point.
- Press and release the STOP button ■ to discard the buffered audio and stop recording.

Note:

If there is less than 5 minutes of REC REMAIN time PupPreRec does not work.

How to set or change PupPreRec

Quick instructions

Press & hold ▲MENU/STORE 2 sec Preset
 Double Click ENTER ►|| RecFormat
 Press F.FWD/+ ►► until PupPreRec
 Press ENTER ►|| Off/On
 Press F.FWD/+ ►► toggle Off/On

1. From stop, press and hold the ▲MENU/STORE button for about 2 seconds.



Example display

2. With Preset flashing in the display, double click the ENTER button ►||.

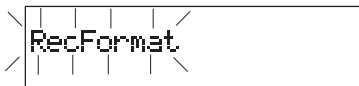

3. Press and release the F.FWD/+ button ►► until PupPreRec is displayed.



4. With PupPreRec flashing, press and release the ENTER button ►||.



PupPreRec menu choice is flashing.

5. Press and release the F.FWD/+ button ►► to toggle between On and Off.

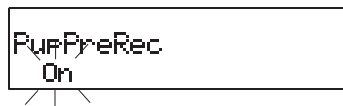

6. When the desired state is displayed, press and release the ENTER button ►||.



The display returns to PupPreRec flashing.

You can:

- Press and release the F.FWD/+ button ►► or the -/ F.REV button ◀◀ to tab to another menu choice, or
- Press and release the ▲MENU/STORE button to write the menu changes and return to stop mode, or
- Press and release the CANCEL button ■ to cancel all menu changes and return to stop mode.

St Mode

Stereo Mode determines which input channels are recorded onto the Left and Right channels.

There are three Stereo Modes:

Stereo - The Left input channel is recorded onto the Left channel, and the Right input channel is recorded onto the Right channel.

L-Stereo - The Left input channel is recorded onto the Left channel, and onto the Right channel.

0-20dB - For secure recording, the Left channel is recorded at the normal record level and the Right channel is reduced by 20dB.

Notes:

- If the input is set to INT MIC and St Mode is set to 0-20dB, the St Mode of the recording is automatically switched to L-Stereo.
- If a mono source input (INT MIC or L channel only) the mono input is also recorded on the R channel reduced by 20dB.

How to set or change St Mode

Quick instructions

Press & hold ▲MENU/STORE 2 sec Preset
 Double Click ENTER ►|| RecFormat
 Press F.FWD/+ ►► until St Mode
 Press ENTER ►|| Stereo/L-Stereo/0-20dB
 Press F.FWD/+ ►► tab thru modes
 Press ENTER ►|| St Mode
 Press ▲MENU/STORE store & exit

1. From stop, press and hold the ▲MENU/STORE button for about 2 seconds.

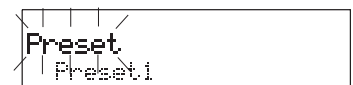

2. With Preset flashing in the display, double click the ENTER button ►||.



3. Press and release the F.FWD/+ button ►► until St Mode is displayed.



4. With St Mode flashing, press and release the ENTER button ►||.



St Mode menu choice is flashing.

- Press and release the F.FWD/+ button ►► to tab through Stereo, L-Stereo and 0-20db.
- When the desired mode is displayed, press and release the ENTER button ►||. The display returns to St Mode flashing.

You can:

- Press and release the F.FWD/+ button ►► or the -/ F.REV button ◀◀ to tab to another menu choice, or
- Press and release the ▲MENU/STORE button to write the menu changes and return to stop mode, or
- Press and release the CANCEL button ■ to cancel all menu changes and return to stop mode.

Mono Mode

Mono Mode determines which input channel(s) are recorded as the mono channel.

There are two Mono Modes:



Mono - The Left input channel is recorded as the mono channel.

LR Mono - The Left input channel and the Right input channel are mixed (combined) and recorded [(L+R)/2] as the mono channel.

How to set or change Mono Mode

Quick instructions

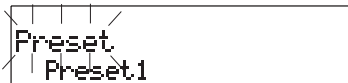
Press & hold ▲MENU/STORE 2 sec Preset
 Double Click ENTER ►|| RecFormat
 Press F.FWD/+ ►► until Mono Mode
 Press ENTER ►|| Mono/LRmono
 Press F.FWD/+ ►► tab thru modes
 Press ENTER ►|| Mono Mode
 Press ▲MENU/STORE store & exit

- From stop, press and hold the ▲MENU/STORE button for about 2 seconds. 
- With Preset flashing in the display double click the ENTER button ►||. 

- Press and release the F.FWD/+ button ►► until Mono Mode is displayed. 

- With Mono Mode flashing Press and release the ENTER button ►||. Mono Mode menu choice flashing. 

- Press and release the F.FWD/+ button ►► to toggle between Mono and LRmono. 

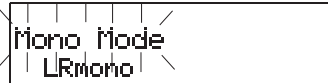
- When the desired mode is displayed, press and release the ENTER button ►||. The display returns to Mono Mode flashing. 

You can:

- Press and release the F.FWD/+ button ►► or the -/ F.REV button ◀◀ to tab to another menu choice, or
- Press and release the ▲MENU/STORE button to write the menu changes and return to stop mode, or
- Press and release the CANCEL button ■ to cancel all menu changes and return to stop mode.

Auto Mark

Auto Mark turns the automatic EDL mark feature on or off.

On - During record after a REC PAUSE, an EDL mark is added to the track.

As recording is resumed and the EDL mark is added, the following appear for a few seconds.

Example display

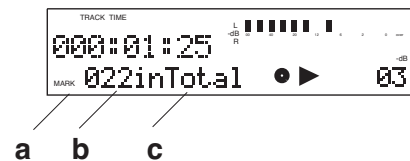



MARK (a) is displayed to indicate that the number (b) is the EDL mark number. "In Total" (c) reminds you that EDL marks are counted from the beginning of the CF card, not the beginning of the current track.

Off - Pause during record does not add an EDL mark to the track.

How to set or change Auto Mark

Quick instructions

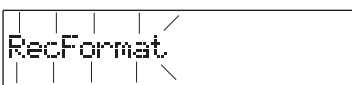
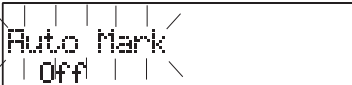
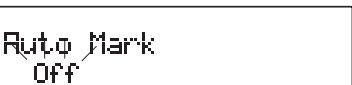
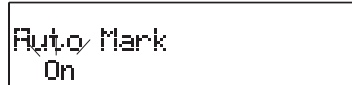
Press & hold ▲MENU/STORE 2 sec Preset
 Double Click ENTER ▶/■ RecFormat
 Press F.FWD/+ ▶▶ until Auto Mark
 Press ENTER ▶/■ Off/On
 Press F.FWD/+ ▶▶ toggle Off/On
 Press ENTER ▶/■ Auto Mark
 Press ▲MENU/STORE store & exit

- From stop, press and hold the ▲MENU/STORE button for about 2 seconds.
 
- With Preset flashing in the display double click the ENTER button ▶/■.
 
- Press and release the F.FWD/+ button ▶▶ until Auto Mark is displayed.
 
- With Auto Mark flashing. press and release the ENTER button ▶/■. Auto Mark menu choice is flashing.
 
- Press and release the F.FWD/+ button ▶▶ to toggle between On and Off.
 
- When correct, press and release the ENTER button ▶/■. The display returns to Auto Mark flashing.
 

You can:

- Press and release the F.FWD/+ button ▶▶ or the -/F.REV button ◀◀ to tab to another menu choice, or
- Press and release the ▲MENU/STORE button to write the menu changes and return to stop mode, or
- Press and release the CANCEL button ■ to cancel all menu changes and return to stop mode.

Manual TR





When Manual track incrementing is on, slide and release the REC switch during recording to increment the track. A new track is created at that point. There is no break in recording. When Manual track incrementing is off, sliding and releasing REC switch during recording does nothing.

Default setting is On.

How to set or change Manual TR

Quick instructions

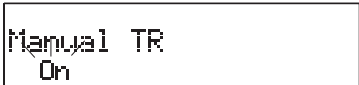
Press & hold ▲MENU/STORE 2 sec Preset
 Double Click ENTER ▶/■ RecFormat
 Press F.FWD/+ ▶▶ until Manual TR
 Press ENTER ▶/■ Off/On
 Press F.FWD/+ ▶▶ toggle Off/On
 Press ENTER ▶/■ Manual TR
 Press ▲MENU/STORE store & exit

- From stop, press and hold the ▲MENU/STORE button for about 2 seconds.
 
- With Preset flashing in the display, double click the ENTER button ▶/■.
 
- Press and release the F.FWD/+ button ▶▶ until Manual TR is displayed.
 
- With Manual TR flashing, press and release the ENTER button ▶/■. Manual TR menu choice is flashing.
 
- Press and release the F.FWD/+ button ▶▶ to toggle between On and Off.
 
- When correct, press and release the ENTER button ▶/■. The display returns to Manual TR flashing.
 

You can:

- Press and release the F.FWD/+ button ►► or the -/ F.REV button ◀◀ to tab to another menu choice, or
- Press and release the ▲ MENU/STORE button to write the menu changes and return to stop mode, or
- Press and release the CANCEL button ■ to cancel all menu changes and return to stop mode.

Auto TRK

During recording, Auto Track Incrementing breaks the recording into multiple tracks of a preset length of time. At the preset time, the next track number is begun without stopping recording.

Timed tracks are helpful when recording long sessions such as meetings, speeches, surveillance sessions, or recordings for transcription. During playback, timed tracks make finding a particular passage easy because of the relationship between track numbers and time.

Auto Track Incrementing can be On or Off. If On, the time interval can be set to: 1, 5, 10, 15 or 30 minutes; or 1, 2, 6, 8, 12 or 24 hours.

For example, if **Minute Track** is recorded (a new track every minute) you can select track 3 to play approximately the 3rd minute of recording. To go directly to the beginning of the 10th minute, select track 10, etc.

The table below shows the relationship between time and tracks in Minute Track.

Track #	Recording time minutes:seconds
1	0:00 - 0:59
2	1:00-1:59
3	2:00-2:59
...	...
80	79:00-79:56

How to set or change Auto TRK

Quick instructions

Press & hold ▲ MENU/STORE 2 sec Preset
 Double Click ENTER ►|| RecFormat
 Press F.FWD/+ ►► until Auto TRK
 Press ENTER ►|| Off/On
 Press F.FWD/+ ►► toggle Off/On
 Press ENTER ►|| duration
 Press F.FWD/+ ►► tab duration
 Press ENTER ►|| Auto TRK
 Press ▲ MENU/STORE store & exit

1. From stop, press and hold the ▲ MENU/STORE button for about 2 seconds.

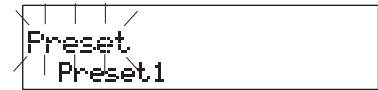

2. With Preset flashing in the display, double click the ENTER button ►||.



3. Press and release the F.FWD/+ button ►► until Auto TRK is displayed.



4. With Auto TRK flashing, press and release the ENTER button ►||. On/Off menu choice is flashing.



5. Press and release the F.FWD/+ button ►► to toggle between On and Off.



6. When correct, press and release the ENTER button ►||. Duration choice is flashing.



7. Press and release the F.FWD/+ button ►► to tab through the duration choices.



8. When correct, press and release the ENTER button ►||.

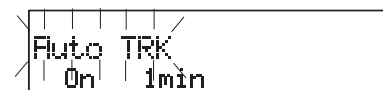

The display returns to Auto TRK flashing.

You can:

- Press and release the F.FWD/+ button ►► or the -/ F.REV button ◀◀ to tab to another menu choice, or
- Press and release the ▲ MENU/STORE button to write the menu changes and return to stop mode, or
- Press and release the CANCEL button ■ to cancel all menu changes and return to stop mode.

Seamless Play.

When Seamless Play is On during playback, multiple tracks will be played back in sequence without any break (space) between the tracks. When Seamless Play is Off during playback, multiple tracks will be played back in sequence with breaks (brief periods of silence) between the tracks.

Default setting is Off.

How to set or change SeamlsPly

Quick instructions

Press & hold ▲MENU/STORE 2 sec Preset
 Double Click ENTER ►|| RecFormat
 Press F.FWD/+ ►► until SeamlsPly
 Press ENTER ►|| Off/On
 Press F.FWD/+ ►► toggle Off/On
 Press ENTER ►|| SeamlsPly
 Press ▲MENU/STORE store & exit

1. From stop, press and hold the ▲MENU/STORE button for about 2 seconds.



2. With Preset flashing in the display, double click the ENTER button ►||.

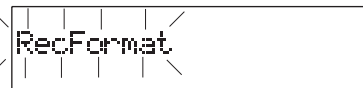

3. Press and release the F.FWD/+ button ►► until SeamlsPly is displayed.

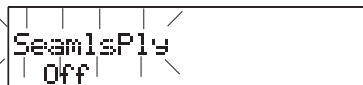

4. With SeamlsPly flashing, press and release the ENTER button ►||.

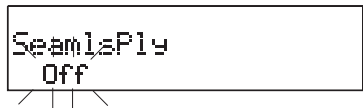

On/Off menu choice is flashing.

5. Press and release the F.FWD/+ button ►► to toggle between On and Off

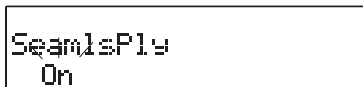

6. When correct, press and release the ENTER button ►||.

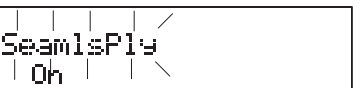

The display returns to SeamlsPly flashing.

You can:

- Press and release the F.FWD/+ button ►► or the -/ F.REV button ◀◀ to tab to another menu choice, or
- Press and release the ▲MENU/STORE button to write the menu changes and return to stop mode, or
- Press and release the CANCEL button ■ to cancel all menu changes and return to stop mode.

Silent Skip.

When set to On, Silent skip automatically pauses recording when there is a period of silence and continues recording when sound resumes. Silent Skip looks for sound below a preset level for a preset period of time. When that occurs, the PMD671 switches to record pause. When a signal exceeding the dB level you set is input, recording resumes. If set to TR, a new track is started when recording resumes.

You can set the preset time for 01, 02, 03, 04 or 05 seconds.

You can set the decibel level (dB) to- 20, -25, -30, -35, -40, -45, -50, -55 or -60 dB.

For example, if you are both the recorder and master of ceremonies for an event, you can preset the PMD671 for recording and automatically start recording when you start speaking into the microphone.

When the Auto Mark feature is at On, resumption of recording after a record pause by Silent Skip adds an EDL mark.

S.SKIP

The S.SKIP icon appears in the display while Silent Skip is On.



The S.SKIP icon is flashing during a Silent Skip record pause.

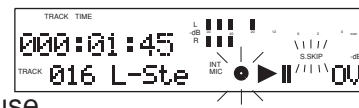

Manual overrides:

Pause During recording press and release the REC PAUSE button to force a recording pause. S.SKIP icon is steady. Slide the REC Button to resume recording.

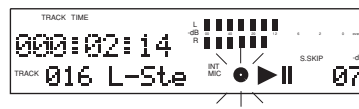

Resume During Silent Skip pause, slide the REC Button to resume recording. Silent Skip remains active.

How to set or change SilentSkp continued

Default settings are Off, 03 seconds and -40 dB.

How to set or change SilentSkp

Quick instructions

Press & hold **MENU/STORE** 2 sec Preset
 Double Click **ENTER** **▶/||** RecFormat
 Press **F.FWD/+** **▶▶** until SilentSkp
 Press **ENTER** **▶/||** Off/On/TR
 Press **F.FWD/+** **▶▶** tab Off/On/TR
 Press **ENTER** **▶/||** seconds
 Press **F.FWD/+** **▶▶** tab seconds
 Press **ENTER** **▶/||** decibels
 Press **F.FWD/+** **▶▶** tab decibels
 Press **ENTER** **▶/||** SilentSkp
 Press **MENU/STORE** store & exit

1. From stop, press and hold the **MENU/STORE** button for about 2 seconds.

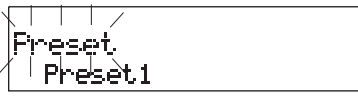

2. With Preset flashing in the display, double click the **ENTER** button **▶/||**.

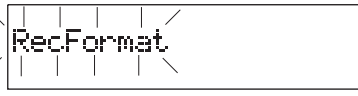

3. Press and release the **F.FWD/+** button **▶▶** until SilentSkp is displayed.

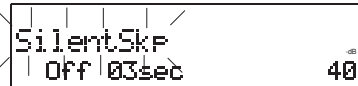

4. With SilentSkp flashing, press and release the **ENTER** button **▶/||**.
 On/Off/TR menu choice is flashing.



5. Press and release the **F.FWD/+** button **▶▶** to tab between On, Off and TR.



6. When correct, press and release the **ENTER** button **▶/||**. Seconds choice is flashing.



Note

If you don't want to change the seconds or dB settings press and release the **ENTER** button **▶/||** several times to tab to SilentSkp flashing.

7. Press and release the **F.FWD/+** button **▶▶** to tab through seconds.



8. When correct, press and release the **ENTER** button **▶/||**.
 Decibel choice flashing.



9. Press and release the **F.FWD/+** button **▶▶** to tab through decibel choices.



10. When correct, press and release the **ENTER** button **▶/||**.
 The display returns to SilentSkp flashing.



You can:

- Press and release the **F.FWD/+** button **▶▶** or the **-/F.REV** button **◀◀** to tab to another menu choice, or
- Press and release the **MENU/STORE** button to write the menu changes and return to stop mode, or
- Press and release the **CANCEL** button **■** to cancel all menu changes and return to stop mode.

Auto Cue

Auto Cue skips the silence at the beginning of an audio track and pauses playback at the point where the audio begins (sound is loud enough for long enough). You can adjust how loud (dB's) and how long (milliseconds) the audio has to be before playback is cued.

If Single Play is selected, Auto Cue pauses playback and cues to the sound of the next track when the end of the track is reached.

The Auto Cue Menu settings permit:







- turning Auto Cue On or Off.
- adjusting the millisecond period in 5 millisecond intervals from 5 to 95 milliseconds.
- adjusting the margin sound level that defines where audio begins in -5 dB increments from -20 to -60 dB.

Default settings are Off, 20 milliseconds, and -40 dB.

How to set or change Auto Cue





Quick instructions

Press & hold **▲MENU/STORE** 2 sec Preset
 Double Click **ENTER** ▶/|| RecFormat
 Press **F.FWD/+** ▶▶ until Auto Cue
 Press **ENTER** ▶/|| Off/On
 Press **F.FWD/+** ▶▶ toggle Off/On
 Press **ENTER** ▶/|| milliseconds
 Press **F.FWD/+** ▶▶ tab milliseconds
 Press **ENTER** ▶/|| decibels
 Press **F.FWD/+** ▶▶ tab decibels
 Press **ENTER** ▶/|| Auto Cue
 Press **▲MENU/STORE** store & exit

- From stop, press and hold the **▲MENU/STORE** button for about 2 seconds.
 
- With Preset flashing in the display, double click the **ENTER** button ▶/||.
 
- Press and release the **F.FWD/+** button ▶▶ until Auto Cue is displayed.
 
- With Auto Cue flashing, press and release the **ENTER** button ▶/||. On/Off menu choice is flashing.
 
- Press and release the **F.FWD/+** button ▶▶ to toggle between On and Off.
 
- When correct, press and release the **ENTER** button ▶/||. Milliseconds choice flashing.
 

Note

If you don't want to change the Milliseconds or dB settings press and release the **ENTER** button ▶/|| several times to tab to Auto Cue flashing.

- Press and release the **F.FWD/+** button ▶▶ to tab through milliseconds.
 
- When correct, press and release the **ENTER** button ▶/||. Decibel choice flashing.
 
- Press and release the **F.FWD/+** button ▶▶ to tab through decibel choices.
 
- When correct, press and release the **ENTER** button ▶/||. The display returns to Auto Cue flashing.
 

You can:

- Press and release the **F.FWD/+** button ▶▶ or the **-/F.REV** button ◀◀ to tab to another menu choice, or
- Press and release the **▲MENU/STORE** button to write the menu changes and return to stop mode, or
- Press and release the **CANCEL** button ■ to cancel all menu changes and return to stop mode.

S.Monitor

Stop Monitor lets you monitor the source signal when in stop as well as during record. The source signal is available at the PHONES jack or Internal Speaker.

Default setting is Off.

How to set or change S.Monitor

Quick instructions

Press & hold **▲MENU/STORE** 2 sec Preset
 Double Click **ENTER** ▶/|| RecFormat
 Press **F.FWD/+** ▶▶ until S.Monitor
 Press **ENTER** ▶/|| Off/On
 Press **F.FWD/+** ▶▶ toggle Off/On
 Press **ENTER** ▶/|| S.Monitor
 Press **▲MENU/STORE** store & exit

- From stop, press and hold the **▲MENU/STORE** button for about 2 seconds.
 

2. With Preset flashing, in the display, double click the ENTER button ▶/||.



3. Press and release the F.FWD/+ button ▶▶ until S.Monitor is displayed.

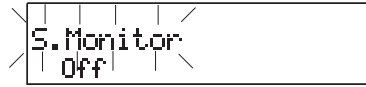

4. With S.Monitor flashing, press and release the ENTER button ▶/||. On/Off menu choice is flashing.



5. Press and release the F.FWD/+ button ▶▶ to toggle between On and Off.



6. When correct, press and release the ENTER button ▶/||. The display returns to S.Monitor flashing.

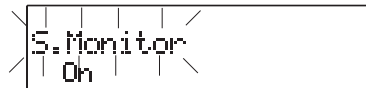

You can:

- Press and release the F.FWD/+ button ▶▶ or the -/ F.REV button ◀◀ to tab to another menu choice, or
- Press and release the ▲MENU/STORE button to write the menu changes and return to stop mode, or
- Press and release the CANCEL button ■ to cancel all menu changes and return to stop mode.

SinglePly

Off - During playback, when Single Play and Auto Cue are Off and the end of a track is reached, the next track automatically starts playing.

On - During playback, when Single Play is On and the end of a track is reached, the PMD671 automatically pauses. If Auto Cue is also On in play cues to start of audio.

Default setting is Off.

How to set or change SinglePly

Quick instructions

Press & hold ▲MENU/STORE 2 sec Preset
 Double Click ENTER ▶/|| RecFormat
 Press F.FWD/+ ▶▶ until SinglePly
 Press ENTER ▶/|| Off/On
 Press F.FWD/+ ▶▶ toggle Off/On
 Press ENTER ▶/|| SinglePly
 Press ▲MENU/STORE store & exit

1. From stop, press and hold the ▲MENU/STORE button for about 2 seconds.



2. With Preset flashing in the display, double click the ENTER button ▶/||.

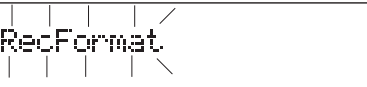

3. Press and release the F.FWD/+ button ▶▶ until SinglePly is displayed.

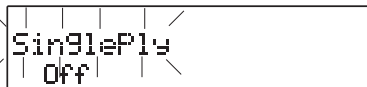

4. With SinglePly flashing, press and release the ENTER button ▶/||. On/Off menu choice flashing.

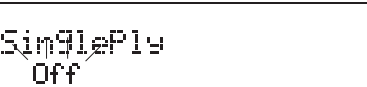

5. Press and release the F.FWD/+ button ▶▶ to toggle between On and Off.

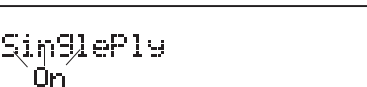

6. When correct, press and release the ENTER button ▶/||. The display returns to SinglePly flashing.

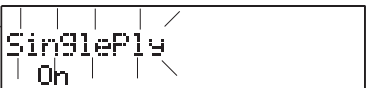

You can:

- Press and release the F.FWD/+ button ▶▶ or the -/ F.REV button ◀◀ to tab to another menu choice, or
- Press and release the ▲MENU/STORE button to write the menu changes and return to stop mode, or
- Press and release the CANCEL button ■ to cancel all menu changes and return to stop mode.

Remote Mode (REMOTE1 jack only)

Use a wired remote (not supplied) to control the PMD671. There are five remote modes:



- StartPause – during recording or playback, switch off to pause and on to resume (recording on the same track).
- StrtStp TR - during recording, switch off to pause recording and on to start recording a new track.
- EDL Mark – during recording, switch remote to on to add an EDL mark.
- PWR REC – during power off, switch remote on to turn power on and begin recording. During recording, switch remote off to stop recording and power off.
- Manual TRK – during recording, switch remote on to increment the track. Recording continues with a new track created at that point.

Default is StartPause.

How to set or change the Remote Mode

Quick instructions

Press & hold ▲MENU/STORE 2 sec Preset
 Double Click ENTER ►|| RecFormat
 Press F.FWD/+ ►► until Remote
 Press ENTER ►|| StartPause/StrtStp TR/
 EDL Mark/PWR REC/Manual TRK
 Press F.FWD/+ ►► tab Remote Modes
 Press ENTER ►|| Remote
 Press ▲MENU/STORE store & exit

1. Select the RemoteMode menu choice:
 - a. From stop, press and hold the ▲MENU button for about 2 seconds. Preset will appear (flashing) in the display.
 
 - b. While Preset is flashing, double click the ENTER button ►||. The last Menu choice selected will appear.
 
2. Press and release the F.FWD/+ button ►► repeatedly until Remote is displayed and flashing.
 

3. Press and release the ENTER button ►|| to accept the Remote choice and switch to RemoteMode choices.
 

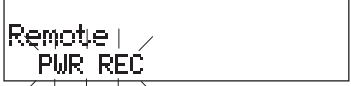
4. Press and release the F.FWD/+ button ►► or the -/F.REV button ◀◀ to tab through the RemoteMode choices: StartPause, StartStp TR, EDL Mark, PWR REC, or Manual TRK.
 

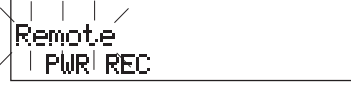
5. When correct, press and release the ENTER button ►|| to switch to RemoteMode flashing.
 

You can:

- Press and release the F.FWD/+ button ►► or the -/F.REV button ◀◀ to tab to another menu choice, or
- Press and release the ▲MENU/STORE button to write the menu changes and return to stop mode, or
- Press and release the CANCEL button ■ to cancel all menu changes and return to stop mode.

Broadcast Wave ID numbers

Broadcast Wave Format (.bwf) has three identification numbers in the header (Extension Chunk): Description, Originator, and Originator Reference. For example, if the IDs are used for a broadcast station ID1 could be the identifier of the station, ID2 could be used for the department code, and ID3 for the badge number of the reporter.

Default is all ID numbers at 000000.

How to set or change ID numbers

Quick instructions

Press & hold ▲MENU/STORE 2 sec Preset
 Double Click ENTER ►|| RecFormat
 Press F.FWD/+ ►► until ID1Dscprt
 ID2Origin or ID3OrgRef
 Press ENTER ►|| 1st digit flashing
a Press F.FWD/+ ►► tab 0-9
b Press ENTER ►|| save & next digit
 Repeat a, b until 6th digit set
 Press ENTER ►|| ID1Dscprt
 ID2Origin or ID3OrgRef
 Press ▲MENU/STORE store & exit

1. Select the ID1 menu choice:

a. From stop, press and hold the **MENU** button for about 2 seconds. Preset will appear (flashing) in the display.

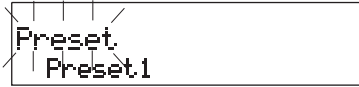

b. While Preset is flashing, double click the **ENTER** button. The last Menu choice selected will appear.



2. Press and release the **F.FWD/+** button repeatedly until an ID choice is displayed and flashing.

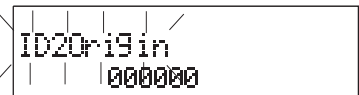

3. Press and release the **F.FWD/+** button or the **-/F.REV** button to tab through the ID choices.



When correct press and release the **ENTER** button to accept the ID# choice and switch to the highest number position.



4. Press and release the **F.FWD/+** button or the **-/F.REV** button to tab through the digits 0 through 9.

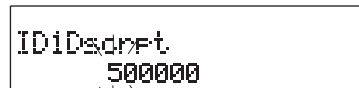

5. When correct, press and release the **ENTER** button to switch to the next digit.

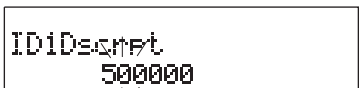

6. Press and release the **F.FWD/+** button or the **-/F.REV** button to tab through the digits 0 through 9.

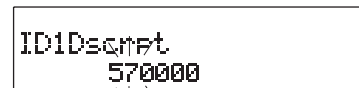

Repeat steps 5 and 6 until all six digits are set.

7. Press and release the **ENTER** button to switch to ID# flashing.



8. Press and release the **F.FWD/+** button to switch to the next ID#.

9. Repeat 5 - 8 for all three ID numbers.

10. When the upper display is flashing, press and release the **F.FWD/+** button to switch to another menu choice, or press and release the **MENU/STORE** button to write the menu change(s) and return to stop mode.

Menu Default

The Default menu choice resets all Menu items to their defaults. This is convenient if you are setting up a new configuration because you don't have to check all the settings, you know they are at the default.

Defaults are listed for each menu item.

Note:

US defaults are used for illustration. See page 59 for a table of menu defaults.

Quick instructions

Press & hold **MENU/STORE** 2 sec Preset
 Double Click **ENTER** RecFormat
 Press **F.FWD/+** until Default
 Press **ENTER** Execute
 Press **ENTER** EXECUTING
 exits

- From stop, press and hold the **MENU/STORE** button for about 2 seconds. Preset is flashing.
- With Preset flashing in the display, double click the **ENTER** button. Menu item is flashing.

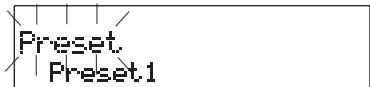

3. Press and release the F.FWD/+ button ►► until Default is displayed.



4. With Default flashing, press and release the ENTER button ►||. Execute will be flashing*.

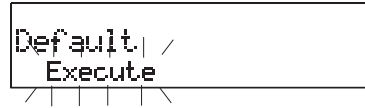

5. Press and release the ENTER button ►||. EXECUTING is displayed briefly.



The PMD671 returns to stop mode.

*Press and release the STOP button ■ to exit without changing your Menu settings.

Controls and Connections Top continued

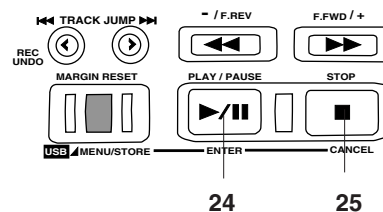
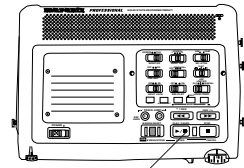

24. PLAY/PAUSE button ►|| (playback)
ENTER button ►|| (menu)

PLAY/PAUSE button ►||

From stop, press and release to begin playback. During playback, press and release to pause playback.

During playback pause, press and release to resume playback.



ENTER button ►||

During menu functions, press and release to accept the current setting and switch to the next menu item to be set.

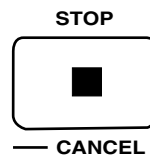

25. STOP/CANCEL button ■

During recording, press and release to stop recording and end the track (file).

During playback, press and release to stop playback and end the playback session. When you resume, playback starts at the beginning of the first track.

During menu operations, press and release to cancel all entries made and return to stop mode.

Front

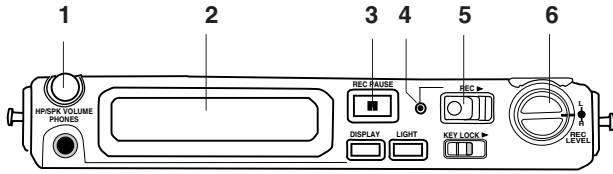

HP/SPK VOLUME

- 1. HP/SPK VOLUME control**
 Turn to adjust the volume of headphones plugged into the PHONE jack or the built-in speaker.

During playback, what is heard on the L or R headphone depends on the recording. For a Stereo or Dual Mono recording, the setting of the AUDIO switch determines what is heard on headphones.

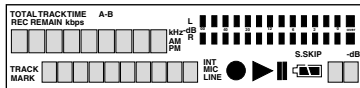

- 2. Display**
 See Display on page 55 for details.



REC PAUSE

- 3. REC PAUSE button**
 During recording, push and release to pause.

When paused, the REC indicator will flash.

Example display

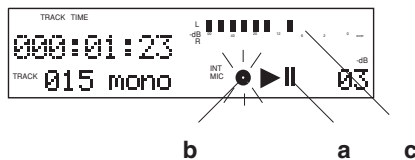

The Pause symbol (a) will be displayed.
 The Record symbol (b) will flash in the display
 The Level meter (c) will remain active.

To resume recording, slide the REC switch to the right and release.

A REC PAUSE does not increment the track.

If the AUTO MARK switch is at ON, after a REC PAUSE an EDL mark is added when recording is resumed. The following is displayed for a couple of seconds.

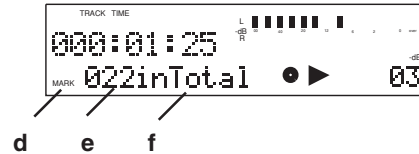

MARK (d) is displayed to indicate that the number (e) indicates the count of EDL marks. "inTotal" (f) reminds you that EDL marks are counted from the beginning the Flash memory card, not the beginning of the current track.

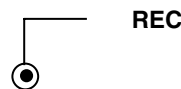

REC

- 4. REC indicator**
 Red indicator light is lit and steady during

Record and flashing during Record pause.

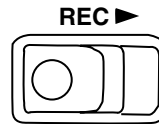

- 5. REC switch**

From Stop, slide to the right and release to start recording.

From REC PAUSE, slide to the right and release to resume recording.

If Manual TR is on during recording, slide to the right and release to increment the track (start a new audio file).

To stop recording, press and release STOP ■.

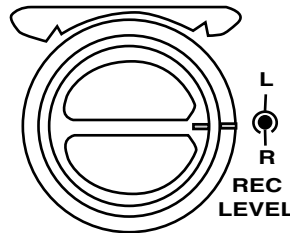

- 6. REC LEVEL controls**

Turn to adjust the record level when the LEVEL CONT. switch is at MANUAL.

The inside control (Right channel) and outside control (Left channel) turn together unless you hold one while turning the other. The optimum record level is when the level meter goes as close to 0dB as possible but not OVER.

Front continued

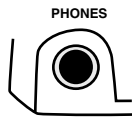
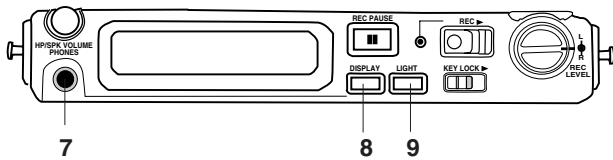

7. PHONES jack
Plug stereo headphones in this jack.

Adjust headphone volume with the HP/SPK volume control.

Headphones are active during recording and playback.

During playback, plugging in headphones mutes the internal speaker.

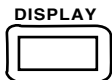

8. DISPLAY button
Press and release to tab through alternate information displays.

Displays are slightly different in Stop, Record and Play.

During Stop:
Default display is **Remaining record time for the card.**

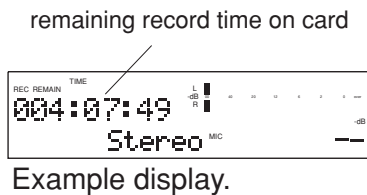

After the first press, **track information** is displayed.



After the second press, **EDL mark information** is displayed.

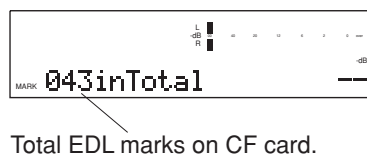

After the third press, **file parameters** are displayed.

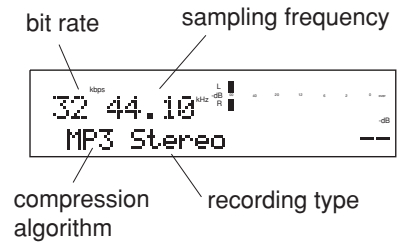

After the fourth press, **Date and Time** information is displayed.

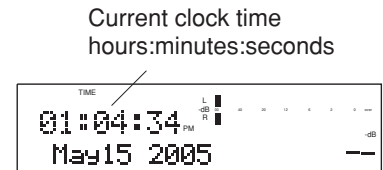

After the fifth press, the display returns to the default: remaining record time on the card.

During Record:
the default display is Record time on the current track.

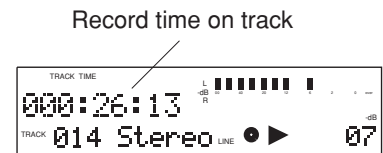

The first press of the DISPLAY button switches to remaining record time for the card.

The second press switches to file parameters.

The third press switches to date and time.

The fourth press returns to the default.

During Playback:
the default display is playing time on the current track.



The first press switches to file parameters.

The second press switches to date and time.

The third press returns to the default.

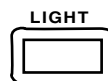

9. LIGHT button
Press and release to momentarily turn the Display light on.

Press and hold for three seconds to switch the Display light on.

Press and release to switch the Display light off.

Front continued

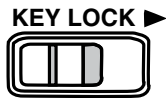
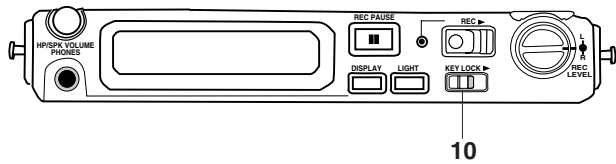

10. KEY LOCK switch

The KEY LOCK switch secures the PMD671 in its present state during Record, Playback or Stop.

Slide the switch to the right to turn KEY LOCK on. "Locked" is displayed for three seconds.

Only these controls will work:
 Display LIGHT button.
 POWER switch - Works during Playback or Stop.
 PRE REC switch.

If you try to operate a button or switch that is locked, "Locked" appears briefly in the display.

Example display:

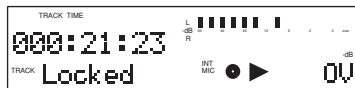

Slide the switch to the right to turn KEY LOCK off. "Unlocked" is displayed for three seconds.

Left side

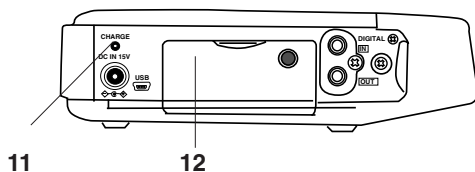

CHARGE



11. CHARGE indicator

The CHARGE indicator is lit when an optional Ni-Cd or Ni-MH battery is charging.

12. CF card compartment

Pull the compartment door open to access the CF card.

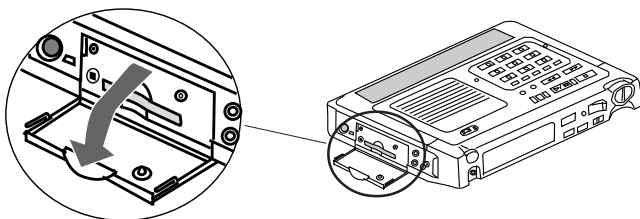

Door Open is displayed.

Door Open

The PMD671 automatically turns off.

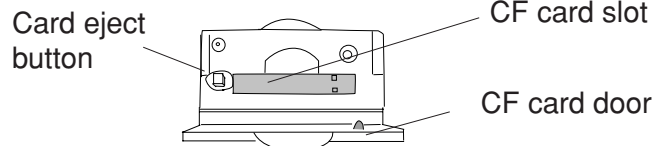

Card eject button

The Card eject button has two positions: click out (a) and click in (b).

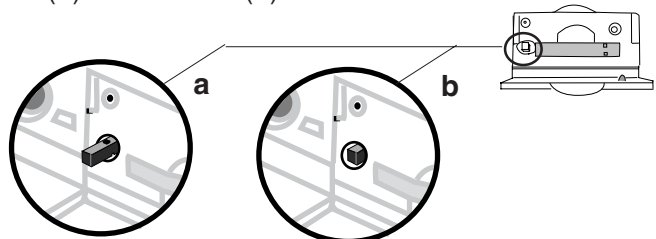

To eject a CF card:

1. If recording or in playback, push STOP ■. If other operations are in progress, cancel them by pushing STOP ■ or wait for them to complete.
2. Open the CF card door*.
3. Push and release the Card eject button so it is in the click out position (a).
4. Push the Card eject button from the click out position to the click in position (b).

*Opening the CF card door turns the PMD671 off. If recording is in progress, opening the CF card door automatically stops recording and writes critical track information to properly close the file before turning off. Close the CF card door to re-start the PMD671.

To insert a CF card:

1. Push and release the Card eject button so it is in the click in position (b above).
2. Fully insert the CF card.
3. Close the CF card door.

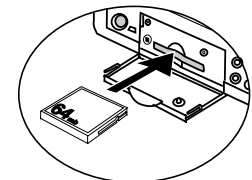

Note: If the CF card door won't latch, check that the Card eject button is in the click in position (b above).

Security

The supplied security screw requires using a small Phillips screwdriver to open the Memory compartment door. The screw reduces the possibility that the CF card will be misplaced or stolen.

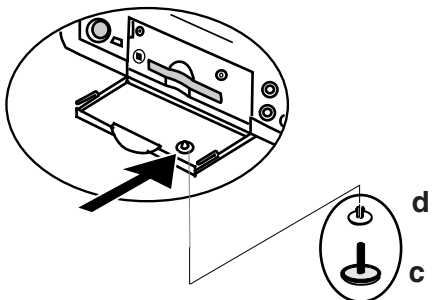
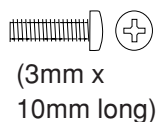

1. Remove the plastic pin (c) and then the retainer (d).
2. Add the screw. Tighten the screw enough so that the screw cannot be removed with a fingernail.

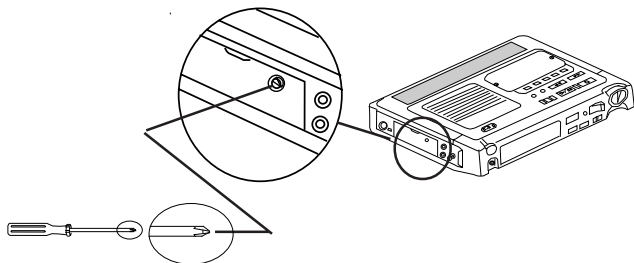

Left side continued

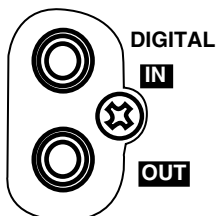
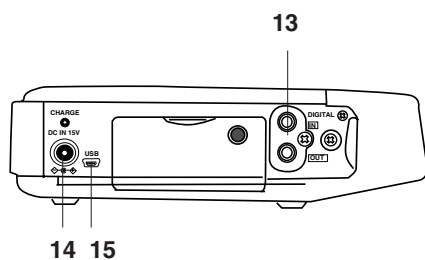

- 13. DIGITAL IN/OUT jacks**
RCA jacks for connecting the PMD671 to an audio component that accepts or outputs digital audio signals.

IN: Connect to the digital out of a digital audio component. PCM audio data input at 44.1, 48, 88.2 and 96 kHz can be recorded. Digi-IN must be selected using the INPUT button for the signal to be recorded. See page 18.

OUT: Connect to the digital in of a digital audio component.

- Only files with sampling frequencies of 44.1, 48, 88.2 or 96 kHz can be output.
- Digital audio is only output during normal or EDL playback.
- The receiving component must be able to accept audio in SPDIF (IEC-958-II) format.
- The receiving component must be able to accept a sampling frequency of 44.1, 48, 88.2 or 96 kHz.

DC IN 15V

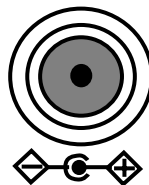

14. DC IN 15V jack

Plug the supplied AC power pack in this jack. The power supplied is 1.0A at 15V AC.

The PMD671 automatically switches to adapter power if it was running on battery power. If AC power is interrupted by a power outage or unplugging the power pack, the PMD671 automatically switches to battery power.

USB



15. USB port

Plug the supplied USB cable in this port and connect the other end to your computer (PC or MAC).

The USB (2.0) connection makes it easy to copy audio files to your computer's hard drive or a CD. This connection can only be made active when the PMD671 is off (neither recording nor during playback).

How to connect via the USB port

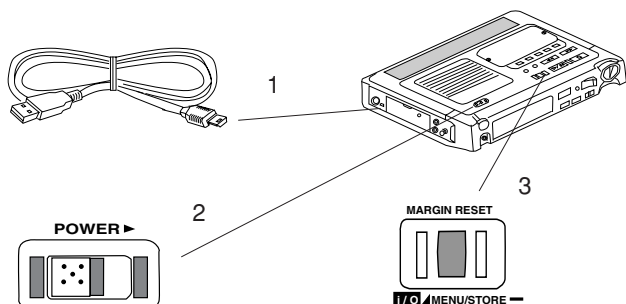

1. Connect the cable to the PMD671 and your computer.
2. Slide the PMD671's POWER switch to the right and release to power off.
3. Press and hold the USB MENU/STORE button while you slide the POWER switch to the right and release to power on.

This display appears:



The CF card in the PMD671 appears as a removable device on your computer. The audio files are in a folder named MPGLANG1.

CAUTION: Only copy audio files (tracks) to other volumes. Do not modify or delete the EDL file. If the EDL file is missing or damaged the PMD671 will be unable to recognize recorded tracks.

See the enclosed CD for demo PMDEdit software for computer audio file manipulation. PMDEdit is a full featured software suite designed for Marantz Professional digital recorders. It is available for purchase at www.d-mpro.com or by calling toll free (866) 405-2154.

Power off and power the PMD671 back on to resume recording or playback.

A file titled PMD670.EDL and a folder (directory) titled MPGLANG1 will appear on your computer. Files within the MPGLANG1 folder are numbered from 1001 through the number of tracks recorded to a maximum of 1999. The file extension will be .mp3, .wav, .bwf or .mpg depending on the Rec Format parameters that were set for the recording.

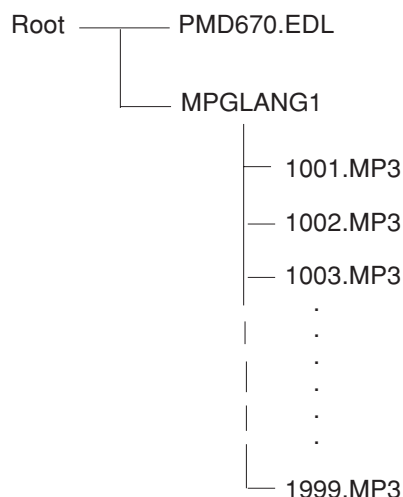
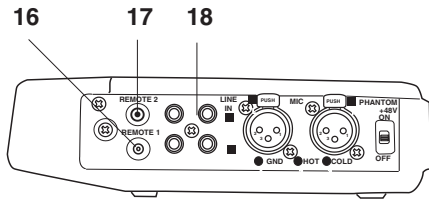

Diagram of file structure (assuming .mp3 files). Changes made to file names or file structure on your computer will prevent file recognition and therefore playback in the PMD671.

However, audio files from your computer that are renamed using the file names and file structure above may be playable on the PMD671. For example, if you name an mp3 audio file 1234.MP3 and place it in the MPGLANG1 folder, the PMD671 may play it.

Right side



REMOTE 1



16. REMOTE1 jack

Plug a wired remote (not supplied) in this jack.

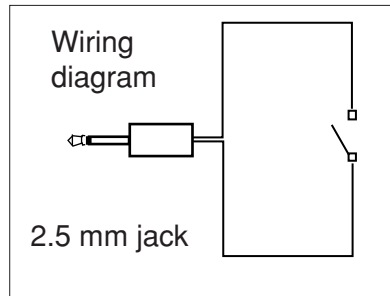

A switch connected to the 2.5mm mini jack off (open) and on (closed) does the following, depending on the RemoteMode setting:

RemoteMode: StartPause

From Rec or Playback Pause, switch remote on to start recording. During record or playback, switch remote off to pause and on to resume. If Auto Mark is On, an EDL mark is added when recording resumes.

StrtStp TR

Start or stop recording. When re-started, a new track is begun.

EDL Mark

During record or playback, switch remote to on to add an EDL mark.

PWR REC

During POWER off, switch remote to on to turn power on and begin recording.

During recording, switch remote to off to stop recording and power off.

Manual TRK

During recording, switch remote to on to increment the track. A new track is created at that point. There is no break in recording.

See page 44 for instructions on how to set or change the Remote Mode.

REMOTE 2



17. REMOTE2 jack

The REMOTE2 jack is for the optional RC600 remote. The RC600 is designed for

microphone interviews. It attaches to your microphone.

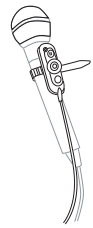
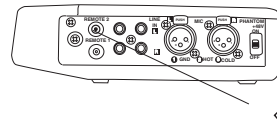

The remote's four foot cord with a four contact mini plug, plugs into the PMD671 while you carry the PMD671 via its carry strap.

The RC600 does not require any menu changes for use. The RC600 includes:

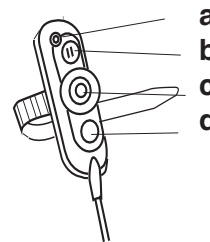

a An indicator light:

- (green) lit and steady during standby or stop
- (red) lit and steady while recording
- (flashing red) during rec pause

- (orange) flashes for 1/2 second when an over peak level signal is input during recording or rec pause, then it goes back to red
- (green flash) for 2 seconds when an EDL mark is added during recording
- b** press to pause recording
- c** press to start/resume recording and to manually increment tracks
- d** press to add an EDL mark while recording

LINE OUT

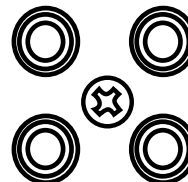

LINE IN

18. LINE IN/OUT jacks

Plug external line level audio devices in these jacks.

LINE IN jacks

Plug Left and Right RCA audio cables in here to connect to the output of an external unit.

To record, mono, stereo, or LR mono LINE input must be selected in the input select menu. See INPUT button.

Right side continued

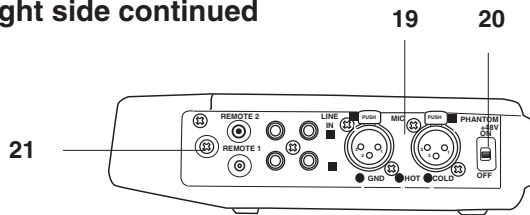

LINE OUT jacks

Plug Left and Right RCA audio cables into these jacks to connect to the input of an amplifier or other external unit.

During playback, the output on the L or R channel depends on the recording. For a Stereo or Dual Mono recording, the setting of the AUDIO OUT switch determines the output channel(s).

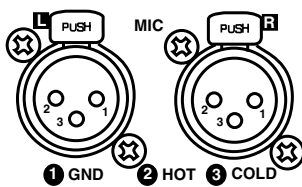

19. MIC IN jacks

Plug external microphones in these jacks. MIC must be selected using the INPUT button.

For mono recording, use the Left jack. To record stereo with MIC input or LRmono with MIC input, use both jacks.

Notes:

- XLR pin out is 1 ground, 2 hot and 3 cold.
- Microphones with a PHONE jack can be used with an

PHANTOM +48V

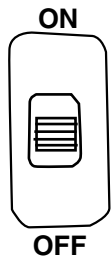

adapter (not supplied) from PHONE to XLR.

20. PHANTOM +48V switch

Switch to ON to provide 48V of power for a condenser microphone(s).

ON: +48V is supplied to power condenser microphone(s).

OFF: No microphone power is supplied.

Microphone recommendations

Professional condenser microphone(s) (which require additional power either from phantom power from the PMD671 or another source) are recommended because they provide greater sensitivity and higher quality audio recording.

Dynamic microphone(s) can be used but do not yield optimum audio quality recordings.

Consult with your local dealer to select the appropriate microphone(s) for your specific application. They can demonstrate the various performances and characteristics of microphones for your use.

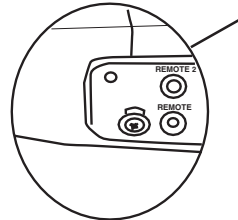

21. Carry studs

Attach the supplied carry strap to these studs.

Installing the carry strap

1. Push the end of a strap retainer with a round hole onto a carry stud.

2. Attach the carry strap.

3. Close the strap retainer by 'buttoning' the other end of strap retainer over the carry stud.

4. Repeat 1-3 for other carry stud.

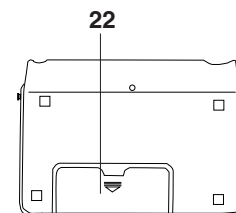
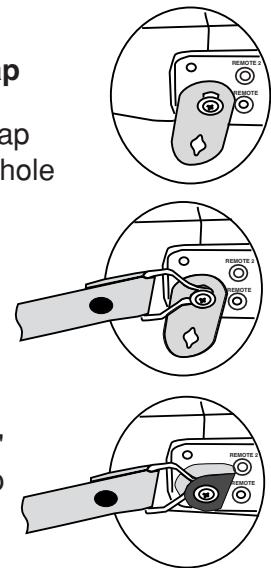

Bottom

22. Battery compartment

Press and slide at arrow to open the Battery compartment.

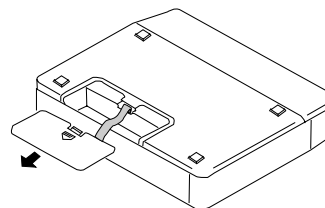

Battery power

The PMD671 can operate on several types of battery power.

Hint:

Keep fully charged batteries in the PMD671 when recording using AC power because as much as 30 seconds of your recording could be lost if AC power is interrupted.

Eight AA alkaline batteries and the supplied battery holder can be used. Alkaline batteries can power recording or playback for about *6 hours.

AA size rechargeable Ni-Cd or Ni-MH batteries can be used in the supplied battery holder, but they cannot be recharged with the PMD671's built in charger.

An optional Ni-Cd battery model RB1100 can be charged in the PMD671. Ni-Cd batteries can power recording or playback for about *5 hours.

An optional Ni-MH (Nickel metal hydride) battery model RB1651 can be used and recharged with the PMD671's built-in charger. Ni-MH batteries can power recording or playback for about *7 hours.

*Using compact flash media.

Installing AA size batteries:

Power off and turn the PMD671 upside down.

Press and push in the direction of the arrow to remove the battery compartment cover.

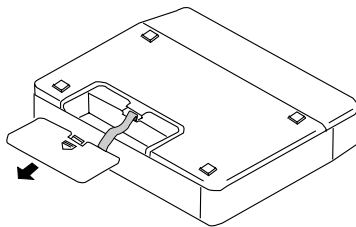

Install 8 AA size batteries to the

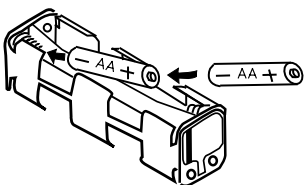

battery holder with the - ends towards the springs.

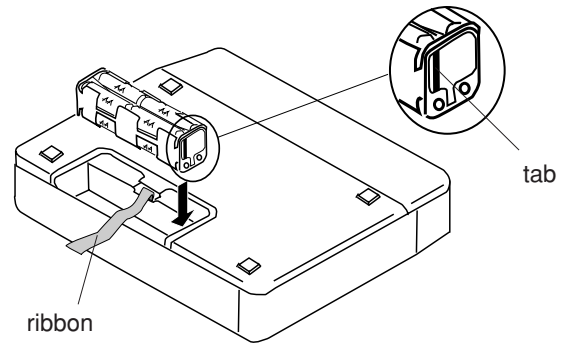

Install the battery holder with tab as shown and over the ribbon for easy battery holder removal.

Replace the battery compartment cover**.

Installing an optional Ni-Cd or Ni-MH battery

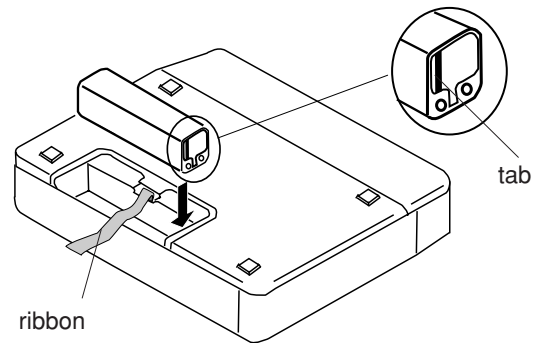

Install the battery with tab as shown and over the ribbon for easy battery removal**.

Charging the optional Ni-Cd battery

- Load the Ni-Cd battery correctly in the battery compartment.
- Connect the AC power pack and plug into power supply.
- Select Ni-Cd in the Batt type menu (page 30).
- Power the PMD671 on, then off for the charging cycle to begin.
- The PMD671 must be off during battery charging.

While charging (about 3 hours), the CHARGE indicator will be lit and steady.

When the Ni-Cd battery charge cycle is complete, the CHARGE indicator will be off.

**When changing battery type, be sure you change the Batt type menu setting for optimal battery performance.

Display

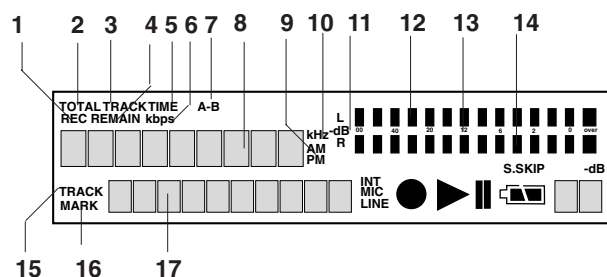

1. REC label

The REC label appears to indicate TOTAL REC TIME or REC TIME REMAINING displayed on the upper alphanumeric display.

2. TOTAL label

The TOTAL label appears to indicate TOTAL REC TIME or TOTAL REC TIME REMAINING displayed on the upper alphanumeric display.

3. TRACK label

The TRACK label appears with other labels in this area to indicate TRACK TIME displayed on the upper alphanumeric display.

4. REMAIN label

The REMAIN label appears to indicate REC TIME REMAINING or TOTAL REC TIME REMAINING displayed on the upper alphanumeric display.

5. TIME label

The TIME label appears to indicate REC TIME REMAINING, TOTAL REC TIME REMAINING or TRACK TIME displayed on the upper alphanumeric display.

6. kbps label

The kbps label appears to indicate that the first five places in the upper alphanumeric display are kilobytes per second.

7. A-B label

A- indicates that the beginning (A point) of an A-B loop has been set.
A-B indicates that the ending (B point) of an A-B loop has also been set.

8. Upper alphanumeric display

Displays a variety of information including remaining recording time, clock time, menu

settings etc. Associated labels are display items 1-7, 9 and 10.

9. AM / PM label

Displays AM or PM when clock time is displayed.

10. kHz label

The kHz label appears to indicate that the last five places in the upper alphanumeric display show frequency in kilohertz.

11. L -dB R level meter labels

L is the label for the Left (upper) level meter.
-dB is the label for the center level meter scale in decibels.
R is the label for the Right (lower) level meter.

12. Upper level meter

The louder the sound input to the recorder on the Left channel, the more bars are displayed.

13. Decibel scale

The scale in dB (decibels) for the upper and lower level meters.

14. Lower level meter

The louder the sound input to the recorder on the Right channel, the more bars are displayed.

15. TRACK label

The TRACK label appears to indicate that the number displayed on the left of the lower alphanumeric display is the track number.

16. MARK label

The MARK label appears to indicate that the number displayed on the left of the lower alphanumeric display is the EDL Mark number.

17. Lower alphanumeric display

Displays a variety of information including remaining recording algorithm, date, track number, number of tracks on CF card, EDL Mark number, number of EDL Marks on CF card etc. Associated labels are display items 15 and 16.

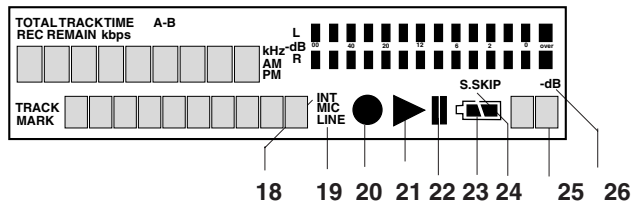

18. MIC / INT MIC label

The MIC label appears when external microphones are selected.

The INT MIC label appears when input selected for recording is the internal microphone.

19. LINE label

The LINE label appears when input(s) selected for recording is (are) the LINE IN jacks.

20. Record

The Record symbol appears when the PMD671 is in record mode. It appears with the Play symbol when recording. It appears with the pause symbol and flashing when in record pause.

21. Play

The Play symbol appears when the PMD671 is in playback, playback pause, recording or record pause.

22. Pause

The Pause symbol appears when the PMD671 is in playback pause or record pause.

23. Battery

When on battery power, the Battery symbol appears in most displays to indicate battery charge.

 indicates that the battery charge is good.

 indicates that the battery charge is getting low and there is approximately 5 to 10 minutes of record or playback time available.



flashing indicates that the battery has approximately 1 to 3 minutes of record or playback time remaining.

The CHARGE indicator light will flash. If BEEP is set to On, the PMD671 will also beep.

If the PMD671 continues to operate, it will automatically shut down. If recording, it will write track information, stop recording and power off. If in playback, it will stop playback and power off.



indicates that the battery charge is depleted.

24. S.SKIP label

The S.Skip label appears when Silent Skip is enabled.

25. Margin level

The Margin level is displayed. The PMD671 holds this display at the highest level achieved during the current recording. If more than 0 dB, OV is displayed. To reset the Margin level, press and release the MARGIN RESET button.

26. -dB label

The -dB label applies to the Peak level display.

Care and Maintenance

Use a soft cloth slightly moistened with mild detergent solution.

Recording time chart

The recording time available (Hours:Minutes:Seconds) on a CF card depends on the size of the card in megabytes (MB), the recording type (PCM, MP2 or MP3), mono or stereo, bit rate, sample rate, and byte size (8, 16, or 24). This recording time chart lists approximate recording times based on those factors.

All times are approximate.

MP3 Mono/Stereo		320kbps	256kbps	160kbps	128kbps	80kbps	64kbps	40kbps	32kbps	24kbps	16kbps
CARD SIZE	Bit rate										
	32 MB	0:13:20	0:16:40	0:26:40	0:33:20	0:53:20	1:06:40	1:46:40	2:13:20	2:57:47	4:26:40
	64 MB	0:26:40	0:33:20	0:53:20	1:06:40	1:46:40	2:13:20	3:33:20	4:26:40	5:55:34	8:53:20
	128 MB	0:53:20	1:06:40	1:46:40	2:13:20	3:33:20	4:26:40	7:06:40	8:53:20	11:51:08	17:46:40
	256 MB	1:06:40	1:46:40	2:13:20	3:33:20	4:26:40	7:06:40	14:13:20	17:46:40	23:42:16	35:33:20
	512 MB	2:13:20	2:57:47	3:33:20	4:26:40	7:06:40	14:13:20	28:26:40	35:33:20	47:24:32	71:06:40
1024 MB (1GB)	4:26:40	5:55:34	7:06:40	8:53:20	11:51:04	14:13:20	28:26:40	35:33:20	47:24:32	71:06:40	
2048 MB (2GB)	8:53:20	11:51:04	14:13:20	17:46:40	23:42:08	28:26:40	56:53:20	71:06:40	94:49:04	189:38:08	

MP2 Mono/Stereo		384kbps	256kbps	192kbps	128kbps	96kbps	64kbps	48kbps	32kbps	24kbps
CARD SIZE	Bit rate									
	32 MB	0:11:07	0:16:40	0:22:13	0:33:20	0:44:27	1:06:40	1:28:53	1:46:40	2:13:20
	64 MB	0:22:13	0:33:20	0:44:27	1:06:40	1:28:53	1:46:40	2:57:46	3:33:20	4:26:40
	128 MB	0:44:27	0:53:20	1:06:40	1:28:53	1:46:40	2:13:20	3:33:20	4:26:40	5:55:32
	256 MB	1:06:40	1:28:53	1:46:40	2:13:20	2:57:46	3:33:20	4:26:40	5:55:32	7:06:40
	512 MB	1:28:53	1:46:40	2:13:20	2:57:46	3:33:20	4:26:40	5:55:32	7:06:40	8:53:20
1024 MB (1GB)	2:57:46	3:33:20	4:26:40	5:55:32	7:06:40	8:53:20	11:51:04	14:13:20	17:46:40	
2048 MB (2GB)	5:55:32	7:06:40	8:53:20	11:51:04	14:13:20	17:46:40	23:42:08	28:26:40	47:24:16	

PCM stereo 16bit		48kHz	32kHz	24kHz	22.05kHz	16kHz	12 kHz	11.025kHz	8kHz
CARD SIZE	Sample rate								
	32 MB	0:02:47	0:03:02	0:03:34	0:06:03	0:08:20	0:11:07	0:12:06	0:16:40
	64 MB	0:05:34	0:06:03	0:07:07	0:12:06	0:16:40	0:22:14	0:24:12	0:33:20
	128 MB	0:11:07	0:08:20	0:12:06	0:16:40	0:22:14	0:33:20	0:44:28	0:53:20
	256 MB	0:22:14	0:16:40	0:22:14	0:33:20	0:44:28	0:53:20	1:06:40	1:28:56
	512 MB	0:44:28	0:33:20	0:44:28	0:53:20	1:06:40	1:28:56	1:46:40	2:13:20
1024 MB (1GB)	0:53:20	0:44:28	0:53:20	1:06:40	1:28:56	1:46:40	2:13:20	2:57:46	
2048 MB (2GB)	1:28:56	0:53:20	1:06:40	1:28:56	1:46:40	2:13:20	2:57:46	3:13:36	

PCM mono 16bit		48kHz	32kHz	24kHz	22.05kHz	16kHz	12 kHz	11.025kHz	8kHz
CARD SIZE	Sample rate								
	32 MB	0:05:34	0:06:03	0:07:07	0:12:06	0:16:40	0:22:14	0:24:12	0:33:20
	64 MB	0:11:07	0:08:20	0:12:06	0:16:40	0:22:14	0:33:20	0:44:28	0:53:20
	128 MB	0:22:14	0:16:40	0:22:14	0:33:20	0:44:28	0:53:20	1:06:40	1:28:56
	256 MB	0:44:28	0:33:20	0:44:28	0:53:20	1:06:40	1:28:56	1:46:40	2:13:20
	512 MB	0:53:20	0:44:28	0:53:20	1:06:40	1:28:56	1:46:40	2:13:20	2:57:46
1024 MB (1GB)	1:28:56	0:53:20	1:06:40	1:28:56	1:46:40	2:13:20	2:57:46	3:13:36	
2048 MB (2GB)	2:57:52	1:06:40	1:28:56	1:46:40	2:13:20	2:57:46	3:13:36	4:26:40	

PCM 24bit		44.1kHz		48kHz		88.2kHz		96kHz	
Sample rate	Channels	mono	stereo	mono	stereo	mono	stereo	mono	stereo
CARD SIZE	32 MB	0:04:02	0:02:01	0:03:44	0:01:52	0:02:01	0:01:00	0:01:51	0:00:56
	64 MB	0:08:04	0:04:02	0:07:28	0:03:44	0:04:02	0:02:01	0:03:42	0:01:51
	128 MB	0:16:08	0:08:04	0:14:56	0:07:28	0:08:04	0:04:02	0:07:24	0:03:42
	256 MB	0:32:16	0:16:08	0:29:52	0:14:56	0:16:08	0:08:04	0:14:48	0:07:24
	512 MB	1:04:32	0:32:16	0:59:44	0:29:52	0:32:16	0:16:08	0:29:36	0:14:48
	1024 MB (1GB)	2:09:04	1:04:32	1:59:28	0:59:44	1:04:32	0:32:16	0:59:12	0:29:36
2048 MB (2GB)	4:18:08	2:09:04	3:58:56	1:59:28	2:09:04	1:04:32	1:58:24	0:59:12	

Rec Format charts

Analog inputs

Channel(s)	Audio Format		Fs kHz and (Bit rate kbps)	File ext.	BWF ext.
Stereo	PCM	24 bit	96, 88.2, 48, 44.1	wav/bwf	wav/bwf
		16 bit	48, 44.1, 32, 24, 22.05, 16, 12, 11.025, 8		
	MP2		48, 44.1, 32 (384, 256, 192, 128, 96, 64)	mpg/bwf	
	MP3	48, 44.1, 32 (320, 256, 160, 128, 80, 64)		mp3/bwf	
24, 22.05, 16 (160, 128, 80, 64, 40, 32)		mp3/bwf			
Mono	PCM	24 bit	96, 88.2, 48, 44.1	wav/bwf	
		16 bit	48, 44.1, 32, 24, 22.05, 16, 12, 11.025, 8		
	MP2		48, 44.1, 32 (192, 128, 96, 64, 48, 32)	mpg/bwf	
	MP3	48, 44.1, 32 (160, 128, 80, 64, 40, 32)		mp3/bwf	
24, 22.05, 16 (80, 64, 40, 32, 24, 16)		mp3/bwf			

Digital input (shaded values set by input source)

Channel(s)	Audio Format		Fs kHz and (Bit rate kbps)	File ext.	BWF ext.
Stereo	PCM	24 bit	96, 88.2, 44, 44.1	wav/bwf	wav/bwf
		16 bit	48, 44.1		
	MP2		48, 44.1 (384, 256, 192, 128, 96, 64)	mpg/bwf	
	MP3		48, 44.1 (320, 256, 160, 128, 80, 64)	mp3/bwf	
Mono	PCM	24 bit	96, 88.2, 44, 44.1	wav/bwf	
		16 bit	48, 44.1		
	MP2		48, 44.1 (192, 128, 96, 64, 48, 32)	mpg/bwf	
	MP3		48, 44.1 (160, 128, 80, 64, 40, 32)	mp3/bwf	

Menu defaults

Display	Selection range	Default Setting (America)	Default Setting (Europe)
Date Time	2003 - 2099	2005	2005
	JAN - DEC	JAN	JAN
	1 - 31	1	1
DateForm	AM/PM 0:00 - 11:59	AM 0:00	AM 0:00
Beep	M/D/Y, D/M/Y	M/D/Y	D/M/Y
A.PowOff	On/Off	On	On
Batt type	Yes/No	Yes	Yes
Preset	Alkaline/Ni-Cd/Ni-Mh	Alkaline	Alkaline
	1/2/3	1	1
RecFormat	Stereo/Mono	Preset 1 Stereo	Preset 2 Stereo
	PCM/MP2/MP3	Preset 2 Mono	Preset 3 Stereo
	Fs (kHz)	Preset 3 PCM	Preset 1 PCM
	bit rate (kbps)	44.1	44.1
	wave/BWF/mp2/mp3 (File Format)	32	N/A
	wav/bwf (BWF Extension)	mp3	wave
RAW Mode	Monitor, TimeShift	wav	wav
Verify	On/Off	Monitor	Monitor
PupPreRec	On/Off	Off	Off
St Mode	Stereo/L-Stereo/0-20dB	Off	Off
Mono Mode	Mono/LRimono	Off	Off
Auto Mark	On/Off	Stereo	Stereo
ManualTR	On/Off	Mono	Mono
Auto TRK	On/Off	On	On
	1/5/10/15/30 min, 1/2/6/8/12/24 hrs	On	On
Seamls Ply	On/Off	Off	Off
SilentSkp	On/Off	5 min*	5 min*
	1 - 5 sec (1 sec steps)	Off	Off
	-60 - -20dB (5dB steps)	Off	Off
Auto Cue	On/Off	3 sec*	3 sec*
	5 - 95 msec (5 msec steps)	-40dB*	-40dB*
	-60 - -20dB (5dB steps)	Off	Off
S.Monitor	On/Off	Off	Off
SinglePly	On/Off	On	On
Remote	StartPause/StrnPausTR/EDL Mark/ PWR REC/Manual TRK	On	On
ID1Dscpt	6-digit ASCII code	StartPause	StartPause
ID2Origin	6-digit ASCII code	000000	000000
ID3OrgRef	6-digit ASCII code	000000	000000
Default	---	000000	000000
Application:		--	--
		High Quality Uncompressed	High Quality Uncompressed
		Music Compressed	Music Compressed

*Default when the function has been set to On.

TROUBLESHOOTING

Should faults occur, it is often unnecessary to consult your dealer or technical service department. On the basis of the following checks, you may be able to rectify a number of conditions yourself without difficulty. If the condition cannot be remedied after the following check, please consult your dealer or contact Marantz Professional toll free at (866) 405-2154.

The PMD671 does not turn on

Check power

- install fresh batteries
- check AC adaptor connections

The PMD671 turns on then turns itself off

- install fresh batteries

The PMD671 seems to record, but there is no sound on playback

- check input setting (For example, if LINE input is selected and no input is connected to the LINE IN jacks, the PMD671 will record silence.)

The PMD671 will not playback

- check EDL switch, if ON switch to OFF

No audio playback through headphones or internal speaker

- check HP/SPK VOLUME control setting
- check a different track or CF card

The PMD671 will not record

- try a different CF card
- check that the maximum of 999 tracks have not been recorded
- check that the PMD671 acknowledges the CF card

No signal from microphone input

- check input selection
- check REC level control settings
- check if microphone(s) require Phantom power

Excessive noise

- check cable connections
- turn off power to the PMD671, unplug the AC adapter, remove batteries, and then reinstate power to the unit (Complete Reset).

Playback on a PC results in poor sound

- check quality of PC sound card and program
- check frequency conversion program*

*The PMD671 records audio files with a sampling frequency of 48kHz. Some PC programs convert the files to 44.1kHz (using a sample rate converter). Only high quality sample rate converters should be used.

Cannot Read After Write (display says Cannot . . .)

Cannot Time Shift (display says Cannot . . .)

- Read After Write/Time Shift features are not available in 24 bit recording

PC cannot read files

- check if the files are MP2 or MP2 with a .wav file extension. Some PC's cannot interpret this combination. Try renaming the MP2 file so it has a .mp2 or .mp3 file extension.
- check the capability of the PC program
Some playback and editing programs do not support MP2/MP3, Broadcast Wave (.bwf) or 24-bit formats. Consult the Marantz Professional web site at www.d-mpro.com for links to programs that support MP2/MP3 and Broadcast Wave Format.

The rechargeable battery is not recharging

- check that the CHARGE indicator is lit and steady during charging and off when charging is complete
- check AC power pack connections
- check that Power is turned off on the PMD671

The rechargeable battery life is low

- make sure you fully charge and discharge the Ni-Cd battery during each charge cycle
- replace battery

Media cards that are heavily used should be occasionally reformatted to avoid audio problems due to fragmentation.

If the PMD671 exhibits erratic behavior, the microprocessor can be reset by, powering off, disconnecting AC power and removing batteries.

Error Messages

Display	Description
CF Card	
NO_CARD	No CF card inserted, or card is not detected.
UNFORMAT	Initializing of CF card failure or track information renewal failure.
FULL_CARD	Remaining capacity of CF card is less than a few kbytes.
"You Need FormatOnPC"	CF card is not formatted.
Format Fail	Formatting failure.
NO_FILE	Correct file does not exist.
FULL_999	The number of tracks on the CF card has reached the 999 maximum.
Can not	A track for which playback is not available was output.
Mark_255	The number of EDL marks on the card has reached the 255 maximum.
No_Good	Accessing speed of the CF card is not suitable.
Others	
UnLock	A corrupt digital audio signal was received during recording with digital input.
Unsupport	A digital audio signal with a corrupt sample rate was received during recording with digital input, or a corrupt file format is set up.
"NO_EDL EDLERROR-A"	A or B point for EDL A-B loop was not found.
Verify Err	A verify error was detected during recording while the menu choice Verify is "On".
DSP ERROR	DSP processing error.
Can not E1	Time Shift Playback is not available on the CF card which was recorded on the PMD660.
Can not E2	Time Shift Playback is not available between tracks having different sampling frequencies or audio formats i.e. MP2 and MP3.
Can not E3	Read After Write is not available during recording with MP2, or 24 bits and 96/88.2 kHz PCM.
Can not E4	Verify is not available during recording with MP2, or 24 bits and 96/88.2kHz PCM
Can not E5	F.FWD/F.REV or Seek+/- search is not available on the VBR (Variable Bit Rate) file.
Can not E6	Cannot Card Check because there is too little remaining card capacity.
Can not E7	Wave format error was detected during PCM file playback.

SPECIFICATIONS*

Digital audio system

System	Solid State Recorder
Usable Media	CF memory/Microdrive cards
Recording and media methods	
.mp2	MPEG1 Layer II compression
.mp3	MPEG1 Layer III compression
.mp3	MPEG2 Layer III compression*
	*for all half sample rates.
PCM	16/24 bit linear PCM

Recording bit rate (selectable)

MP2 mono	192, 128, 96, 64, 48, 32 kbps
MP2 stereo	384, 256, 192, 128, 96, 64 kbps
MP3 mono	160, 128, 80, 64, 40, 32, 24, 16 kbps
MP3 stereo	320, 256, 160, 128, 80, 64, 40, 32 kbps

Sampling frequency

Analog	
24bit PCM	96, 88.2, 48, 44.1 kHz
16bit PCM	48, 44.1, 32, 24, 22.05, 16, 12, 11.025, 8 khz
MP2	48, 44.1, 32 kHz
MP3	48, 44.1, 32, 24, 22.05, 16 kHz
Digital	96, 88.2, 48, 44.1 kHz

Number of channels 2 (stereo), 1 (mono)

Frequency response 44kHz (-0.5dB, fs=96kHz)

Signal-to-Noise Ratio

IEC-A weighted	LINE 92 dB
	MIC 65 dB

Total Harmonic Distortion

at 0 VU (PCM)	LINE 0.01%
	MIC 0.03%

Dynamic Range 94 dB

Inputs

MIC IN L/R	
Type	XLR (1:GND, 2:HOT, 3:COLD)
Input Sensitivity (MIC)	1.2 mVrms/3 kohms
LINE IN L/R	
Type	RCA jack
Input Sensitivity	300 mVrms/22 kohms
DIGITAL IN	
Type	RCA jack
Input impedance	75 ohms
Standard input level	0.5 Vp-p
Sampling frequency	96, 88.2, 48, 44.1 kHz
Format	SPDIF (IEC 958 TypeII)

Outputs

LINE OUT L/R	
Type	RCA jack
Standard level	2 Vrms max./2 kohms
DIGITAL OUT	
Type	RCA jack
Output impedance	75 ohms
Standard output level	0.5 Vp-p
Sampling frequency	96, 88.2, 48, 44.1 kHz
Format	SPDIF (IEC-958 Type II)

General

Headphone Output power 20 mW/32 ohms

Speaker Output power 70 mW/4 ohms

Phantom power +48V/7mA

Power consumption

 Recording/Playback 6 W

 Charging 12 W max

 Standby (battery driven) 2.9 mW

Battery life (Alkaline) 6 hours (typical)

Dimensions

 Width 264 mm (10.4")

 Height 55 mm (2.0")

 Depth 185 mm (7.3")

Weight 1.3 kg (2 lbs. 14 oz.)

Included accessories

AC adapter	1
Battery holder	1
Carry strap	1
Carry strap retainers	2
Screws (ISO 3x10 mm)	3
Plastic pin and retainer	1
USB cable	1
User Guide	1

Optional accessories** [availability]

Ni-Cd battery pack	RB1100
Ni-MH battery pack	RB1651
Carrying cover (vinyl)	CLC670
Carrying bag [US, Europe, only]	PRC300
Professional reporter's bag	
[US, Europe, only]	PRC600
Attache carrying case [US only]	CA200

**See www.d-mpro.com for details.

*Specifications subject to change without notice.

Record setting recommendations

Recording a meeting

LEVEL CONT. switch at ALC.

ANC switch at .

Factory default settings.

Input: INT MIC mono or MIC mono

Menu settings:

 Preset 2

Recording music

LEVEL CONT. switch at MANUAL.

ANC switch at FLAT.

Input: MIC stereo

Menu settings:

 Preset 1

Menu settings (highest quality):

 Preset 3

LIMITED WARRANTY

Your Marantz Professional product is warranted against manufacturer defects in material and workmanship for a period of one year parts and labor.

Except as specified below, this warranty covers defects in material and workmanship. The following are not covered under warranty:

1. Damage, deterioration, malfunction or failure to meet performance specifications resulting from:
 - a) Accidents, acts of nature, misuse, abuse, neglect or unauthorized product modification.
 - b) Improper installation, removal or maintenance, or failure to follow supplied instructions.
 - c) Repair or attempted repair by a non-Marantz authorized agent.
 - d) Any shipment (claims must be presented to the carrier).
 - e) Any cause other than a defect of manufacturing.
2. Cleaning, check-ups with no fault found or changes incurred for installation, removal or reinstallation of the product.
3. Any serialized product on which the serial number has been defaced, modified or removed.
4. Batteries and battery chargers.
5. Accessories, including but not limited to: cables, mounting hardware and brackets, cleaning accessories, power cords and adapters, and carry cases.

Non-transferable warranty

This Warranty may be enforced only by the original purchaser.

What We Will Pay For

We will pay for all labor and material expenses for items covered by the warranty.

How You Can Get Service (Americas only)

1. If your unit needs service in the USA, contact our service referral at the appropriate telephone number indicated below. We will advise you of the name and location of one or more authorized service centers from which service may be obtained. Please do not return the unit directly to us.
2. You must pay any shipping charges if it is necessary to ship the product for service. If the necessary repairs are covered by the warranty, we will pay return shipping charges to your location anywhere in the United States or its territories.
3. Whenever warranty service is required, you must present the original dated sales receipt or other proof of date purchased.

Limitation of Implied Warranties

All implied warranties, including warranties of merchantability and fitness for a particular purpose, are limited in duration to the length of this warranty.

Exclusion of Damages (Americas only)

Liability for any defective product is limited to repair or replacement of the product at manufacturer's option. Manufacturer shall not be liable for damage to other products caused by any defects in Marantz products, damages based on inconvenience or loss of use of the product, or any other damages, whether incidental, consequential, or otherwise.

Some States do not allow limitations on how long an implied warranty lasts and/or do not allow the exclusion or limitation of incidental or consequential damages, so the above limitations and exclusions may not apply to you.

How State Law Relates to the Warranty (Americas only)

This warranty gives you specific legal rights, and you may have other rights which may vary from State to State.

Marantz Professional Service Number (Americas only):

Marantz Professional Factory Service (630) 741-0330, toll free within the US (866) 405-2154.

Products purchased outside of the United States, its possessions or territories.

This warranty is enforceable only in the United States and its possessions or territories.

marantz[®]

Marantz is a registered trademark.



Free Manuals Download Website

<http://myh66.com>

<http://usermanuals.us>

<http://www.somanuals.com>

<http://www.4manuals.cc>

<http://www.manual-lib.com>

<http://www.404manual.com>

<http://www.luxmanual.com>

<http://aubethermostatmanual.com>

Golf course search by state

<http://golfingnear.com>

Email search by domain

<http://emailbydomain.com>

Auto manuals search

<http://auto.somanuals.com>

TV manuals search

<http://tv.somanuals.com>