

marantz
PROFESSIONAL

Model CDR310 User Guide

CD Recorder

CLASS 1 LASER PRODUCT
LUOKAN 1 LASERLAITE
KLASS 1 LASERAPPARAT

COMPACT
disc
DIGITAL AUDIO

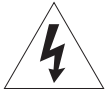

The lightning flash with arrowhead symbol within an equilateral triangle is intended to alert the user to the presence of uninsulated "dangerous voltage" within the product's enclosure that may be of sufficient magnitude to constitute a risk of electric shock to persons.



The exclamation point within an equilateral triangle is intended to alert the user to the presence of important operating and maintenance (servicing) instructions in the literature accompanying the product.

WARNING

**TO REDUCE THE RISK OF FIRE OR ELECTRIC SHOCK,
DO NOT EXPOSE THIS APPLIANCE TO RAIN OR MOISTURE.**

CAUTION:

**USE OF CONTROLS OR ADJUSTMENTS OR PERFORMANCE OF PROCEDURES OTHER THAN THOSE SPECIFIED HEREIN
MAY RESULT IN HAZARDOUS RADIATION EXPOSURE.**

WARNINGS

Do not expose the equipment to rain or moisture.

Do not remove the cover from the equipment.

Do not insert anything into the equipment through the ventilation holes.

Do not handle the mains lead with wet hands.

Do not cover the ventilation with any items such as tablecloths, newspapers, curtains, etc.

No naked flame sources, such as lighted candles, should be placed on the equipment.

When disposing of used batteries, please comply with governmental regulations or environmental public instruction's rules that apply in your country or area.

Do not place anything about 0.1 meter above the top panel.

Make a space of about 0.1 meter around the unit.

No objects filled with liquids, such as vases, shall be placed on the apparatus.

When the switch is in the OFF position, the equipment is not completely switched off from MAINS.

LASER SAFETY

This unit employs a laser. Only a qualified service person should remove the cover or attempt to service this device, due to possible eye injury.

Copyright

Recording and playback of any material may require consent. For further information refer to the following US ordinances:

- Copyright act of 1956
- Dramatic and Musical Performance Act 1958
- Performers Protection Acts 1963 and 1972
- any subsequent statutory enactments and orders

IMPORTANT SAFETY INSTRUCTIONS

READ BEFORE OPERATING EQUIPMENT

This product was designed and manufactured to meet strict quality and safety standards. There are, however, some installation and operation precautions which you should be particularly aware of.

1. Read these instructions.
2. Keep these instructions.
3. Heed all warnings.
4. Follow all instructions.
5. Do not use this apparatus near water.
6. Clean only with dry cloth.
7. Do not block any ventilation openings. Install in accordance with the manufacture's instructions.
8. Do not install near any heat sources such as radiators, heat registers, stoves, or other apparatus (including amplifiers) that produce heat.
9. Do not defeat the safety purpose of the polarized or grounding-type plug. A polarized plug has two blades with one wider than the other. A grounding type plug has two blades and a third grounding prong. The wide blade or the third prong are provided for your safety. If the provided plug does not fit into your outlet, consult an electrician for replacement of the obsolete outlet.
10. Protect the power cord from being walked on or pinched particularly at plugs, convenience receptacles, and the point where they exit from the apparatus.



11. Only use attachments/accessories specified by the manufacturer.
12. Use only with the cart, stand, tripod, bracket, or table specified by the manufacturer, or sold with the apparatus. When a cart is used, use caution when moving the cart/apparatus combination to avoid injury from tip-over.
13. Unplug this apparatus during lightning storms or when unused for long periods of time.
14. Refer all servicing to qualified service personnel. Servicing is required when the apparatus has been damaged in any way, such as power-supply cord or plug is damaged, liquid has been spilled or objects have fallen into the apparatus, the apparatus has been exposed to rain or moisture, does not operate normally, or has been dropped.

Additional Safety Information!

- This product should not be placed in a built-in installation such as a bookcase or rack unless proper ventilation is provided or the manufacturer's instructions have been adhered to.
- Apparatus shall not be exposed to dripping or splashing and that no objects filled with liquids, such as vases, shall be placed on the apparatus.
- The AC adaptor shall be installed near the Socket-Outlet and shall be easily accessible.

NOTE TO CATV SYSTEM INSTALLER:

This reminder is provided to call the CATV (Cable-TV) system installer's attention to Article 820-40 of the NEC, which provides guidelines for proper grounding and, in particular, specifies that the cable ground shall be connected to the grounding system of the building, as close to the point of cable entry as practical.

NOTE:

This equipment has been tested and found to comply with the limits for a Class B digital device, pursuant to Part 15 of the FCC Rules. These limits are designed to provide reasonable protection against harmful interference in a residential installation. This equipment generates, uses and can radiate radio frequency energy and, if not installed and used in accordance with the instructions, may cause harmful interference to radio communications. However, there is no guarantee that interference will not occur in a particular installation. If this equipment does cause harmful interference to radio or television reception, which can be determined by turning the equipment off and on, the user is encouraged to try to correct the interference by one or more of the following measures:

- Reorient or relocate the receiving antenna.
- Increase the separation between the equipment and receiver.
- Connect the equipment into an outlet on a circuit different from that to which the receiver is connected.
- Consult the dealer or an experienced radio/TV technician for help.

NOTE:

Changes or modifications may cause this unit to fail to comply with Part 15 of the FCC Rules and may void the user's authority to operate the equipment.

This Class B digital apparatus complies with Canadian ICES-003.

Cet appareil numérique de la Classe B est conforme à la norme NMB-003 du Canada.

CE marking (only EU version)

- English**
This product is in conformity with the EMC directive and low-voltage directive.
- Français**
Cet appareil est conforme á la directive EMC et á la de directive sur les basses tensions.
- Deutsch**
Dieses Gerát entspricht den EMC-Richtlinien und den Richtlinien für Niederspannungsgeräte.
- Nederlands**
Dit apparaat voldoet aan de EMC-richtlijnene en de richtlijnen voor apparatuur met laag voltage.
- Italiano**
Quest' unità è conforme alle direttive EMC ed alla direttiva sulle basse tensioni.
- Português**
Esta unidade está em conformidade com as directivas EMC e as directivas de baixa voltagem.
- Español**
Esta unidad estáde acuerdo con las normas EMC y las relacionadas con baja tensión.
- Svenska**
Produkten är tillverkad i enlighet med EMC-direktivet och direktivet för lågspänningsutrustning.

Equipment mains working system

This product complies with household power and safety requirements in your area.

SI DICHIARA CHE L'APPARECCHIO SINTO-AMPLIFACATORE SR-39
RISPONDE ALLE PRESCRIZIONI DELL'ART. 2 COMMA 1 DEL D.M. 28
AGOSTO 1995 N° 548.

FATTO A EINDHOVEN, IL 1/1/1997.

MARANTZ EUROPE B.V.
5600 EINDHOVEN
THE NETHERLANDS

"Este aparato lleva elementos antiparasitarios necesarios para cumplir con los límites que se establecen en el Anexo V del Reglamento sobre Perturbaciones Radioeléctricas e Interferencias aprobado en el Real Decreto 138/1989. (B.O.E. de 9 Febrero 1989)."

Table of Contents

| | | | |
|------------------------------------------|-----------|--------------------------------------------------|-----------|
| Package contents | 3 | 3. AllMkErase (How to erase all EDL marks) | 28 |
| Introduction | 4 | 4. Format (How to format a CF card) | 28 |
| Features | 4 | Virtual Track and Copy Segment | 29 |
| Preparation | 6 | Virtual Track | 29 |
| Installing the carry strap | 6 | Copy Segment | 29 |
| Installing batteries | 6 | Virtual Track Edit Mode | 29 |
| Controls and Connections | 7 | Creating a Virtual Track | 30 |
| Top side | 7 | Using Copy Segment to | |
| Front side | 12 | create a new file | 31 |
| Left / Right side | 13 | Entering Virtual Playback mode | 32 |
| Rear side | 14 | Virtual Track EDIT mode | 33 |
| Display | 15 | Copy SEG? | |
| Basic operation | 16 | [How to convert a Virtual Track to a new file] | 33 |
| CF cards | 17 | Copy SEG A? | |
| To insert a CF card | 17 | [How to convert all Virtual Tracks to new files] | 34 |
| To eject a CF card | 17 | 34 | |
| CF card security | 18 | VT Erase? | |
| CF card Format | 18 | [How to erase a Virtual Track] | 34 |
| Recording | 19 | AVT Erase? | |
| Connection Diagram | 19 | [How to erase all Virtual Tracks] | 35 |
| Recording Procedure | 19 | USB mode | 36 |
| Audio input for recording | 20 | Computer compatible | 36 |
| Recording Format parameters | 21 | How to connect via the USB port | 36 |
| Recording time chart | 21 | Diagram of file structure | 37 |
| Recording Level Control | 22 | Machine ID | 37 |
| Microphone Attenuator | 22 | Additional Functions | 38 |
| Pre Record | 22 | Battery | 38 |
| Silent Skip (Automatic Pause Recording) | 22 | Auto power off | 38 |
| Add a Track manually | 22 | Beep Alarm | 38 |
| Add a Track automatically | 23 | Key lock | 39 |
| Playback | 23 | Set Date and Time | 39 |
| Connection Diagram | 23 | LED level meter | 39 |
| Playback Procedure | 24 | Phantom Power | 39 |
| Track Access | 24 | Display | 40 |
| Search | 24 | Preset Setup | 41 |
| Audible Search | 25 | Table of Preset defaults (USA) | 42 |
| Audio output for playback | 25 | Table of Preset defaults (Europe) | 43 |
| EDL Mark | 25 | Troubleshooting | 55 |
| Add an EDL mark manually | 25 | Error Message | 57 |
| Search the EDL mark | 25 | Specifications | 58 |
| Add an EDL mark automatically | 26 | LIMITED WARRANTY - USA | 59 |
| Edit | 26 | | |
| 1. Trk Erase (How to erase tracks) | 27 | | |
| 2. TrkMkErase (How to erase | | | |
| all EDL marks within one track) | 27 | | |

Introduction

Thank you for purchasing this CDR310 CD Recorder. Before using the CD recorder, make sure that you read through this instruction manual carefully to fully understand the device's functions and how to operate them. We hope that you will continue to enjoy using the recorder for a very long time. After reading this manual, please keep it in a safe, easy to reach place for future reference.

Features

- You can record audio from an external microphone onto the internal HD (Hard Disk), and then burn the audio onto a CD-R.
- Audio input
 - Condenser microphone or dynamic microphone (XLR balanced input) connected to the MIC IN jack
 - Internal microphone
 - Line level audio source connected to the LINE IN jack
 - Digital input (Coaxial input)
- Phantom power supply
- L/R independent attenuator for external microphone input or internal microphone input
- 4 different types of recording format (MP3, WAVE, CD-DA, AIFF)
 - Compressed sound recording uses MPEG1 Layer III (MP3) monaural and stereo recording.
 - MP3 are compressed to 128kbps (stereo) or 64kbps (monaural).
 - Non-compressed sound recording uses 16-bit linear pulse code modulation (PCM).
- Simple recording
 - You can start simple recording to the HD just by pressing the REC button once. The HD capacity is 1.5GB. (Approx. 2 hours in PCM recording)
- You can create an extended play recorded CD (maximum 25 hours 29 minutes on a 700MB CD-R disc in MP3 mono format).
- Simple CD creation
 - You can burn data recorded on the HD onto a CD-R just by pressing the MAKE CD button.
- Convenient special recording functions
 - Pre-code cache (Ⓜ XX)
 - Background recording (Ⓜ XX)
 - Silent skip (Ⓜ XX)
 - Auto track (Ⓜ XX)
 - Manual track (Ⓜ XX)
- Recording level and LR balance adjustment (Ⓜ XX)
 - Automatic recording level control (ALC)
 - Manual control
- You can record and playback audio in stereo (2 channel) or monaural (1 channel).
- You can play back CD-DA and Data CD (MP3, AIF, WAV).
- The following sound outputs are available.
 - Internal speakers
 - Headphones connected to the headphone (PHONES) jack
 - Amp or other analog audio devices connected to the LINE OUT jack.
 - Digital output
- 2 types of power supply source
 - Use the provided AC adaptor.
 - Use alkaline batteries, the optional Nickel-Cadmium battery (RB1100), or the optional Nickel-Metal Hydride battery (RB1650).

Package contents

- CDR310

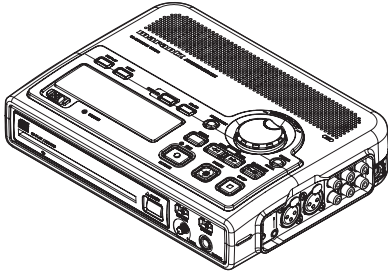

- AC power pack

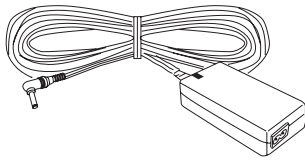

- Power cord

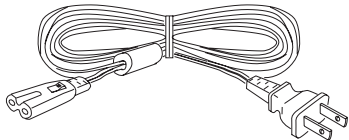

- Battery holder (AA type)

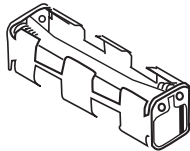

- User Guide
- Customer Registration Document

Quick Start Guide

Before using the CDR310, please read through the following section which explains the basic flow of operation.

1. Setup the power supply (☞ P.XX)

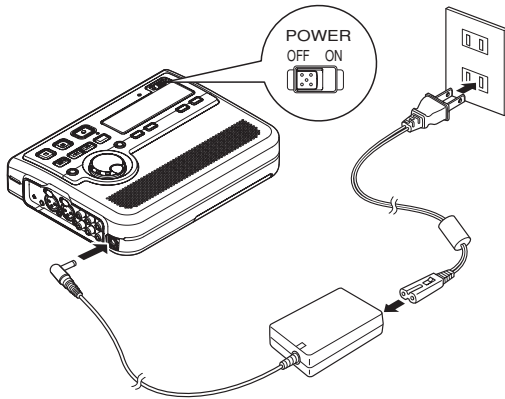

- Use either the provided AC adaptor or batteries.
- You can use any one of the 3 types of batteries: Alkaline, optional Nickel-Cadmium, or optional Nickel-Metal Hydride.
- Please make sure batteries are fully charged.

2. Connect an external microphone and turn the power ON. (☞ P.XX)

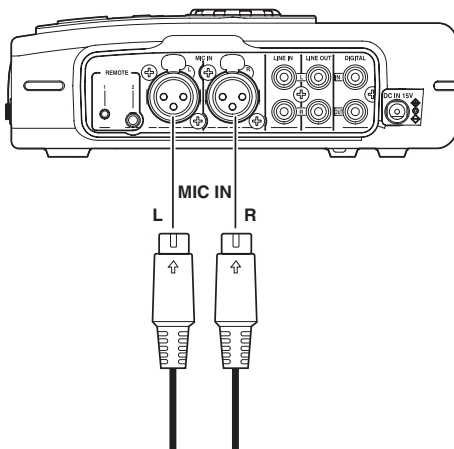

- Connect the external microphone to the MIC IN jack. (☞ P.XX)
- Slide the **power switch** to the ON side. (☞ P.XX)

3. Record (☞ P.XX)

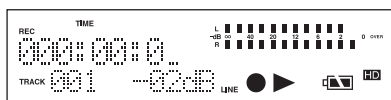

- Press the **REC** button, and recording starts.
- Adjust the recording level/LR balance. (☞ P.XX)
- Detailed settings for recording. (☞ P.XX)
- Press the **STOP** button, and recording stops.



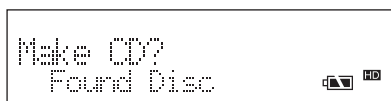

4. Burn a CD (☞ P.XX)



- Press the **MAKE CD** button to burn to a CD-R.
- When the CD burning process has completed, the CD-R is automatically ejected.
- To continue to burn to a different CD-R, insert a new CD-R.
- If the CD creation is ended without burning onto another CD-R, all of the HD data is deleted.

About Discs

Playable discs

| | |
|-------|-------------------------------------------------------------------------------------------------------------------------------------------------------------------------------------------------------------------------------------------------------|
| CD-R |   |
| CD-RW |    |

Finalized CD-R and CD-RW discs recorded in the CD-DA format, MP3 format or Video-CD format can be played with the unit.

- Finalize is the process to make a CD-R/CD-RW playable for players (not recorders)
- Some discs may not be able to be played depending on condition of the discs and recording software.
- Single CDs (8cm) cannot be used.

ADDITIONAL INFORMATION

The glossy side shining like a rainbow is the front side of the disc, and the side on which the label is printed is the back. Unlike conventional turntables for playing analog discs, the unit reads the information recorded on the disc from underneath without contacting it using a beam of laser light. Therefore, the performance of a compact disc will not degrade like conventional analog records.

Handle discs carefully so as not to damage or scratch the front side.

To protect the disc, avoid placing it in the following locations:

- In direct sunlight or near a source of heat like a heater.
- In a place which is damp or dirty.
- In a place which could be exposed to rain, such as near a window.

Always keep the disc surface clean.

When cleaning the disc surface, always be sure to use a special compact disc cleaner and wipe as shown below.

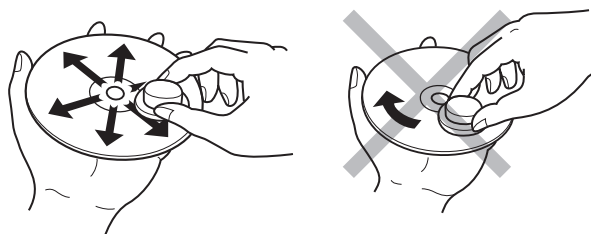

- Do not use conventional record cleaner for analog records, as this will adversely affect the disc surface. Store discs properly by placing them in their disc cases.
- Do not attach a piece of paper or sticker on the label side of disc. When a disc has a piece of plastic tape or rental DVD/CD label with paste protruded from the edge or when a disc has a trace of such a sticky object, do not attempt to play the disc. If such a disc is played on the DVD player, impossibility of taking out the disc or other malfunction may result.

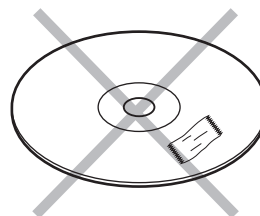

- Do not use a disc with a special shape. Do not attempt to play a disc with a special shape such as a heart-shaped disc or octagonal disc. Otherwise the equipment malfunction may result.

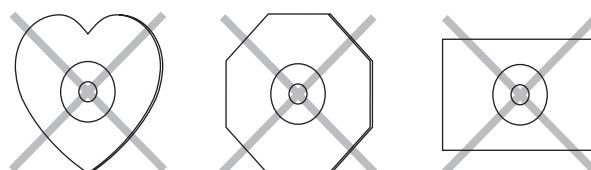

Names and Functions

Top side

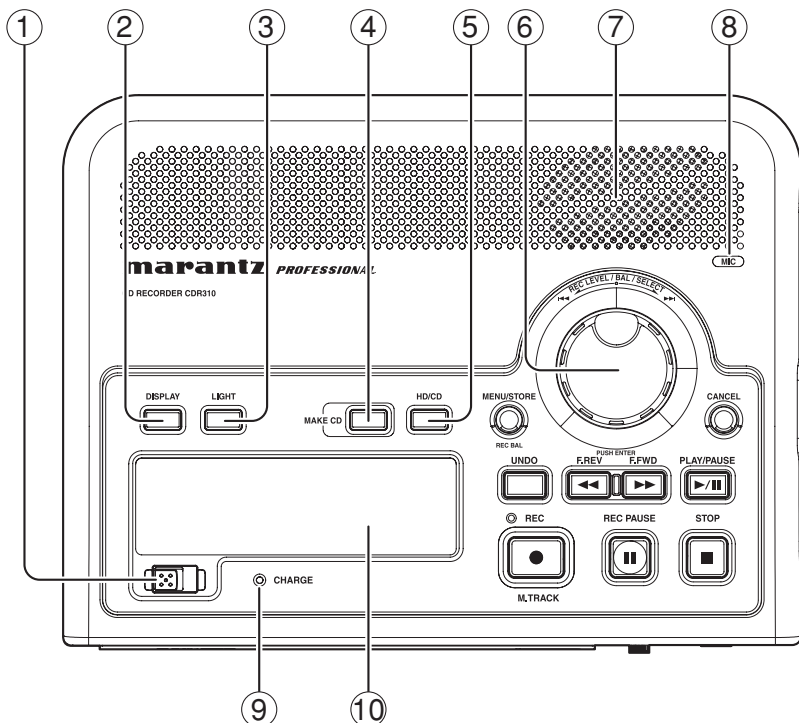

① Power switch

Slide this switch to switch the power on/off.

② DISPLAY button

Press this button to switch the contents of the display. The displayed information is different when the recorder is stopped, recording, and playing back. (P.XX)

③ LIGHT button

Press this button to light the display light for 3 seconds. Hold this button down for 1 second to keep the display light on. Press this button once again to turn the display light off.

④ MAKE CD button

You can burn the recorded data to CD-R by pressing this button when the recorder is stopped. (P.XX)

⑤ HD/CD button

Press this button when the recorder is stopped to switch between the HD recording/playback mode and CD playback mode.

⑥ JOG/ENTER button

• REC LEVEL control

You can adjust the recording level by rotating the JOG while the recording is paused, or during recording. You can also adjust the recording level left and right (L/R) balance by holding down the MENU button and rotating the JOG. (P.XX)

• Track selection

You can select the track you wish to play back by rotating the JOG while playback is paused, stopped, or during playback. After selecting the track that you wish to play back, press the JOG or PLAY/PAUSE button to play back the selected track. (P.XX)

• MENU mode

You can select the MENU items by rotating the JOG in the MENU mode. Press the JOG after selecting an item to choose that item. Press the CANCEL button to cancel the selection.

⑦ Internal speakers

The audio signal being played back is output to the internal speakers. If headphones are connected to the headphone (PHONES) jack, sound is not output from the internal speakers. Adjust the speaker volume using LEVEL volume.

⑧ MIC (Internal microphone)

⑨ CHARGE Indicator

This LED flashes while the optional rechargeable batteries are being recharged. The LED goes out when recharging has finished.

⑩ Display (P.XX)

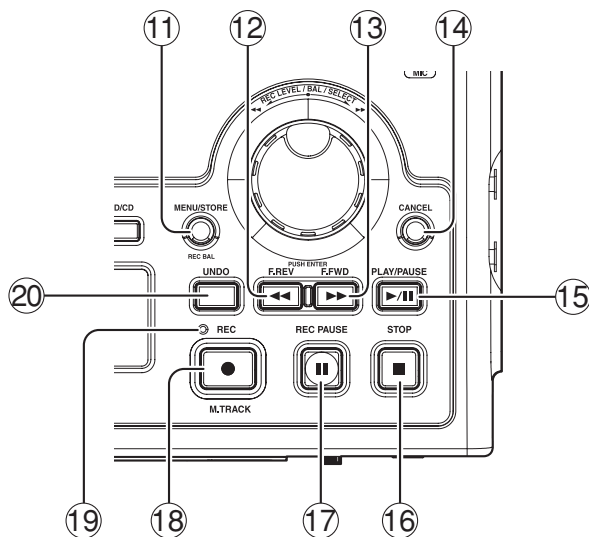

11 MENU/STORE button

• **MENU**

Press this button when the recorder is stopped to switch to the Menu mode. Turn the JOG to select the item that you wish to set from the various menu items. (P. XX)

• **STORE**

Press this button when you want to enter changes in the menu items, and when you want to write to the recorder.

• **REC BALANCE**

You can adjust the recording level L/R balance by holding down this button and rotating the JOG.

12 F.REV (◀◀) button

Press this button when the recorder is stopped to pause playback. Continue to press and hold this button to search tracks in reverse direction from the first track.

Press and hold this button during playback to search tracks in reverse direction at 2 times speed playback. Release the button to return to normal playback.

Press and hold this button when playback is paused to search tracks in reverse direction.

13 F.FWD (▶▶) button

Press this button when the recorder is stopped to pause playback. Continue to press and hold this button to search tracks in the forward direction from the first track.

Press and hold this button during playback to search tracks in the forward direction at 2 times speed playback. Release the button to return to normal playback.

Press and hold this button when playback is paused to search in the forward direction.

14 CANCEL button

Press this button in the MENU mode to cancel the menu contents being set, and to return to the stopped status.

15 PLAY/PAUSE button

Press this button when the recorder is stopped to start playback.

Press this button during playback to pause playback.

Also, if this button is pressed when playback is paused, playback restarts.

16 STOP button

Press this button during recording to stop the recording and save the recorded track (file).

Press this button during playback to stop playback. If you press the PLAY/PAUSE button after pressing the STOP button, the stopped track starts playback again from the beginning of the track.

17 REC PAUSE button

Press this button when the recorder is stopped to pause recording. You can adjust the recording level before recording in this state.

Press this button during recording to pause recording.

The REC indicator flashes while recording is paused.

18 REC button

Press this button when the recorder is stopped to start recording.

Also, press this button when recording is paused to start recording again.

If "Manual Trk" is set to ON in the menu item labeled "preset menu", pressing this button during recording saves the track currently being recorded, and starts recording as a new track.

Press the STOP button to stop recording.

19 REC Indicator

Remains lit while recording and flashes while recording is paused.

20 UNDO button

Press this button after stopping recording to delete the recorded track. (P. XX)

Front side

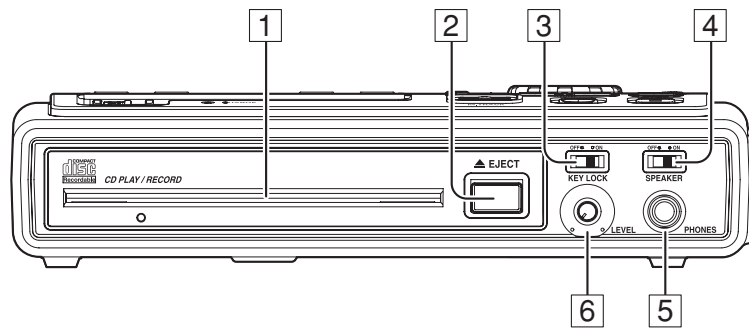

1 CD slot

2 EJECT button

Press this button to eject the CD that is inside the CD slot.

3 KEYLOCK switch

Set this switch ON to set to the key-lock status. All of the operating buttons and switches are locked, except for the LIGHT button.

4 SPEAKER switch

Set this switch to OFF to mute the output from the internal speakers.

5 Headphone (PHONES) jack

Insert the stereo headphones plug here.

6 LEVEL volume

Turn this knob to adjust the internal speaker volume or volume output from the headphone jack.

Notes

When recording with the internal microphone, switch the SPEAKER switch OFF to avoid feedback between the internal microphone and speakers.

Rear side

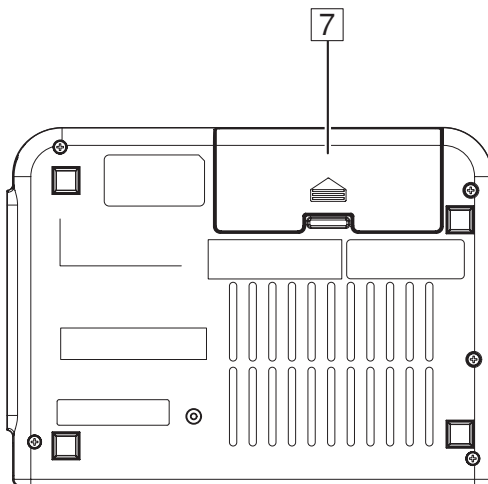

7 Battery case

Open the battery cover case, and insert the supplied battery holder (with alkaline batteries inserted), or the commercially available Nickel-Cadmium battery or Nickel-Metal Hydride battery.

Right side

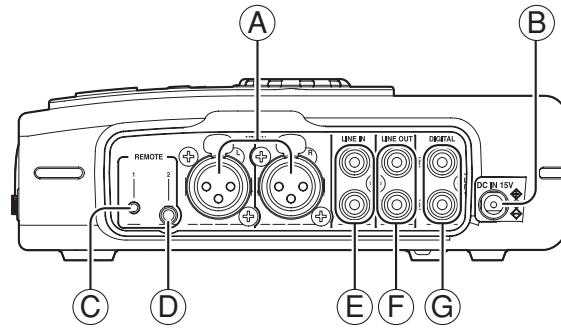

Ⓐ MIC IN jacks (L/R) (XLR balanced input)

Insert an external microphone plug.
For monaural recording, plug into either the L side or R side jack.

Ⓑ DC IN jack

Insert the provided AC adaptor plug.
The power supply is DC15V, 2.3A.
If the AC adaptor plug is inserted while using the recorder on battery power, the recorder will automatically switch to adaptor power. Also, if the AC adaptor plug is removed, the recorder will automatically switch to battery power.

Ⓒ REMOTE 1 jack

Insert a contact closure plug similar to the one shown below into this 2.5mm mini jack.

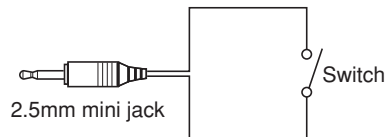

You can remotely control playback/recording of the recorder by opening and closing the switch contact. (P. XX)

Ⓓ REMOTE 2 jack

Connect microphone remote RC600PMD (sold separately) to this jack. There is a recording indicator lamp on the RC600PMD.

Ⓔ LINE IN jacks (L/R)

Insert RCA audio cable plugs connected to an external audio device into these jacks to input the signals output from the external device into the recorder.

Ⓕ LINE OUT jacks (L/R)

Insert RCA audio cable plugs connected to an external audio device into these jacks to output audio signals to an external device (amp, etc.).

Ⓖ DIGITAL IN/OUT

• IN

Connects to the digital signal output terminal (Coaxial) of a digital device (DVD, CD, MD, etc.).

• OUT

Connects to the digital signal input terminal (Coaxial) of a digital recording device (CD recorder, MD recorder, etc.).

Display

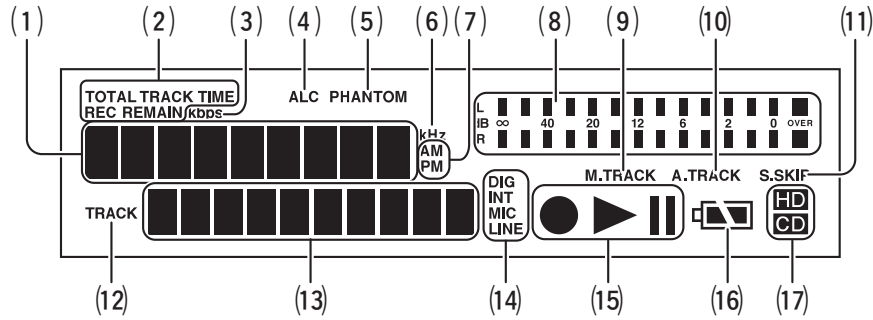

(1) **Upper character display section**

Displays the remaining time, etc.

(2) **TOTAL/TRACK/TIME/REC/REMAIN icon**

The following types of details are displayed in the upper character display section.

| Lit display | Explanation of display in upper character display section |
|-------------------|-----------------------------------------------------------------------------------------|
| REC REMAIN TIME | Lights when the remaining recordable time is being displayed. |
| TIME | Lights when the current time or the recording time is being displayed. |
| TRACK TIME | Lights when the playback elapsed time or the recording elapsed time is being displayed. |
| REC TIME | Lights when the recording time of the track is being displayed. |
| TRACK REMAIN TIME | Lights when the remaining playback time is being displayed. |
| TOTAL TRACK TIME | Lights when the total time for all tracks is being displayed. |

(3) **kbps icon**

Lights when the bit rate for the recording format is being displayed in the upper character display section.

(4) **ALC icon**

Lights when "REC Level" is set to ALC in the preset menu.

(5) **PHANTOM icon**

Lights when "Phantom" is set to ON in the preset menu.

(6) **kHz icon**

Lights when the sampling frequency for the recording format is being displayed in the upper character display section.

(7) **AM/PM icon**

When the clock setting is set to 12-hour display, the current time or recording time is displayed in the AM/PM format.

(8) **Level meter icon**

Displays the recording levels in the left and right channels during recording.

Displays the playback levels in the left and right channels during playback.

The level meter display dots have a peak hold function that holds for a fixed amount of time. (Self reset)

(9) **M.TRACK icon**

Lights when "ManualTR" is set to ON in the preset menu.

(10) **A.TRACK icon**

Lights when "Auto TRK" is set to ON in the preset menu.

(11) **S.SKIP icon**

Lights when "SilentSkip" is set to ON or TRK in the preset menu.

(12) **TRACK icon**

Lights when the track number is displayed in the lower character display section.

(13) **Lower character display section**

Displays the track number, channel, etc.

(14) **Input signal (DIG/MIC/INT/LINE) icon**

Shows the type of input signal when recording.

| Lit display | Type of input signal |
|-------------|------------------------------------------------------------|
| DIG | Lights when "Input" is set to Dig-In in the preset menu. |
| MIC | Lights when "Input" is set to MIC in the preset menu. |
| INT MIC | Lights when "Input" is set to Int. MIC in the preset menu. |
| LINE | Lights when "Input" is set to Line in the preset menu. |

(15) **Recording/Playback/Pause mark**

Shows the operating status of the recorder.

| Lit display | Operating status |
|-------------|---------------------------------------------|
| ▶ | Playback |
| ▶ | Playback paused |
| ● ▶ | Recording |
| ● ▶ | Recording paused (Recording standby status) |

(16) **Battery remaining indicator**

Displays the remaining battery power.

(17) **HD/CD icon**

Lights when the recorder is in the HD mode or CD mode.

Preparations Before Use

AC adaptor connection

When using the recorder with the provided AC adaptor, follow the procedure below to connect the AC adaptor.

If you wish to use batteries, please refer to the [Using batteries] section. (P.XX)

Notes

Only use the AC adaptor that is provided with the recorder. Running the recorder on DC power without using the provided AC adaptor will cause damage to the recorder.

- 1 Connect the plug of AC power pack into the DC IN jack on the recorder.
- 2 Connect the Power cord to a regular household plug socket.

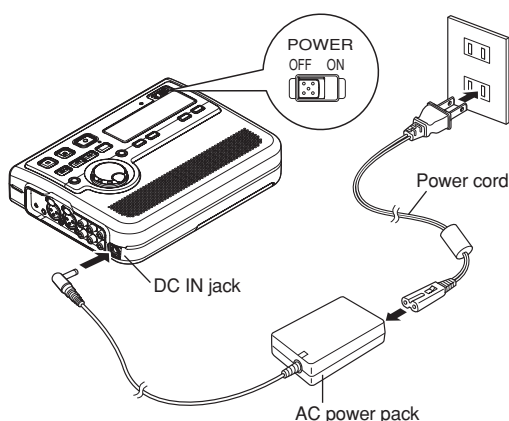

Notes

If a optional rechargeable battery is inside the recorder, the battery will be recharged in this state.

Using batteries

If you wish to run the recorder on battery power, follow the procedure below to install batteries into the provided battery holder, and insert the holder into the recorder.

The following types of battery can be used.

- Alkaline batteries
- Optional Nickel-Cadmium battery (option: parts number RB1100)
- Optional Nickel-Metal Hydride battery (option: parts number RB1650)

(Guide to battery lifespan)

When alkaline batteries (1450mAh type) are used
HD Recording: about 4 hours

Notes

- When running the recorder on batteries, always set the battery type in the preset menu to the correct setting for the batteries used. (P.XX)

- 1 Insert 8 batteries into the battery holder correctly as shown in the diagram below, while paying attention to the polarity displays (+: plus, and -: minus).

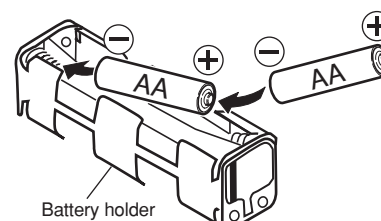

- 2 Remove the battery case cover from the rear side of the recorder.

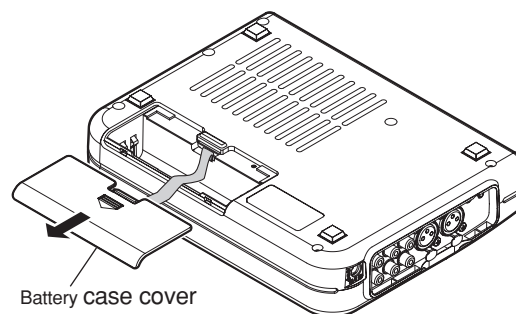

- 3** Insert the battery holder into the battery case of the recorder correctly as shown in the diagram below, while paying attention to the polarity displays (+: plus, and -: minus) on the case.

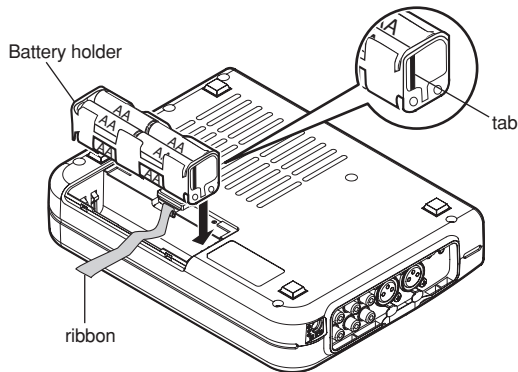

- 4** Re-attach the removed battery case cover.

Notes

- When using the optional rechargeable batteries for the first time, fully charge the batteries. Connect the provided AC adaptor to the recorder to recharge the batteries.
- If the batteries run out during the HD recording, recording automatically stops and the file information is updated before the recorder shuts down.
- When burning data from the HD to a CD-R, the CD burning process will not start if there is not enough battery power remaining. Furthermore, if the batteries run out while burning to the CD-R, recording will stop and the recorder will shut down. If this happens, the CD burning process may not complete correctly.

Safety cautions on handling batteries

Always follow the points below when using batteries to avoid electrolyte leakage, overheating, fire, rupturing, ingestion, etc.

- Electrolyte leakage or corrosion may occur if batteries are kept inside the recorder for prolonged periods of time. If the recorder is not to be used for a prolonged period, remove the batteries to prevent electrolyte leakage.
- Make sure that the + and – markings on the batteries are aligned with the corresponding markings in the battery case and the battery holder.
- Do not recharge, heat, or disassemble batteries. Do not throw dry cell batteries onto a fire.
- Do not insert old or exhausted batteries into the recorder.
- Do not mix the type of battery, and do not use both old and new batteries together.
- If the recorder does not operate correctly, replace the old batteries with new ones.
- If electrolyte has leaked, thoroughly wipe the inside of the battery holder, and then insert new batteries.

Installing an optional Ni-Cd or Ni-MH battery

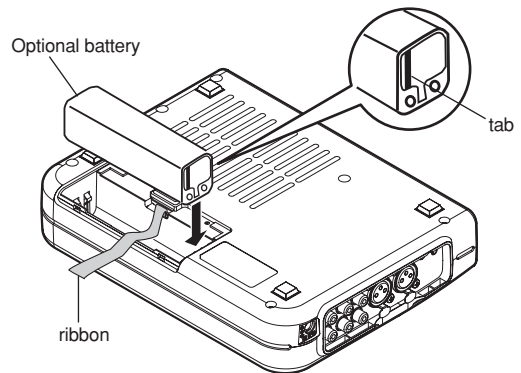

Install the battery with tab as shown and over the ribbon for easy battery removal.

When changing battery type, be sure you change the Battery type menu setting for optimal battery performance.

Charging the optional Ni-Cd battery

- Load the Ni-Cd battery correctly in the battery compartment.
- Connect the AC power pack and AC adaptor into power supply.
- Select Ni-Cd in the battery type menu. (P. XX)
- Power the CDR310 on, then off for the charging cycle to begin.
- The CDR310 must be off during battery charging.

While charging (about 3 hours), the CHARGE indicator will be lit and steady.

When the Ni-Cd battery charge cycle is complete, the CHARGE indicator will be off.

Basic Operations

Power on/off

- Slide the **power switch** to the ON side to switch the power ON.

Notes

The factory-preset settings are set to record sound using the external microphone input. Refer to “Menu Settings” for details on the default settings of the various menus. (P. XX)

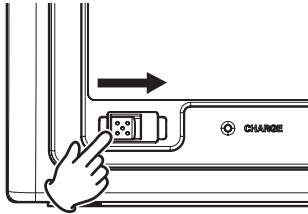

- At this time, the display shows “Loading”. The recorder’s BOOT process starts.



- The recorder stops when the BOOT process completes.

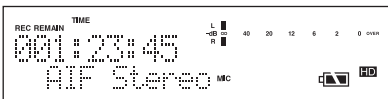

- Slide the **power switch** to the OFF side to switch the power OFF.

Battery type settings

Set the battery type for the recorder to match the type of batteries you are using.

< Default value > Alkaline

- While the recorder is stopped, press the **MENU/STORE** button.



- Turn the **JOG** to select “Batt Type” and press the **JOG**.

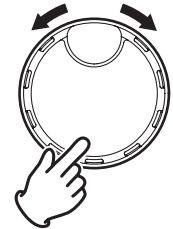
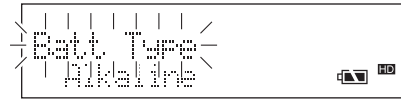

- Turn the **JOG** to select the type of battery, and press the **JOG**.

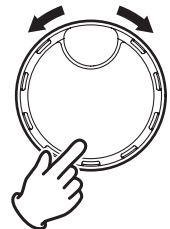
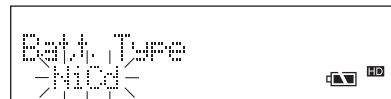



| Display | Battery type |
|----------|---------------------------------------|
| Alkaline | Alkaline battery |
| NiCd | Optional Nickel-Cadmium battery |
| NiMH | Optional Nickel-Metal Hydride battery |

- Press the **MENU/STORE** button to register the settings.



Battery remaining indicator ---

The recorder operates using commercially available AA size alkaline batteries, the optional Nickel-Cadmium battery, or the optional Nickel-Metal Hydride battery. During operation, the battery remaining indicator is as follows.

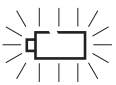
| Remaining indicator | Display explanation |
|-----------------------------------------------------------------------------------------------|-------------------------------------------------------------------------------------------------------------------------------------------------------------------------------------------------------------------------------------------------------|
| No display | Nothing is displayed when the AC adaptor is being used. The adaptor power supply is valid. |
|  | There is still ample battery power remaining. |
|  | The amount of battery power remaining has decreased to approx. half. |
|  | Only a small amount of battery power remaining. There is not enough battery power remaining to record or playback. Either replace the batteries with new ones, or recharge the rechargeable batteries. |
|  Flashing | There is almost no remaining battery power. If the "Beep" setting in the menu are set to ON, the beep sound will be heard. If you continue recording while this indicator is flashing, recording/playback will stop, and the recorder will shut down. |

Notes ---

If the battery type is not set correctly to match the type of battery being used, the battery remaining display may not be displayed correctly.

Setting the clock

Set the current time (year, month, date, hour, minute).

Notes

The setting order is different depending on the "DateForm" settings in the menu. Check the "Date form settings" setting. (P. XX)

| DateForm | Setting order |
|---------------------------------|-----------------------------|
| M (Month) / D (Date) / Y (Year) | Month→Date→Year→Hour→Minute |
| D (Date) / M (Month) / Y (Year) | Date→Month→Year→Hour→Minute |
| Y (Year) / M (Month) / D (Date) | Year→Month→Date→Hour→Minute |

< When DateForm: M/D/Y >

- 1 While the recorder is stopped, press the **MENU/STORE** button.



- 2 Turn the **JOG** to select "Date/time" and press the **JOG**.

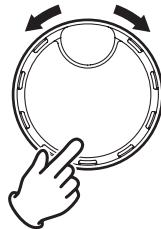
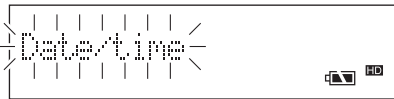

- 3 Turn the **JOG** to select [Month (Jan to Dec)], and press the **JOG**.

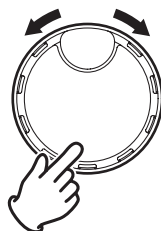
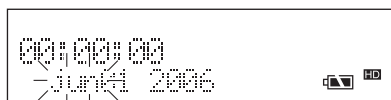

- 4 Turn the **JOG** to select [Date (01 to 31)], and press the **JOG**.

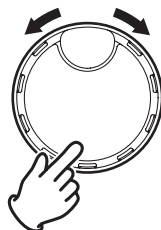
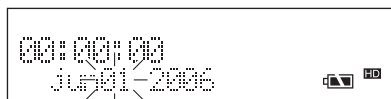

- 5 Turn the **JOG** to select [Year (2006 to 2099)], and press the **JOG**.

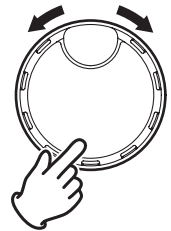
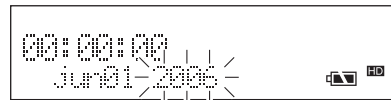

- 6 Turn the **JOG** to select [Time], and press the **JOG**.
For 24 hour display : 0 ~ 23
For 12 hour display : 0am ~ 11pm

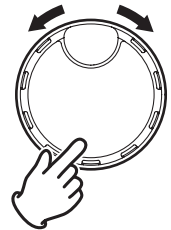

- 7 Turn the **JOG** to select [Minute (00 to 59)], and press the **JOG**.

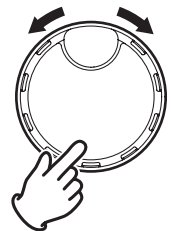
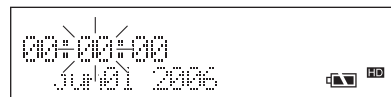

- 8 Press the **MENU/STORE** button to register the settings.



Date form settings

There are 3 types of date form. You can set the form to your own preference.

| Form type | Form subjects | Form example |
|-----------|-----------------|--------------|
| M/D/Y | Month/Date/Year | Jan 10 2006 |
| D/M/Y | Date/Month/Year | 10 Jan 2006 |
| Y/M/D | Year/Month/Date | 2006 Jan 10 |

< Default value > M/D/Y

- 1 While the recorder is stopped, press the **MENU/STORE** button.



- 2 Turn the **JOG** to select "Date Form" and press the **JOG**.

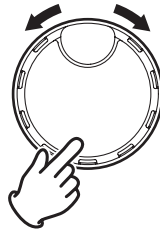
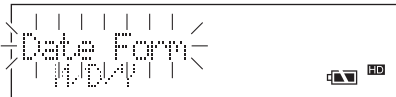

- 3 Turn the **JOG** to select the type of date form, and press the **JOG**.

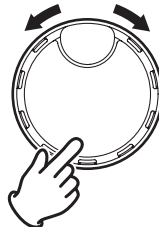

- 4 Press the **MENU/STORE** button to register the settings.



Time form settings

There are 2 types of time form. You can set the form to your own preference.

| Form type | Form subjects | Form example |
|-----------|-----------------|-----------------|
| 12H | AM/PM display | 01 : 00 : 00 pm |
| 24H | 24 hour display | 13 : 00 : 00 |

< Default value > 12H

- 1 While the recorder is stopped, press the **MENU/STORE** button.



- 2 Turn the **JOG** to select "Time Form" and press the **JOG**.

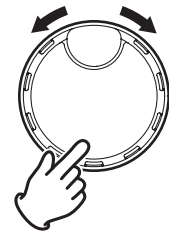
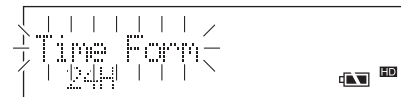

- 3 Turn the **JOG** to select the type of time form, and press the **JOG**.

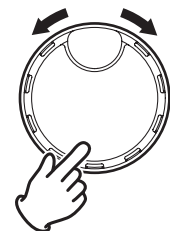
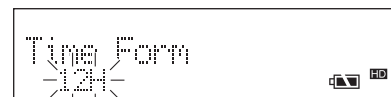

- 4 Press the **MENU/STORE** button to register the settings.



Menu Settings

The recorder uses 8 menus to set the various functions.

There is a menu for basic settings such as time (display method), alarm, automatic power off, and battery type, and a menu for formatting the internal HD. These menus are displayed by pressing the **MENU/STORE** button once to enter the menu mode.

You can also perform detailed settings for the recording and playback conditions, and register up to 3 of these settings in the preset menu. To enter this preset menu, select "PRESET" using the **JOG**, then specify the preset number.

Refer to "Preset Menu" for details on preset items. (P. XX)

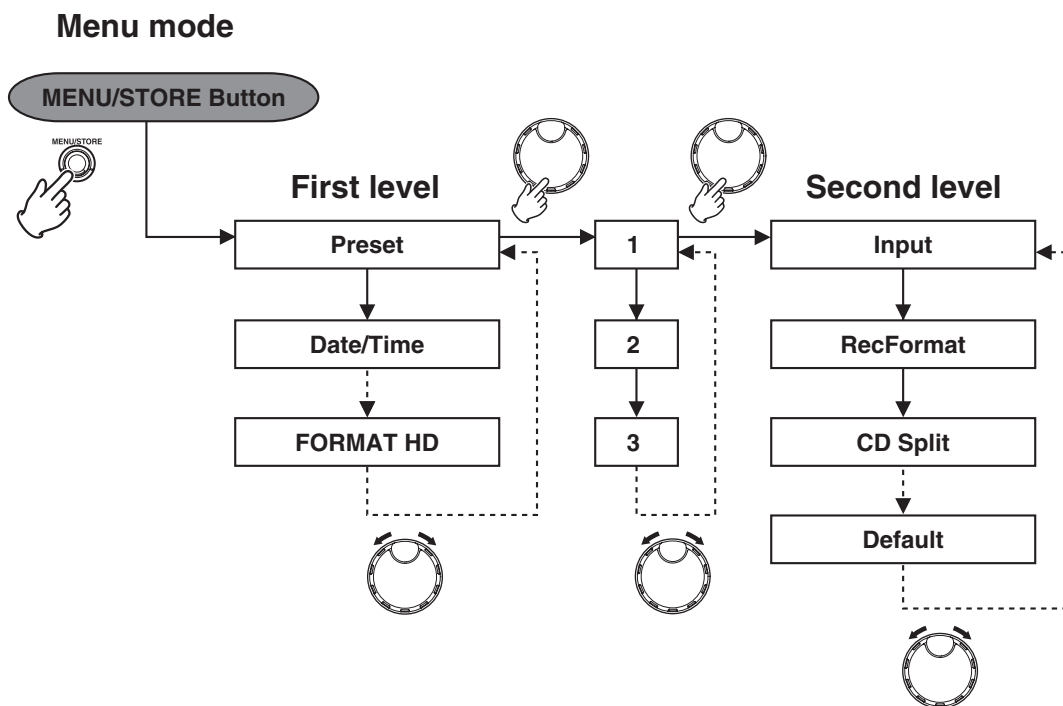

The composition of these menu contents is explained below.

| Menu | Menu explanation | Settings | Default settings |
|--------------------------|------------------------------------------------------------------------------------|------------------------------------------------------------------------|-----------------------------------|
| Preset (P. XX) | 3 settings can be registered. Select the preset number, and set the various items. | Preset-1, 2, 3 | Preset-1 |
| Date/Time (P. XX) | Sets the clock (current date and time). | 2006–2099 JAN – DEC 1 – 31 AM/PM 0:00 – 11:59, (0:00 – 23:59) | 2006 JAN 1 AM0:00 (0:00) |
| Date Form (P. XX) | Selects the type of date form. | M (Month) / D (Date) / Y (Year), D/M/Y, Y/M/D, | M/D/Y |
| Time Form (P. XX) | Selects the type of time form. | 12H, 24H | 12H |
| Beep (P. XX) | Sets the alarm on/off. | On/Off | On |
| A.PowOff (P. XX) | Sets the automatic power off setting. | On/Off Time : 5/10/15/30 min | Off 15 min |
| Batt_Type (P. XX) | You can select the type of battery. | Alkaline, NiCd, NiMH | Alkaline |
| HD Format (P. XX) | Formats the HD. | (Execute) | – |

Preset menu

You can register up to 3 detailed setting on the recorder for such settings as recording input, recording conditions, recording format, playback mode, remote control, etc. There are 17 setting items in the preset menu, and 3 presets can be set with the desired conditions.

The contents of the preset menu are explained below.

Preset1 : High quality PCM recording

Preset2 : Meeting recording (monaural)

Preset3 : MP3 music recording

| Preset menu | Menu explanation | Settings | Default settings | | |
|-------------------------|---------------------------------------------------------------------------------------------------------------------------------------|----------------------------------------------------------------------------|-----------------------|-----------------------|-----------------------|
| | | | Preset1 | Preset2 | Preset3 |
| Input (P.xx) | Selects the input source. | MIC, Line, Int. MIC, Dig-In | MIC | MIC | MIC |
| RecFormat (P.xx) | Sets the recording format. | Stereo, Mono CD-DA, WAVE, MP3, AIFF | Stereo CD-DA | Mono MP3 | Stereo MP3 |
| CD Split (P.xx) | When burning HD data to CD-R, this sets the saving procedure for the final track when all of the contents will not fit onto one CD-R. | On/Off | On | On | On |
| PreRecord (P.xx) | Sets PreRecord. | Off/1–10 sec (1 sec steps) | Off | 4 sec | 4 sec |
| Rec Level (P.xx) | Sets the recording level operating method. | Manual/ALC | Manual | Manual | Manual |
| MIC-ATT-L (P.xx) | External microphone Sets the attenuator function for the left channel side. | On/Off | Off | Off | Off |
| MIC-ATT-R (P.xx) | External microphone Sets the attenuator function for the right channel side. | On/Off | Off | Off | Off |
| IntMicATT (P.xx) | Sets the attenuator function for the internal microphone. | On/Off | Off | Off | Off |
| Phantom (P.xx) | Sets the Phantom power supply when a condenser microphone is connected. | On/Off | Off | Off | Off |
| BkGrndRec (P.xx) | Sets background recording. | On/Off | Off | Off | Off |
| ManualTR (P.xx) | Sets Manual Track. | On/Off | On | On | On |
| Auto TRK (P.xx) | Sets Auto Track. | On/Off Time : 1/5/10/15/30 min, 1/2/6/8/12/24 Hrs, 640/700 MB CD | Off 5 min | On 5 min | Off 5 min |
| SilentSkp (P.xx) | Sets Silent Skip. | On/Off Time : 1–5 sec (1 sec steps) Level: -60– -20dB (5dB steps) | Off 3 sec -40dB | Off 3 sec -40dB | Off 3 sec -40dB |
| Play Mode (P.xx) | Sets the playback mode. | Normal, Repeat All, Repeat TRK, Single | Normal | Normal | Normal |
| StopMonit (P.xx) | Sets the Stop Monitor. | On/Off | Off | Off | Off |
| Remote (P.xx) | Sets the operating mode controlled by the opening and closing of a switch contact. | * StartPause, StartPauTR, Manual TRK | Manual TRK | StartPauTR | StartPause |
| Default (P.xx) | Returns the settings of the selected preset number only to the default values. | (Execute) | --- | --- | --- |

* StartPause : Start / stop
StartPauTR : Start / stop + track increment
Manual TRK : Manual track

Menu operation

The recorder uses menus to set various functions. (P.XX) You can alter the basic settings and use a wide range of recording and playback functions by changing the menu settings. The basic menu operations are explained in this section.

- 1 While the recorder is stopped, press the **MENU/STORE** button to enter the menu mode.

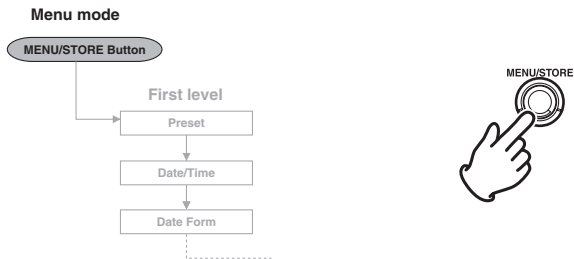

- The recorder enters the menu mode.

- 2 Turn the **JOG** to select a menu item.

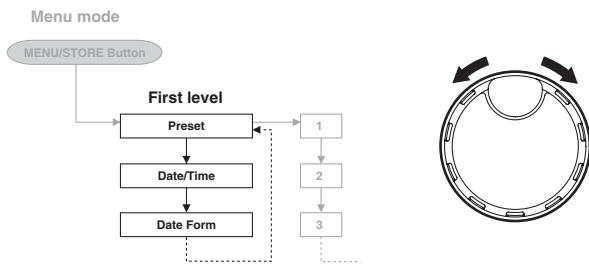

- 3 Press the **JOG** to choose the selected menu item.

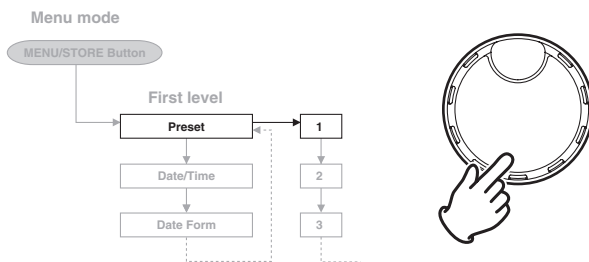

- The recorder enters the setting mode for the menu item.

- 4 Turn the **JOG** to select the menu settings, then press the **JOG** to choose the selected settings.

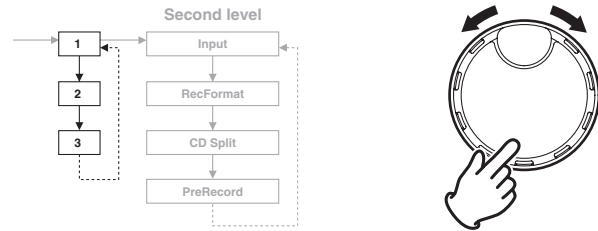

- Repeat the procedure above of rotating the **JOG** to select settings and items, and pressing the **JOG** to choose items and contents, to set each of the menu items.

- 5 Finally, press the **MENU/STORE** button to register all of the settings.



Recording to the HD

Schematics

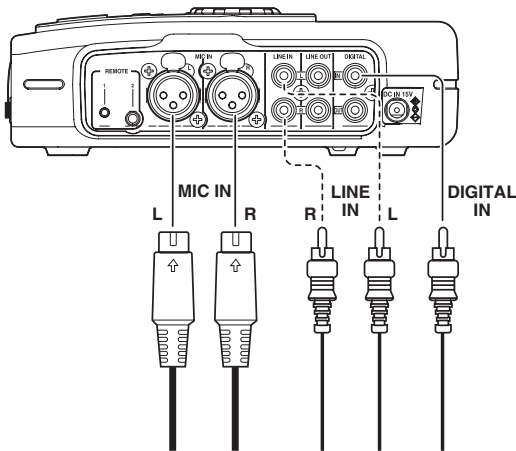

Basic operations for recording

- 1 Press the **REC** button when the recorder is stopped to start recording.
 - During recording, the REC indicator lights and the following contents are displayed on the display.

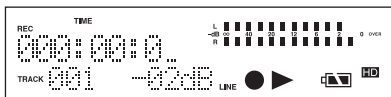

Notes

- The default preset settings for [Recording level control settings] are set to "Manual". For details on adjusting the recording level/LR balance, please refer to [Recording level control settings]. (P. XX)
- When recording with the internal microphone, switch the SPEAKER switch OFF to avoid feedback between the internal microphone and speakers.

- Also, to start recording from the recording standby status, press the **REC PAUSE** button while the recorder is stopped to switch to recording standby status. When in recording standby status, the REC indicator flashes and the following contents are displayed on the display.



Adjust the recording level/LR balance while in recording standby. (P. XX)
 After adjusting the recording level/LR balance, press the **REC** button to start recording.

- 2 Press the **REC PAUSE** button to pause recording.
 - The recording mark flashes in the display while recording is paused.

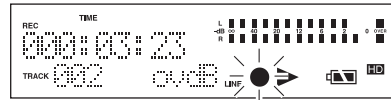

- Press the **REC** button when recording is paused to start recording again.

- 3 Press the **STOP** button to stop recording.
 - The recorded track (file) information is saved to the HD.

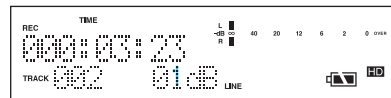

- Press the **PLAY** button after this to play back the recorded track from the start.

- 4 Press the **STOP** button once again to return to the stopped status.

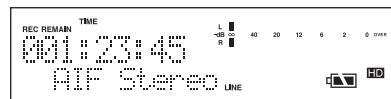

- Press the **PLAY** button after this to play back from the first track.

Erasing recordings

You can erase data (tracks) recorded to the HD after stopping recording.

- 1 After stopping recording, press the **UNDO** button to switch to the erase mode of the recorded track.
 - “REC UNDO?” is displayed for 3 seconds.



- 2 Press the **UNDO** button again while “REC UNDO?” is being displayed.
 - The recorded track is erased, and “Completed” is displayed for 3 seconds.

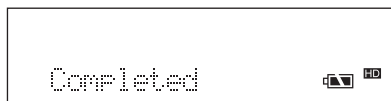

Formatting the HD

Formats all of the tracks recorded onto the HD.

Notes

If the HD is formatted, all contents of the HD are erased. Before formatting, re-check the contents of the HD.

- 1 While the recorder is stopped, press the **MENU/STORE** button.



- 2 Turn the **JOG** to select “Format HD” and press the **JOG**.

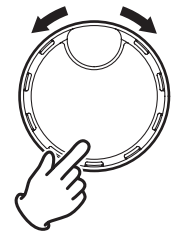
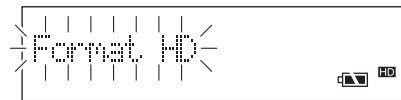

- A confirmation message to perform HD format is displayed.

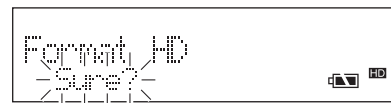

- 3 To format the HD, press the **JOG**.
 - “Formatting” is displayed while the HD is being formatted.

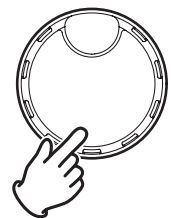
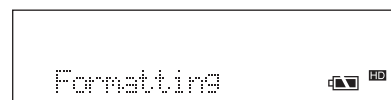

- After formatting has completed, “Completed” is displayed for 1 second. After that, the recorder returns to the stopped status.

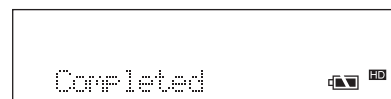

Detailed Settings for HD Recording

Input source settings

Set the input source (internal microphone, external microphone, line input, digital input) for recording.

< Default value > Preset1 : MIC
 Preset2 : MIC
 Preset3 : MIC

Notes

If digital input is set, only the sampling frequency 44.1KHz is available. Any other frequencies are displayed as unlocked, and are not recorded.

1 While the recorder is stopped, press the **MENU/STORE** button.



2 Turn the **JOG** to select "Preset" and press the **JOG**.

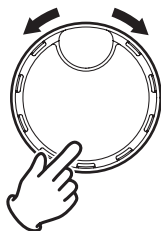
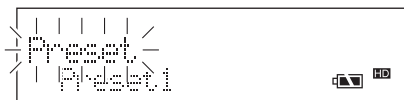

3 Turn the **JOG** to select the preset number that you wish to set, and press the **JOG**.

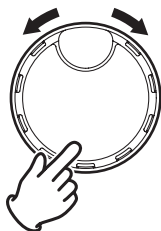

4 Turn the **JOG** to select "Input" and press the **JOG**.

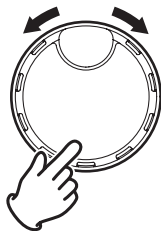

5 Turn the **JOG** to select the type of input source ("MIC", "Line", "Int.Mic", "Dig-In"), and press the **JOG**.

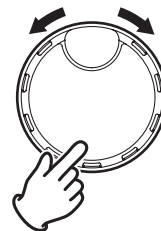

6 Press the **MENU/STORE** button to register the settings.



Notes

Depending on the combination of input source and recording format (channel), the input signal stereo / monaural settings are as follows.

For details on the recording format settings, please refer to [Recording format settings]. (P.XX)

| | | Recording format (channel) | |
|--------------|---------------------|----------------------------|--------------|
| | | Stereo | Mono |
| Input source | External microphone | L/R Stereo | L/R Mono Mix |
| | Internal microphone | Same source in L/R | Mono |
| | LINE Input | L/R Stereo | L/R Mono Mix |
| | DIGITAL input | L/R Stereo | L/R Mono Mix |

Recording format settings

Set the recording format (compression format and channel) for recording.

< **Default value** > Preset1 : Stereo/CD-DA
Preset2 : Mono/MP3
Preset3 : Stereo/MP3

Notes

The recording format can only be changed when there are no tracks saved on the HD. There is only one HD recording format on the recorder. This cannot be changed if tracks are already recorded in a certain format. To change the recording format, either burn the data to a CD-R, or format the HD. When data is burned to a CD-R, the data on the HD is erased. Stereo/monaural can be changed.

[Recording format parameters]

The recorder can record in the following compression formats and channels.

- Compressed sound recording that uses MPEG Audio Layer III (MP3) in either monaural or stereo.
- Non-compressed sound recording that uses the 16-bit linear pulse code modulation used on a CD.
- Non-compressed sound recording that uses WAVE (Windows standard audio file format)
- Non-compressed sound recording that uses AIFF (the audio file format developed by Apple Computer, Inc.)

The format parameters that can be recorded are as shown below.

When the channel setting is Stereo

| Recording format | Sampling frequency | Bit rate | Extension | Recordable time |
|------------------|--------------------|----------|-----------|-----------------|
| MP3 | 44.1KHz | 128Kbps | .mp3 | 055:55:24 |
| CD-DA | 44.1KHz | — | .cda | 005:04:21 |
| WAVE | 44.1KHz | — | .wav | 005:04:21 |
| AIFF | 44.1KHz | — | .aif | 005:04:21 |

When the channel setting is Mono

| Recording format | Sampling frequency | Bit rate | Extension | Recordable time |
|------------------|--------------------|----------|-----------|-----------------|
| MP3 | 44.1KHz | 64Kbps | .mp3 | 111:50:49 |
| CD-DA | 44.1KHz | — | .cda | 010:08:42 |
| WAVE | 44.1KHz | — | .wav | 010:08:42 |
| AIFF | 44.1KHz | — | .aif | 010:08:42 |

When burning from the HD to CD, the CD-R Format is decided by the recording format as shown below.

| Recording format | CD Format |
|------------------|------------|
| MP3 | Data Disc |
| CD-DA | CD-DA Disc |
| WAVE | Data Disc |
| AIFF | Data Disc |

Set the recording format (compression format and channel) using the procedure shown below.

- 1** While the recorder is stopped, press the **MENU/STORE** button.



- 2** Turn the **JOG** to select "Preset" and press the **JOG**.

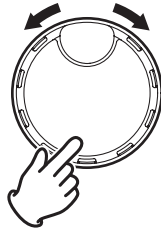
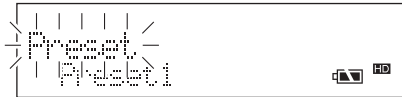

- 3** Turn the **JOG** to select the preset number that you wish to set, and press the **JOG**.

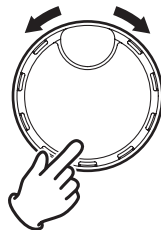
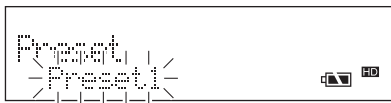

- 4** Turn the **JOG** to select "RecFormat" and press the **JOG**.

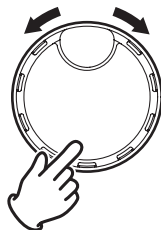
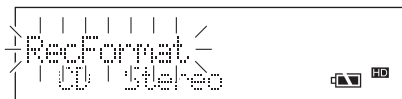

- 5** Turn the **JOG** to select the compression format ("MP3", "CD-DA", "WAVE", "AIFF"), and press the **JOG**.

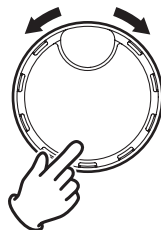
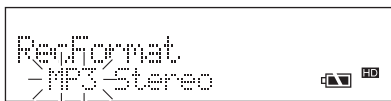

- 6** Turn the **JOG** to select the channel ("Stereo", "Mono") and press the **JOG**.

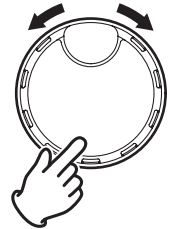

- 7** Press the **MENU/STORE** button to register the settings.



Recording level control settings

Set the recording level control and operating method (ALC, Manual) for recording.

- Automatic level control (ALC)
If the recording level control or operating method is set to ALC, the recording level for external microphone input or internal microphone input is automatically set.
When ALC is set, the ALC icon lights in the display.

Notes

ALC becomes invalid for line input or digital input recording. Even if the ALC is set, control switches to manual control.

- Manual control (Manual)
If the recording level control or operating method is set to Manual, turn the **JOG** to set the recording level when recording is paused or during recording.
Also, the LR balance can be set by holding down the **MENU** button and rotating the **JOG** during recording.

< Default value > Preset1 : Manual
Preset2 : Manual
Preset3 : Manual

- 1 While the recorder is stopped, press the **MENU/STORE** button.



- 2 Turn the **JOG** to select "Preset" and press the **JOG**.

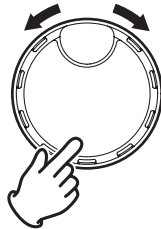
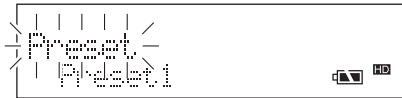

- 3 Turn the **JOG** to select the preset number that you wish to set, and press the **JOG**.

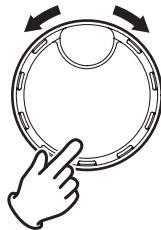

- 4 Turn the **JOG** to select "RecLevel" and press the **JOG**.

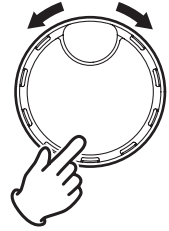
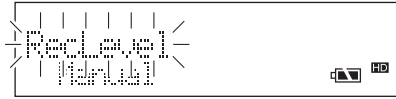

- 5 Turn the **JOG** to select the operating method of the recording level ("ALC", "Manual") and press the **JOG**.

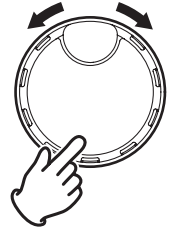
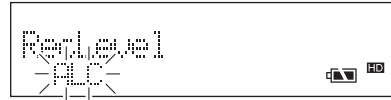

- 6 Press the **MENU/STORE** button to register the settings.



[Operations when manual control is set]

When the recording level control or operating method is set to Manual, use the **JOG** as shown below to set the recording level.

- Recording level settings

Turn the **JOG** while recording is paused or during recording, and the manual level control screen is displayed.

Turn the **JOG** to set the level.

(The level can be changed from +10dB to -∞dB)

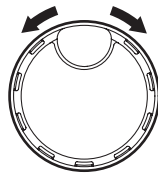
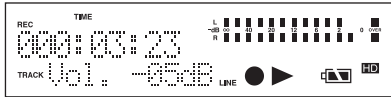

- LR balance settings

Hold down the **MENU** button and turn the **JOG** while recording is paused or during recording, and the LR balance control screen is displayed.

Turn the **JOG** to set the LR balance.

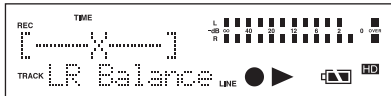

+

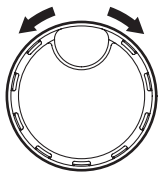

The LR balance can be changed to 0dB to -18dB on the left, or 0dB to -18dB on the right.

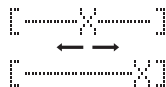

If the above-mentioned recording level and LR balance are left without operation for 3 seconds, the recorder returns to the previous display mode.

Microphone attenuator

Set the attenuator function for external microphone input and internal microphone input.

For external microphone input, set this function when using microphones directly that have different sensitivity levels. The attenuator function for the external microphone can be set for the L/R sides respectively.

For internal microphone input, set this function when the sensitivity is too high.

- Attenuator OFF (0dB)
No microphone level attenuation.
- Attenuator ON (-20dB)
The input signal from either the microphone connected to the MIC IN jack or the internal microphone is attenuated by 20dB.

< **Default value** > Preset1 : Off
Preset2 : Off
Preset3 : Off

1 While the recorder is stopped, press the **MENU/STORE** button.



2 Turn the **JOG** to select "Preset" and press the **JOG**.

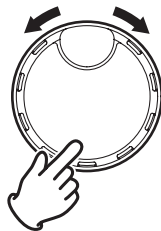
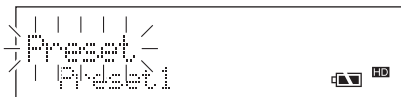

3 Turn the **JOG** to select the preset number that you wish to set, and press the **JOG**.

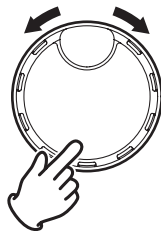

4 Turn the **JOG** to select the microphone attenuator item ("MIC-ATT-L", "MIC-ATT-R", "IntMicATT") that you want to set in the preset menu, and press the **JOG**.

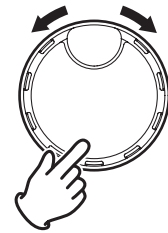
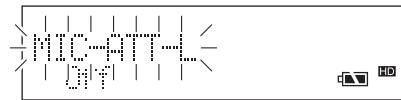

| Preset menu | Menu contents |
|-------------|-------------------------------|
| MIC-ATT-L | External microphone L Channel |
| MIC-ATT-R | External microphone R Channel |
| IntMicATT | Internal microphone |

5 Turn the **JOG** to select function On/Off, and press the **JOG**.

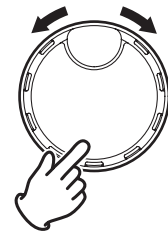
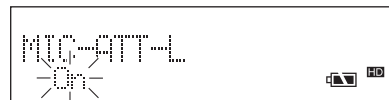

6 Press the **MENU/STORE** button to register the settings.



Phantom power settings

The recorder has DC+48V (P48) phantom power, and the phantom power can be set On/Off.

Set to On when a condenser microphone that requires the external power source is used.

When set to On, the "PHANTOM" icon lights in the display.

For details, please refer to the instruction manual that came with your microphone.

Phantom power consumes battery power. Set this setting to Off when using the internal microphone, a dynamic type microphone, or other such microphone that does not use phantom power.

< Default value > Preset1 : Off
Preset2 : Off
Preset3 : Off

- 1 While the recorder is stopped, press the **MENU/STORE** button.



- 2 Turn the **JOG** to select "Preset" and press the **JOG**.

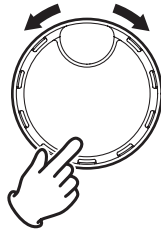
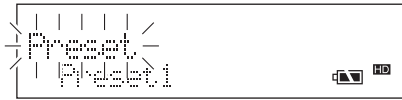

- 3 Turn the **JOG** to select the preset number that you wish to set, and press the **JOG**.

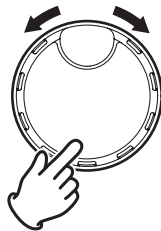

- 4 Turn the **JOG** to select "Phantom" and press the **JOG**.

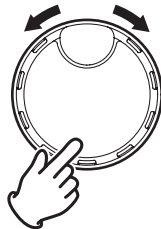
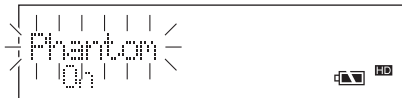

- 5 Turn the **JOG** to select function On/Off, and press the **JOG**.

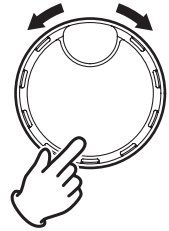

- 6 Press the **MENU/STORE** button to register the settings.



Prerecord

Set the PreRecord function.

When the PreRecord function is set to On, sounds from the input source are always saved only for a set period of time (1 to 10 seconds) in modes other than CD playback mode, Make CD mode, during playback, or during playback pause. When the recording is restarted, the audio data temporarily saved in the recorder is written to the HD, then recording continues from there.

This can be set to a maximum of 10 seconds, which prevents missing the first part of a recording when recording is suddenly started.

< Default value > Preset1 : Off
Preset2 : 4 sec
Preset3 : 4 sec

- 1 While the recorder is stopped, press the **MENU/STORE** button.



- 2 Turn the **JOG** to select "Preset" and press the **JOG**.

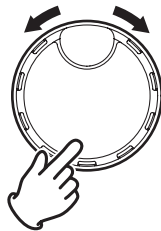

- 3 Turn the **JOG** to select the preset number that you wish to set, and press the **JOG**.

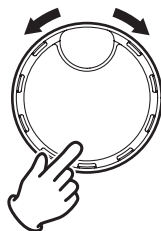

- 4 Turn the **JOG** to select "PreRecord" and press the **JOG**.

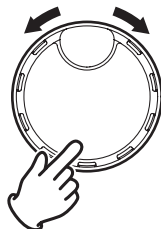
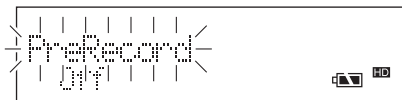

- 5 Turn the **JOG** to select the temporary save time (1 to 10 seconds), and press the **JOG**.

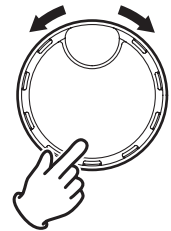

- 6 Press the **MENU/STORE** button to register the settings.



Background recording

Set background recording.

When background recording is set to On, recording is continued inside the recorder while recording is paused. This can be used to recover data after pausing a recording, so that nothing is missed even if important contents are lost while the recording is paused.

When the **REC** button is pressed to restart recording from the recording paused status, the display shows "Cont REC?" (Do you continue the recording?) "Yes".

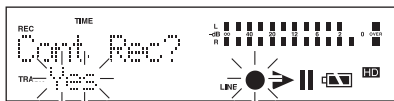

Turn the **JOG** to select Yes/No, and press the **JOG**.

- When Yes is selected

The audio data recorded by background while the recording was paused continues to be recorded.

- When No is selected

The data recorded by background is erased, and the recording starts as a new track. The new track is created from the point in which the track No is selected. At this time, if prerecord is set, only the data for the prerecord setting time remains.

Also, if the **STOP** button is pressed, the recording and this function stops.

< **Default value** > Preset1 : Off
 Preset2 : Off
 Preset3 : Off

- 1 While the recorder is stopped, press the **MENU/STORE** button.



- 2 Turn the **JOG** to select "Preset" and press the **JOG**.

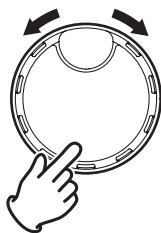
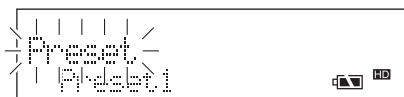

- 3 Turn the **JOG** to select the preset number that you wish to set, and press the **JOG**.

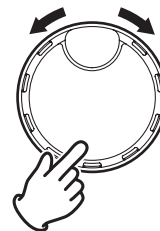

- 4 Turn the **JOG** to select "BkGrndRec" and press the **JOG**.

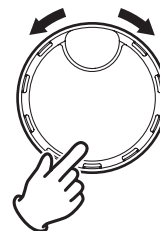
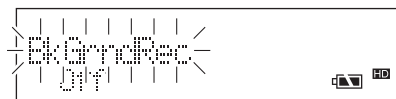

- 5 Turn the **JOG** to select function On/Off, and press the **JOG**.

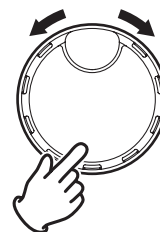
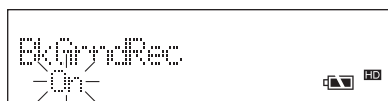

- 6 Press the **MENU/STORE** button to register the settings.



Silent skip

Set the silent skip function.

- Silent skip

The silent skip function automatically pauses the recording if there is a period of no signal during recording. Recording automatically starts again when an input signal is received. This function cuts unnecessary sections (sections with no sound) from within one track, and saves only the necessary sections. The file size is smaller, search is easier during playback, and the tracks are easier to listen to.

When silent skip is set, "S.SKIP" lights in the display, and it flashes when the recording is paused while there is no input signal.

- Silent skip/Track increment

Silent skip is processed within one track. However, if this function is set, every time the input signal is received, a new track is automatically created for the recording.

Notes

- This function does not operate when [Background recording] is set to On in the preset menu.
- When silent skip is set to ON, the prerecord function operates for 2 seconds, irrespective of the prerecord setting time.
- When silent skip is set to On, and the REC PAUSE button is pressed while the recorder is paused due to there being no signal, the recorder switches to regular recording pause status. At this time, the S.SKIP icon flashes in the display.

< Default value >

Preset1 : Off / Time : 3 sec / Level : -40dB
 Preset2 : Off / Time : 3 sec / Level : -40dB
 Preset3 : Off / Time : 3 sec / Level : -40dB

- 1 While the recorder is stopped, press the **MENU/STORE** button.



- 2 Turn the **JOG** to select "Preset" and press the **JOG**.

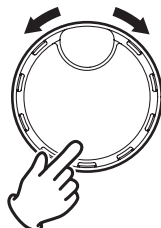
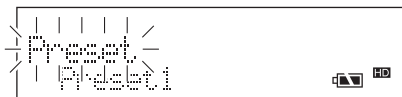

- 3 Turn the **JOG** to select the preset number that you wish to set, and press the **JOG**.

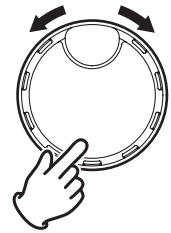

- 4 Turn the **JOG** to select "SilentSkp" and press the **JOG**.

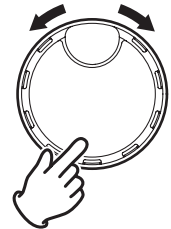
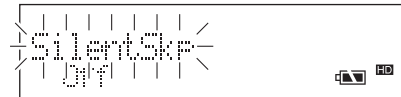

- 5 Turn the **JOG**, and select "On" to set silent skip, "T/ON" to set silent skip/track increment, or "Off" if you do not wish to set either. After making your selection, press the **JOG**.

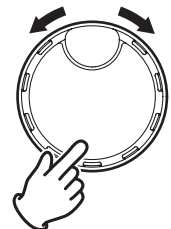

| | |
|--------|-------------------|
| On | Silent Skip |
| T / ON | Silent Skip Track |
| Off | Off |

- 6 If you activate this function, turn the **JOG** to select the no signal status judgment level (-60 to -20dB: 5dB steps) and press the **JOG**.

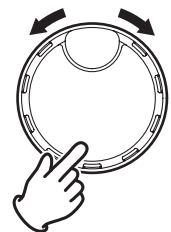

- 7** If you activate this function, turn the **JOG** to select the no signal status judgment time (1 to 5 seconds) and press the **JOG**.

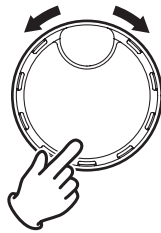

- 8** Press the **MENU/STORE** button to register the settings.



- 3** Turn the **JOG** to select the preset number that you wish to set, and press the **JOG**.

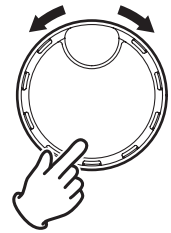
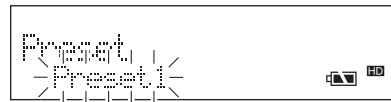

- 4** Turn the **JOG** to select "ManTrack" and press the **JOG**.

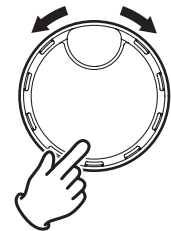
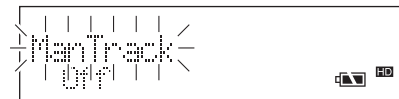

Manual track

Set the manual track.

If the manual track is set to On, press the **REC** button during recording to record as a new track at the point when the button was pressed.

This function can be used to create new tracks whenever desired, making it easier to search for tracks during playback. When manual track is set to On, the "M.TRACK" icon lights in the display.

< Default value > Preset1 : On
 Preset2 : On
 Preset3 : On

- 1** While the recorder is stopped, press the **MENU/STORE** button.



- 2** Turn the **JOG** to select "Preset" and press the **JOG**.

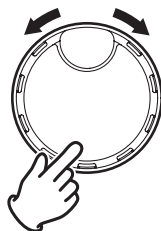
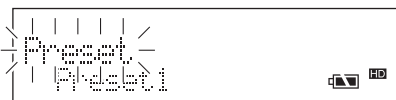

- 5** Turn the **JOG** to select function On/Off, and press the **JOG**.

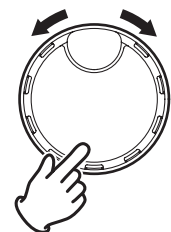

- 6** Press the **MENU/STORE** button to register the settings.



Auto track

Set auto track.

When auto track is set to On, new tracks are automatically created and recorded at the set time interval.

Auto track can be set to increase the number of tracks every 1, 5, 10, 15, 30 minutes, or every 1, 2, 6, 8, 12, 24 hours, or every 640 Mbytes or 700 Mbytes.

By using this function, it is easy to search recorded contents for specific points.

For example, if the Auto Track function is set to "every 1 minute", the track number is updated every 1 minute. When playing back the recorded data, you can play back approximately the 3rd minute of the recording data by choosing track 4. To listen directly to the 10th minute of the recorded data, the search can be performed easily by selecting track 11.

(To search and listen from a certain number of minutes after the start, specify the track number $n+1$.)

Also, when burning from the HD to a CD-R, you can also divide the tracks by the capacity of one CD-R disc (640Mbyte or 700Mbyte).

When auto track is set to On, the "A.TRACK" icon lights in the display.

Notes

- When both auto track and manual track are set to On at the same time, if many tracks are created using manual track, the relationship between track number and time will not be consistent.
- If background recording is set to On and a No is chosen when recording is restarted, the data recorded by background is erased and a new track is created.

The auto track setting time is also reset and a new count is started.

< Default value > Preset1 : Off / Time : 5 min
Preset2 : On / Time : 5 min
Preset3 : Off / Time : 5 min

- 1 While the recorder is stopped, press the **MENU/STORE** button.



- 2 Turn the **JOG** to select "Preset" and press the **JOG**.

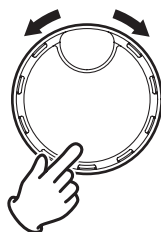
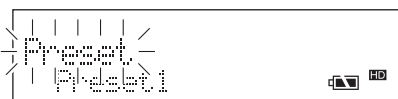

- 3 Turn the **JOG** to select the preset number that you wish to set, and press the **JOG**.

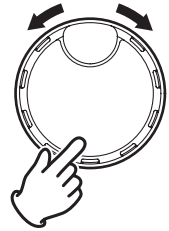

- 4 Turn the **JOG** to select "Auto TRK" and press the **JOG**.

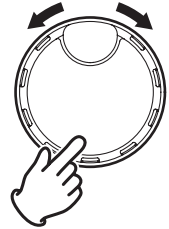
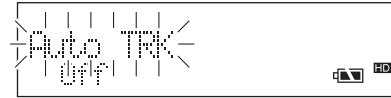

- 5 Turn the **JOG** to select function On/Off, and press the **JOG**.

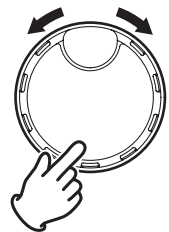

- 6 When this function is activated, turn the **JOG** to select the auto track time (every 1, 5, 10, 15, 30 minutes, or every 1, 2, 6, 12, 24 hours, or every 640Mbyte, 700Mbyte), and press the **JOG**.

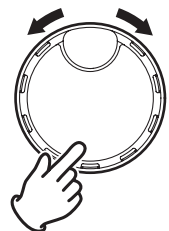

- 7 Press the **MENU/STORE** button to register the settings.



CD Burning

You can easily burn all of the data recorded on the HD onto a CD-R with this recorder. You cannot specify particular data on the HD for burning onto a CD-R. After burning onto the CD-R, all of the data is erased from the HD.

Notes

- Do not attempt to playback or burn a CD while the recorder is on a slant, standing on its edge, or on an unstable surface.
- Do not move or carry the recorder while a CD is inserted and operating. Doing so may cause damage to the inserted CD.

1 Insert a CD-R disc into the recorder's CD slot.

Notes

- Use CD-R discs that are compatible with the recorder. (P. XX)
- Also, if all of the data will not fit onto one CD-R disc, the recording method for the final track can be set in [CD Split] in the preset menu. (P. XX)

2 While the recorder is stopped, press the **MAKE CD** button.

- A confirmation message to perform CD burning is displayed.

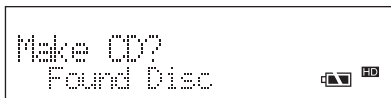

3 Press the **MAKE CD** button again to start burning all of the HD data onto a CD-R.

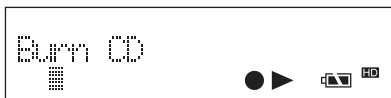

- The progress status is shown in the lower character display section. The display is a 10-figure display, with one figure representing 10%.
- Press the **CANCEL** button to cancel CD creation.

4 When CD burning is completed, the CD-R disc is automatically ejected from the CD slot.

If all of the HD data did not fit onto 1 CD-R disc, "Insert CD" message is displayed.



(Displayed when 2 discs are required)

5 To continue recording the remaining HD data to CD-R, insert the seconds CD-R disc into the recorder.

- When the CD-R disc is inserted, the recorder starts burning HD data to the CD-R again.

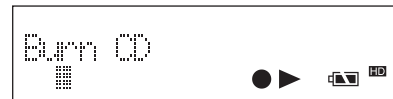

- When CD burning is completed, "Complete" is displayed for 3 seconds, and the CD-R disc is automatically ejected from the CD slot.



- When CD creation is fully completed, "MoreCopy?" is displayed.



If you select No when "MoreCopy?" is displayed, the display switches to "FORMAT HD".

If you wish to format the HD, select YES.

If you wish to create another CD, select No. The display returns to "MoreCopy?".



- 6** To burn the data again onto a different CD-R disc, turn the **JOG** to select “Yes”, and press the **JOG**.
If you have finished burning to CD-R, select “No” and press the **JOG**.

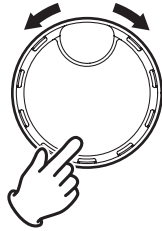

- If you selected “Yes”, CD creation starts again.
- If you selected “No”, all of the HD data is erased. After all of the HD data is erased, “HD Clear” is displayed for 3 seconds, after which the display returns to the default display.



Notes

If an error occurs during CD creation, “Write_Err” is displayed in the lower section, and the CD-R disc is automatically ejected from the CD slot.
If a new CD-R disc is inserted, the recorder automatically starts CD creation again.

CD Split

When copying the HD data to CD-R disc, the recording method for the final track when all of the data will not fit onto 1 CD is set in the CD Split function.

• CD Split On Setting

This setting uses all of the unused space on a CD-R disc to save data.

This enables the effective use of disc space, and reduces the number of discs required. Also, when creating a CD with data from a meeting, etc., a 30 second overlap of the beginning and end contents is burned to make it easier to understand the context.

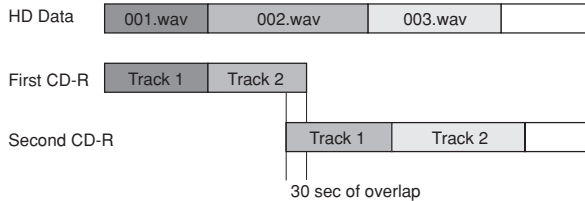

If track 001 and only part of track 002 can be saved to the first CD-R as shown in the diagram above, track 001 and part of track 002 are saved to the first disc. Then, the remainder of track 002 that could not be saved onto the first disc is saved onto the second disc, starting 30 seconds before the track cut off on the first disc.

• CD Split Off Setting

The final track that could not fit onto the first CD-R is not saved to the first CD-R, but is saved from the beginning of the track onto the second CD-R.

Unused space remains on the disc, but it is easier to play back these tracks because only complete tracks exist on the same disc.

If a track with a file size larger than the capacity of the disc is being burned to disc, CD Split Off becomes invalid, and the track is cut midway.

If the file size of the next track is small, CD Split Off becomes valid again.

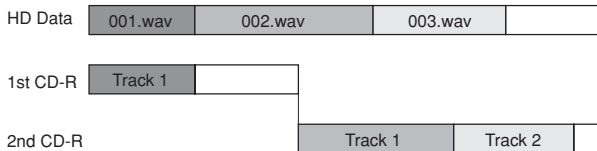

If only track 001 and part of track 002 can be saved onto the first CD-R as shown in the diagram above, track 001 is saved onto the first CD-R, and track 002 is saved from the start onto the second CD-R.

It is convenient to use auto track. (P. XX)

Creating tracks with the desired time interval increases the efficiency with which discs are used.

If you do not wish to create many tracks, you can create a disc with one CD-sized track by setting the capacity of the disc being used.

< Default value > Preset1 : On
Preset2 : On
Preset3 : On

- 1 While the recorder is stopped, press the **MENU/STORE** button.



- 2 Turn the **JOG** to select "Preset" and press the **JOG**.

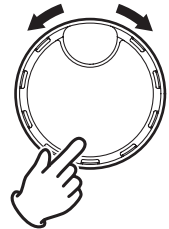

- 3 Turn the **JOG** to select the preset number that you wish to set, and press the **JOG**.

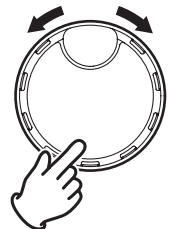

- 4 Turn the **JOG** to select "CD Split" and press the **JOG**.

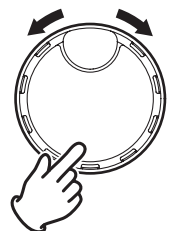
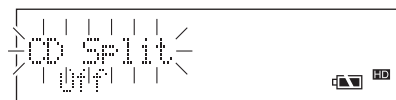

- 5 Turn the **JOG** to select function On/Off, and press the **JOG**.

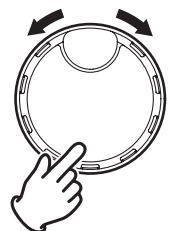
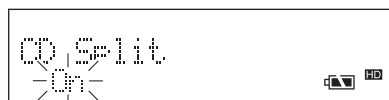

- 6 Press the **MENU/STORE** button to register the settings.



Playing Back HD Data

Schematics

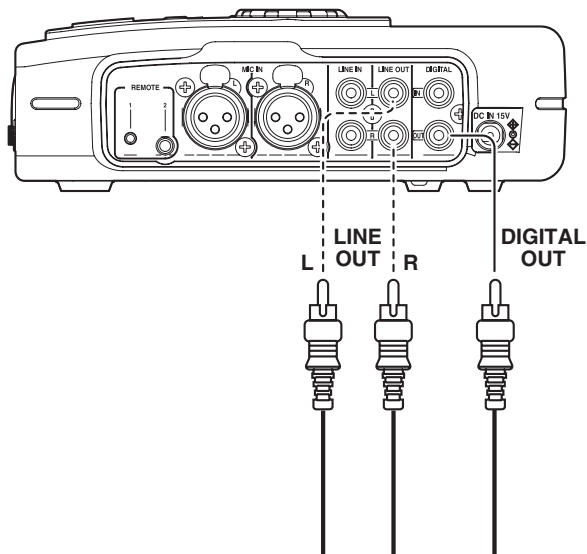

Basic operations for playback

- 1 Press the **PLAY/PAUSE** button while the recorder is stopped to play back.
 - The following information is displayed during playback.



- 2 During playback, press the **PLAY/PAUSE** button to pause playback.



- 3 Press the **STOP** button to stop playback.
 - This display shows the stopped status of playback. If you press the **PLAY/PAUSE** button again, the stopped track starts playback again from the beginning of the track.

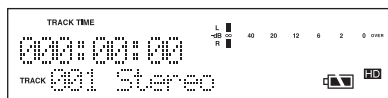

- 4 Press the **STOP** button again to return to the stopped status.
 - Press the **PLAY/PAUSE** button to play back from the first track.

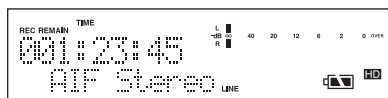

Track access

You can select the track that you wish to play back while the recorder is stopped, during playback, or while playback is paused.

- 1 Turn the **JOG** to display track selection while the recorder is stopped, during playback, or while playback is paused.

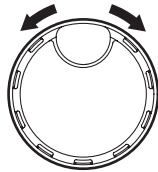

- 2 Select the track that you wish to play back, and press either the **JOG** or the **PLAY/PAUSE** button to play back the track.

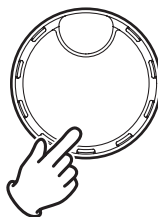
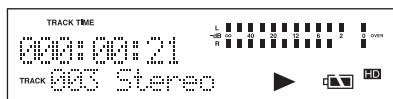

Search

[Fast forward]

- 1 You can search at high speed in the forward direction by holding down the **▶▶** button while playback is paused or stopped. The search starts from the beginning of the first track while playback is stopped. The first 3 seconds of the forward search are performed at 10 times speed, after which the speed automatically increases to 140 times speed. When you release the button, the recorder returns to playback paused.

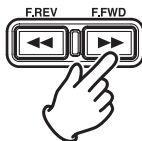

Notes

If the end of the track is passed with **▶▶** button still held down, search moves to the next track and continues searching in the forward direction.

[Fast reverse]

- 1 You can search at high speed in the reverse direction by holding down the **◀◀** button while playback is paused or stopped. The search starts from the end of the final track while playback is stopped. The first 3 seconds of the reverse search are performed at 10 times speed, after which the speed automatically increases to 140 times speed. When you release the button, the recorder returns to playback paused.

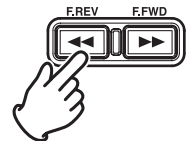

Notes

If the start of the track is passed with **◀◀** button still held down, search moves to the previous track and continues searching in the reverse direction.

Audible search

[Fast forward]

- 1 You can search audio at 2 times speed in the forward direction while listening to the audio by holding down the **▶▶** button during playback. Release the button to return to normal forward direction playback.

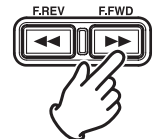

[Fast reverse]

- 1 You can search audio at 2 times speed in the reverse direction while listening to the audio by holding down the **◀◀** button during playback. Release the button to return to normal forward direction playback.

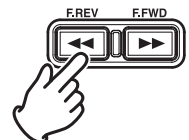

Playback mode settings

You can select the playback mode from the following 4 modes.

| Mode | Mode explanation |
|--------------|---------------------------------------------------------------------------------------------------------|
| Normal | Play back the tracks in numerical order, and playback stops when the final track playback is completed. |
| Repeat All | Repeat playback of all tracks. |
| Repeat Track | Repeat playback of selected tracks only. |
| Single | After completing playback of the tracks, playback is paused at the start of the next track. |

< Default value > Preset1 : Normal
 Preset2 : Normal
 Preset3 : Normal

1 While the recorder is stopped, press the **MENU/STORE** button.



2 Turn the **JOG** to select "Preset" and press the **JOG**.

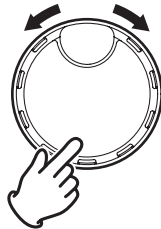
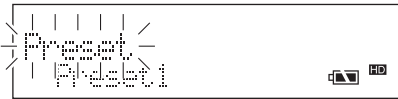

3 Turn the **JOG** to select the preset number that you wish to set, and press the **JOG**.

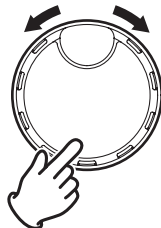

4 Turn the **JOG** to select "Play Mode" and press the **JOG**.

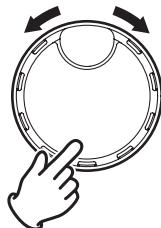
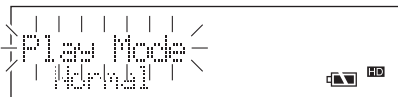

5 Turn the **JOG** to select the playback mode and press the **JOG**.

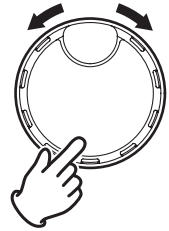

6 Press the **MENU/STORE** button to register the settings.



Playing Back CDs

Schematics

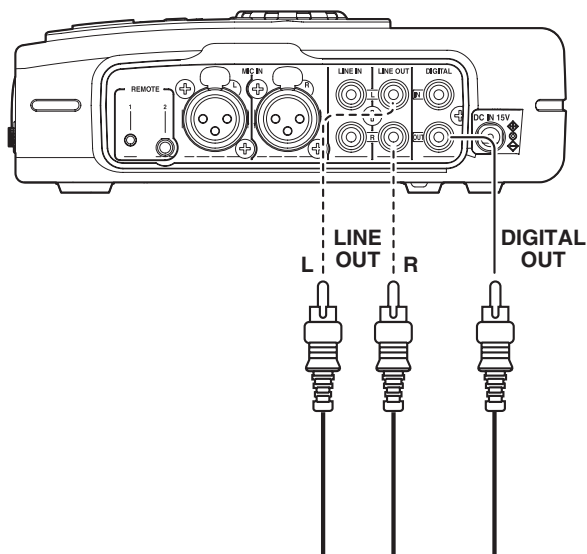

CD Playback

Pay attention to the following points when playing back a CD that was not created on the recorder.

- Data discs recorded in MP3, WAVE, and AIFF format may contain a number of hierarchies (directory folders). In this case, the tracks are played back in a decided order because the recorder does not have an album (directory) selection function.
- As the recorder does not have a file name display function, only the track number starting from track 1 is displayed in the display.
- Maximum number of hierarchies that can be played back : 8
- Maximum number of displayable file : 999

You can playback a CD using the same playback mode as HD playback. (☞ P.XX)

Notes

- Do not attempt to playback or burn a CD while the recorder is on a slant, standing on its edge, or on an unstable surface.
- Do not move or carry the recorder while a CD is inserted and operating. Doing so may cause damage to the inserted CD.

Basic operations for playback

- 1 While the recorder is stopped, press the **HD/CD** button to switch to CD playback mode.



- 2 Insert a CD into the recorder's CD slot.
- 3 Press the **PLAY/PAUSE** button while the recorder is stopped to restart playback.
 - The following information is displayed during playback.

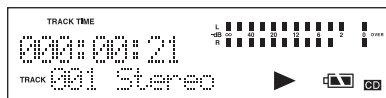

- 4 Press the **PLAY/PAUSE** button to pause playback.



- 5 Press the **STOP** button to stop playback.
 - This display shows the stopped status of playback. If you press the **PLAY/PAUSE** button again, the stopped track starts playback again from the beginning of the track.



- 6 Press the **STOP** button once again to return to the stopped status.
 - In this state, press the **PLAY/PAUSE** button to play back from the first track.

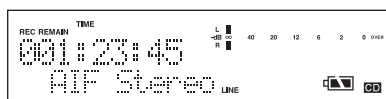

- 7 Press the **EJECT** button to eject the CD.

[Various CD playback operations]

When playing back a CD, you can perform the following various operations just as when playing back HD data.

- Track access (☞ P.XX)
- Search (☞ P.XX)
- Audible search (☞ P.XX)
- Playback mode settings (☞ P.XX)

Other Functions

Auto power off settings

If there are no operations for the set amount of time while the recorder is stopped or playback is paused, the power is automatically turned off.

Before the power turned off, the beep sound can be heard for xx seconds through the speakers or headphones.

This function is used to conserve battery power.

< Default value > Off / 15 min

- 1 While the recorder is stopped, press the **MENU/STORE** button.



- 2 Turn the **JOG** to select "A.Pow Off" and press the **JOG**.

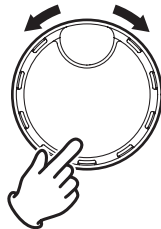
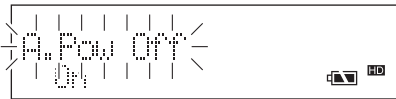

- 3 Turn the **JOG** to select function On/Off, and press the **JOG**.

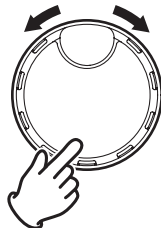

- 4 If this function is activated turn the **JOG** to select the automatic power off (5, 10, 15, 30 minutes) and press the **JOG**.

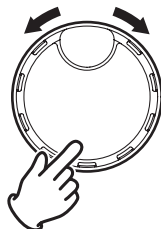

- 5 Press the **MENU/STORE** button to register the settings.



Beep sound (alarm) setting

If there are no operations performed for the set amount of time for auto power off while the recorder is stopped or playback is paused, the beep sound can be heard.

The beep sound can be heard through the speakers or headphones.

The beep sound that occurs when the remaining battery power is low can be heard through the headphones even if the recorder volume is set to minimum.

< Default value > On

- 1 While the recorder is stopped, press the **MENU/STORE** button.



- 2 Turn the **JOG** to select "Beep" and press the **JOG**.

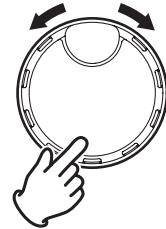
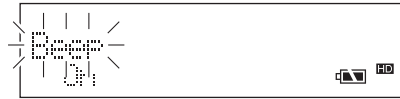

- 3 Turn the **JOG** to select function On/Off, and press the **JOG**.

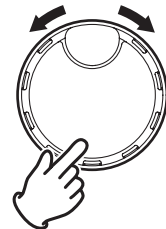

- 4 Press the **MENU/STORE** button to register the settings.



Switching the display mode

Depending on the status of the recorder, you can switch the information in the display by pressing the **DISPLAY** button.

[When the HD is stopped]

Remaining recordable time on the HD
(Default display)



Total number of tracks



Recorded track information



Current time



Remaining recordable time on the HD
(Return to the default display)

[When CD is stopped]

CD total time and total number of tracks
(Default display)



Current time



CD total time and total number of tracks
(Return to the default display)

[When in HD recording or recording paused status]

Recording elapsed time of current track
(Default display)

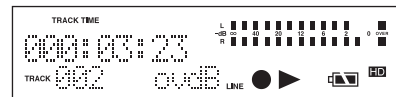

Remaining recordable time on the HD

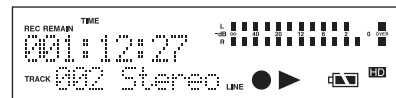

Recording format of recorded track

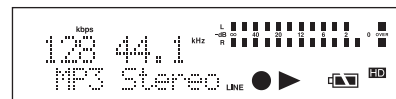

Recording date and time information

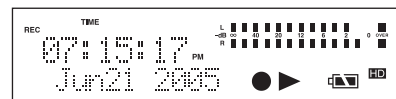

Recording elapsed time
(Return to the default display)

[When in HD/CD playback or playback paused status]

The following display screens are for HD playback.

Playback elapsed time for the track currently being played back
(Default display)

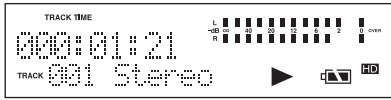

Level margin display

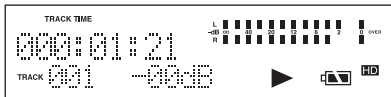

Remaining playback time for track currently being played back



Recording format of the track being played back

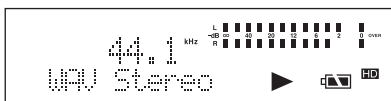

Recording date and time information

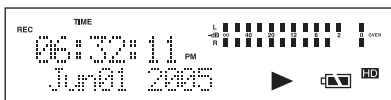

Playback elapsed time for the track currently being played back
(Return to the default display)

The following display screens are for CD playback.

Playback elapsed time for the track currently being played back
(Default display)

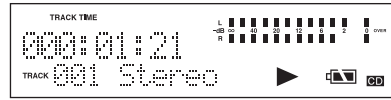

Level margin display

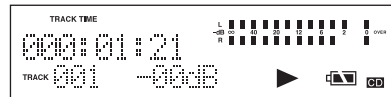

Remaining playback time for track currently being played back



Remaining playback time for all tracks

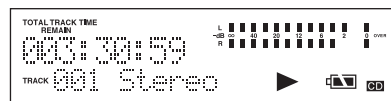

Recording format of the track being played back

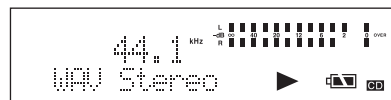

Recording date and time information

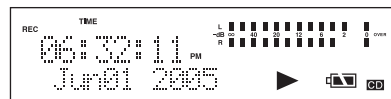

Playback elapsed time for the track currently being played back
(Return to the default display)

Stop Monitor settings

This function constantly monitors the input signal from the selected input source while the recorder is stopped.

When the Stop Monitor function is set to On, the level and level margin of the currently connected input signal is displayed in the display. Furthermore, audio is output to the line out jack, speakers, or headphones.

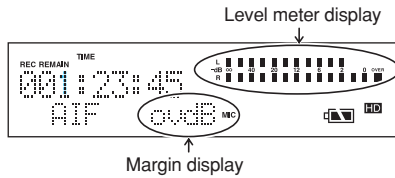

< Default value > Preset1 : Off
 Preset2 : Off
 Preset3 : Off

- 1 While the recorder is stopped, press the **MENU/STORE** button.



- 2 Turn the **JOG** to select "Preset" and press the **JOG**.

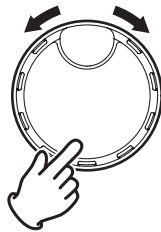
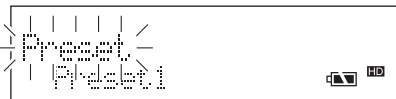

- 3 Turn the **JOG** to select the preset number that you wish to set, and press the **JOG**.

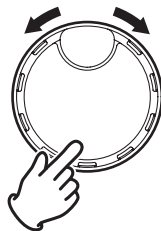

- 4 Turn the **JOG** to select "StopMonit" and press the **JOG**.

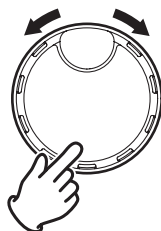
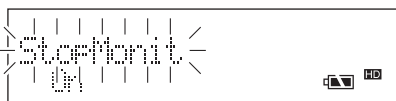

- 5 Turn the **JOG** to select function On/Off, and press the **JOG**.

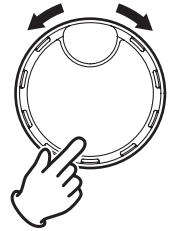

- 6 Press the **MENU/STORE** button to register the settings.



Key lock settings

When the **KEYLOCK** switch is switched ON, all of the operating buttons and switches are locked, except for the **LIGHT** button.

- 1 Set the **KEYLOCK** switch to ON while the recorder is stopped, paused, recording, or playing back to engage the key lock.

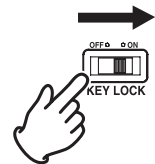

- If any of the buttons (except for the **LIGHT** button) are operated while key lock is engaged, the display shows "KEY LOCKED".

- 2 Return the **KEYLOCK** switch to OFF to disengage the key lock.

Various remote functions

1. Using a contact remote (contact closure) and setting the operating mode

Set the operating mode for the switch contact connected to the REMOTE1 jack.

There are the following 3 operating modes for when the switch contact is opened and closed.

Wiring diagram of switch contact device

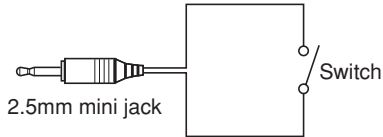

- Start / pause mode (StartPause)
Open / Close : Playback or recording starts.
Close / Open : Playback or recording pauses.
- Start / pause + track increment mode (StartPauTR)
Open / Close : Playback or recording starts.
Close / Open : Playback or recording pauses.
Creates a new track during recording.
- Manual track mode (Manual TRK)
Open / Close : Creates a new track.
Close / Open : No operation.

< Default value > Preset1 : Manual TRK
Preset2 : StartPauTR
Preset3 : StartPause

1 While the recorder is stopped, press the **MENU/STORE** button.



2 Turn the **JOG** to select "Preset" and press the **JOG**.

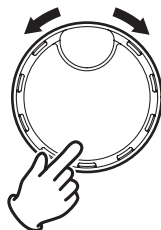
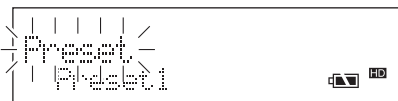

3 Turn the **JOG** to select the preset number that you wish to set, and press the **JOG**.

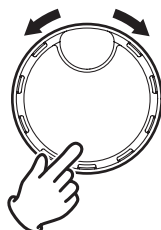

4 Turn the **JOG** to select "Remote" and press the **JOG**.

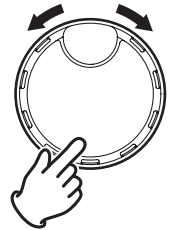
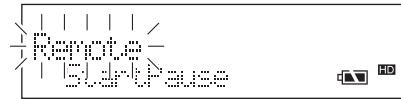

5 Turn the **JOG** to select the switch contact operating mode, and press the **JOG**.

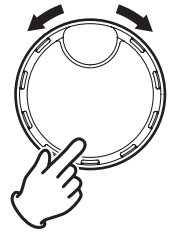

6 Press the **MENU/STORE** button to register the settings.



2. Microphone remote connection

Optional jack for the microphone remote RC600PMD (sold separately). The RC600PMD is a small unit that can be attached to the microphone.

As the recorder can be controlled by hand while holding the microphone, this is a very useful device in situations such as recording interviews, etc.

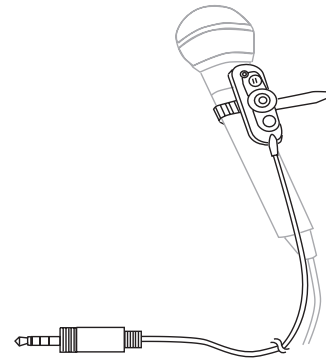

- Microphone remote RC600PMD has 3 buttons, REC, REC PAUSE, and MARK, which perform the same functions as the buttons on the recorder. However, as the CDR310 does not have a marking function, the MARK button cannot be used.
- The microphone remote has 1 LED that serves as the REC indicator and peak indicator.

(REC indicator)

Lights red during recording, and flashes red while recording is paused.

(Peak indicator)

Lights orange when the source level becomes the same level as [OVER] on the level meter during recording or recording pause.

However, it lights green when in standby (statuses other than recording and recording pause). Orange (peak) takes precedence over red in the display.

Margin display

For this reason, a precise clip margin (amount of margin from the current source level at 0dB) is displayed in -dB. The value is held in the same way as for peak hold. Press the **CANCEL** button to reset it.

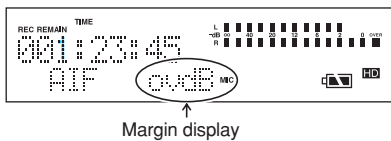

CD-TEXT, ID3 tag

There is no text display function on the recorder. However, the Time/Date stamp (the recording start date and time for a certain file) information can be recorded as text information. This is so file recording information can be seen on a regular CD player. The information is recorded in the title areas for both, as CD text for CD-DA, and as an ID3 tag for MP3. These text displays can be displayed on CD players that support these text displays.

Initialization of preset settings

Returns the settings of the selected preset number to default.

- 1 While the recorder is stopped, press the **MENU/STORE** button.



- 2 Turn the **JOG** to select "Preset" and press the **JOG**.

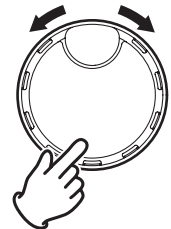

- 3 Turn the **JOG** to select the preset number that you wish to set, and press the **JOG**.

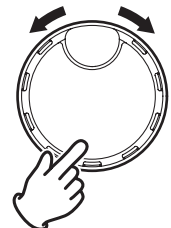

- 4 Turn the **JOG** to select "Default" and press the **JOG**.

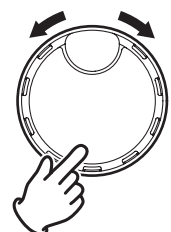
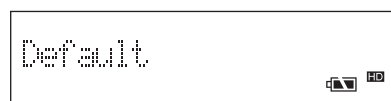

- At this time, a default process confirmation screen is displayed. Press the **JOG** to perform the process.

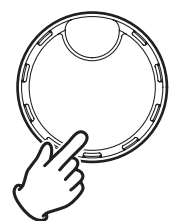
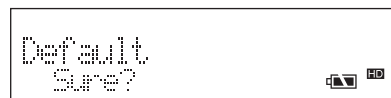

- After default processing, "Completed" is displayed for 1 second, and the settings only for the selected preset number are returned to the default values. After that, the recorder returns to the stopped status.

Troubleshooting

If you think a malfunction has occurred, there may be no need to contact the dealer or the repair service counter. Please check the following points. You can easily solve many problems without needing to ask for professional help. If the problem cannot be solved even after performing these checks, contact your dealer.

Recorder power will not turn on.

- Insert new batteries.
- If you are using rechargeable batteries, recharge the batteries.
- Check the connection of the AC adaptor.

The recorder power turns itself off after it is turned on.

- Insert new batteries.

There is no sound from the internal speakers.

- Check the LEVEL volume setting on the front side of the recorder.
- Check the ON/OFF position of the speaker switch on the front side of the recorder.

Cannot record

- Check that the input source settings are correct.
- Check to see if the maximum number of tracks, 999 tracks, have been recorded.
- Check that there is enough recording time remaining on the HD.

There is no signal from the microphone input.

- Check the input source settings. (P.XX)
- Check the recording level settings. (P.XX)
- Check if the microphone requires Phantom power. (P.XX)

Cannot change recording format.

- There is only one HD recording format. If tracks already recorded in a certain format already exist, the format cannot be changed. CD, or format the HD.

Too much noise

- Check the cable connection between each device. Replace the cable if required.
- Check that the recording level is suitable.

Care and maintenance

Dip a soft cloth into water mixed with a small amount of neutral detergent, wring out the cloth, and gently wipe the recorder.

Error Messages

| | Display | Description |
|------------------|------------|----------------------------------------------------------------------------------------------------------|
| Error messages | Full_HD | There is no space remaining on the HD. |
| | Full_999 | The track number on the HD has reached the maximum number, track 999. |
| | No Track | No track files detected. |
| | No Disc | No disc in the CD slot. |
| | Blank Disc | No files detected on the CD. |
| | Unlocked | Cannot synchronize the signal because the sampling frequency of the digital input signal is not 44.1kHz. |
| | Write_Err | Write to the HD or CD-R failed. |
| | Read_Err | Read from the HD or CD-R failed. |
| | Format_Err | Formatting failed. |
| | Err_MPU | MPU error detected. |
| | Err_HD | HD error detected. |
| | Err_CDR | CD-R drive error detected. |
| | Err_RTC | Real Time Clock error detected. |
| | Err_EEPROM | EEPROM error detected. |
| | Err_SRAM | SRAM error detected. |
| Warning messages | LowBattery | Battery voltage is low. |
| | Not Blank | There is no writable CD-R disc in the CD-R slot. |
| | KEY LOCKED | Key Lock is engaged. |
| System messages | ALC On | The recording level control is set by ALC. |

Specifications

Digital audio system

| | |
|-----------------------------------------------------------|----------------------------------------------------|
| System | HD recorder |
| Recording media | 1-inch 4G HD |
| Writing CD media | CD-R |
| Recording format | |
| MP3 (.mp3) | MPEG1 layer 3 compression |
| WAV (.wav) | 16-bit linear PCM, WAVE file format |
| AIFF (.aif) | 16bit linear PCM, Audio Interchange File format |
| CD (.cda) | 16bit linear PCM, CD audio file format |
| Recording bit rate | |
| MP3 | 128 kbps (mono : 64 kbps) |
| WAV | 1412 kbps (mono : 705.5 kbps) |
| AIFF | 1412 kbps (mono : 705.5 kbps) |
| CD | 1412 kbps (mono : 705.5 kbps) |
| Sampling frequency | 44.1 kHz |
| Channel | 2 (stereo), 1 (mono) |
| Frequency characteristics | 16,000 Hz (-0.5dB) |
| S/N ratio | |
| IEC-A load | LINE 80 dB MIC 60 dB |
| Overall height harmonic distortion by 0 VU (wav) | LINE 0.06% MIC 0.06% |
| Dynamic range | 80 dB |

Input

| | |
|-----------------------------------|----------------------------|
| MIC IN L/R | |
| Type | XLR (1:GND, 2:HOT, 3:COLD) |
| Input sensitivity (MIC) | 1.0 mVrms/6.5 kohms |
| LINE IN | |
| Type | RCA terminal |
| Input sensitivity | 500 mVrms/20 kohms |
| DIGITAL IN | |
| Type | RCA terminal |
| Input impedance | 75 ohms |
| Standard input/output level | 0.5Vp-p |
| Sampling frequency | 44.1 kHz |
| Format | SPDIF |

Output

| | |
|-----------------------------------|---------------------|
| LINE OUT L/R | |
| Type | RCA terminal |
| Standard level | 2 Vrms max./2 kohms |
| DIGITAL OUT | |
| Type | RCA terminal |
| Output impedance | 75 ohms |
| Standard input/output level | 0.5Vp-p |
| Sampling frequency | 44.1 kHz |
| Format | SPDIF |

General

| | |
|------------------------|--------------------------|
| Headphone output | 8 mW/ 32 ohms |
| Speaker output | 150 mW/ 8 ohms |
| Phantom power | + 48V, 5mA |
| Power consumption | |
| Recording | 5.0 W(DC) |
| Playback | 5.0 W(DC) |
| Battery lifespan | 4 hours (standard value) |
| Dimensions | |
| Width | 113 mm |
| Height | 47 mm |
| Length | 183.5 mm |
| Weight..... | 0.5 kg |

Provided accessories

| | |
|-------------------------|---|
| AC adaptor | 1 |
| AA battery holder | 1 |
| User's guide | 1 |

Accessories sold separately**

(Please refer to <http://www.d-mpro.com/> for descriptions and ordering information.)

| | |
|----------------------------|----------|
| Wired remote control | RC600PMD |
|----------------------------|----------|

* Specifications are subject to change without prior notice.

LIMITED WARRANTY

Your Marantz Professional product is warranted against manufacturer defects in material and workmanship for a period of one year parts and labor.

Except as specified below, this warranty covers defects in material and workmanship. The following are not covered under warranty:

1. Damage, deterioration, malfunction or failure to meet performance specifications resulting from:
 - a) Accidents, acts of nature, misuse, abuse, neglect or unauthorized product modification.
 - b) Improper installation, removal or maintenance, or failure to follow supplied instructions.
 - c) Repair or attempted repair by a non-Marantz authorized agent.
 - d) Any shipment (claims must be presented to the carrier).
 - e) Any cause other than a defect of manufacturing.
2. Cleaning, check-ups with no fault found or changes incurred for installation, removal or reinstallation of the product.
3. Any serialized product on which the serial number has been defaced, modified or removed.
4. Batteries and battery chargers.
5. Accessories, including but not limited to: cables, mounting hardware and brackets, cleaning accessories, power cords and adapters, and carry cases.

Non-transferable warranty

This Warranty may be enforced only by the original purchaser.

What We Will Pay For

We will pay for all labor and material expenses for items covered by the warranty.

How You Can Get Service (Americas only)

1. If your unit needs service in the USA, contact our service referral at the appropriate telephone number indicated below. We will advise you of the name and location of one or more authorized service centers from which service may be obtained. Please do not return the unit directly to us.
2. You must pay any shipping charges if it is necessary to ship the product for service. If the necessary repairs are covered by the warranty, we will pay return shipping charges to your location anywhere in the United States or its territories.
3. Whenever warranty service is required, you must present the original dated sales receipt or other proof of date purchased.

Limitation of Implied Warranties

All implied warranties, including warranties of merchantability and fitness for a particular purpose, are limited in duration to the length of this warranty.

Exclusion of Damages (Americas only)

Liability for any defective product is limited to repair or replacement of the product at manufacturer's option. Manufacturer shall not be liable for damage to other products caused by any defects in Marantz products, damages based on inconvenience or loss of use of the product, or any other damages, whether incidental, consequential, or otherwise.

Some States do not allow limitations on how long an implied warranty lasts and/or do not allow the exclusion or limitation of incidental or consequential damages, so the above limitations and exclusions may not apply to you.

How State Law Relates to the Warranty (Americas only)

This warranty gives you specific legal rights, and you may have other rights which may vary from State to State.

Marantz Professional Service Number (Americas only):

Marantz Professional Factory Service (630) 741-0330, toll free within the US (866) 405-2154.

Products purchased outside of the United States, its possessions or territories.

This warranty is enforceable only in the United States and its possessions or territories.

Marantz Professional products Sales Office Site:

For inquiries or information on repair service of Marantz Professional Products, please contact our Sales Office or Tech Support Centre near you which are listed in D&M Professional website below.

AMERICA

D&M Professional America <http://www.d-mpro.com>
Service number : 866-405-2154 (Toll Free)

EUROPE

D&M Professional Europe <http://www.d-mpro.eu.com>

ASIA / OTHERS

Marantz Korea Co.,Ltd. <http://www.marantz.co.kr>
DENON Asia Co.,Ltd. <http://www.denon.com.hk>
D&M Electronics Singapore Pte. Ltd. <http://www.denonsingapore.com>

D&M Holdings Inc.
PROFESSIONAL BUSINESS COMPANY



Free Manuals Download Website

<http://myh66.com>

<http://usermanuals.us>

<http://www.somanuals.com>

<http://www.4manuals.cc>

<http://www.manual-lib.com>

<http://www.404manual.com>

<http://www.luxmanual.com>

<http://aubethermostatmanual.com>

Golf course search by state

<http://golfingnear.com>

Email search by domain

<http://emailbydomain.com>

Auto manuals search

<http://auto.somanuals.com>

TV manuals search

<http://tv.somanuals.com>