

# marantz®

## Model VP-12S4 User Guide

DLP™ Projector

ENGLISH



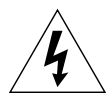

The lightning flash with arrowhead symbol within an equilateral triangle is intended to alert the user to the presence of uninsulated "dangerous voltage" within the product's enclosure that may be of sufficient magnitude to constitute a risk of electric shock to persons.



The exclamation point within an equilateral triangle is intended to alert the user to the presence of important operating and maintenance (servicing) instructions in the literature accompanying the product.

## WARNING

**TO REDUCE THE RISK OF FIRE OR ELECTRIC SHOCK,  
DO NOT EXPOSE THIS PRODUCT TO RAIN OR MOISTURE.**

**CAUTION: TO PREVENT ELECTRIC SHOCK, MATCH WIDE BLADE OF  
PLUG TO WIDE SLOT, FULLY INSERT.**

**ATTENTION: POUR ÉVITER LES CHOC ÉLECTRIQUES, INTRODUIRE  
LA LAME LA PLUS LARGE DE LA FICHE DANS LA BORNE  
CORRESPONDANTE DE LA PRISE ET POUSSER JUSQU'AU FOND.**

### NOTE:

This equipment has been tested and found to comply with the limits for a Class B digital device, pursuant to Part 15 of the FCC Rules. These limits are designed to provide reasonable protection against harmful interference in a residential installation. This equipment generates, uses and can radiate radio frequency energy and, if not installed and used in accordance with the instructions, may cause harmful interference to radio communications. However, there is no guarantee that interference will not occur in a particular installation. If this equipment does cause harmful interference to radio or television reception, which can be determined by tuning the equipment off and on, the user is encouraged to try to correct the interference by one or more of the following measures:

- Reorient or relocate the receiving antenna.
- Increase the separation between the equipment and receiver.

- Connect the equipment into an outlet on a circuit different from that to which the receiver is connected.

- Consult the dealer or an experienced radio/TV technician for help.

### NOTE:

Changes or modifications not expressly approved by the party responsible for compliance could void the user's authority to operate the equipment.

# IMPORTANT SAFETY INSTRUCTIONS

## READ BEFORE OPERATING EQUIPMENT

This product was designed and manufactured to meet strict quality and safety standards. There are, however, some installation and operation precautions which you should be particularly aware of.

1. Read these instructions.
2. Keep these instructions.
3. Heed all warnings.
4. Follow all instructions.
5. Do not use this apparatus near water.
6. Clean only with dry cloth.
7. Do not block any ventilation openings. Install in accordance with the manufacture's instructions.
8. Do not install near any heat sources such as radiators, heat registers, stoves, or other apparatus (including amplifiers) that produce heat.
9. Do not defeat the safety purpose of the polarized or grounding-type plug. A polarized plug has two blades with one wider than the other. A grounding type plug has two blades and a third grounding prong. The wide blade or the third prong are provided for your safety. If the provided plug does not fit into your outlet, consult an electrician for replacement of the obsolete outlet.
10. Protect the power cord from being walked on or pinched particularly at plugs, convenience receptacles, and the point where they exit from the apparatus.
11. Only use attachments/accessories specified by the manufacturer.
12. Use only with the cart, stand, tripod, bracket, or table specified by the manufacturer, or sold with the apparatus. When a cart is used, use caution when moving the cart/apparatus combination to avoid injury from tip-over.



13. Unplug this apparatus during lightning storms or when unused for long periods of time.
14. Refer all servicing to qualified service personnel. Servicing is required when the apparatus has been damaged in any way, such as power-supply cord or plug is damaged, liquid has been spilled or objects have fallen into the apparatus, the apparatus has been exposed to rain or moisture, does not operate normally, or has been dropped.

### Additional Safety Information!

- This product should not be placed in a built-in installation such as a bookcase or rack unless proper ventilation is provided or the manufacturer's instructions have been adhered to.
- To prevent fire or shock hazard, do not place objects filled with liquids, such as vases, on the apparatus.
- When the switch is in the OFF position, the apparatus isn't completely switched-off from the MAINS.

This Class B digital apparatus complies with Canadian ICES-003.

Cet appareil numérique de la Classe B est conforme à la norme NMB-003 du Canada.

## ENGLISH

### FOREWORD

This section must be read carefully before any connection is made to the mains supply.

### WARRANTY

For warranty information, contact your local Marantz distributor.

### RETAIN YOUR PURCHASE RECEIPT

Your purchase receipt is your permanent record of a valuable purchase. It should be kept in a safe place to be referred to as necessary for insurance purposes or when corresponding with Marantz.

### IMPORTANT

When seeking warranty service, it is the responsibility of the consumer to establish proof and date of purchase. Your purchase receipt or invoice is adequate for such proof.

### FOR U.K. ONLY

This undertaking is in addition to a consumer's statutory rights and does not affect those rights in any way.

### EQUIPMENT MAINS WORKING SETTING

Your Marantz product has been prepared to comply with the household power and safety requirements that exist in your area.

### COPYRIGHT

Recording and playback of some material may require permission. For further information refer to the following:

- Copyright Act 1956
- Dramatic and Musical Performers Act 1958
- Performers Protection Acts 1963 and 1972
- Any subsequent statutory enactments and orders

### WARNINGS

- Do not expose the equipment to rain or moisture.
- Do not remove the cover from the equipment.
- Do not insert anything into the equipment through the ventilation holes.
- Do not handle the mains lead with wet hands.
- Do not cover the ventilation with any items such as tablecloths, newspapers, curtains, etc.
- No naked flame sources, such as lighted candles, should be placed on the equipment.
- When disposing of used batteries, please comply with governmental regulations or environmental public instruction's rules that apply in your country or area.
- Do not place anything about 1 meter above the top panel.
- Make a space of about 0.2 meter around the unit.
- When the projector is mounted on the ceiling, the Ceiling Mount Kit approved by MARANTZ must be used for installation.
- Do not look into the lens when the projector is turned on. It could damage your eyesight.
- Unplug the projector from the wall outlet if it is not to be used for a few days.
- When the switch is in the OFF position, the apparatus is NOT disconnected from the AC supply mains.
- The socket-outlet shall be installed near the equipment and shall be easily accessible.
- No objects filled with liquids, such as vases, shall be placed on the apparatus.

### Lamp Handling Precautions

#### DANGER

This SHP uses a high voltage glass mercury vapor lamp. The lamp can break or fail to light if handled wrongly during replacement or because of the projector's surrounding temperature.

Lamp life also varies according to the lamp with some even breaking or failing to light as soon as they are used the first time. If the lamp breaks, glass fragments may be scattered inside the lamp unit and projector, and gas inside the lamp bulb that contains mercury vapor may be emitted from the projector's vent.

Before use, carefully read the projector user guide and the lamp replacement instructions. Remember to handle the lamp with care. In the event of serious trouble, call for Marantz authorized dealer.

- Do not look directly into the lamp with bare eyes while lit. The bright light can cause sore eyes and impair vision.
- Do not directly expose skin to the light of the lamp. Direct exposure can inflame the skin.
- Do not drop, impact, subject to excessive force or otherwise damage the lamp.
- Replacing the lamp runs the risk of burns and electric shock, therefore shut OFF power supply, unplug the AC power cord from AC power outlet and wait at least 60 minutes for the lamp to cool down before attempting to replace it.
- If the lamp breaks, unplug the AC power cord from AC power outlet and call for Marantz authorized dealer to replace it. Do not replace the lamp yourself or clean up broken glass inside the projector as this can result in cuts and burns to you or damages inside the projector.
- If the projector is hung from a ceiling or installed in a high place, it is extremely dangerous to replace the lamp. In this case, do not replace or handle the damaged lamp yourself.

### CAUTION

- The chance of the lamp breaking is high after extended use. It is recommended to replace the lamp when near the end of its designed life. Do not use a lamp beyond the maximum lighting time.
- Use only Marantz original lamp units. Check the model code of the lamp unit matches that in the user guide.
- Before replacing the lamp, read carefully "Lamp Unit Replacement" in the user guide. Replace the lamp as explained therein.
- Entrust disposal of a used lamp to a licensed industrial waste handler or return it to the place of purchase. Do not break the lamp or discard with general waste.
- If the lamp breaks, leave the area immediately and stay away for at least 30 minutes, and ventilate the room so as not to inhale the mercury vapor.
- If you inhale the mercury vapor, see a physician immediately and follow his instructions.

## FRANÇAIS

### AVANT-PROPOS

Prière de lire ce chapitre avant de brancher l'appareil sur le secteur.

### GARANTIE

Pour des informations sur la garantie, contacter le distributeur local Marantz.

### CONSERVER L'ATTESTATION D'ACHAT

L'attestation d'achat est la preuve permanente d'un achat de valeur. La conserver en lieu sûr pour s'y reporter aux fins d'obtention d'une couverture d'assurance ou dans le cadre de correspondances avec Marantz.

### IMPORTANT

Pour l'obtention d'un service couvert par la garantie, il incombe au client d'établir la preuve de l'achat et d'en corroborer la date. Le reçu ou la facture constituent des preuves suffisantes.

### REGLAGE DE L'ALIMENTATION

#### SECTEUR DE L'APPAREIL

Cet appareil Marantz a été conçu pour respecter les exigences de votre région en matière d'alimentation secteur et de sécurité.

#### DRUITS D'AUTEUR

L'enregistrement et la lecture de certaines informations sonores nécessitent une autorisation. Pour de plus amples renseignements, consultez:

- La loi de 1956 sur les Copyright
- Loi concernant les Acteurs et Musiciens 1958
- Lois de Protection des Artistes 1963 et 1972
- Les décrets et règlements ultérieurs qui s'y rapportent

### AVERTISSEMENTS

- Ne pas exposer l'appareil à la pluie ni à l'humidité.
- Ne pas essayer de retirer le boîtier de l'appareil.
- Ne rien insérer dans l'appareil par les orifices de ventilation.
- Ne pas manipuler le cordon d'alimentation avec les mains mouillées.
- Ne pas recouvrir les ouïes de ventilation avec un objet quelconque comme une nappe, un journal, un rideau, etc.
- Ne placer aucune source de flamme nue, comme une bougie allumée, sur l'appareil.
- Pour mettre au rebut les piles usées, respecter les lois gouvernementales ou les règlements officiels concernant l'environnement qui s'appliquent à votre pays ou région.
- Ne placer aucun objet à moins d'un mètre environ du panneau supérieur.
- Veiller à ce qu'aucun objet ne soit à moins de 0,2 mètre des côtés de l'appareil.
- Pour monter le projecteur au plafond, vous devez utiliser un kit de montage au plafond approuvé par MARANTZ pour l'installation.
- Ne regardez pas dans l'objectif quand le projecteur est allumé. Cela pourrait endommager votre vue.
- Débranchez le projecteur de la prise murale s'il ne doit pas être utilisé pendant plusieurs jours.
- Quand l'interrupteur d'alimentation est sur la position OFF, l'appareil N'EST PAS déconnecté de l'alimentation secteur.
- La prise secteur doit être située près de l'appareil et accessible facilement.
- Aucun objet rempli de liquide, un vase par exemple, ne doit être placé sur l'appareil.

### Précautions à prendre pour la manipulation de la lampe

#### DANGER

Ce SHP utilise une lampe à vapeur de mercure en verre à haute tension. Cette lampe peut se casser ou ne pas s'allumer si elle est manipulée incorrectement pendant son remplacement ou du fait de la température ambiante du projecteur.

La durée de service d'une lampe varie aussi en fonction de la lampe, certaines se cassant ou ne s'allumant pas aussitôt qu'elles sont utilisées pour la première fois. Si la lampe se casse, des fragments de verre peuvent se répandre à l'intérieur de l'unité lampe et du projecteur, et le gaz à l'intérieur de l'ampoule de la lampe qui contient de la vapeur de mercure peut être émis par l'orifice du projecteur.

Avant utilisation, lisez attentivement le guide de l'utilisateur du projecteur et les instructions de remplacement de la lampe. Pensez à manipuler la lampe avec précautions. En cas de problème sérieux, contactez un distributeur agréé Marantz.

- Ne regardez pas directement la lampe sans protection pour les yeux pendant qu'elle est allumée. Sa lumière brillante peut faire mal aux yeux et affaiblir la vue.
- N'exposez pas directement la peau à la lumière de la lampe. Une exposition directe peut provoquer une inflammation de la peau.
- Ne laissez pas tomber la lampe, ne la heurtez pas, ne la soumettez pas à une force excessive ni ne l'endommager.
- Le remplacement de la lampe fait courir un risque de brûlure et de choc électrique ; il faut donc couper l'alimentation électrique, débrancher le cordon d'alimentation secteur de la prise secteur et attendre au moins 60 minutes que la lampe refroidisse avant d'essayer de la remplacer.
- Si la lampe se casse, débranchez le cordon d'alimentation secteur de la prise secteur et contactez un distributeur agréé Marantz pour qu'il la remplace. Ne remplacez pas la lampe vous-même ni ne nettoyez le verre brisé à l'intérieur du projecteur car vous pourriez vous couper et vous brûler ou endommager l'intérieur du projecteur.
- Si le projecteur est accroché au plafond ou installé dans un endroit en hauteur, il est extrêmement dangereux de remplacer la lampe. Dans ce cas, ne remplacez ni ne manipulez vous-même la lampe endommagée.

### ATTENTION

- Le risque que la lampe se casse est élevé après une utilisation prolongée. Il est recommandé de remplacer la lampe lorsqu'elle approche de sa durée de service spécifiée. N'utilisez pas une lampe au-delà du temps d'éclairage maximum.
- N'utilisez que des unités lampes d'origine Marantz. Vérifiez que le code de modèle de l'unité lampe correspond à celui indiqué dans le guide de l'utilisateur.
- Avant de remplacer la lampe, lisez attentivement "Remplacement de l'unité lampe" dans le guide de l'utilisateur. Remplacez la lampe conformément aux explications de cette section.
- Confiez la mise au rebut d'une lampe usée à un service de déchets industriels licencié ou retournez-la où vous l'avez achetée. Ne cassez pas la lampe ni ne la jetez avec les ordures ménagères.
- Si la lampe se casse, sortez immédiatement de la zone pendant au moins 30 minutes, et aérez la pièce afin de ne pas inhaler la vapeur de mercure.
- Si vous inhalez de la vapeur de mercure, consultez immédiatement un médecin et suivez ses instructions.

## PROLOGO

Antes de conectar el equipo a la corriente, debe leer este capítulo.

## GARANTIA

Para obtener información acerca de la garantía póngase en contacto con su distribuidor Marantz.

## GUARDE SU RECIBO DE COMPRA

Su recibo de compra es su prueba permanente de haber adquirido un aparato de valor. Este recibo deberá guardarlo en un lugar seguro y utilizarlo como referencia cuando tenga que hacer uso del seguro o se ponga en contacto con Marantz.

## IMPORTANTE

Cuando solicite el servicio otorgado por la garantía el usuario tiene la responsabilidad de demostrar cuando efectuó la compra. En este caso, su recibo de compra será la prueba apropiada.

## SELECCION DEL VOLTAJE DE

### ALIMENTACION

Este producto Marantz se ha preparado para estar conforme con los requisitos de alimentación eléctrica doméstica y de seguridad que hay en su zona.

## COPYRIGHT

La grabación y reproducción de determinado material puede necesitar permiso. Para más información consulte lo siguiente:

- Acta sobre copyright de 1958
- Acta de la Sociedad General de Autores de 1958
- Acta de Protección de la Propiedad Intelectual de Autores de 1963 y 1972
- Cualquier acta, estatuto y órdenes subsiguientes

## ADVERTENCIAS

- No exponga el equipo a la lluvia ni a la humedad.
- No extraiga la tapa del equipo.
- No introduzca nada en el interior del equipo a través de los orificios de ventilación.
- No maneje el cable de alimentación con las manos mojadas.
- No cubra la ventilación con objetos como manteles, periódicos, cortinas, etc.
- No deben colocarse sobre el equipo elementos con fuego, por ejemplo velas encendidas.
- Cuando se eliminen baterías usadas, deben cumplirse las reglamentaciones oficiales o las normas de protección medioambiental aplicables en su país o en su zona.
- No ponga nada a menos de 1 metro por encima del panel superior.
- Deje un espacio de unos 0,2 metro alrededor de la unidad.
- Cuando el proyector se monte en el techo deberá utilizarse para la instalación el juego de montaje en el techo aprobado por MARANTZ.
- No mire al objetivo cuando el proyector esté encendido. Podría lesionarse la vista.
- Desenchufe el proyector de la toma de corriente si no lo va a utilizar durante unos pocos días.
- Cuando el interruptor esté en la posición OFF, el aparato NO estará desconectado de la fuente de alimentación de CA.
- La toma de corriente deberá estar instalada cerca del equipo y deberá poderse acceder a ella fácilmente.
- No se deben colocar sobre el aparato recipientes que contengan líquidos, como por ejemplo jarrones.

## Precauciones para la manipulación de la lámpara

### PELIGRO

Esta lámpara SHP de vidrio y de alto voltaje contiene vapor de mercurio. La lámpara puede romperse o no encenderse si es manipulada incorrectamente durante el recambio o debido a la temperatura ambiente del proyector.

La vida útil también varía según las lámparas, algunas de las cuales se rompen o no se encienden al cabo del primer uso. Si la lámpara se rompe, los fragmentos de cristal se pueden desparramar por el interior de la unidad de la lámpara y del proyector, y el gas con vapor de mercurio contenido en la bombilla se puede escapar a través del sistema de ventilación del proyector.

Antes de usar el aparato, lea con cuidado la guía de usuario del proyector y las instrucciones de recambio de la lámpara. No olvide manipular con cuidado la lámpara. En caso de producirse problemas serios, avise a un distribuidor autorizado de Marantz.

- No mire directamente a la lámpara sin protección en los ojos cuando ésta esté encendida. La luz brillante puede irritar los ojos e impedir la visión.
- No exponga directamente la piel a la luz de la lámpara. La exposición directa puede inflamar la piel.
- No deje caer la lámpara, ni la golpee, ni la someta a presiones excesivas, ya que de lo contrario la lámpara se daña.
- El recambio de la lámpara entraña el riesgo de quemaduras y descargas eléctricas, y por lo tanto, deberá apagar el aparato, desenchufar el cable de alimentación del tomacorriente de CA, y esperar al menos 60 minutos a que la lámpara se enfríe antes de intentar recambiarla.
- Si la lámpara se rompe, desenchufe el cable de alimentación de CA y avise a un distribuidor autorizado de Marantz para recambiarla. No recambie la lámpara usted mismo ni limpie los cristales rotos en el interior del proyector, pues podría sufrir cortes y quemaduras y ocasionar daños en el interior del proyector.
- Si el proyector cuelga del techo o está instalado en un lugar elevado, el recambio de la lámpara es extremadamente peligroso. En tal caso, no recambie ni manipule usted mismo la lámpara dañada.

## PRECAUCIÓN

- La probabilidad de que la lámpara se rompa es alta después de un uso prolongado. Se recomienda recambiar la lámpara cerca de la fecha de expiración de su vida útil prevista. No utilice una lámpara más tiempo del máximo de iluminación previsto.
- Utilice sólo lámparas originales de Marantz. Compruebe que el código del modelo de la lámpara coincide con el de la guía de usuario.
- Antes de recambiar la lámpara, lea atentamente la sección "Recambio de la lámpara" en la guía de usuario. Recambie la lámpara tal y como viene allí explicado.
- Confíe el desecho de la lámpara usada a un manipulador autorizado de desechos industriales o devuélvala al lugar donde la compró. No rompa la lámpara ni la deseche en la basura normal.
- Si la lámpara se rompe, abandone la zona inmediatamente y permanezca alejado durante al menos 30 minutos, ventilando la habitación con objeto de no inhalar el vapor de mercurio.
- Si inhala vapor de mercurio, consulte inmediatamente a su médico y siga sus instrucciones.

## PORTUGUÊS

### INTRODUÇÃO

Esta secção deverá ser lida antes de efectuar qualquer ligação à corrente.

### GARANTIA

Para informações sobre a garantia, contactar o distribuidor Marantz local.

### GUARDAR O RECIBO DE COMPRA

O recibo é o registo permanente da compra que fez. Deve ser guardado num local seguro, para ser apresentado em questões relacionadas com o seguro ou para quando tiver de contactar a Marantz.

### IMPORTANTE

Quando procurar assistência técnica ao abrigo da garantia, é da responsabilidade do consumidor estabelecer a prova e data de compra. O recibo é prova adequada.

### REGULAÇÃO DO EQUIPAMENTO

#### CONFORME A ALIMENTAÇÃO DA REDE

O seu produto Marantz foi condicionado a satisfazer os requisitos domésticos de energia e segurança existentes na sua zona.

### DIREITOS DE AUTOR

Poderá ser necessária autorização para a gravação e a leitura de determinado material. Para mais informações deverá consultar o seguinte:

- Lei do direito de autor de 1956 (Copyright Act)
- Lei dos artistas relacionados com a música e com o teatro de 1958 (Dramatic and Musical Performers Act)
- Leis de protecção dos artistas de 1963 e de 1972 (Performers Protection Acts)
- Quaisquer regulamentos e despachos estatutários posteriores

### ADVERTÊNCIAS

- Não exponha o equipamento à chuva nem à humidade.
- Não retire a tampa do equipamento.
- Não atire nada para dentro do equipamento através dos orifícios de ventilação.
- Não manuseie o cabo de alimentação com as mãos molhadas.
- Não cobrir os orifícios de ventilação com objectos tais como toalhas de mesa, jornais, cortinas, etc.
- Não colocar chamas abertas tais como velas acesas, sobre o aparelho.
- Ao deitar foras as pilhas usadas, favor observar os regulamentos governamentais ou as regras com respeito ao meio ambiente que se aplicam no seu país ou área de residência.
- Deixar um espaço completamente livre de cerca de 1 metro acima do painel superior.
- Deixar um espaço de cerca de 0,2 metro ao redor do aparelho.
- Quando o projector for montado no tecto, o Kit de Montagem no Tecto aprovado pela MARANTZ deverá ser utilizado para a instalação.
- Não olhe para dentro da lente quando o projector é activado. Isto pode danificar a visão.
- Desligue o projector da tomada de parede se este não estiver para ser utilizado durante alguns dias.
- Quando o interruptor estiver na posição OFF (desligado), o aparelho NÃO é desligado da rede eléctrica principal.
- A tomada de parede deverá estar instalada perto do equipamento e deverá estar facilmente acessível.
- Não colocar recipientes com água, tal como vasos, sobre o aparelho.

### Precauções para o manuseio da lâmpada

#### CUIDADO

Esta lâmpada SHP é uma lâmpada feita de vidro que contém vapor de mercúrio a alta pressão. A lâmpada pode quebrar ou não acender caso seja manuseada incorrectamente durante a substituição ou devido à temperatura ambiente onde se encontra o projector.

A vida útil da lâmpada também varia conforme a lâmpada, com casos de quebra ou falha em acender na primeira vez que a lâmpada é utilizada. Se a lâmpada quebrar, estilhaços de vidro podem cair dentro do compartimento da lâmpada e do projector, e o gás de dentro da lâmpada que contém vapor de mercúrio poderá ser emitido através da saída do projector.

Antes de o utilizar, leia cuidadosamente o guia do utilizador do projector bem como as instruções para substituição da lâmpada. Lembre-se de manusear a lâmpada com cuidado. No caso de problemas, entre em contacto com o representante autorizado da Marantz.

- Não olhar directamente na lâmpada acesa sem protecção ocular. A luz forte pode causar irritação nos olhos ou prejudicar a visão.
- Não expor a pele directamente à luz da lâmpada. Exposição directa pode causar inflamação na pele.
- Não derrubar, bater, nem usar força excessiva, pois pode danificar a lâmpada.
- Devido ao risco de queimaduras e choque eléctrico ao substituir a lâmpada, desligue a alimentação, desligue o cabo de alimentação da tomada de CA e espere pelo menos 60 minutos para arrefecer antes de substituir a lâmpada.
- Se a lâmpada quebrar, desligue o cabo de alimentação de CA da tomada e entre em contacto com o representante autorizado da Marantz para que faça a substituição. Não tente fazer a substituição nem limpar os estilhaços de vidro de dentro do projector, pois pode resultar em cortes e queimaduras ou ainda danos ao projector.
- Se o projector estiver instalado no teto ou qualquer lugar alto, é extremamente perigoso substituir a lâmpada. Nesse caso, não tente fazer a substituição nem manusear o lâmpada danificada.

### AVISO

- A probabilidade da lâmpada quebrar aumenta depois de um longo período de utilização. É recomendável substituir a lâmpada quando a vida útil da mesma estiver próxima do fim. Não utilizar a lâmpada além do tempo máximo determinado.
- Utilizar apenas lâmpadas genuínas Marantz. Confirme que o código do modelo da lâmpada corresponde com o listado no guia do utilizador.
- Antes de substituir a lâmpada, leia cuidadosamente a secção “Substituição da lâmpada” no guia do utilizador. Substitua a lâmpada de acordo com as instruções dadas.
- Para jogar uma lâmpada usada, solicite os serviços de uma companhia autorizada a colectar lixo industrial ou devolva a lâmpada na loja onde a adquiriu. Não quebrar a lâmpada nem jogá-la com o lixo comum.
- Se a lâmpada quebrar, saia da sala imediatamente, ventile o ambiente para evitar inalar o vapor de mercúrio e não retorne por pelo menos 30 minutos.
- Se inalar o vapor de mercúrio, consulte um médico imediatamente e siga as suas instruções.

# TABLE OF CONTENTS

<b>IMPORTANT SAFEGUARDS.....</b>	<b>2</b>	<b>OPERATIONS .....</b>	<b>17</b>
Caution Concerning the Lamp Replacement .....	2	Menu Structure .....	17
Caution Concerning the Lamp Unit .....	2	Picture Mode .....	18
Caution Concerning the Setup of the Projector .....	2	How to Operate Menus .....	18
Notes on Operation .....	2	Picture Adjust .....	19
<b>FEATURES.....</b>	<b>3</b>	Fine Menu 1 .....	20
<b>ACCESSORIES.....</b>	<b>3</b>	Fine Menu 2 .....	20
<b>PROJECTOR LAYOUT AND FUNCTIONAL OVERVIEW .....</b>	<b>4</b>	Input Signal .....	21
Front and Top View .....	4	RGB/HD Adjust .....	21
Rear and Terminals View .....	5	Display .....	22
Bottom View .....	5	OSD/Blanking .....	22
Remote Controller .....	6	Configuration .....	23
Remote Controller Operational Range .....	7	<b>MAINTENANCE.....</b>	<b>24</b>
Preparing the Remote Controller .....	7	Lamp Life and Replace Lamp .....	24
<b>CONNECTION.....</b>	<b>8</b>	Replacing Lamp Unit .....	24
Connection with AC Power Supply .....	8	Color Temperature Adjustment .....	26
Connection with Video Equipments .....	8	Cleaning the Lens .....	27
Connection with a HD-Video, DVD Player, Satellite, Cable Tuner or PC .....	9	Replacement Parts .....	27
Advanced Connection .....	9	Optional Accessories .....	27
<b>INITIAL SETTING .....</b>	<b>10</b>	<b>TROUBLESHOOTING.....</b>	<b>27</b>
Turning on the Power .....	10	<b>ERROR MODE .....</b>	<b>28</b>
Zooming and Focusing .....	10	<b>ON SCREEN MESSAGE.....</b>	<b>28</b>
Detail Focusing .....	10	<b>SPECIFICATIONS.....</b>	<b>29</b>
Adjusting the Image Position .....	11	<b>DIMENSIONS .....</b>	<b>30</b>
Adjusting the Height .....	11	<b>GLOSSARY .....</b>	<b>30</b>
Keystone Correction .....	11		
<b>INSTALLATION.....</b>	<b>12</b>		
Recommended Setting .....	12		
Screen Size and Projection Distance (inch) VP-12S4 .....	13		
Screen Size and Projection Distance (mm) VP-12S4 .....	13		
Lens shift position .....	14		
<b>BASIC OPERATIONS .....</b>	<b>15</b>		
Turning on the Power .....	15		
Selecting the Input Signal Source .....	15		
Selecting the Aspect Mode .....	15		
The Screen Images in a 16:9 screen .....	15		
The Screen Images in a 4:3 screen .....	16		
To Turn off the Power .....	16		

# IMPORTANT SAFEGUARDS

## Caution Concerning the Lamp Replacement

There is potential glass particle hazard if the lamp ruptures.

## Caution Concerning the Lamp Unit

There is a potential hazard of glass particle if the lamp ruptures. In case of lamp rupture, contact your nearest Marantz Authorized Dealer or Service Center for a replacement. See "Replacing Lamp Unit". (P.24)

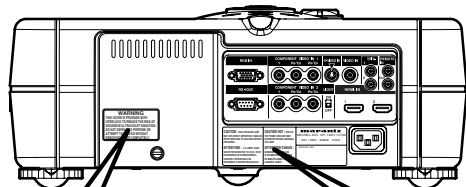

For USA

### WARNING

THIS COVER IS PROVIDED WITH INTERLOCK TO REDUCE THE RISK OF EXCESSIVE ULTRAVIOLET RADIATION. DO NOT DEFEAT ITS PURPOSE OR ATTEMPT TO SERVICE WITHOUT REMOVING COVER COMPLETELY.

For Europe

### CAUTION HOT

UNPLUG THE POWER CORD AND WAIT 60 MINUTES BEFORE CHANGING THE LAMP.

### ATTENTION CHAUD

DEBRANCER LE CORD ON D'ALIMENTATION ET ATTENDRE 60 MINUTES AVANT DE CHANGER LA LAMPE.

### WARNUNG HEISS

ZIEHEN SIE DEN NETZSTECKER AB UND WARTEN SIE 60 MINUTEN, BEVOR SIE DIE GLUHLAMPE WECHSELN.

For USA

**CAUTION :** HIGH PRESSURE LAMP MAY EXPLODE IF IMPROPERLY HANDLED. REFER SERVICING TO QUALIFIED SERVICE PERSONNEL.

**ATTENTION :** LA LAMPE SOUS HAUTE PRESSION PEUT SI ELLE, N'EST PAS MANIPULEE CORRECTEMENT, CONFIER L'OPERATION A UN PERSONNEL D'ENTRETIEN QUALIFIE.

**CAUTION HOT :** UNPLUG THE POWER CORD AND WAIT 60 MINUTES BEFORE CHARGING THE LAMP.

**ATTENTION CHAUD :** DEBRANCER LE CORD ON D'ALIMENTATION ET ATTENDRE 60 MINUTES AVANT DE CHANGER LA LAMPE.

For Europe

### CAUTION

HIGH PRESSURE LAMP MAY EXPLODE IF IMPROPERLY HANDLED. REFER SERVICING TO QUALIFIED SERVICE PERSONNEL.

### ATTENTION

LA LAMPE SOUS HAUTE PRESSION PEUT EXPLOSER SI ELLE, N'EST PAS MANIPULEE CORRECTEMENT, CONFIER L'OPERATION A UN PERSONNEL D'ENTRETIEN QUALIFIE.

### VORSICHT :

BEI FALSCHER HANDHABUNG KANN DIE HOCHDRUCKLAMPE EXPLODIEREN UBERLASSEN SIE WARTUNGSARBEITEN NUR FACHPERSONAL.

## Caution Concerning the Setup of the Projector

For minimal servicing and to maintain high image quality, avoid humidity, dust and cigarette smoke. When the projector is subjected to these environments, the lens and part of ventilation holes must be cleaned more often than usual. As long as the projector is properly maintained in this manner, use in these environments will not reduce the overall operation life. Please note that all internal cleaning must be performed by an Marantz Authorized Dealer, or Service Center.

- Do not expose the projector to extreme heat or cold.
- Operating temperature: 41 °F to 95 °F (+5 °C to 35 °C)
- Storage temperature: -4 °F to 140 °F (-20 °C to +60 °C)

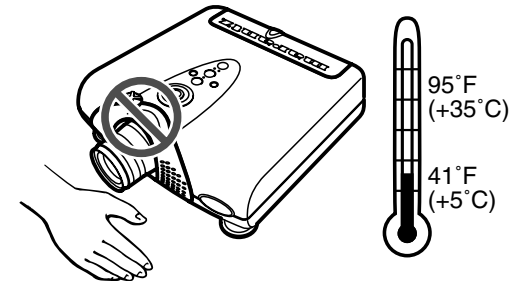

## Notes on Operation

- The exhaust ventilative hole, the lamp cage cover and adjacent areas may get extremely hot during projector operation. To prevent injury, do not touch these areas until they have sufficiently cooled down.
- Allow at least 1 foot (30 cm) of space between the exhaust ventilative hole and the nearest wall or obstruction.
- If the cooling fan becomes obstructed, a protection device will automatically turn off the projector lamp. This does not indicate a malfunction. Remove the projector power cord from the wall outlet and wait at least 10 minutes. Then turn on the power by plugging the power cord back in. This will return the projector to the normal operating condition.

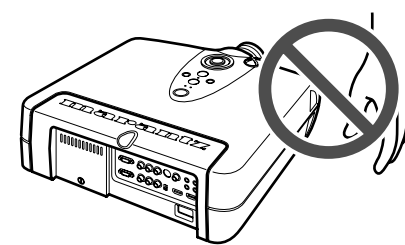



# FEATURES

- Incorporates the latest DMD element -- “.8 720p with DarkChip3™” (1280 x 720 pixel, 16:9 wide panel). Using an optimized system for movie viewing with specially designed image circuits and optical parts, the VP-12S4 bring high color reproduction with the pitch black of movie films that reproduces images in rich tones and crisp black.
  - Images are sharply detailed, smooth and high quality owing to a powerful chip that builds into a dedicated processor an image processing IC featuring Gennum’s proud “VXP™” high quality contouring technology, “TruMotionHD™”, “FineEdge™”, “RealityExpansion™” and “FidelityEngine™”.
  - Konica Minolta optical system custom-made for Marantz.
  - O.R.C.A. (Optically Reproducing Color Accurately) filter™ that greatly improves color purity.
  - A large 98mm 7-segment color wheel that builds an ND filter.
  - Automatic color temperature adjustment
  - 4 Picture Modes (Theater, Standard, Dynamic, User)
  - 5 built-in preset gammas
  - Fine-adjustment menus that allow the user to adjust images as they like
  - 18 user menus for saving adjusted images
  - Color temperature setting (5250K, 5800K, 6500K, 7500K, 9300K)
  - Black level adjustment
  - Supports input of NTSC, PAL, SECAM and satellite broadcasts (480i/p, 540p, 576i/p, 720p, 1035i, 1080i/p).
  - Rich array of input jacks including HDCP supporting HDMI digital input jack and dual system component jacks
  - 1.45x zoom lens
  - Lens shift feature for vertically positioning the projection point
  - Digital correction of vertical keystone distortion
  - Projection modes for functional, hanging and rear projection
  - Light-up luminous remote control
  - Light-up I/O jacks for easy connections and setup in dark environments
  - Equipped with RS-232C port and 12V trigger terminal for custom installation
  - Marantz system bus port
  - Low operating noise thanks to a die-cast silent duct, hermetically sealed color wheel motor and fan speed control
  - Highly rigid die-cast chassis to minimize radiating noise
  - 2000 hr long-life 200W SHP lamp with double-shielded safety structure
- **Digital Micromirror Device, DLP, DLP logo, DLP Medallion and DarkChip3** are trademarks of Texas Instruments.
  - **VXP, Visual Excellence Processing and the VXP Logo** are trademarks or registered trademarks of Gennum Corporation.
  - All trademarked product names mentioned in this manual are the property of their respective companies.
  - **HDMI, the HDMI logo and High-Definition Multimedia Interface** are trademarks or registered trademarks of HDMI Licensing LLC.

# ACCESSORIES

- Lens Cap x 1

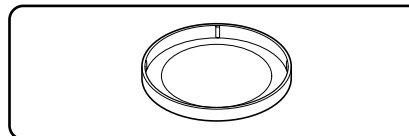

- Remote Controller x 1

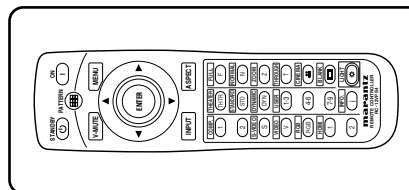

- AA Size Batteries x 2

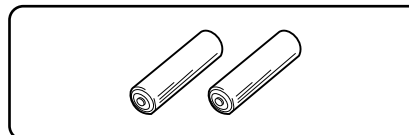

- Scart - RCA plug Cable x 1 (For Europe only)

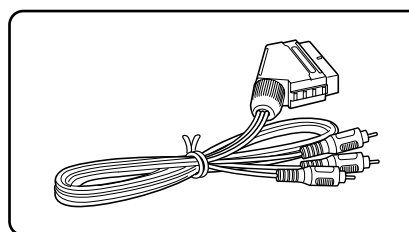

- Color temperature sensor x 1

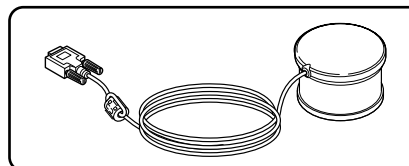

- AC Power Code

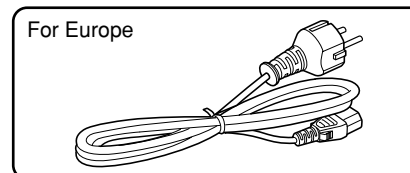
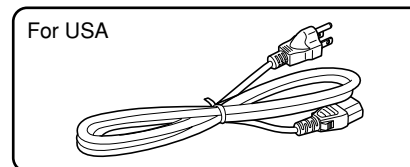

- Control Adapter Cable (Mini Jack to RCA) x 1

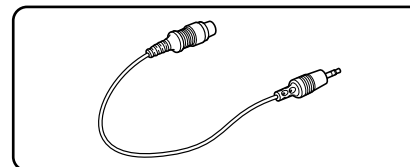

- User Guide

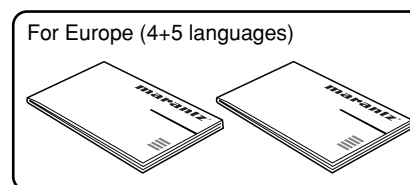
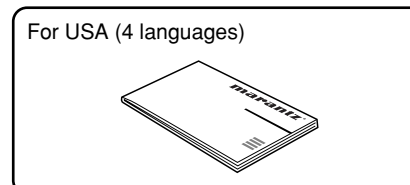

- Warranty Card  
(1 copy each for USA, CANADA)

# PROJECTOR LAYOUT AND FUNCTIONAL OVERVIEW

## Front and Top View

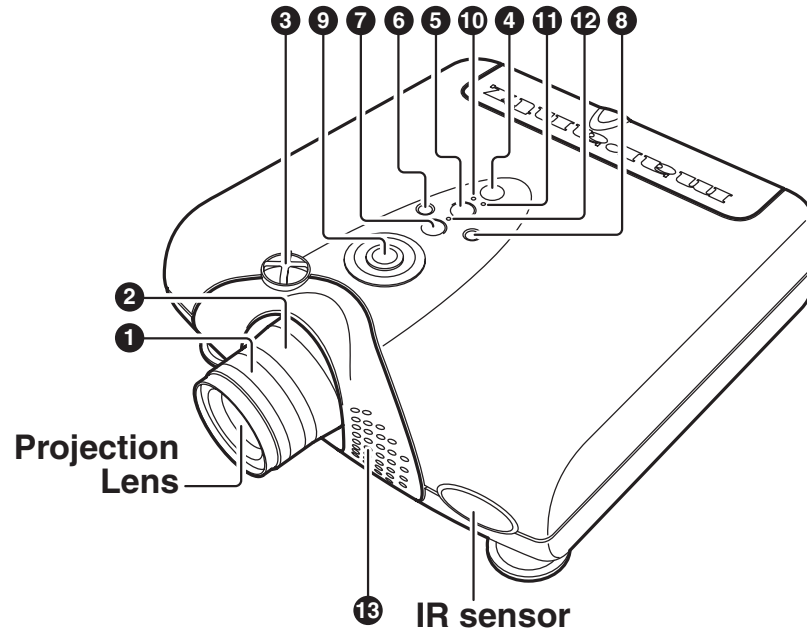

### 1 Focus ring (P.10)

Adjust the picture focus.

### 2 Zoom ring (P.10)

Adjust the size of the projected image.

### 3 Lens Shift knob (P.11)

Manually adjust the position of the image vertically.

### 4 Power / Standby button (P.15)

Press to turn the projector ON or STANDBY mode.

### 5 MENU button (P.18)

Display the on-screen menu.

### 6 ENTER button

Press to enter the selected menu item.

### 7 INPUT SELECT button (P.15)

Selects the input signal (COMPONENT 1, COMPONENT 2, S-VIDEO, VIDEO, RGB, HDMI 1 and HDMI 2).

### 8 PATTERN button (P.10)

Projects a focus pattern on the screen.

### 9 The ▲ / ▼ / ◀ / ▶ buttons

Control the MENU cursor.

### 10 ON indicator

Lights up blue when power is ON. When power is shut OFF, the lamp flashes for about 1 minute before going out.

### 11 STANDBY indicator

Lights up when the power is turned off.

### 12 WARNING/LAMP indicator

Flashes or lights up when something is wrong with the lamp cover, lamp, fan, or temperature inside the projector.

For more information on the error mode, see the "Error Mode List" (P.28)

### 13 Ventilation holes

#### Notes:

- Do not place anything near the ventilation holes to avoid overheat inside the unit.
- Do not place your hand or objects near the ventilation holes; the air is coming out.

#### Note: Pixel defects

DMD (Digital Micromirror Device) is one of the most advanced technologies for consumer products. The DMD made by high precision technology, however some pixel defects may be found on the projected image. We are trying our best to control the quality in order to reduce the number of defective pixels. It is almost impossible to have zero pixel defects, even using the most advanced technology. This is not a problem only for Marantz, but all DLP™ projector manufactures. Therefore we have to note that the warranty does not cover the DMD for pixel defects. We appreciate your understandings.

#### Note: Lamp

SHP lamp is one of the most advanced technologies for consumer products. The lamp made by high precision technology, however some lamps might be failing before it reaches its life. And projector's brightness is getting darker along with accumulated lamp usage hours. We are trying our best to control the quality in order to reduce lamp failures. It is almost impossible to have zero failure, even using the most advanced technology. This is not a problem only for Marantz, but all projector manufactures. Therefore we have to note that the warranty does not cover the SHP lamp for lamp failures: explosion, and non-lighting except initial use. And also we have to note that the warranty does not cover the SHP lamp for lamp failures: flickering, and getting darker along with accumulated lamp usage hours. We appreciate your understandings.

## Rear and Terminals View

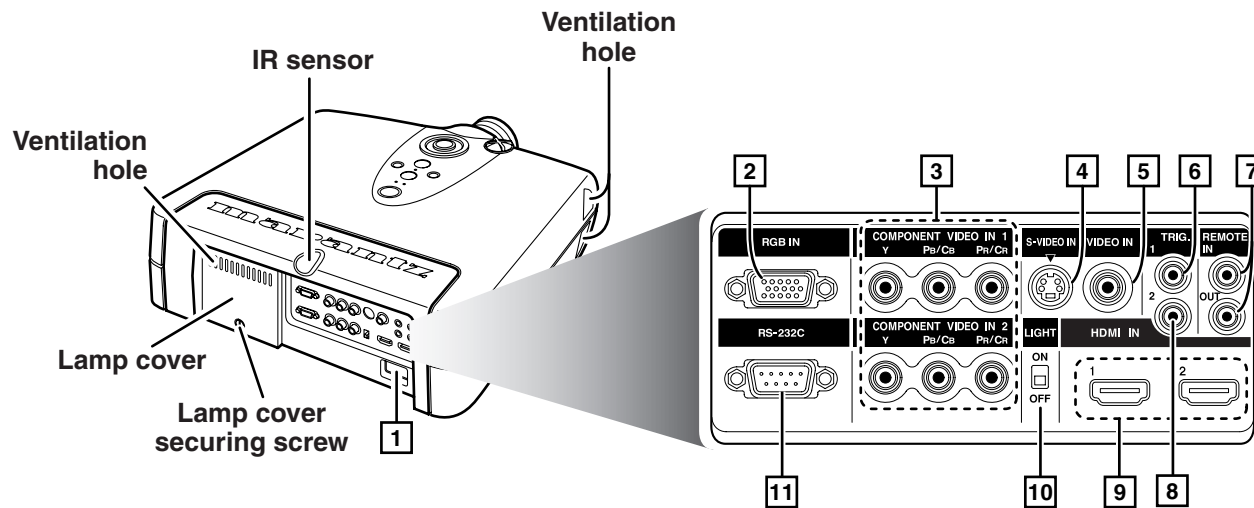

### 1 AC IN (P.8)

Connect the supplied AC power code.

### 2 RGB IN

Connect the analog RGB output from an IBM VGA or compatible equipment.

### 3 COMPONENT VIDEO IN 1 and 2

Terminals 1 and 2 have each Y, Pb/Cb, Pr/Cr terminals. Connect them to the component video output of a video device, AV amp/processor, DVD player, etc.

### 4 S-VIDEO IN

Connect the S-VIDEO output from a video equipment.

### 5 VIDEO IN

Connect the composite video output from a video equipment.

### 6 TRIG.1(TRIGGER 1)

When the unit is turned on, 12V is output. When the unit is turned off, no voltage is output. This allows such as a powered up/down screen, whenever the projector is turned on or off.

#### Note:

To connect with external devices, use an ordinal 3.5mm mini-plug (mono) cable.

### 7 REMOTE IN/OUT

By connecting this projector to another Marantz audio component using a supplied System Control cable, you can remotely operate the components as a single system.

- When connecting to component with a remote sensor (such as the SR9500, SR8500), be sure to connect the "REMOTE CONTROL IN" jack of this projector to the "REMOTE CONTROL OUT" jack of the component with the remote sensor.

#### Note:

For connections, always use the included bus control adaptor cable.

### 8 TRIG.2(TRIGGER 2)

Select ON or OFF at each aspect mode, such as Full, Normal, Zoom, and Through to control screen aspect ratio with powered up/down dual aspect ratio screen.

#### Notes:

- Do not use TRIG.1 and TRIG.2, as the power source.
- To connect with external devices, use an ordinal 3.5mm mini-plug (mono) cable.

### 9 HDMI IN 1 and 2

Connect the digital RGB signal (TMDS compliant, single link only)

#### Note:

To use the HDMI terminal, please follow the cautions on page 9.

### 10 LIGHT ON/OFF

Select ON : The terminal panel lights up.

### 11 RS-232C

This is the control port for the custom installer.

## Bottom View

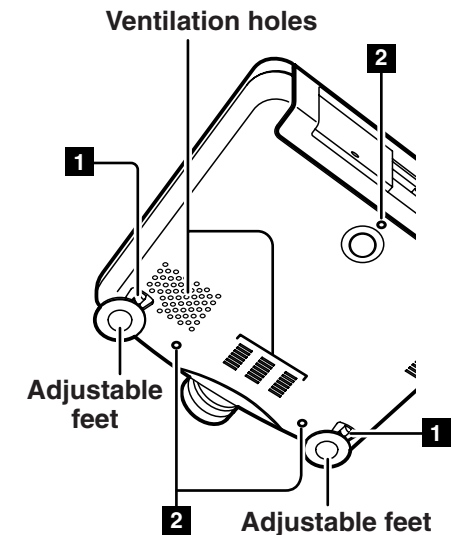

### 1 Adjustment lever (P.11)

Lift the projector and turn the adjustment lever right or left. The adjustable feet will extend from the projector. Then, release the lever, the adjustable feet is locked.

### 2 Screw holes for ceiling mount kit

## Remote Controller

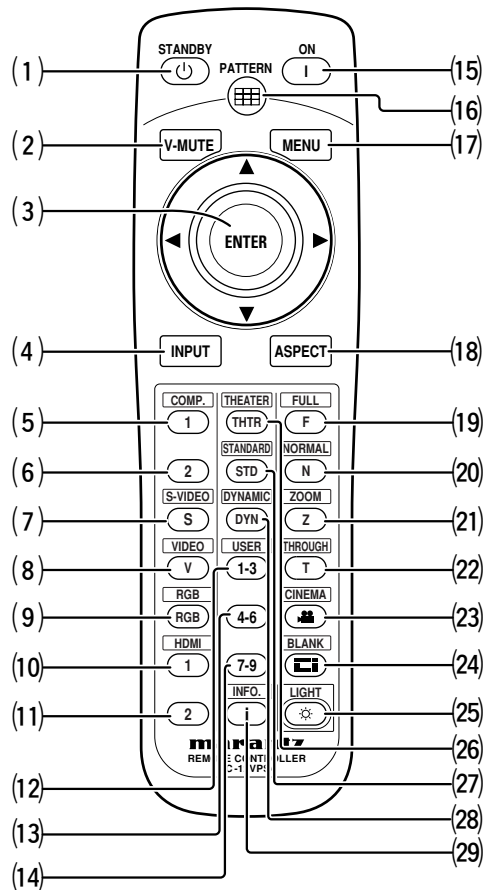
**(1) STANDBY button (P.16)**

Turn the projector off.

**(2) V-MUTE button**

Turn the picture into black. Press again to resume.

**(3) ▲ / ▼ / ◀ / ▶ / ENTER buttons**

Press the cursor buttons (▲ [UP], ▼ [DOWN], ◀ [LEFT], ▶ [RIGHT]) to select menu items. Press the button at its center to enter the selected item.

**(4) INPUT (Input signal select) button (P.15)**

Selects the input signal. Every time the button is pressed, the selection rotates in the order of COMPONENT 1 → COMPONENT 2 → S-VIDEO → VIDEO → RGB → HDMI 1 → HDMI 2.

**(5) COMP. 1 (Component video in 1) button (P.15)**

Selects the device connected to the COMPONENT VIDEO IN 1 jack as the input source.

**(6) COMP. 2 (Component video in 2) button (P.15)**

Selects the device connected to the COMPONENT VIDEO IN 2 jack as the input source.

**(7) S-VIDEO button (P.15)**

Select the S-VIDEO IN signal.

**(8) VIDEO button (P.15)**

Select the VIDEO IN signal.

**(9) RGB button (P.15)**

Select the RGB IN signal.

**(10) HDMI 1 button (P.15)**

Select the HDMI 1 IN signal.

**(11) HDMI 2 button (P.15)**

Select the HDMI 2 IN signal.

**(12) USER 1-3 button (P.18)**

Selects the user mode.

The user mode is for enjoying images at a user-selected gamma curve.

Every time the button is pressed, the selection rotates in the order of User 1 → User 2 → User 3. For more information on how to select gamma curve. (P.19)

**(13) USER 4-6 button (P.18)**

Selects the user mode.

The user mode is for enjoying images at a user-selected gamma curve.

Every time the button is pressed, the selection rotates in the order of User 4 → User 5 → User 6. For more information on how to select gamma curve. (P.19)

**(14) USER 7-9 button (P.18)**

Selects the user mode.

The user mode is for enjoying images at a user-selected gamma curve.

Every time the button is pressed, the selection rotates in the order of User 7 → User 8 → User 9. For more information on how to select gamma curve. (P.19)

**(15) ON button (P.15)**

Turn the projector on.

**(16) PATTERN button (P.10)**

Projects a focus pattern on the screen.

**(17) MENU button (P.18)**

Display the on-screen menu.

**(18) ASPECT (Aspect select) button (P.15)**

Selects the aspect ratio. Every time the button is pressed, the selection rotates in the order of Full → Normal → Zoom → Through.

**(19) FULL button (P.15)**

Select FULL mode from four aspect ratio modes.

**(20) NORMAL button (P.15)**

Select NORMAL mode from four aspect ratio modes.

**(21) ZOOM button (P.15)**

Select ZOOM mode from four aspect ratio modes.

**(22) THROUGH button (P.15)**

Select THROUGH mode from four aspect ratio modes.

**(23) CINEMA button**

Press to turn the CINEMA mode – auto 3-2 pull down mode – on or off.

**(24) BLANK button**

Select the blanking mode. Every time the button is pressed, the selection rotates in the order of OFF → Memory 1 → Memory 2 → Memory 3.

**(25) LIGHT button**

Lights up backlit buttons (ON, STANDBY, MENU, V-MUTE, INPUT, ASPECT, PATTERN) for about 7 sec.

**(26) THEATER (THTR) button (P.18)**

Select the Theater picture mode.

Theater mode is designed for high fidelity black appearance and is good for movie pictures.

Every time THEATER button is pressed, the selection rotates in the order of Theater 1 → Theater 2 → Theater 3 → Default.

**(27) STANDARD (STD) button (P.18)**

Select the STANDARD picture mode.

Standard mode is good for normal pictures.

Every time the button is pressed, the selection rotates in the order of Standard 1 → Standard 2 → Standard 3 → Default.

**(28) DYNAMIC (DYN) button (P.18)**

Select the Dynamic picture mode.

Dynamic mode is good for visually dynamic pictures.

Every time the button is pressed, the selection rotates in the order of Dynamic 1 → Dynamic 2 → Dynamic 3 → Default.

**(29) INFO. button (P.24)**

Turn the information menu on or off.

## Remote Controller Operational Range

Operate the remote controller within a distance of approximately 5m from the IR sensor (remote sensor) on the projector.

Remote control operation may not be possible if the remote control unit's transmitter is not pointing in the direction of the remote sensor or if there is an obstruction between the transmitter and the remote sensor.

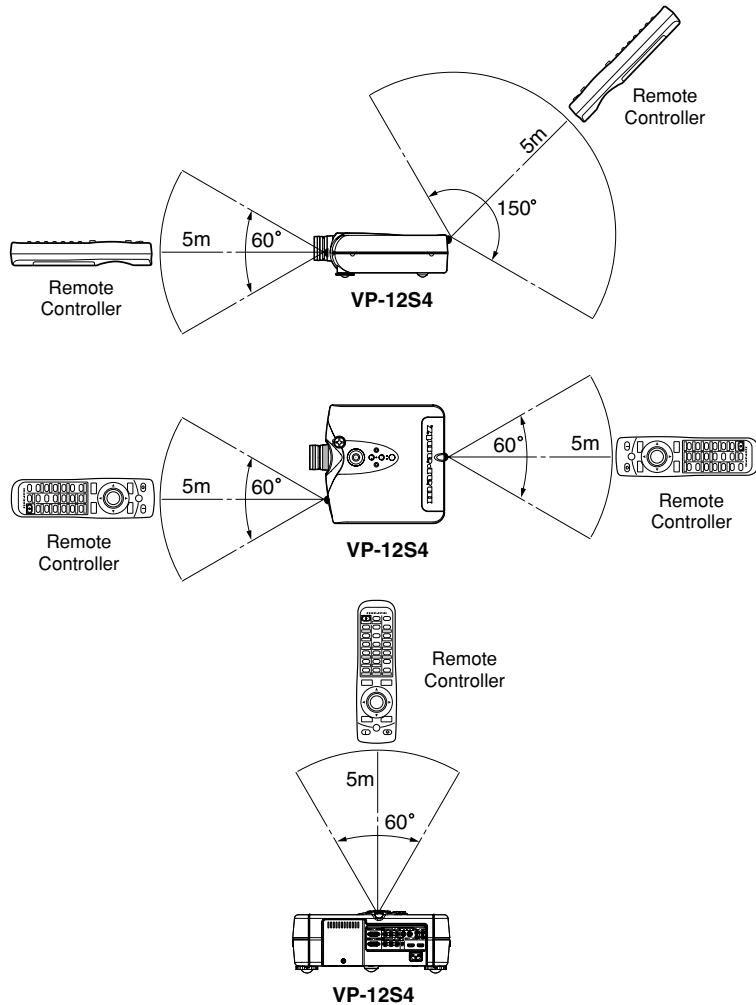

## Preparing the Remote Controller

1. Take the cover off the battery case on the remote control backside.

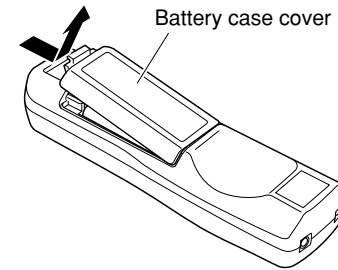

2. Insert two AA size batteries. Make sure the polarities match the + and - marks inside the battery compartment.

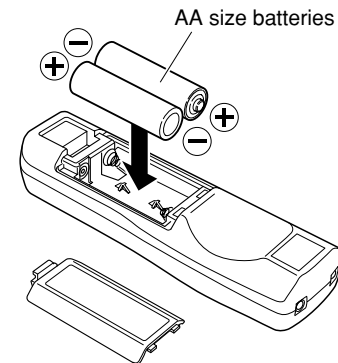

3. Reattach the battery case cover as before.

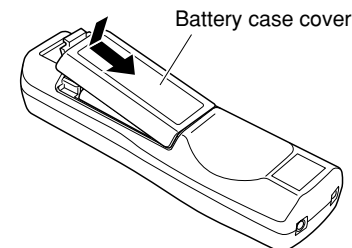

### Notes :

- Do not mix alkaline and manganese batteries.
- Do not mix old and new batteries.

### CAUTIONS ON BATTERIES

- Use "AA" type batteries in this remote control unit.
- If the remote control unit does not operate from close to the main unit, replace the batteries with new ones, even if less than a year has passed.
- The included battery is only for verifying operation. Replace it with a new battery as soon as possible.
- When inserting the batteries, be careful to do so in the proper direction, following the + and - marks in the remote control unit's battery compartment.
- To prevent damage or battery fluid leakage:
  - Do not use a new battery with an old one.
  - Do not use two different types of batteries.
  - Do not short-circuit, disassemble, heat or dispose of batteries in flames.
- Remove the batteries when not planning to use the remote control unit for a long period of time.
- If the batteries should leak, carefully wipe off the fluid from the inside of the battery compartment, then insert new batteries.
- When disposing of used batteries, please comply with governmental regulations or environmental public instruction's rules that apply in your country or area.

# CONNECTION

## ❖ When making connections be sure to:

- Turn off all equipment before making any connections.
- Use the proper cables for each connection.
- Securely insert the plug into the port to connect cables. Loose cables can lead to trouble and damage.

## ❖ When pulling out a cable:

- Be sure to grab the plug, not the cable itself.

## Connection with AC Power Supply

Connect the supplied AC power cord into the AC IN socket of the projector. The STANDBY indicator lights up and the projector goes into the standby mode.

**Note :** Make sure the AC power cord is firmly connected into the AC IN socket.

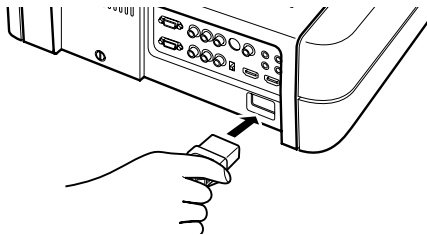

## Connection with Video Equipments

You can connect this projector to a VCR, DVD player and other video equipment.

### Connecting a video source using S-VIDEO IN and VIDEO IN terminals.

1. Connect one of the S-video cable to the S-VIDEO IN terminal, or one end of the video cable to the VIDEO IN terminal on the projector.
2. Connect the other end of the S-video cable or the video cable to the S-video output terminal or video output terminal of the video source.

### Connecting a DVD player to the COMPONENT VIDEO IN 1 or 2 terminal (Devices can be connected to both terminals at the same time.)

1. Connect the individual terminals of the component video cable into the COMPONENT VIDEO IN 1 or 2 terminal of the projector.
2. Connect the other end of the cable to the corresponding terminals on a DVD player.

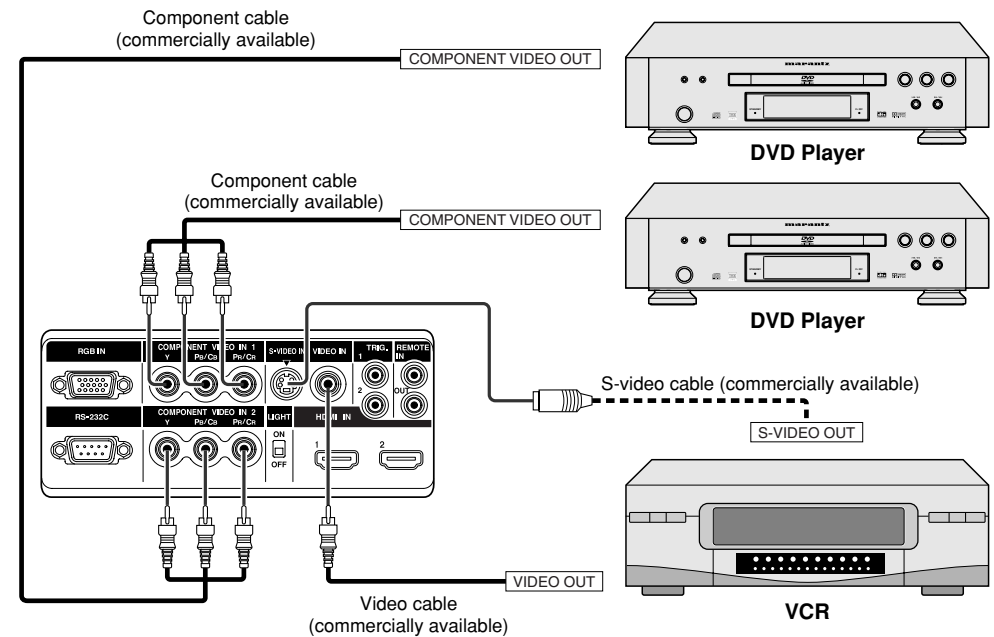

## Connection with a HD-Video, DVD Player, Satellite, Cable Tuner or PC

You can connect this projector to HD-Video /PC using RGB IN port, or DVD Plyer /Satellite /Cable Tuner /PC using HDMI IN port.

1. Connect one end of the RGB cable to the RGB IN port, or one end of the HDMI cable to the HDMI IN port on the projector.
2. Connect the other end to the corresponding port on a HD-Video, Satellite, Cable Tuner or personal computer.

**Note :** When projecting a video image from a device connected to the HDMI terminal, follow the procedure below.

1. Turn on power of this unit. (P.15)
2. Set the input video source to HDMI input. (P.15)
3. Turn on power of the device connected to the HDMI terminal of the unit (i.e. DVD player).

If the procedure above is not followed, projected image may corrupt.  
For the details of the HDMI terminal on the device connected with the unit, see the instruction manual of the device.

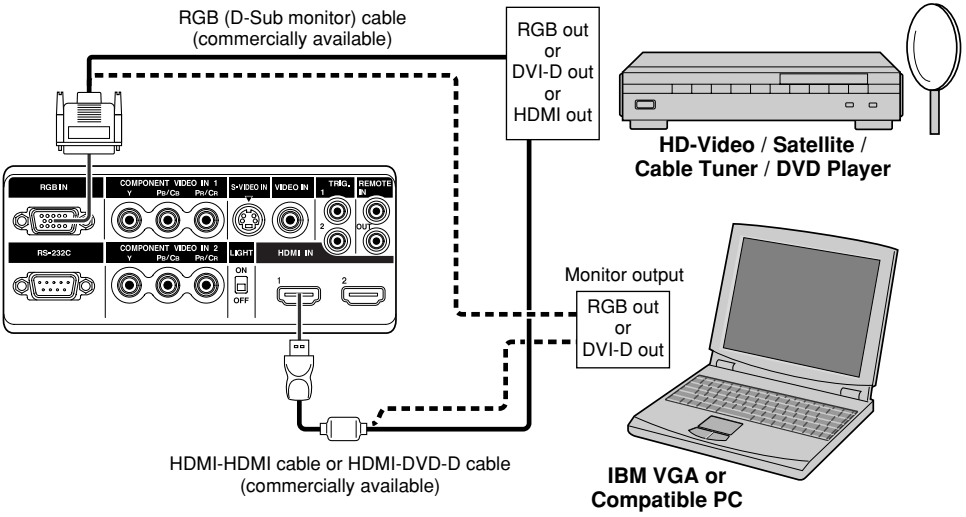

## Advanced Connection

You can control total home theater system using PC or Marantz receiver equipment. For installing below system, consult with Marantz authorized dealer.

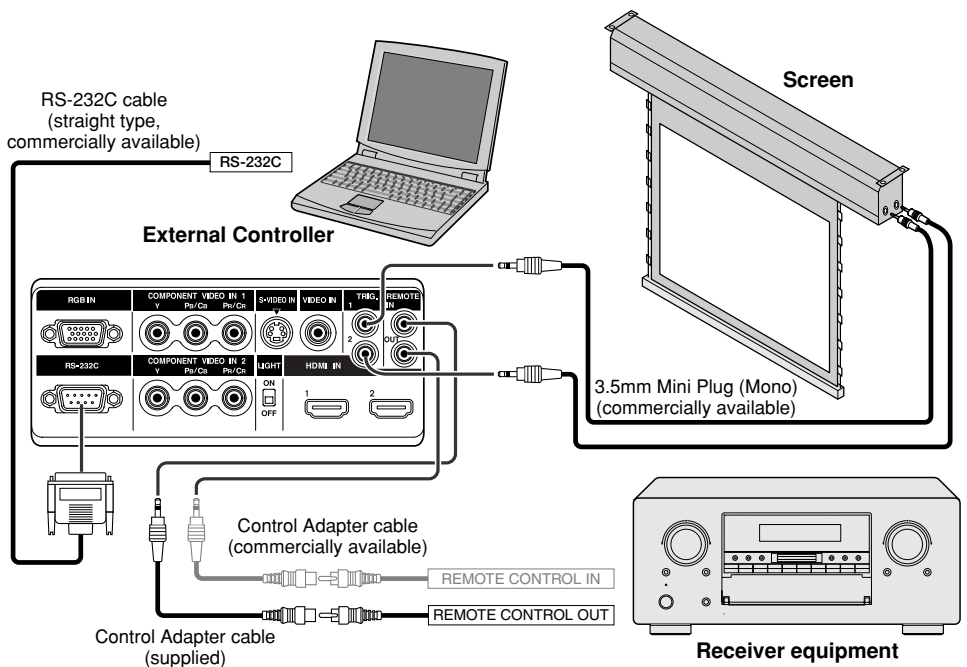

# INITIAL SETTING

## Turning on the Power

1. Connect the supplied AC power cord. (☞ P.8)
2. Press the **ON** button on the remote controller or the  $\text{P}$  / I button on the projector.  
The ON indicator lights up.

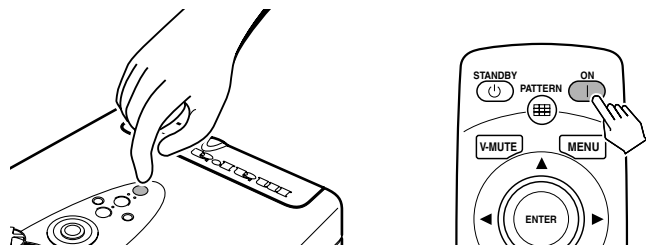

## Zooming and Focusing

Project an image on the screen roughly at first.

1. Turn the **Zoom ring** and adjust to the desired size within the zoom range.  
WIDE: Enlarges (zooms in) the projected image.  
TELE: Reduces (zooms out) the projected image.
2. Turn the **Focus ring** until the image on the screen becomes clear.

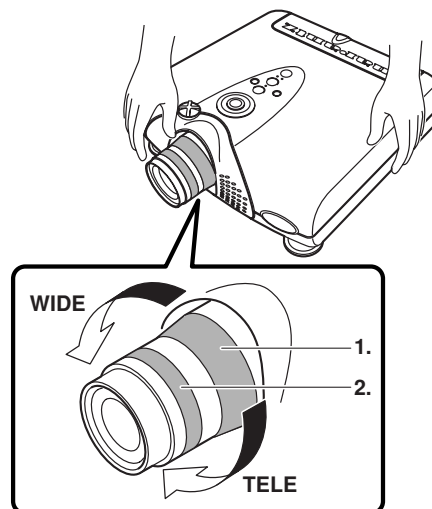

## Detail Focusing

You can strictly focus the image with focus pattern.

1. Press the **PATTERN** button to project the focus pattern on the screen.

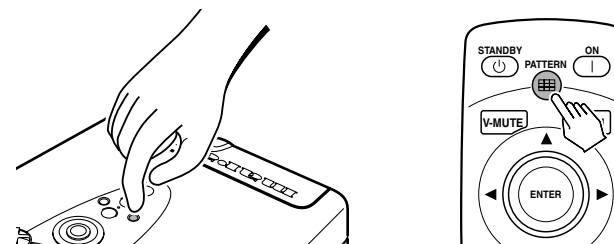

2. Turn the **Focus ring** to make an adjustment.  
Adjust the focus for the sharpest image possible to obtain, using focus pattern.

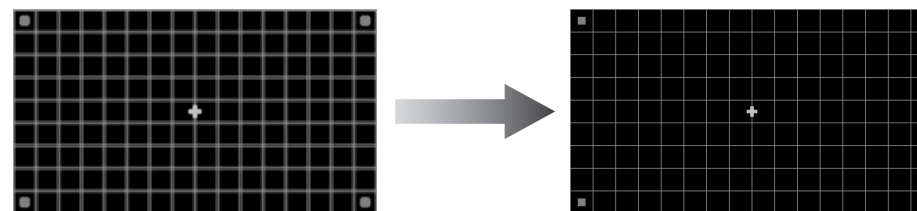

3. Press the **PATTERN** button again to hide the focus pattern. This completes fine focusing.

### Note :

#### Changing the Focus Pattern Color According to Lens Position (☞ P.14)

The focus pattern changes color depending on the lens position. There are two colors and they can be used for checking the quality of the projected image. The **white** focus pattern uses the highest optical performance to maximize the sharpness of the projected image. To enjoy the highest sharpness, it is recommended to position the lens within this range.

When the lens is shifted outside the aforementioned range, the focus pattern turns **green**. Rough focusing in this range loses image sharpness.

Adjusting the zoom position from WIDE to TELE enhances sharpness even at the same lens position. However, the focus pattern does not change when the zoom position is changed.



## Adjusting the Image Position

You can adjust the image position with the Lens Shift knob.

- ❖ Turn the Lens Shift knob to clockwise : The image goes up.

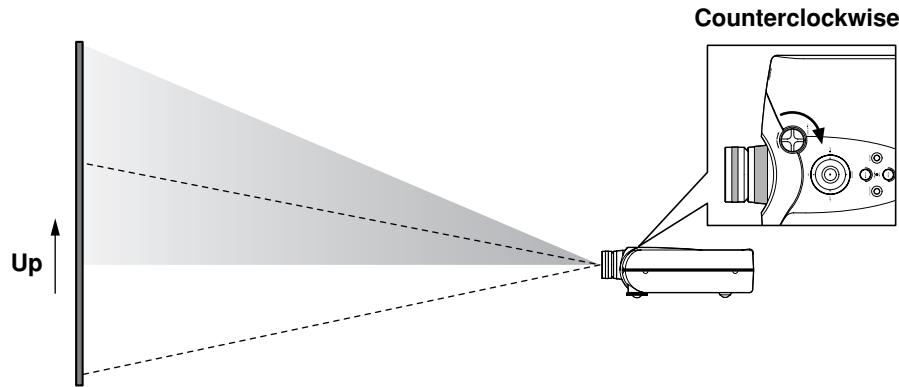

- ❖ Turn the Lens Shift knob to counterclockwise : The image goes down.

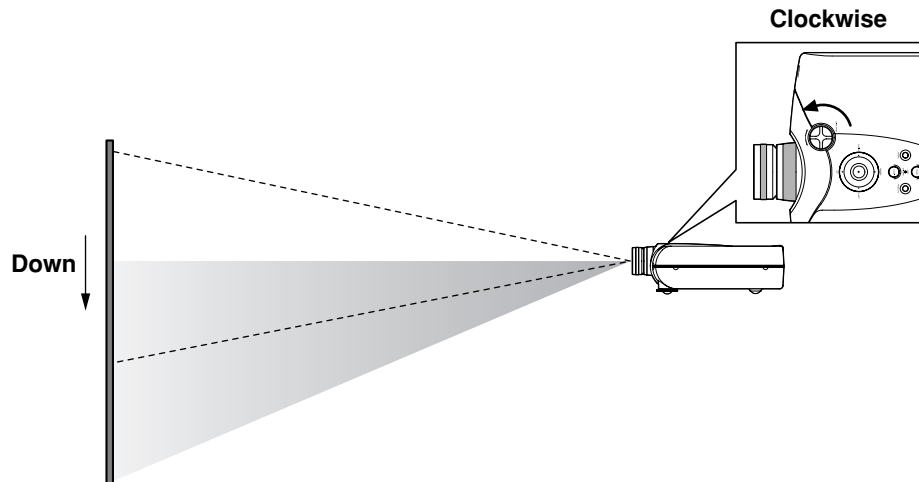

## Adjusting the Height

You can position the projected image by changing the height of the projector's adjusters.

1. Move the adjuster lever to the left or right to enable adjuster changing. Carefully lift the projector.
2. Once having positioned the projector, return the adjuster lever as before to lock in place. Check the adjusters are securely locked before releasing your hands from the projector.
3. Turn the adjuster to fine-adjust the height.

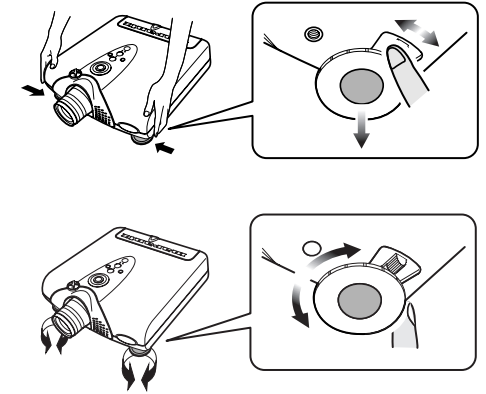

- ❖ Returning the Projector to its Initial Position

Slightly lift the projector, turn the adjuster lever to the left or right, then carefully set the projector down.

## Keystone Correction

When the projecting image is a trapezoid, correct it in Keystone and in the Display Menu. See "Display". (P.22)

- ❖ Keystone  
(Electronic keystone correction)

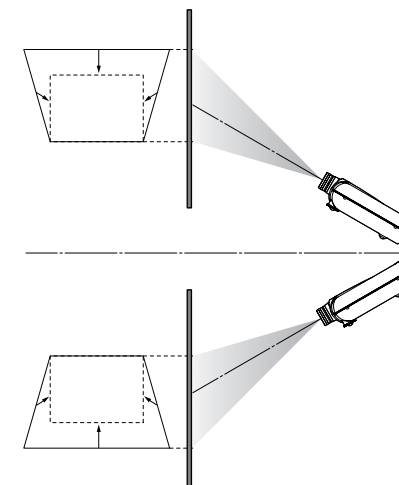

# INSTALLATION

## Recommended Setting

### ❖ Installing on a tabletop

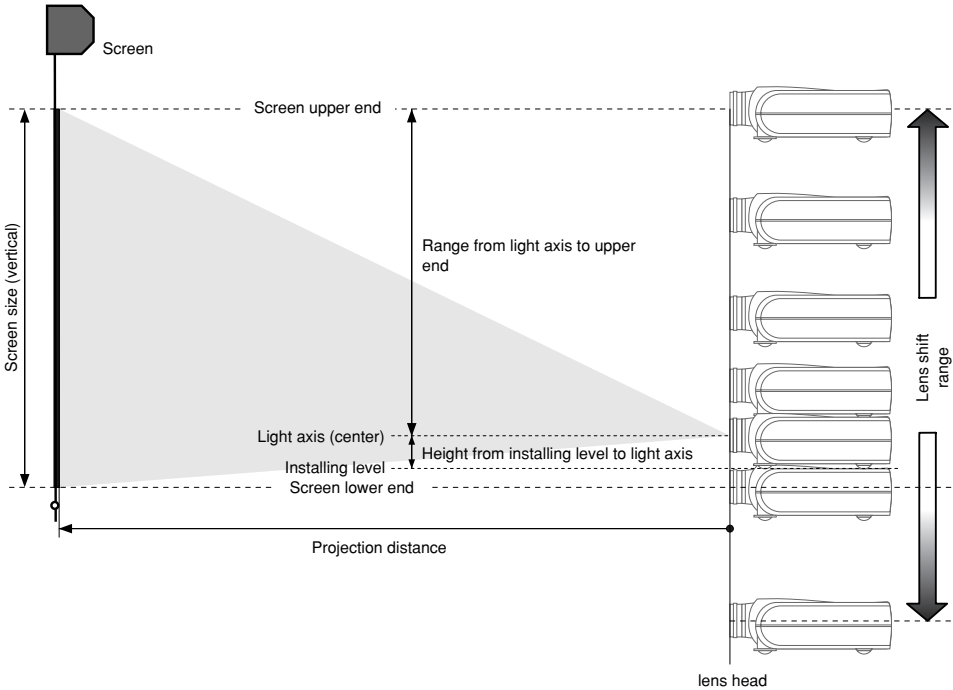

### ❖ Mounting on the ceiling

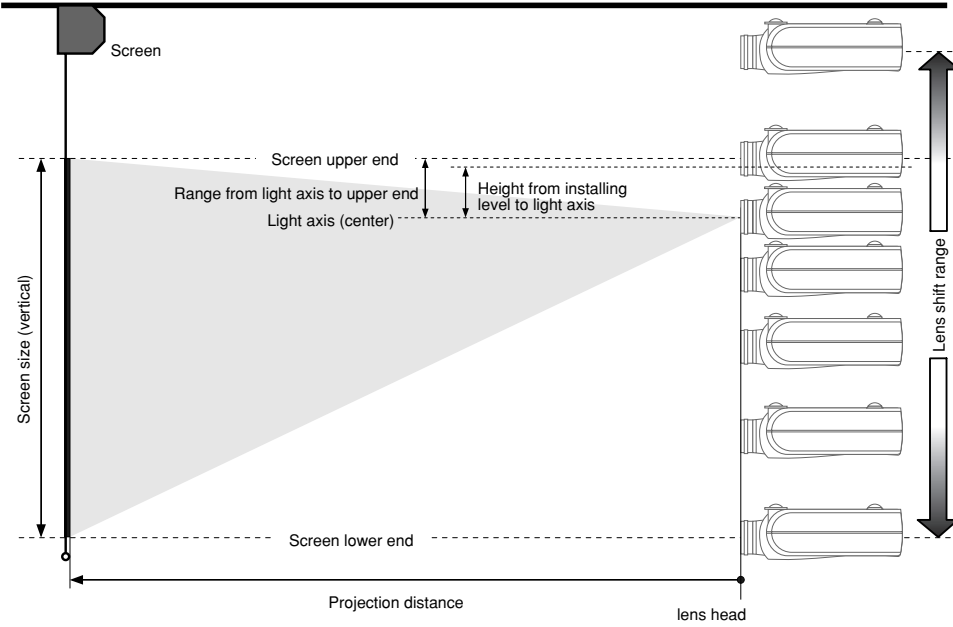

**CAUTION**  
 –For ceiling installation, consult with Marantz authorized dealer.  
 –Do not look into the lens when the projector is turned on. It could damage your eyesight.

## Screen Size and Projection Distance (inch) VP-12S4

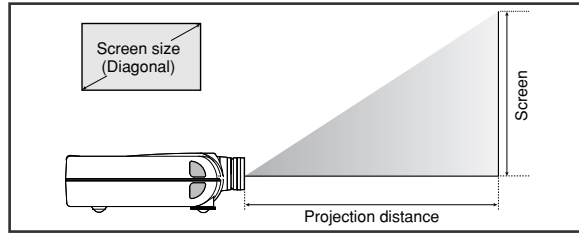

### ❖ 16 : 9 Screen

In case of displaying the 16:9 picture on the whole of the 16:9 screen.

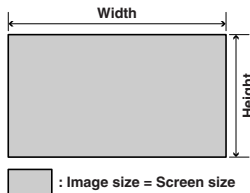

16:9 Screen Size (1.77:1 Aspect Ratio)			Projection Distance	
Diagonal	Width	Height	Minimum	Maximum
inch	inch	inch	inch	inch
60	52 5/16	29 7/16	89 9/16	130 13/16
70	61	34 5/16	104 13/16	152 15/16
72	62 3/4	35 5/16	107 14/16	157 3/8
80	69 3/4	39 1/4	120 2/16	175 1/16
82	71 1/2	40 3/16	123 3/16	179 1/2
84	73 3/16	41 3/16	126 3/16	183 15/16
90	78 7/16	44 1/8	135 6/16	197 3/16
92	80 3/16	45 1/8	138 7/16	201 5/8
100	87 3/16	49	150 10/16	219 5/16
106	92 3/8	51 15/16	159 13/16	232 5/8
110	95 7/8	53 15/16	165 15/16	241 7/16
120	104 9/16	58 13/16	181 3/16	263 9/16
123	107 3/16	60 5/16	185 13/16	270 1/4
133	115 15/16	65 3/16	201 1/16	292 3/8
135	117 11/16	66 3/16	204 2/16	296 3/4
150	130 3/4	73 9/16	227 1/16	329 15/16
170	148 3/16	83 6/16	257 9/16	374 1/4
200	174 5/16	98 1/16	303 7/16	440 5/8
250	217 7/8	122 9/16	379 13/16	551 1/4

To calculate the installation measurement (unit : inch)  
 Minimum = 1 1/2 x Screen Size - 1 7/8  
 Maximum = 2 3/16 x Screen Size - 1 15/16  
**Note : Tolerance ±5%**

### ❖ 4 : 3 Screen

In case of displaying the 16:9 picture on the whole of the 4:3 screen.

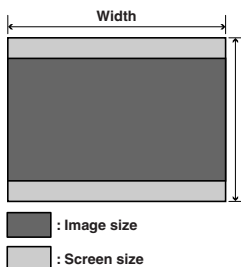

4:3 Screen Size (1.33:1 Aspect Ratio)			Projection Distance	
Diagonal	Width	Height	Minimum	Maximum
inch	inch	inch	inch	inch
60	48	36	82	119 15/16
70	56	42	96 1/16	140 1/4
72	57 5/8	43 3/16	98 7/8	144 5/16
80	64	48	110 1/16	160 9/16
84	67 3/16	50 3/8	115 11/16	168 11/16
90	72	54	124 1/16	180 7/8
100	80	60	138 1/8	201 3/16
110	88	66	152 1/8	221 1/2
120	96	72	166 1/8	241 13/16
150	120	90	208 3/16	302 11/16
170	136	102	236 1/4	343 5/16
180	144	108	250 1/4	363 5/8
200	160	120	278 5/16	404 1/4
250	200	150	348 7/16	505 13/16

To calculate the installation measurement (unit : inch)  
 Minimum = 1 3/8 x Screen Size - 1 7/8  
 Maximum = 2 x Screen Size - 1 15/16  
**Note : Tolerance ±5%**

## Screen Size and Projection Distance (mm) VP-12S4

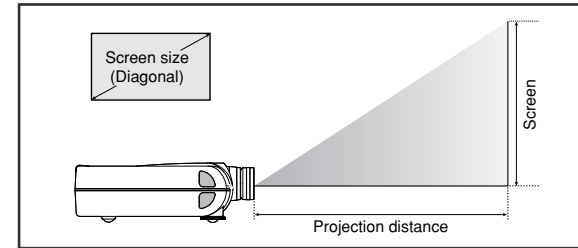

### ❖ 16 : 9 Screen

In case of displaying the 16:9 picture on the whole of the 16:9 screen.

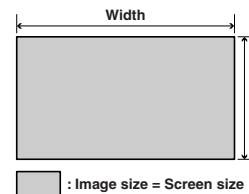

16:9 Screen Size (1.77:1 Aspect Ratio)			Projection Distance	
Diagonal	Width	Height	Minimum	Maximum
inch	mm	mm	mm	mm
60	1328	747	2275	3323
70	1550	872	2663	3885
72	1594	897	2740	3998
80	1771	996	3051	4447
82	1815	1021	3128	4560
84	1860	1046	3206	4672
90	1992	1121	3439	5009
92	2037	1146	3516	5122
100	2214	1245	3827	5571
106	2347	1320	4059	5908
110	2435	1370	4215	6133
120	2657	1494	4603	6695
123	2723	1532	4719	6864
133	2944	1656	5107	7426
135	2989	1681	5185	7538
150	3321	1868	5767	8381
170	3763	2117	6543	9505
200	4428	2491	7707	11191
250	5535	3113	9647	14001

To calculate the installation measurement (unit : mm)  
 Minimum = 38.8 x Screen Size - 53.4  
 Maximum = 56.2 x Screen Size - 48.8  
**Note : Tolerance ±5%**

### ❖ 4 : 3 Screen

In case of displaying the 16:9 picture on the whole of the 4:3 screen.

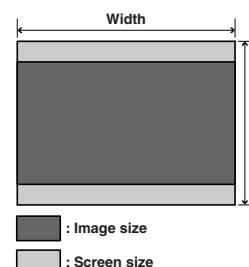

4:3 Screen Size (1.33:1 Aspect Ratio)			Projection Distance	
Diagonal	Width	Height	Minimum	Maximum
inch	mm	mm	mm	mm
60	1219	914	2083	3046
70	1422	1067	2440	3562
72	1463	1097	2511	3665
80	1626	1219	2796	4078
84	1707	1280	2938	4284
90	1829	1372	3152	4594
100	2032	1524	3508	5110
110	2235	1676	3864	5626
120	2438	1829	4220	6141
150	3048	2286	5289	7689
170	3454	2591	6001	8721
180	3658	2743	6357	9236
200	4064	3048	7069	10268
250	5080	3810	8850	12847

To calculate the installation measurement (unit : mm)  
 Minimum = 35.61 x Screen Size - 53.4  
 Maximum = 51.58 x Screen Size - 48.8  
**Note : Tolerance ±5%**

## Lens shift position

### ❖ Standard condition (From -100% to +170%)

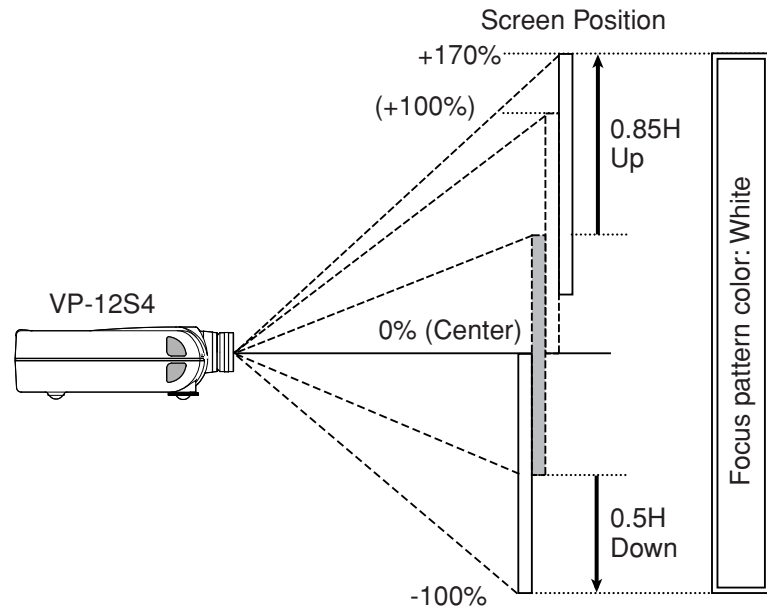

### ❖ Extended mounting condition (From +170% to +200%)

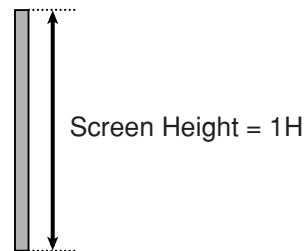
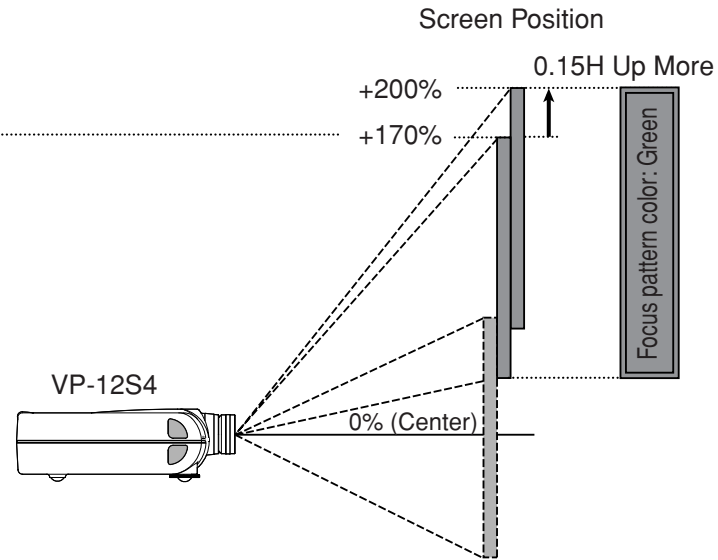

### About Extended mounting conditions

The VP-12S4 has a very flexible lens shift arrangement that allows mounting the projector above the screen possibly eliminating the need for a mounting pole. For the VP-12S4 the projector can be mounted 15% of the height of the screen(=0.15H)\* above the top of the viewable portion. For extended mounting conditions, the lens can be shifted even farther (170% → 200%). However if these values are used, optical performance may suffer slightly. This could manifest itself as chromatic aberration (minor color fringing) and/or geometric distortion.

If the projector is used in the extended mounting conditions, the focus pattern will be displayed in Green.

\*the height of the screen=1H

# BASIC OPERATIONS

## Turning on the Power

Press the **ON** button on the remote controller or the  / I button on the projector. The ON indicator lights up.

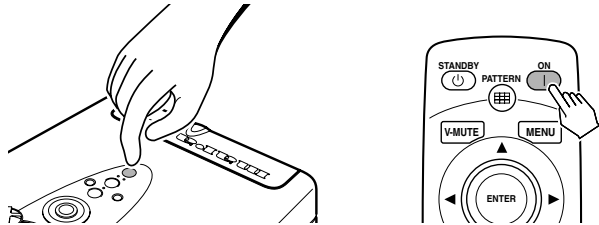

## Selecting the Input Signal Source

Switch to the equipment connected to the projector. Pressing the **INPUT** button on the projector or remote control rotates the input signal in the order of COMPONENT1 → COMPONENT2 → S-VIDEO → VIDEO → RGB → HDMI 1 → HDMI 2, allowing you to select an input signal. An input signal can also be directly selected by pressing one of the **COMP.1**, **COMP.2**, **S-VIDEO**, **VIDEO**, **RGB**, **HDMI 1** and **HDMI 2** buttons on the remote control.

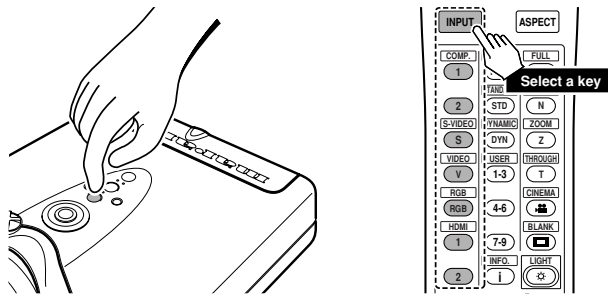

## Selecting the Aspect Mode

You can select 4 kinds of ASPECT mode using remote controller. Pressing the **ASPECT** button on the remote control rotates the aspect ratio in the order of FULL → NORMAL → ZOOM → THROUGH, allowing you to select an aspect ratio. An aspect ratio can also be directly selected by pressing one of the **FULL**, **NORMAL**, **ZOOM** and **THROUGH** buttons on the remote control, or it can be selected from the menu. (P.19)

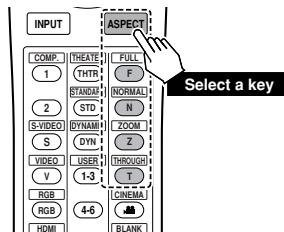

## The Screen Images in a 16:9 screen

- Press the **ZOOM** button, the **NORMAL** button or the **FULL** button on the remote controller for the 4:3 aspect ratio video source.
- Press the **FULL** button on the remote controller for 16:9 aspect ratio video source, such as 1080i, 1035i, and 720p video systems.
- Press the **FULL** button on the remote controller for the squeezed video source.

### ❖ Original Source Image

16 : 9 video source

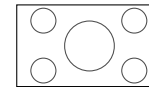

4 : 3 video source

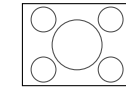

### ❖ Full mode

The 16:9 squeezed image is displayed with the correct aspect.

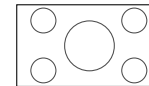

The 4:3 image is enlarged horizontally.

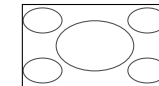

### ❖ Normal mode

The picture in normal ratio 4:3 is displayed.

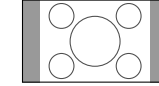
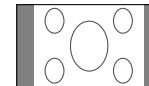

### ❖ Zoom mode

The picture in normal ratio 4:3 is enlarged vertically and horizontally (with same ratio) to the screen size

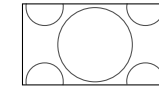
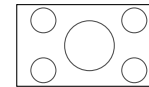

### ❖ Through mode

It shows an image when the video source has the same resolution to RGB/video signal with 720 or less vertical pixel number.

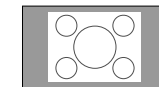
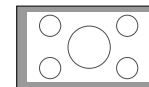

## The Screen Images in a 4:3 screen

- Press the **ZOOM** button, the **NORMAL** button or the **FULL** button on the remote controller for the 4:3 aspect ratio video source.
- Press the **FULL** button on the remote controller for 16:9 aspect ratio video source, such as 1080i, 1035i, and 720p video systems.
- Press the **FULL** button on the remote controller for the squeezed video source.

### ❖ Original Source Image

16 : 9 video source

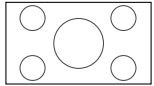

4 : 3 video source

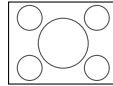

### ❖ Full mode

The 16:9 squeezed image is displayed with the correct aspect.

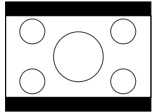

The 4:3 image is enlarged horizontally.

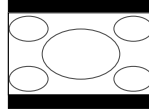

### ❖ Normal mode

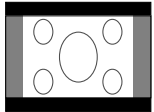

The picture in normal ratio 4:3 is displayed.

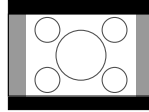

### ❖ Zoom mode

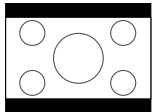

The picture in normal ratio 4:3 is enlarged vertically and horizontally (with same ratio) to the screen size

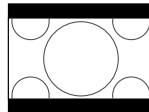

### ❖ Through mode

It shows an image when the video source has the same resolution to RGB/video signal with 720 or less vertical pixel number.

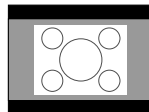
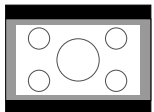

## To Turn off the Power

1. Press the **STANDBY** button on the remote controller or the  $\text{⏻}$  / **I** button on the projector.
2. The fan continues running for about 1 minute to internally cool the projector. In the meantime, the ON indicator on the projector flashes a blue color and buttons on the projector and remote control are irresponsive to touch. Once the fan stops, the ON indicator goes out and the STANDBY indicator lights up a red color to indicate the projector is on standby.

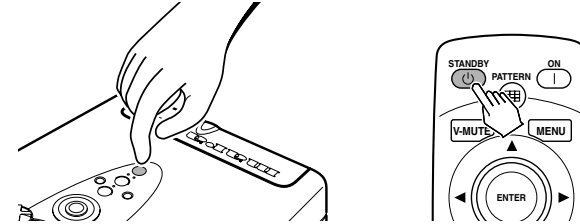

### Notes :

- Do not pull out the AC power cord until the projector turns in standby mode.
- Do not pull out the power cord suddenly in the state of "POWER ON." It can cause a breakdown.
- When a WARNING indicator lit up or blinks in red, pull out the AC power cord after checking that the fan has stopped.
- The projector will not be turned on if the **ON** button on the remote controller or the  $\text{⏻}$  / **I** button on the projector is pressed immediately after turning off. Press the **ON** button on the remote controller or  $\text{⏻}$  / **I** button on the projector after the projector turns into standby mode.
- When on standby, power to the projector is not OFF completely. If not planning to use the projector for an extended period of time, unplug the AC power cord from AC power outlet as explained above.

# OPERATIONS

## Menu Structure

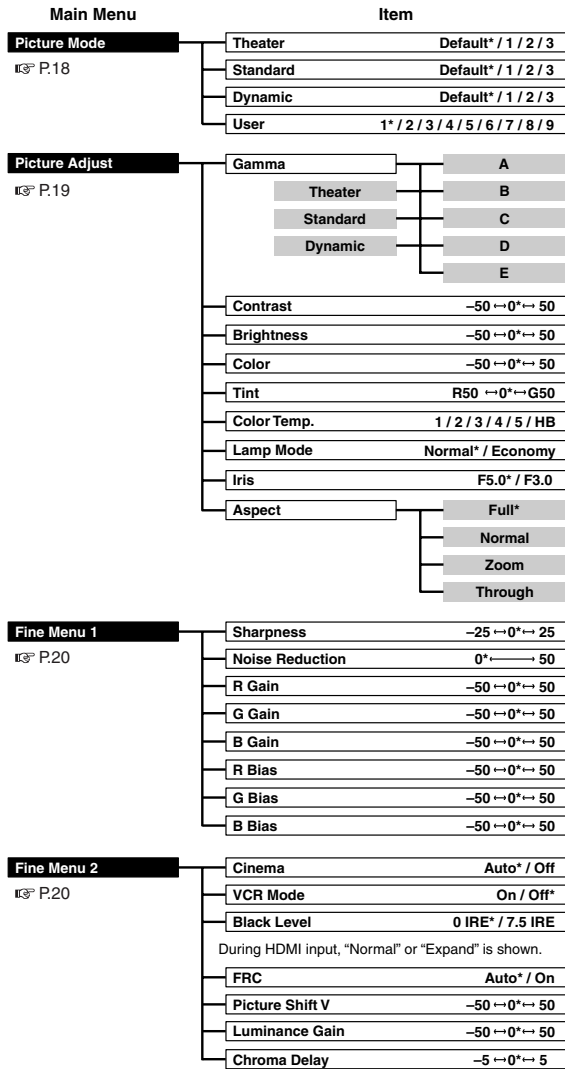

\* Default setting

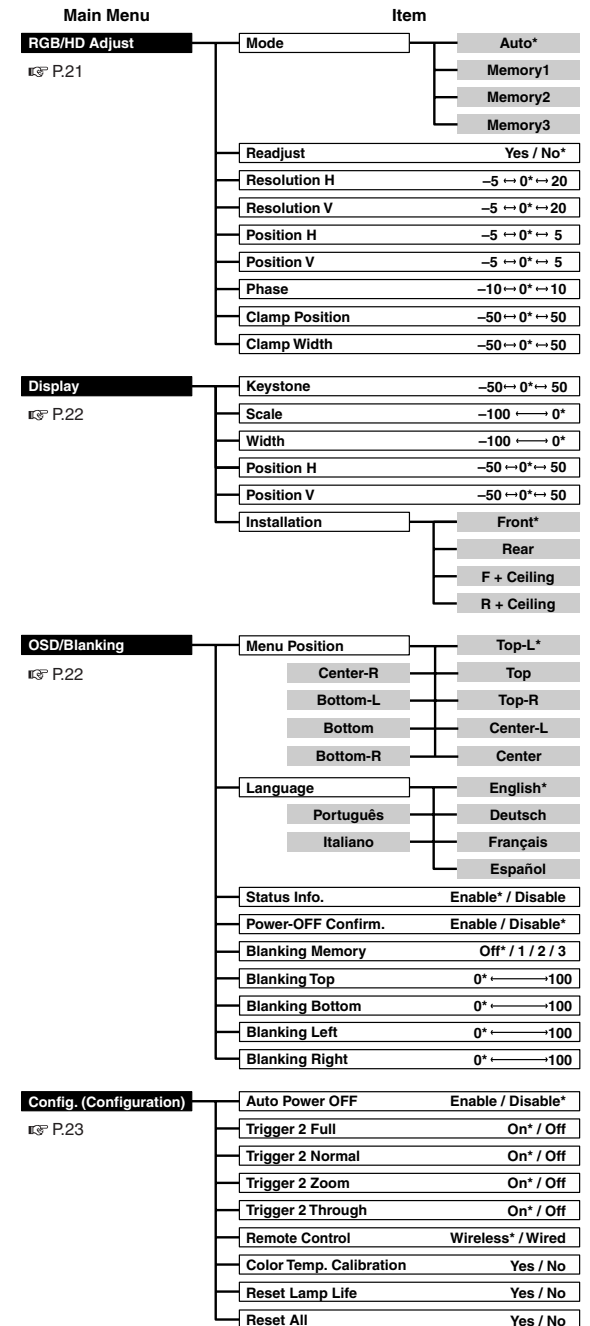
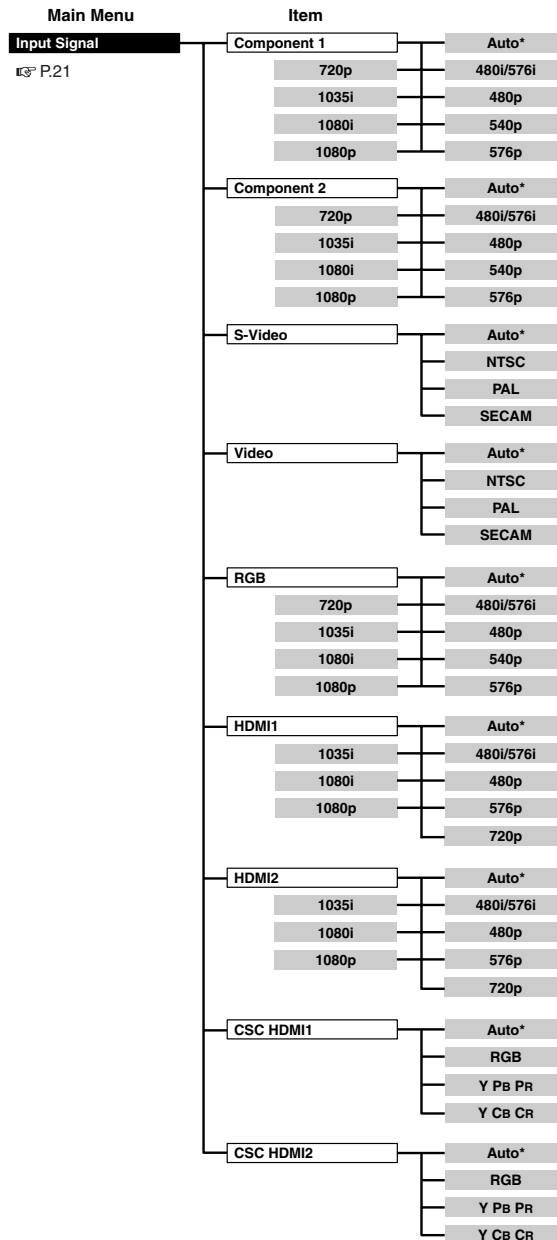

## Picture Mode

This unit has four picture modes: Theater, Standard, Dynamic and User. The picture quality recommended by Marantz is already set for each mode. The User mode has eight gamma curves that can be chosen and saved by users. Also, the Theater, Standard and Dynamic modes three indexes for memorizing picture quality adjustments. Similarly, the User mode has nine, making a total of 18 indexes available for use.

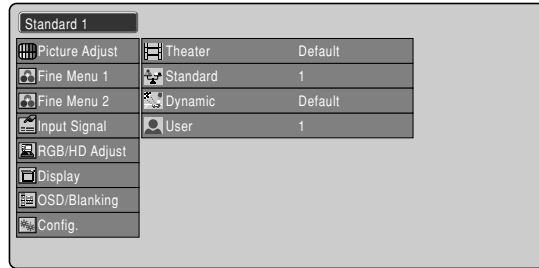

Picture mode	Index
Theater	Default, 1, 2, 3
Standard	Default, 1, 2, 3
Dynamic	Default, 1, 2, 3
User	1, 2, 3, 4, 5, 6, 7, 8, 9

- **Theater:** Reproduces the black suited for movie software.
- **Standard:** Suited for normal movie software.
- **Dynamic:** Suited for visually dynamic image software.
- **User 1-9:** Enable the user to adjust the gamma curve as preferred. (P.19).

### Picture mode selection

There are two ways to select the Picture mode: selecting a mode from the MENU screen or pressing the picture mode buttons (**THEATER, STANDARD, DYNAMIC** or **USER**) on the remote controller. To use the remote controller buttons to select a picture mode, make sure the MENU screen does not appear on the screen and press the desired picture mode button any number of times. (P.6)

To select an picture mode from the menu, do as follows.

1. Press the **MENU** button. The MENU screen appears on the screen.
2. Use the **▲** and **▼** buttons to select "Picture Mode" along the top of the menu.
3. Press the **ENTER** button to display the picture mode selection screen. Use the **▲**, **▼**, **▶** and **◀** buttons to select an picture mode.
4. Press the **ENTER** button to decide the selected picture mode. Once the mode has been entered, the screen returns to the previous menu.

### Memorizing settings in an index

The settings made in "Picture Adjust" and "Fine Menu 1" of the main menu are automatically memorized in the currently selected picture mode. Therefore, first select an picture mode and index, and then make settings.

**Note :** When default is selected, "Picture Adjust" and "Fine Menu 1" cannot be selected from the menu.

## How to Operate Menus

This projector has menus that make setting and adjustment easy.

1. Press the **MENU** button. The MENU screen appears on the screen.

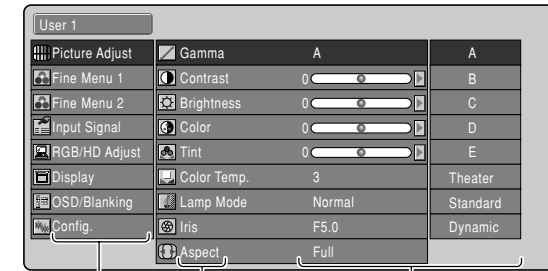

Main menu      Menu item      Setting or adjustment level

2. Use the **▲** and **▼** buttons to select a menu (Picture Adjust, Fine Menu 1, Fine Menu 2, Input Signal, RGB/HD Adjust, Display, OSD/Blanking, Config) and press the **▶** button.  
For image mode selection, see "Picture Mode". (P.18)
3. Use the **▲** and **▼** buttons to select a menu item and press the **▶** button.
4. Use the **▲**, **▼**, **◀** and **▶** buttons to make the setting or adjustment of the selected item.
  - The current setting or adjustment level is displayed to the right of each menu item.
5. Press the **MENU** button again to close the menu.

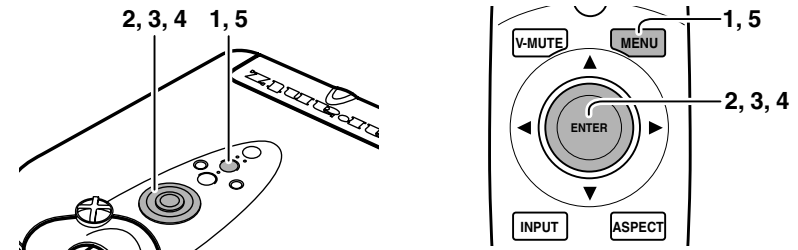

### - Adjustment bar

When there is a "▶" right of a menu item, this **▶** acts as a button for engaging an adjustment mode. In the adjustment mode, the menu disappears and only an adjustment bar, like that shown below, appears along the bottom of the display. Use the **◀** and **▶** buttons to adjust the item to the desired level. Press the **▲** button to return to the menu.





## Picture Adjust

Picture quality in each of the picture modes can be adjusted to your liking and those adjustments can be saved in memory.

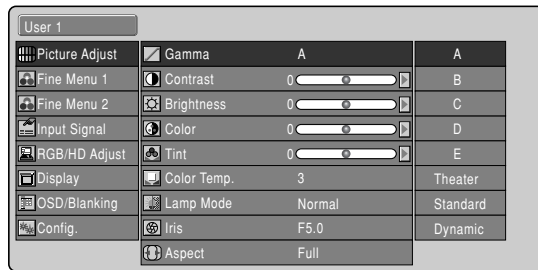

Item	Adjustments
<b>Gamma</b>	<b>A, B, C, D, E, Theater, Standard, Dynamic</b>
<b>Contrast</b>	<b>-50 ↔ 0 ↔ 50</b> (Weak) (Default) (Strong)
<b>Brightness</b>	<b>-50 ↔ 0 ↔ 50</b> (Dark) (Default) (Bright)
<b>Color</b>	<b>-50 ↔ 0 ↔ 50</b> (Light) (Default) (Deep)
<b>Tint</b>	<b>R50 ↔ 0 ↔ G50</b> (Purple) (Default) (Green)
<b>Color Temp. (Color Temperature)</b>	<b>1 2 3 4 5 HB</b> (Red) ↔ (Blue)
<b>Lamp Mode</b>	<b>Normal, Economy</b>
<b>Iris</b>	<b>F5.0, F3.0</b> Sets the lens aperture. F5.0: Use to prioritize contrast. F3.0: Use to prioritize brightness.
<b>Aspect</b>	<b>Full, Normal, Zoom, Through</b>

### - Gamma setting

To change the type of Gamma curve, set the Picture Mode (P.18) to User (1 – 9). Select “Gamma” and the desired gamma curve (A, B, C, D, E, Theater, Standard, Dynamic).

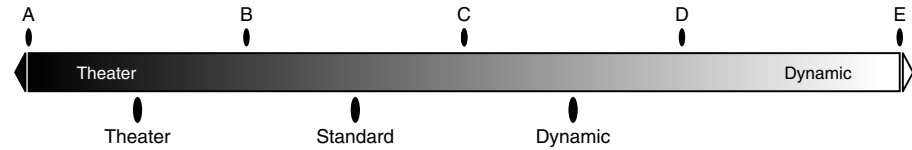

### - Color Temp. (Color Temperature)

- 1 : Red comes out strong. Color temperature is about 5250 K.
- 2 : Red is mildly strong. Color temperature is about 5800 K.
- 3 : Normal. Color temperature is about 6500 K.
- 4 : Blue is mildly strong. Color temperature is about 7500 K.
- 5 : Blue comes out strong. Color temperature is about 9300 K.
- HB : High Bright : Display brightest image.

#### NOTES:

- To adjust picture quality, set the index to 1 - 3. See “Picture Mode”. (P.18)
- The Gamma cannot be set unless User (1 - 9) is set for the Picture Mode (P.18).
- Tint cannot be adjusted for component input, HDMI input or PAL signals.
- The settings made in Picture Adjust are saved in the currently selected Picture Mode index.

## Fine Menu 1

By adjusting this Fine Menu, you can make fine picture adjustment.

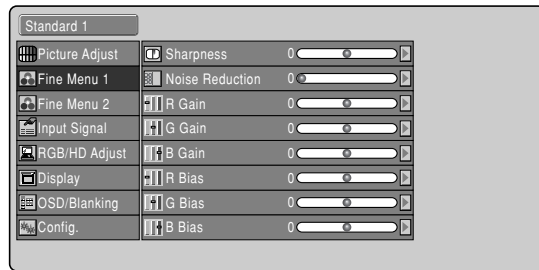

Item	Adjustments
<b>Sharpness</b>	-25 ↔ 0 ↔ 25
<b>Noise Reduction</b>	0 ↔ 50
<b>R Gain</b>	-50 ↔ 0 ↔ 50
<b>G Gain</b>	-50 ↔ 0 ↔ 50
<b>B Gain</b>	-50 ↔ 0 ↔ 50
<b>R Bias</b>	-50 ↔ 0 ↔ 50
<b>G Bias</b>	-50 ↔ 0 ↔ 50
<b>B Bias</b>	-50 ↔ 0 ↔ 50

- **Sharpness**  
Adjust the sharpness.
- **Noise Reduction**  
Adjust the noise reduction.
- **R Gain**  
This menu allows the users to set the gain for red.
- **G Gain**  
This menu allows the users to set the gain for green.
- **B Gain**  
This menu allows the users to set the gain for blue.
- **R Bias**  
This menu allows the users to set the bias for red.
- **G Bias**  
This menu allows the users to set the bias for green.
- **B Bias**  
This menu allows the users to set the bias for blue.

**Note :**

- The settings made in Fine Menu 1 are saved in the currently selected Picture Mode index (Default excluded).

## Fine Menu 2

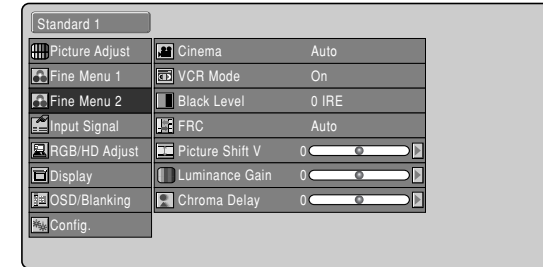

Item	Adjustments
<b>Cinema</b>	Auto, Off
<b>VCR Mode</b>	On, Off
<b>Black level</b>	0 IRE, 7.5 IRE /Normal, Expand (For HDMI input)
<b>FRC</b>	Auto, On
<b>Picture Shift V</b>	-50 ↔ 0 ↔ 50
<b>Luminance Gain</b>	-50 ↔ 0 ↔ 50
<b>Chroma Delay</b>	-5 ↔ 0 ↔ 5

- **Cinema**  
Auto : Automatically selects the cinema mode when a video signal is input.  
NTSC: 3-2 pull down, PAL: 2-2 pull down  
Off : Pull-down processing is not performed.
- **VCR Mode**  
On : A projector is forced into the intra-field only deinterlacing mode.  
Off : A projector is used with external field memories and operates in the full set of deinterlacing modes, i.e., motion adaptive video deinterlacing and full frame film source deinterlacing using 3:2 pulldown detection (2:2 pulldown for 625/50 sources).
- **Black level**  
Select the black level by a video source.
- **FRC (Frame Rate Conversion)**  
Auto : Frame Rate Conversion function is basically off. However FRC turns on automatically depending on vertical frequency of input signal.  
On : Frame Rate Conversion function is "On". (60Hz fixed)
- **Picture Shift V**  
When Aspect on the Picture Adjust menu is set to "Zoom", this setting allows the user to move the projected image vertically in order to see parts on the image not appearing on the screen.
- **Luminance Gain**  
This menu allows the users to set the luminance gain.
- **Chroma Delay**  
This menu allows the users to set the chrominance delay.

**Notes :**

- There are some parameters can not adjust according to input signal.
- The settings made in Fine Menu 2 are saved in each currently selected input signal source.

## Input Signal

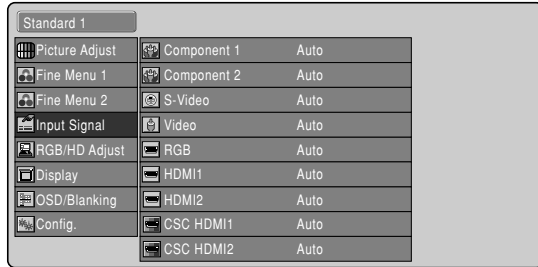

Item	Adjustments
Component1, Component2	Auto, 480i/576i, 480p, 540p, 576p, 720p, 1035i, 1080i, 1080p
S-Video	Auto, NTSC, PAL, SECAM
Video	Auto, NTSC, PAL, SECAM
RGB	Auto, 480i/576i, 480p, 540p, 576p, 720p, 1035i, 1080i, 1080p
HDMI 1, HDMI 2	Auto, 480i/576i, 480p, 576p, 720p, 1035i, 1080i, 1080p
CSC HDMI 1, CSC HDMI 2	Auto, RGB, YP <sub>B</sub> Pr, YC <sub>B</sub> Cr Color space conversion select for HDMI input. RGB: Color Space Conversion is skipped. YP <sub>B</sub> Pr: This mode is suitable for HD TV signal such a 720p, 1080i. YC <sub>B</sub> Cr: This mode is suitable for SD TV signal such a 480i, 480p.

### NTSC(NTSC-3.58)

: Conventional analog broadcasting used mainly in USA, Canada, Taiwan, Korea, and Japan.

### PAL(PAL-4.43)

: Conventional analog broadcasting used mainly in United Kingdom and Germany.

### SECAM

: Conventional analog broadcasting used mainly in France and Russia.

### 480p

: Standard digital broadcasting

### 540p

: Special digital broadcasting (for example: RCA DTC100)

### 576p

: Standard digital broadcasting

### 720p, 1080p

: High Definition digital broadcasting

### 1035i

: Japanese "Hi-Vision" broadcasting

## RGB/HD Adjust

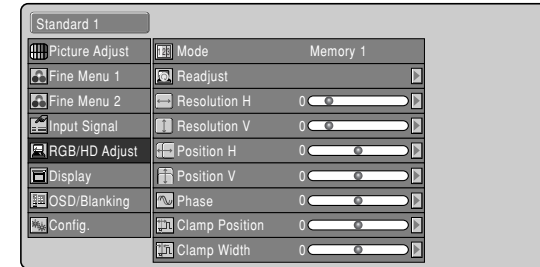

Item	Adjustments
Mode	Auto, Memory 1, Memory 2, Memory 3
Readjust	Yes, No
Resolution H	-5 ↔ 0 ↔ 20 (Small) (Default) (Large)
Resolution V	-5 ↔ 0 ↔ 20 (Small) (Default) (Large)
Position H	-5 ↔ 0 ↔ 5 (Left) (Default) (Right)
Position V	-5 ↔ 0 ↔ 5 (Down) (Default) (Up)
Phase	-10 ↔ 0 ↔ 10 (Backward) (Default) (Forward)
Clamp Position	-50 ↔ 0 ↔ 50 (Backward) (Default) (Forward)
Clamp Width	-50 ↔ 0 ↔ 50 (Small) (Default) (Large)

### - Mode

Auto:

Each item is adjusted automatically.

Memory1-3:

If something wrong with Auto Adjust, select Memory, please adjust each item manually.

### - Readjust

Select to readjust settings automatically for each item in this menu.

### - Resolution H, V

Adjusts the horizontal and vertical resolution of the RGB/HD input signals.

### - Position H, V

Adjust the position of the input signal. H adjusts the horizontal position of the input signal. V adjusts the vertical position of the input signal.

### - Phase

Adjust the phase of the DMD dots and the computer signal input from the RGB IN. Adjust the picture to where it looks clearest.

### - Clamp Position, Width

Adjusts the clamp position and width used in RGB/HD input.

## Display

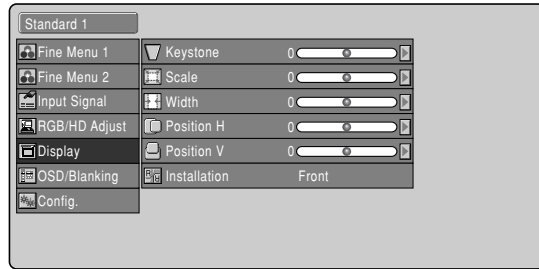

Item	Adjustments
<b>Keystone (Electronic vertical keystone correction)</b>	-50 ↔ 0 ↔ 50 ( ▽ ) ( □ ) ( ▲ )
<b>Scale</b>	-100 ↔ 0 (Min) (Max)
<b>Width</b>	-100 ↔ 0 (Min) (Max)
<b>Position H</b>	-50 ↔ 0 ↔ 50 (Left) (Default) (Right)
<b>Position V</b>	-50 ↔ 0 ↔ 50 (Down) (Default) (Up)
<b>Installation</b>	<b>Front, Rear, F+Ceiling, R+Ceiling</b>

### – Keystone

Adjust trapezoid image to rectangle image.

### – Scale

Reduces the image without changing the aspect ratio. The image can be reduced to about 70% the original size.

### – Width

Reduces the image width without changing the image height. The width can be reduced to about 75% the original size.

### – Position H, V

Adjust the position of the input signal. H adjusts the horizontal position of the input signal. V adjusts the vertical position of the input signal.

However, when Scale and Width are set to their default settings, the picture position cannot be adjusted.

### – Installation

Sets the installation mode of the projector.

Front: Select to set the projector on a tabletop and project from in front of the screen.

Rear: Select to set the projector on a tabletop and project from behind the screen.

F + Ceiling: Select to mount the projector on the ceiling and project from in front of the screen.

R + Ceiling: Select to mount the projector on the ceiling and project from behind the screen.

## OSD/Blanking

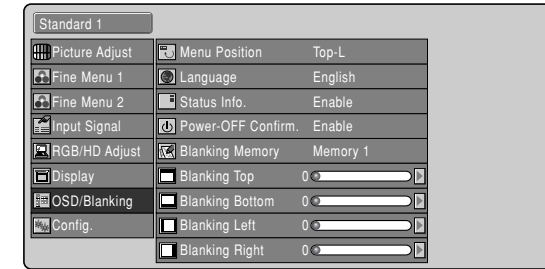

Item	Adjustments
<b>Menu Position</b>	<b>Top-L, Top, Top-R, Center-L, Center, Center-R, Bottom-L, Bottom, Bottom-R</b>
<b>Language</b>	<b>English, Deutsch, Français, Español, Português, Italiano</b>
<b>Status Info.</b>	<b>Enable, Disable</b>
<b>Power-OFF Confirm.</b>	<b>Enable, Disable</b>
<b>Blanking Memory</b>	<b>Off, Memory 1, Memory 2, Memory 3</b>
<b>Blanking Top</b>	<b>0 ↔ 100</b>
<b>Blanking Bottom</b>	<b>0 ↔ 100</b>
<b>Blanking Left</b>	<b>0 ↔ 100</b>
<b>Blanking Right</b>	<b>0 ↔ 100</b>

### – Menu Position

OSD position is selected from 9 positions.

### – Status Info.

Enable: Displays the current status of the projector for a set amount of time in the upper right-hand corner of the screen at startup and whenever the Input Source, Picture Mode, Aspect ratio or other setting is changed.

Disable: Does not display Status Info.

### – Power-OFF Confirm.

Disable: Directly puts the projector on standby without displaying the confirmation message when power is shut off from the  $\cup$  button on the remote controller or the  $\cup$ /I button on the projector.

Enable: Displays a confirmation message asking whether to shut the power off or continue use when power is shut off from the  $\cup$  button on the remote controller or the  $\cup$ /I button on the projector. To shut off the power immediately, select "Yes" and press the **ENTER** button. To not shut off the power, select "No" and press the **ENTER** button.

### – Blanking Memory

Sets the blanking mode with which part of the screen can be hidden in black bands. To use this mode or change the setting, select from Memory 1 to 3.

Off: Turns the blanking mode off. No masking occurs.

Memory 1-3: Memorize the blanking width of the top, bottom, left and right masks set with the below features. Up to three settings can be memorized.

### – Blanking Top, Bottom, Left and Right

Set the blanking width of the top, bottom, left and right masks, which are then memorized in Memory 1 – 3 of Blanking Memory. Each can be set from 0 (no mask) to a maximum 100.

## Configuration

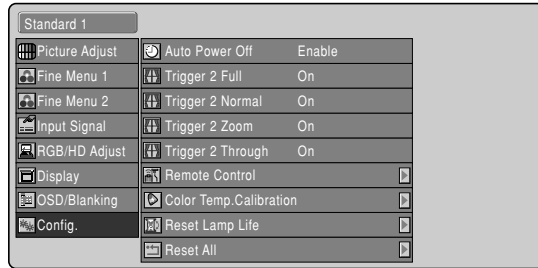

Item	Adjustments
Auto Power Off	Enable, Disable
Trigger 2 Full	On, Off
Trigger 2 Normal	On, Off
Trigger 2 Zoom	On, Off
Trigger 2 Through	On, Off
Remote Control	Wireless, Wired
Color Temp. Calibration	Yes, No
Reset Lamp Life	Yes, No
Reset All	Yes, No

### - Auto Power Off

When the auto power off feature is set to Enable, power to the projector automatically shuts off if no signals are received and no operations are performed for about 10 consecutive minutes. If 9 minutes pass without the projector receiving any signals or being operated in anyway, the below message appears on the screen.

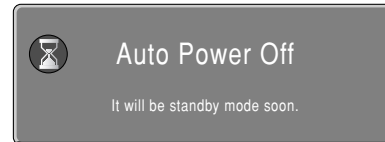

About 1 minute after the message appears on the screen, power to the projector shuts off.

#### Note:

After the above message appears on the screen, pressing any button on the projector or remote control other than the **⏻ / I** button on the projector and the **ON** or **STANDBY** buttons on the remote control resets the auto power off feature.

The auto power off feature will activate again if, after that, the projector goes without receiving any signals or being operated in anyway for 10 consecutive minutes.

### - Tigger 2

Select either 12V output or 0V output by choosing On or Off for each aspect mode. Full, Normal, Zoom, and Through.

This allows you to control such as a powered dual aspect screen with the outputs for the aspect modes.

**On:** Output DC 12V.

**Off:** No output.

### - Remote Control

**Wireless:** Set to use the included remote controller.

**Wired:** Set to control the projector from either Marantz's AV components connected to the REMOTE CONTROL IN/OUT terminals or a PC or other device connected to the RS-232C terminal of the projector. The included remote controller cannot be used in this case.

When this item is selected, a confirmation message appears asking whether to change the currently selected mode to the other mode or not. To change the mode, select "Yes" and press the **ENTER** button on the projector. To keep the same mode, select "No" and press the **ENTER** button.

#### Notes:

- To prevent misoperation, the **ENTER** button of the remote controller does not respond to touch when the Wired/Wireless setting is displayed. Press the **ENTER** button of the projector to enter the setting.
- To change from Wired to Wireless, set "Wireless" from the menu using the buttons of the projector.

### - Color Temp. Calibration

After replacing the lamp or in other cases where the lighting changes, color temperature can be adjusted using the color temperature sensor. For more information on how to adjust color temperature, see "Color Temperature Adjustment" (P.26).



### - Reset Lamp Life

If the lamp is replaced before reaching its 2000 hours lamp life, be sure to reset the lamp's life counter. To do this, select "Reset Lamp Life" from the Configuration menu. When the user selects this item, the following message appears:

Select "Yes", and press the **ENTER** button. Then the lamp life is initialized.

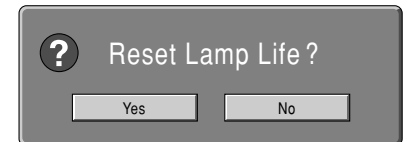

### - Reset All

All settings are reset to the factory default settings except the lamp life.

When the user selects this item, the following message appears:

Select "Yes", and press the **ENTER** button.



# MAINTENANCE

## Lamp Life and Replace Lamp

### ❖ Lamp Life

Display the remaining lamp life by pressing the **INFO.** button on the remote controller.

i Information	
Video Input	Component 2 -480p
Picture Mode	User 1
Gamma	A
Aspect	Normal
Lamp Mode	Economy
Iris	F5.0
Lamp Life	921 Hours
Total Time	3653 Hours

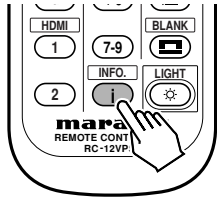

#### Notes:

- The maximum life limit of the lamp is 2,000 hours. Although we care very much about quality, the lamp can rarely break down if running time exceeds 1,000 hours. Therefore we recommend to replace the lamp if Lamp Life gets under 1,000 hours. The lamp cannot be used exceeding the maximum life limit.
- This product is checked under strict quality control when it is shipped out from factory. "Total Hours" in the menu includes the time for this check. So "Total Hours" may not be 0 hours when it is used first time.

- When the lamp life becomes less than 100 hours and the unit is still on, the remaining lamp life is displayed on the screen automatically.

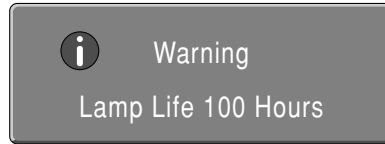

- When the lamp life becomes less than 5 hours, the remaining lamp life is displayed on the screen.

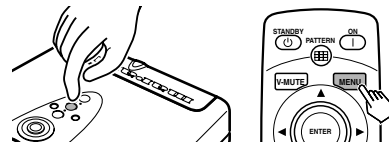
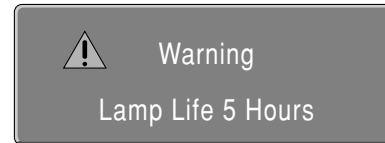

To clear the warning, press the **MENU** button.

- Approximately 2 minutes after the lamp reaches the end of its lamp life, power to the projector shuts OFF and the WARNING indicator lights up a red color. If the below message appears on the screen and power shuts OFF soon thereafter, promptly replace the lamp with a new one. (See "Replacing Lamp Unit" P.24)



### ❖ Initialize the Lamp Life

The lamp has a lamp life of 2000 hours. The projector is designed to shut OFF power if the lamp is used beyond this 2000 hours lamp life. In such case, replace the lamp and reset the lamp life counter as follows.

1. After the message "Lamp Life 0 Hours" appears, power to the projector shuts OFF. Promptly replace the lamp with a new one. (See P.24 "Replacing Lamp Unit")
2. Once the lamp has been replaced, press the **ON** button on the remote control or the **⏻ / I** button on the projector.

The below message appears on the screen for 120 seconds.

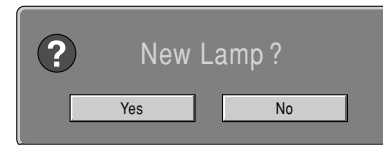

3. Select "Yes", using the **◀ / ▶** buttons.
4. Press the **ENTER** button. The lamp life indicator is now initialized.

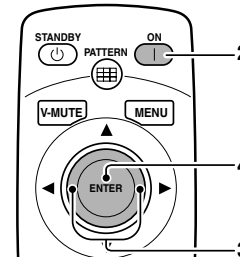
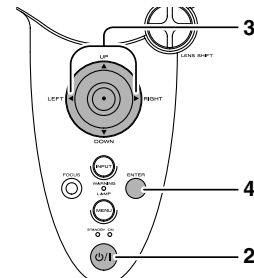

## Replacing Lamp Unit

#### CAUTION:

- Do not touch the lamp and the lamp unit carelessly. It is extremely hot. Wait at least one hour for the lamp to cool down before handling.
- Do not loosen any screws except for those mentioned below.
- The lamp may break if handled improperly.
- Do not use other than a Marantz replacement lamp unit.

### ❖ How to replace the Lamp Unit

#### PREPARATION:

When replacing the lamp, turn off the power for the projector. After the cooling fan stops, disconnect the power cord and wait for one hour until the lamp is cooled down completely, then replace the lamp.

1. Press the **STANDBY** button on the remote controller or the **⏻ / I** button on the projector to turn the projector off.

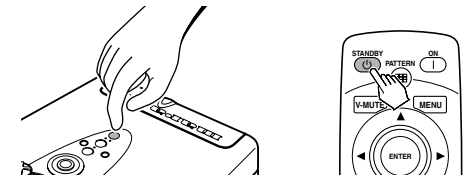

2. After the cooling fan stops, Unplug the AC power cord.

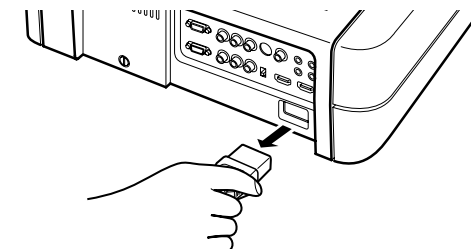

- Wait at the least one hour for the lamp and lamp unit to cool down.
- Read the caution and warning labels on the unit.

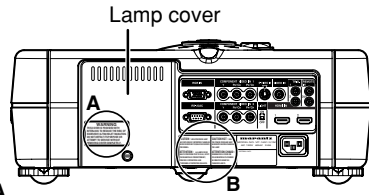

**A**

**For USA**

**WARNING**  
THIS COVER IS PROVIDED WITH INTERLOCK TO REDUCE THE RISK OF EXCESSIVE ULTRAVIOLET RADIATION. DO NOT DEFEAT ITS PURPOSE OR ATTEMPT TO SERVICE WITHOUT REMOVING COVER COMPLETELY.

**For Europe**

**CAUTION HOT**  
UNPLUG THE POWER CORD AND WAIT 60 MINUTES BEFORE CHANGING THE LAMP.

**ATTENTION CHAUD**  
DEBRANCER LE CORD ON D'ALIMENTATION ET ATENDER 60 MINUTES AVANT DE CHANGER LAMPE.

**WARNUNG HEISS**  
ZIEHEN SIE DEN NETZSTECKER AB UND WARTEN SIE 60 MINUTEN, BEVOR SIE DIE GLUHLAMPE WECHSELN.

**B**

<p><b>For USA</b></p> <p><b>CAUTION :</b> HIGH PRESSURE LAMP MAY EXPLODED IF IMPROPERLY HANDLED. REFER SERVICING TO QUALIFIED SERVICE PERSONNEL.</p> <p><b>ATTENTION :</b> LA LAMPE SOUS HAUTE PRESSION PEUT SI ELLE, N'EST PAS MANIPULEE CORRECTEMENT, CONFIER L'OPERATION A UN PERSONNEL D'ENTRETIEN QUALIFIE.</p>	<p><b>CAUTION HOT :</b> UNPLUG THE POWER CORD AND WAIT 60 MINUTES BEFORE CHARGING THE LAMP.</p> <p><b>ATTENTION CHAUD :</b> DEBRANCER LE CORD ON D'ALIMENTATION ET ATENDER 60 MINUTES AVANT DE CHANGER LAMPE.</p>
<p><b>For Europe</b></p> <p><b>CAUTION</b> HIGH PRESSURE LAMP MAY EXPLODED IF IMPROPERLY HANDLED. REFER SERVICING TO QUALIFIED SERVICE PERSONNEL.</p> <p><b>ATTENTION</b> LA LAMPE SOUS HAUTE PRESSION PEUT EXPLOSER SI ELLE, N'EST PAS MANIPULEE CORRECTEMENT. CONFIER L'OPERATION A UN PERSONNEL D'ENTRETIEN QUALIFIE.</p>	<p><b>VORSICHT :</b> BEI FALSCHER HANDHABUNG KANN DIE HOCHDRUCKLAMPE EXPLODIEREN UBERLASSEN SIE WARTUNGSARBEITEN NUR FACHPERSONAL.</p>

- Remove the lamp cover screw.

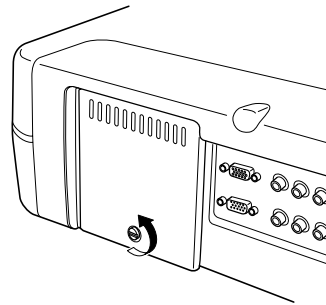

- Remove the lamp cover in the direction of the arrow.

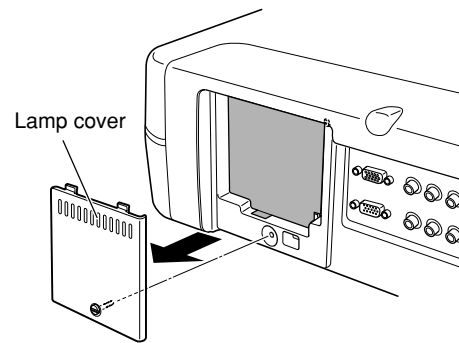

- Open the cover sheet and remove the two screws (slotted head screwdriver required) that lock down the lamp unit. Do not remove any other screws.

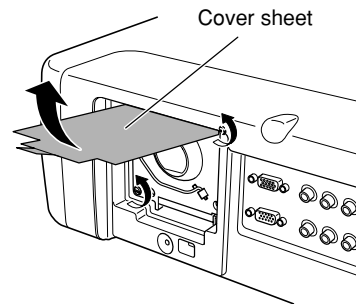

- Holding the handle and pull the lamp unit out toward your side.

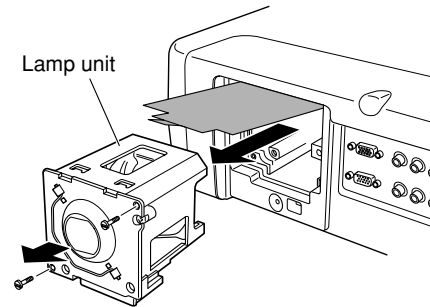

- Install a new lamp unit in position securely.

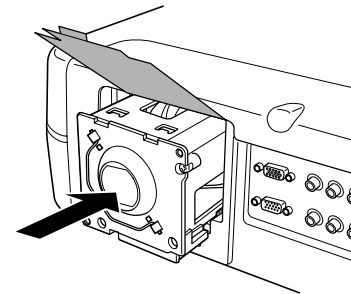

- Lock the lamp unit in place with the two screws removed in step 7. Press on the handle until it folds over and close the cover sheet.

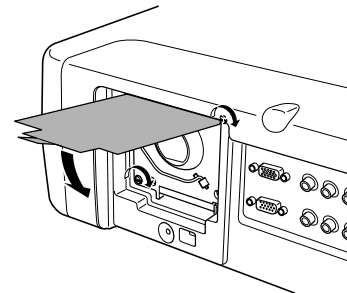

- Install the lamp cover back in its original position and fasten with the fastening screw.

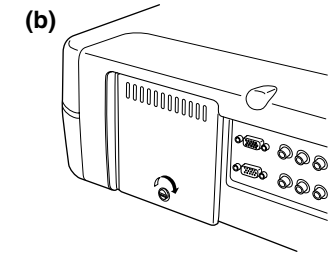
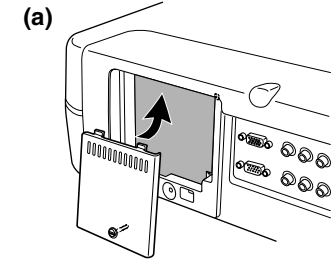

- Plug in the video projector and turn on the power and project the image.
  - If the lamp is replaced before reaching its 2000 hours lamp life, see "Reset Lamp Life" (P.23).
  - If the lamp is replaced after reaching its 2000 hours lamp life, see "Initialize the Lamp Life" (P.24).

## Color Temperature Adjustment

After replacing the lamp or in other cases where the lighting changes, color temperature can be adjusted using the color temperature sensor. In the adjustment procedure, you must first initialize the sensor itself before adjusting color temperature. It takes about 10 minutes from when the power to the projector is activated for the lamp's brightness to stabilize. Wait for lamp brightness to stabilize before adjusting color temperature.

1. Connect the cable of the color temperature sensor to the RS-232C port.

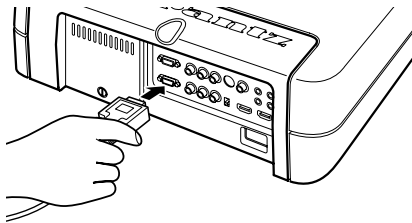

2. Press the **MENU** button and select "Color Temp. Calibration" from the MENU screen. Press the **▶** button. The below message appears on the screen.

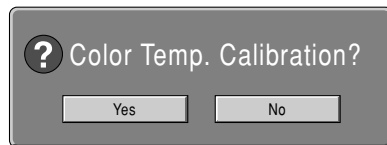

3. Use the **◀** and **▶** buttons to select "Yes" and press the **ENTER** button. The below message appears on the screen.

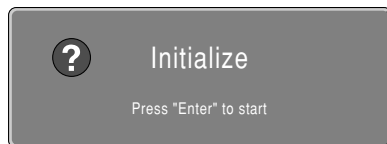

Before pressing the **ENTER** button, turn the color temperature sensor over on its dark side as shown in the below figure, to prevent outside light from penetrating to the sensor's condenser.

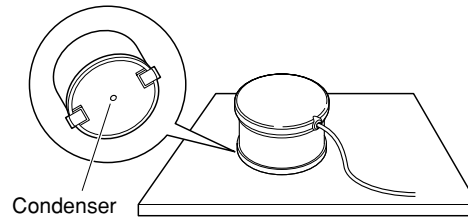

4. Press the **ENTER** button. The below message appears on the screen for a few seconds as the sensor is being calibrated.

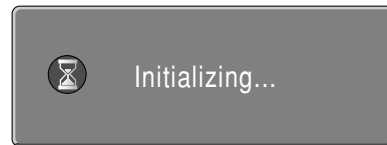

5. Position the lamp so that its light passes through the center of the lens. This is necessary in order to calibrate color temperature correctly. First, turn the lens shift knob all the way to the left so that the lens lowers to the lowest position. Then, turn it five and a half turns to the right to raise the lens. In this position, the light of the lamp passes almost through the center of the lens.

### Note:

Color temperature cannot be correctly calibrated unless the lens is properly positioned.

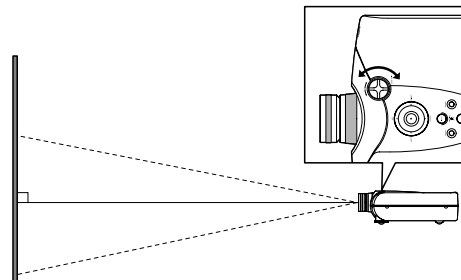

6. Fit the color temperature sensor onto the lens and press the **ENTER** button. Color temperature adjustment starts and the projector's **WARNING** and **STANDBY** indicators begin flashing simultaneously.

### When installed on a tabletop

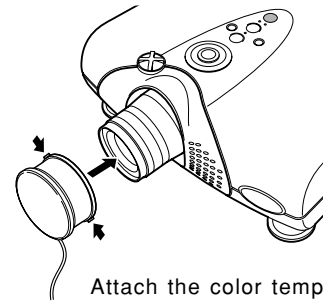

Attach the color temperature sensor so that the cable is to the bottom side of the projector.

### When installed on a ceiling

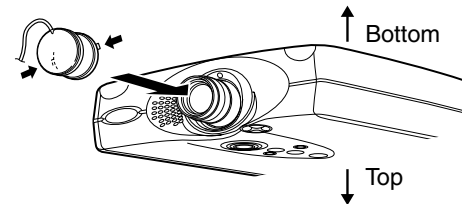

Attach the color temperature sensor so that the cable is to the bottom side of the projector.

7. When the **WARNING** and **STANDBY** indicators go out, color temperature adjustment is complete. Adjustment takes about 2 to 3 minutes. When the color temperature sensor is detached from the lens, the below message appears on the screen.

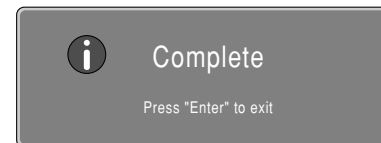

8. Press the **ENTER** button to return to the menu and disconnect the cable of the color temperature sensor from the projector.

### Note:

If color temperature adjustment is not correctly processed or if adjustment processing is interrupted in course by pressing the **MENU** button or for some other reason, the below message appears on the screen.



Also, adjustment processing can be interrupted by pressing the **MENU** button.

9. Turn the lens shift knob until returning the lens to the screen position you want to use.

## ❖ Color Temperature Sensor Protection

If no operations are performed for approximately 10 minutes from the moment color temperature adjustment processing ends, power to the projector shuts OFF automatically in order to protect the color temperature sensor. If power is shut OFF to protect the color temperature sensor, do the following.

### • If the **WARNING** indicator does not light

When color temperature adjustment ends successfully and the sensor protection feature trips, the projector goes on standby. As usual, activate power by pressing either the **ON** button on the remote control or the **⏻ / I** button on the projector.

### • If the **WARNING** indicator lights

If color temperature adjustment does not end successfully and the sensor protection feature trips, the projector's **WARNING** and **STANDBY** indicators light simultaneously to indicate the error mode. Unplug the power cable and then plug it back in. Then, press either the **ON** button on the remote control or the **⏻ / I** button on the projector to reactivate power.



## Cleaning the Lens

If the lens becomes dirty or smudged, clean it with a soft dry cloth only. Use optical lens cleaners that are approved for eyeglasses or cameras. Do not use a dampen cloth, detergent solution, or thinner. It may damage the lens and remain as stains.

## Replacement Parts

When replacement parts are required, be sure to inform a Marantz authorized service center. Use only replacement parts specified by Marantz. Unauthorized substitutions may result in fire, electric shock, or other hazards. And, the warranty may not be guaranteed.

## Optional Accessories

Lamp Unit : LU-12VPS3

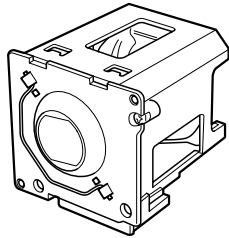

# TROUBLESHOOTING

Try the following troubleshooting before calling for service.

1. Are the connections made properly ?
2. Are you operating the unit properly, following the instructions ?

If the unit does not operate properly, check the items shown in the following table.

If any trouble cannot be solved by the instructions below, malfunction of the internal circuitry is suspected; immediately unplug the AC power cord and contact Marantz dealer or service center.

Symptom	Possible Cause	Remedy
<b>No power</b>	AC power cord is not connected correctly.	Connect the AC power cord properly.
	Lamp cover is not closed correctly.	Close the cover properly. (☞ P.25)
<b>Image is not displayed.</b>	A signal cable is not connected correctly.	Connect a signal cable properly.
	Selected input is incorrect.	Select the correct input source .
	The picture mute is active.	Press the V-MUTE button to release the mute.
<b>Poor color.</b>	Picture is not adjusted properly.	Adjust the picture in the MENU mode.
<b>Picture is too dark.</b>	Lamp life is running out.	Replace the lamp. (☞ P.24)
	Contrast or brightness is not adjusted properly.	Adjust contrast or brightness properly.
<b>Picture is not clear.</b>	Picture is out of focus.	Adjust the focus.
	Dew is on the lens.	Run the projector for about two hours.
<b>Picture rolls.</b>	A signal cable is not properly connected.	Connect a signal cable properly.
<b>The Remote Controller does not work.</b>	Batteries are exhausted.	Replace batteries. (☞ P.7)
	The distance to the unit is too far.	Make the distance between the unit and the remote control closer. (☞ P.7)
	IR sensor on unit is obstructed.	Remove any obstacles.
	The "Wired" position in the Menu is selected.	Select the "Wireless" position. (☞ P.23)
<b>Color temperature cannot be adjusted.</b>	Is the sensor cable disconnected?	Correctly connect the sensor cable. (☞ P.26)
	Was the sensor correctly initialized?	Initialize the sensor by taking the correct procedures. (☞ P.26)
	Is the lens shift knob set to the correct (center) position?	Set the lens shift knob to the correct (center) position by taking the correct procedures. (☞ P.26)

### Notes:

- If the lamp still does not function after the replacement and initialization of the lamp life, contact a Marantz authorized dealer, or service center.
- This projector uses a microcomputer. External noise can cause malfunctions. In such case, shut power OFF and unplug the power cable from AC power outlet. Then, plug the AC power cable back in, press the ⏻ / I button on the projector or the **ON** button on the remote control and check operation.

## ERROR MODE

WARNING/LAMP indicator, ON indicator, and STANDBY indicator diagnose error mode of the projector as follows.

Error mode	Indicators			Possible Cause	Recommendation
	WARNING /LAMP	ON	STANDBY		
Lamp cover	ON	OFF	Flashing	The lamp cover is not closed properly.	Close the cover correctly.
Lamp	ON	OFF	OFF	The lamp has failed, or the lamp is completely worn out.	Replace the lamp and reset lamp life.
Temperature	Flashing	OFF	Flashing	Projector internal temperature is higher than the allowed level.	Check if anything is blocking the exhaust vent.
Fan	Flashing	OFF	ON	Trouble has occurred with the fan.	
Color temperature adjustment	ON	OFF	ON	Color temperature adjustment failed.	Retry adjustment.
Other	Flashing	OFF	OFF	Internal program error	Shut power OFF and ON again.

## ON SCREEN MESSAGE

Use the list below to check the message displayed on the screen.

Message	Meaning	Remedy
<b>NO SIGNAL</b>	No input signal.	Properly connect the cables.
<b>REPLACE LAMP!</b>	The lamp has reached the end of its life.	Replace the lamp and reset lamp life.
<b>OUT OF RANGE</b>	Improper signal feed to the projector.	Adjust resolution, V(Hz) : refresh rate of the equipment, referring to the Timing Chart.

# SPECIFICATIONS

## ❖ Optical characteristics

<b>Panel</b>	0.8 inch 16:9 1280 x 720 pixels Digital Micromirror Device
<b>Lamp</b>	Super High Pressure 200W DC
<b>Lens</b>	f: 30.7 to 44.5mm F: F3.0/F5.0
<b>Projection size</b>	60 to 250 inches
<b>Light output</b>	600/700 ANSI LUMEN typical (F5.0/F3.0)

## ❖ Input/Output

<b>VIDEO IN</b>	RCA x 1 NTSC-3.58/PAL-4.43/SECAM Composite video 1.0Vp-p/ 75 Ohm
<b>S-VIDEO IN</b>	S-Connector x 1 NTSC-3.58/PAL-4.43/SECAM S-Video
<b>COMPONENT IN</b>	3RCA x 2 Y, C <sub>B</sub> /P <sub>B</sub> , C <sub>R</sub> /P <sub>R</sub>
<b>RGB/HD IN</b>	D-sub M 15 pin x 1 Analog RGB HD:1080i, 720p, 480p
<b>HDMI IN</b>	HDMI x 2 HDMI compliant (single link only)
<b>REMOTE CONTROLLER IN</b>	Mini jack type x 1
<b>REMOTE CONTROLLER OUT</b>	Mini jack type x 1
<b>AC IN</b>	3 Prong Grounding Type
<b>TRIG.1 OUT, TRIG.2 OUT</b>	Mini Jack x 2 Output: DC12V or 0V
<b>RS-232C</b>	RS-232C receptacle plug x 1

## ❖ General

<b>Power requirement</b>	AC 100-120V / 220-240V, 50/60 Hz
<b>Power consumption</b>	< 320 W
<b>Standby consumption</b>	< 3.3 W
<b>Chassis isolation</b>	Class-1
<b>Safety</b>	UL6500 CSA E60065 EN60950
<b>EMC</b>	FCC Part-15 Class-B EN55022 Class-B
<b>Dimensions</b>	15 15/16(W) x 18 15/16(D) x 6 1/8(H) inch 404.5(W) x 481(D) x 158(H) mm
<b>Net weight</b>	13 kg
<b>Operating Temperature</b>	5 to 35 °C
<b>Operating humidity</b>	30 to 85%
<b>Storage Temperature</b>	- 20 to 60 °C
<b>Storage humidity</b>	30 to 85%

## ❖ Accessories

- Lens cap x 1
- Remote controller x 1
- Batteries x 2
- AC power code x 1
- Scart-RCA plug Cable x 1 (For Europe only)
- Control Adapter cable (Mini jack to RCA) x 1
- Color temperature sensor x 1
- User Guide
  - For USA (4 languages x 1)
  - For Europe (4 languages x 1, 5 languages x 1)
- Warranty Card  
(1 copy each for USA, CANADA)

## ❖ Timing chart

\*: Supported only for DVI

Format	Resolution	V (Hz)	H (KHz)	Comp.1/2	CVBS/S-Video	RGB	HDMI
NTSC 3.58	-	59.94 / 60	15.734/15.75		●		
NTSC 4.43	-	59.94 / 60	15.734/15.75		●		
PAL-B/G	-	50	15.625		●		
PAL M	-	59.94 / 60	15.734/15.75		●		
PAL N	-	50	15.625		●		
PAL 60	-	59.94 / 60	15.734/15.75		●		
SECAM	-	50	15.625		●		
480/60i	720 x 487	59.94 / 60	15.734/15.75	●		●	●
480/60p	720 x 483	59.94 / 60	15.734/15.75	●		●	●
576/50i	720 x 576	50	15.625	●		●	●
576/48p	720 x 576	48	30	●		●	●*
576/50p	720 x 576	50	31.25	●		●	●
540/60p	1920 x 540	59.94 / 60	33.746/33.78	●		●	
720/24p	1280 x 720	23.98 / 24	17.985/18	●		●	
720/25p	1280 x 720	25	18.75	●		●	
720/30p	1280 x 720	29.97 / 30	22.478/22.5	●		●	
720/50p	1280 x 720	50	37.5	●		●	●
720/60p	1280 x 720	59.94 / 60	44.955/45	●		●	●
1035/60i	1920 x 1035	59.94 / 60	33.716/33.75	●		●	●*
1080/50i	1920 x 1080	50	28.125	●		●	●
1080/60i	1920 x 1080	59.94 / 60	33.716/33.75	●		●	●
1080/24PsF	1920 x 1080	23.98 / 24	26.978/27	●		●	
1080/25PSF	1920 x 1080	25	28.125	●		●	
1080/30PsF	1920 x 1080	29.97 / 30	33.716/33.75	●		●	
1080/24p	1920 x 1080	23.98 / 24	26.978/27	●		●	●*
1080/25p	1920 x 1080	25	28.125	●		●	●*
1080/30p	1920 x 1080	29.97 / 30	33.716/33.75	●		●	●*
1080/50p	1920 x 1080	50	62.5	●		●	
1080/60p	1920 x 1080	59.94 / 60	67.433/67.5	●		●	
640 x 350 @ 70Hz	640 x 350	70	31.469			●	
640 x 350 @ 85Hz	640 x 350	85	37.861			●	●*
640 x 400 @ 70Hz	640 x 400	70	31.469			●	
640 x 400 @ 85Hz	640 x 400	85	37.861			●	●*
640 x 480 @ 60Hz	640 x 480	60	31.469			●	●
640 x 480 @ 72Hz	640 x 480	72	37.861			●	●*
640 x 480 @ 75Hz	640 x 480	75	37.5			●	●*
640 x 480 @ 85Hz	640 x 480	85	43.269			●	●*
800 x 600 @ 56Hz	800 x 600	56	35.156			●	●*
800 x 600 @ 60Hz	800 x 600	60	37.879			●	●*
800 x 600 @ 72Hz	800 x 600	72	48.077			●	●*
800 x 600 @ 75Hz	800 x 600	75	46.875			●	●*
800 x 600 @ 85Hz	800 x 600	85	53.673			●	●*
1024 x 768 @ 60Hz	1024 x 768	60	48.363			●	●*
1024 x 768 @ 70Hz	1024 x 768	70	56.476			●	●*
1024 x 768 @ 75Hz	1024 x 768	75	60.023			●	●*
1024 x 768 @ 85Hz	1024 x 768	85	68.678			●	
1280 x 1024 @ 60Hz	1280 x 1024	60	63.981			●	
1600 x 1200 @ 60Hz	1600 x 1200	60	75			●	

Specifications may be subjected to change without any prior notice.

# DIMENSIONS

# GLOSSARY

❖ Top

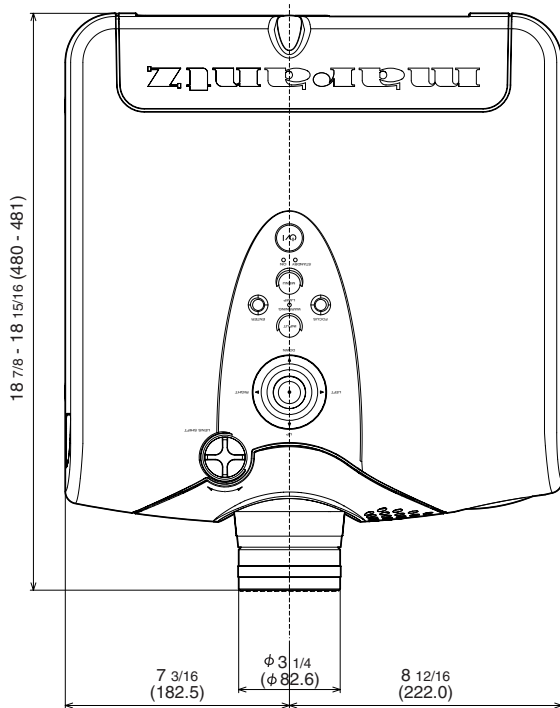

❖ Bottom

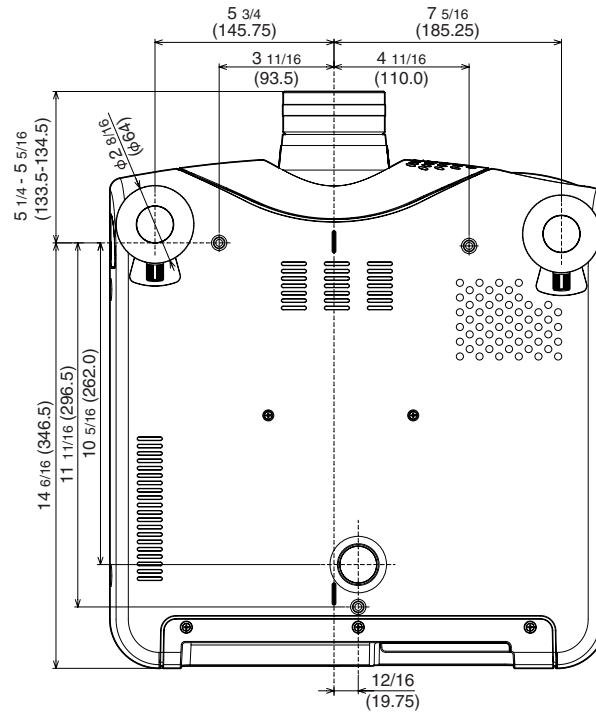

❖ Front

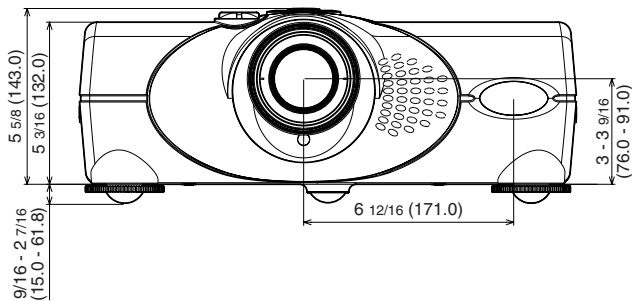

❖ Rear

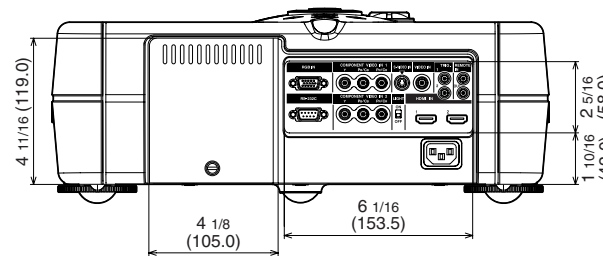

## Aspect ratio

Width and height ratio of an image. The normal aspect ratio of a computer and video image is 4 : 3. There are also wide images with an aspect ratio of 16 : 9 and 21 : 9.

## Black Level (Black setup)

The signal level which represents black picture intensity.  
 For NTSC system for USA, this level is 7.5IRE.  
 NORMAL: 16 (Black) – 235 (White)  
 For NTSC system for Japan and DVD, this level is 0IRE.  
 EXPAND: 0 (Black) – 246 (White)

## Color Temperature

White color hue.  
 Low color temperature implies a warmer (more yellow/red) light.  
 High color temperature implies a colder (more blue) light.

## Keystone

Distortion of the image caused by projection to a wrong vertical/horizontal angle.

Unit : inch (mm)

## **www.marantz.com**

You can find your nearest authorized distributor or dealer on our website.

---

<b>JAPAN</b>	Marantz Japan, Inc.	35-1 Sagami Ohno 7-Chome, Sagamihara-shi, Kanagawa 228-8505, Japan
<b>U.S.A.</b>	Marantz America, Inc.	1100 Maplewood Drive, Itasca, IL 60143, U.S.A.
<b>EUROPE</b>	Marantz Europe B.V.	P.O. Box 8744, 5605 LS Eindhoven, The Netherlands

---

**marantz**<sup>®</sup> is a registered trademark.



## Free Manuals Download Website

<http://myh66.com>

<http://usermanuals.us>

<http://www.somanuals.com>

<http://www.4manuals.cc>

<http://www.manual-lib.com>

<http://www.404manual.com>

<http://www.luxmanual.com>

<http://aubethermostatmanual.com>

Golf course search by state

<http://golfingnear.com>

Email search by domain

<http://emailbydomain.com>

Auto manuals search

<http://auto.somanuals.com>

TV manuals search

<http://tv.somanuals.com>