

This manual is for reference and historical purposes, all rights reserved.

**This page is copyright© by M. Butkus, NJ.**

This page may not be sold or distributed without the expressed permission of the producer

I have no connection with any camera company

On-line camera manual library

This is the full text and images from the manual. This may take 3 full minutes for the PDF file to download.

**If you find this manual useful, how about a donation of \$3 to: M. Butkus, 29 Lake Ave., High Bridge, NJ 08829-1701 and send your e-mail address so I can thank you. Most other places would charge you \$7.50 for a electronic copy or \$18.00 for a hard to read Xerox copy.**

**This will allow me to continue to buy new manuals and pay their shipping costs.**

**It'll make you feel better, won't it?**

**If you use Pay Pal or wish to use your credit card,  
click on the secure site on my main page.**

Download From [www.manuals.com](http://www.manuals.com) or [www.manuals.com](http://www.manuals.com) Search And Download.

*Nikon*  
**NIKONOS-V**  
INSTRUCTION MANUAL

[www.butkus.us](http://www.butkus.us)

# NOMENCLATURE

① Film advance lever

② Shutter speed scale

③ Shutter speed/mode selector dial

④ Frame counter

⑤ Shutter release button

⑥ Shutter release button lock lever

⑦ Anatomical grip

⑧ Depth-of-field indicators

⑨ Lens

⑩ Lens aperture knob

⑪ Aperture index

Shutter speed/mode index ⑫

Accessory shoe ⑬

Viewfinder ⑭

Neckstrap eyelets ⑮

Lens positioning slot ⑯

SPD sensor for  
TTL flash photography ⑰

Lens positioning pin ⑱

Distance scale ⑲

Lens focusing knob ⑳

Distance scale index ㉑

Aperture scale ㉒



23 ASA/ISO film speed index

24 Film rewind knob

25 Film rewind crank

26 ASA/ISO film speed dial

27 ASA/ISO film speed scale

28 Camera back release/  
lock button

29 Camera back lock  
index (red)

30 Camera back release  
index (white)

31 Camera back release/  
lock mark

32 Camera back release/  
lock latch

33 Film rewind fork

Viewfinder eyepiece window 34

Hinged film pressure plate 35

Film advance sprockets 36

Film takeup spool 37

Film guide rails 38

Pressure plate locking catch 39

Camera back 40

Film cartridge chamber 41

Flash sync socket cover 42

Battery chamber clip 43

Tripod socket 44



www.butkus.us

# CONTENTS

<b>NOMENCLATURE</b> .....	2-3	EV range of the camera .....	39
<b>FOREWORD</b> .....	6	Shutter Release Lock Lever .....	40
<b>PREPARATION</b> .....	7-11	Shutter Release Button .....	40
Examining and lubricating the O-rings .....	8	ASA/ISO Film Speed Dial .....	41
The O-rings and their sealing method .....	10	Frame Counter .....	42
<b>TIPS ON CAMERA CARE</b> .....	12-13	Film Advance Lever .....	43
<b>BASIC OPERATIONS</b> .....	14-29	Exposure compensation .....	43-44
<b>CONTROLS IN DETAIL</b> .....	30-49	Depth of field .....	45
Shutter Speed/Mode Selector Dial .....	30	Camera Back Lock System .....	47
A (Auto) .....	30	Pressure Plate .....	48
Manual (1/30 to 1/1000sec.) .....	31	Anatomical Grip .....	48
M90 (1/90sec.) .....	31	Tripod Socket .....	49
B (Bulb) .....	31	<b>FLASH PHOTOGRAPHY</b> .....	50-57
R (Rewind) .....	31	Flash Socket .....	52
Aperture Setting .....	32	Accessory Shoe .....	53
TTL Metering System .....	33	Viewfinder Ready-Light .....	53
Viewfinder .....	34	Camera meter, shutter speed, and ready-light .....	54
Shooting in the Aperture-Priority Automatic Exposure Mode .....	35	Nikonos-V/Speedlight combination chart .....	55
Shutter-priority automatic exposure photography .....	36	Daylight fill-in flash shooting .....	56
Shooting in the Manual Exposure Mode .....	37	EV chart .....	57
How to select the f/stop and shutter speed .....	39	<b>TIPS ON UNDERWATER PHOTOGRAPHY</b> ..	58-64
Shutter speed/aperture combinations that give the same exposure .....	39	Water's magnifying effects .....	58
		Lens focal length and picture angle .....	58
		Focusing .....	59

Water's effects on colors .....	60
Color absorption underwater .....	60
Shooting distance and subject contrast .....	61
Shooting with sunlight .....	61
Camera positioning .....	62
Best depth of water for AE shooting .....	62
Film choice .....	63
When to use a speedlight .....	63
Underwater photography and speedlight guide numbers .....	63
Flash shooting tips .....	64
<b>ACCESSORIES .....</b>	<b>65-76</b>
Nikonos Speedlights SB-103 and SB-102 .....	65-66
V-Type Sync Cord .....	66
VI-A-Type Sync Cord SC-10 .....	66
Nikonos Interchangeable Lenses .....	67
Relationship between picture angle and focal length .....	67
UW-Nikkor 15mm f/2.8N, UW-Nikkor 20mm f/2.8, and UW-Nikkor 28mm f/3.5 .....	68-69
W-Nikkor 35mm f/2.5 (Standard) .....	70
Nikkor 80mm f/4 .....	71
LW-Nikkor 28mm f/2.8 .....	72

Nikonos Close-up Outfit .....	73
Accessory Viewfinders .....	74
Optical Viewfinder DF-11 .....	74
Optical Viewfinder DF-12 .....	74
Optical Viewfinder for the UW-Nikkor 28mm f/3.5 .....	74
Optical Viewfinder DF-10 .....	74
Plastic Frame Finder for the UW-Nikkor 28mm f/3.5 .....	74
Plastic Frame Finder for the W-Nikkor 35mm f/2.5 and the Nikkor 80mm f/4 .....	74
Lens Hood .....	75
Plastic Lens Protector .....	75
Rubber Lens Hood .....	75
Lens Cases .....	76
Camera Case .....	76
Speedlight Case SS-101 .....	76
Close-up Outfit Case .....	76
O-rings and lubricant .....	76
<b>TIPS ON BATTERY USE .....</b>	<b>77</b>
<b>SPECIFICATIONS .....</b>	<b>78-79</b>

# FOREWORD

The Nikonos-V is the world's only 35mm underwater camera capable of going to a depth of 50m (160 feet) and withstanding pressure of 6kg/cm<sup>2</sup> (85lb/in<sup>2</sup>) without a special underwater housing. Because of its ruggedness, you can use the Nikonos in situations where regular cameras would dare not go. Carry it to the beach, use it on your boat, even take it mountain climbing or go skiing.

The Nikonos-V's automatic aperture-priority and manual exposure controls make picture-taking both above and below water easier than ever. For extra precision, shutter speeds are quartz-controlled in the manual mode. The Nikonos-V also makes flash photography easier than ever. Combine it with the SB-103 or SB-102 for both underwater and on-land photography and enjoy the benefits of automatic TTL flash exposure control. Other Nikon accessories allow TTL multiple flash photography.

Six interchangeable lenses from super-wideangle to medium telephoto are also available: the UW-Nikkor 15mm f/2.8N, UW-Nikkor 20mm f/2.8, UW-Nikkor 28mm f/3.5—all for underwater use only; the W-Nikkor 35mm f/2.5 and Nikkor 80mm f/4, for both underwater and on-land use; and the water-resistant LW-Nikkor 28mm f/2.8, for on-land use only.

The Nikonos-V has a large, high-eyepoint viewfinder that lets you see the entire field of view from up to 40mm away while wearing a diver's mask or goggles.

A new camera back lock system eliminates the possibility of the camera back opening accidentally. And a large shutter release button and film advance lever allow you to operate the Nikonos-V in the same manner as a regular 35mm camera.

Even though this camera is very easy to use, you should still familiarize yourself with the preparatory steps and basic operations explained in the first two sections of this manual. For more detailed information, refer to "CONTROLS IN DETAIL" and "TIPS ON UNDERWATER PHOTOGRAPHY." A few minutes wisely invested now will pay off later in years of rewarding photographic experiences.

# PREPARATION

## **STOP! READ THIS NOTICE BEFORE USING YOUR NIKONOS-V CAMERA. THE O-RING SEALS MUST BE EXAMINED AND LUBRICATED BEFORE USE TO AVOID DAMAGING THE CAMERA.**

This Nikonos-V uses O-rings to seal and waterproof the junctions between parts. Your Nikonos-V should not be considered waterproof until you have examined the four user-serviceable O-rings (one each for the camera back 40, lens 9, flash sync socket, and battery clip 43). They must be in perfect, undamaged condition and properly lubricated prior to each use. Read the following instructions thoroughly to familiarize yourself with the maintenance of the O-rings.

Because the outer surface of your Nikonos-V has been specially treated to make it waterproof, it must be protected from impact. If it becomes damaged, send it to a qualified technician for service before the next use.

Your Nikonos-V is watertight only when in properly serviced condition, when all O-ring seals are in perfect condition, and when all components are properly assembled and closed.

Pay special attention to the instructions for installing the O-rings because it is the O-rings which make your Nikonos-V watertight. For the O-rings to perform properly, they must be in perfect condition (with no cuts, tears, or other imperfections) and properly lubricated. If they are not, they will not perform pro-

perly and may allow water to enter your camera. To prevent the accidental use of a defective O-ring, always discard old rings.

The channels into which the O-rings fit must be free of any foreign matter and in their original, smoothly finished condition. If they are not, the O-rings will not seat properly and may allow water to enter your camera. If any channel in your Nikonos-V becomes damaged, send the camera to a qualified technician for service before the next use.

Your Nikonos-V contains a series of O-rings. Some are factory installed and cannot be serviced by you. Once each year, send your camera to a qualified technician so these O-rings can be serviced. Do not attempt to disassemble the camera and service these O-rings yourself.

Four of the O-rings in your Nikonos-V can be serviced by you. These must be examined at the end of each dive day and, if possible, after each dive.



# PREPARATION—continued

## Examining and lubricating the O-rings

1. To remove the O-rings, except the one around the camera back, grasp the ring between your thumb and forefinger. Pinch your fingers together as you slide them in the direction of the arrow to create slack in the O-ring. Then grasp the portion with your other hand and pull the ring off (see Fig. 1).  
To remove the O-ring around the camera back, use the edge of a credit card or dive card or some other thin, **blunt**, instrument. **Never use a knife or other sharp-edged instrument.** Insert the card under the ring and pull up to lift the O-ring out (see Fig. 2). Do not scratch the O-ring in the process.
2. Visually examine each O-ring for imperfections. If any O-ring is damaged (by tears, cuts, or other imperfections), discard it immediately. If any O-ring has dirt, sand, hair, or foreign matter on it, rinse the O-ring in fresh water to remove it.
3. When lubricating the various parts of your camera, **use only the special non-water-soluble silicone lubricant supplied with the camera.** Never use other lubricants (such as Vaseline) which are water-soluble.
4. To lubricate the O-rings, smear a small amount of the special silicon lubricant on your fingertips and then gently run each O-ring between them. Never use a brush or similar object to apply the lubricant; small hairs may fall into the channel and allow

water to enter the camera. While lubricating each O-ring, examine it with your fingertips for imperfections. If an O-ring is properly lubricated, it will glisten and will not have "gobs" of lubricant on it. To ensure the longest possible camera life, apply lubricant whenever necessary. Lubrication protects the O-rings from excessive wear; it also makes the camera back easy to open and the lens or other parts easy to attach.

5. Visually examine the channels into which the O-rings fit to determine that each is clean and smooth. If any channel is dirty, clean it with a non-lint material. Coat each channel with a thin film of lubricant while being careful not to apply too much.
6. Reseat all four O-rings with your fingertips by inserting one side of the ring into the channel and holding it in position while rolling the other side of the ring into place (see Fig. 3). To insert the O-ring into the channel in the camera back, place the ring over the groove and then press it down into place. Check to see that the O-ring is not twisted and that each of its edges is properly seated (see Fig. 4).
7. Check the surfaces which are opposite the O-rings to determine that each is clean, smooth, and free of foreign matter. Clean and lubricate the surfaces in the same manner as the channels.



Fig. 1

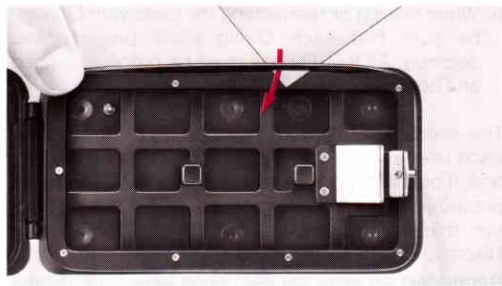

Fig. 2



Fig. 3

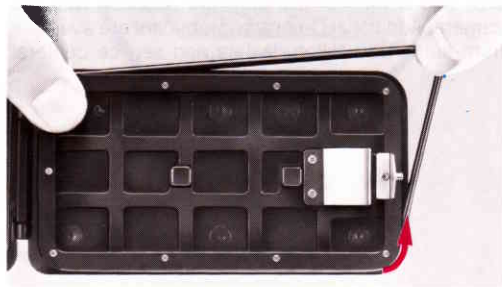

Fig. 4

[www.butkus.us](http://www.butkus.us)

# PREPARATION—continued

8. When closing or reattaching the parts with O-rings, be sure that each O-ring seats properly and securely. All four O-rings must be properly aligned and not "pinched."

The preceding instructions must be performed on each user-serviceable O-ring prior to each dive day and, if possible, prior to each dive. By following these procedures and all other procedures in this instruction manual, you will be able to enjoy using your Nikonos-V for many years.

**Reminder:** An extra set of O-rings (one each for the camera back, lens, flash sync socket, and battery clip) and a tube of lubricant are supplied with the camera. Additional O-rings and lubricant are available from authorized Nikon dealers and service centers.

## The O-rings and their sealing method

The method used by the O-rings to seal and waterproof the camera is shown in the following illustrations. When a low level of pressure exists (for instance, just under the water's surface), each O-ring seals its groove by its own elastic force (see Chart A). When the pressure increases (at greater depths), the O-ring's shape is altered and its sealing ability is increased to withstand the greater pressure. The pressure changes the ring from its original "O" shape (when looking at a cross-sectional view) to a "D" shape (see Chart B).

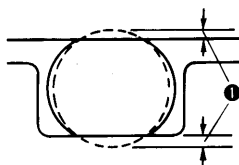

Chart A

① Slight compression

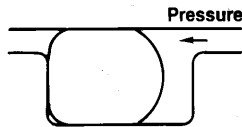

Chart B



[www.butkus.us](http://www.butkus.us)

# TIPS ON CAMERA CARE

1. After using the camera underwater, rinse it in **fresh water with the camera back closed and the lens mounted**. When the camera/lens assembly gets dirty, rinse it thoroughly in fresh water. Immediately after using it in salt water, rinse it thoroughly in fresh water to remove any residue. Otherwise, corrosion may occur in minute places like screw holes or the junctions of parts. To prevent this, soak the camera/lens assembly overnight in a basin of fresh water and move the external parts (for instance, the film advance lever ①, shutter speed/mode selector dial ③, ASA/ISO film speed dial ⑥, and so on), then rinse it vigorously in running water. Finally, dry the camera/lens assembly with a soft cloth—never by heating—**before** removing the lens from the camera. Be sure to wipe away any drops of water that may have seeped in past the O-ring. All underwater Nikonos accessories should be handled in this way.
2. **Never attempt to change lenses, open the camera, or load/unload film underwater.**
3. After shooting in the water (especially, in salt water or dirty water), wipe any drops of water on the camera body before removing the film cartridge. If any drops of water fall into the camera when the camera back is opened, immediately wipe them off.
4. Do not submerge the camera in water with the flash socket cover removed. And when using the Nikonos Speedlight, make sure the sync cord and sensor cord plugs are securely attached before entering the water.
5. Should the lens or camera body accidentally fall into salt water during loading (or at any other time when the interior is exposed), rinse it immediately in fresh water and take the unit to any authorized Nikon dealer or service center as soon as possible.
6. If this camera is frequently used underwater (especially in salt water or dirty water), make it a rule to take it to a Nikon service center on a regular basis for an inspection of the camera's O-rings. Doing so will increase the camera's performance and life span.
7. Do not attempt to rotate the focusing or aperture knobs beyond their limits of travel; forcing these knobs will damage the lens mechanism.
8. The LW-Nikkor 28mm f/2.8 is water-resistant, not waterproof, and cannot be submerged in water.

9. Store the camera and lens away from high temperatures, high humidity, naphthalene, and camphor. If the camera will not be used for more than two weeks, remove the battery or batteries. Do not leave the battery or batteries in the battery chamber for a long time or the contacts may become contaminated. It is a good idea to periodically clean the battery or batteries and the contacts in the battery chamber with a soft cloth. If a battery leaks into the battery chamber, remove the battery or batteries at once and clean the chamber.
10. Check the camera thoroughly before using it each time.
11. Do not touch the shutter curtains.
12. Clean metallic parts with a blower brush or soft dry cloth.
13. Clean glass surfaces, such as the lens or the finder eyepiece ④, with a blower brush; avoid using lens tissue if possible. To remove dirt, smudges, or fingerprints, gently wipe the surface with soft cotton moistened with a small amount of absolute alcohol, using a spiral motion from center to periphery.
14. In a humid environment, store the camera in a vinyl bag with a desiccant to keep away dust, moisture, and salt.
15. Because the frame counter window is made of plastic, do not wipe it with an alcohol-moistened cloth.

[www.butkus.us](http://www.butkus.us)

# BASIC OPERATIONS

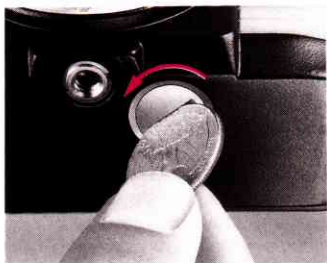

## 1. Remove the battery clip <sup>43</sup>.

Turn the camera upside down and use a coin to twist the lid counter-clockwise to unscrew it.

**Note:** The small numbers in the circles identify parts of the camera as listed in the NOMENCLATURE section.



## 2. Install the battery or batteries.

Wipe the battery terminals clean and insert either one 3V lithium battery (CR-1/3N type), two 1.55V silver-oxide batteries (SR-44 type), or two 1.5V alkaline-manganese batteries (LR-44 type) into the battery clip, making sure each "+" sign is up.

• See "TIPS ON BATTERY USE" on page 77 for more information.



## 3. Replace the battery clip.

Slip the battery clip back into the camera body and screw it clockwise tightly into place.

To replace the clip, gently push it into the battery chamber then screw it into place.

**Check O-ring:** Before replacing the clip, check the O-ring around it by following the directions in "PREPARATION" on page 7.



#### 4. Mount the lens 9.

With the silver lens focusing knob 20 positioned vertically in front of the viewfinder 14 (when mounting the LW-Nikkor lens, hold the silver mounting ring with the red dot facing up), push the lens firmly into the camera's bayonet mount. Turn the lens 90° clockwise until the lens positioning pins 18 click and lock into position in the lens positioning slots 16. Now the camera/lens assembly is completely watertight.

- *Mounting the lens upside down will not affect its operation but may make it easier to read the aperture and distance scales from above the camera. Do not, however, mount the LW-Nikkor lens in this manner.*
- *It will be easier to mount the lens if you push the lens alternately up and down into the camera's bayonet mount.*

**Check the O-ring:** Before mounting the lens, check the O-ring around it by following the directions in "PREPARATION" on page 7.

**To remove:** Pull the lens slightly out from the body and turn it 90° counterclockwise so the lens positioning pins are out of the lens positioning slots. Then, with the silver lens focusing knob positioned vertically (in the case of the LW-Nikkor, with the red dot on the mounting ring facing up), remove the lens from the camera body.

- *Be sure the O-ring does not get scratched while the lens is being removed.*

[www.butkus.us](http://www.butkus.us)





### 5. Unlock and open the camera back (40).

While depressing the orange camera back release/lock button (28), lift up the camera back release/lock latch (32), turn it in the direction of the arrow on the camera body (counterclockwise), and align the red camera back release/lock mark (31) on the latch with the white camera back release index (30) on the camera body.

### 6. Lift up the film pressure plate (35) and install the film cartridge.

Swing the film pressure plate away from the camera body. While holding the film pressure plate up, slip the cartridge into the film cartridge chamber so the top of the cartridge engages the rewind fork (33) and the film leader points toward the takeup spool (37). Then push in the bottom of the cartridge until it is fully seated in the chamber.



- The film pressure plate is attached to the camera body to protect the shutter curtains from water and other foreign matter when the camera back is open. Because the pressure plate is spring-loaded, it will automatically return to its original position when you remove your finger.
- Any 35mm film cartridge (J135 type) available on the market can be used.
- Avoid loading film in direct sunlight. If there is no shade available, turn your back to the sun and use your own shadow to shield the camera.

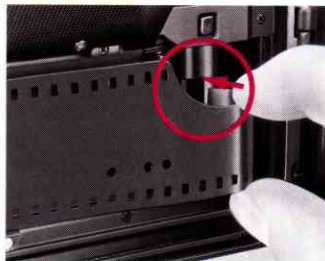

## 7. Insert the film leader in the takeup spool <sup>37</sup>.

Pull the leader across the camera and insert it into one of the slots in the film takeup spool.

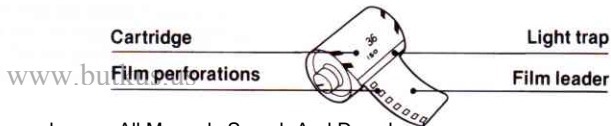

## BASIC OPERATIONS—continued

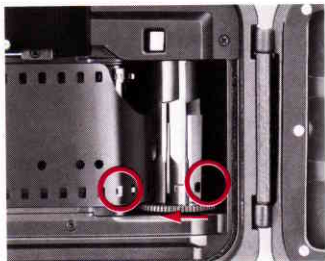

### 8. Engage the film's perforations with the sprocket teeth.

Advance the takeup spool slightly with your finger to engage the film's perforations with the teeth of the takeup spool and the sprockets ③⑥.



### 9. Unlock the shutter release button ⑤.

Move the shutter release lock lever ⑥ out of the "L" position.

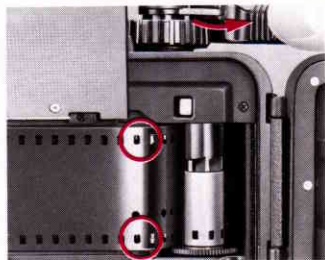

### 10. Advance the film with the film advance lever ①.

Pull out the film advance lever and advance the film with it until the perforations on both film edges are securely engaged with the sprocket teeth.

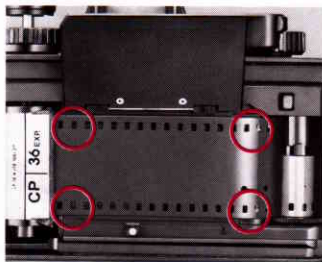

## 11. Confirm that the film is properly loaded.

Confirm that the perforations on both film edges are securely engaged with the sprocket teeth, that the film is located properly between both film guide rails 38, and that there is no film slack.



## 12. Return the film pressure plate to its original position.

Let the film pressure plate swing gently back into its original position and lock under the pressure plate locking catch 39.

- If the film pressure plate is placed in its original position before the film perforations and the sprocket teeth are properly engaged, the film pressure plate may become dislocated or the film may not advance properly. If the film is improperly located between the film guide rails, the film may not advance properly.

## BASIC OPERATIONS—continued



### 13. Close and lock the camera back.

Before closing the camera back, make sure the red mark on the camera back release/lock latch is aligned with the white camera back release index on the camera body. Then firmly press the camera back against the camera body (the camera back release/lock latch will move clockwise).

Turn the camera back release/lock latch clockwise until its red mark clicks into position opposite the red camera back lock index 29. The camera back is now locked.



### 14. Fold down the camera back release/lock latch.

Fold the latch down until it is flush with the camera body.

**Check the O-ring:** Before closing the camera back, check the O-ring around it by following the directions in "PREPARATION" on page 7.

• When closing the camera back, make sure it locks shut. Also make sure the lens positioning pins 18 lock securely into the lens positioning slots 16. The lens positioning pins may disengage from the lens positioning slots from pressure caused by closing the camera back. If this occurs, remount the lens

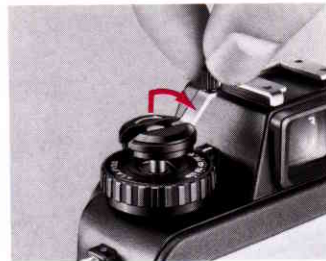

### 15. Take up the film slack.

Fold out the film rewind crank 25. Rotate the film rewind knob in the direction of the arrow on the knob (clockwise) as you lift up. Then, with the knob in the raised position, rotate it in the same direction until you feel a slight tension.

- If you cannot pull up the film rewind knob, turn it clockwise slightly.
- Do not push the film rewind knob down until you have completed Step 17.

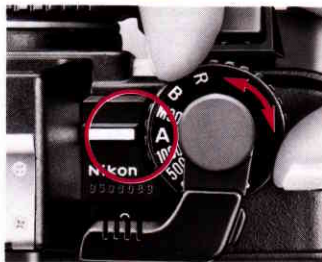

## 16. Set the shutter speed/mode selector dial ③ to "A" (for automatic exposure operation).

For rapid film loading, align the "A" on the shutter speed/mode selector dial ③ with the shutter speed/mode index before making blank exposures. Until the frame counter reaches "1," the shutter will be automatically released at approximately 1/1500sec.

- Until the frame counter reaches "1," the shutter will also be automatically released at approximately 1/1500sec. when the shutter speed/mode selector dial is set from 1/30sec. to 1/1000sec.
- In addition to the aperture-priority automatic exposure system, the Nikonos-V is also equipped with a manual exposure system. See "MANUAL EXPOSURE" on page 37 for more information.
- When the older-type UW-Nikkor 15mm f/2.8 lens is used, the Nikonos-V's TTL exposure meter does not operate.

[www.butkus.us](http://www.butkus.us)



### 17. Make blank exposures until the frame counter shows frame "1."

Continue to depress the shutter release button and wind the film advance lever until the frame counter shows "1." While making these blank exposures, watch the rewind knob to see that it rotates. This indicates that the film has been loaded correctly and is being advanced.

If the film rewind knob does not rotate, the film is improperly loaded and must be loaded again.



- Do not begin shooting until the frame counter shows frame "1." The viewfinder LED indicator(s) does not operate before the frame counter shows frame "1."



### 18. Push the rewind knob back down.

Fold the crank back in. Then rotate the knob slightly in the opposite direction of the arrow on the knob (counterclockwise) while pushing down. The knob will return to its original position.

- Be sure to push the rewind knob back down after completing the blank exposures, especially before you actually dive into the water. Otherwise, water may enter the camera body.



## 19. Set the ASA/ISO film speed.

Lift up the film speed dial ⑳, rotate it in either direction until the ASA/ISO film speed is opposite the white ASA/ISO film speed index ㉓, then make sure the dial is fully seated at the desired position. This

programs the camera's exposure meter so that it may provide a proper exposure for the speed of the film in use.

- *The film speed is printed on the film carton and the cartridge itself.*



## 20. Gently depress the shutter release button halfway.

The shutter release button activates the exposure meter when gently depressed halfway.

### ASA/ISO film speed scale

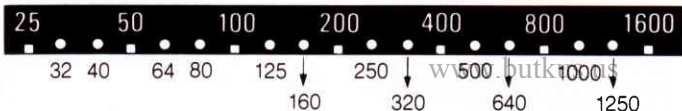



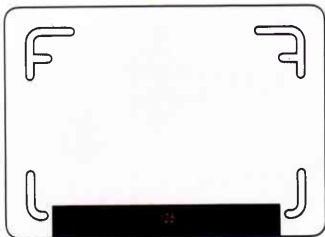

## 21. Check battery power.

Be sure to check battery power before shooting.

Point the lens at a brightly lit area, look through the viewfinder eyepiece ④, and check to see that the viewfinder LED indicator(s) lights up or blinks. It is not possible to check battery power when the shutter speed/mode selector dial is set at M90 (1/90sec.) or B (Bulb) because the exposure meter does not operate when the shutter speed/mode selector dial is at either of these settings, even if the shutter release button is depressed

halfway.

If battery power is sufficient, the meter will stay on for 16sec. after you remove your finger from the button. The meter automatically turns off after 16sec.

If the viewfinder LED indicator(s) does not appear, reload the battery (or batteries) properly or replace it (them) with a fresh one(s).

- *Battery power cannot be checked until the frame counter reaches "1."*
- *If the viewfinder LED indicator(s) turns off immediately after you remove your finger from the shutter release button or before 16sec. have elapsed, the battery (or batteries) is (are) almost exhausted and must be replaced with a fresh one(s).*

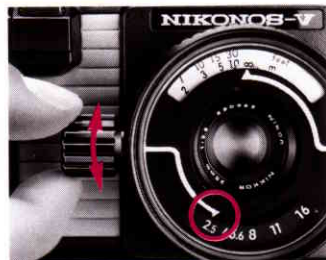

## 22. Set the lens aperture.

Turn the black lens aperture knob ⑩ until the desired f/number is opposite the index mark on the front of the lens.

The pincer-type depth-of-field indicators ⑧, coupled with the focusing knob, open and close to show the range of distances which will be in focus in the final photograph. Refer to the example photos on page 46 for more information.

When shooting for the first time, use the following guide to select the aperture.

### Aperture Setting Guide (Shooting on land at ASA/ISO 100)

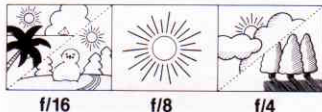

- When the aperture is changed, the shutter speed selected by the camera and the depth of field change accordingly. Both affect the look of your photographs.

In underwater photography, aperture selection varies depending upon the shooting situation. For more information, see page 39 or 45. Do not attempt to rotate the lens aperture knob beyond its limits of travel; forcing it will damage the lens mechanism.



## 23. Set the distance on the lens.

Estimate or measure the camera-to-subject distance\*. Turn the silver lens focusing knob until the estimated camera-to-subject distance in meters or feet is lined up with the index on the front of the lens. The depth-of-field indicators will indicate how close an estimate of the camera-to-subject distance you will need to obtain an in-focus picture.

\* See page 59 for more information.

- Do not attempt to rotate the lens focusing knob beyond its limits of travel; forcing it will damage the lens



### Film plane indicator

- To measure the exact distance between the subject and film plane, use the film plane indicator (⊖) on the camera.

# BASIC OPERATIONS — continued



## 24. Hold the camera steady.

Many blurred shots are caused by improperly holding the camera. The best way to prevent camera blur is to hold the camera steady. Basic shooting posture: As you look through the viewfinder, use your left hand to cradle the camera, wrapping your fingers around the lens and propping your elbow against your body for support. Use your right hand's index finger to depress the shutter release button, and use your thumb to wind the film advance lever. Wrap the other fingers of



your right hand around the camera body. You can adapt this basic posture to both horizontal- and vertical-format shooting. Other factors can contribute to camera blur, especially when shooting underwater, so experiment until you find the camera holding method that works best for you (practicing by holding the camera in front of a mirror is useful). When actually shooting, it is also advisable to lean on or against a strong, stable object (for instance, a wall or large rock).

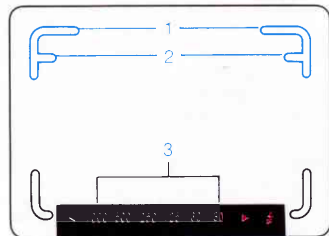

## 25. Frame the subject in the viewfinder.

The frame lines built into the viewfinder show the field of view of the normal 35mm lens. For proper framing, place your subject within the outlined area. When shooting subjects at distances as close as 0.8m (2.75ft), use the parallax correction marks for framing.

### Inside the viewfinder

1. Frame lines showing the field of view for the normal 35mm lens
2. Parallax correction marks
3. LED shutter speed indicators

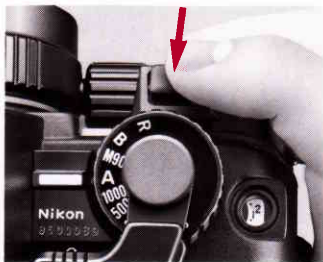

## 26. Take the picture.

Look through the viewfinder and depress the shutter release button halfway. The shutter speed, determined by the subject's brightness, is indicated by the viewfinder LED. If any LED shutter speed indicator between 1000 and 30 lights, gently depress the shutter release button completely.

If either the LED overexposure or underexposure warning arrow lights, adjust the lens aperture knob to turn it off. If the warning arrow remains lighted, after the lens aperture knob is adjusted, the shutter speed is beyond the meter

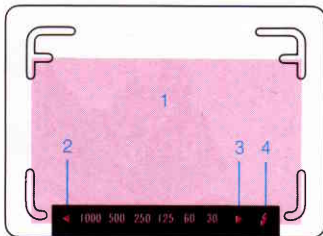

coupling range and you cannot obtain the correct exposure. See page 35 for more information.

### Inside the viewfinder

1. Actual field of view with parallax-corrected shooting
2. LED overexposure warning arrow
3. LED underexposure/camera shake warning arrow
4. LED thunderbolt mark (flash ready-light)

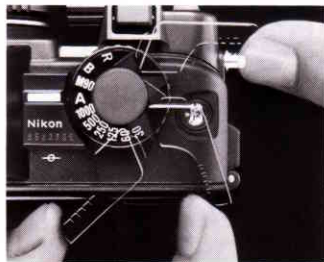

## 27. Advance the film.

Stroke the film advance lever to transport the film to the next frame and prepare the camera for the next shot.

[www.butkus.us](http://www.butkus.us)

# BASIC OPERATIONS — continued



## 28. Set the shutter speed/mode selector dial to "R."

After the last exposure has been made, the film advance lever will not advance further and the frame counter will indicate that all frames have been exposed. You must then rewind the exposed film back into its cartridge. To do this, first turn the shutter speed dial to "R" (Rewind) to disengage the film sprocket drive.

The shutter is automatically locked when the dial set to "R."



## 29. Lift up the film rewind knob.

Lift up the film rewind knob and rotate it in the direction of the arrow on the knob (clockwise) to secure it in the raised position.



## 30. Rewind the film.

Fold out the film rewind crank and rotate it in the direction of the arrow on the knob (clockwise) to rewind the film.

When you feel the tension lessen, continue winding one or two more turns so the film leader rewinds completely into the cartridge.

- Do not open the camera back until you have completely rewound the film into its cartridge. Otherwise, light may reach the film and ruin your photos.
- Do not attempt to rewind film underwater.



## 31. Remove the film cartridge.

Do not remove the film cartridge in direct sunlight.

Open the camera back by following the directions in **Step 5** (the frame counter will automatically return to "S") and remove the film cartridge. Then close and lock the camera by following the directions in **Step 13**.

- Do not store the removed film cartridge in a brightly lit area.
- Take the film in for development as soon as possible.
- After shooting underwater, thoroughly wipe off any water around the camera back with a soft cloth before opening the camera back.

Also wipe off the junctions of the O-rings and their grooves with a soft cloth.

When loading or removing film, wipe up any water that seeps into the camera body or it may corrode the body. [www.butkus.us](http://www.butkus.us)

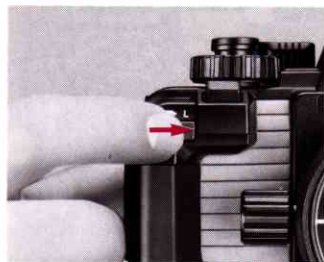

## 32. Lock the shutter release button.

Return the shutter speed/mode selector dial to the "A" position to prepare the camera for the next roll of film. Finally, move the shutter release button lock lever to the "L" position to prevent the shutter release button from being depressed and inadvertently draining battery power.

# CONTROLS IN DETAIL

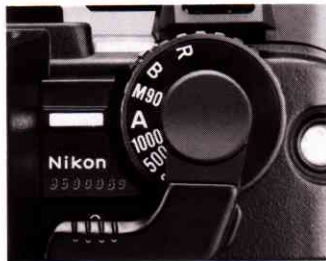

## Shutter Speed/Mode Selector Dial ③

The Nikonos-V offers aperture-priority automatic mode operation and manual control of all shutter speeds from 1/30 to 1/1000sec., including the M90 (1/90sec.), B (Bulb), and R (Rewind) settings. All shutter speeds from 1/30 to 1/1000sec., excluding M90 (1/90sec.) and B (Bulb), are electronically controlled. To set the desired shooting mode or shutter speed, rotate the shutter speed/mode selector dial until the desired setting click-stops opposite the shutter speed/mode index. The shutter speed/mode selector dial has the following settings: R (Rewind), B (Bulb), M90 (1/90sec.), A (Auto), and six shutter speeds from 1/1000 to 1/30sec. Intermediate settings cannot be used.

### A (Auto)

Used for aperture-priority automatic mode shooting. Manually set the f/stop first; then the camera's micro-computer selects the matching shutter speed steplessly between 1/30 and 1/1000sec., depending on the scene brightness and the film speed in use. Until the frame counter reaches frame "1," the shutter will be automatically released at approximately 1/1500sec. regardless of the scene brightness and the film speed in use. After the frame counter reaches frame "1," the camera automatically returns to normal A mode operation.

### **Manual (1/30 to 1/1000 sec.)**

Used for full manual control of both f/stop and shutter speed. All six shutter speeds indicated on the dial are available with timing accuracy assured by a quartz oscillator. Each number shown on the scale is reciprocal, i.e., 1000 means 1/1000 second, 125 means 1/125 second, etc. A one-step change will either halve or double the exposure; e.g., a shutter speed of 1/125sec. lets in twice as much light as 1/250sec. and half as much light as 1/60sec.

*Note: When the shutter speed/mode selector dial is set at either M90 or B, the exposure meter does not work nor do the LED viewfinder indicators light. When the dial is set at R, the shutter is automatically locked.*

### **M90 (1/90 sec.)**

At this setting, the shutter is mechanically released at 1/90sec. Use this setting when the battery (or batteries) is weak, exhausted or not loaded in the camera. M90 setting can also be used for flash photography. It cannot, however, be used for TTL auto flash photography.

### **B (Bulb)**

At this mechanical setting, the shutter remains open for as long as you depress the shutter release button. Cannot be used for TTL auto flash photography.

### **R (Rewind)**

This setting disengages the film sprocket drive to permit film rewinding. At this setting, the shutter release button cannot be operated.



## CONTROLS IN DETAIL—continued

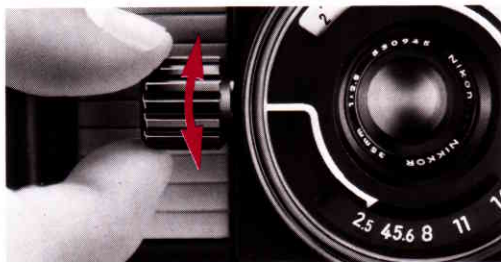

### Aperture Setting

The aperture controls the amount of light passing through the lens. When moving from one f/stop to the next, the amount of light is either halved or doubled. For example, to halve the amount of light, rotate the lens aperture knob (in the case of the LW-Nikkor, rotate the aperture ring) until the aperture index is opposite the next smaller aperture (indicated by a numerically larger f-number on the aperture scale). To double the amount of light through the lens, rotate the lens aperture knob until the aperture index is opposite the next larger aperture (the next smaller f-number).

Because the Nikkor lenses for the Nikonos-V do not have click-stops at each f-number, any setting can be used. (The LW-Nikkor does have click-stops between f-numbers, but intermediate settings can still be

used.) As the aperture is opened and closed, the pincer-type depth-of-field indicators open and close to show the distance range which will be in focus in the final photograph. See page 39 for more information.

## TTL Metering System

The Nikonos-V uses a (through-the-lens) TTL center-weighted stopped-down metering system which measures the light passing through the lens to determine the correct exposure.

When the shutter release button is depressed halfway, activating the exposure meter, the camera's micro-computer automatically selects the shutter speed that corresponds to the aperture set, ASA/ISO film speed in use, and scene brightness, and causes the appropriate viewfinder LED indicators to light.

The camera places special emphasis on the brightness at the center of the viewfinder, although the meter measures the brightness of the entire scene. Correct exposure is assured when the main subject is placed in this central area.

IC printed circuit board

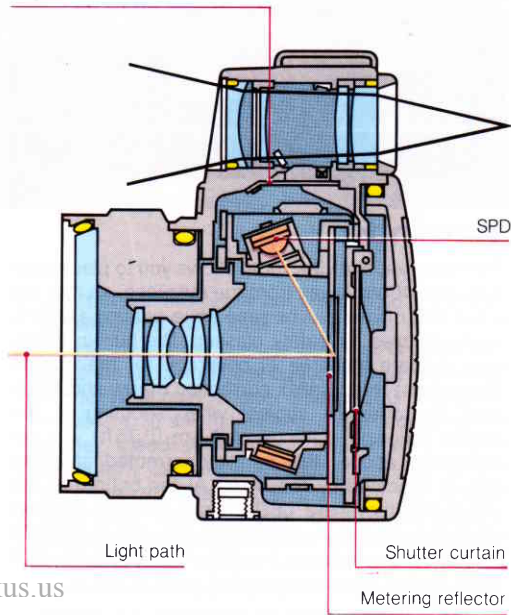

[www.butkus.us](http://www.butkus.us)

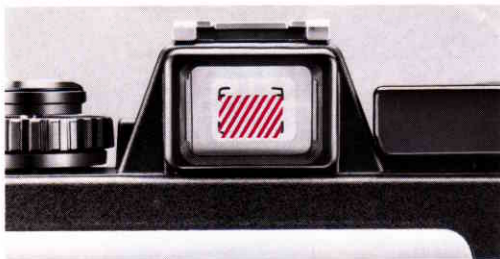

## Viewfinder 14

The high-eyepoint viewfinder allows you to place your eye up to 40mm away from the eyepiece, so that the entire field of view can be seen while wearing a diver's mask, goggles, or safety glasses. The built-in frame lines indicate the area of coverage for the normal 35mm lens; the parallax correction marks should be used to frame the subject when shooting at the closest focusing distance of 0.8m (2.75ft). (In the illustration above, the parallax-corrected shooting area is indicated by red lines.) At the bottom of the viewfinder, there are LEDs (Light Emitting Diodes) which indicate the shutter speeds and warn of possible over- or underexposure. In addition, a flash ready-light in the form of a red lightning bolt mark is built in.

- *The frame lines indicate 85% (when the focusing scale is set to infinity) of the area which will be reproduced on the film. So the actual area will be wider than the scene through the viewfinder.*
- *When using the LW-Nikkor 28mm f/2.8, the field of view is the same as the full area inside the viewfinder. When shooting at the closest focusing distance of 0.5m (1.5ft), the picture coverage is from the top of the uppermost frame lines down.*



## Shooting in the Aperture-Priority Automatic Exposure Mode

To use the aperture-priority automatic exposure mode, perform the following procedures:

1. Set the shutter speed/mode selector dial to "A" (Auto).
2. Turn the lens aperture knob (in the case of the LW-Nikkor, turn its aperture ring) to the desired aperture setting. Intermediate aperture settings can be used.
3. Estimate or measure the camera-to-subject distance\*. Then turn the lens focusing knob (in the case of the LW-Nikkor, turn its focusing ring) until the distance scale index is opposite the desired setting.

\* See page 59 for more information.

4. Look through the viewfinder and compose the subject within the frame lines.
5. Unlock the shutter release button and gently depress the shutter release button halfway. If any one of the viewfinder shutter speed LED indicators between 1/30 and 1/1000sec. lights (indicating the shutter speed selected by the camera's microcomputer), depress the shutter release button completely to release the shutter. If two shutter speed LED indicators light at the same time, it means the camera's microcomputer has selected an intermediate shutter speed. If the LED overexposure warning arrow (◀) blinks, the exposure is beyond the high end of the meter's range (the sub-

www.butku.com

Overexposure warning

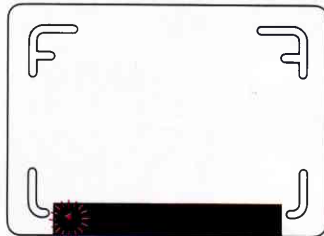
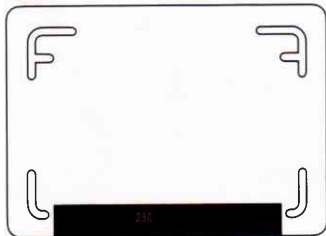

Underexposure warning

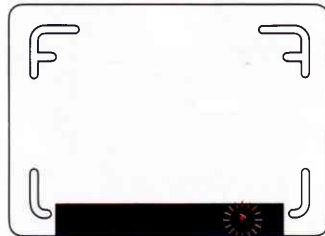

ject is too bright). Therefore, set the lens to its smallest available aperture (the largest f-number). If, after that, the arrow is still blinking, either use a neutral density filter or change to a film with a lower ASA/ISO film speed.

If the LED underexposure warning arrow (▶) blinks, the exposure is beyond the low end of the meter's range (the subject is too dark). Therefore, set the lens to its largest available aperture (the smallest f-number). If, after this, the arrow is still blinking, use a Nikon Speedlight or change to a film with a higher ASA/ISO film speed. (For Speedlight information, see page 50.)

## Shutter-priority automatic exposure photography

The Nikonos-V allows you to select a particular shutter speed to achieve a specific photographic effect when shooting in the A mode. To photograph moving subjects, you can select a fast shutter speed to freeze the action and produce sharp outlines, or you can select a slow shutter speed to pan the action and produce an intentional blur. To operate the Nikonos-V in this manner, gently depress the shutter release button halfway. Then, while watching the viewfinder LED indicators, turn the lens aperture knob (in the case of the LW-Nikkor, turn its aperture ring) until the LED that indicates the desired shutter speed lights.

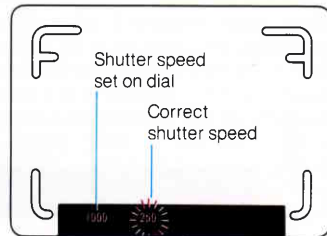
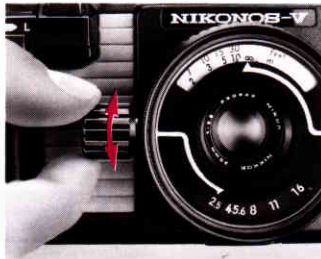

## Shooting in the Manual Exposure Mode

The following procedures apply when you want to:

- Select your own aperture and shutter speed.
- Use an exposure other than what the viewfinder LEDs indicate.
- Use the "B" (Bulb) setting.
- Use a Nikon Speedlight other than the SB-103, SB-102 or SB-101.
- Use the "M90" (1/90 sec.) setting.

1. Estimate or measure the camera-to-subject distance\*.
2. Unlock the shutter release button.
3. Set the shutter speed/mode selector dial and the aperture index to the desired shutter speed and f/stop, respectively.
4. Look through the viewfinder, compose the scene, and gently depress the shutter release button half-

\* See page 59 for more information.

way to activate the meter. The viewfinder LED indicator which corresponds to the shutter speed you selected will light. If, at the same time, one or two other shutter speed LEDs blink, the camera's microcomputer has determined that a different shutter speed is needed to obtain the correct exposure with the existing scene brightness and aperture.

To obtain the correct exposure, rotate either the lens aperture knob (in the case of the LW-Nikkor, rotate its aperture ring) or the shutter speed/mode selector dial until only one shutter speed LED remains lighted.

If the LED overexposure warning arrow (◀) blinks, either turn the shutter speed/mode selector dial to a faster shutter speed or set the lens to a smaller

# CONTROLS IN DETAIL—continued

Overexposure warning

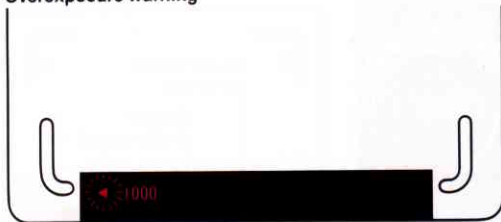

aperture (a larger f-number). If the arrow continues to blink even when the shutter speed/mode selector dial is set to "1000" (1/1000sec.) and the lens is set to its smallest aperture (the largest f-number), either use a neutral density filter or change to a film with a lower ASA/ISO film speed.

If the LED underexposure warning arrow (▶) blinks, either turn the shutter speed/mode selector dial to a slower shutter speed or set the lens to a larger aperture (a smaller f-number). If the arrow continues to blink even when the shutter speed/mode selector dial is set to "30" (1/30sec.) and the lens is set to its largest aperture (the smallest f-number), either use a Nikon Speedlight or change to a film with a higher ASA/ISO film speed. (For Speedlight information, see page 50).

Underexposure warning

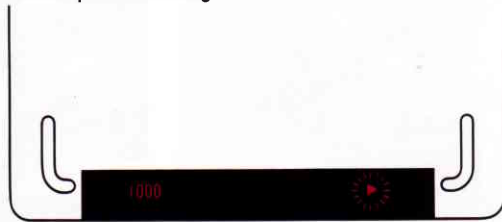

- If two shutter speed LED indicators light at the same time, it means an intermediate shutter speed will provide the correct exposure. Therefore, turn the lens aperture knob (in the case of the LW-Nikkor, turn its aperture ring) slightly until only one LED remains lighted.
- When the shutter speed/mode selector dial is set at either M90 or B, the exposure meter does not work nor do the LED viewfinder indicators light. When the dial is set at R, the shutter is automatically locked.
- To create a special photographic effect through an intentional over- or underexposure, set either the lens aperture knob (in the case of the LW-Nikkor, set its aperture ring) or the shutter speed/mode selector dial so that at least two non-adjacent LED indicators are lighted.

## How to select the f/stop and shutter speed

Exposure is determined by the combination of shutter speed and aperture. As the numbers on either the aperture scale or shutter speed/mode selector dial increase by one increment, the amount of light striking the film is reduced by approximately one half. For example, the amount of light at 1/250sec. is one half that at 1/125sec., but the amount of light at 1/60sec. is twice that at 1/125sec. Likewise, the amount of light at f/16 is one half that at f/11, but the amount of light at f/8 is twice that at f/11. Brighter scenes require either faster speeds or smaller apertures or a combination of both which will give the same amount of exposure; darker scenes require the reverse.

For example, if you obtain the correct exposure with the combination of 1/125sec. and f/11, you will also obtain the correct exposure with the combination of 1/60sec. and f/16, and with 1/250sec. and f/8.

For more information about depth of field, see page 45.

### Shutter speed/aperture combinations that give the same exposure

Shutter speed (sec.)	1/1000	1/500	1/250	1/125	1/60
Aperture (f/number)	4	5.6	8	11	16

## EV Range of the Camera

EV is the abbreviation for Exposure Value. With ASA/ISO 100 film and an f/2.8 lens, the exposure value range of the Nikonos-V is between EV 8 and EV 19 (1/30sec. at f/2.8 to 1/1000sec. at f/22). These shutter speed/aperture combinations are not affected by ASA/ISO film speed. That is, the Nikonos-V's shutter speed/aperture combinations are always 1/30sec. at 2.8 to 1/1000sec. at f/22 at any film speed from ASA/ISO 25 to 1600.





## Shutter Release Lock Lever ⑥

This convenient lever prevents film wastage and inadvertent battery drain caused by accidentally depressing the shutter release button when the camera is not in use. When storing or carrying the camera, lock the shutter release button by sliding the lever to the "L" position. To unlock the shutter release button, slide the lock lever off the "L" position.

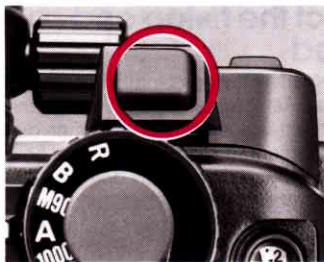

## Shutter Release Button ⑤

Located at the top of the anatomical grip, the large shutter release button on the Nikonos-V provides convenient operation either above or below the water. When gently depressed halfway, this button activates the exposure meter. After you remove your finger from the button, the meter stays for approximately 16sec. and then automatically turns itself off to conserve battery power. Because the shutter release button activates the viewfinder LEDs when the shutter speed/mode index is opposite any setting **except** M90 (1/90sec.), B (Bulb), or R (Rewind), the shutter release button can be used as a battery check. At M90 (1/90sec.), B (Bulb), and R (Rewind), and until the frame counter reaches "1," the viewfinder LEDs do not appear. Remember that the shutter release button should be depressed gently, not rapidly, to



## ASA/ISO Film Speed Dial 26

release the shutter. Also avoid shaking or moving the camera when releasing the shutter.

- *When you release the shutter at "A" in a very dark place or with the front lens cap on, the shutter curtain may remain open. If this happens, turn the shutter speed/mode selector dial to another setting to close the shutter.*
- *The shutter will not be released when the film has not been advanced, when the shutter release button is locked, nor when the shutter speed/mode selector dial is set at "R."*

Providing ASA/ISO settings from 25 to 1600, the film speed dial is set by lifting up the knurled ring and rotating it until the desired speed is opposite the white index. When the ring is released, it locks into place. The dial can be rotated even underwater without water getting inside the camera.

The white dots between the numbers on the dial represent intermediate film speed settings. (See the adjacent chart at page 23.).

- *Setting the correct ASA/ISO film speed value is essential to the proper operation of the camera, since the ASA/ISO film speed in use is one of the three pieces of information (the other two being the shutter speed in use and the scene brightness) used by the camera's microcomputer to determine the correct exposure.*



## Frame Counter ④

To accommodate all commercially available film cartridges, the Nikonos-V frame counter goes up to 36. The "S" appears automatically as soon as the camera back is opened and signifies the "START" position. There are two dots between "S" and "1" to indicate blank exposures. After "1," even numbers are listed and odd numbers are indicated by dots in between. The most frequently used numbers—**12, 20, 24,** and **36**—are in red. The frame counter will advance one stop with each complete stroke of the film advance lever, regardless of whether or not there is film in the camera. The frame counter will not advance after it reaches 36, but the film can be wound and the shutter can be cocked.

- Do not begin shooting until the frame counter reaches frame "1."
- When the shutter speed/mode index is opposite any setting **except** M90 (1/90sec.), B (Bulb), or R (Rewind), the shutter will be automatically released at approximately 1/1500sec. until the frame counter reaches frame "1," regardless of the scene brightness and the film speed in use.
- After the frame counter reaches frame "1," the camera automatically returns to the mode you have selected.



## Film Advance Lever ①

The film advance lever on the Nikonos-V operates in the same manner as that of a regular 35mm camera. To cock the shutter and advance the film to the next frame, stroke the lever counterclockwise until it stops. When you remove your finger, the lever will automatically return. The lever is ratcheted, so it may be operated in one continuous stroke or a series of shorter ones. In addition, the lever is hinged for compact storage in the rest position. The angle of throw is 144°.

- If the lever becomes increasingly difficult to stroke when winding several frames, the film is improperly advancing. Do not force the lever further; instead, rewind the film and load it again.
- When all available frames have been exposed, the lever will stop advancing. Do not force the lever further; instead, rewind the film.

## Exposure Compensation

When the overall scene is unusually light or dark in tone or there is a substantial difference in contrast between the main subject and the background (for example, backlit subjects or snowscapes), the camera's meter may be fooled into giving the incorrect exposure. In these cases, exposure compensation—via the ASA/ISO film speed dial—is required to obtain the correct exposure. To do this, intentionally reset the ASA/ISO film speed dial.

# CONTROLS IN DETAIL—continued

**Exposure Compensation in the A mode:** To make an exposure compensation with the ASA/ISO film speed scale, determine the film speed that corresponds to the desired exposure compensation value by using the following chart.

For example, to make a +1 exposure compensation when using ASA/ISO 100 film, reset the ASA/ISO film speed scale to ASA/ISO 50.

② \ ①	+2	+1½	+1	+¾	+½	0	-½	-¾	-1	-1½	-2		
32	—	—	—	—	—	25	32	40	50	64	80	100	125
64	—	—	25	32	40	50	64	80	100	125	160	200	250
100	25	32	40	50	64	80	100	125	160	200	250	320	400
200	50	64	80	100	125	160	200	250	320	400	500	640	800
400	100	125	160	200	250	320	400	500	640	800	1000	1250	1600
1000	250	320	400	500	640	800	1000	1250	1600				

① Exposure compensation value

② Film speed in use

**Exposure Compensation in the manual mode (1/30sec. to 1/1000sec.):** To make an exposure compensation, set either the lens aperture knob (in the case of the LW-Nikkor, set its aperture ring) or the shutter speed/mode selector dial so that at least two non-adjacent LED indicators are lighted (one LED indicates the shutter speed you select, one indicates the shutter speed the camera's microcomputer se-

lects). Another method is to move close to the subject (or position it in the center of the viewfinder) and obtain an exposure reading; then set the controls accordingly and step back (or change the position of the subject in the viewfinder). When you release the shutter, the result will be a properly exposed photograph.

- *This technique can also be used to create intentional over- and underexposures in normal lighting. The proper amount of exposure compensation can be determined through trial and error.*

- **Be sure to return the ASA/ISO film speed dial to the correct setting after you have finished your exposure compensation.**

- *It is difficult to use exposure compensation when shooting underwater in harsh lighting conditions. An alternative is to "bracket" your shots: take one shot at the indicated correct exposure, and one each at the next largest and smallest f/stops (or next fastest and slowest shutter speeds).*

- *Generally speaking, a +2 exposure compensation is required when shooting subjects against snowscapes and similar situations, but that value will not always provide the correct exposure. For best results, use an 18% reflectance gray card (available at most camera stores) for precise exposure metering rather than using the ASA/ISO film speed dial. TTL exposure meters are calibrated to provide the correct exposure when an 18% reflectance gray card is used. If you do not have a gray card, hold the palm of one hand at least a foot in front of the lens in the same light as your main subject and let the camera meter your hand for the correct exposure.*

## Depth Of Field

When you shoot at a certain aperture and focusing distance, you will find that not only the main subject but also objects within a certain range in front and behind it will be sharp in the final photograph. This "in-focus zone" is known as depth of field. Objects beyond this range become increasingly out of focus. Because the Nikonos-V features aperture-priority automatic exposure, you can control depth of field by varying the f/stop. When the zone of sharpness is large, depth of field is "deep"; when it is small, depth of field is "shallow."

For any individual lens:

- The smaller the aperture (the larger the f-number), the deeper the depth of field; the larger the aperture (the smaller the f-number), the shallower the depth of field.
- Depth of field becomes deeper the farther the subject is from the lens; the depth of field becomes shallower the closer the subject is to the lens.
- Depth of field behind the main subject is deeper than in front of it.

Between lenses of different focal lengths: longer focal length lenses have shallower depth of field at each f/stop; shorter focal length lenses have deeper depth of field at each f/stop.

As you open and close the aperture, the pincer-type depth-of-field indicators open and close to show the distance range which will be in focus in the final photograph. (In the case of the LW-Nikkor, depth of field is indicated by pairs of colored depth-of-field index lines on the aperture scale.)

For example, with the standard W-Nikkor 35mm f/2.5 lens, when the lens focusing knob is set at 3m and the lens aperture knob at f/16, the indicators show that all objects between 1.5m and infinity ( $\infty$ ) will be in focus in the final photograph.

- *To minimize any errors you may have made when measuring or estimating the subject distance or focusing, use the smallest aperture (the largest f-number) possible. Alternately, move farther from the subject or use a lens with shorter focal length.*

# CONTROLS IN DETAIL—continued

## Different Depths Of Field



f/2.5—Shallow depth of field



f/22—Deep depth of field

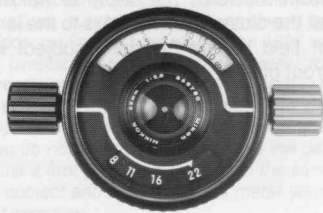

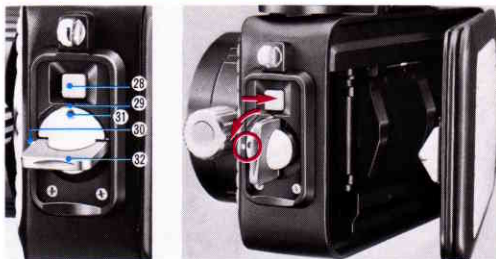

## Camera Back Lock System

This newly designed system allows quick and easy film loading in the normal 35mm camera way.

To allow the camera back to be opened or closed in a minimum amount of time, a quick-release camera back release/lock latch (32) is employed. It can be opened after turning it 90° in the direction of the arrow on the camera body while depressing the orange camera back release/lock button (28), thereby aligning the red camera release/lock mark (31) on the latch with the white camera back release index (30) on the camera body. Before closing the camera back, align the red mark with the white index, then firmly press the camera back against the body and turn the latch until its red mark clicks into position opposite the red index (29).

Naturally, you should never attempt to load or unload the camera underwater or in situations where water might get inside the camera.



## CONTROLS IN DETAIL — continued

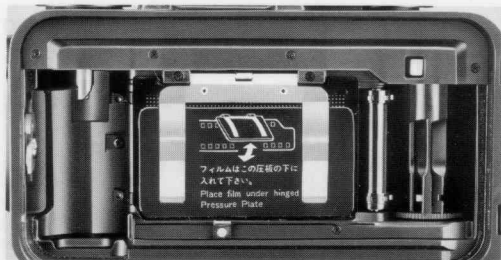

### Pressure Plate ③⑤

Instead of being attached to the camera back, the Nikonos-V's pressure plate is attached to the inside of the camera and is hinged. This style pressure plate uses a safety catch to keep the film flat, and to protect the shutter curtains from accidental splashes or foreign matter when the camera back is open.

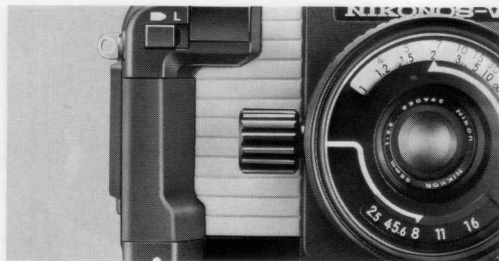

### Anatomical Grip ⑦

By placing your right forefinger on the shutter release button with the thumb behind the film advance lever, your other fingers naturally wrap around the anatomical grip. With this comfortable and secure hold, you can change rapidly from horizontal- to vertical-format shooting.

One of the biggest causes of blurred pictures is camera shake. When you release the shutter, support the camera with both hands and depress the shutter release button gently, not rapidly. Underwater, weightlessness makes it even more difficult to hold the camera steady, so concentrate on steadiness even when using fast shutter speeds.

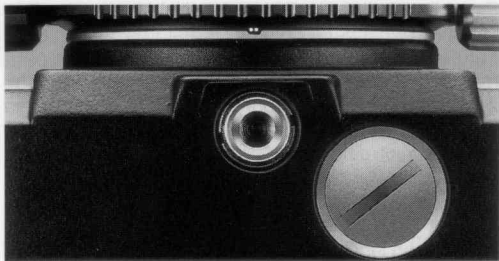

### Tripod Socket 44

A standard tripod socket is located in the camera's baseplate for attachment of the brackets for the Nikonos Underwater Speedlights SB-103, SB-102 and SB-101. A regular tripod can also be used for shooting on land at slow shutter speeds or when making time exposures.

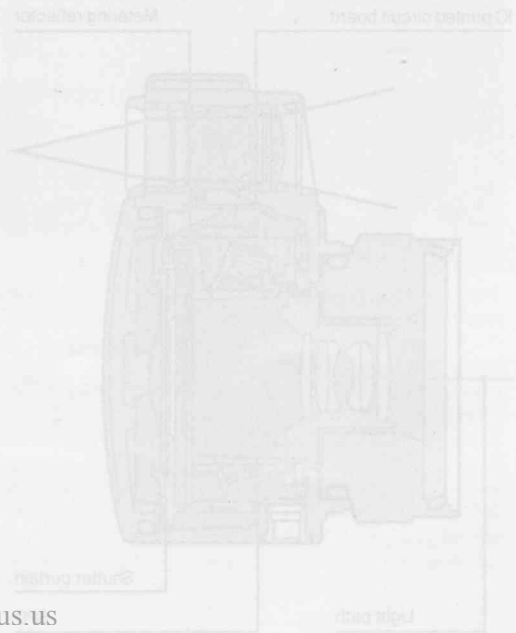

www.butkus.us

# FLASH PHOTOGRAPHY

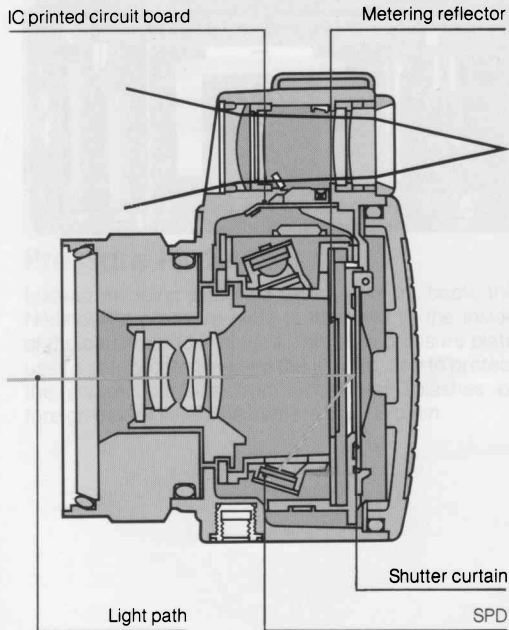

Except at shallow depths, a speedlight is a must when shooting underwater because it restores the subject's natural colors. A speedlight is also convenient as a main light source at night and in dim light as well as a supplemental light source to fill in shadows in daylight.

A number of different speedlights can be used with the Nikonos-V, including the new dedicated speedlight, the SB-103 or SB-102, and the SB-101—both of which can be used both on land and underwater. When shooting on land, you can also use Speedlights SB-19, SB-18, SB-16B, SB-15, and SB-E.

To simplify flash photography even further, the Nikonos-V features fully automatic through-the-lens (TTL) flash exposure control. While the shutter is open, a silicon photodiode (SPD) at the bottom of the shutter box reads the light as it reflects off the film; when the film has received enough light for correct exposure, the flash unit turns off. TTL flash exposure control is operable with the SB-103 or SB-102, which connects directly to the camera, and the SB-18, SB-16B and SB-15, which connect to the camera through a sync cord. The Nikonos-V can also be used with a variety of Nikon TTL Multiple Flash photographic accessories. Before shooting, check that the aperture setting is adequate for the flash-to-subject distance and the guide number of the speedlight in use.

The Nikonos-V, which has only an X-contact, synchronizes with speedlights when the shutter speed set is 1/90sec. or slower. (Shutter speed sync ranges are shown in the following chart.)

- When connecting a special electronic flash unit with a provision for time lag, set the shutter speed at 1/60sec. or slower depending upon the time lag.
- Connecting other manufacturers' flash units may damage the Nikonos-V's IC circuitry. Also, units with a high-voltage sync circuit may adversely affect shutter speed precision.

Shutter speed (sec.)	1/1000	1/500	1/250	1/125	1/60	1/30	M90	B
Speedlight								

 : Synchronized

 : Cannot be used

[www.butkus.us](http://www.butkus.us)

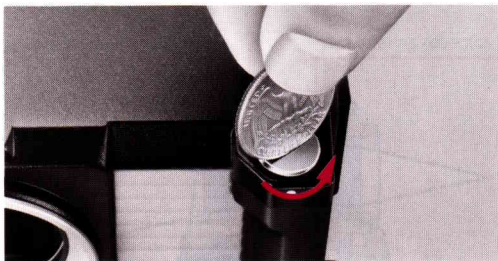

## Flash Socket

The flash socket is located in the camera's baseplate just below the anatomical grip. Use a coin to unscrew the flash socket cover (42). Like the battery chamber cover, it has an O-ring to make it watertight. Once the cover is removed, electrical connection between the camera and the Nikonos Speedlight SB-103, SB-102 or SB-101 can be made with the coiled sync cord. Since the Nikonos-V's flash socket provides X-sync only, flash units using flashbulbs **cannot** be used. An optional sync cord allows other Nikon speedlights to be used with the Nikonos-V on land.

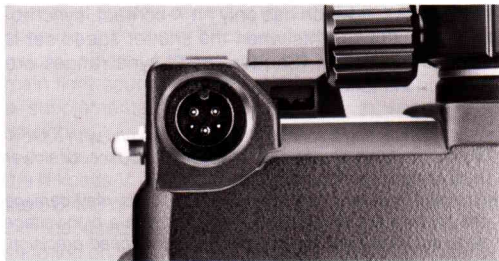

- **After each underwater shooting session, examine the flash socket cover's O-ring and apply lubrication if necessary. See "PREPARATION" on page 7 for more information.**
- **Whenever a sync cord is not being used, be sure the flash socket cover is screwed tightly into place; if water seeps past, it will be almost impossible to remove. If water does enter the flash socket, contact an authorized Nikon dealer or service center immediately or corrosion may damage the electrical contacts and circuitry.**

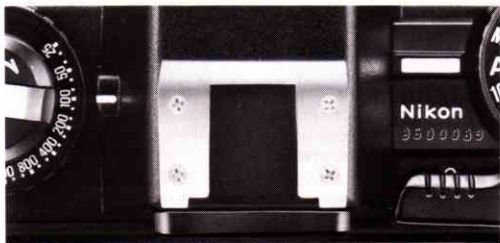

## Accessory Shoe 13

Built into the top of the viewfinder, the Nikonos-V's accessory shoe accepts the following accessories:

1. Four optical viewfinders: DF-11 for UW-Nikkor 15mm f/2.8N; DF-12 for the UW-Nikkor 20mm f/2.8 (and for UW-Nikkor 28mm f/3.5 via mounting mask); DF-10 for Nikkor 80mm f/4; and "Optical Viewfinder for UW-Nikkor 28mm f/3.5" (also for W-Nikkor 35mm f/2.5 via mounting mask).
2. Two plastic frame finders—one for the UW-Nikkor 28mm f/3.5, the other for both W-Nikkor 35mm f/2.5 and Nikkor 80mm f/4.
3. Sensor Unit SU-101 for Nikonos Speedlight SB-102 and SB-101 or on-land use with dedicated direct-mounting Nikon Speedlights.

[www.butkus.us](http://www.butkus.us)

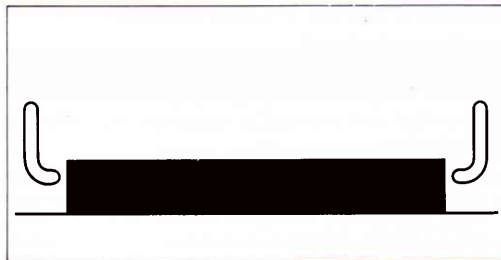

## Viewfinder Ready-Light

The Nikonos-V's thunderbolt-shaped ready-light is located in the lower righthand corner of the viewfinder next to the LED underexposure warning arrow.

When the SB-103 or SB-102 Speedlight is being used and both the speedlight and the camera's exposure meter are turned on, the ready-light lights when the speedlight has recycled and goes out when the shutter is released. This enables you to keep your eye to the viewfinder at all times. As a warning, the ready-light blinks when the flash output is insufficient, the camera's ASA/ISO film speed dial is misset, or the shutter speed/mode selector dial is set to M90 (1/90sec.) or B (Bulb) for TTL flash operation.

# FLASH PHOTOGRAPHY—continued

## Camera meter, shutter speed, and ready-light

The relationship between the recycling of the flash unit, the camera's shutter speed, and the ready-light (if the flash unit provides a ready-light indication) is shown below.

• If the shutter speed/mode selector dial is set at "A" or at any shutter speed setting from 1/1000 to 1/125 sec., the shutter speed automatically switches to 1/90 sec. when the speedlight is turned on, regardless of whether or not it has recycled. When the shutter speed/mode selector dial is set at 1/60 or 1/30 sec., the shutter will be released at the speed selected.

- The Nikonos-V's automatic TTL flash exposure control is not operable when the shutter speed/mode selector dial is set at M90 (1/90 sec.) or B (Bulb).
- If the ready-light does not light after a shot, check the battery power in the following manner.
  1. If the flash unit's ready-light does not light, the flash unit's batteries are exhausted and must be replaced with a fresh set.
  2. If the camera's meter is on and the flash unit's ready-light lights but the viewfinder ready-light does not light or blink, the camera's battery (or batteries) is (are) exhausted and must be replaced with a fresh one (or set).

Shutter speed/mode selector dial	Meter on		Meter off	
	Viewfinder ready-light	Shutter speed	Viewfinder ready-light	Shutter speed
A (Auto)*	lights	1/90 sec.	doesn't light	—
1/1000 to 1/125 sec.	lights	1/90 sec.	doesn't light	—
1/60 to 1/30 sec.	lights	as set	doesn't light	—
M90 or B	→	→	lights	as set

\* Select and set a useable aperture; aperture-priority automatic exposure is not operable when using a speedlight. However, the shutter speed you selected and shutter speed selected by the camera's microcomputer light are indicated by the viewfinder LEDs in the same manner as when operating in manual mode.  
Download from [www.Sonmanuals.com/](http://www.Sonmanuals.com/) All Manuals Search And Download.

## Nikonos-V/Speedlight Combination Chart

Situation	Speedlight	Connection	Ready-light operates	Flash output control
Underwater (also usable on land)	SB-103	Direct	Yes	TTL/manual
	SB-102	Direct	Yes	TTL/auto/manual
	SB-101	Direct	Yes	Auto/manual
On land	SB-17/SB-16A/SB-12	Via V-Type Sync Cord + AS-6	Yes	Auto/manual*
	SB-18/SB-16B/SB-15	Via V-Type Sync Cord	Yes	TTL/auto/manual*
	SB-19/SB-E	Via V-Type Sync Cord	Yes	Auto
	SB-11/SB-14	Via V-Type Sync Cord + SC-13 with SU-2	Yes	Auto/manual
		Via V-Type Sync Cord + SC-23	Yes	TTL/manual*

- Except with the SB-12, TTL multiple flash photography is possible with the optional TTL Multi-Flash Sync Cord SC-19 and/or SC-18. For TTL multiple flash photography, SB-17 and SB-16A should be used as slave flash units. For details, see instruction manual of accessories for TTL multiple flash photography.
- When connecting a Nikon speedlight to the Nikonos-V with the Nikonos IV-A's Flash Unit Adapter and the SC-10 Sync Cord for use on land, reset the shutter speed/mode selector dial to 1/60, 1/30 or M90 (1/90sec.).



# FLASH PHOTOGRAPHY—continued

## Daylight fill-in flash shooting

When shooting in daylight, a backlit subject may come out almost as a silhouette if the background is correctly exposed. If, on the other hand, exposure compensation is made to correctly expose the subject, the background may be washed out. To fill in the shadows and balance the illumination levels of the subject and the background in daylight shooting, use the SB-103 or SB-102 Speedlight.

When the speedlight is turned on, the shutter speed automatically switches to 1/90sec. Point the camera at the main subject and gently depress the shutter release button halfway to activate the camera's exposure meter. When the meter is on and the flash has recycled, the viewfinder ready-light will light and one of the shutter speed LED indicators will blink. To obtain the correct exposure, adjust the aperture to numerically larger f-numbers until both the 1/125sec. and 1/60sec. shutter speed LEDs begin blinking, or until either the 1/60sec. or 1/30sec. LED indicator blinks. Check that the viewfinder ready-light is lighted, then depress the shutter release button completely.

For best results, follow this procedure whenever any of the shutter speed LEDs from "125" to "1000" blinks during daylight fill-in flash shooting unless you intentionally want to over- or underexpose a shot.

For more information, refer to the speedlight instruction manual.

## EV Chart

At ASA/ISO 100, the exposure range of the Nikonos-V is from EV 8 (1/30sec. at f/2.8) to EV 19 (1/1000sec. at f/22). The ranges at various film speeds are shown in the chart. For example, the range at ASA/ISO 100 is in pink, the range at ASA/ISO 25 is indicated by blue lines, and the range at ASA/ISO 400 is indicated

by black lines. The exposure value (EV) is a number representing the various combinations of apertures and shutter speeds that will provide the same exposure. For instance, EV 10 represents 1/30sec. at f/5.6, but it can also mean 1/60sec. at f/4 or 1/125sec. at f/2.8.

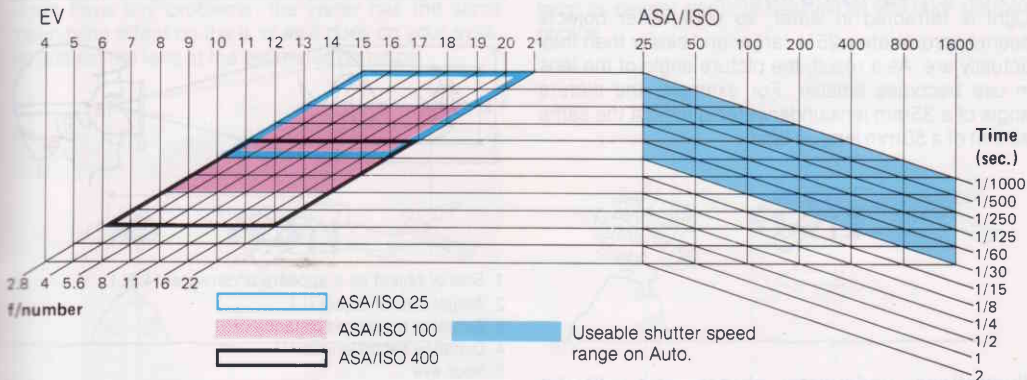

www.butkus.us

# TIPS ON UNDERWATER PHOTOGRAPHY

The results you will obtain when shooting underwater depend upon the transparency of the water, the shooting depth, whether or not objects are floating near your subject, the condition of the light, and several other factors. To take good underwater photos, you must have a basic knowledge of underwater photography.

## Water's magnifying effects

Light is refracted in water, so underwater objects seem approximately 25% larger and closer than they actually are. As a result, the picture angle of the lens in use becomes smaller. For example, the picture angle of a 35 mm lens underwater is almost the same as that of a 50mm lens on land.

## Lens focal length and picture angle

Focal length (mm)	On land	Underwater
	Picture angle	Picture angle
15	—	94°
20	—	78°
28	74°	59°
35	62°	46°30'
80	30°20'	22°45'

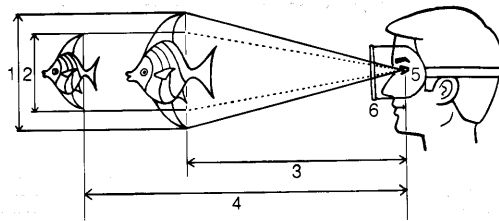

- 1 Size of object as it appears underwater ( $4/3L$ )
- 2 Actual size of object ( $L$ )
- 3 Actual or measured distance ( $l$ )
- 4 Distance set on lens ( $3/4l$ )
- 5 Your eye
- 6 Underwater mask

Illustrations, underwater photos, and editorial supervision supplied by Akira Tateishi, Marine Art Center, Co., Ltd.

## Focusing

The distance scales on the interchangeable lenses for the Nikonos-V are correct for on-land use. When using these lenses underwater, therefore, you must set the distance scale to  $3/4$  of the actual or measured camera-to-subject distance. For example, if the actual or measured camera-to-subject distance is 1.33 m (4.3 ft), the distance scale should be set at 1 m (3.3 ft). If you estimate the distance underwater, though, you won't have any problems; the water has the same magnifying effect on the lens as it does on your eyes. So just set the lens at the estimated distance.

When shooting underwater, you will probably find it more convenient to keep the lens set at a specific distance and reposition yourself at that distance from the subject than to set the distance for each subject. When taking photos of fish, set the lens to a specific distance and then release the shutter when the fish swims to that distance.

For best results underwater, shoot with a wide-angle lens; its deeper depth of field will let you take sharper photos.

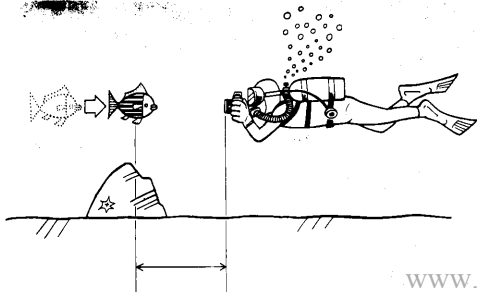

**Wait for the subject to move to the prefocused distance.**

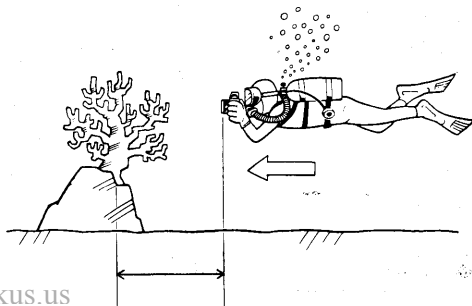

**Move to the prefocused distance.**

[www.butkus.us](http://www.butkus.us)

# TIPS ON UNDERWATER PHOTOGRAPHY—continued

## Water's effects on colors

The farther you descend from the water's surface, the more the selective filtration and light absorption of the water reduce visibility. Red is the first color to be absorbed, orange and yellow follow close behind (refer to the chart).

At 10m (33ft), everything takes on a blue-green cast. In addition, depending upon the turbulence of the water, visibility may be reduced even further by silt and microscopic particles of plankton in suspension. Therefore, below approximately 5m (16ft), use a speedlight to give the subject additional illumination and to restore natural colors, especially those in the red portion of the spectrum. For more information about flash shooting, see page 50.

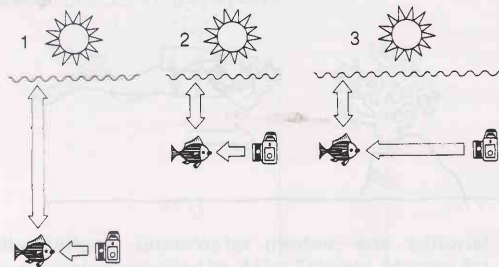

1. Red absorption increases at greater depths. Subject looks bluish even at short distances.
2. Red absorption decreases at shallower depths and at smaller distances.
3. Subject looks increasingly bluish at greater distances, even at shallow depths.

## Color Absorption Underwater

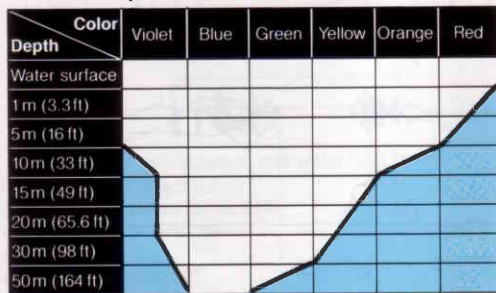

— = color is absorbed

## Shooting distance and subject contrast

The greater the camera-to-subject distance underwater, the less the subject contrast. Small particles of plankton or dirt that float in the water decrease the subject contrast to such a degree that, even under ideal conditions, it is next to impossible to take a sharp photo when the camera-to-subject distance is more than 5m (16ft). For best results, get as close to the subject as possible and use the widest angle lens you have. Be careful, too, when using a speedlight that you aren't so far from the subject that sufficient light cannot reach it.

## Shooting with sunlight

Good underwater photography requires good lighting, such as sunlight. But the amount of sunlight that enters the water depends upon the position of the sun. The maximum amount of light enters the water when the sun is directly overhead. If the angle between the sun and the water's surface is at least  $45^\circ$ , though, more than 90% of the sun's light enters the water. (The chart below shows the relationship of the angle between the sun and water and the amount of sunlight that enters the water.) For best results, pick a calm, sunny day and dive between the hours of 10:00a.m. and 2:00p.m. If there are waves and swells, or if the waves break against rocks nearby and foam, less sunlight will enter the water.

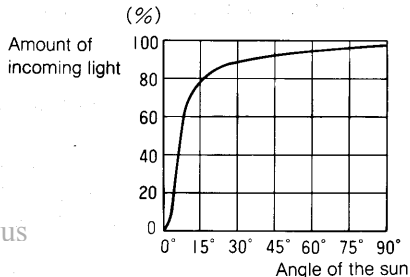

[www.butkus.us](http://www.butkus.us)

# TIPS ON UNDERWATER PHOTOGRAPHY—continued

## Camera positioning

For normal shooting, hold the camera horizontally for subject lighting with good contrast (illustration #4). Whenever possible, avoid shooting straight down on the subject (illustration #1); the sunlight will be behind the camera, resulting in flat, low-contrast lighting.

As it is on land, backlighting is possible underwater. For partially backlit subjects with medium-contrast lighting, hold the camera at an angle toward the water's surface (illustration #2). For dramatic backlit scenes in which objects appear as silhouettes, point the camera directly toward the water's surface (illustration #3). If more detail in the silhouetted subject is desired, make an exposure compensation by resetting the ASA/ISO film speed dial to a lower number (this can be done underwater), by switching to the manual mode, or by using a speedlight. For example, with ASA/ISO 400 film, reset the dial to ASA/ISO 200 for a one-stop exposure increase or reset the dial to ASA/ISO 100 for a two-stop increase.

**After taking the shot, do not forget to reset the dial to its original position.**

## Best depth of water for AE shooting

If the water is very transparent, you can use the Nikonos-V in the A mode down to 20m (65.6ft), but most pictures will come out bluish because of the light absorption of the water. Diving deeper will not ensure better photographs; most subjects underwater are no more than 10m (33ft) below the water's surface. For results, dive in shallow areas and do not attempt to take pictures below a depth of 4 to 5m (13 to 16ft). If you want to shoot below this depth, use a speedlight to restore the subject's natural colors.

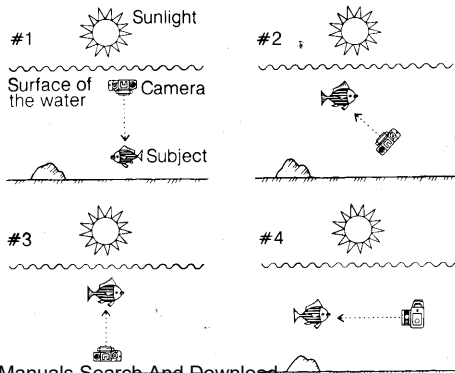

## Film choice

Using film with a speed of ASA/ISO 400 or higher will allow you to use faster shutter speeds, thereby minimizing the effects of camera movement as much as possible.

## When to use a speedlight

### 1) To restore natural colors to the subject

When shooting color film without a speedlight, your photos will come out bluish because of the selective filtration and light absorption of water. Using a speedlight will allow you to capture the subject in all its splendor.

### 2) To add illumination to the subject

When shooting a subject that is partially in darkness (such as the inside of an underwater cave or a face behind a diver's mask), use a speedlight to provide more illumination.

## Underwater photography and speedlight guide numbers

Because of the light absorption of water, the guide number of a speedlight is lower underwater than it is on land. Also, because the transparency of the water varies from situation to situation, it is difficult to calculate the aperture setting from the guide number. As a rule of thumb, use the following formula to calculate the aperture from the guide number when using a speedlight in fairly transparent water.

$$\frac{(1/2 \text{ to } 1/3) \text{ Guide Number}}{\text{Flash-to-subject Distance}} = f/\text{stop}$$

Poor visibility may reduce the maximum shooting distance and guide number even further. For best results, take the first shot at the recommended exposure, then take two additional shots with the lens at the next two numerically smaller f-numbers.

To compensate for light loss in the A mode, use the Sensor Unit SU-101 when using the SB-101 in the automatic mode. Even though the maximum shooting distance will be cut in half, you will still obtain the correct exposure. When shooting manually, divide the speedlight guide number by two. In the TTL mode, the SB-103 or SB-102 automatically provides the correct flash exposure.

[www.butkus.us](http://www.butkus.us)



# TIPS ON UNDERWATER PHOTOGRAPHY—continued

## Flash shooting tips

To prevent light from being scattered by suspended particles and then being reflected directly back into the lens, position the flash head as far away from the lens as possible. If necessary, remove the flash from its bracket and hold it off to the side and slightly above the subject. If sand is kicked up from the seabed (see Photo 1), wait until it settles before shooting (see Photo 2). Finally, remember that water absorbs the light from the speedlight, too.

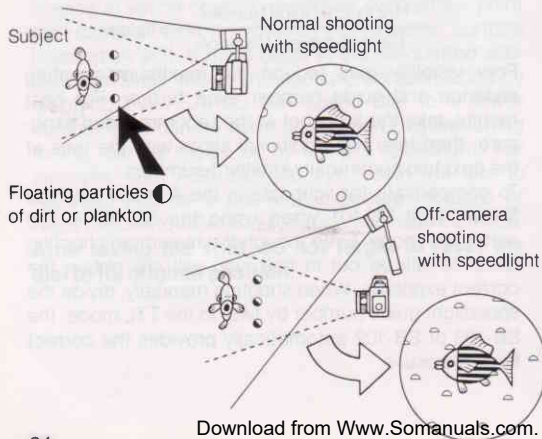

Photo 2

# ACCESSORIES

## Nikonos Speedlight SB-103

A compact version of the field-proven SB-102, this new direct-mounting unit has automatic through-the-lens (TTL) flash exposure control (with the Nikonos-V) as well as manual. Thanks to TTL automatic flash output control, the range of useable apertures widens to make photography easier than ever.

Area of coverage is that of a 28mm lens; with the Wide-Flash Adapter SW-103 (provided), area of coverage increases to that of a 15mm lens.

The SB-103 also features TTL multiple flash capability through the optional Double Flash Bracket and Double Sync Cord. Use two SB-103s or one SB-103 and one SB-102 and broaden your underwater photography capabilities.

The SB-103 couples with the Nikonos-V's viewfinder ready-light to indicate when the flash has charged and to warn if the camera's settings are outside the flash coupling range.

In addition, when the camera's shutter speed/mode selector dial is set at any setting except "M90" (1/90sec.), B (Bulb), or R (Rewind), the shutter speed automatically switches to 1/90sec. when the speedlight is turned on. (See the chart on page 54 for more information.)



SB-103

SB-102

[www.butkus.us](http://www.butkus.us)

# ACCESSORIES — continued

## Nikonos SB-102

This powerful (GN 32) and versatile speedlight offers TTL (with the Nikonos-V), Auto (useable with the optional Sensor Unit SU-101) and manual flash controls.

Like the SB-103, area of coverage is that of a 28mm lens; with the Wide-Flash Adapter SW-102 (provided), area of coverage increases to that of a 15mm lens. Viewfinder indicators and shutter synchronization speed are the same as the SB-103. (See the chart on page 54 for more information.)

The SB-102 has multiple flash capability (with or without cord), through the built-in slave sensor or the optional Double Flash Bracket and Double Sync Cord, and also features a target-light for close-up shooting. The target-light, positioned in the center of the flash head, shoots a beam of light at the subject to help you aim the flash head at the subject.

## V-Type Sync Cord

One end of the cord connects to the camera's flash socket; the other has a hot shoe which attaches to the camera's accessory shoe. Thus, any electronic flash unit with a standard ISO-type mounting foot, such as Nikon Speedlights SB-18, SB-16B or SB-15, can be used with the Nikonos-V for on-land flash photography. By using TTL Remote Cord SC-23 in conjunction with a V-Type Sync Cord, a bracket-mounting type flash unit such as Nikon Speedlight SB-14 or SB-11 can be

used. TTL automatic flash exposure control is possible with these flash units, as is TTL multiple flash photography.

## IV-A-Type Sync Cord SC-10

One end of this cord connects to the camera via the flash unit adapter for the Nikonos IV-A; the other end has a hot shoe which attaches to the accessory shoe. Thus, any electronic flash unit with a standard ISO-type mounting foot, such as Nikon Speedlights SB-18, SB-16B, and SB-15, can be used with the Nikonos-V for on-land flash photography. However, automatic TTL and TTL multiple flash photography are not possible.

## Nikonos Interchangeable Lenses

### Relationship between picture angle and focal length



15mm



28mm



# ACCESSORIES — continued

## UW-Nikkor 15 mm f/2.8N, UW-Nikkor 20 mm f/2.8, and UW-Nikkor 28 mm f/3.5

Designed exclusively for underwater use, these UW-Nikkor lenses can be used to a depth of 50mm (160ft). The optics are corrected exclusively for underwater aberrations and provide excellent underwater photographs. Also, Nikon Integrated Coating (NIC) is applied to internal air-to-glass surfaces to minimize ghost images and flare. For each lens, an optional optical viewfinder is available for quick determination of field of view.

### Main Specifications

#### UW-Nikkor 15 mm f/2.8N

<b>Lens construction:</b>	12 elements in 9 groups (including watertight front cover glass)
<b>Picture angle:</b>	94° (underwater)
<b>Distance scale:</b>	Graduated in meters and feet from 0.3m (1ft) to infinity ( $\infty$ ) with secondary scales from 0.22 to 0.25 m (0.7 to 0.9ft)
<b>Aperture scale:</b>	f/2.8 to f/22
<b>Attachment size:</b>	87 mm (P = 0.75 mm)
<b>Dimensions:</b>	Approx. 93 mm dia x 90.6 mm long (overall)
<b>Weight:</b>	Approx. 665 g

#### UW-Nikkor 20 mm f/2.8

<b>Lens construction:</b>	9 elements in 7 groups
<b>Picture angle:</b>	78° (underwater)
<b>Distance scale:</b>	Graduated in meters and feet from 0.4 m (1.3ft) to infinity ( $\infty$ )
<b>Aperture scale:</b>	f/2.8 to f/22
<b>Attachment size:</b>	67 mm (P = 0.75 mm)
<b>Dimensions:</b>	Approx. 70 mm dia. x 74 mm long (overall)
<b>Weight:</b>	Approx. 350 g

#### UW-Nikkor 28 mm f/3.5

<b>Lens construction:</b>	6 elements in 5 groups
<b>Picture angle:</b>	59° (underwater)
<b>Distance scale:</b>	Graduated in meters and feet from 0.6m (2ft) to infinity ( $\infty$ )
<b>Aperture scale:</b>	f/3.5 to f/22
<b>Attachment size:</b>	58 mm (P = 0.75 mm)
<b>Dimensions:</b>	Approx. 62mm dia. x 43.8 mm long (overall)
<b>Weight:</b>	Approx. 175 g

UW-Nikkor 15 mm f/2.8N mounted on  
Nikonos-V with Optical Viewfinder DF-11



UW-Nikkor 20 mm f/2.8 mounted on  
Nikonos-V with Optical Viewfinder DF-12



[www.bulkus.us](http://www.bulkus.us)

UW-Nikkor 28mm f/3.5

# ACCESSORIES — continued

## W-Nikkor 35mm f/2.5 (Standard)

This, the standard lens for the Nikonos-V, can be used both on land and underwater to a depth of 50m (160ft).

NIC is applied to internal air-to-glass surfaces to minimize ghost images and flare and ensure high-resolution images. The optical elements are sealed with a watertight front element and the lens barrel features a special spring-loaded mount to ensure proper alignment of the lens and camera body regardless of the water pressure. The threaded lens front accepts a variety of accessories.



### Main Specifications

- Lens construction:** 7 elements in 5 groups (including watertight front cover glass)
- Picture angle:** 43°30' (underwater) and 62° (on land)
- Distance scale:** Graduated in meters and feet from 0.8m (2.75ft) to infinity ( $\infty$ )
- Aperture scale:** f/2.5 to f/22
- Attachment size:** 58mm (P = 0.75mm)
- Dimensions:** Approx. 62mm dia. x 39.5mm long (overall)
- Weight:** Approx. 160g

## Nikkor 80mm f/4

Designed for maximum performance both on land and underwater, this medium telephoto lens can go to a depth of 50m (160ft).

NIC is applied to internal air-to-glass surfaces to minimize ghost images and flare and produce high-resolution images.

In addition, a plastic frame finder (for underwater use) and optical viewfinder DF-10 (for on-land use) are available to let you quickly determine the precise field of view.

### Main Specifications

<b>Lens construction:</b>	5 elements in 5 groups (including watertight front cover glass)
<b>Picture angle:</b>	22°45' (underwater) and 30°20' (on land)
<b>Distance scale:</b>	Graduated in meters and feet from 1m (3.5ft) to infinity ( $\infty$ )
<b>Aperture scale:</b>	f/4 to f/22
<b>Attachment size:</b>	58mm (P = 0.75mm)
<b>Dimensions:</b>	Approx. 62mm dia. x 66mm long (overall)
<b>Weight:</b>	Approx. 275g



[www.butkus.us](http://www.butkus.us)



# ACCESSORIES — continued

## LW-Nikkor 28 mm f/2.8

Designed exclusively for use on land, this lens is water-resistant, not waterproof, and cannot be submerged in water. Useful for regular snapshots and landscapes, this lens is ideal for shooting under harsh conditions, such as in rain or snow, or while skiing, mountain climbing, boating, etc.

All aberrations are well corrected, so pictures are sharp and have high contrast, even at full aperture. The convenient 52mm attachment size allows you to use a large variety of filters and other accessories designed for Nikkor and Nikon Series E lenses. And like those lenses, the LW-Nikkor is easy to operate.

### Main Specifications

<b>Lens construction:</b>	5 elements in 5 groups
<b>Picture angle:</b>	74° (on land)
<b>Distance scale:</b>	Graduated in meters and feet from 0.5m (1.5ft) to infinity ( $\infty$ )
<b>Aperture scale:</b>	f/2.8 to f/22
<b>Attachment size:</b>	52mm (P = 0.75mm)
<b>Dimensions:</b>	Approx. 68.5mm dia. x 57mm long (overall)
<b>Weight:</b>	Approx. 240g



## Nikonos Close-Up Outfit

Because of the incredible variety of aquatic life, half the fun of underwater photography is in taking close-ups. To simplify the process, use the Nikonos Close-Up Outfit. It consists of a single close-up attachment lens, three field frames, and a frame support bracket. The close-up lens screws into the front of either the 28mm, 35mm, or 80mm lens (not the UW-Nikkor 15mm f/2.8 or the LW-Nikkor 28mm f/2.8) to magnify the image. The three field frames indicate the area of coverage for each of the three interchangeable lenses, while the frame support bracket holds the frames at exactly the right distance from the camera for perfect focus. Just frame your subject within the field frame and take a perfect close-up. This outfit can also be used with the Nikonos IV-A and III.



[www.butkus.us](http://www.butkus.us)

# ACCESSORIES — continued

## Accessory Viewfinders

Accessory viewfinders are available for certain Nikonos lenses to help you determine the field of view rapidly.

Plastic frame finders let you frame moving subjects quickly and accurately while your eye is removed from the viewfinder.

**Optical Viewfinder DF-11:** For exclusive use with the UW-Nikkor 15mm f/2.8N.

**Optical Viewfinder DF-12:** Designed for use with the UW-Nikkor 20mm f/2.8. Can also be used with UW-Nikkor 28mm f/3.5 lens via the supplied mounting mask.

**Optical Viewfinder for UW-Nikkor 28mm f/3.5:** Designed for use with the UW-Nikkor 28mm f/3.5. Can also be used with the W-Nikkor 35mm f/2.5 lens via the supplied mounting mask.

**Optical Viewfinder DF-10:** For exclusive use on land with Nikkor 80mm f/4. Distance scale ring for parallax correction is provided.

**Plastic Frame Finder for UW-Nikkor 28mm f/3.5:** For exclusive use with the UW-Nikkor 28mm f/3.5. Mounts on the Nikonos accessory shoe.

**Plastic Frame Finder for the W-Nikkor 35mm f/2.5 and the Nikkor 80mm f/4:** For exclusive use underwater with the W-Nikkor 35mm f/2.5 and the Nikkor 80mm f/4. Mounts on the Nikonos accessory shoe.



Nikon offers a full range of accessories for both underwater and on land picture-taking with the Nikonos-V. In addition to the lenses, flash units, optical viewfinders (glass and plastic), and close-up outfit already mentioned, the following accessories are available:

### Lens Hood (also serves as a filter holder)

This combination lens hood/filter adapter for the W-Nikkor 35 mm f/2.5 and the Nikkor 80mm f/4 lenses prevents stray light from entering the lens and protects the lens from damage.

The hood screws into the front of the lens; standard 52mm filters screw directly into the front of the hood.

### Plastic Lens Protector

A special plastic lens protector is available for mounting on the front of the UW-Nikkor 28mm f/3.5, W-Nikkor 35mm f/2.5, and Nikkor 80mm f/4 lenses. The resiliency of this unit effectively protects the lens against damage from bumps against solid underwater objects.

### Rubber Lens Hood

This unit is a combination lens protector and lens hood for the W-Nikkor 35mm f/2.5 lens. It slides over the front of the lens and protects it underwater.



www.butkus.us

# ACCESSORIES — continued

## Lens Cases

Three types of leatherette lens cases are available for the Nikonos-V's lenses. The Lens Case CL-51 accepts the Nikkor 80mm f/4 lens; the Lens Case CL-50A accepts either the UW-Nikkor 28mm f/3.5 or the W-Nikkor 35mm f/2.5 lens. For the LW-Nikkor 28mm f/2.8, both the Lens Case CL-30S and the Flexible Lens Pouch No. 61 are available.

## Camera Case

This special soft camera case of nylon and leatherette accepts the Nikonos-V and either the UW-Nikkor 28mm f/3.5 or the W-Nikkor 35mm f/2.5 lens with its front lens cap.

## Speedlight Case SS-101

This stylish tote bag has three cushioned compartments for the camera and all parts of the SB-103, SB-102 or SB-101.

## Close-Up Outfit Case

All items in the Nikonos Close-Up Outfit, including the field frames, fit into special contoured compartments in this rectangular zippered case.

## O-rings and Lubricant

Additional O-rings and lubricant are available to allow you to maintain the camera in perfect condition.



CL-51

CL-50A



# TIPS ON BATTERY USE

---

- Keep batteries away from infants and small children. In case a battery is accidentally swallowed, call a doctor immediately as the material inside the batteries may be fatal.
- Battery power falls off in extremely cold temperatures and this may cause the camera to cease to operate. In this situation, use new batteries and protect the camera body from the cold. Note that battery power will be recovered as soon as the temperature becomes normal.
- When not using the camera for a long period of time, take the batteries out and store them in a cool (below 20°C), dry place. Should the batteries be left in the battery chamber for a long period of time, insufficient contact may occur due to battery contamination. Thus, it is good practice to periodically clean the batteries and the contact section in the battery chamber with a soft cloth. If the battery chamber is stained by a leaking battery, remove the batteries at once and clean the chamber.
- Never mix new and old batteries or batteries of different makes.
- Always check battery power before every shooting session. It is a good idea to have spare batteries on hand during a lengthy shooting assignment.
- In normal use, a battery's lifespan is about one year. The battery packed with this camera, however, is for test purposes only so its lifespan may be shorter than usual.
- Never disassemble batteries or dispose of them by burning.

[www.butkus.us](http://www.butkus.us)

# SPECIFICATIONS

**Type of camera:** Electronically controlled 35mm amphibious focal plane shutter camera

**Construction:** Body made of die-cast aluminum alloy and reinforced plastic; all joints sealed by O-ring gaskets to ensure absolute watertightness; camera able to withstand pressures up to  $6\text{kg/cm}^2$  ( $85\text{lb/in}^2$ ) at a depth of 50m (160ft)

**Useable film:** Standard 35mm cartridge-type film

**Picture format:** 24mm x 36mm (standard 35mm film format)

**Lens mount:** Nikonos bayonet mount

**Lenses:** W-Nikkor 35mm f/2.5 standard; four additional lenses from super-wideangle to medium telephoto available

**Viewfinder:** Inverted Galilean type Albada finder built into camera for use with standard 35mm lens; bright frame lines show approx. 85% field of view at infinity ( $\infty$ ); 0.55X magnification; diopter 0.9; high eyepoint allows viewing with eye 40mm away from finder; parallax correction marks provided; accessory optical viewfinders or frame finders available for various lenses

**Viewfinder display:** LED shutter speed indications; LED over- and underexposure warning arrows; thunderbolt-shaped ready-light

**Shutter:** Electronically controlled vertical-travel metal focal-plane type

**Shutter speeds:** A (AUTO): Electronically controlled stepless speeds from 1/30 to 1/1000sec.;

M (MANUAL): Quartz-controlled speeds from 1/30 to 1/1000sec.; M90 (MECHANICAL): Mechanical speed of 1/90sec.; B (BULB): Mechanical setting for long exposures; R (REWIND): Setting used when rewinding film

**Shutter release:** Button at top of anatomical grip; initial pressure on button switches on meter, meter remains on for 16sec. after finger is removed; shutter release lock incorporated

**Exposure control:** Two exposure control modes: A (automatic aperture-priority) and M (manual) modes provided; M90 (mechanical 1/90sec.) and B (Bulb) also provided

**Exposure metering:** Through-the-lens (TTL) stopped-down metering via two silicon photo diodes (SPD) with center-weighted metering pattern; one SPD used for TTL flash exposure control with SB-103, SB-102, and others

**Metering range:** EV 8 to EV 19 at ASA/ISO 100 with f/2.8 lens (from 1/30sec. at f/2.8 to 1/1000sec. at f/22)

**Film speed range:** ASA/ISO 25 to 1600

**Accessory shoe:** Provided; built into top of viewfinder

**Flash synchronization:** X-sync only via flash socket in camera's base; synchronizes at 1/90sec. or slower; with Nikonos Speedlights SB-103, SB-102 and SB-101, shutter speed automatically switches to 1/90sec. when shutter speed/mode selector dial is at "A" or at 1/125 or higher in manual mode; at 1/60sec. or slower on manual, shutter fires at speed set

**Flash ready-light:** Thunderbolt-shaped LED in viewfinder lights when SB-103, SB-102, SB-101, and others have recycled; blinks to warn of insufficient light output, improper shutter speed/mode selector dial setting, and film speed setting beyond the useable range of ASA/ISO 25 to 400 for TTL flash operation

**Film advance lever:** Wound in single stroke or series of strokes; 144° winding angle; hinged for compact storage; when shutter speed/mode selector dial is at "A," shutter releases at approx. 1/1500sec. until film frame counter reaches frame "1" for fast film loading

**Frame counter:** Additive type; advances one frame with each complete stroke of film advance lever whether film is loaded or not; resets when camera back is opened

**Film rewind:** Manual via film rewind crank after shutter speed/mode selector dial is set to "R" (Rewind); shutter release button is automatically locked

**Camera back:** Hinged type with camera back locking pin; opened and locked via camera back lock/release latch and camera back release button

**Pressure plate:** Hinged type, attached to camera body; locking catch provided

**Tripod socket:** Located at base plate of camera body; standard 1/4 inch (JIS)

**Batteries:** One 3V lithium battery (CR 1/3 type), two 1.55V silver-oxide batteries (SR-44 type) or one 1.5V alkaline-manganese battery (LR-44 type)

**Battery check:** Possible when shutter speed/mode selector dial is at any setting except M90, B, or R, and frame counter is at or beyond "1"; viewfinder LED lights to indicate proper battery installation and sufficient battery power when shutter release button is depressed; if battery power is exhausted, shutter can be released at 1/1500sec.

**Dimensions:** Approx. 146mm(W)×99mm(H)×58mm(D) (without lens)

**Weight:** Approx. 700g (without lens)

Subject to change without notice.



## Free Manuals Download Website

<http://myh66.com>

<http://usermanuals.us>

<http://www.somanuals.com>

<http://www.4manuals.cc>

<http://www.manual-lib.com>

<http://www.404manual.com>

<http://www.luxmanual.com>

<http://aubethermostatmanual.com>

Golf course search by state

<http://golfingnear.com>

Email search by domain

<http://emailbydomain.com>

Auto manuals search

<http://auto.somanuals.com>

TV manuals search

<http://tv.somanuals.com>