

User's Manual

▲LTODRIVE3.4

3 - WAY STEREO
DIGITAL X - OVER



www.altoproaudio.com
Version 1.2 January 2003
— English —

SAFETY RELATED SYMBOLS



This symbol, wherever it appears, alerts you to the presence of uninsulated dangerous voltage inside the enclosure-voltage that may be sufficient to constitute a risk of shock.



This symbol, wherever it appears, alerts you to important operating and maintenance instructions in the accompanying literature. Read the manual.



Protective grounding terminal.



Alternating current /voltage.



Hazardous live terminal.

ON: Denotes the apparatus turns on.

OFF: Denotes the apparatus turns off, because of using the single pole switch, be sure to unplug the AC power to prevent any electric shock before you proceed your service.

WARNING: Describes precautions that should be observed to prevent the danger of injury or death to the user.

CAUTION: Describes precautions that should be observed to prevent danger of the apparatus.

WARNING

• Power Supply

Ensure the source voltage matches the voltage of the power supply before turning ON the apparatus. Unplug this apparatus during lightning storms or when unused for long periods of time.

• External Connection

The external wiring connected to the output hazardous live terminals requires installation by an instructed person, or the use of ready-made leads or cords.

• Do not Remove any Cover

There are maybe some areas with high voltages inside, to reduce the risk of electric shock, do not remove any cover if the power supply is connected. The cover should be removed by the qualified personnel only.

No user serviceable parts inside.

• Fuse

To prevent a fire, make sure to use fuses with specified standard (current, voltage, type). Do not use a different fuse or short circuit the fuse holder.

Before replacing the fuse, turn OFF the apparatus and disconnected the power source.

• Protective Grounding

Make sure to connect the protective grounding to prevent any electric shock before turning ON the apparatus. Never cut off the internal or external protective grounding

wire or disconnect the wiring of protective grounding terminal.

• Operating Conditions

This apparatus shall not be exposed to dripping or splashing and that no objects filled with liquids, such as vases, shall be placed on this apparatus. To reduce the risk of fire or electric shock, do not expose this apparatus to rain or moisture.

Do not use this apparatus near water.

Install in accordance with the manufacturer's instructions. Do not install near any heat sources such as radiators, heat registers, stoves, or other apparatus (including amplifiers) that produce heat. Do not block any ventilation openings.

No naked flame sources, such as lighted candles, should be placed on the apparatus.

IMPORTANT SAFETY INSTRUCTIONS

- Read these instructions.
- Follow all instructions.
- Keep these instructions.
- Heed all warnings.
- Only use attachments/accessories specified by the manufacturer.

• Power Cord and Plug

Do not defeat the safety purpose of the polarized or grounding type plug. A polarized plug has two blades with one wider than the other. A grounding type plug has two blades and a third grounding prong. The wide blade or the third prong are provided for your safety. If the provided plug does not fit into your outlet, consult an electrician for replacement of the obsolete outlet.

Protect the power cord from being walked on or pinched particularly at plugs, convenience receptacles, and the point where they exit from the apparatus.

• Cleaning

When the apparatus needs a cleaning, you can blow off dust from the apparatus with a blower or clean with rag etc. Don't use solvents such as benzol, alcohol, or other fluids with very strong volatility and flammability for cleaning the apparatus body.

Clean only with dry cloth.

• Servicing

Refer all servicing to qualified personnel. To reduce the risk of electric shock, do not perform any servicing other than that contained in the operating instructions unless you are qualified to do so.

Servicing is required when the apparatus has been damaged in any way, such as power supply cord or plug is damaged, liquid has been spilled or objects have fallen into the apparatus, the apparatus has been exposed to rain or moisture, does not operate normally, or has been dropped.

PREFACE

Dear Customer:

Thanks for choosing ▲LTODRIVE3.4 and thanks for choosing one of the results of ▲LTO AUDIO TEAM job and researches.

For our ▲LTO AUDIO TEAM , music and sound are more than a job... are first of all passion and let Us say our obsession!

We have been designing professional audio products for a long time in cooperation with some of the major brands in the world in the audio field.

The ▲LTO line presents unparalleled analogue and digital products made by Musicians for Musicians in our R&D centers in Italy, Netherlands, United Kingdom and Taiwan. The core of our digital audio products is a sophisticated DSP (digital sound processor) and a large range of state of the art algorithms which have been developed by our Software Team for the last 7 years.

Because we are convinced you are the most important member of ▲LTO AUDIO TEAM and the one confirming the quality of our job, we would like to share with you our work and our dreams, paying attention to your suggestions and your comments.

Following this idea we create our products and we will create the new ones! From our side, we guarantee you and we will guarantee you also in future the best quality , the best fruits of our continuous researches and the best prices.

Our ▲LTODRIVE3.4 is the result of many hours of listening and tests involving common people, area experts, musicians and technicians; nothing else to add, but that we would like to thank all the people that made the ▲LTODRIVE3.4 a reality available to our customers , and thank our designers and all the ▲LTO staff, people who make possible the realization of products containing our idea of music and sound and are ready to support you, our Customers, in the best way , conscious that you are our best richness.

Thank you very much
▲LTO AUDIO TEAM

TABLE OF CONTENTS

1. INTRODUCTION	4
2. FEATURE LIST	4
3. FRONT AND BACK PANELS DESCRIPTION.....	4
3.1 The Front Panel	
3.2 The Rear Panel	
4. INSTALLATION & CONNECTION	5
4.1 Power Up and Audio Connections	
a. Audio Connections	
b. Power Up Setting	
4.2 Operational Overview	
4.2.1 UTILITY MENU	
a. Load Preset	
b. Store Preset	
c. MIDI Setup	
d. VU-Meter	
e. Password	
4.2.2 EDIT MENU	
a. Routing	
b. IN L/IN R	
c. OUT 1 / 2 / 3 / 4 / 5 / 6	
5. APPLICATION ILLUSTRATION.....	12
5.1 ▲LTODRIVE 3.4 2-Way Input, 6- Way Output (High, Mid, Low, Sub Level)	
5.2 ▲LTODRIVE3.4 2-Way Input, 6- Way Output (High, High, Low, Low Level)	
6. MIDI STANDARD CONTROL.....	14
7. TECHNICAL SPECIFICATIONS.....	16
8. WARRANTY	18

1. INTRODUCTION

Thank you very much for expressing your confidence in ▲LTO products by purchasing our ▲LTODRIVE3.4 . With the ▲LTODRIVE3.4 you have acquired an extremely musical and flexible Active Crossover which will provide you also the subwoofer application.

Our new ▲LTODRIVE 3.4(2 inputs , 6outputs , matrix-like operation X-over) allows the user to work with the quality of the 2/3 by 24 × 32-bit DSPs, permits extremely precise and fast speakers control and equalization for PA systems with the power of a matrix process allowing each kind of combination in assigning the 2 inputs to the 6 outputs. The ▲LTODRIVE 3.4is based on2/3 extremely powerful , high-speed 24 × 32-bit DSP and very high quality 20-bit A/D and 24-bit D/A converters, preserving the pureness of analogue sound in your digital applications. The 128×64 graphical display and the 14 buttons and the relative encoder available on the front panel, offer an easy way of editing data, so to create new custom powerful and exciting presets which may then be stored in the unit as user's presets . The integrated MIDI interface permits real-time editing with a powerful pc based SW or a MIDI standard sequencer.

Both input channels feature a digital , high quality filters 5-band parametric equalizer, allowing boost/attenuation of 15 dB in 0.5dB increment's steps. On each output channel is possible to have a 4th order low pass and a high pass filters, limiter /compressor and polarity switchable 0° or 180° .

2.FEATURE LIST

- Single Rack Unit
- Robust and Compact Design
- 24×32-bit High Speed Signal Processor
- Open Architecture for Easy Software Updates
- Windows Editor for Easy to Use and Powerful Pc Based MIDI Remote Control
- 5 Parametric EQ for Each Channel
- Band Pass Filter Available (Until - 24dB/Oct) for Each Output Channel
- Up to 0.5 sec. of Delay per Channel by Step from 21 ms to 2ms
- Lock-System for the Editing Functions
- Manufactured Under ISO9001 Certified Management System.

3.FRONT AND BACK PANELS DESCRIPTION

3.1.The Front Panel

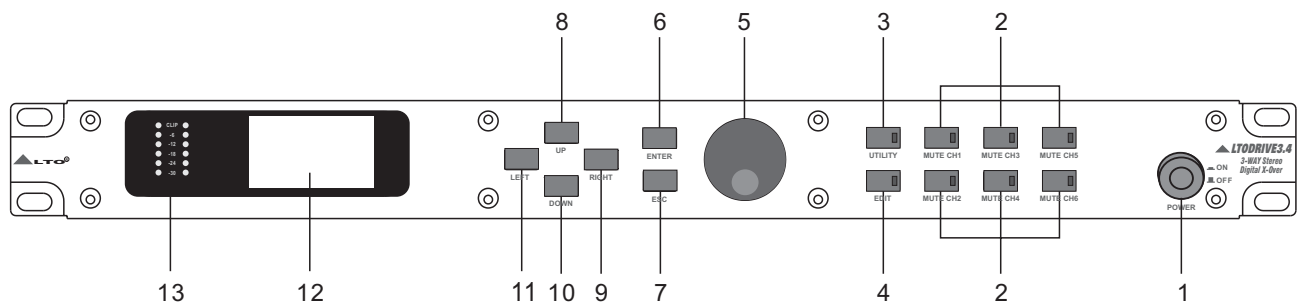

- 1.Power SW with LED
- 2.Mute buttons and LEDs for CH1, CH2, CH3, CH4, CH5, CH6
- 3.Utility key and LED
- 4.Edit key and LED
- 5.Dial knob(encoder)
- 6.Enter key
- 7.ESC key
- 8.Up key
- 9.Right key
- 10.Down key
- 11.Left key
- 12.Graphic display
- 13.Vu-meters

- **Power SW with LED (1)**
Turns the apparatus on and off. Press this SW, the power LED inside the SW will turn on.
- **Dial Control knob (5)**
Used to change editable values.

3.2. The Rear Panel

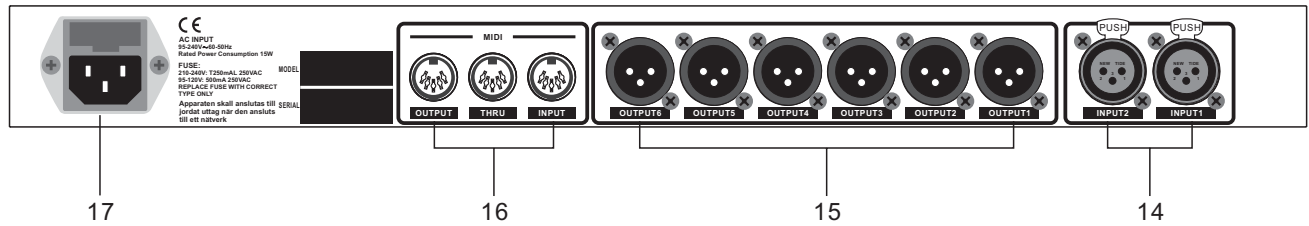

14. Input Connector for Input1 and Input2
 15. Output Connector for Output1~Output6
 16. MIDI Connector
 17. Power Connector

- **Inputs(14)**
These are XLR balanced connectors which connect to sources such as the channel inserts on mixing consoles. They may be used with nominal input levels from consumer to professional audio.
- **Outputs(15)**
▲LTODRIVE3.4 has 6 outputs, they are XLR balanced connectors which connect to devices such as the channel inserts on mixing console or power amplifier inputs .
- **MIDI Connectors(16)**
-MIDI in: 5-poles DIN connector for the MIDI input to the ▲LTODRIVE3.4.
-MIDI thr: 5-poles DIN connector for the MIDI thr.
-MIDI out: 5-poles DIN connector for the MIDI output from the ▲LTODRIVE3.4.
- **Power Connector(17)**
This is an IEC 3-pole socket for connecting the AC power supply to the ▲LTODRIVE3.4.

4. INSTALLATION & CONNECTION

4.1. Power Up and Audio Connections

a. Audio Connections

The connections between the ▲LTODRIVE3.4 and the other audio devices have to be made using high quality cables so to prevent bad performances of the ▲LTODRIVE3.4 itself. So it should be good to use low-capacitance shielded cables with a flexible internal conductor. Connect the cables to the ▲LTODRIVE3.4 properly by observing the following precautions:

- Do not bundle audio cables with AC power cords.
- Do not place audio cables and ▲LTODRIVE3.4 near sources of electromagnetic interference such as transformers, monitors, computers, etc.
- Always unplug cables by firmly grasping the body of the plug and pulling directly outward.
- Do not place cables where they can be stepped on.
- Avoid twisting a cable or having it make sharp, right angle turns.

b. Power Up Setting

Before turning on the ▲LTODRIVE3.4's power, check if:

- All connections have been made correctly.
- The volume controls of the amplifier or mixer are turned down.

Insert the Power plug into the POWER input on the rear panel of the ▲LTODRIVE3.4 and plug the power cable into an AC outlet.

Turn on the power of the ▲LTODRIVE3.4, pushing the ON/OFF button on the front panel.

Turn on the power of the amplifier/mixer, and adjust the volume.

4.2.Operational Overview

At system startup the following splash screens will be shown on the graphic display.

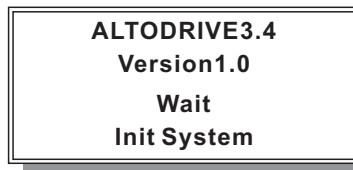

The ▲LTODRIVE is booting and initializing its hardware and software, loading the last used preset and the user interface. The process lasts a few seconds, afterwards the system goes to the Utility Menu (Utility Led is ON).

4.2.1 UTILITY MENU

The Utility menu is accessed by means of the Utility key (Utility Led is ON). The display shows as flowing figure:

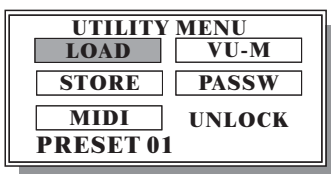

Use Up/Down/Left/Right keys to select one of the five fields. Use Enter to access the selected sub-menu.

a. Load Preset

With this function it's possible to load one of the 65 available presets.

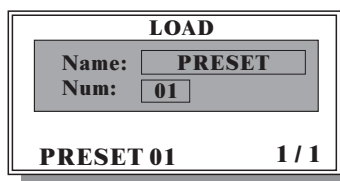
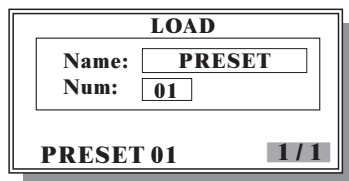

In this window the user can read the name, number and type of the currently loaded preset. 1/1 indicates the number of page; when it's selected it is possible to get back to the main menu pressing the Esc key. With the Up/Down key it's possible to select the preset or page number fields, selection is high lighted printing the item in reverse color.

To load a preset it is necessary to select the preset item; using the dial it is possible to choose the desired preset, to be confirmed pressing the Enter key.

If the user tries to load an empty preset, an error message (NO LOADING) is shown for some seconds. To go back to main menu, select page number, then press Esc.

b. Store Preset

With this function it's possible to store preset data into one of the 64 user available presets.



In this window the user can read the number of the location in which to save the current preset data. With the Up/Down key it's possible to select the preset or page number fields, selection is high lighted printing the item in reverse color.

To save a preset it is necessary to select the Preset item; using the dial it is possible to choose the desired preset number, to be confirmed pressing the Enter key.

After data saving, a character string (preset name) will be shown to the user for editing (max 8 chars).

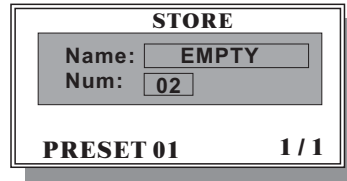

Using Left and Right keys the user can move into the string, with the dial the blinking character can be edited, Enter confirms the choice and Esc cancels operation allowing to maintain the old preset name. Upon confirmation the new preset name will be shown in the lower left corner of the window and in the Name field.



To get back to the main menu, select 1/1 and press the Esc key.

c. MIDI Setup

This function allows a simple MIDI configuration:

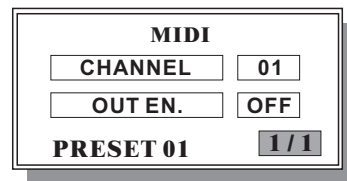

with the Up/Down key it's possible to select the MIDI channel and/or the output enable; selection is high lighted printing the item in reverse color.

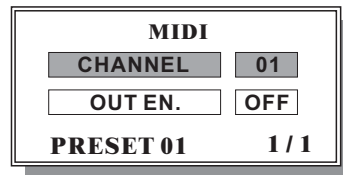
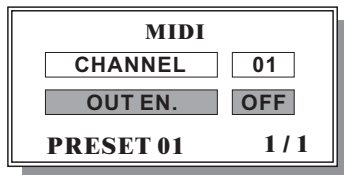

With the dial it is possible to change the value of the parameter, which will be operating immediately (no confirmation needed). To get back to the main menu, select 1/1 and press the Esc key. These two parameters are system settings, ie. They don't belong to a particular preset.

d. VU-Meter

This sub-menu has 2 pages: the first (1/2) shows the 6 output volumes, the second (2/2) the activity of the 6 limiters.

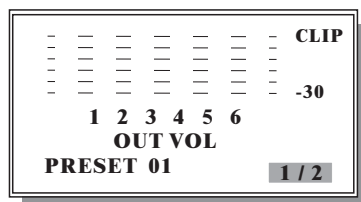

Enter accesses the next page, Esc gets back to the precedent.

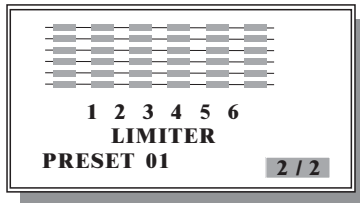

e. Password

With this function the user can decide if the device has to be protected from unauthorized tampering:

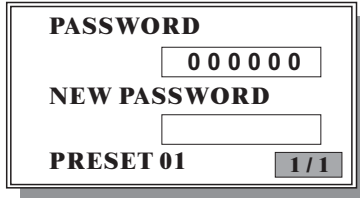

With the Up/Down key it's possible to select the Password, New Password and page number items; selection is highlighted printing the item in reverse color.

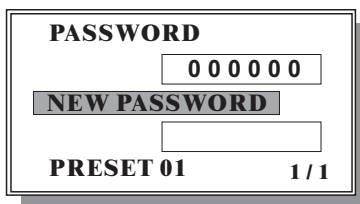

To have complete access to the system, the fields PASSWORD and NEW PASSWORD must match. If the user wants to restrict system access, it is sufficient to change the PASSWORD field. In this condition the user is not able to access UTILITY functions, except the PASSWORD screen. If the user wants to restore complete access to all the system functions, it is sufficient to change the PASSWORD field again to match the other field.

If the two fields aren't matched, the NEW PASSWORD field results blank, in order to protect the system password; when the two fields are matched, the NEW PASSWORD content becomes visible and therefore may be changed, allowing to change the system password; to change a password, select the character string, use Left/Right keys to select a character and change the character using the dial. The default password when the ▲LTODRIVE3.4 is shipped is 000000 (all zeros).

Never forget the system password!

If you forget the system password you will be unable to unlock your ▲LTODRIVE3.4; a lost password is unrecoverable. Consult your ▲LTO dealer in order to restore and unlock the system.

When the ▲LTODRIVE3.4 is password protected, the LOCK indication appears on screen (see below).

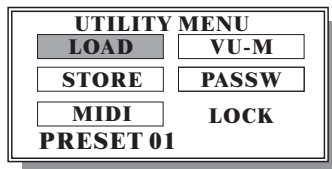

4.2.2 EDIT MENU

Edit key gives access to this menu (Edit LED is ON).

Use Up/Down/Left/Right keys to select one of the seven fields. Use Enter to access the selected sub-menu.

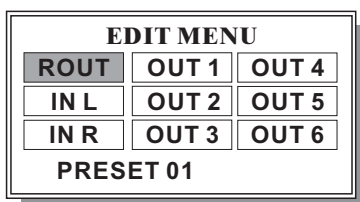

a. Routing

This function allows to configure the signal input/output path:

1/1 indicates the number of page; when it's selected it is possible to get back to the main menu pressing the Esc key.

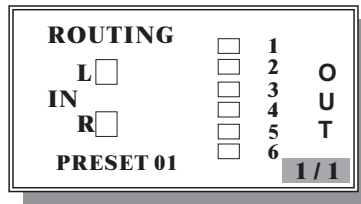

With the Up/Down keys it is possible to select the inputs and the outputs sequentially. In the pictures below the selection sequence is shown.

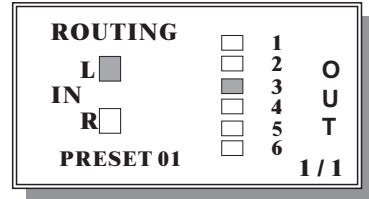
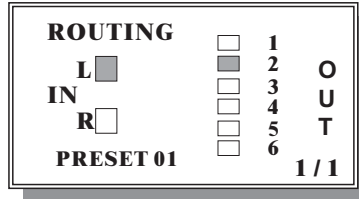
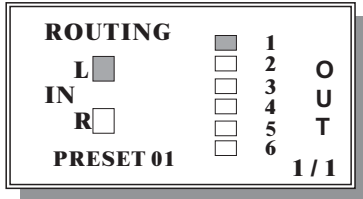

The Right/Left keys make/cut the connection between the selected input and output. In the case above, pressing the Right key, the Left channel will be connected to the OUT 3 channel.

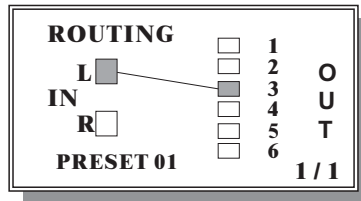

To get back to the main menu, select 1/1 and press the Esc key.

b. IN L / IN R

Here input channels can be configured:

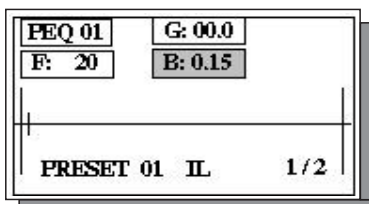
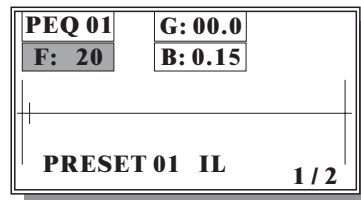
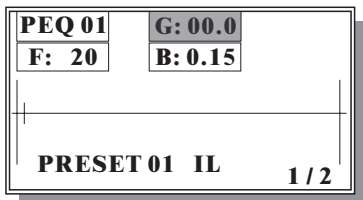
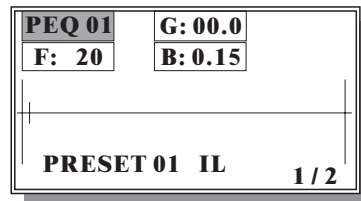
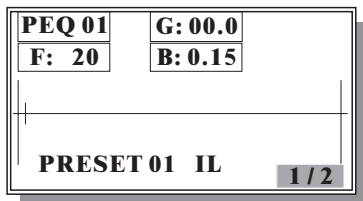

This graphic screen shows the frequency response of the channel.

Use Up/Down/Left/Right keys to select one of the five fields: Page Number, Filter Number, Gain, Frequency, Bandwidth. The selected value can be changed by means of the dial. The selected filter's frequency will be shown by a vertical segment on the display (see above).

When a filter parameter is modified, the audio signal is processed real-time, while the picture on the display waits briefly to update. During this waiting time, an asterisk is shown in the upper right corner of the window, until the graphic is processed.

To access the following screen select page number and press Enter, to get back press Esc.

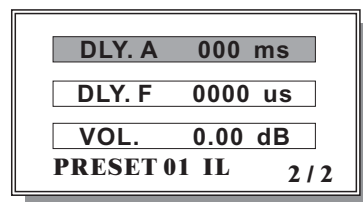
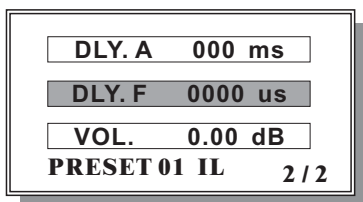
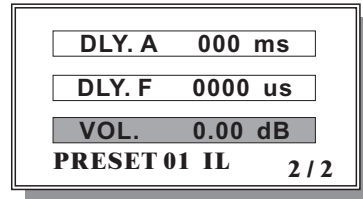
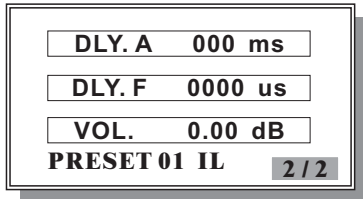

Use Up/Down/Left/Right keys to select one of the four fields: Page Number, Volume, Delay Fine, Delay Adjust; the selected value can be changed by means of the dial. To access the precedent screen select page number and press Esc.

c. OUT 1 / 2 / 3 / 4 / 5 / 6

Here output channels can be configured:

- **EDIT PARAMETRIC FILTERS (page 1 of 4)**

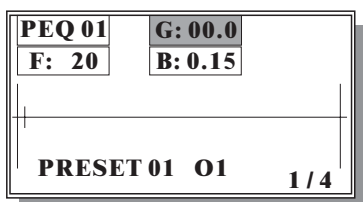
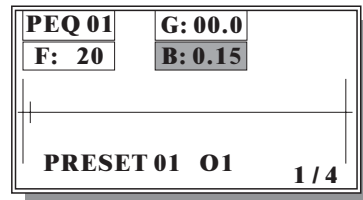
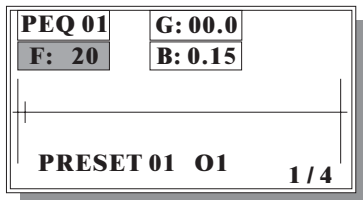
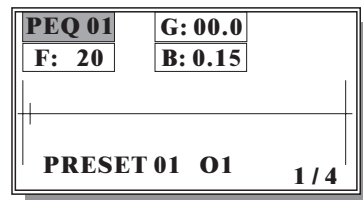
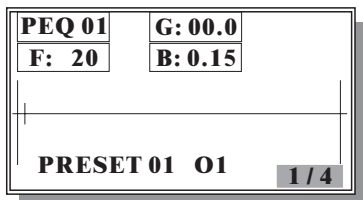

This graphic screen shows the frequency response of the channel.

Use Up/Down/Left/Right keys to select one of the five fields: Page Number, Filter Number, Gain, Frequency, Bandwidth. The selected value can be changed by means of the dial. The selected filter's frequency will be shown by a vertical segment on the display (see above).

When a filter parameter is modified, the audio signal is processed real-time, while the picture on the display waits briefly to update. During this waiting time, an asterisk is shown in the upper right corner of the window, until the graphic is processed.

To access the following page select page number and press Enter. Esc returns to main menu.

• EDIT HP/LP

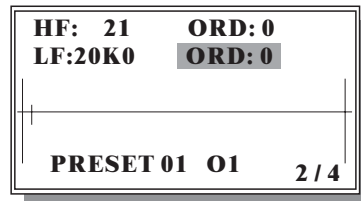
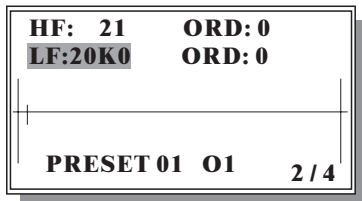
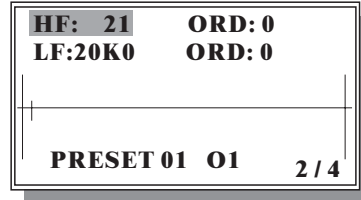
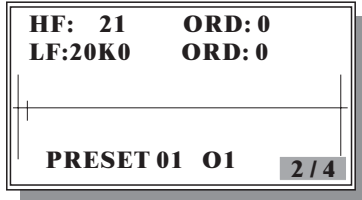

Use Up/Down/Left/Right keys to select one of the five fields; Page Number, Freq Low Pass, Order Low Pass, Freq High Pass, Order High Pass. Hi Pass and Low Pass filters are of Butterworth type; the selected value can be changed by means of the dial.

When a filter parameter is modified, the audio signal is processed real-time, while the picture on the display waits briefly to update. During this waiting time, an asterisk is shown in the upper right corner of the window, until the graphic is processed.

To access the following page select page number and press Enter. Esc returns to precedent page.

• EDIT PARAMETERS

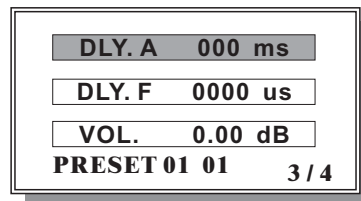
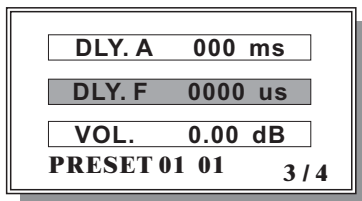
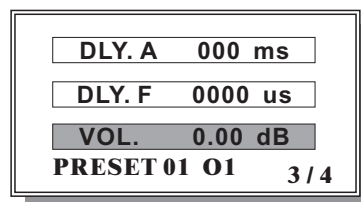
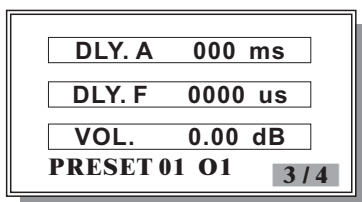

Use Up/Down/Left/Right keys to select one of the four fields: Page Number, Volume, Delay Fine, Delay Adjust; the selected values can be changed by means of the dial.

When Outputs 5 and 6 are selected, only Page Number and Volume fields can be selected because these outputs aren't provided with delay lines.

To access the following screen select page number and press Enter. Esc returns to precedent page.

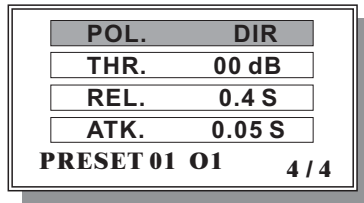
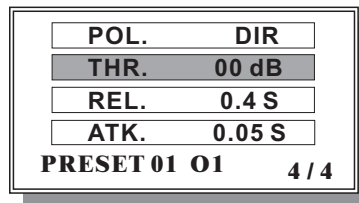
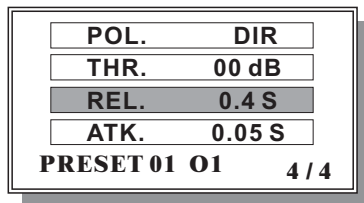
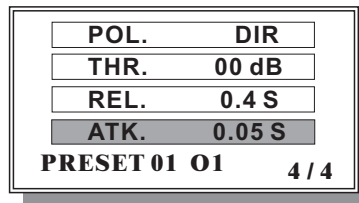
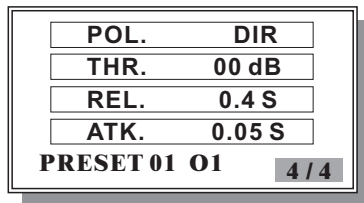

Use Up/Down/Left/Right keys to select one of the five fields: Page Number, Polarity, Limiter Threshold, Limiter Release, Limiter Attack; the selected values can be changed by means of the dial.

To access the precedent page select page number and press Esc.

When the current preset has been edited, it is necessary to save this preset by means of the STORE function, otherwise whatever preset loading or power cycle of the system will overwrite and erase Completely the edited data.

Up/Down/Right/Left key: These keys are used to navigate the menus and to modify the parameter values.

Enter/Esc key: These keys are used to access or to leave the menus, or to confirm the parameter values.

Edit key: This key allows the user to enter the edit menu (the related LED will light)

When entered the edit menu, the user will be able to access and modify all the parameters related to the process, when the user modifies one parameter value, the LED starts to blink to signal the update. The LED will blink until the storing of the new modified preset in one of the 64 available locations.

Vu-meter: This function allows the user to use the vu-meter to show the input signal level.

Mute keys: ▲LTODRIVE3.4 has 6 mute keys.(each channel has one mute key).

Press the mute key, the related channel is muted.

5.APPLICATION ILLUSTRATION

5.1 ▲LTODRIVE 3.4 2-Way Input, 6- Way Output (High, Mid, Low, High, Mid, Low)

If you want to present your ▲LTODRIVE 3.4 in a 2-way input, 6-way output (high, mid, low, high, mid, low level) application, please connect your system as the following illustration step by step:

1.Set the input /output path as the following connection:

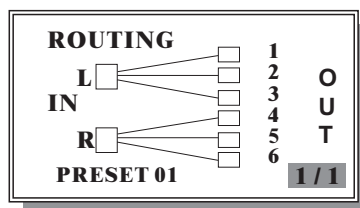

2.Plug the left line-in into INPUT1 and the right line-in into INPUT2

3.Set OUTPUT1, OUTPUT2, OUTPUT3, OUTPUT4, OUTPUT5,OUTPUT6 as high, mid, low, high, mid, low frequency band OUT separately.

4.Connect the OUTPUT1,OUTPUT4 to the high frequency amplifier, OUTPUT2,OUTPUT5 to the mid frequency amplifier, OUTPUT3,OUTPUT6 to the low frequency amplifier.

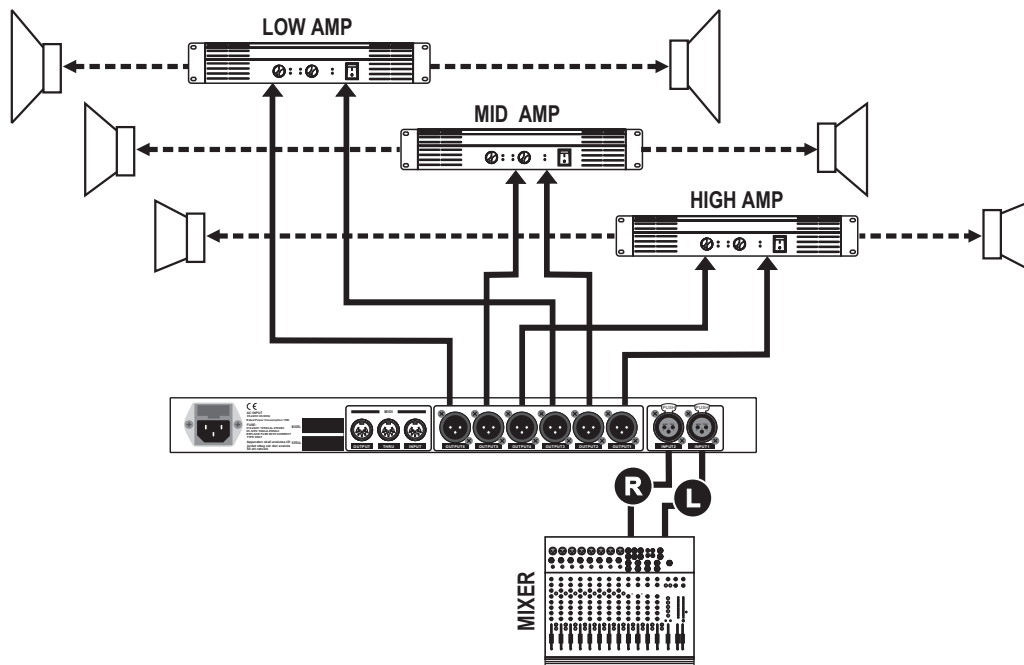

5.2. ▲LTODRIVE3.4 2-Way Input, 6- Way Output (High, High, Low, Low, Sub, Sub Level)

If you want to present your ▲LTODRIVE3.4 in a 2-way input, 6-way output (high, high, low, low, sub, sub level) application, please connect the unit to your system as the following illustration step by step:

1. Set the input /output path as the following connection:

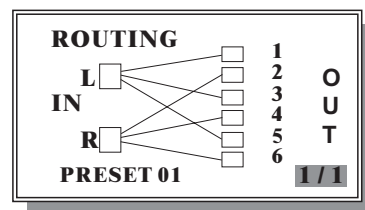

2. Plug the left line-in into INPUT1 and the right line-in into INPUT2.

3. Set the OUTPUT1, OUTPUT2, OUTPUT3, OUTPUT4, OUTPUT5, OUTPUT6 as high, high, low, low, sub, sub frequency band OUT separately.

4. Connect the OUTPUT1, OUTPUT2 to the high frequency amplifier, OUTPUT3, OUTPUT4 to the low frequency amplifier, OUTPUT5, OUTPUT6 to the low frequency amplifier.

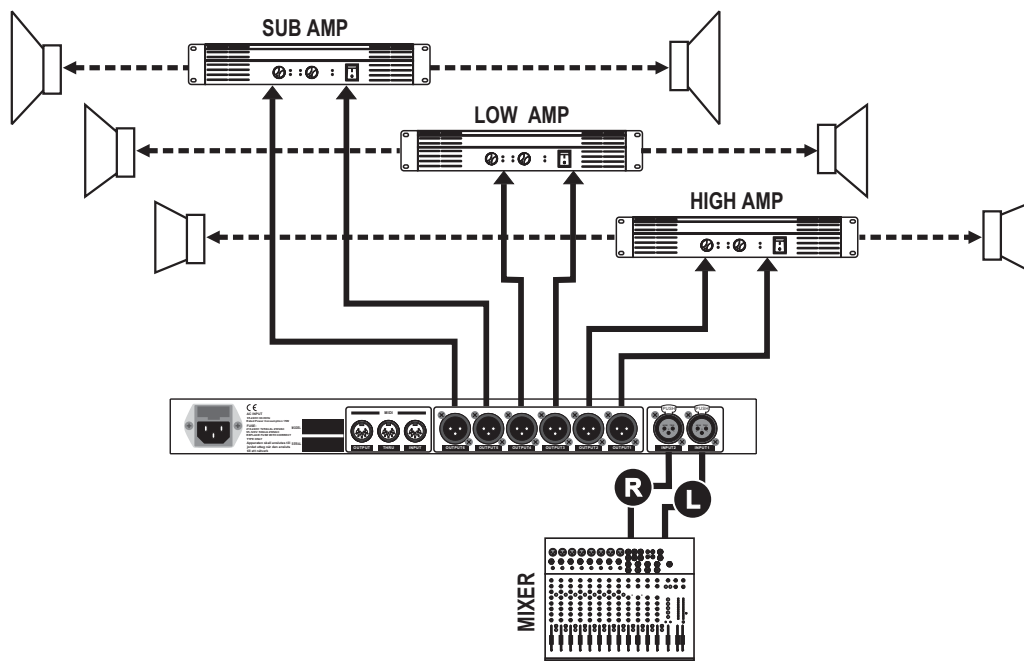

6. APPENDIX

AltoDrive3.4 Midi standard control

PROGRAM CHANGE

Parameter	Value	Legend
Preset 01	0	Preset Factory
Preset 02 to preset 64	1, 2, 3,....., 64	Preset User

CONTROL CHANGE

Parameter	Controller	Value	setting	Legend
Bank	0	0, 1, 2		
Mode Channel	22	0, 1	Input Left, Input Right	
Mode Channel	22	2, 3, 4, 5, 6, 7	Output 1, 2, 3, 4, 5, 6	
Output Volume	7	0, ..., 48	Select Mode Channel	-12 / +12 dB
High Pass Filter	17	0, ..., 120	Mode Channel = 2, 3, 4, 5, 6, 7 Bank=0	HP Frequency
High Pass Filter	17	0, 1, 2, 3, 4	Mode Channel = 2, 3, 4, 5, 6, 7 Bank=1	HP Order
Low Pass Filter	18	0, ..., 120	Mode Channel = 2, 3, 4, 5, 6, 7 Bank=0	LP Frequency
Low Pass Filter	18	0, 1, 2, 3, 4	Mode Channel = 2, 3, 4, 5, 6, 7 Bank=1	LP Order
Delay Line Adj	19	0, ..., 127	Mode Channel = 0, 1, 2, 3, 4, 5 Bank=0	508 ms step 4ms
Delay Line Fine	19	0, ..., 95	Mode Channel = 0, 1, 2, 3, 4, 5 Bank=1	1995 us step 21us
Limiter Threshold	20	0, ..., 29	Mode Channel = 2, 3, 4, 5, 6, 7 Bank=0	-29, ..., 0dB
Limiter Release	20	0, ..., 3	Mode Channel = 2, 3, 4, 5, 6, 7 Bank=1	0.4s, 0.5s, 0.7s, 1.4s
Limiter Attack	20	0, ..., 3	Mode Channel = 2, 3, 4, 5, 6, 7 Bank=2	0.05s, 0.1s, 0.2s, 0.3s
Polarity	21	0	Mode Channel = 2, 3, 4, 5, 6, 7	Direct
Polarity	21	1	Mode Channel = 2, 3, 4, 5, 6, 7	Invers
Filer 01, 02, ..., 04	12, 13, 14, 15	0, ..., 120	Only Mode Channel = 0, 1 (in L, R)	Frequency; Bank=0
Filer 01, 02, ..., 04	12, 13, 14, 15	0, ..., 60	Only Mode Channel = 0, 1 (in L, R)	Amplitude; Bank=1
Filer 01, 02, ..., 04	12, 13, 14, 15	0, ..., 59	Only Mode Channel = 0, 1 (in L, R)	Band Width; Bank=2
Filer 01, 02, ..., 05	12, 13, 14, 15, 16	0, ..., 120	Only Mode Channel = 2, 3, 4, 5, 6, 7	Frequency; Bank=0
Filer 01, 02, ..., 05	12, 13, 14, 15, 16	0, ..., 60	Only Mode Channel = 2, 3, 4, 5, 6, 7	Amplitude; Bank=1
Filer 01, 02, ..., 05	12, 13, 14, 15, 16	0, ..., 59	Only Mode Channel = 2, 3, 4, 5, 6, 7	Band Width; Bank=2
Mute	23	0, 1	Output 1 Mute OFF, ON	ModeCh=2
Mute	23	0, 1	Output 2 Mute OFF, ON	ModeCh=3
Mute	23	0, 1	Output 3 Mute OFF, ON	ModeCh=4
Mute	23	0, 1	Output 4 Mute OFF, ON	ModeCh=5
Mute	23	0, 1	Output 6 Mute OFF, ON	ModeCh=6
Mute	23	0, 1	Output 5 Mute OFF, ON	ModeCh=7
Routing	24	0, 1	Connect Off/On InputL/R to Output1	Bank= 0 / Bank=1
Routing	25	0, 1	Connect Off/On InputL/R to Output2	Bank= 0 / Bank=1
Routing	26	0, 1	Connect Off/On InputL/R to Output3	Bank= 0 / Bank=1
Routing	27	0, 1	Connect Off/On InputL/R to Output4	Bank= 0 / Bank=1
Routing	28	0, 1	Connect Off/On InputL/R to Output5	Bank= 0 / Bank=1
Routing	29	0, 1	Connect Off/On InputL/R to Output6	Bank= 0 / Bank=1

Note:

- Select the channel to edit by means of the controller 22 (Mode channel).

Warnings:

1. Before starting a MIDI session please set on the ALTODRIVE3.4 the same MIDI channel used by the external controller.
2. During a MIDI control session the unit's graphic display is NOT updated.

3. After MIDI use of ALTODRIVE3.4 it's advisable to run a manual STORE to save preset changes done by means of the external controller. After saving, reboot the ALTODRIVE3.4 to use it as a stand-alone unit.
4. When setting and resetting mutes (controller 23) by MIDI, the relative LEDs are NOT actived.

MIDI Controllers Values

Amplitude -15dB / +15dB step 0.5dB (Value = d+u)

d \ u	0	1	2	3	4	5	6	7	8	9
0	-15.0dB	-14.5dB	-14.0dB	-13.5dB	-13.0dB	-12.5dB	-12.0dB	-11.5dB	-11.0dB	-10.5dB
10	-10.0dB	-09.5dB	-09.0dB	-08.5dB	-08.0dB	-07.5dB	-07.0dB	-06.5dB	-06.0dB	-05.5dB
20	-05.0dB	-04.5dB	-04.0dB	-03.5dB	-03.0dB	-02.5dB	-2.0dB	-1.5dB	-1.0dB	-00.5dB
30	00.0dB	+00.5dB	+01.0dB	+01.5dB	+02.0dB	+02.5dB	+03.0dB	+03.5dB	+04.0dB	+04.5dB
40	+05.0dB	+05.5dB	+06.0dB	+06.5dB	+07.0dB	+07.5dB	+08.0dB	+08.5dB	+09.0dB	+09.5dB
50	+10.0dB	+10.5dB	+11.0dB	+11.5dB	+12.0dB	+12.5dB	+13.0dB	+13.5dB	+14.0dB	+14.5dB
60	+15.0dB									

Frequency 20Hz - 20KHz step 1/12 oct (Value = d+u)

d \ u	0	1	2	3	4	5	6	7	8	9
0	20	21,2	22,5	23,7	25	26,6	28,3	29,9	31,5	33,6
10	35,8	37,9	40	42,5	45	47,5	50	53,5	57	59,5
20	63	67	71,5	76	80	85	90	95	100	106,5
30	113	119	125	134	143	151,5	160	170	180	190
40	200	212,5	225	237,5	250	266,5	283	299	315	336,5
50	358	379	400	425	450	475	500	532,5	565	597,5
60	630	672,5	715	757,5	800	850	900	950	1000	1062
70	1125	1187	1250	1337	1425	1512	1600	1700	1800	1900
80	2000	2125	2250	2375	2500	2662	2825	2987	3150	3362
90	3575	3787	4000	4250	4500	4750	5000	5325	5650	5975
100	6300	6725	7150	7575	8000	8500	9000	9500	10000	10625
110	11250	11875	12500	13375	14250	15125	16000	17000	18000	19000
120	20000									

Bandwidth 0.05 oct - 3 oct step 0.05 oct (Value = d+u)

d \ u	0	1	2	3	4	5	6	7	8	9
0	0,05	0,1	0,15	0,2	0,25	0,3	0,35	0,4	0,45	0,5
10	0,55	0,6	0,65	0,7	0,75	0,8	0,85	0,9	0,95	1
20	1,05	1,1	1,15	1,2	1,25	1,3	1,35	1,4	1,45	1,5
30	1,55	1,6	1,65	1,7	1,75	1,8	1,85	1,9	1,95	2
40	2,05	2,1	2,15	2,2	2,25	2,3	2,35	2,4	2,45	2,5
50	2,55	2,6	2,65	2,7	2,75	2,8	2,85	2,9	2,95	3

Output Volume -12dB / +12dB step 0.5dB (Value = d+u)

d \ u	0	1	2	3	4	5	6	7	8	9
0	-12.0dB	-11.5dB	-11.0dB	-10.5dB	-10.0dB	-09.5dB	-09.0dB	-08.5dB	-08.0dB	-07.5dB
10	-07.0dB	-06.5dB	-06.0dB	-05.5dB	-05.0dB	-04.5dB	-04.0dB	-03.5dB	-03.0dB	-02.5dB
20	-2.0dB	-1.5dB	-1.0dB	-00.5dB	00.0dB	+00.5dB	+01.0dB	+01.5dB	+02.0dB	+02.5dB
30	+03.0dB	+03.5dB	+04.0dB	+04.5dB	+05.0dB	+05.5dB	+06.0dB	+06.5dB	+07.0dB	+07.5dB
40	+08.0dB	+08.5dB	+09.0dB	+09.5dB	+10.0dB	+10.5dB	+11.0dB	+11.5dB	+12.0dB	

7. TECHNICAL SPECIFICATIONS

Input Channel

Digital Input Gain	- /+ 12 dB / step 0.5 dB
4 Parametric Filters	Gain - /+ 15 dB / step 0.5 dB Freq 20 Hz - 20 KHz step 1/12 oct BandWidth 0.05 oct - 3 oct / step 0.05 oct
Delay line	Up to 512 ms minimum step 21us

Output Channel

Digital Out Volume	- /+ 12 dB / step 0.5 dB
Delay line	Up to 512 ms minimum step 21us
5 Parametric Filters	Gain - /+ 15 dB / step 0.5dB Freq 20 Hz - 20 KHz / step 1/12 oct BandWidth 0.05 oct - 3 oct step 0.05 oct
High Pass filter type Butterworth	Freq: 20 Hz - 20 KHz / step 1/12 oct Slope: Bypass, 1 st ord, 2 nd ord, 3 rd ord, 4 th ord
Low Pass filter type Butterworth	Freq: 20 Hz - 20 KHz / step 1/12 oct Slope: Bypass, 1 st ord, 2 nd ord, 3 rd ord, 4 th ord
Polarity	Phase 0° or 180°
Limiter	Threshold - 29 dB up to 0 dB / step 1dB Release Time 0.4 s, 0.5 s, 0.7 s, 1.4 s Attack Time 0.05 s, 0.10 s, 0.20 s, 0.30 s

The Whole Unit

Memory	1 Factory Preset 64 User Preset
Analog	
Inputs	2 XLR - F (BAL)
Outputs	6 XLR - M (BAL)
Input Impedance	>40k Ω
Output Impedance	<200 Ω
Input MAX Level	12dBv
Output MAX Level	12dBv
A/D Converter	20BITS Sigma-Delta
D/A Converter	24BITS Sigma-Delta
Performance	
THD+N	0.02%(1KHz - 3dBFS)
Amplitude	20Hz - 20KHz
S/N Ratio	>97dBa
Digital	
Processor speed	36 MIPS
DSP resolution	24 \times 32 bits
Control	Microprocessor
MIDI section	
Connections	Input/output/thru
Sockets	5 - poles DIN(female)
Mode	Photocoupled

Power Supply

Connector type	3 - poles DIN (female)
Type	Servo controlled, Switching
fuse	210 - 240V: T250mAL 250VAC 95 - 120V: 500mAL 250VAC
AC Input	95 - 240V~60 - 50Hz
rated power consumption	15W

User Interface

Graphic display	128×64 dots
Keyboard	14 user keys/ 8LEDs
Vu meter	2×6 LEDs

Physical

Size	Standard 19"rack Mounting
Dimensions	483(W)×232.5(D)×44(H)mm(19"×9.3"×1.7")
weight	3.5Kg(7.72lb)

8. WARRANTY

1. WARRANTY REGISTRATION CARD

To obtain Warranty Service, the buyer should first fill out and return the enclosed Warranty Registration Card within 10 days of the Purchase Date.

All the information presented in this Warranty Registration Card gives the manufacturer a better understanding of the sales status, so as to purport a more effective and efficient after-sales warranty service. Please fill out all the information carefully and genuinely, miswriting or absence of this card will void your warranty service.

2. RETURN NOTICE

- 2.1 In case of return for any warranty service, please make sure that the product is well packed in its original shipping carton, and it can protect your unit from any other extra damage.
- 2.2 Please provide a copy of your sales receipt or other proof of purchase with the returned machine ,and give detail information about your return address and contact telephone number .
- 2.3 A brief description of the defect will be appreciated.
- 2.4 Please prepay all the costs involved in the return shipping, handling and insurance.

3. TERMS AND CONDITIONS

- 3.1 ▲LTO warrants that this product will be free from any defects in materials and/or workmanship for a period of 1 year from the purchase date if you have completed the Warranty Registration Card in time.
- 3.2 The warranty service is only available to the original consumer, who purchased this product directly from the retail dealer, and it can not be transferred.
- 3.3 During the warranty service,▲LTO may repair or replace this product at its own option at no charge to you for parts or for labor in accordance with the right side of this limited warranty.
- 3.4 This warranty does not apply to the damages to this product that occurred as the following conditions:
 - Instead of operating in accordance with the user's manual thoroughly, any abuse or misuse of this product.
 - Normal tear and wear.
 - The product has been altered or modified in any way.
 - Damage which may have been caused either directly or indirectly by another product / force / etc
 - Abnormal service or repairing by anyone other than the qualified personnel or technician.And in such cases, all the expenses will be charged to the buyer.
- 3.5 In no event shall ▲LTO be liable for any incidental or consequential damages. Some states do not allow the exclusion or limitation of incidental or consequential damages, so the above exclusion or limitation may not apply to you.
- 3.6 This warranty gives you the specific rights, and these rights are compatible with the state laws, you may also have other statutory rights that may vary from state to state.

SEKAKU ELECTRON IND. CO., LTD

NO.1, LANE 17, SEC. 2, HAN SHI WEST ROAD, TAICHUNG, 401 TAIWAN

<http://www.altoproaudio.com> Tel:886-4-22313737

email: alto@altoproaudio.com Fax:886-4-22346757

All rights reserved to ALTO. All features and content might be changed without prior notice. Any photocopy, translation, or reproduction of part of this manual without written permission is forbidden. Copyright © 2003 Sekaku Electron

Free Manuals Download Website

<http://myh66.com>

<http://usermanuals.us>

<http://www.somanuals.com>

<http://www.4manuals.cc>

<http://www.manual-lib.com>

<http://www.404manual.com>

<http://www.luxmanual.com>

<http://aubethermostatmanual.com>

Golf course search by state

<http://golfingnear.com>

Email search by domain

<http://emailbydomain.com>

Auto manuals search

<http://auto.somanuals.com>

TV manuals search

<http://tv.somanuals.com>