

---

# American-Lincoln®

ALTO®

Operator's Manual



SMART  
Sweeper/Scrubber

Beginning with Serial No. 692003

## READ THIS BOOK

This book has important information for the use and safe operation of this machine. Failure to read this book prior to operating or attempting any service or maintenance procedure to your machine could result in injury to you or to other personnel. Damage to the machine or to other property could occur as well. You must have training in the operation of this machine before using it. If you or your operator (s) cannot read English, have this manual explained fully before attempting to operate this machine.

All directions given in this book are as seen from the operator's position at the rear of the machine.

For new books, write to: American-Lincoln, 1100 Haskins Road, Bowling Green, Ohio 43402



---

Part No. 2-86-00321

2003 American-Lincoln®

Printed in the USA



**C**

CONTROLS 20-32

**D**

DECIMAL - METRIC CONVERSION TABLE 5

DISCLAIMER 4

**H**

HARDWARE ABBREVIATIONS 6

HYDRAULIC TORQUE REQUIREMENTS 8

**M**

MACHINE PREPARATION 17, 18, 19

MAINTENANCE 44-58

**O**

OPERATING INSTRUCTIONS 33-43

ORDERING PARTS 10

**S**

SAFETY PRECAUTIONS 11, 12

SPECIFICATIONS 14, 15, 16

STANDARD HARDWARE & TORQUE VALUES 7

SYMBOLS 9

**T**

TROUBLESHOOTING 59, 60

## **DISCLAIMER**

---

### **DISCLAIMER**

The information contained in this manual is believed correct at the time of publication. American Lincoln assumes no responsibility or liability for unauthorized changes made to this manual or pages removed, causing indirect or consequential damages resulting from the use of the information appearing herein.

### **WARNING!**

In the event that machinery or controls described herein are modified in any way, or in the event that such machinery or controls are not maintained in a proper manner, the instructional material contained herein may be rendered inaccurate. The information contained herein is to be used only by persons knowledgeable in the operation of machinery such as that described herein, or other persons being directly supervised by such knowledgeable persons.

No portion of this manual may be reproduced without the express written consent of:

AMERICAN LINCOLN  
Product Engineering  
1100 Haskins Road  
Bowling Green, OH, 43402  
(419) 352-7511 Fax: (419) 373-4284  
Copyright 2003 American Lincoln. All rights reserved.  
Printed in USA March 2003

## DECIMAL - METRIC CONVERSION TABLE

FRACTION	DECIMAL	MILLIMETER	FRACTION	DECIMAL	MILLIMETER
$\frac{1}{64}$	0.015625	0.3969	$\frac{33}{64}$	0.515625	13.0969
$\frac{1}{32}$	0.03125	0.7938	$\frac{17}{32}$	0.53125	13.4938
$\frac{3}{64}$	0.046875	1.1906	$\frac{35}{64}$	0.546875	13.8906
$\frac{1}{16}$	0.0625	1.5875	$\frac{9}{16}$	0.5625	14.2875
$\frac{5}{64}$	0.078125	1.9844	$\frac{37}{64}$	0.578125	14.6844
$\frac{3}{32}$	0.09375	2.3813	$\frac{19}{32}$	0.59375	15.0813
$\frac{7}{64}$	0.109375	2.7781	$\frac{39}{64}$	0.609375	15.4781
$\frac{1}{8}$	0.125	3.1750	$\frac{5}{8}$	0.625	15.8750
$\frac{9}{64}$	0.140625	3.5719	$\frac{41}{64}$	0.640625	16.2719
$\frac{5}{32}$	0.15625	3.9688	$\frac{21}{32}$	0.65625	16.6688
$\frac{11}{64}$	0.171875	4.3656	$\frac{43}{64}$	0.671875	17.0656
$\frac{3}{16}$	0.1875	4.7625	$\frac{11}{16}$	0.6875	17.4625
$\frac{13}{64}$	0.203125	5.1594	$\frac{45}{64}$	0.703125	17.8594
$\frac{7}{32}$	0.21875	5.5563	$\frac{23}{32}$	0.71875	18.2563
$\frac{15}{64}$	0.234375	5.9531	$\frac{47}{64}$	0.734375	18.6531
$\frac{1}{4}$	0.25	6.3500	$\frac{3}{4}$	0.75	19.0500
$\frac{17}{64}$	0.265625	6.7469	$\frac{49}{64}$	0.765625	19.4469
$\frac{9}{32}$	0.28125	7.1438	$\frac{25}{32}$	0.78125	19.8438
$\frac{19}{64}$	0.296875	7.5406	$\frac{51}{64}$	0.796875	20.2406
$\frac{5}{16}$	0.3125	7.9375	$\frac{13}{16}$	0.8125	20.6375
$\frac{21}{64}$	0.328125	8.3344	$\frac{53}{64}$	0.828125	21.0344
$\frac{11}{32}$	0.34375	8.7313	$\frac{27}{32}$	0.84375	21.4313
$\frac{23}{64}$	0.359375	9.1281	$\frac{55}{64}$	0.859375	21.8281
$\frac{3}{8}$	0.375	9.5250	$\frac{7}{8}$	0.875	22.2250
$\frac{25}{64}$	0.390625	9.9219	$\frac{57}{64}$	0.890625	22.6219
$\frac{13}{32}$	0.40625	10.3188	$\frac{29}{32}$	0.90625	23.0188
$\frac{27}{64}$	0.421875	10.7156	$\frac{59}{64}$	0.921875	23.4156
$\frac{7}{16}$	0.4375	11.1125	$\frac{15}{16}$	0.9375	23.8125
$\frac{29}{64}$	0.453125	11.5094	$\frac{61}{64}$	0.953125	24.2094
$\frac{15}{32}$	0.46875	11.9063	$\frac{31}{32}$	0.96875	24.6063
$\frac{31}{64}$	0.484375	12.3031	$\frac{63}{64}$	0.984375	25.0031
$\frac{1}{2}$	0.5	12.7000	$1$	1.0000	25.4000

C-2001/9907

# HARDWARE ABBREVIATIONS

---

## **ABBREVIATIONS-SCREWS**

ADJ	= Adjusting Screw
ADJ.SP	= Adjusting Plunger Screw
BHM	= Binding Head Machine Screw
BHS	= Button Head Socket Screw
CAPT.SL	= Captivated Slotted Screw
CAPT.WG	= Captivated Wing Screw
FHM	= Flat Head Machine Screw
FIL.HM	= Filister Head Machine Screw
HHC	= Hexagon Head Cap Screw
HHM	= Hexagon Head Machine Screw
HIHD	= ½ High Head Screw
HSHC	= Hexagon Socket Head Cap Screw
HSFHC	= Hexagon Socket Flat Head Cap Screw
KNH	= Knurled Head Screw
MHHC	= Metric Hexagon Head Cap Screw
PHM	= Pan Head Machine Screw
RHD	= Round Head Drive Screw
RHM	= Round Head Machine Screw
RHW	= Round Head Wood Screw
SHC	= Shiny Crown Cap Screw
SHTB	= Shoulder Thumb Screw
SQ	= Square Head Screw
TB	= Thumb Screw
THM	= Truss Head Machine Screw
WELD	= Weld Stud
WG	= Wing Screw

## **ABBREVIATIONS-SETSCREWS**

HS	= Hexagon Socket Setscrew
S	= Slotted Setscrew
SH	= Square Head Setscrew
KCP	= Knurled Cup Point Setscrew
CP	= Cup Point Setscrew
OP	= Oval Point Setscrew
FDP	= Full Dog Point Setscrew
HDP	= Half Dog Point Setscrew
FP	= Flat Point Setscrew
COP	= Cone Point Setscrew

## BOLT IDENTIFICATION

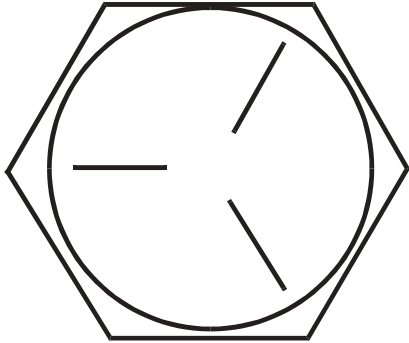

SAE - Grade 5

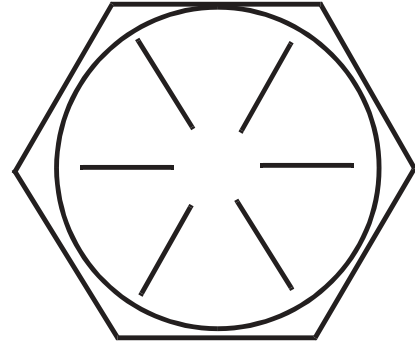

SAE - Grade 8

Screw Size	Grade 5 Plated		Grade 8 Plated		410H Stainless		Brass	Type F & T & BT		Type B, AB
	C	F	C	F	C	F		C	F	
*6	14	15	-	-	18	20	5	20	23	21
*8	27	28	-	-	33	35	9	37	41	34
*10	39	43	-	-	47	54	13	49	64	49
*1/4	86	108	130	151	114	132	32	120	156	120
5/16	15	17	22	24	19	22	6	-	-	-
3/8	28	31	40	44	34	39	10	-	-	-
7/16	44	49	63	70	55	62	16	-	-	-
1/2	68	76	95	108	85	95	-	-	-	-
9/16	98	110	138	155	-	-	-	-	-	-
5/8	135	153	191	216	-	-	-	-	-	-
3/4	239	267	338	378	-	-	-	-	-	-
7/8	387	-	545	-	-	-	-	-	-	-
1	579	-	818	-	-	-	-	-	-	-

C = Coarse Thread

F = Fine Thread

\* = Torque values for #6 through 1/4 are lb./in. All others are lb./ft.

NOTE

Decrease the torque by 20% when using thread lubricant  
The torque tolerance is  $\pm$  on torque values.

+

C2000/9905

## HYDRAULIC TORQUE REQUIREMENTS

### HYDRAULIC TORQUE REQUIREMENTS

Refer to the following chart for torque values on all hydraulic hoses & fittings

Nominal SAE Dash Size	O-Ring Face Seal End		SAE O-Ring Boss End	
	Thread Size Inch	Swivel Nut Torque	Thread Size Inch	Str. Fitting or Locknut Torque
		LB-FT		LB-FT
-3	*	*	3/8-24	8-10
-4	9/16-18	10-12	7-16-20	14-16
-5	*	*	1/2-20	18-20
-6	11/16-16	18-20	9/16-18	24-25
-8	13/16-16	32-35	3/4-16	50-60
-10	1-14	46-50	7/8-14	72-80
-12	1 3/16-12	65-70	1 1/16-12	125-135
-14	1 3/16-12	65-70	1 3/16-12	160-180
-16	1 7/16-12	92-100	1 5/16-12	200-220
-20	1 11/16-12	125-140	1 5/8-12	210-280
-24	2-12	150-165	1 7/8-12	270-360





































-Ring face-seal-type end not defined for this tube size

#### NOTE

Parts must be lightly oiled with hydraulic fluid



THESE SYMBOLS IDENTIFY CONTROLS, DISPLAYS/FEATURES, AND SAFETY SYMBOLS ON THE MACHINE.

	Battery Charger		Scrub Brush Down Heavy Pressure
	Choke		Squeegee Down & Vacuum On
	Fan On		Squeegee Up & Vacuum Off
	Filter Shaker On		Squeegee Up & Vacuum On
	Forward/Reverse		Solution Tank Low
	Headlights		Solution Flow Control
	Hopper Dump		Throttle
	Hopper Return		Read Machine Manual Before Operating or Servicing
	Horn		No gas or combustibles in tank
	Main Broom & Side Broom Up		Keep Away From Flames/ NO Smoking
	Main Broom & Side Broom Down		Wear Eye Protection
	No Step		Electrical Hazard
	Off		Stay Clear
	On		Moving Fan Blade
	Power		Pinch Point/Crush Hazard
	Recovery Tank High		Cover or Hopper Could Close/ Engage Support
	Scrub Brush Down & On		Turn Key Off/Lock Wheel Before Leaving Seat
	Scrub Brush Up and Off		WARNING! / ATTENTION!

## ORDERING PARTS

---

### Parts may be ordered from ALTO distributors:

#### INTERNET

<http://www.alto-online.com>

#### ALTO HEADQUARTERS

Incentive International A/S  
Kongens Nytorv 28  
P.O. Box 2064  
1013 Copenhagen K  
Tel.: +45 72 18 10 00  
Fax: +45 72 18 11 64  
E-mail: [incentive@incentive-dk.com](mailto:incentive@incentive-dk.com)

#### AUSTRIA

ALTO Österreich GmbH  
Metzgerstr. 68  
5101 Bergheim/Salzburg  
Tel.: +43 6624 5 64 00-14  
Fax: +43 6624 5 64 00-55  
E-mail: [wap@salzburg.co.at](mailto:wap@salzburg.co.at)

#### CROATIA

Wap ALTO Strojevi za čišćenje, d.o.o.  
Siget 18a  
10020 Zagreb  
Tel.: +385 1 65 54 144  
Fax: +385 1 65 54 112  
E-mail: [admin.wap@wap-sistemi.hr](mailto:admin.wap@wap-sistemi.hr)

#### CZECH REPUBLIC

ALTO Česká Republika s.r.o.  
Zateckých 9  
14000 Praha 4  
Tel.: +420 2 41 40 84 19  
Fax: +420 2 41 40 84 39  
E-mail: [wap\\_p@mbox.vol.cz](mailto:wap_p@mbox.vol.cz)  
Web: [www.wap-alto.cz](http://www.wap-alto.cz)

#### DENMARK

ALTO Danmark A/S  
Industrikvarteret  
9560 Hadsund  
Tel.: +45 7218 21 00  
Fax: +45 7218 21 05  
E-mail: [salg@alto-dk.com](mailto:salg@alto-dk.com)

#### FRANCE

ALTO France S.A.  
B.P. 44, 4 Place d'Ostwald  
67036 Strasbourg Cedex 2  
Tel.: +33 3 88 28 84 00  
Fax: +33 3 88 30 05 00  
E-mail: [info@alto-fr.com](mailto:info@alto-fr.com)

#### GERMANY

ALTO Deutschland GmbH  
Guido-Oberdorfer-Straße 2-8  
89287 Bellenberg  
Tel.: +49 0180 5 37 37 37  
Fax: +49 0180 5 37 37 38  
E-mail: [info@wap-online.de](mailto:info@wap-online.de)

#### GREAT BRITAIN

ALTO Cleaning Systems  
(UK) Ltd.  
Bowerbank Way  
Gilwilly Industrial Estate, Penrith  
Cumbria CA11 9BN  
Tel.: +44 1 7 68 86 89 95  
Fax: +44 1 7 68 86 47 13  
E-mail: [sales@alto-uk.com](mailto:sales@alto-uk.com)

#### NETHERLANDS

ALTO Nederland B.V.  
Postbus 65  
3370 AB Hardinxveld-Giessendam  
Tel.: +31 18 46 77 20 0  
Fax: +31 18 46 77 20 1  
E-mail: [info@alto-nl.com](mailto:info@alto-nl.com)

#### NORWAY

ALTO Norge A/S  
Bjørnerudveien 24  
1266 Oslo  
Tel.: +47 22 75 17 70  
Fax: +47 22 75 17 71  
E-mail: [info@alto-no.com](mailto:info@alto-no.com)

#### SLOVENIA

Wap ALTO čistilni sistemi, d.o.o.  
Letališka 33  
SLO-1110 Ljubljana  
Tel.: +368 15 20 62 00  
Fax: +368 15 20 62 10  
E-mail: [wap@siol.net](mailto:wap@siol.net)

#### SLOWAKIA

Wap ALTO čistiace systémy s.r.o.  
Remeselnícka 42  
83106 Bratislavia-Rača  
Tel.: +421 2 44 881 402  
Fax: +421 2 44 881 395  
E-mail: [wap@gtinet.sk](mailto:wap@gtinet.sk)  
Web: [www.wap-alto.sk](http://www.wap-alto.sk)

#### SPAIN

ALTO Iberica S.L.  
Calle de la Majada No. 4  
28760 Tres Cantos - Madrid  
Tel.: +34 91 8 04 62 56  
Fax: +34 91 8 04 64 63  
E-mail: [info@alto-es.com](mailto:info@alto-es.com)

#### SWEDEN

ALTO Sverige AB  
Aminogatan 18  
431 04 Mölndal  
Tel.: +46 3 17 06 73 00  
Fax: +46 3 17 06 73 41  
E-mail: [info@alto-se.com](mailto:info@alto-se.com)

1. Use the model number, catalog number, and serial number when ordering.
2. Give the part number, description, and quantity of parts needed.
3. Give shipping instructions for either freight, UPS, or parcel post.

## MACHINE CATALOG NUMBERS

<b>505-320</b>	<b>SMART (40") SWEEPER/SCRUBBER</b>
<b>505-321</b>	<b>SMART (46") SWEEPER/SCRUBBER</b>
<b>505-322</b>	<b>SMART (40") SWEEPER/SCRUBBER W/ DUST CONTROL</b>
<b>505-323</b>	<b>SMART (46") SWEEPER/SCRUBBER W/ DUST CONTROL</b>

The following safety labels are mounted on the machine in the locations indicated. If the labels become damaged or illegible replace with identical label.

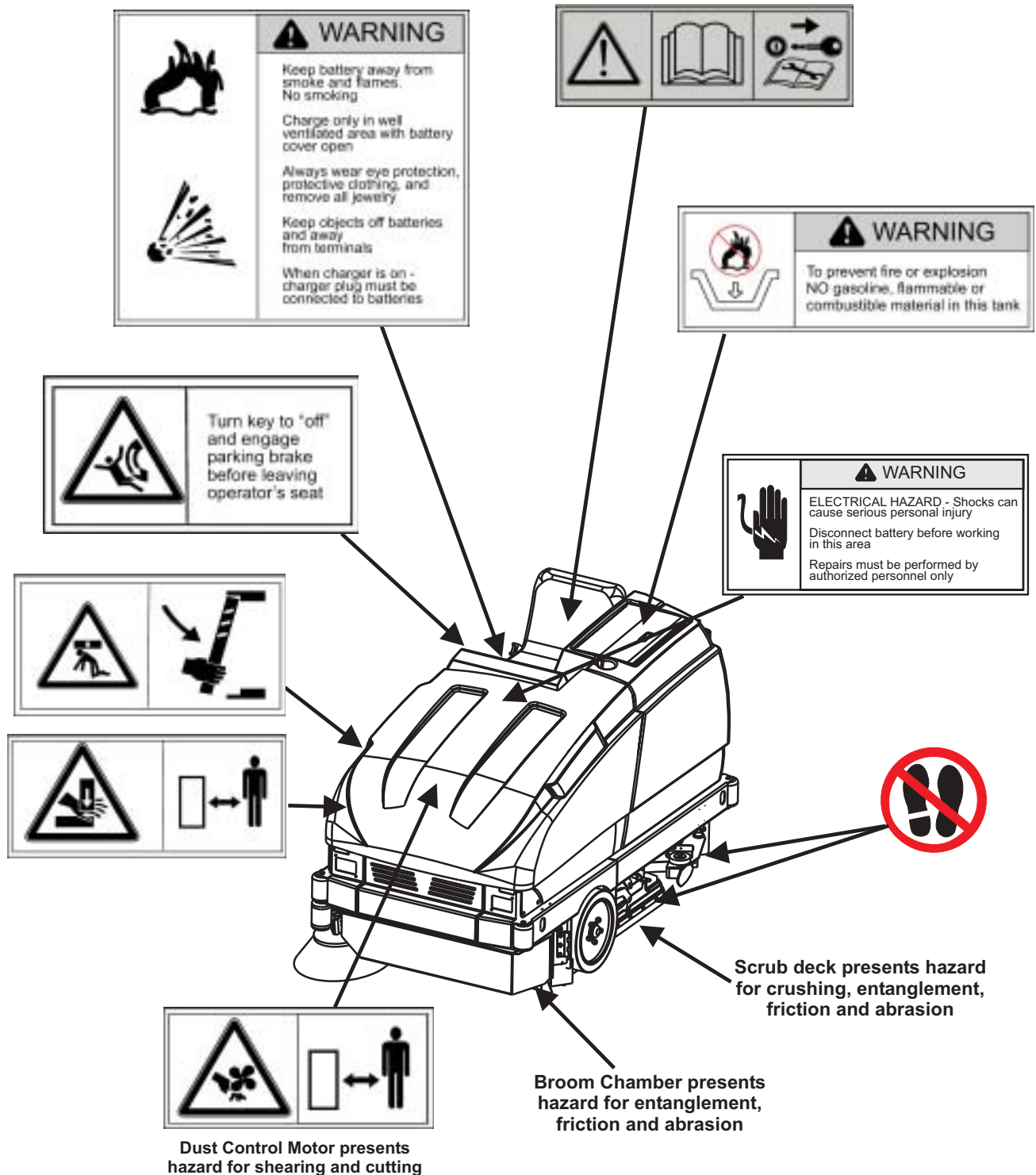

## SAFETY PRECAUTIONS

---

### HAZARD SERIOUSNESS LEVEL

Signal words (DANGER, WARNING and CAUTION) are used to identify levels of hazard seriousness. The degree of severity is based on the likely consequences of human interaction with the hazard.



#### **DANGER**

To warn of immediate hazards which will result in severe personal injury or death.



#### **WARNING**

To warn of hazard or unsafe practices which could result in severe personal injury.



#### **CAUTION**

To warn of hazards or unsafe practices which could result in minor personal injury.



#### **ATTENTION**

To warn of unsafe practices which could result in extensive equipment damage.



#### **NOTE**

To give important information or to warn of unsafe practices which could result in equipment damage.

For the safe operation of this machine, read and understand all WARNINGS, CAUTIONS AND NOTES.

### PERSONAL SAFETY

- Read this manual carefully. The following information signals potentially dangerous conditions to the operator or equipment. Know when these conditions can exist then take necessary steps to train machine operating personnel.
- Dress appropriately; loose clothing, jewelry and other accessories may get caught in the machine and cause physical injury.
- Wear OSHA/NIOSH protective eye wear or prescription glasses to protect eyes.
- Wear appropriate gloves when filling and/or draining tanks.
- Before operating machine, test brake mechanism, lights and back up alarm (if applicable).
- Observe maintenance schedule guidelines to assume optimal safe operation of the machine.
- Be aware of pinch points that exist on the machine.
- Do not operate machine if you are tired, upset, ill, on medication or intoxicated.
- Be completely aware of your surroundings. STOP, LOOK, and LISTEN for other employees walking in or around your cleaning area.

### MACHINE SAFETY

- Operator must be properly trained to operate machine.
- Read this manual before operating machine
- Familiarize yourself with all components and safety features.
- Do not operate machine unless it is completely assembled.
- Do not use machine other than intended use.
- Report damages or maintenance problem immediately. Do not use machine until it has been repaired.
- Repairs should be done by authorized personnel.
- For storage, keep machine in a building.
- This machine is not at tow truck and should not be used for towing.
- Do not use this machine as a step or furniture.
- Do not operate machine on public highways, gravel, sand, grass and other unsafe surfaces.

## SAFETY PRECAUTIONS

---

- Be careful when operating the machine on a ramp or incline. Do not operate machine on incline greater than 8° or longer than 100'. Always move slowly on a ramp. Do not turn this machine on a ramp.
- Do not stop and leave this machine on a ramp. Always stop the machine on a level surface, put the power switch in the on position.
- To prevent injury, and damage to the machine, do not lift the machine or move it to an edge of a stair or loading dock.
- Turn off machine when unattended, filling, fueling or doing maintenance on machine (if applicable). When carrying out maintenance, pull the key.
- Do not operate machine near flammable materials, fire or explosion may occur.
- Solution or recovery tank should not be filled with fuel or chemicals.
- Read label on cleaning solutions to verify it is safe for machine.
- Use a cleaning concentrate recommended by the chemical manufacturer.
- Water solutions or cleaning materials used can leave wet areas on floor surfaces causing dangerous conditions for the operator or other persons. Always put CAUTION signs near area you are cleaning.
- Use care when reversing machine.
- Always empty the solution tank and recovery tank before doing maintenance.
- Unplug the battery first to prevent possible injury when servicing a machine.
- Lead acid batteries generate gases, which can cause an explosion. Keep sparks and flames away from batteries. NO SMOKING. Charge batteries only in area with good ventilation.
- Always wear eye protection and protective clothing when working near batteries. Remove all jewelry.
- Do not put tools or other metal objects across the battery terminals, or the tops of batteries.
- Keep electrical parts of the machine dry.
- Make sure that all labels, decals, warnings, cautions and instructions are fastened to the machine.
- Get new labels and decals from American-Lincoln.
- Do not use machine to pick up dusts hazardous to health.
- Only use accessories according to this instruction manual. Use of other accessories may impair safety.

## SPECIFICATIONS

---

### CLEANING PATH

Scrubbing	40 in. (101 cm) 46 in. (117 cm)
Sweeping	46 in. (117 cm)
Edge Cleaning	6 in. (15 cm) Right Side 46 in. (117 cm) only

### TRANSPORT SPEED OPERATING SPEED

0-4.6 MPH (0 - 7.4kph)  
0-2.7 MPH (0 - 4.3kph)

### POWER SUPPLY

(1) 36 Volt Wet Battery, 720 AH

For machine to operate properly, voltage reading should fall within 32-40 vdc.

Guaranteed power sound level: LWA<sub>max</sub> = 103 dBA  
(Operator) Sound Pressure Level = 84.8

### CHARGER

240 Vac, 3-phase, 60 Hz, 36 Vdc, 150 A

### STEERING

Rack & Pinion 90°-90° Hyd. Assist  
Adjustable Steering Column

### TURNING RADIUS

Left	59 in. (150 cm)
Right	59 in. (150 cm)
Aisle "U" Turn	87 in. (221 cm)

### DIMENSIONS

Length	87 in. (221 cm)
Width	46 in. (116.8 cm)
Height	52 in. (132 cm)
Height w/Overhead Guard	79 in. (200.6 cm)
Wheel Base	37.6 in. (95.5 cm)

### WEIGHT

Standard Machine (Battery)	1700 lbs. (765 kg.) without battery 720 Ah battery 1990 lbs. (896 kg)
----------------------------	--

### VIBRATION LEVELS

Steering Wheel	<2,5m/s <sup>2</sup>
Seat	<2,5m/s <sup>2</sup>

### TIRES

Front (Battery) Solid Urethane	Two (2) 16 in (41cm) x 3.75 in (8.26 cm)
Rear (Battery) Solid Rubber	One (1) 16 in (41 cm) x 4.00 in (10.16cm)

### RAMP CLIMBING

Transporting	8°
--------------	----

### MAIN BROOM

One piece plastic core disposable type. Broom position can be set to "restricted down" or "free floating".

Length	36 in (91.4 cm)
Diameter	10 inches (25.4 cm)
Optional Bristle Type	Nylon (High density) Proex Nylon Eight (8) Row

### SIDE BROOM

Side Broom Size	16 inches (40.6 cm) Diameter
-----------------	------------------------------

**INSTRUMENTS AND CONTROLS**

Main/Side Broom Switch	Key Switch
Headlight/Taillight Switch (option)	Hour Meter
Squeegee Switch	Recovery High Light
3 Position Scrub Deck Switch	Dust Control Switch (with certain models)
Horn Button	Solution Low Light
Solution Control Knob	ESP (Option)
Hopper Up/Down Switch	Filter Shaker Switch
Hopper Open Light	Squeegee and Vacuum Wand (Option)

**SCRUBBING SYSTEM**

Brush Size-46" (116.84 cm)	Three (3) 16" (40.6cm) Diameter
Brush Size-40" (101.4 cm)	Two (2) 20" (51cm) Diameter
Brush Lift	Hydraulic Actuator
Scrub Pressure	Normal: 140 lbs. / Heavy: 200 lbs.

**SQUEEGEE**

Rear	Accu-Trac™ 46 in(116.8 cm) Swing, break away, w/no tool squeegee replacement
Side	26 in (66 cm) Easy Change

**TANKS**

Solution Tank	55 Gallons (208 liter)Polyethylene
Recovery Tank	55 Gallons (208liter)Polyethylene
Solution Metering	Variable to 3.0 GPM (11.4 lpm)
Drain Hose	48 in (122 cm)
Clean Out Port	5.7 in (14.5 cm) heavy debris

**HOPPER**

Capacity	2.5 cu.ft.(71liter)
----------	---------------------

**DUMP AND LIFT**

Dump Height	14 in (35.6 cm.)
-------------	------------------

**SYSTEM FLUID CAPACITIES**

Hydraulic System	4.7 Gallons (17.79 Liters)
------------------	----------------------------

**OPTIONAL EQUIPMENT**

Back-Up Alarm	Headlight/Taillights	ESP System
Overhead Guard	Squeegee Wand	Fire Extinguisher
Spray and Vac Wand	Linatex Squeegee	720 AH Battery
Black Nylon Brush	Polyethelyne Panel Filter	Arm Rest (RH only)
Polypropylene Brush	Smart Cart (Battery Roll-Out Cart)	Seat Belt
Clean Grit Brush	Strobe Light (Amber) W/O OHG	
Supergrit Brush	Strobe Light (Amber) W/OHG	

**WARRANTY**

Our general conditions of business are applicable with regard to the guarantee. Subject to change as a result of technical advances. The guarantee is invalidated if the machine is not operated in accordance with these instructions or otherwise abused. The guarantee is invalidated if the machine is not serviced as described.

# SPECIFICATIONS

## MACHINE DATA

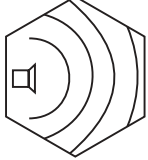
<b>ALTO®</b>		<input type="text"/>
		MACHINE NAME
<input type="text"/>		<input type="text"/>
MODEL		DATE / SERIAL NUMBER
<input type="text"/>		<input type="text"/>
WEIGHT		RATED POWER
	IP X3	<input type="text"/>
		MAX OPERATING SLOPE
	LWA	CE
<input type="text"/>	dB	

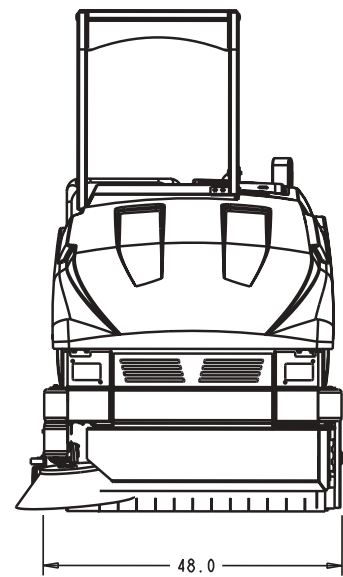
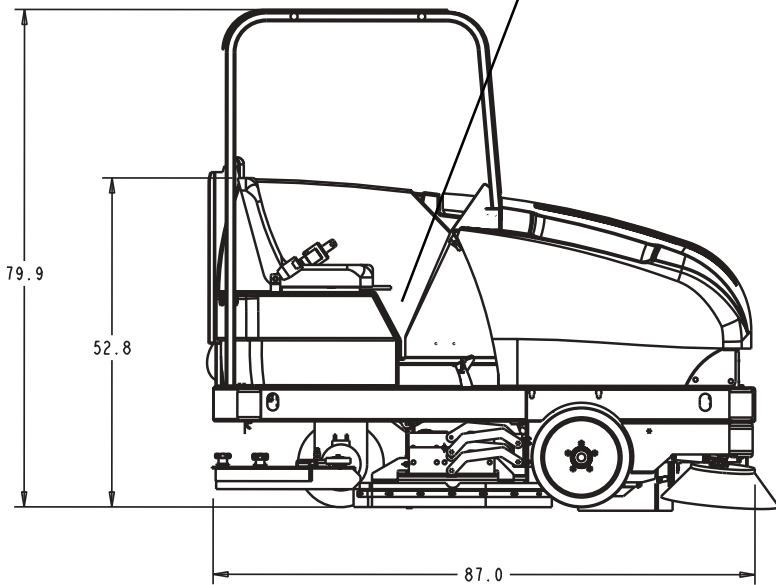





Fig 1

Your SMART battery machine has been shipped complete, but do not attempt to operate without reading the following instructions:

### UNPACKING AND ASSEMBLING MACHINE

The SMART is shipped on a pallet and held in place with wooden block to stop the machine from moving.

- 1) Remove wooden blocks holding machine in place.
- 2) Position a 11° and 48" ramp on base of pallet.

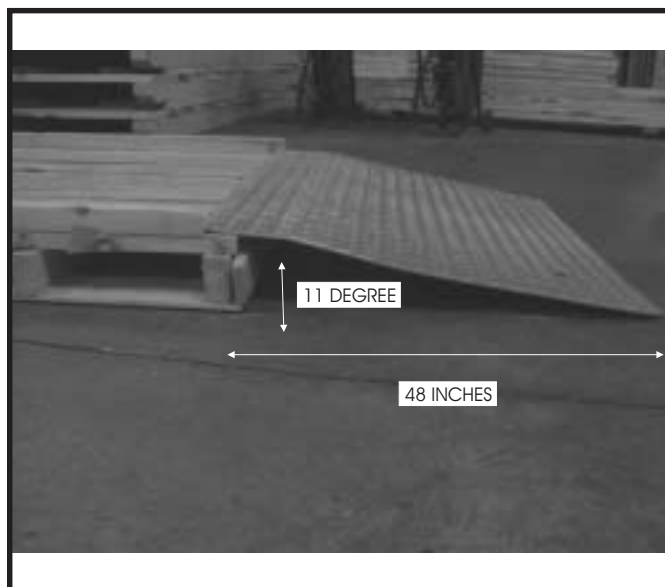

Fig 2

## MACHINE PREPARATION

---

- 3) Push machine down the ramp onto a flat surface.
- 4) Install battery.
  - Turn the key to the "O" position
  - Lift the hood up and pull the battery lever up to the right.
  - Use a battery lifting device with a 2000 LB. (907KG) capacity to place the battery into the battery tray.
  - Push battery lever down to the left to lock the battery into place.
  - Plug the battery power connector into the machine power connector.
  - Lower the hood into place.
- 5) Charge battery as shown in the manual. Read battery manufacturer literature for battery care and maintenance.



**Do not charge batteries on a concrete grounded surface. Hydrogen gas is formed during the charging operation and is explosive. Only charge batteries in a well ventilated area with the lid open. Avoid any smoking, open flame, or electrical sparks.**



**Fig 3**



**Fig 4**

### UNPACKING BATTERY

The battery is shipped separately on a pallet wrapped in plastic as shown in figure 3. Remove the plastic and use a 2000 LB. (907KG) capacity lifting device to lower the battery into the battery compartment as shown in figure 4.

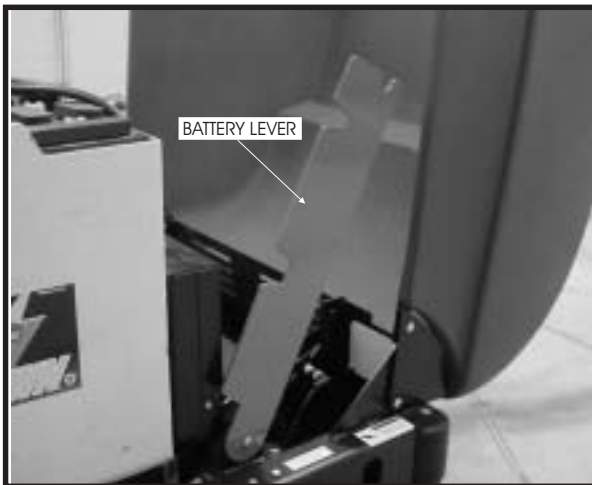

Fig 5



Fig 6



Fig 7

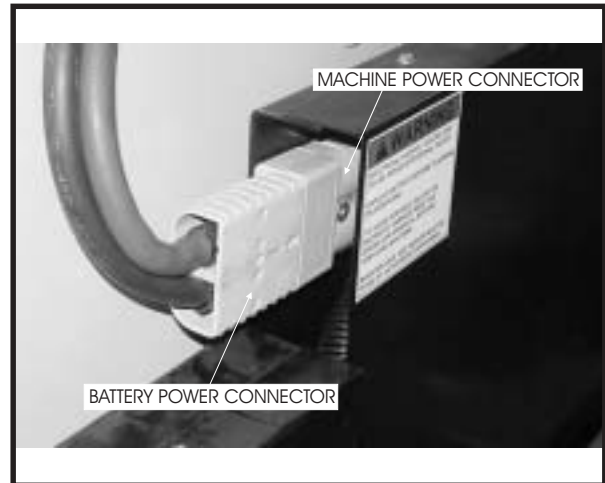

Fig 8

### BATTERY INSTALLATION

1. Lift the machine front cover.
2. Rotate the battery lever to the right.
3. Lower the battery into place using a 2000 LB. (907 KG) capacity lifting device.
4. Rotate the battery lever to the left to lock the battery into place.
5. Connect battery wires according to manufacturer's direction.
6. Connect the battery power connector to the machine power connector.
7. Lower the machine front cover into place.



### WARNING

Do not leave charged batteries on concrete surface, they will discharge.

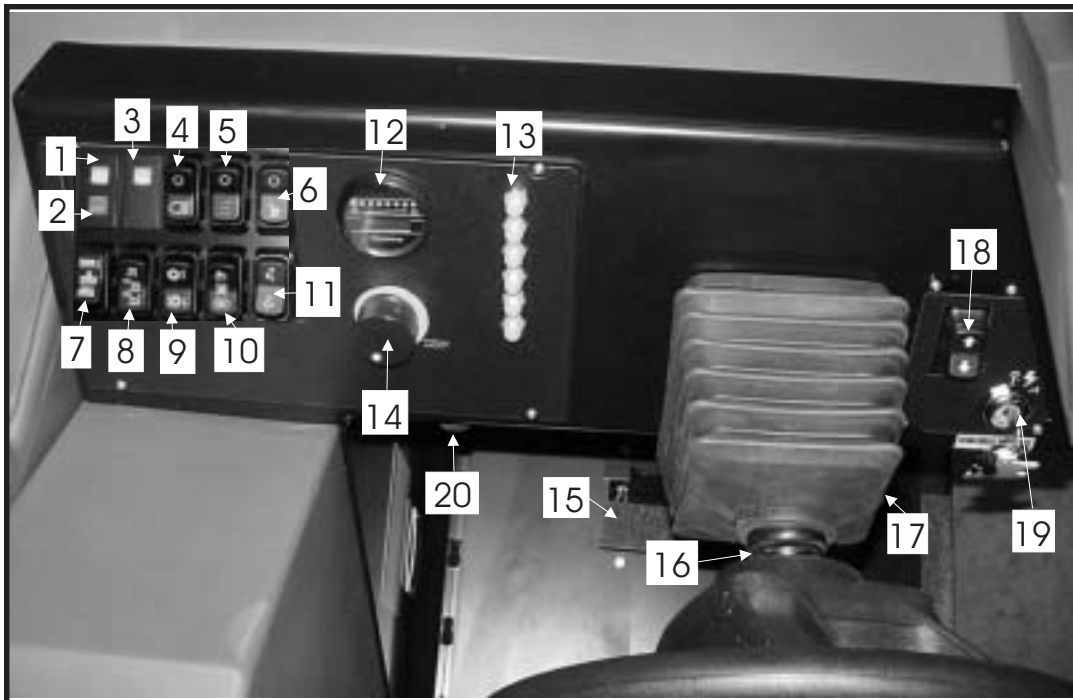

Figure 9

1. High recovery light.
2. Low solution light
3. Hopper open light.
4. Light switch.
5. ESP switch.
6. Spray Vac Wand switch.
7. Scrub brush switch.
8. Squeegee switch.
9. Main side broom switch.
10. Filter shaker/Dust control switch.
11. Hopper switch.
12. Battery condition meter/Hour meter.
13. Circuit breakers.
14. Solution flow knob.
15. Parking Brake.
16. Steering wheel adjustment lever.
17. Foot throttle.
18. Forward/Reverse switch.
19. Key switch.
20. Horn



Figure 10

**KEY SWITCH**

The keyed ignition switch is located on the operator's console as shown in figure 10.

The "OFF" position (O position) will shut off the machine. The IGN/ON position (I position) provides power to all machine systems and accessories.



Figure 11

**FORWARD / REVERSE SWITCH**

The forward/reverse switch is located on the operator's console as shown in figure 11. Pressing the upper half of the forward/reverse switch will result in the machine moving forward when the foot throttle is depressed. Pressing lower half of the forward/reverse lever switch will result in the machine moving backward when the foot throttle is depressed.

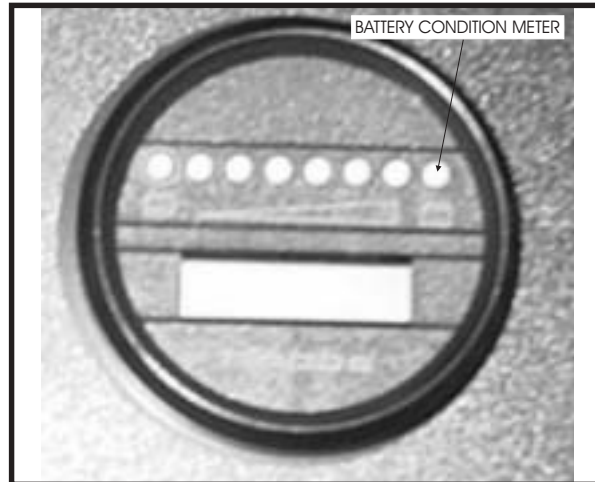

Figure 12

### BATTERY CONDITION METER

The battery condition meter is located on the instrument panel as shown in figure 12. The condition meter indicates the level of charge in the batteries. The batteries are sufficiently charged when all of the LED's are illuminated amber as shown on the ramp illustration. Charge the batteries when one red LED is illuminated on the left at the bottom of the ramp diagram and the scrub brushes stop. Do not operate the machine.

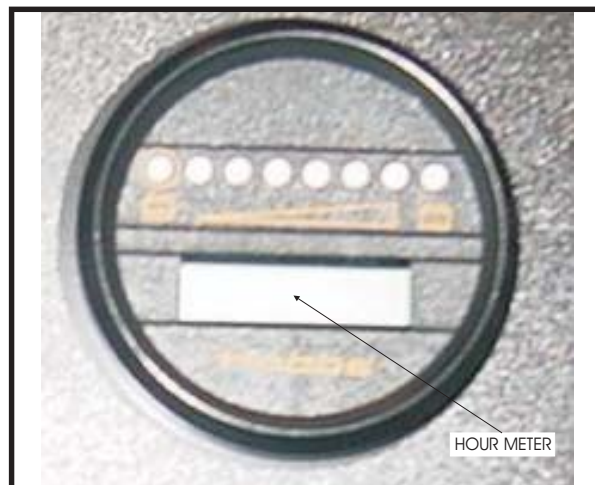

Figure 13



### NOTE

To reengage, the key must be returned to the "OFF" position.

### HOUR METER

The hour meter is located on the instrument panel as shown in figure 13. The display will show the total hours the machine has been in operation. The meter is activated when the key switch is placed in the ignition position. The meter can be used to determine when maintenance should be done on the machine.



Figure 14

**HEADLIGHT/TAILLIGHT SWITCH (Optional)**

The light switch is located on the instrument panel as shown in figure 14. By pressing on the lower half of the switch the headlights and taillights will be activated. Pressing the upper half of the switch will turn off the lights.



Figure 15

**HOPPER OPEN LIGHT WARNING**

The hopper open light switch is located on the instrument panel as shown in figure 15. When the hopper is open, the light is illuminated the broom and the dust control fan will stop.



Figure 16

### **FILTER SHAKER SWITCH (Only models with dust control)**

The filter shaker switch is located on the instrument panel as shown in figure 16. By pressing and holding in the upper half of the switch, it will activate the filter shaker motors for 20 to 30 seconds. Releasing the switch, returns to the off position.

The dust control fan will stop when the filter shaker has been activated. The filter shaker will only operate with the hopper in the "DOWN" position.



Figure 17

### **DUST CONTROL SWITCH**

The dust control switch is located on the instrument panel as shown in figure 17. To turn on the dust control system for normal sweeping, press the lower half of the switch.



### **WARNING**

**Turn the dust control switch to the center "OFF" position while wet sweeping. Water will damage the filter and cause premature filter failure.**





Figure 18

### SCRUB BRUSH SWITCH

The scrub brush switch is located on the left of the instrument panel as shown in figure 18. Pressing the top half of the switch raises the scrub deck and turns off the brushes. The middle switch position lowers the brushes to the normal down position for scrubbing. Pressing the lower half of the switch lowers the scrub deck to the heavy down position, supplying additional downward pressure for extremely dirty surfaces.



### NOTE

**Lowering the scrub deck does not turn on the brushes. The brushes turn on automatically when the machine moves forward or reverse.**



Figure 19

### SQUEEGEE SWITCH

The squeegee switch is located on the the instrument panel as shown in figure 19. Pressing the lower half of the switch lowers the squeegee and activates the squeegee vacuum. Pressing the upper half of the switch will turn off the squeegee vacuum and raise the squeegee. In the middle position the switch will raise the squeegee. In this position the vacuum remains on to allow vacuuming the water that is left in the squeegee recovery hose. This prevents water from dripping on the floor with the squeegee raised. If the squeegee is lowered and the direction of the machine is reversed (activated by the FWD/REV pedal) the squeegee will automatically raise. Moving forward the squeegee will automatically return to the lowered position.



Figure 20

### **LOW SOLUTION LIGHT**

The low solution warning light is located on the instrument panel as shown in figure 20. The low solution warning light illuminates when the solution tank is empty, marking the end of the scrubbing cycle.



Figure 21

### **HIGH RECOVERY LIGHT**

The high recovery warning light is located on the instrument panel as shown in figure 21. The light will illuminate approximately 5 minutes before the recovery tank is full, giving ample time to complete the scrubbing cycle, before the mechanical float shuts off the vacuum to the recovery tank.



Figure 22

**HOPPER LIFT SWITCH**

The hopper lift switch is located on the instrument panel as shown in figure 22. The switch controls the operation of the hopper lift system. To raise the hopper for dumping, press and hold the lower half of the switch until the hopper reaches the desired height, then release. To close the hopper press in and hold the upper half of the switch until the hopper closes completely then release.

 **WARNING**

To prevent the hopper from closing while doing maintenance lock the hopper in the open position into place with the safety arm.



Figure 23

**SIDE BROOM and MAIN BROOM SWITCH**

The side broom and main broom switch is located on the instrument panel as shown in figure 23. By pressing in the upper half of the switch, the side and main broom are raised and turned off. To lower and turn on both brooms, press the lower half of the switch.



Figure 24

### **SPRAY AND VAC WAND SWITCH (Optional)**

The spray and vac wand switch is located on the instrument panel as shown in figure 24. Pressing the bottom half of switch turns on the vacuum motor and the solution pump. Pressing the top half of the switch turns the vacuum motor and solution pump off.



Figure 25

### **ESP SWITCH (Optional)**

The ESP switch is located on the instrument panel as shown in figure 24. The ESP switch transfers water from the recovery tank through a filter and into the solution tank. When the switch is in the down position the pump will operate when the high recovery light is illuminated. Clean the recovery tank when the tank is emptied.



#### **NOTE**

**Do not place clean water in the recovery tank when using ESP option, the solution tank could become overfilled during operation.**

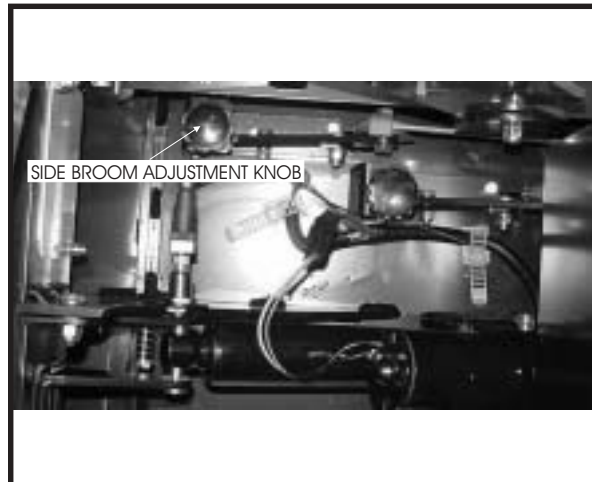

Figure 26

**SIDE BROOM ADJUSTMENT**

The side broom adjustment knob for changing the sweep height to compensate for broom wear, is located in front of the machine to the right of the dust control filter as shown in figure 26. Turning the knob to the left (counterclockwise) will lower the side broom.

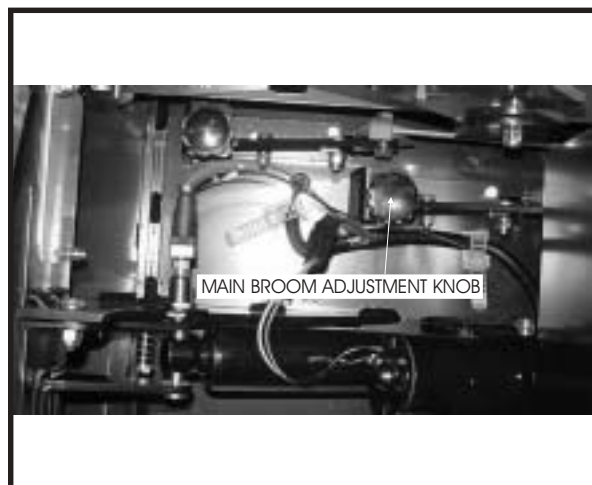

Figure 27

**MAIN BROOM ADJUSTMENT**

The main broom adjustment knob for changing the sweep height to compensate for broom wear, is located in front of the machine to the right of the dust control filter as shown in figure 27. Turning the knob to the left (counterclockwise) will lower the main broom.

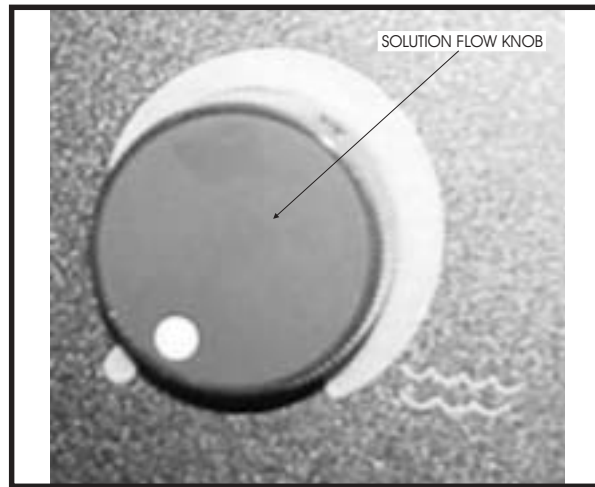

Figure 28

### SOLUTION FLOW KNOB

The solution flow knob is located on the instrument panel as shown in figure 28. Turning the knob clockwise will increase the flow of solution and water. The farther the solution control knob is turned the heavier the flow of water and solution will be. Turning the knob counterclockwise will decrease the flow of the water and solution. To turn the water and solution off turn the knob all the way counterclockwise.



### NOTE

**For best results, discontinue application of solution 10 feet before stopping or making a 90° or 180° turn.**



Figure 29

### HORN BUTTON

The horn button is located on the instrument panel as shown in figure 29. The horn button is always active. Pressing the horn button will sound the horn.



Figure 30

**FOOT THROTTLE**

The foot throttle is located to the right of the brake pedal on the floor of the operator's compartment as shown in figure 30. This pedal controls the machine travel speed. Press the forward/reverse switch to choose the travel direction, and then press down on the foot throttle to move set the machine in motion. Increase the foot pressure to increase the travel speed.

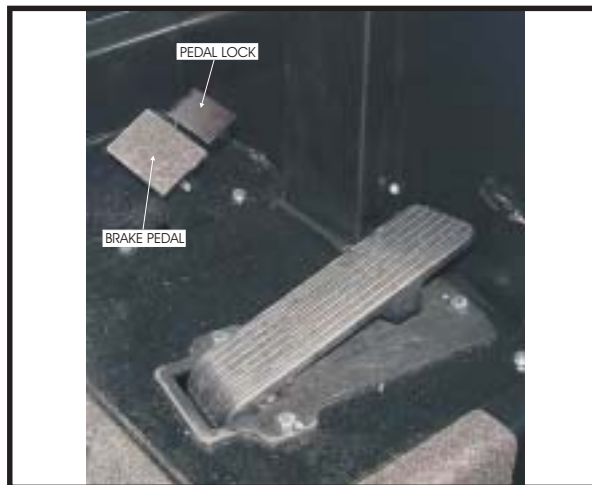

Figure 31

**PARKING BRAKE**

The parking brake is located on the floor of the machine left of the foot throttle as shown in figure 31. To set the parking brake, press down on the foot pedal and the press down the lock. To unlock the parking brake, push down on the upper portion of the foot pedal and release.



Figure 34

### **SEAT POSITION ADJUSTMENT**

The seat position adjustment lever is located on the front of the seat to the left as seen in figure 34. The lever is spring loaded to the lock position. To adjust the seat, push the lever to the left and move the seat to the desired position and then release the lever to lock the seat into place.

### **SAFETY FEATURES**

**SEAT SAFETY SWITCH** - Machine will not move and parking brake will set if this switch is not activated.

**SPEED INTERLOCK** - Maximum machine speed will be reduced while scrub brushes are in use.

**BRUSHES OFF IN NEUTRAL** - Scrub brushes automatically disengage when machine is idle.

**AUTOMATIC RECOVERY VACUUM SHUT-OFF** - Vacuum fans will shut down when recovery tank is full.





## NOTE

Before starting the engine, perform the pre-start checklist. Before starting the engine, perform the pre-start checklist.

### PRE-START CHECKLIST

- Check hydraulic fluid level.
- Check all systems for leaks.
- Check brakes and controls for proper operation.
- Check broom patterns.
- Check hydraulic fluid level.
- Check hydraulic connections for leaks.
- Check brakes and controls for proper operation.
- Check broom pattern.
- Check to ensure that all covers, panels and access doors are securely closed.



Figure 35



Figure 36

### TO FILL SOLUTION TANK

Open the solution lid located on the top left side of the machine as shown in figure 36. Fill tank with 55 gallons of water and the correct mixture of American Lincoln Commercial cleaner for the job on hand. Close the solution tank.

## OPERATING INSTRUCTIONS

---

### TO START MACHINE

Turn key to "I" position.

### TO TRANSPORT MACHINE

1. Make sure the brushes and squeegees are in the up or raised position with all other controls in the off position.
2. Release the parking brake.
3. Push the forward/reverse switch to desired position (up for forward and down for reverse)
4. Push down on the foot throttle to obtain desired travel speed.
5. Release the foot throttle to slow down or stop when on a flat surface. To slow the machine when descending down an inclined surface reduce foot pedal pressure.



#### NOTE

**The pedal proportional braking system is designed to regulate machine speed according to the foot throttle position. This system is designed to bring the machine to a stop in controlled manner. When driving down an inclined surface, reduce foot pedal pressure rather than releasing the foot throttle. This will provide a controlled stop and prevent the drive wheel from locking.**



#### WARNING

**Do not turn the steering wheel sharply when the machine is in motion. The sweeper is very responsive to movement of the steering wheel. Do not make sudden turns.**



Figure 38

### TO BEGIN THE CLEANING OPERATION

1. Select the operating mode  
NORMAL = ESP
2. Lower brushes to the desired position.  
SCRUB DECK = NORMAL RANGE OR HEAVY
3. Place the squeegee switch in the lower position.  
SQUEEGEE BLADE = LOWER
4. Move solution control knob to the desired setting and begin operation.

### SCRUBBING THE AVERAGE FLOOR WITH LIGHT TO MEDIUM SOILAGE

In this operation, cleaning is accomplished in one pass, with simultaneous solution feed, scrubbing and dirty water pick up. The rate of solution feed and the speed of travel required will vary with floor condition. This knowledge will come with operator experience.

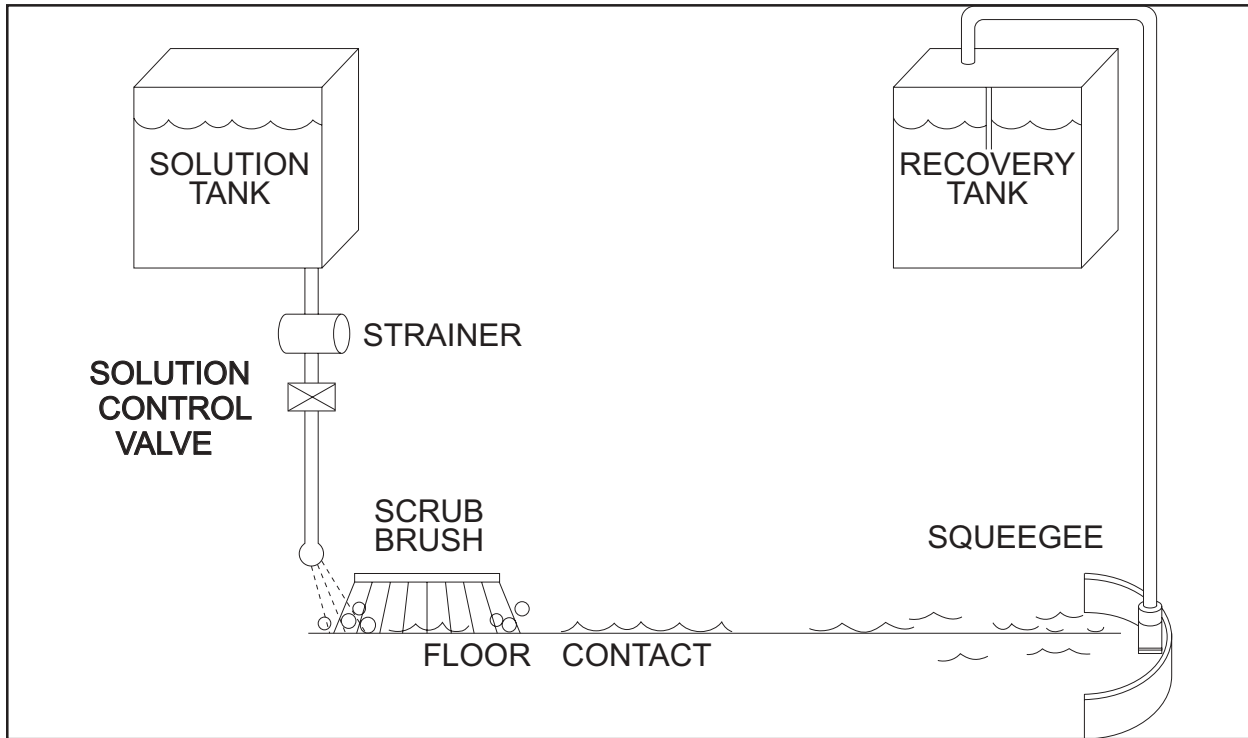

Fig. 39

### THE NON-RECYCLING OR STANDARD SCRUBBING MODE

During the scrubbing process, detergent solution water from the solution tank is fed to the solution line. There it is fed to the floor where three disc scrubbing brushes work to dislodge soil. After scrubbing, the dirty solution is vacuumed from the floor and discharged into the containment chamber in the forward portion of the recovery tank, where a system of baffles helps to clarify the solution.

Sensors in each tank will indicate, by lights on the control panel, when the water in the solution tank is too low or when the water in the recovery tank is too high.

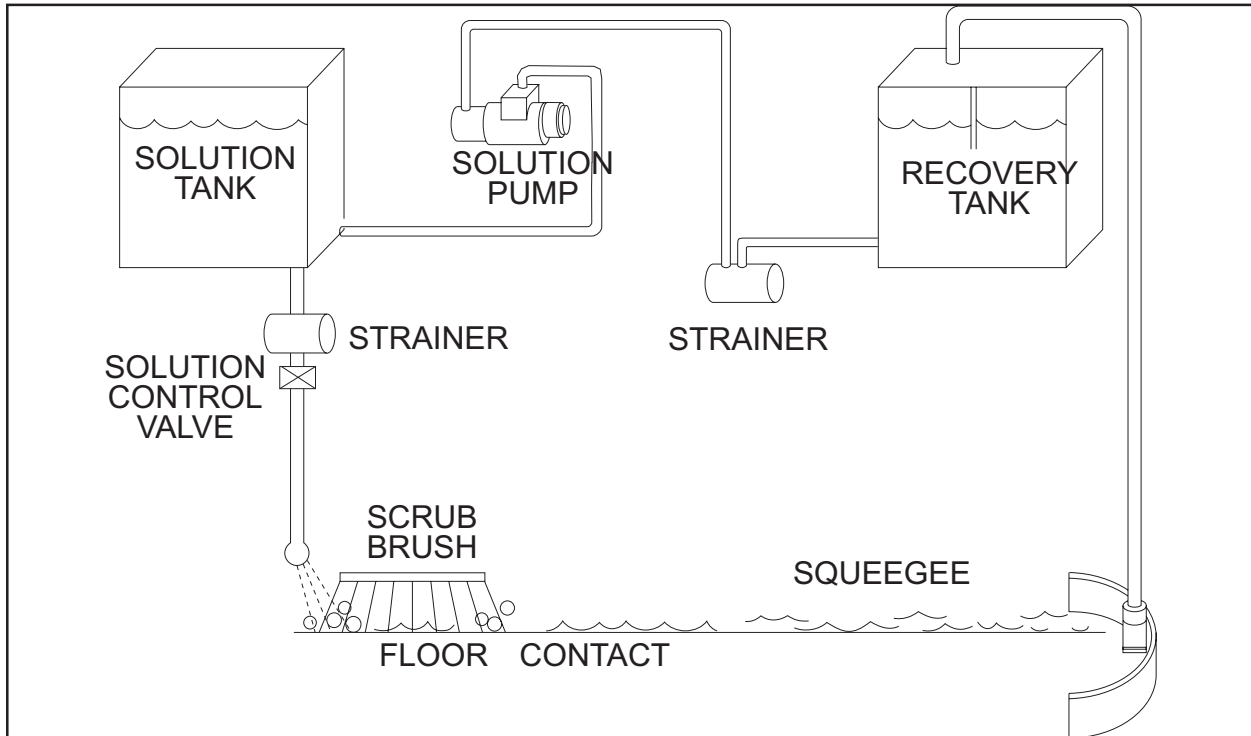

Fig. 40

**ESP OPERATING MODE**

During the scrubbing process, filtered water from the solution tank is fed to the solution line, where it combines with detergent. This mixture is then fed to the floor where two or three disc scrubbing brushes work to dislodge soil. After scrubbing, the dirty solution is vacuumed from the floor and discharged into the recovery tank. At intervals, a float switch activates the recycling pump, which sends filtered solution from the recovery tank to the solution tank.

## OPERATING INSTRUCTIONS

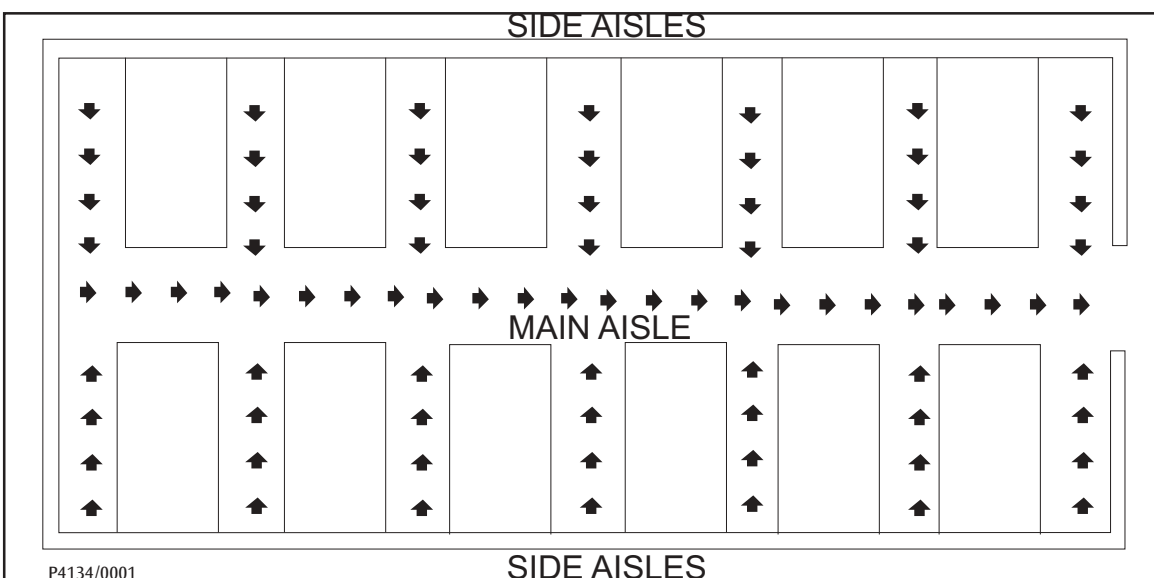

Fig. 41

### SCRUBBING PATH

- Scrub in straight paths. Do not bump posts. Do not scrape the sides of the machine.
- When the machine is in motion, do not push the directional/speed control pedal all the way forward. This is the same as starting in "high" and will put a strain on the motor and drive system.
- Plan your sweeping and scrubbing in advance. Try to arrange long runs with minimum stopping and starting. Sweep debris from narrow aisles out into main aisle ahead of time. Do an entire floor, or section at on time.
- Pick up oversize debris before sweeping.
- Allow a few inches of overlap of sweep and scrub paths. This will eliminate leaving dirty patches.
- Allow a few inches of overlap of sweep and scrub paths. This will eliminate leaving dirty patches.
- Don't turn steering wheel to sharply when machine is in motion. The machine is very responsive to movement of the steering wheel; so avoid sudden turns.
- Try to follow as straight a path as possible. Avoid bumping into posts or scraping the sides of the machine.
- When placing the machine in motion, avoid slamming the directional control pedal all the way forward suddenly. This is equivalent to starting out in "HIGH" and puts needless strain on the drive system. Periodically, turn the sweeping broom end for end to prevent the bristles from "settling" in one direction.

### TO STOP THE CLEANING OPERATION

Discontinue the cleaning operation when the low solution light or the high recovery light illuminates, this indicates the solution tank is empty or recovery tank is full. Discontinue the scrubbing cycle, put all controls in the forward position for transport and drive to the drain area.



#### NOTE

**After stopping, perform these post operation checks.**

## POST OPERATION CHECKLIST

Check Battery Condition and recharge, if necessary.

1. Check all flaps for wear, damage and adjustment.
2. Drain and clean recovery tank.
3. Clean recovery tank screen and float.
4. Check scrub brushes for wear or damage.
5. Check rear and side squeegee for wear, damage and adjustment.
6. Clean the debris in hopper
7. Check main and side broom for wear or damage.

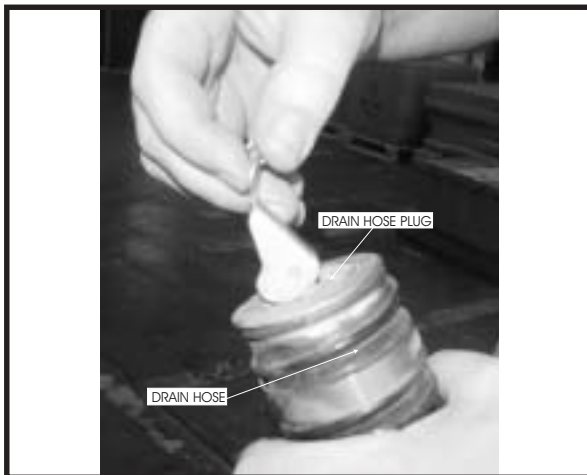

Fig. 42

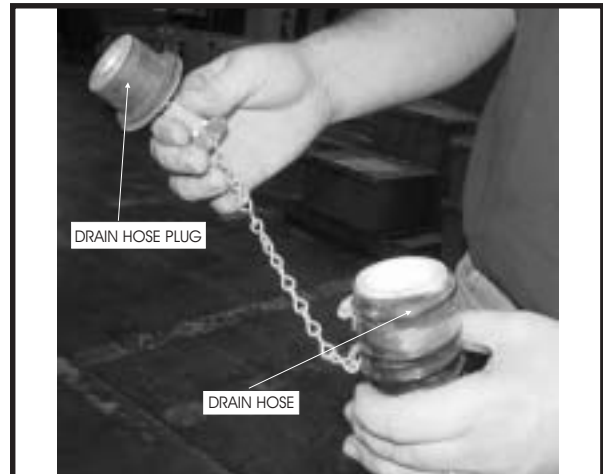

Fig. 43



Fig. 44

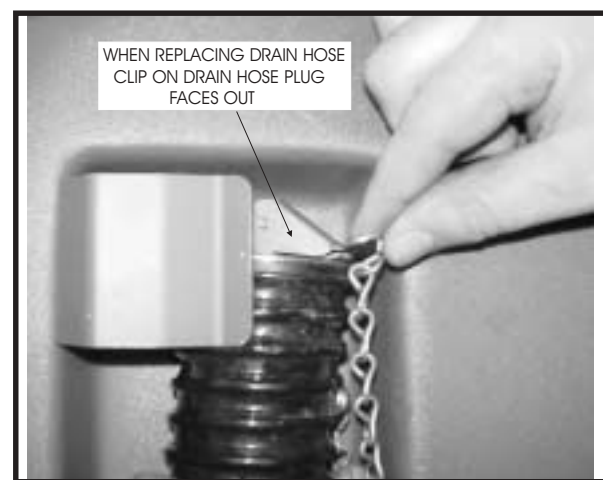

Fig. 45

## TO DRAIN RECOVERY TANK

The drain hose for the recovery tank is located on the back of the machine. To drain the tank, remove and lower the hose and place in a suitable floor drain as shown in figure 44. Open the drain hose plug as shown in figure 42 and 43.



## IMPORTANT

Improper discharge of wastewater will damage the environment and is illegal. The U.S. Environmental Protection Agency has established certain regulations regarding discharge of wastewater. The local city and state regulations regarding wastewater discharge may be in effect in your area. Understand and follow the regulations in your area. Be aware of the environmental hazards associated with the substances you dispose of.

## OPERATING INSTRUCTIONS



Fig. 46



Fig. 47

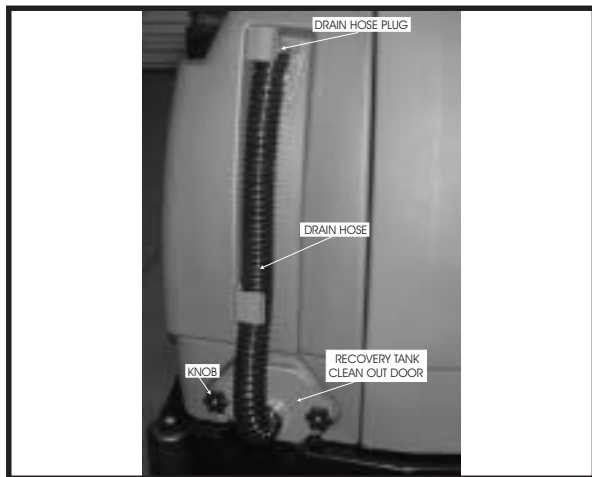

Fig. 48

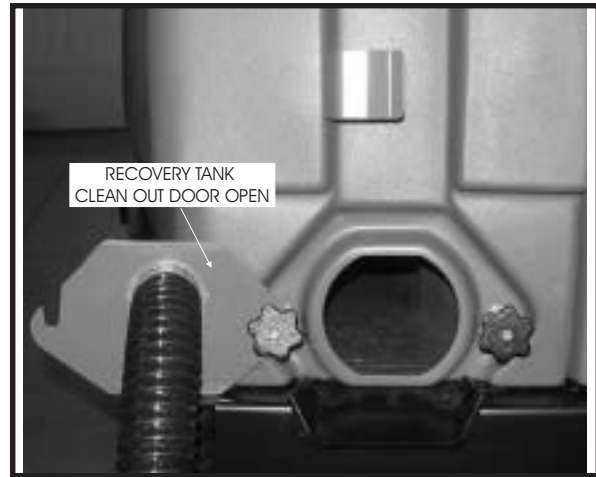

Fig. 49

When the draining operation is complete, open the recovery tank clean out door as shown in figure 49 and flush the recovery drain hose as shown in figure 46. Clean the recovery tank and recovery tank screen as shown in figure 47. Close the recovery tank clean out door, drain hose plug, the recovery tank lid and clip the drain hose into place as shown in figure 48.



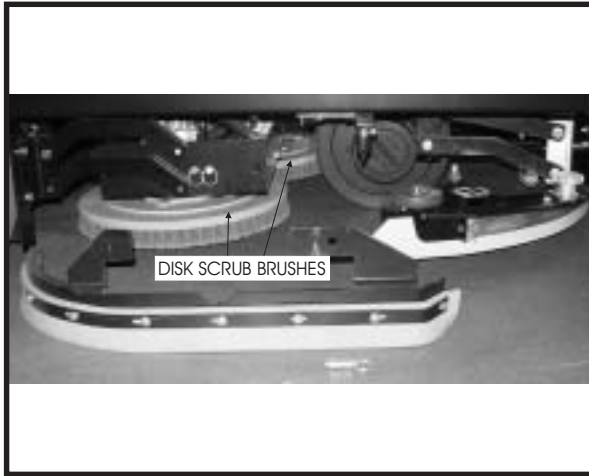

Fig. 50

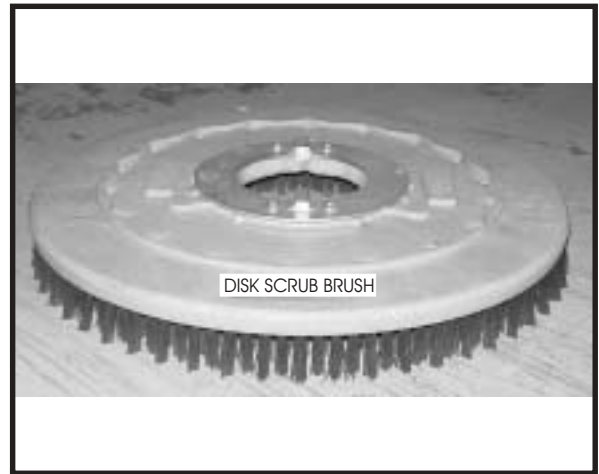

Fig. 51

Inspect the disk scrub brushes and replace when the bristles are reduced to  $\frac{3}{4}$  in length as shown in figure 50 and 51. To order replacement brushes, see scrub brush options in this manual.

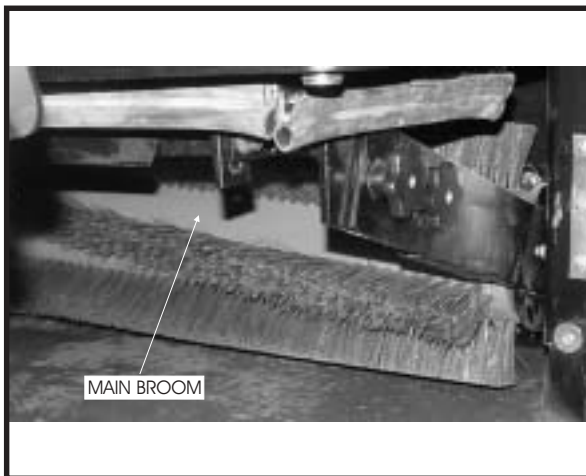

Fig. 52



Fig. 53

Inspect the main and side broom. When the bristles are worn to 1 1/2 inch length replace the main broom as shown in figure 52 and replace side broom when bristles are worn to 3 1/2 inch as shown in figure 53.



Fig. 54

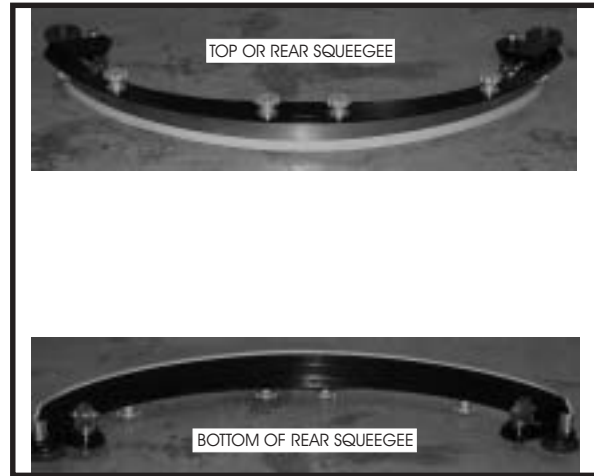

Fig. 55



Fig. 56

Inspect the rear and side squeegee blades for wear. If the wiping edge becomes rounded, remove and reinstall so the unworn edge is now the wiping edge. This process can be repeated until all four edges are worn. If the squeegee blade has become rippled, it will need to be replaced.

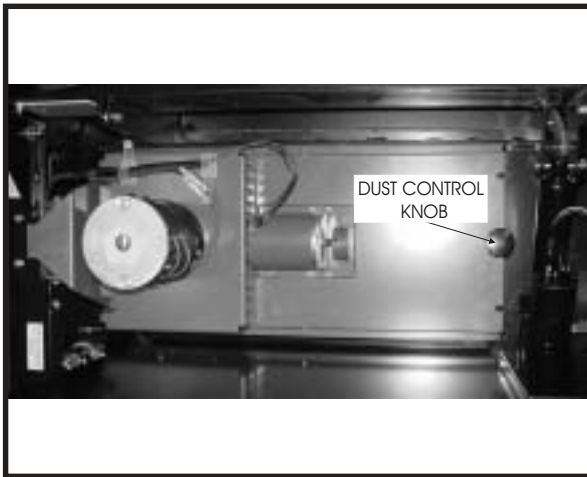

Fig. 57

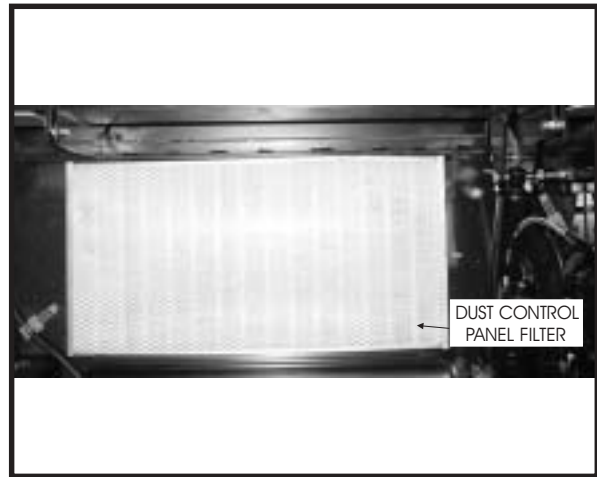

Fig. 58

**DUST CONTROL KNOB**

The dust control knob is used to hold the dust control filter cover down as shown in figure 57. The dust control filter is located under the front cover and will need to be removed periodically for cleaning or replacement. Removal of the filter panel requires no tools. The front cover must be opened to gain access to the filter compartment. The panel filter is held in place by a hinged frame and knob. To remove the panel filter, turn the knob counterclockwise and lift the hinged frame. The panel filter can now be lifted out and cleaned or replaced. To install the replacement panel filter, place a new filter in the machine, lower the frame and twist the knob clockwise to lock the filter in place.

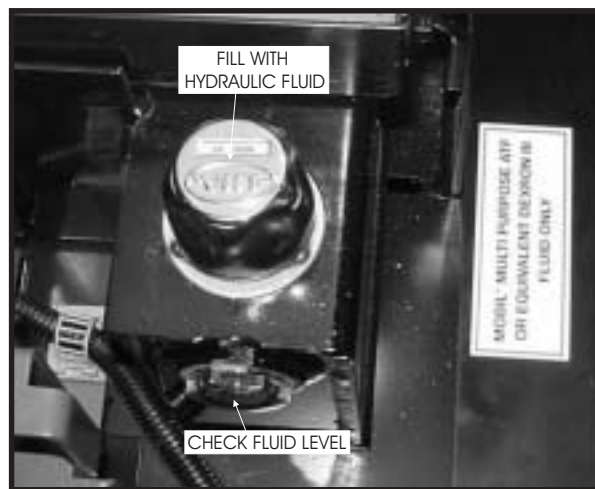

Fig. 59

**HYDRAULIC RESERVOIR LEVEL SIGHT GAUGE**

The sight gauge is located on the right side of the machine under the front cover as shown in figure 59. The sight gauge is used to indicate the level of fluid in the reservoir. The fluid level must be visible in the sight gauge when the hopper is in the down position.

## MAINTENANCE

---

### SERVICE CHART

Check items for proper operation. If service is required, please contact an authorized American-Lincoln Technology distributor. For best performance, replace worn parts with genuine American-Lincoln parts.

#### **EVERY eight (8) HOURS or DAILY check and clean/adjust if necessary:**

- 1 Inspect panel filter for damage and clean them.
- 2 Inspect and clean hopper.
- 3 Inspect and clean recovery tank screens and filters.
- 4 Check hydraulic fluid level.
- 5 Check all flaps for wear or damage.
- 6 Check brooms for wear or damage, adjust as required.
- 7 Check brake pedal and parking brake.
- 8 Check hydraulic oil filter.
- 9 Check battery electrolyte level.
- 10 Check all fluid system components for leaks.

#### **50 HOUR (WEEKLY) MAINTENANCE CHECKLIST**

- 11 Check solution tank (recycling or ESP system).
- 12 Check solution filter screen (recycling or ESP system).
- 13 Check recovery tank.
- 14 Check recovery tank screens and filters.
- 15 Inspect scrub brushes for wear or damage.
- 16 Inspect rear and side squeegees for wear or damage.
- 17 Check battery electrolyte level.
- 18 Check all hydraulic hoses for wear or cuts.
- 19 Rotate main brush.
- 20 Clean or replace panel filter.
- 21 Lubricate squeegee casters.

#### **100 HOUR MAINTENANCE CHECKLIST**

- 22 Lubricate front wheel bearings.
- 23 Lubricate all moving joints.

#### **250 HOUR MAINTENANCE CHECKLIST**

- 24 Lubricate squeegee casters.
- 25 Clean solution tank and filter screen.
- 26 Replace hydraulic filter element.
- 27 Clean hydraulic reservoir.

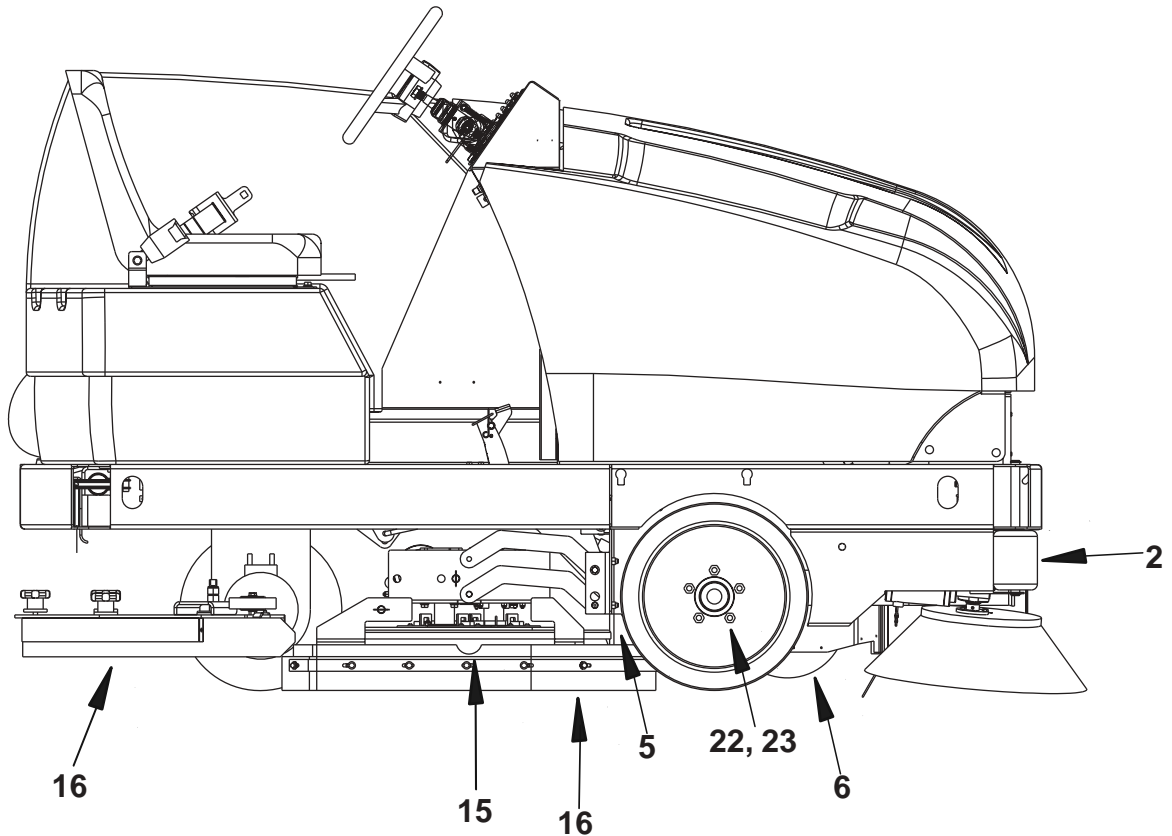
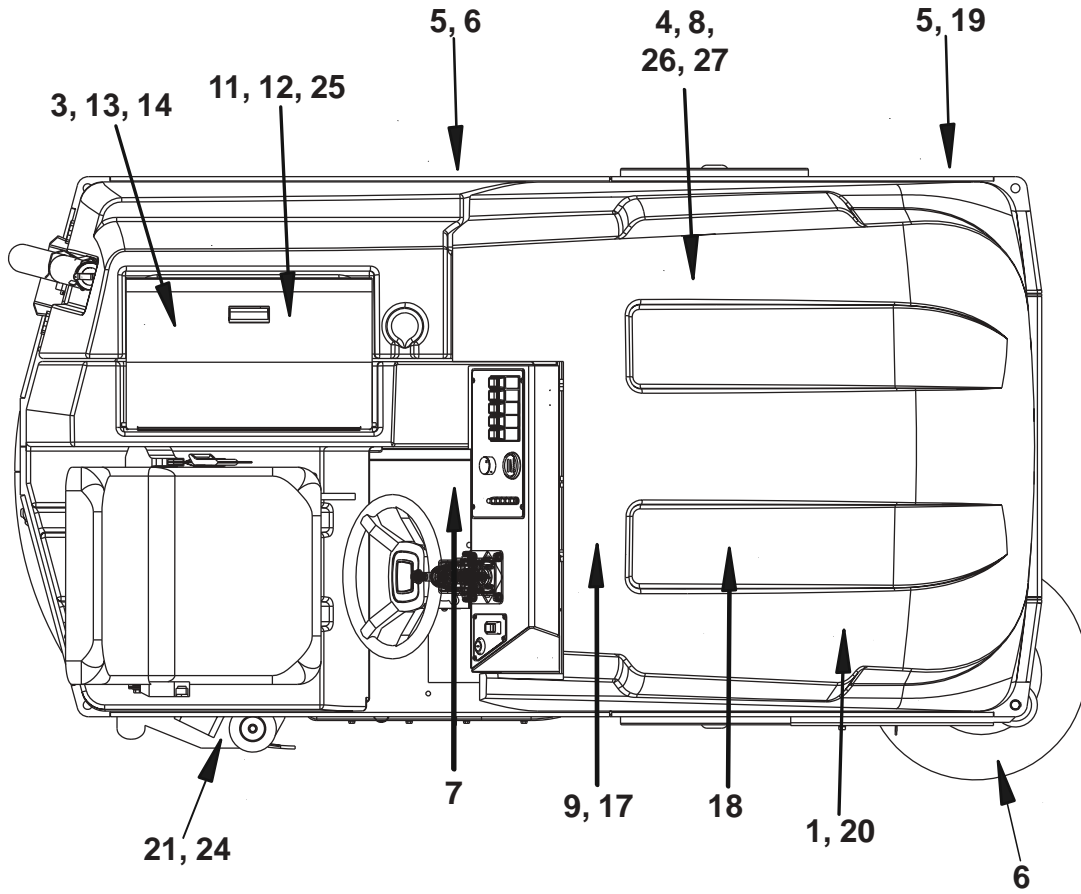

## MAINTENANCE

---

For safety, read and follow the service precautions below. Know the hazards associated with the equipment you are working on to prevent personal injury or damage to equipment.

For service assistance, consult your nearest American-Lincoln dealer. For best performance replace worn parts with genuine American-Lincoln parts.

Refer all maintenance and service requirements to qualified maintenance personnel.

DO NOT attempt to service this machine until you have read and understand all safety warnings associated with the equipment you are working on.



### WARNING

- **Maintenance and repairs must be done by authorized personnel only.**
- **Electrical repairs must be done by authorized personnel only. Consult your American-Lincoln Authorized Service Person to do service procedures. Use only genuine American-Lincoln parts.**
- **Always park on a level surface, turn key off, and engage parking brake before working on the machine to keep it from creeping or rolling.**
- **Maintenance and repairs must be done by authorized personnel only. Always empty the solution tank and the recovery tank before doing any maintenance. Keep all fasteners tight. Keep adjustments according to the specifications as shown in the Service Manual for this machine.**
- **Always wear eye protection and protective clothing when working near batteries. Do not put tools or other metal objects across the tops of the batteries. NO SMOKING.**
- **To prevent damage to the machine, and discharge across the tops of the batteries, do not fill the batteries above the bottom of the tube in each cell. Wipe any acid from the machine or the tops of the batteries. Do not add acid to a battery after installation.**
- **The hopper could fall and cause serious injury. Always engage the hopper safety arm before working under the hopper.**
- **To maintain the stability of this machine in normal operation, the overhead guard, or similar equipment installed by the manufacturer as original equipment should not be removed. If it becomes necessary to remove such equipment for repair or maintenance, this equipment must be reinstalled before machine is placed back in operation.**

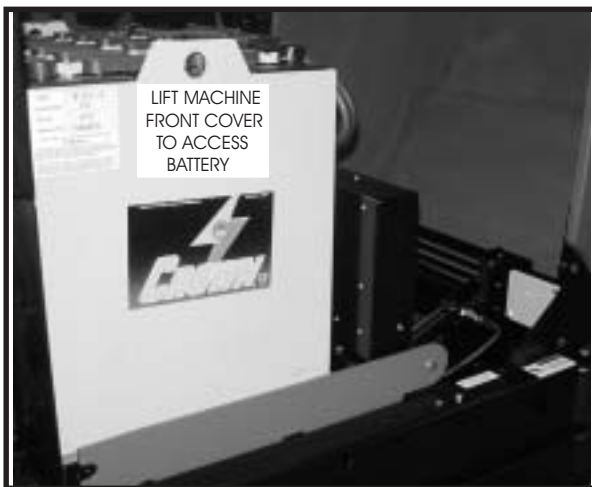

Fig. 60

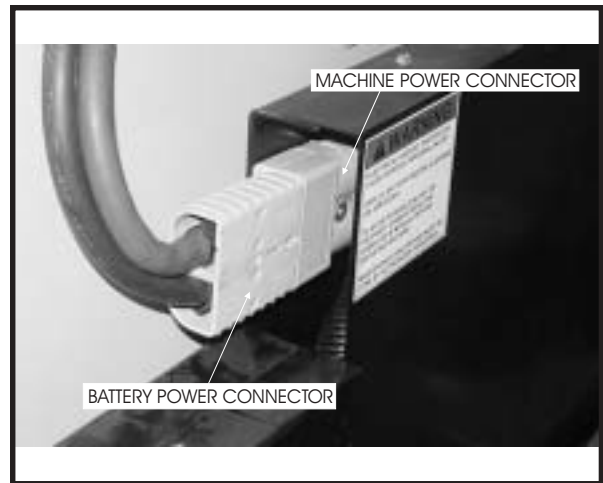

Fig. 61

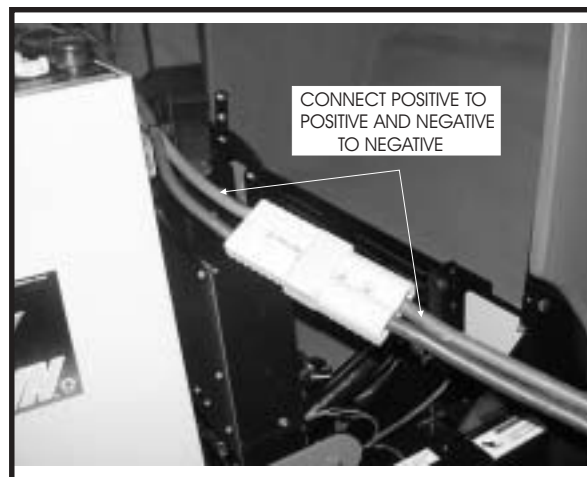

Fig. 62

### BATTERY CHARGING INSTRUCTIONS

When the battery conditioning meter is illuminated with one red LED light, the battery needs to be recharged. To prevent interruption of the cleaning cycle, charge the battery after using.

1. Lift the machine front cover.
2. Disconnect the battery power connector from the machine power connector.
3. Plug the battery power connector into the battery charger.
4. Follow manufacturer's charging instructions provided on the charger.
5. Maintain electrolyte level in battery, check after charging. Add distilled water as needed.

## MAINTENANCE

### WARNING

- Do not remove the battery from the machine if there is waste in the solution tank.
- Hydrogen gas is formed during the charging operation and is explosive! Only charge batteries in a well-ventilated area with the lid open. Avoid any open flame or electrical sparks. Pulling out the charger plug, with the charger still on, will cause an arc and must be avoided.
- Batteries are heavy. Use lifting device with specified rated capacity.
- Always remove jewelry, wear protective clothing, and face protection when working near batteries.
- Lead acid batteries generate gases, which cause explosions. Keep sparks and flames away from batteries charge the batteries only in area with good ventilation. NO SMOKING!
- To prevent an explosion, disconnect the AC plug from the receptacle before connection or disconnect the DC plug on the charger.
- The battery box can slide off a forklift and cause severe personal injury or damage to equipment. Ensure that the battery box is properly secured to the forks of the forklift during transport, drive and stop with caution.

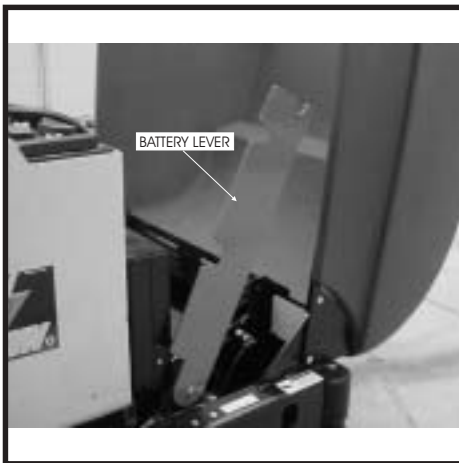

Fig. 63

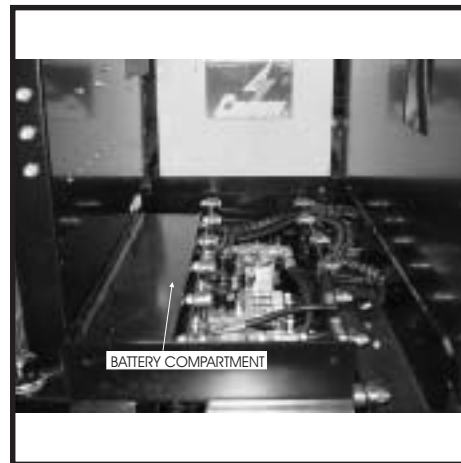

Fig. 64



Fig. 65



Fig. 66

### BATTERY REMOVAL

When removing batteries

1. Lift the machine front cover to access battery compartment.
2. Unplug the battery power connector from the machine power connector.
3. Rotate the battery lever to the right.
4. Lift the battery out using a 2000 LB. (907 KG) capacity lifting device.



**BATTERY REMOVAL WITH THE BATTERY ROLLOUT OPTION**

When removing batteries

1. Lift the machine front cover to access battery compartment.
2. Unplug the battery power connector from the machine power connector.
3. Line up battery cart locator pins with slots in frame and lock in place.
4. Rotate the battery lever to the right.
5. Roll battery out on to cart.

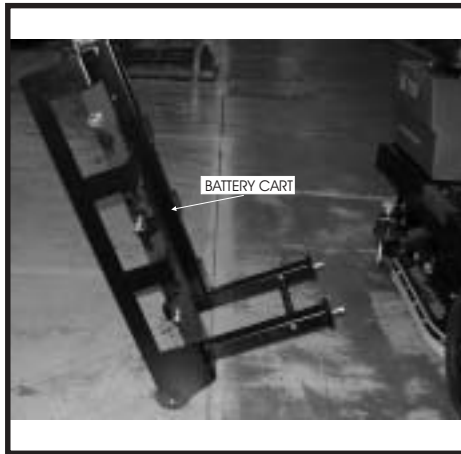

Fig. 67



Fig. 68

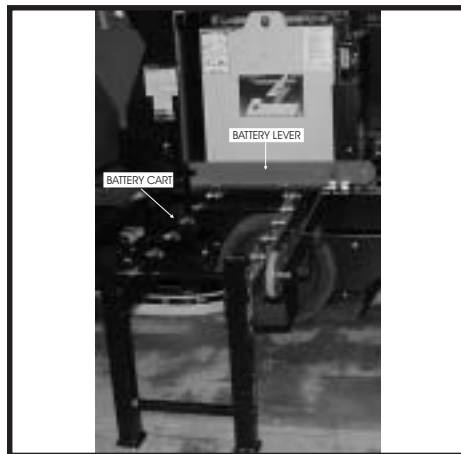

Fig. 69

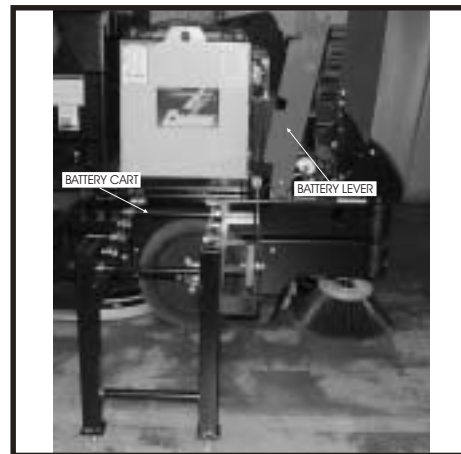

Fig. 70

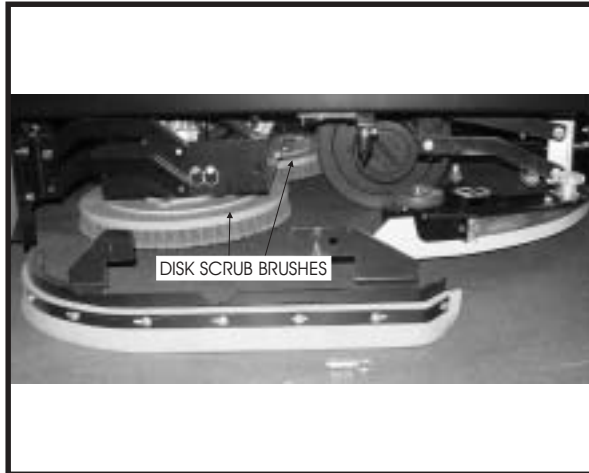

Fig. 71



Fig. 72

### REPLACING SCRUB BRUSHES

1. Raise the scrub brush deck by pressing the "Scrub Brush" switch on the instrument panel.
2. Press the brush latches in to release the scrub brush.
3. Remove the old scrub brush.
4. Snap the new scrub brush into place.

### REPLACING PADS ON A PAD DRIVER

Install a new pad when the old one is worn or dirty. The pad driver assembly is removed and installed the same way a standard scrub brush is (See replacing the scrub brush).

1. The pad driver is held in place by a ring. Pull the pad driver straight down to remove it.
2. Remove the pad holder using the spring wire retainer.
3. Replace the worn pad.

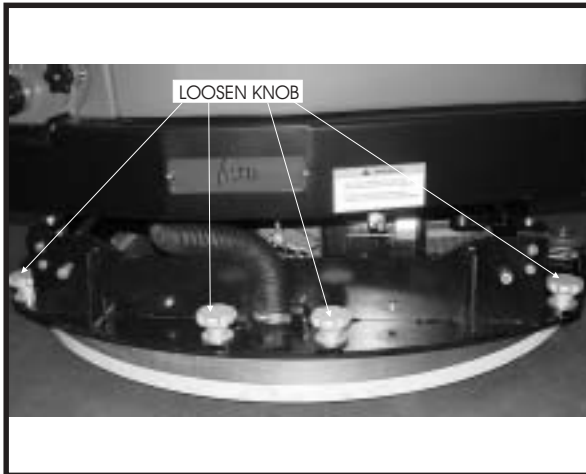

Fig. 73

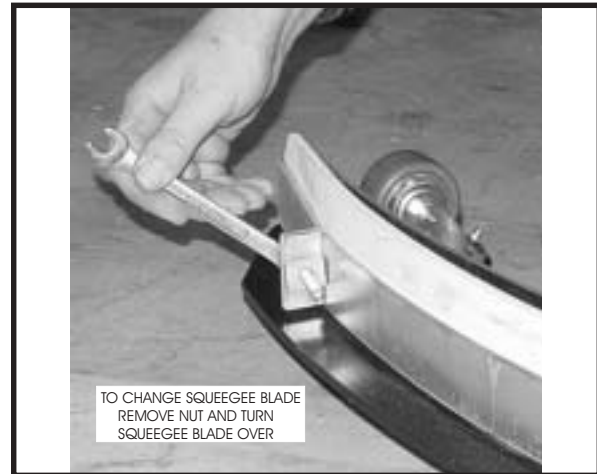

Fig. 74

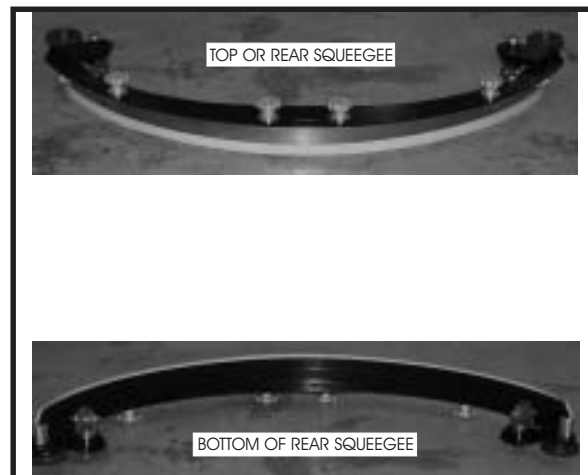

Fig. 75

### REPLACING REAR SQUEEGEE

The squeegee will require service when the inner edge of the blades become round with wear, impairing the wiping action or water pick up.

1. Loosen the four aluminum knobs.
2. Remove the squeegee tool and turn upside down to service the blades or the caster wheels. The squeegee blades are designed to rotate to use an unworn edge.
3. Loosen the clamp bolts.
4. Install blades so that the outer blade is 3/16" longer than the inner blades. This is achieved by assembling the top edge of the blade against the squeegee tool weldment.
5. Reinstall the squeegee clamp band and tighten the clamp bolt.

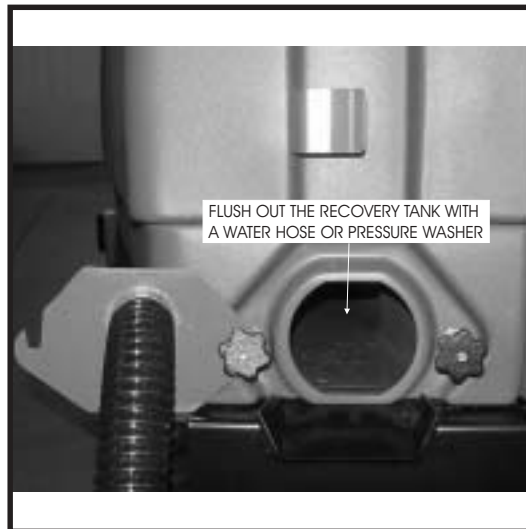

Fig. 76

### DRAINING THE RECOVERY TANK

Drive the machine to a draining area. Loosen the knobs on the recovery clean out door and pivot the door to the left as shown in figure 76. With the water hose flush out the bottom of the recovery tank clean out door to remove larger particles of debris.



Fig. 77



Fig. 78

### DRAINING THE SOLUTION TANK

Lift the cover on the solution/recovery tank. Locate the solution tank drain hose as shown in figure 77. Pull the hose out as shown in figure 78. Open the solution tank drain plug and let the solution tank drain. Clean out and flush the solution tank with a water hose. Tighten the solution tank plug and tuck the solution tank drain hose into place.

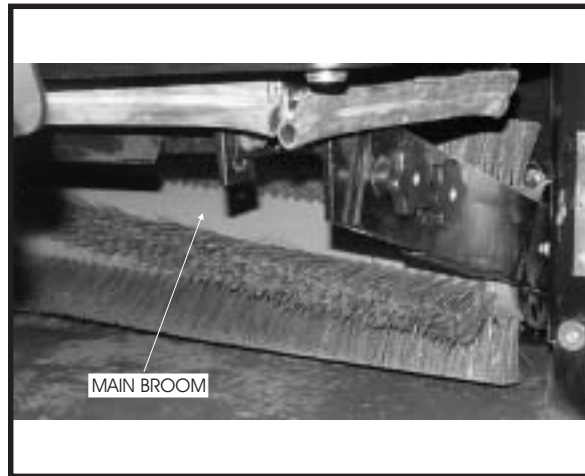

Fig. 79

**MAIN BROOM**

To prevent the broom from setting in one direction and to provide the maximum life of the broom it is recommended that the broom be turned end over end periodically.



Fig. 80

**ADJUSTING THE MAIN BROOM HEIGHT**

The main broom adjustment knob for changing the sweep height to compensate for broom wear is located in front of the machine as shown in figure 80. Turning the knob to the left (counterclockwise) will lower the main broom. When changing the sweep height adjustment, it is recommended the knob be adjusted one turn at a time. After adjusting, recheck the sweep pattern to determine if further adjustment is necessary.

TURN KNOB CLOCKWISE = INCREASE SWEEP PATTERN WIDTH  
 TURN KNOB COUNTERCLOCKWISE = DECREASE SWEEP PATTERN WIDTH



Fig. 81

### MAIN BROOM ACCESS DOOR

The main broom access door is located in front of the left side tire of the machine as shown in figure 81. The door provides access to the main broom for service or inspection. The hopper must be raised to access.



### WARNING

Engage hopper safety arm while accessing the main broom

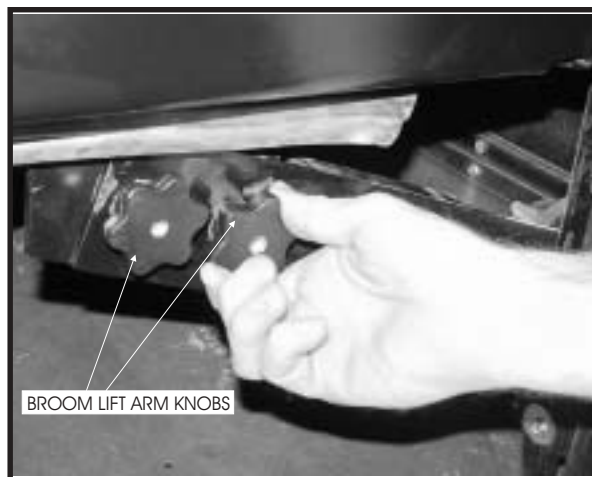

Fig. 82



Fig. 83

### REPLACING THE MAIN BROOM

The Main Broom should be replaced when the bristles become worn to less than 1 1/2". The main broom is held in place by the right side broom door. This feature provides for easy removal and installation of the main broom without the need for special tools or equipment. Lift the hopper to gain access to the main broom compartment. Loosen the main broom access door knob and open the main broom access door. Rotate and remove the broom lift arm knobs counterclockwise to the left as shown in figure 82 and 83.

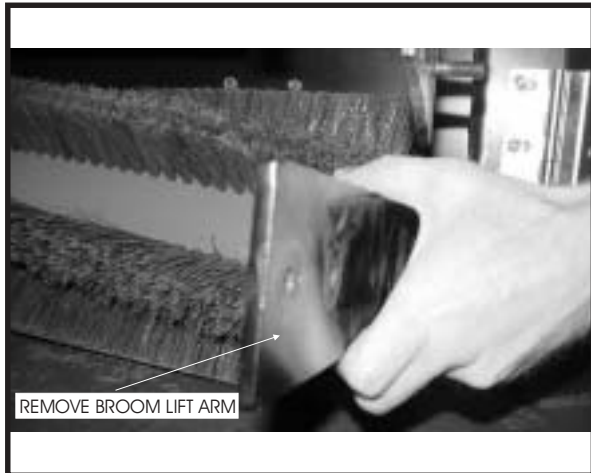

Fig. 84

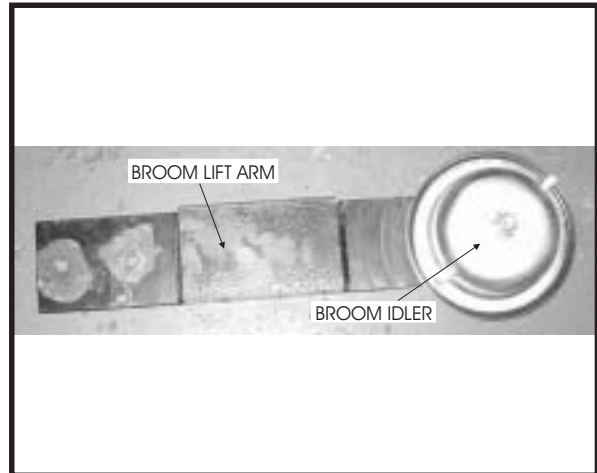

Fig. 85

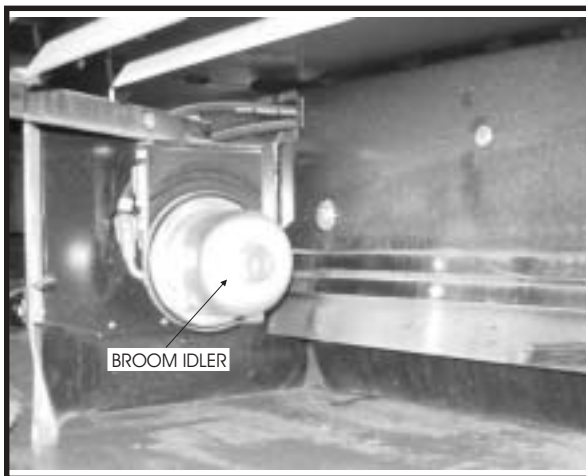

Fig. 86

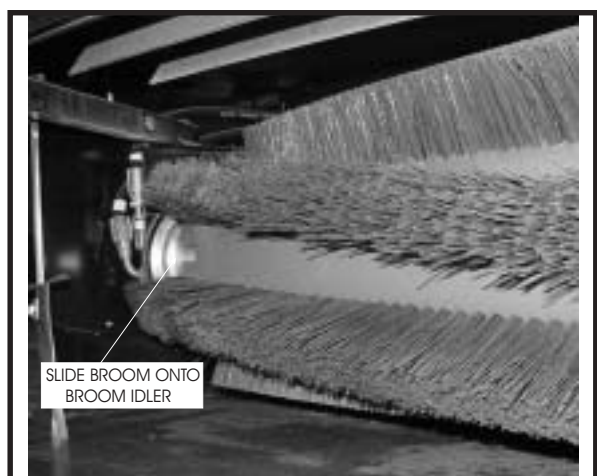

Fig. 87

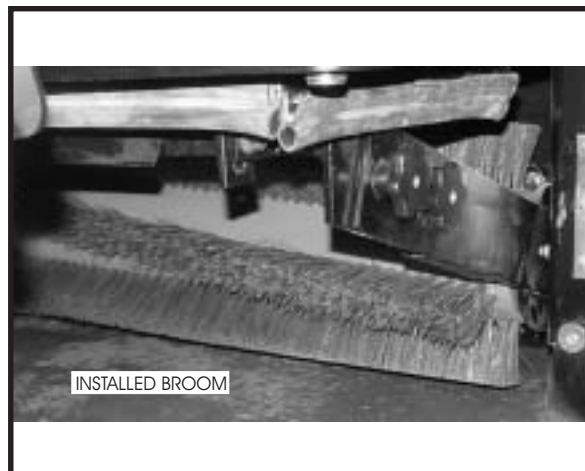

Fig. 88

Remove broom lift arm as shown in figure 84 and 85. Remove the main broom from the from the broom idler exposing the main broom compartment as shown in figure 86. Check and clean out the main broom compartment before installing the new main broom. Slide the main broom onto the broom idler as shown in figure 87. Replace the broom lift arm and rotate the broom lift arm knobs clockwise to tighten into place as shown in figure 88. Adjust the main broom to 1-1/2" to 2" sweep pattern.

## MAINTENANCE

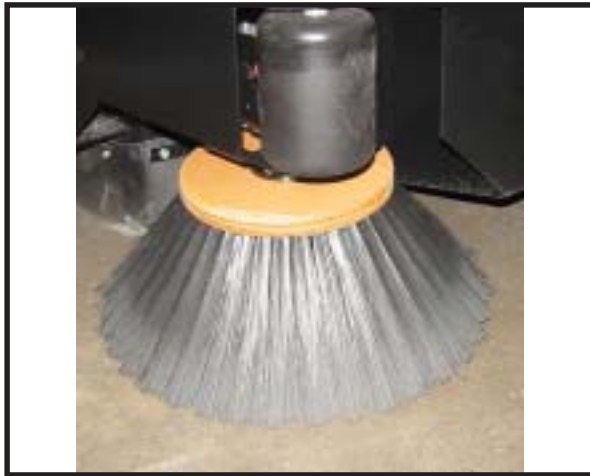

Fig. 89

### SIDE BROOM

The side broom (Fig. 89) sweeping angle is not adjustable. However, the height of the side broom can be adjusted to compensate as the broom becomes worn from use. Always check and adjust the sweep pattern after changing the side broom.

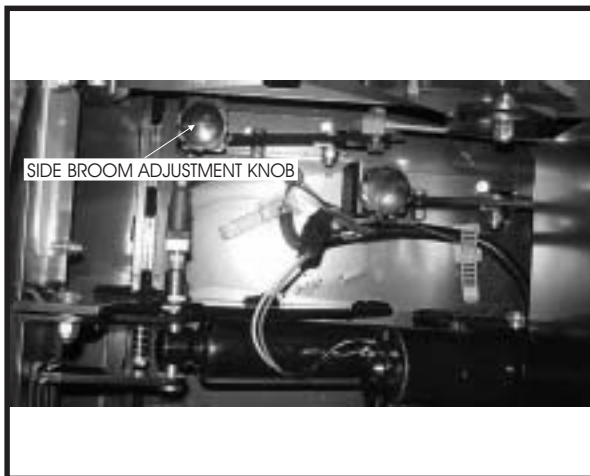

Fig. 90

### ADJUSTING THE SIDE BROOM HEIGHT

Turn the side broom adjustment knob (Fig. 90) to change the side broom sweep height. Recheck for proper sweep pattern after adjustment.

Turn the adjustment knob counterclockwise to INCREASE the sweep pattern width.

Turn the adjustment knob clockwise to DECREASE the sweep pattern width.



Fig. 91

### REPLACING THE SIDE BROOM

Change the side broom (Fig. 91) when the bristles become worn to less than 3 inches length.

1. Park the machine on a smooth level surface, turn key switch to "O" Position and engage parking brake.
2. Place the side brooms switch in the "UP" position.
3. Remove the lock pin that holds the broom flange to the motor shaft.
4. Disassemble the flange from the broom by removing the screws that hold the flange to the broom.
5. Assemble the flange to the replacement broom and fasten using the hardware removed.
6. Install the replacement broom on the shaft and insert the lock pin.





Fig. 92

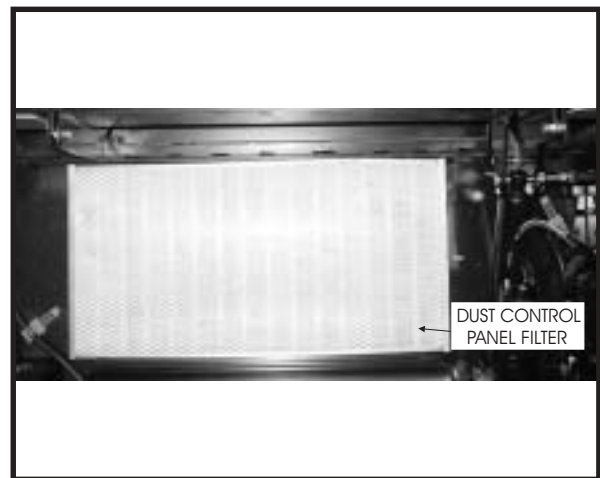

Fig. 93

**HOPPER**

The hopper (Fig. 92) houses the debris compartment, the dust control filter and the removable dust baffle. For maximum performance and service life, keep the hopper clean and inspect the seals and flaps daily. Clean the hopper prior to parking the sweeper at the end of the day. A clean hopper will make inspecting the flaps and seals much easier and will prevent premature deterioration of hopper components. Do not leave the hopper full of debris while in storage or when parked for extended periods of time. Once the hopper has been emptied the insides of the hopper should be rinsed out with water.

**DUST CONTROL FILTER**

The dust control filter (Fig. 93) should be checked daily for damage and cleaned if necessary. A damaged filter must be replaced to prevent damage to other dust control system components. Inspect the filter for tears in the filter media or excessive dirt lodged in the pleats. A tear in the filter media will allow dirt to pass through the filter and can be easily seen as a dirty patch on the top side of the filter. Cleaning of the filter is necessary when the filter shaker fails to adequately clean the pleats.

**CHECKING THE DUST CONTROL FILTER**

1. Park the machine on a smooth level surface, turn the key switch to the “O” position and engage the parking brake.
2. Raise the hopper lid for access to the filter compartment.
3. Turn the filter latch, lift the filter frame and remove the filter.
4. Inspect the panel filter for tears and clean or replace if necessary.
5. Reinstall the filter, lower the filter frame and engage the filter latch.
6. Close the hopper cover.

**CLEANING THE DUST CONTROL FILTER**

Clean the dust control filter when the shaker fails to adequately clear the filter. The filter can be cleaned with compressed air not to exceed 100 PSI. To clean the filter with compressed air, apply the compressed air to the top side of the panel to back flush the lodged dirt from the filter pleats. Be careful to not damage the filter media while cleaning. The filter can be cleaned with a solution of soap and water. If this cleaning method is used do not use the filter until it has completely dried.

**REPLACING THE DUST CONTROL FILTER WHEN DAMAGE IS EVIDENT**

1. Park the machine on a smooth level surface, turn the key switch to the “O” position and engage the parking brake.
2. Open the hopper compartment cover to gain access to the filter compartment.
3. Turn the latch on the hinged frame counterclockwise and lift the frame .
4. Remove the filter panel.
5. Install replacement filter, lower the hinged frame and engage the latch.
6. Lower the filter compartment cover.

## MAINTENANCE

### DUST FLAPS

The dust flaps are very important to sweeping and dust control and are susceptible to damage and should be inspected daily and maintained in good condition.

### CHECKING THE DUST FLAPS

The dust flaps are used on the wheel well, broom chamber and broom door. Inspect the flaps daily and replace any flap that shows signs of wear or deterioration. All flaps should be replaced when worn or damaged to the point that they can no longer perform their normal function. The adjustable flaps have slotted mounting holes to facilitate adjustment.

### ADJUSTING THE DUST FLAPS

Adjust the flaps so there is a 1/8" to 1/16" gap between the floor and the bottom edge of the flaps. The rear flap adjustment is 1/16" (16 cm.) above the floor.

1. Park the machine on a smooth level surface and engage the parking brake.
2. Loosen the flap retaining screws and adjust the flap to clear the floor and leave a 1/16" to 1/8" gap.
3. Tighten flap retaining screws while holding flap in position.
4. Drive the machine on a smooth surface and recheck the flaps for proper floor clearance.

### FILLING THE HYDRAULIC RESERVOIR (Fig. 94)

1. Access to the hydraulic reservoir is located in the engine compartment.
2. Open the hydraulic reservoir breather filter cap.
3. Remove any debris that is in the breather filter cap screen.
4. Fill the reservoir until the fluid is at the "FULL" line on the hydraulic fluid sight gauge. The sight gauge is located on the center side of the hydraulic reservoir.
5. Close the hydraulic reservoir breather filter cap.
6. Close the engine compartment cover.

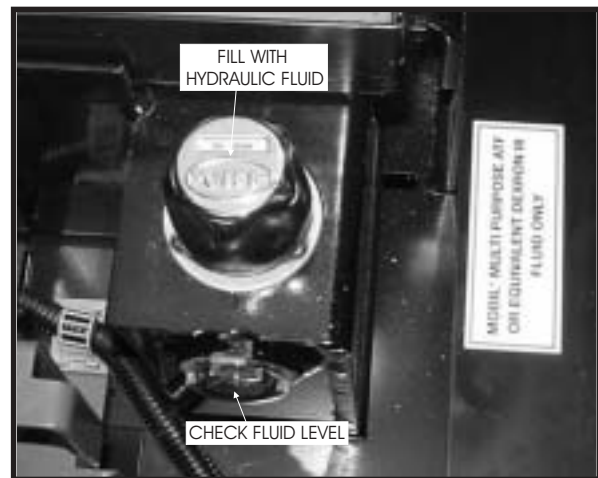

Fig. 94

### CLEANING THE HYDRAULIC SYSTEM

1. Put a drop cloth on the floor.
2. Drive the machine onto the drop cloth.
3. Set the parking brake.
4. Open the hood.
5. Put a container under the reservoir drain to catch the reservoir fluid. Pivot the reservoir out.
6. Remove the drain plug. The reservoir fluid will drain. Do not use the drained fluid to refill the hydraulic reservoir. Dispose of the used fluid.
7. Flush the interior of the hydraulic reservoir with clean fluid.
8. Put the reservoir plug, removed in step six, back in the hydraulic tank drain and tighten it. A pipe thread sealer is required on the plug.
9. Open the breather filter cap.
10. Fill the reservoir with new MOBIL Multipurpose ATF or equivalent Dextron III. The capacity of the tank is 4.7 gal (17.79 liters). Fill to the "FULL" line on the hydraulic fluid sight gauge.
11. Close the breather filter cap.
12. Replace the hood.

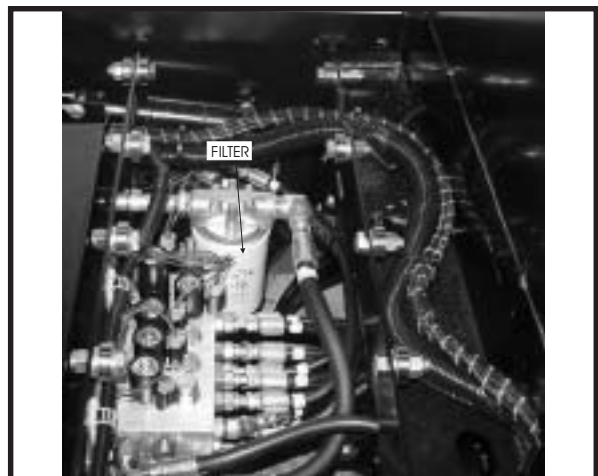

Fig. 95

### REPLACING THE RETURN FILTER ELEMENT (Fig. 95)

1. Replace the return filter element after 250 hours of machine run time.
2. Unscrew the fasteners from the filter assembly cover and retain.
3. Remove the cover and the compression spring and retain.
4. Discard the old filter element.
5. Position the new filter element inside the filter body.
6. Put the compression spring in position. Wipe the cover magnet free of any metal filings or debris.
7. Place O-ring (moisten with clean hydraulic fluid) and cover into position.
8. Reattach fasteners to the filter cover.
9. Clean any hydraulic reservoir fluid spills. The fluid can damage painted surfaces of the machine.

<b><u>PROBLEM</u></b>	<b><u>PROBABLE CAUSE</u></b>	<b><u>REMEDY</u></b>
Machine moves slowly or erratically	<ol style="list-style-type: none"> <li>1. Battery charge low</li> <li>2. Brakes dragging</li> <li>3. Loose connection at foot pedal</li> <li>4. Drive circuit overloaded</li> </ol>	<ol style="list-style-type: none"> <li>1. Change</li> <li>2. Adjust</li> <li>3. Repair</li> <li>4. Remove obstruction, put drive pedal in neutral</li> <li>5. Adjust</li> </ol>
Machine does not move	<ol style="list-style-type: none"> <li>1. Blown fuse</li> <li>2. Battery unplugged</li> </ol>	<ol style="list-style-type: none"> <li>1. Check fuse &amp; replace if necessary</li> <li>2. Plug in battery</li> </ol>
Poor water pickup at squeegee	<ol style="list-style-type: none"> <li>1. Recovery tank full</li> <li>2. Squeegee is worn or damaged</li> <li>3. Clogged suction hose or pick-up tool</li> <li>4. Loose connections between suction hose and squeegee</li> <li>5. Vacuum motors not running</li> <li>6. Plugged filter</li> <li>7. Vacuum float cage clogged</li> <li>8. Vacuum float shut off</li> <li>9. Air leaks in suction hose and connection</li> <li>10. Air leaks at recovery tank cover and/or manifold hose</li> <li>11. Drain hose or drain plug leakage or not closed properly</li> </ol>	<ol style="list-style-type: none"> <li>1. Empty tank</li> <li>2. Examine squeegee rubber blade for cuts or worn spots &amp; replace if necessary</li> <li>3. Disconnect suction hose from squeegee, flush squeegee &amp; hoses</li> <li>4. Check all hose connections for looseness or damage</li> <li>5. Reset circuit breaker or repair loose connection</li> <li>6. Clean filter element in vacuum manifold</li> <li>7. Clean perforated metal thoroughly</li> <li>8. Excessive solution in recovery tank. Excessive foam buildup, change cleaning chemical mixture (use A-L approved materials)</li> <li>9. Repair or replace hose and connection</li> <li>10. Repair or replace seal or hose</li> <li>11. Close, repair, or replace drain plug in recovery tank</li> </ol>
Water spills from squeegee	<ol style="list-style-type: none"> <li>1. Side squeegee blades have poor contact with floor</li> <li>2. Squeegee blades worn or damaged</li> <li>3. Too much solution being applied before making turns</li> <li>4. Brushes rotating opposite direction</li> </ol>	<ol style="list-style-type: none"> <li>1. Readjust blades for proper contact</li> <li>2. Replace &amp; adjust</li> <li>3. Shut off solution flow 5-10 ft. Before turning</li> <li>4. Check switch positions</li> </ol>
Squeegee leaves wet spots	<ol style="list-style-type: none"> <li>1. Lift actuator out of adjustment</li> <li>2. Squeegee wheels out of adjustment</li> </ol>	<ol style="list-style-type: none"> <li>1. Adjust</li> <li>2. Adjust</li> </ol>
Squeegee makes excessive noise	<ol style="list-style-type: none"> <li>1. Blades worn or damaged</li> </ol>	<ol style="list-style-type: none"> <li>1. Replace</li> </ol>

## TROUBLESHOOTING

<b><u>PROBLEM</u></b>	<b><u>PROBABLE CAUSE</u></b>	<b><u>REMEDY</u></b>
Poor scrubbing action	<ol style="list-style-type: none"> <li>1. Worn scrubbing brushes</li> <li>2. Incorrect method of operation</li> <li>3. Wrong cleaning agent or mixture</li> <li>4. Poor solution distribution</li> <li>5. Brushes won't turn</li> </ol>	<ol style="list-style-type: none"> <li>1. Inspect brushes. Replace if brushes are worn to 3/4" or less.</li> <li>2. Check scrubbing procedure, brush pressure, solution flow &amp; cleaning agent used - all are important to the process</li> <li>3. Use A-L recommended materials</li> <li>4. Check solution strainer &amp; feed hoses for obstructions - clean if necessary. Check valve &amp; rest of solution control system for proper operation.</li> <li>5. Check wiring connections</li> </ol>
Water splashes from sides of scrub deck	<ol style="list-style-type: none"> <li>1. Scrub deck bumpers, poor contact with floor</li> <li>2. Squeegee blades worn or damaged</li> <li>3. Too much solution</li> </ol>	<ol style="list-style-type: none"> <li>1. Readjust blades for proper contact</li> <li>2. Replace &amp; adjust</li> <li>3. Shut off solution flow 5-10 ft. before making turns</li> </ol>
Poor sweeping	<ol style="list-style-type: none"> <li>1. Broom jammed</li> <li>2. Hopper full</li> <li>3. Broom not adjusted properly</li> <li>4. Worn or damaged flaps</li> <li>5. Worn broom</li> </ol>	<ol style="list-style-type: none"> <li>1. Remove any obstruction</li> <li>2. Empty</li> <li>3. Refer to broom adjustment in maintenance section</li> <li>4. Inspect for damage - replace or adjust by referring to maintenance section</li> <li>5. Inspect for damage or wear - refer to maintenance section</li> </ol>
Sweep does not function	<ol style="list-style-type: none"> <li>1. Hopper is raised</li> <li>2. Hopper switch out of adjustment</li> </ol>	<ol style="list-style-type: none"> <li>1. Lower hopper</li> <li>2. Adjust hopper switch</li> </ol>
Poor dust control at main broom	<ol style="list-style-type: none"> <li>1. Broom chamber &amp; hopper flaps worn</li> <li>2. Impellor fan failure - shaft key broken or electric motor not operating</li> <li>3. Filter plugged</li> </ol>	<ol style="list-style-type: none"> <li>1. Check condition of flaps. Replace torn or badly worn flaps. Side flaps can be adjusted or not damaged.</li> <li>2. Check &amp; repair</li> <li>3. Engage shaker switch or check filter</li> </ol>
Hopper will not lift	<ol style="list-style-type: none"> <li>1. Load too heavy</li> <li>2. Defective lift actuator</li> </ol>	<ol style="list-style-type: none"> <li>1. Low dump partial load</li> <li>2. Repair or replace actuator</li> </ol>

## Free Manuals Download Website

<http://myh66.com>

<http://usermanuals.us>

<http://www.somanuals.com>

<http://www.4manuals.cc>

<http://www.manual-lib.com>

<http://www.404manual.com>

<http://www.luxmanual.com>

<http://aubethermostatmanual.com>

Golf course search by state

<http://golfingnear.com>

Email search by domain

<http://emailbydomain.com>

Auto manuals search

<http://auto.somanuals.com>

TV manuals search

<http://tv.somanuals.com>