

# SNOW CONE CART™

Model # SCC-200

---

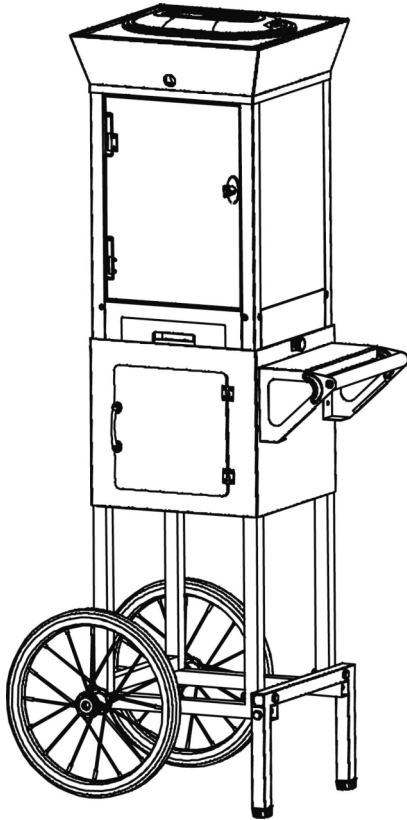

---

**For Household Use Only!**

**Read These Instructions Before Using  
This Unit!**

***SAVE THESE INSTRUCTIONS!***

## IMPORTANT PRECAUTIONS

---

### *Appliance Specifications:*

120 Volts  
60 HZ  
100 Watts  
ETL Approved

### *Important Precautions to Remember:*

- A. NEVER immerse in water.
- B. NEVER use near water.
- C. NEVER use an abrasive sponge or cloth.
- D. NEVER use a scouring pad on the unit.
- E. NEVER leave unit unattended while in use.
- F. NEVER try to force the cover in the locking mechanism.
- G. Unplug unit from outlet when not in use and when cleaning.
- H. DO NOT operate this appliance with a damaged cord or plug or in the event the appliance ever malfunctions.
- I. Keep out of reach of children.
- J. This appliance is NOT A TOY.
- K. This appliance is not intended for use by young children or infirm persons without supervision.
- L. Young children should be supervised to ensure that they do not play with the appliance.

## IMPORTANT SAFEGUARDS

---

When using electrical appliances, basic safety precautions should always be followed, including the following:

1. Read all instructions before operating this appliance.
2. DO NOT TOUCH hot surfaces. Keep hands away from blade mechanism. Use handles or knobs.
3. To protect against electrical shock, do not immerse cord, plug or any part of this unit in water or other liquids.
4. Close supervision is necessary when any appliance is used by or near children.
5. Unplug from outlet when not in use and before removing parts and before cleaning.
6. DO NOT operate any appliance with a damaged cord or plug or if the appliance has been damaged in any manner. Return the appliance to the nearest repair shop for examination or repair or send back to company as stated in this booklet in the warranty.
7. The appliance manufacturer does not recommend the use of accessory attachments. This may cause injuries.

## IMPORTANT SAFEGUARDS (Continued)

---

8. DO NOT use outdoors.
9. DO NOT let the cord hang over the edge of table or counter tops, or touch hot surfaces.
10. DO NOT place on or near a hot gas or electric burner, or in a heated oven.
11. Extreme caution must be used when moving this appliance.
12. DO NOT use the appliance for other than its intended use.
13. A unit that is plugged into an outlet should not be left unattended.
14. Check ice hopper for presence of foreign objects prior to use.
15. Blades are extremely sharp. **Use with extreme caution.**
16. DO NOT place on or near a hot gas or electric burner, or in a heated oven.
17. Longer detachable power supply cords can be used if care is exercised in their use.
18. The marked electrical rating of an extension cord should be at least as great as the electrical rating of the appliance.
19. This appliance has a polarized plug (one blade is wider than the other). To reduce the risk of electrical shock, this plug is intended to fit into a polarized outlet only one way.

# SAVE THESE INSTRUCTIONS!

## INTRODUCTION

---

Thank you for purchasing the one-of-a-kind SNOW CONE CART™. This vintage looking appliance beautifully resembles the carnival style vendors of the early 1900s. Though it may be designed to look like a nostalgic cart of the past, The SNOW CONE CART™ is in fact a technologically modern snow cone maker, and should be treated as such.

The SNOW CONE CART™ uses ice cubes from your freezer or icemaker to create:

- **Snow Cones**
- **Slushies**
- **Smoothies**
- **Low Fat Snacks**

The SNOW CONE CART™ is designed for indoor use and can be used in a number of locations such as:

- **Family Rooms**
- **Dorm Rooms**
- **Offices**
- **Club Houses**

Now you can enjoy icy, cool snow cones to snack on when.....

- **Watching TV or a Movie at Home**
- **Throwing a Party**
- **Listening to Music**
- **Craving a Low fat Treat**

# ASSEMBLY

## After Taking the Unit Out of the Box:

Your SNOW CONE CART™ requires some assembly before first use. The Main Unit, which includes the ice grinder, is already assembled. You will need to put together the cart itself using the instructions that follow. Before first use, make sure to wipe clean the inside of the Main Unit with a non-abrasive moist sponge, a non-abrasive towel, or a damp cloth followed by a non-abrasive dry towel.

## BREAKDOWN





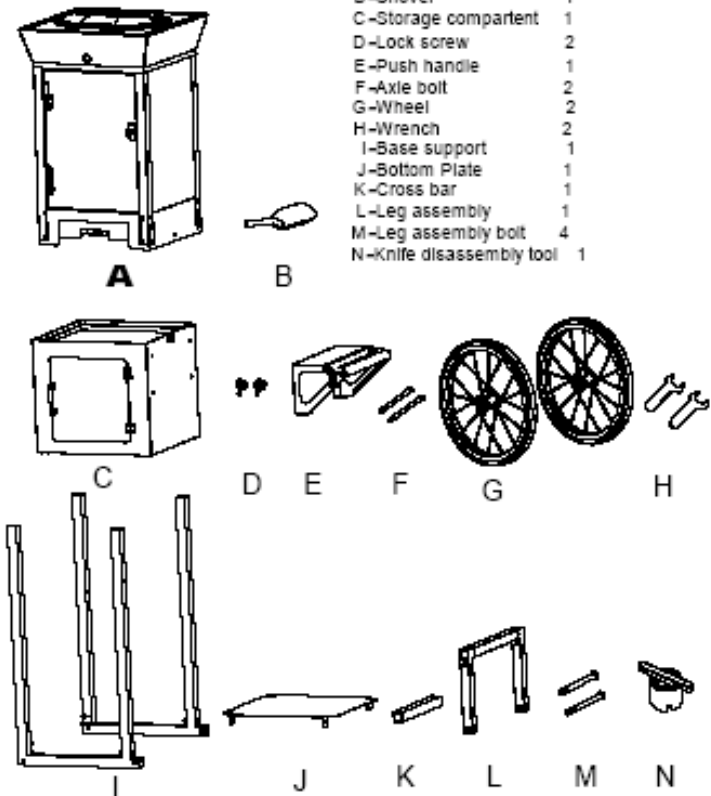

### Parts

<b>A</b> -Main unit	1
B-Shovel	1
C-Storage compartment	1
D-Lock screw	2
E-Push handle	1
F-Axle bolt	2
G-Wheel	2
H-Wrench	2
I-Base support	1
J-Bottom Plate	1
K-Cross bar	1
L-Leg assembly	1
M-Leg assembly bolt	4
N-Knife disassembly tool	1

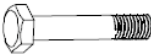
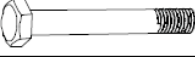

# ASSEMBLY (Continued)

## Screws, Studs, and Nuts

1	M6X8 Screw qty 10	
2	M6X25 Screw qty 4	
3	M8X60 Stud qty 4	
4	M8X93 Wheel Rod qty 2	
5	Lock Washer qty 2	
6	Flat Washer qty 4	
7	M8 Wheel Rod Cap qty 2	
8	M8 Nut Cap qty 4	

## ASSEMBLY

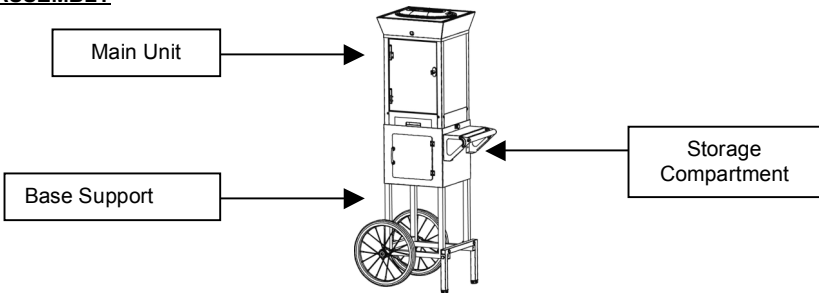

1. Open the box and remove all parts including the Main Unit, Storage Compartment, Wheels, Legs, and all other contents (including the Push Handle and accessories).
2. Attach the Push Handle to the Storage Compartment using four of the #1 screws (as shown below):

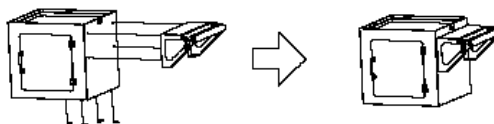

## ASSEMBLY (Continued)

---

3. Connect the Base Supports by screwing two of the #1 screws into the Cross Bar (as shown below):

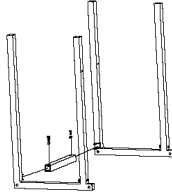

4. Connect the Leg Assembly by screwing four of the #3 studs from the Base Support into the Leg Assembly (as shown below). Make sure to screw from the Base Support into the Leg Assembly and not vice versa. Once the studs are firmly screwed through, place the four #8 Nut Caps over the studs for cosmetic purposes:

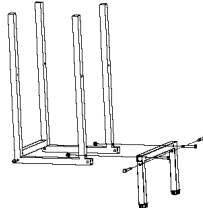

5. Now that the Leg Assembly and Base Support have been connected, use four of the #2 screws to connect the Storage Compartment to the Base Support (as shown below). Once you have successfully screwed the #2 screws through the Storage Cabinet and into the Base Support, place the Bottom Plate underneath the Storage Cabinet and attach it to the Base Support using four of the #1 screws:

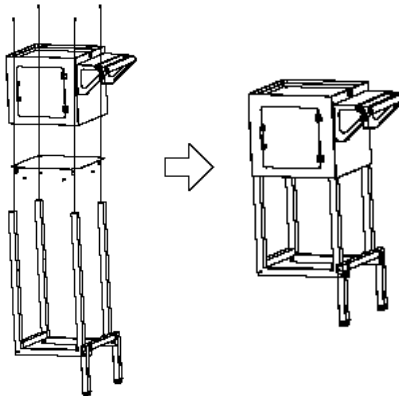

## ASSEMBLY (Continued)

6. Attach the Wheels to the Base Support by using two of the #4 Wheel Rods. Slide a #5 Lock Washer onto a Wheel Rod, and then push the Wheel Rod through the holes in the Base Support. Make sure to place the two #6 Flat Washers between the Base Support and the Wheels. Repeat on the other wheel. Finally, place the two #7 Wheel Rod Caps on the outside of the screws for cosmetic purposes (as shown below):

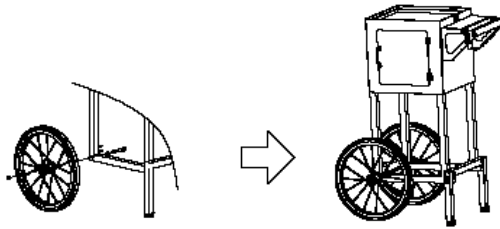

7. Place the Main Unit onto the Storage Compartment so that the two side holes match up. Connect the Main Unit to the Storage Compartment using the two included Lock Screws (D) as shown below:

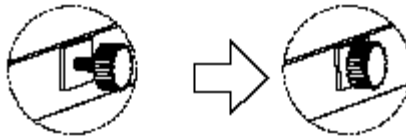

8. Place the Clear Plastic Bowl into the top of the Main Unit and firmly secure the lid into the bowl. Make sure that the end of the lid with the two tabs is properly placed into the corresponding holes and the lid snap shuts. Please note that the ice will not shave unless the lid is properly secured. Never force it down.

You are now ready to use your SNOW CONE CART™!

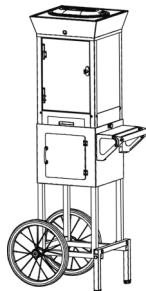

Helpful Hint: Use the black plastic adjusters on the bottom of the feet to properly level.

## USING YOUR SNOW CONE CART™

---

### USING YOUR SNOW CONE CART™

First, find a stable surface near an electrical outlet before starting. (Make sure your cord is away from any water source. If needed, it is acceptable to use an extension cord.)

1. Before plugging in your unit, add ice cubes by removing the clear lid from the Main Unit of your SNOW CONE CART™. In order to do so, simply push the release button on the lid, lift and remove. Once you have done this, plug in the unit.

**For Optimal Ice Shaving Results** – Your ice cubes should sit a short while before putting them in the shaving unit. If your ice has a frosty look, it is much too hard to shave. If your ice sits long enough to look clear and it is wet to the touch, then it is ready to make your SNOW CONE CART™ experience a fun one.

2. When ice cubes are ready, place cubes in the shaving unit while allowing enough room for the lid to be placed back on the unit easily. Never force it shut.
3. Return the clear lid to the unit and turn the power button to the ON position. This will activate the unit to begin shaving. Please note that the ice will not shave unless the lid is properly secured.
4. Repeat steps 2 and 3 until you have shaved the amount of ice desired. Make sure to unplug when you are finished.
5. Once you have the desired amount of ice, open the housing door on the Main Unit to retrieve your ice and use the recipes on the next page to create your favorite snow based treats!

## REPLACING THE BLADE

---

Should the ability of your SNOW CONE CART™ to properly shave ice diminish after a lengthy period of normal use, replace it with the included Replacement Blade and Tool. Should you need additional blades, you can order directly from the manufacturer.

Please note the following steps for replacing the blade:

1. Remove the Ice Tray and insert the Disassembly Tool (N under PARTS) over the three arms of the Ice Hopper.

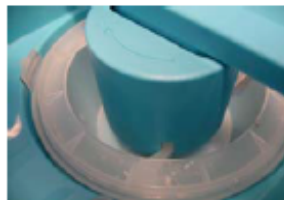



## REPLACING THE BLADE (Continued)

---

When following the next three steps, use **EXTREME CAUTION** as the blade is very sharp! Once the Ice Tray is removed, you are fully exposed to the blade inside!

2. Once the Disassembly Tool is properly inserted, twist counter-clockwise (as the arrow shows) and lift the Ice Hopper out.

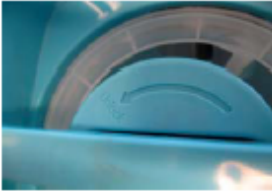

**BLADE IS NOW COMPLETELY EXPOSED – USE CAUTION**

3. Locate the two plastic clips on the Blade Assembly and use a spoon and your thumb to press the clips inward and lift out the Blade Assembly.



4. Twist off the Blade Retainer Nut, and using extreme caution, remove the Blade Cartridge from the Assembly. Insert the replacement Blade Cartridge, and reverse the above steps to reassemble.



5. After reversing all steps, make sure to lock with the tool.



## CLEANING

---

1. Make sure the unit is unplugged before cleaning.
2. Open the housing door to clean and dry inside of unit using a slightly damp, non-abrasive sponger or non-abrasive towel.
3. Also use a slightly damp, non-abrasive sponge or non-abrasive towel to wipe clean outside of unit, then wipe with a non-abrasive dry towel to dry.
4. The shaving unit and clear lid are dishwasher safe. To take out the shaving unit, simply turn the white top in a counter-clockwise direction and it will unscrew, unlocking the top.

**IMPORTANT:** The blade is very sharp. Use **EXTREME CAUTION** when handling.

## RECIPES

---

Your SINOW CONE CART™ makes light and fluffy mounds of ice that can be used to make:

**SNOW CONES** – Add your favorite syrup flavor. Add more than one flavor to increase the fun and vary the flavor by creating *Rainbow Snow Cones*.

**SLUSH DRINKS** – By filling a glass with freshly shaved ice and adding your favorite soft drink or flavored tea or fruit juices.

**FRUITY SLUSH** – By filling a serving cup with freshly shaved ice, adding flavored syrup and topping with chopped fruit of your choice.

**YOGURT SNOW** – By pre-freezing your favorite flavored yogurt in ice cube trays, you can use your SINGLE CONE VINTAGE SNOW CONE MAKER™ to shave the yogurt cubes and make a refreshing, healthy treat. Add flavored syrup for even more flavor.

**SNOW SMOOTHIES** – By freezing ½ cup of milk in ice cube trays, you can use your SINGLE CONE VINTAGE SNOW CONE MAKER™ to shave the cubes. Place the shaved cubes and fresh strawberries or your choice of fruit in a blender. Add 1/4 cup of sugar for sweetness, then blend until smooth to your desired consistency.

**JUICY TREATS** – By freezing your favorite juice in ice cube trays, you can use your SINGLE CONE VINTAGE SNOW CONE MAKER™ to shave the cubes to create a healthy, juicy treat.

*Use your imagination with different fruits, syrups, sodas, teas and juices to create any number of refreshing, icy, healthy, low fat treats, drinks, and desserts that will delight kids of any age*

## RETURNS & WARRANTY

---

SHOULD YOUR UNIT NOT WORK OR IS DAMAGED WHEN YOU FIRST TAKE IT OUT OF THE BOX, PLEASE RETURN IT TO THE PLACE OF PURCHASE IMMEDIATELY.

Should you have any questions, please contact us via email or at the customer service number listed below between the hours of 8:00 AM and 5:00 PM, Monday through Friday, Central Standard Time.

Distributed by:

Nostalgia Products Group LLC  
1471 Partnership Dr.  
Green Bay, WI 54304-5685

### **Customer Service**

Phone: (920) 347-9122  
Web: [www.nostalgiaelectrics.com](http://www.nostalgiaelectrics.com)

### **Customer Service Inquiry**

To submit a Customer Service inquiry, go to [www.nostalgiaelectrics.com](http://www.nostalgiaelectrics.com) and fill out the **Customer Service Inquiry** form and click the Submit button. A representative will contact you as soon as possible.

## SNOW CONE CART™

SCC-200

Limited Warranty

This appliance is designed and built to provide many years of satisfactory performance under normal household use. The distributor pledges to the original owner that should there be any defects in material or workmanship during the first 90 days of purchase, we will repair or replace the unit at our option. Our pledge does not apply to damages caused by shipping, mishandling or unit being dropped. A product deemed defective either from manufacturing or being mishandled is up to the distributor's discretion. To obtain service under this warranty, return this unit to Nostalgia Products Group, LLC at the address above, shipping prepaid. You must also include a copy of the original receipt along with your name, address and phone number. Include a description of the defect along with the date you purchased the product.

This warranty does not apply to re-manufactured merchandise.

Please read these instructions carefully. Failure to comply with these instructions, damages caused by improper replacement parts, abuse or misuse will void this pledge to you and is being made in place of all other expressed warranties.



Nostalgia Products Group LLC  
1471 Partnership Dr.  
Green Bay, WI 54304-5685

Visit Us Online at  
**[www.nostalgielectrics.com](http://www.nostalgielectrics.com)**

©2009 Nostalgia Products Group LLC

## Free Manuals Download Website

<http://myh66.com>

<http://usermanuals.us>

<http://www.somanuals.com>

<http://www.4manuals.cc>

<http://www.manual-lib.com>

<http://www.404manual.com>

<http://www.luxmanual.com>

<http://aubethermostatmanual.com>

Golf course search by state

<http://golfingnear.com>

Email search by domain

<http://emailbydomain.com>

Auto manuals search

<http://auto.somanuals.com>

TV manuals search

<http://tv.somanuals.com>