

Poulan PRO[®]

ENGLISH



Please do not return product to retailer.
Por favor, no devuelva el producto al lugar de compra.
Veuillez ne pas retourner le produit au détaillant.
1-800-554-6723

Register your product online at:
Registre su producto en línea en:
Enregistrez votre produit en ligne à l'adresse :
www.poulanpro.com

Instruction Manual Manual de Instrucciones Manuel d'Instructions

PP2000T

ESPAÑOL



WARNING:

Read and follow all Safety Rules and Operating Instructions before using this product. Failure to do so can result in serious injury. Refer to your original manual for additional Warnings and Operating Instructions.

ADVERTENCIA:

Lea el manual de instrucciones y siga todas las advertencias e instrucciones de seguridad. El no hacerlo puede resultar en lesiones graves. Refiera a su manual original para las Instrucciones de Funcionamiento y las Advertencias adicionales.

AVERTISSEMENT:

Lire le manuel d'instructions et bien respecter tous les avertissements et toutes les instructions de sécurité. Tout défaut de le faire pourrait entraîner des blessures graves. Référez-vous à votre manuel original pour des Avertissements et des Instructions d'Utilisation additionnels.

Poulan PRO
7349 Statesville Road
Charlotte, NC 28269

FRANÇAIS

545212826 Rev. 3 6/15/10 BRW

IDENTIFICATION OF SAFETY SYMBOLS



⚠ DANGER: RISK OF CUT. KEEP HANDS AND FEET AWAY FROM TINES AND CUTTING AREA. Rotating tines can cause serious injury. Do not attempt to clear away cut material or hold material to be cut when the engine/motor is running. Make sure powerhead is stopped and spark plug wire is disconnected (or powerhead is disconnected from power source) when removing jammed material from the tines. Do not grab or hold attachment by the tines.



⚠ WARNING: This unit can be dangerous! Careless or improper use can cause serious injury.



Read the operator's manual before use. Failure to follow instructions could result in serious injury. Save operator's manual.

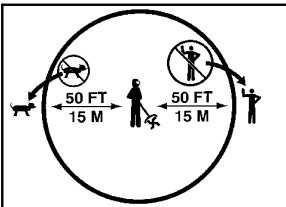

Hazard zone for thrown objects. Keep children, bystanders, and animals away from work area a minimum of 50 feet (15 meters) when starting or operating unit. Stop unit immediately if approached.



The cultivator can throw objects violently. You can be blinded or injured. Always wear hearing protection and safety glasses marked Z87. Always wear heavy, long pants, long sleeves, boots and gloves.

SAFETY RULES

⚠ WARNING: When using gardening appliances, basic safety precautions must always be followed to reduce the risk of fire and serious injury. Read and follow all instructions. Failure to do so can result in serious injury.

This power unit can be dangerous! This unit can cause serious injury including amputation or blindness to the operator and others. Operator is responsible for following instructions and warnings on unit and in manual. Read entire instruction manual before using unit! Be thoroughly familiar with the controls and the proper use of the unit. Restrict the use of this unit to persons who have read, understand and will follow the instructions and warnings on the unit and in the manual. Never allow children to operate this unit.



INSTRUCTION
MANUAL



SAFETY INFORMATION
ON THE UNIT

OPERATOR SAFETY

- Dress properly. Always wear safety glasses or similar eye protection when operating, or performing maintenance on your unit (safety glasses are available). Eye protection should be marked Z87.
- Always wear face or dust mask if operation is dusty.
- Always wear heavy, long pants, long sleeves, boots, and gloves.
- Always wear foot protection. Do not go barefoot or wear sandals.

- Secure hair above shoulder length. Secure or remove loose clothing or clothing with loosely hanging ties, straps, tassels, etc. They can be caught in moving parts.
- Being fully covered also helps protect you from debris and pieces of toxic plants thrown by spinning tines.
- Stay alert. Do not operate when you are tired, ill, upset, or under the influence of alcohol, drugs, or medication. Watch what you are doing; use common sense.
- Wear hearing protection.
- Never start or run inside a closed room or building. Breathing exhaust fumes can kill.
- Keep handles free of oil and fuel.
- Never operate the cultivator without the tine guard in place and properly secured.

FUEL SAFETY (for gas powerheads)

- Mix and pour fuel outdoors.
- Keep away from sparks or flames.
- Use a container approved for fuel.
- Do not smoke or allow smoking near fuel or the powerhead.
- Avoid spilling fuel or oil. Wipe up all fuel spills before starting the powerhead.
- Move at least 10 feet (3 meters) away from fueling site before starting powerhead engine.
- Stop engine and allow to cool before removing fuel cap.
- Remove fuel cap slowly.
- Store unit and fuel in an area where fuel vapors cannot reach sparks or open flames from water heaters, electric motors or switches, furnaces, etc.

ELECTRICAL SAFETY (for electric powerheads)

- ⚠ WARNING:** Avoid a dangerous environment. To reduce the risk of electrical shock, do not use in rain, in damp or wet locations, or around swimming pools, hot tubs, etc. Do not expose to snow, rain, or water to avoid the possibility of electrical shock. Do not use on wet surfaces. Do not handle extension cord plug or unit with wet hands.
- Use only a voltage supply as shown on the nameplate of the unit.
 - Avoid dangerous situations. Do not use in presence of flammable liquids or gases to avoid creating a fire or explosion and/or causing damage to unit.
 - Avoid dangerous environments. Do not use in unventilated areas or where dust or explosive vapors can build up.
 - To reduce the risk of electric shock, the powerhead may have a polarized plug (one blade is wider than the other); if so, it will require the use of a polarized extension cord. The appliance plug will fit into a polarized extension cord only one way. If the plug does not fit fully into the extension cord, reverse the plug. If the plug still does not fit, obtain a correct polarized extension cord. A polarized extension cord will require the use of a polarized wall outlet. This plug will fit into the polarized wall outlet only one way. If plug does not fit fully into the wall outlet, reverse the plug. If it still does not fit, contact a qualified electrician to

install the proper wall outlet. Do not change the equipment plug, extension cord receptacle, or extension cord plug in any way.

- To reduce risk of electrical shock, use extension cords specifically marked as suitable for outdoor appliances having electrical rating not less than the rating of unit. Cord must be marked with suffix "W-A" (in Canada "W"). Make sure your extension cord is in good condition. Inspect extension cord before use and replace if damaged. Do not use a damaged cord. Cord insulation must be intact with no cracks or deterioration. Plug connectors must be undamaged. The extension cord used to reach the power source must be heavy enough to carry current from the power source the full length of the extension cord to the unit. An undersized extension cord will cause a drop in line voltage resulting in loss of power and overheating. If in doubt, use the next heavier gauge. The lower the gauge number, the heavier the cord.
- Do not use multiple cords.
- Do not abuse cord. Never carry the unit by the extension cord or yank extension cord to disconnect unit. To unplug, grasp the plug, not the cord. Do not use cord as a handle, close a door on cord, or pull cord around sharp edges or corners. Do not expose cords to heat, oil, or water.
- Keep the extension cord clear of operator and obstacles at all times.
- Tie cord to cord retainer and connect to recessed plug as shown in this manual to prevent damage to unit and/or extension cord and to reduce the possibility of the extension cord disconnecting from the unit during operation.
- Do not attempt to repair unit. Inspect the insulation and connectors on the powerhead and extension cord before each use. If there is any damage, do not use until damage is repaired by your authorized service dealer.
- Do not use the powerhead if the switch does not turn the unit on and off properly. Have the unit repaired by your authorized service dealer.
- Do not use with damaged cord or plug. If powerhead is not working as it should, has been dropped, damaged, left outdoors, or dropped into water, return it to your authorized service dealer for repair.
- Avoid unintentional starting of the unit. Never carry unit with your finger on the switch. Be sure the switch is in the OFF position and never touch the switch when connecting extension cord.
- Unplug the unit from the power source when not in use, before servicing, and when changing accessories and/or attachments.
- Avoid any body contact with any grounded conductor, such as metal fences, or pipes, to avoid the possibility of electric shock.
- Ground Fault Circuit Interrupter (GFCI) protection should be provided on the circuit or outlet to be used for the powerhead. Receptacles are available having built-in GFCI protection and may be used for this measure of safety.

UNIT/MAINTENANCE SAFETY

⚠ WARNING: Disconnect powerhead spark plug (or disconnect powerhead from power source) before performing maintenance.

- Inspect entire unit before each use. Replace damaged parts. Check for fuel leaks. Make sure all fasteners are in place and securely fastened.
- Maintain unit according to recommended procedures.
- Have all maintenance and service not explained in this manual performed by an authorized service center.
- Throw away tines that are bent, warped, cracked, broken, or damaged in any other way. Replace parts that are cracked, chipped, or damaged before using the unit.
- Use only recommended Poulan PRO parts and accessories. Never use wire, wire rope, string, flailing devices, etc.
- Be sure tines stop turning when engine idles (see CARBURETOR ADJUSTMENTS section of powerhead manual).
- Remove the tines before making carburetor adjustments. Hold the unit by hand.
- Keep others away when making carburetor adjustments.
- Never start the unit with the clutch housing removed. The clutch can fly off and cause serious injury.
- Avoid heavy contact with solid objects that might stop the tines. If heavy contact occurs, stop the unit and inspect for damage.
- If tines strike a foreign object, follow these steps: stop unit and disconnect spark plug wire (or disconnect from power source), inspect for damage, and repair any damage before resuming operation of the unit.
- Never douse or squirt the attachment with water or any other liquid. Clean unit and decals with a damp sponge (see STORAGE).

CULTIVATING SAFETY

⚠ WARNING: Inspect the area to be cultivated before each use. Remove objects (rocks, vines, branches, broken glass, nails, wire, string, etc.) which can be thrown by the tines or can wrap around the shaft.

- Hold the unit firmly with both hands.
- Keep firm footing and balance. Do not over-reach or stand on unstable surfaces.
- Look behind and use care when backing up.
- Keep all parts of your body away from the tines and muffler.
- Do not force the unit. Use only for jobs explained in this manual. Use only for cultivating. Do not abuse unit. Do not use in rain or wet locations.
- Use only in daylight or good artificial light.

TRANSPORTING AND STORAGE

- Stop powerhead before leaving work area.
- Allow powerhead and gearbox to cool before storing or transporting it in a vehicle.
- Store unit and fuel in area where fuel vapors cannot reach sparks or open flames from water heaters, electric motors or switches, furnaces, etc.
- Store attachment so tines cannot accidentally cause injury.
- Store attachment indoors, out of reach of children.

If situations occur which are not covered in this manual, use care and good judgment. If you need assistance, call 1-800-554-6723.

SPECIAL NOTICE: Exposure to vibrations through prolonged use of gasoline powered hand tools could cause blood vessel or nerve damage in the fingers, hands, and joints of people prone to circulation disorders or abnormal swellings. Prolonged use in cold weather has been linked to blood vessel damage in otherwise healthy people. If symptoms occur such as numbness, pain, loss of strength, change in skin color or texture, or loss of feeling in the fingers, hands, or joints, discontinue the use of this tool and seek medical attention. An anti-vibration system does not guarantee the avoidance of these problems. Users who operate power tools on a continual and regular basis must monitor closely their physical condition and the condition of this unit.

SAVE THESE INSTRUCTIONS

OPERATION

KNOW YOUR CULTIVATOR ATTACHMENT

READ THIS INSTRUCTION MANUAL AND SAFETY RULES BEFORE OPERATING YOUR CULTIVATOR ATTACHMENT. Compare the illustrations with your attachment to familiarize yourself with the location of the various controls and adjustments. Save this manual for future reference.

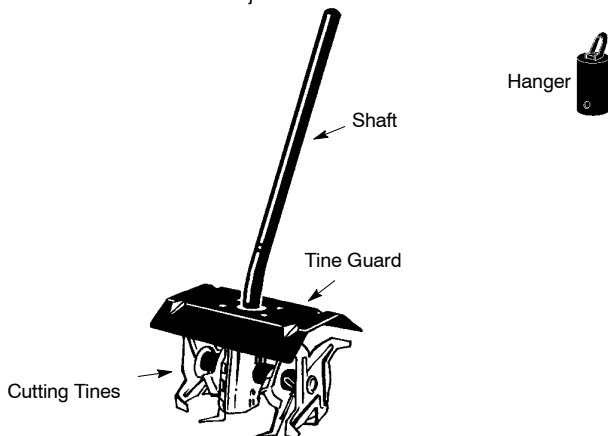

CUTTING TINES

The CUTTING TINES are designed to loosen soil.

NOTE: The cutting tines can not be turned by hand due to the gear ratio.

TINE GUARD

The TINE GUARD provides partial protection from the rotating tines.

OPERATING THE COUPLER

Your powerhead is equipped with a coupler which enables optional attachments to be installed. The optional attachments are:

	MODEL:
Edger	PPB1000E
Blower	PPB3000B
Pruner	PPB5000P
Pruner	PPB5500P
Brushcutter*	PPB4000C

*not designed for use with electric powerheads

WARNING: Always disconnect powerhead spark plug (or disconnect powerhead from power source) before removing or installing attachments.

REMOVING ATTACHMENT

CAUTION: When removing or installing attachments, place the powerhead and attachment on a flat surface for stability.

1. Loosen the coupler by turning the knob counterclockwise.

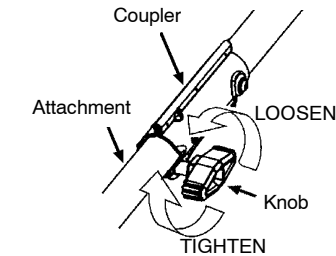

2. Press and hold the locking/release button.

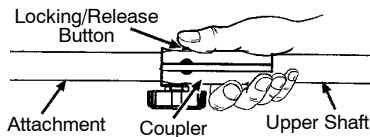

3. While securely holding the upper shaft, pull the attachment straight out of the coupler.

INSTALLING ATTACHMENT

1. Remove the shaft cap from the attachment (if present) and discard.
2. Position locking/release button of attachment into guide recess of upper shaft coupler.
3. Push the attachment into the coupler until the locking/release button snaps into the primary hole.
4. Before using the unit, tighten the knob securely by turning clockwise.

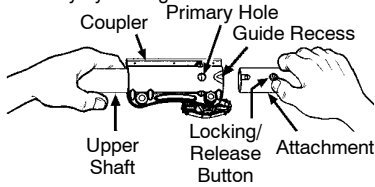

WARNING: Make sure the locking/release button is locked in the primary hole and the knob is securely tightened before operating the unit. Using the wrong hole could lead to serious injury or damage to the unit.

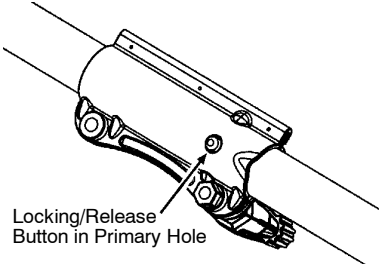

INSTALLING ATTACHMENT HANGER

An attachment hanger is provided for storage when attachment is not in use.

To install hanger on attachment:

1. Remove the shaft cap from the attachment (if present) and discard.
2. Press and hold the locking/release button.
3. Push hanger onto the attachment until the locking/release button snaps into the hole.

OPERATING POSITION

ALWAYS WEAR:



WARNING: To avoid personal injury, never carry the cultivator while the unit is running.

WARNING: The gearbox gets very hot after extended periods of use. To avoid burns, do not touch the gearbox until it has been allowed to cool.

CULTIVATING

1. Move the cultivator to the work area prior to starting the engine/motor.
2. With the engine/motor running and the tines off the ground, press the throttle trigger to increase the engine speed.
3. Hold trigger handle and assist handle firmly. Slowly lower the cultivator until the tines make contact with the ground.



4. As unit begins cultivating, pull back on the unit so that the tines can penetrate the ground.

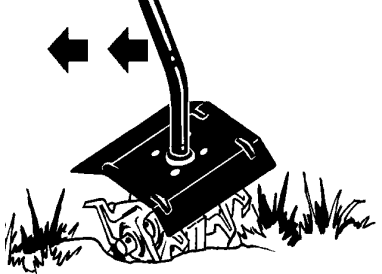

5. Once the ground has been broken, continue at a moderate pace until you are familiar with the controls and the handling of the cultivator.
6. Pull the cultivator backwards to improve the depth of cultivation and reduce your effort.
7. To cultivate in confined areas or narrow rows, remove the left and right outer tines (see TINE REPLACEMENT).

MAINTENANCE

⚠ WARNING: Always stop unit and disconnect spark plug wire (or disconnect powerhead from power source) before performing maintenance.

CHECK FOR DAMAGED OR WORN PARTS

Contact an authorized service center for replacement of damaged or worn parts.

- Tine Guard – Discontinue use of cultivator if tine guard is damaged.

CHECK FOR LOOSE FASTENERS AND PARTS

- Clevis pins
- Hitch pin clips

INSPECT AND CLEAN UNIT AND DECALS

- After each use, inspect complete unit for loose or damaged parts. Clean the unit and decals using a damp cloth with a mild detergent.
- Wipe off unit with a clean dry cloth.

TINE MAINTENANCE

⚠ WARNING: The tines will continue to spin after the engine stops or after the throttle trigger has been released. To avoid serious injury, make sure the tines have stopped coasting and disconnect the spark plug (or disconnect powerhead from power source) before performing work on the tines.

⚠ WARNING: Always replace tines that are bent, warped, cracked, broken, or damaged in any other way. Never attempt to straighten and reuse a damaged tine. Use only specified replacement tines. Wear protective gloves when handling or performing maintenance on the tines to help avoid injury.

SERVICE AND ADJUSTMENTS

TINE REPLACEMENT

⚠ WARNING: The tines will continue to spin after the engine stops or after the throttle trigger has been released. To avoid serious injury, make sure the tines have stopped coasting and disconnect the spark plug (or disconnect powerhead from power source) before performing work on the tines.

⚠ WARNING: Wear protective gloves when handling or performing maintenance on the tines to avoid injury. The tines become very sharp from use.

1. Remove the hitch pin clips and clevis pins.

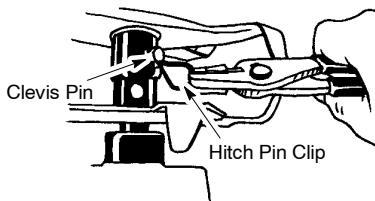

2. Remove the tines and felt cushions from the shaft.
3. Clean and oil the shaft.
4. Replace the tines and the felt cushions.

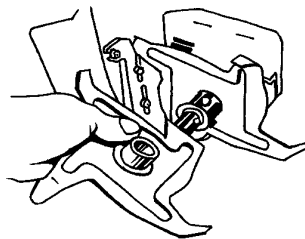

5. Repeat previous steps on opposite side.
6. Reinstall clevis pins and hitch pin clips.

NOTE: When installed correctly, the hubs on the tines will face each other. The letters "R" stamped on the tines will be on the right side of the cultivator and the letters "L" will be on the left side.

STORAGE

⚠ WARNING: Perform the following steps after each use:

- Allow attachment and gearbox to cool before storing or transporting.
- Position attachment so that any sharp object cannot accidentally cause injury.
- Store the attachment in a dry, well ventilated area out of the reach of children.

SEASONAL STORAGE

Prepare attachment for storage at end of season or if it will not be used for 30 days or more. If your cultivator attachment is to be stored for a period of time:

- Clean the entire attachment.
- Inspect the tine guard area and clean any dirt or debris that has collected. Inspect the tines; replace tines that are bent, warped, cracked, broken or damaged in any other way.
- Lightly oil external metal surfaces.
- Check entire attachment for loose screws or nuts. Replace any damaged, worn or broken parts.
- At the beginning of the next season, use only fresh fuel having the proper gasoline to oil ratio.

LIMITED WARRANTY

Poulan PRO, a division of Husqvarna Consumer Outdoor Products N.A., Inc., warrants to the original consumer purchaser that each new **Poulan PRO** brand gasoline tool or attachment is free from defects in material and workmanship and agrees to repair or replace under this warranty any defective gasoline product or attachment as follows from the original date of purchase.

2 YEARS - Parts and Labor, when used for household purposes.

90 DAYS - Parts and Labor, when used for commercial, professional, or income producing purposes.

30 DAYS - Parts and Labor, if used for rental purposes.

This warranty is not transferable and does not cover damage or liability caused by improper handling, improper maintenance or alteration, or the use of accessories and/or attachments not specifically recommended by **Poulan PRO** for this tool. This warranty does not cover parts that will wear and require replacement with reasonable use during the warranty period. This warranty does not cover pre-delivery setup or normal adjustments explained in the instruction manual. This warranty does not cover transportation costs.

In the event you have a claim under this warranty, you must return the product to an authorized service dealer.

Should you have any unanswered questions concerning this warranty, please contact:

Poulan PRO, a division of Husqvarna
Consumer Outdoor Products N.A., Inc.
7349 Statesville Road
Charlotte, NC 28269
1-800-554-6723

In Canada, contact:

Poulan PRO

850 Matheson Blvd. West
Mississauga, Ontario L5V 0B4

Giving the model number, serial number and date of purchase of your product and the name and address of the authorized dealer from whom it was purchased.

THIS WARRANTY GIVES YOU SPECIFIC LEGAL RIGHTS, AND YOU MAY HAVE OTHER RIGHTS WHICH VARY FROM STATE TO STATE.

NO CLAIMS FOR CONSEQUENTIAL OR OTHER DAMAGES WILL BE ALLOWED, AND THERE ARE NO OTHER EXPRESS WARRANTIES EXCEPT THOSE EXPRESSLY STIPULATED HEREIN.

SOME STATES DO NOT ALLOW LIMITATIONS ON HOW LONG AN IMPLIED WARRANTY LASTS OR THE EXCLUSION OR LIMITATIONS OF INCIDENTAL OR CONSEQUENTIAL DAMAGES, SO THE ABOVE LIMITATIONS OR EXCLUSION MAY NOT APPLY TO YOU.

This is a limited warranty within the meaning of that term as defined in the Magnuson-Moss Act of 1975.

The policy of **Poulan PRO** is to continuously improve its products. Therefore, **Poulan PRO** reserves the right to change, modify, or discontinue models, designs, specifications, and accessories of all products at any time without notice or obligation to any purchaser.

Free Manuals Download Website

<http://myh66.com>

<http://usermanuals.us>

<http://www.somanuals.com>

<http://www.4manuals.cc>

<http://www.manual-lib.com>

<http://www.404manual.com>

<http://www.luxmanual.com>

<http://aubethermostatmanual.com>

Golf course search by state

<http://golfingnear.com>

Email search by domain

<http://emailbydomain.com>

Auto manuals search

<http://auto.somanuals.com>

TV manuals search

<http://tv.somanuals.com>