

SEARS

GAS RANGE OWNER'S MANUAL

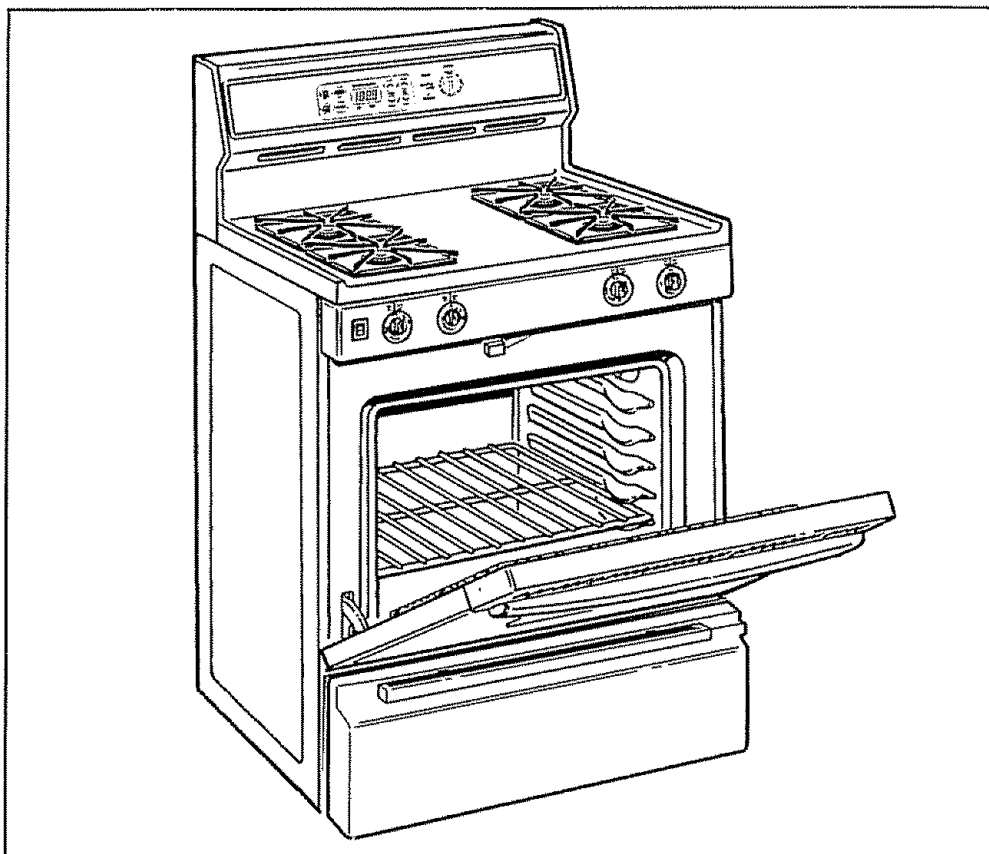

Model Numbers:

| | |
|-------|-------|
| 72671 | 75478 |
| 72675 | 75571 |
| 72676 | 75575 |
| 72678 | 75576 |
| 73271 | 75578 |
| 73278 | 75671 |
| 73465 | 75675 |
| 75371 | 75676 |
| 75375 | 75678 |
| 75376 | 75681 |
| 75378 | 75685 |
| 75471 | |

| | |
|------------------------------------|--------------|
| • Safety Instructions | |
| Anti-Tip Device | 2, 3, 34, 42 |
| Important Safety Instructions | 2-6 |
| • Care & Maintenance | |
| Before You Call for Service | 43-45 |
| Care and Cleaning | 27-32 |
| Consumer Services | 46, 48 |
| Repair Services | 46 |
| Thermostat Adjustment | 19 |
| Warranty | 47 |
| • Installation Instructions | |
| Air Adjustment | 40, 41 |
| Anti-Tip Device | 34, 42 |
| Connect the Range to Gas | 36-38 |
| Dimensions & Clearances | 33 |
| Electrical Connections | 38, 39 |
| LP | 42 |
| • Operation | |
| Features of Your Range | 7 |
| Baking | 15-18 |
| Broiling/Broiling Guide | 22, 23 |
| Oven Control, Clock and Timer | 11, 12 |
| Roasting, Roasting Guide | 20, 21 |
| Surface Cooking | 9, 10 |

Caution:
Read and Follow
All Safety Rules
and Operating
Instructions
Before First Use
of This Appliance.

Sears, Roebuck and Co., Hoffman Estates, IL 60179 U.S.A.

Important Safety Instructions

Read all instructions before using this appliance.

WARNING: If the information in this manual is not followed exactly, a fire or explosion may result causing property damage, personal injury or death.

—Do not store or use gasoline or other flammable vapors and liquids in the vicinity of this or any other appliance.

—WHAT TO DO IF YOU SMELL GAS

- Do not try to light any appliance.
- Do not touch any electrical switch; do not use any phone in your building.
- Immediately call your gas supplier from a neighbor's phone. Follow the gas supplier's instructions.
- If you cannot reach your gas supplier, call the fire department.

—Installation and service must be performed by a qualified installer, service agency or the gas supplier.



IMPORTANT SAFETY NOTICE

- **The California Safe Drinking Water and Toxic Enforcement Act** requires the Governor of California to publish a list of substances known to the state to cause cancer, birth defects or other reproductive harm, and requires businesses to warn customers of potential exposure to such substances. **Gas appliances cause minor exposure to four of these substances**, namely benzene, carbon monoxide, formaldehyde and soot, caused primarily by the incomplete combustion of natural gas or LP fuels. Properly adjusted burners, indicated by a bluish rather than a yellow flame, will minimize incomplete combustion. Exposure to these substances can be minimized further by venting with an open window or using a ventilation fan or hood.
- **Fluorescent light bulbs and safety valves on standing pilot ranges contain mercury.** If your model has these features, they must be recycled according to local, state and federal codes.

When You Get Your Range

- Have the installer show you the location of the range gas shut-off valve and how to shut it off if necessary.
- Have your range installed and properly grounded by a qualified installer in accordance with the **Installation Instructions**. Any adjustment and service should be performed only by qualified gas range installers or service technicians.
- **Plug your range (electric ignition models only) into a 120-volt grounded outlet only.** Do not remove the round grounding prong from the plug. If in doubt about the grounding of the home electrical system, it is your personal responsibility and obligation to have an ungrounded outlet replaced with a properly grounded, three-prong outlet in accordance with the National Electrical Code. In Canada, the appliance must be electrically grounded in accordance with the Canadian Electrical Code. Do not use an extension cord with this appliance.



| | |
|---|--|
|  | ▲ WARNING |
|  | <ul style="list-style-type: none">• ALL RANGES CAN TIP• INJURY TO PERSONS COULD RESULT• INSTALL ANTI-TIP DEVICES PACKED WITH RANGE• SEE INSTALLATION INSTRUCTIONS |



- **Do not attempt to repair or replace any part of your range unless it is specifically recommended in this manual.** All other servicing should be referred to a qualified technician.
- **Be sure all packing materials are removed from the range** before operating it to prevent fire or smoke damage, should the packing material ignite.
- **Locate the range out of kitchen traffic path and out of drafty locations to prevent pilot outage (on models with standing pilots) and poor air circulation.**
- **After prolonged use of a range, high floor temperatures may result and many floor coverings will not withstand this kind of use.** Never install the range over vinyl tile or linoleum that cannot withstand such type of use. Never install it directly over interior kitchen carpeting.
- **Be sure your range is correctly adjusted by a qualified installer for the type of gas (natural or LP), that is to be used.** Your range can be converted for use with either type of gas. See the Installation Instructions.

WARNING: The conversion of your range to LP gas must be made by a qualified LP installer in accordance with the manufacturer's instructions and all codes and requirements of the authority having jurisdiction. Failure to follow these instructions could result in serious injury or property damage. The qualified agency performing this work assumes responsibility for the conversion.

Using Your Range

- **Do not leave children alone or unattended where a range is hot or in operation.** They could be seriously burned.
- **Do not allow anyone to climb, stand or hang on the door, storage or broiler drawer (on some models) or cooktop.** They could damage the range and even tip it over, causing severe personal injury.
- **Let the burner grates and other surfaces cool before touching them or leaving them where children can reach them.**

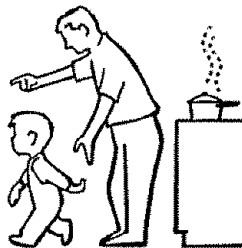

▲ WARNING—

All ranges can tip and injury could result. To prevent accidental tipping of the range, attach it to the wall and floor by installing the Anti-Tip device supplied.



To check if the device is installed and engaged properly, carefully tip the range forward. The Anti-Tip device should engage and prevent the range from tipping over.



If you pull the range out from the wall for any reason, make sure the device is properly engaged when you push the range back against the wall. If it is not, there is a possible risk of the range tipping over and causing injury if you or a child stand, sit or lean on an open door.

Please refer to the Anti-Tip device information in this manual. Failure to take this precaution could result in tipping of the range and injury.

- **For your safety, never use your appliance for warming or heating the room.**

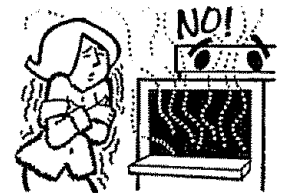

- **CAUTION: ITEMS OF INTEREST TO CHILDREN SHOULD NOT BE STORED IN CABINETS ABOVE A RANGE OR ON THE BACKSPASH OF A RANGE—CHILDREN CLIMBING ON THE RANGE TO REACH ITEMS COULD BE SERIOUSLY INJURED.**



(continued next page)

Important Safety Instructions (continued)

- Never wear loose fitting or hanging garments while using the appliance. Be careful when reaching for items stored in cabinets over the cooktop. Flammable material could be ignited if brought in contact with flames or hot oven surfaces and may cause severe burns.

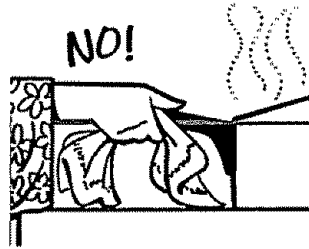

- Do not use water on grease fires. Never pick up a flaming pan. Turn the controls off. Smother a flaming pan on a surface unit by covering the pan completely with a well-fitting lid, cookie sheet or flat tray. Use a multi-purpose dry chemical or foam-type fire extinguisher.

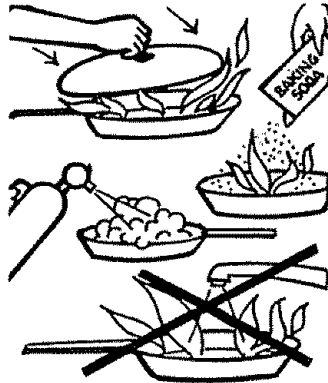

Flaming grease outside a pan can be put out by covering it with baking soda or, if available, by using a multi-purpose dry chemical or foam-type fire extinguisher.

Flame in the oven can be smothered completely by closing the oven door and turning the oven off or by using a multi-purpose dry chemical or foam-type fire extinguisher.

- Do not store flammable materials in an oven, range broiler or storage drawer, or near the cooktop.

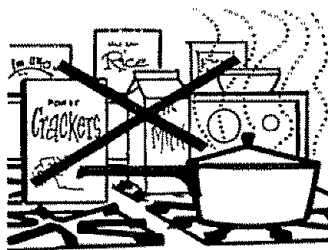

- Do not store or use combustible materials, gasoline or other flammable vapors and liquids in the vicinity of this or any other appliance.
- Do not let cooking grease or other flammable materials accumulate in or near the range.
- When cooking pork, follow the directions exactly and always cook the meat to an internal temperature of at least 170°F. (77°C.). This assures that, in the remote possibility that trichina may be present in the meat, it will be killed and the meat will be safe to eat.

Surface Cooking

- Always use the LITE position (on models with electric ignition) or the HI position (on models with standing pilots) when igniting the top burners and make sure the burners have ignited.
- Never leave the surface burners unattended at high flame settings. Boilovers cause smoking and greasy spillovers that may catch on fire.
- Adjust the top burner flame size so it does not extend beyond the edge of the cookware. Excessive flame is hazardous.
- Use only dry pot holders—moist or damp pot holders on hot surfaces may result in burns from steam.
- Do not let pot holders come near open flames when lifting cookware. Do not use a towel or other bulky cloth in place of a pot holder.
- To minimize the possibility of burns, ignition of flammable materials and spillage, turn cookware handles toward the side or back of the range without letting them extend over adjacent burners.
- Always turn the surface burners to OFF before removing cookware.
- Carefully watch foods being fried at a high flame setting.
- Never block the vents (air openings) of the range. They provide the air inlet and outlet that are necessary for the range to operate properly with correct combustion. Air openings are located in the following places:
 - Oven vent at the rear of the cooktop.
 - Air intake under the broiler drawer.
 - Air vent at the top of the oven door.

- **Do not use a wok on models with sealed burners if the wok has a round metal ring that is placed over the burner grate to support the wok.** This ring acts as a heat trap, which may damage the burner grate and burner head. Also, it may cause the burner to work improperly. This may cause a carbon monoxide level above that allowed by current standards, resulting in a health hazard.
- **Foods for frying should be as dry as possible.** Frost on frozen foods or moisture on fresh foods can cause hot fat to bubble up and over the sides of the pan.
- **Use the least possible amount of fat for effective shallow or deep-fat frying.** Filling the pan too full of fat can cause spillovers when food is added.
- **If a combination of oils or fats will be used in frying,** stir together before heating or as fats melt slowly.
- **Always heat fat slowly** and watch as it heats.
- **Use a deep-fat thermometer whenever possible** to prevent overheating fat beyond the smoking point.
- **Never try to move a pan of hot fat, especially a deep fat fryer.** Wait until the fat is cool.
- **When using glass cookware,** make sure it is designed for top-of-range cooking.
- **Use proper pan size.** Avoid pans that are unstable or easily tipped. Select cookware having flat bottoms large enough to properly contain food and avoid boilovers and spillovers and large enough to cover burner grates. This will both save cleaning time and prevent hazardous accumulations of food, since heavy spattering or spillovers left on the range can ignite. Use pans with handles that can be easily grasped and will remain cool.
- **Keep all plastics away from the top burners.**
- **Do not leave plastic items on the cooktop—they may melt if left too close to the vent.**

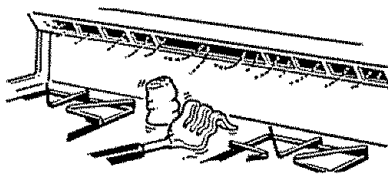

Vent appearance and location vary.

(continued next page)

Important Safety Instructions (continued)

Baking, Broiling and Roasting

- **Do not use the oven for a storage area.** Items stored in the oven can ignite.
- **Stand away from the range when opening the door of a hot oven.** The hot air and steam that escape can cause burns to hands, face and eyes.
- **Keep the oven free from grease buildup.**
- **Place the oven shelves in the desired position while the oven is cool.**
- **Pulling out the shelf to the shelf-stop is a convenience in lifting heavy foods.** It is also a precaution against burns from touching hot surfaces of the door or oven walls. The lowest position (R) is not designed to slide.
- **Do not heat unopened food containers.** Pressure could build up and the container could burst, causing an injury.
- **Do not use aluminum foil anywhere in the oven except as described in this manual.** Misuse could result in a fire hazard or damage to the range.
- **When using cooking or roasting bags in the oven,** follow the manufacturer's directions.
- **Use only glass cookware that is recommended for use in gas ovens.**
- **Always remove broiler pan from the oven or the broiler compartment as soon as you finish broiling.** Grease left in the pan can catch on fire if oven is used without removing the grease from the broiler pan.
- **When broiling, if meat is too close to the flame, the fat may ignite.** Trim excess fat to prevent excessive flare-ups.
- **Make sure the broiler pan is in place correctly** to reduce the possibility of grease fires.
- **If you should have a grease fire in the broiler pan,** turn the oven off and keep the broiler compartment door closed to contain fire until it burns out.

Self-Cleaning Oven

- **Do not clean the door gasket.** The door gasket is essential for a good seal. Care should be taken not to rub, damage or move the gasket.
- **Do not use oven cleaners.** No commercial oven cleaner or oven liner protective coating of any kind should be used in or around any part of the oven. Residue from oven cleaners will damage the inside of the oven when the self-clean cycle is used.
- **Before self-cleaning the oven,** remove the broiler pan, grid, the shelves and other cookware.
- **Clean only parts listed in this Use and Care Manual.**
- **Keep the range clean and free of accumulations of grease or spillovers, which may ignite.**
- **Be sure to wipe up excess spillage before starting the self-clean cycle.**
- **If the self-cleaning mode malfunctions, turn the oven off and disconnect the power supply.** Have it serviced by a qualified technician.

SAVE THESE INSTRUCTIONS

Features of Your Range

NOTE: Not all models have all features. Appearance of features varies.

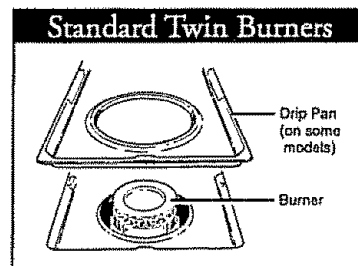
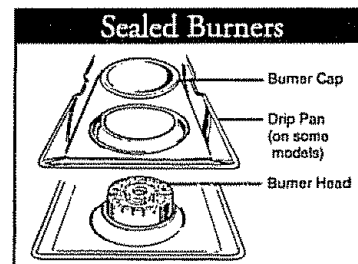
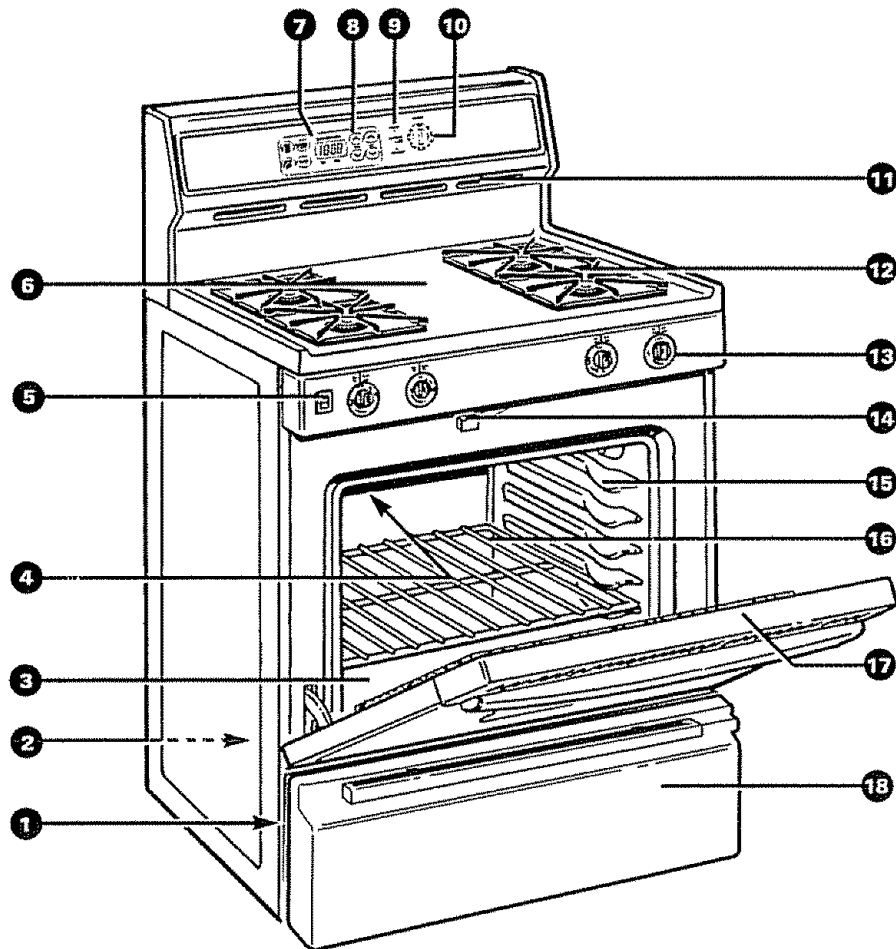

Your range is equipped with one of the two types of surface burners shown above.

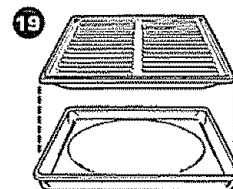

| Feature Index | See Page |
|--|--|
| 1 Model and Serial Numbers (on front frame of range, behind the storage drawer) | — |
| 2 Anti-Tip Device (Lower right rear corner on range back. See the Installation Instructions.) | 2, 3, 34, 42 |
| 3 Oven Bottom | 30, 41 |
| 4 Oven Interior Light | 13, 24, 31 |
| 5 Oven Light Switch (on some models) | 13 |
| 6 Cooktop | 3–5, 29 |
| 7 AUTOMATIC OVEN Light | 11, 17, 18 |
| 8 Clock and Timer | 11, 12 |
| 9 OVEN ON Light SELF CLEAN DOOR LATCH Light PREHEATED Light | 11, 12, 19, 25, 26 11, 19, 25, 26 11, 12, 19 |
| 10 OVEN SET Knob | 11, 12, 17–19, 22, 25, 26 |





| Feature Index | See Page |
|---|------------------------------|
| 11 Oven Vent | 4, 5, 13, 29 |
| 12 Grates, Drip Pans (on some models) and Surface Burners | 3–5, 8–10, 27, 28 |
| 13 Surface Burner Control Knobs | 9, 32 |
| 14 Oven Door Latch Use for self-cleaning cycle only. | 17, 20, 22, 25, 26 |
| 15 Oven Shelf Supports Shelf positions for cooking are suggested in the Baking, Roasting and Broiling sections. | 6, 14, 15, 20, 22, 23 |
| 16 Oven Shelves with Stop-Locks Easily removed or repositioned on shelf supports. | 6, 14, 15, 20, 22, 23, 30 |
| 17 Lift-Off Oven Door Easily removed for oven cleaning. | 6, 31 |
| 18 Storage Drawer | 3, 4, 32 |
| 19 Broiler Pan and Grid Do not clean in the self-cleaning oven. | 6, 20, 22–24, 30 |

How Does This Cooktop Compare to Your Old One?

Your new cooktop has gas burners. If you are used to cooking with induction or other electric surface units, you will notice some differences when you use gas burners.

The best types of cookware to use, plus heat-up and cool-down times, depend upon the type of burner or surface unit you have.

The following chart will help you to understand the differences between gas burner cooktops and any other type of cooktop you may have used in the past.

| Type of Cooktop | Description | How It Works |
|--|---|---|
| Gas Burners  | Regular or sealed gas burners use either LP gas or natural gas. | Flames heat the pans directly. Pan flatness is not critical to cooking results, but pans should be well balanced. Gas burners heat the pan right away and change heat settings right away. When you turn the control off, cooking stops right away. |
| Electric Coil  | Flattened metal tubing containing electric resistance wire suspended over a drip pan. | Heats by direct contact with the pan and by heating the air under the pan. For best cooking results, use good quality pans. Electric coils are more forgiving of warped pans than radiant or solid disks. Heats up quickly but does not change heat settings as quickly as gas or induction. Electric coils stay hot enough to continue cooking for a short time after they are turned off. |
| Solid Disk  | Solid cast iron disk sealed to the cooktop surface. | Heats by direct contact with the pan, so pans must be flat on the bottom for good cooking results. Heats up and cools down more slowly than electric coils. The disk stays hot enough to continue cooking after it is turned off. Remove the pan from the solid disk if you want the cooking to stop. |
| Radiant (Glass Ceramic) Cooktop  | Electric coils under a glass ceramic cooktop. | Heat travels to the glass surface and then to the cookware, so pans must be flat on the bottom for good cooking results. The glass cooktop stays hot enough to continue cooking after it is turned off. Remove the pan from the surface unit if you want cooking to stop. |
| Induction  | High frequency induction coils under a glass surface. | Pans must be made of ferrous metals (metal that attracts a magnet). Heat is produced by a magnetic circuit between the coil and the pan. Heats up right away and changes heat settings right away, like a gas cooktop. After turning the control off, the glass cooktop is hot from the heat of the pan, but cooking stops right away. |

Surface Cooking

Lighting Instructions

Your surface burners are lighted by electric ignition, eliminating the need for standing pilots with constantly burning flames.

In case of a power failure, you can light the surface burners on your range with a match. Hold a lighted match to the burner, then turn the knob to the LITE position. **Use extreme caution when lighting burners in this manner.**

Surface burners in use when an electrical power failure occurs will continue to operate normally.

The electrode of the spark igniter is exposed. When one burner is turned to LITE, all the burners spark. Do not disassemble or clean around any burner while another burner is on. An electric shock may result, which could cause you to knock over hot cookware.

Surface Burner Controls

The knobs that turn the surface burners on and off are located on the control panel in front of the burners.

The two knobs on the left control the left front and left rear burners. The two knobs on the right control the right front and right rear burners.

On ranges with sealed burners:

- The smaller burner (right rear position) will give the best simmer results. It offers precise cooking performance for delicate foods, such as sauces or foods which need to cook over low heat for a long time. It can be turned down to a very low simmer setting.
- The right front burner is higher powered than the others and will bring liquids to a boil quicker (natural gas installations only).

Surface Light

(on some models)

Use the switch on the control panel to turn the light on and off.

Before Lighting a Burner

- If drip pans are supplied with your range, they should be used at all times.
- Make sure all grates on the range are in place before using any burner.

To Light a Surface Burner

Push the control knob in and turn it to LITE. You will hear a little clicking noise—the sound of the electric spark igniting the burner.

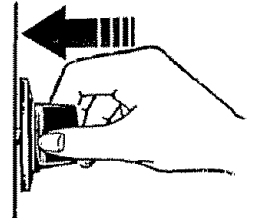

After Lighting a Burner

- After the burner ignites, turn the knob to adjust the flame size.
- Check to be sure the burner you turned on is the one you want to use.
- Do not operate a burner for extended periods of time without having cookware on the grate. The finish on the grate may chip without cookware to absorb the heat.
- Be sure the burners and grates are cool before you place your hand, a pot holder, cleaning cloths or other materials on them.

How to Select Flame Size

Watch the flame, not the knob, as you reduce heat. The flame size on a gas burner should match the cookware you are using.

FOR SAFE HANDLING OF COOKWARE NEVER LET THE FLAME EXTEND UP THE SIDES OF THE COOKWARE. Any flame larger than the bottom of the cookware is wasted and only serves to heat the handle.



(continued next page)

Surface Cooking (continued)

Top-of-Range Cookware

Aluminum: Medium-weight cookware is recommended because it heats quickly and evenly. Most foods brown evenly in an aluminum skillet. Use saucepans with tight-fitting lids when cooking with minimum amounts of water.

Cast-Iron: If heated slowly, most skillets will give satisfactory results.

Enamelware: Under some conditions, the enamel of some cookware may melt. Follow cookware manufacturer's recommendations for cooking methods.

Glass: There are two types of glass cookware—those for oven use only and those for top-of-range cooking (saucepans, coffee and teapots). Glass conducts heat very slowly.

Heatproof Glass Ceramic: Can be used for either surface or oven cooking. It conducts heat very slowly and cools very slowly. Check cookware manufacturer's directions to be sure it can be used on gas ranges.

Stainless Steel: This metal alone has poor heating properties and is usually combined with copper, aluminum or other metals for improved heat distribution. Combination metal skillets generally work satisfactorily if used at medium heat as the manufacturer recommends.

Wok This Way

(on models with sealed burners)

We recommend that you use a flat-bottomed wok. They are available at your local retail store.



A traditional round bottom wok can be used with Wok Holder accessory, model JXWK which can be ordered from your appliance dealer. The Wok Holder fits on top of the range grate to provide support and proper air circulation for traditional round bottom woks only. Do not use flat bottomed woks with the Wok Holder.

Do not use a wok on any other support ring. Placing the ring over the burner grate may cause the burner to work improperly, resulting in carbon

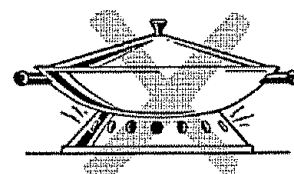

monoxide levels above allowable current standards. This could be dangerous to your health. Do not try to use such woks without the ring unless you are using the Wok Holder. You could be seriously burned if the wok tipped over.

Stove Top Grills

(on models with sealed burners)

Do not use stove top grills on your sealed gas burners. If you use the stove top grill on the sealed gas burner it will cause incomplete combustion and can result in exposure to carbon monoxide levels above allowable current standards. This can be hazardous to your health.

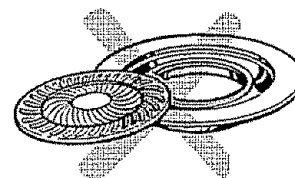

Oven Control, Clock and Timer (appearance may vary)

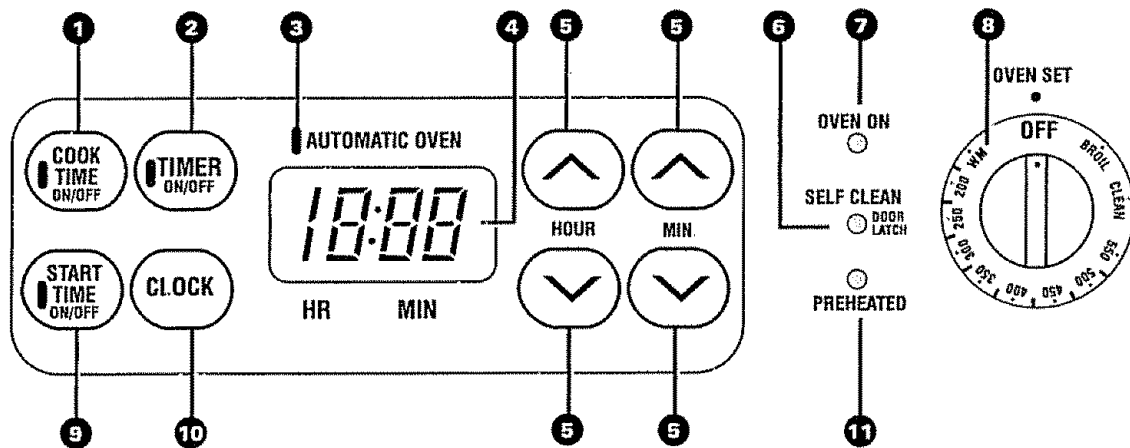

- 1. COOK TIME ON/OFF.** Press this pad and then press the HOUR and MIN. pads to set the amount of time you want your food to cook. Turn the OVEN SET knob to the desired temperature. The oven will shut off after the Cook Time has run out.
- 2. TIMER ON/OFF.** Press this pad to select the timer feature. The timer does not control oven operations. The timer can time up to 11 hours and 59 minutes.
To set the timer, first press the TIMER ON/OFF pad. Press the HOUR and MIN. pads to change the time.
To cancel the timer, press the TIMER ON/OFF pad until the display clears.
- 3. AUTOMATIC OVEN Light.** This lights anytime the oven has been programmed.
- 4. TIME DISPLAY.** Shows the time of day and the times set for the timer on automatic oven operations.
- 5. HOUR and MIN. pads.** These pads allow you to set times up to 11 hours and 59 minutes.
- 6. SELF CLEAN DOOR LATCH Light.** Glows when the oven is in the self-clean cycle. After the self-clean cycle, the light will flash. Unlatch the door and turn the OVEN SET knob to OFF.
- 7. OVEN ON Light.** Glows anytime the oven is heating. The light will flash when the oven automatically turns off to remind you to turn the OVEN SET knob to OFF.
- 8. OVEN SET Knob.** Turn this knob to the temperature or function you want. See the Baking, Roasting, Broiling and Self-Cleaning sections.
- 9. START TIME ON/OFF.** Press this pad and the HOUR and MIN. pads to delay the starting of your oven up to 11 hours and 59 minutes.
- 10. CLOCK.** Press this pad before setting the clock. To set the clock, first press the CLOCK pad. Then press the HOUR and MIN. pads to change the time of day.
- 11. PREHEATED Indicator Light.** Glows when the oven reaches your selected temperature.

(continued next page)

Oven Control, Clock and Timer (continued)

Automatic Clock

The clock must be set for the automatic oven timing functions to work properly. The time of day cannot be changed during a Timed Baking or Self-Cleaning cycle.

To Set the Clock:



1. Press the CLOCK pad.



2. Press the HOUR and MIN. pads to set the time of day.



Timer

The timer is a minute timer only.

The timer does not control oven operations. The maximum setting on the timer is 11 hours and 59 minutes.

To Set the Timer:



1. Press the TIMER ON/OFF pad.

2. Press the HOUR and MIN. pads until the amount of time you want shows in the display. The timer will start automatically within a few seconds of releasing the pad.

To Reset the Timer:

If the display is still showing the time remaining, you may change it by pressing the HOUR and MIN. pads until the time you want appears in the display.

If the remaining time is not in the display, recall the remaining time by pressing the TIMER ON/OFF pad and then pressing the HOUR and MIN. pads until the new time you want shows on the display.

To Cancel the Timer:

To cancel the timer, the remaining time must be in the display. To recall the time remaining, press the TIMER ON/OFF pad once. To cancel the timer press the TIMER ON/OFF pad again.

End of Cycle Tones

(on some models)

The end of cycle tone can be cleared by pressing the TIMER ON/OFF pad or, on some models, by pressing the COOK TIME ON/OFF pad depending on which function you are using.

Power Outage

On some models, after a power outage the oven will automatically resume its setting once the power is restored.

For models with a CLOCK pad, when the power is restored the display will flash the time of day until a pad is pressed or the knob is turned. Reset the clock to the correct time of day.

If the oven was in operation when the power outage occurred, the OVEN SET knob must be turned back to OFF. Then reset the knob to the way it was before the power outage.

If your model has a COOK TIME ON/OFF pad and your oven was set for timed baking or roasting when the power outage occurred, the clock and all programmed functions must be reset. To reset them, first turn the OVEN SET knob back to OFF, reset the clock, functions and knob back to the way they were before the power outage.

OVEN SET Knob

The OVEN SET knob maintains the temperature you set from WARM [170°F. (77°C.)] to BROIL [550°F. (288°C.)]. It also has an OFF and a CLEAN setting.

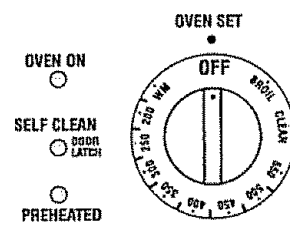

(appearance may vary)

The PREHEATED light glows when the oven reaches your selected temperature.

The OVEN ON light will glow any time the OVEN SET knob is not in the OFF position and is set on a temperature or a function.

Using Your Oven

Before Using Your Oven

Be sure you understand how to set the control properly. Practice removing and replacing the shelves while the oven is cool. Read the information and tips on the following pages. Keep this manual handy where you can refer to it, especially during the first weeks of using your new range.

Electric Ignition

The oven burner and broil burner are lighted by electric ignition.

To light either burner, turn the OVEN SET knob to the desired temperature. The burner should ignite within 30–90 seconds.

After the oven reaches the selected temperature, the oven burner cycles—off completely, then on with a full flame—to keep the oven temperature controlled.

Power Outage

CAUTION: Do not make any attempt to operate the electric ignition oven during an electrical power failure. The oven or broiler cannot be lit during a power failure. Gas will not flow unless the glow bar is hot.

If the oven is in use when a power failure occurs, the oven burner shuts off and cannot be re-lit until power is restored.

Oven Light

Use the switch on the control panel to turn the oven light on and off.

Oven Vents

The oven is vented through duct openings at the rear of the cooktop. See the Features section. Do not block these openings when cooking in the oven—it is important that the flow of hot air from the oven and fresh air to the oven burners be uninterrupted.

- The vent openings and nearby surfaces may become hot. Do not touch them.
- Handles of pots and pans on the cooktop may become hot if left too close to the vent.
- Do not leave plastic items on the cooktop—they may melt if left too close to the vent.



Vent appearance and location vary.

- Metal items will become very hot if they are left on the cooktop and could cause burns.
- Do not leave any items on the cooktop. The hot air from the vent may ignite flammable items and will increase pressure in closed containers, which may cause them to burst.

(continued next page)

Using Your Oven (continued)

Oven Shelves

The shelves are designed with stop-locks so, when placed correctly on the shelf supports, they will stop before coming completely out of the oven and will not tilt when you are removing food from them or placing food on them.

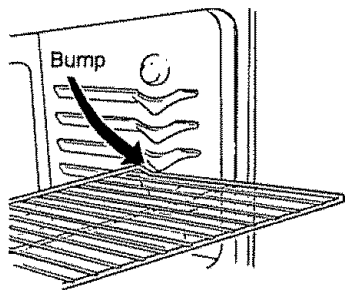

When placing cookware on a shelf, pull the shelf out to the bump on the shelf support. Place the cookware on the shelf, then slide the shelf back into the oven. This will eliminate reaching into the hot oven.

To remove a shelf from the oven, pull it toward you, tilt the front end upward and pull the shelf out.

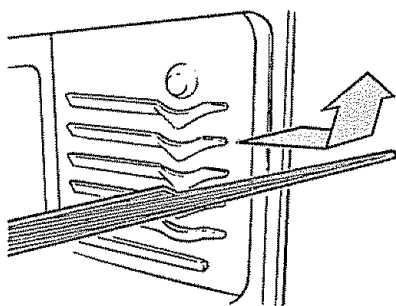

To replace, place the shelf on the shelf support with the stop-locks (curved extension of shelf) facing up and toward the rear of the oven. Tilt up the front and push the shelf toward the back of the oven until it goes past the bump on the shelf support. Then lower the front of the shelf and push it all the way back.

Shelf Positions

The oven has five shelf supports for baking and roasting—A (bottom), B, C, D and E (top). It also has a special low shelf position (R) for roasting extra large items, such as a large turkey. The shelf is not designed to slide out at this position. The shelf positions for cooking are suggested in the Baking, Roasting and Broiling sections.

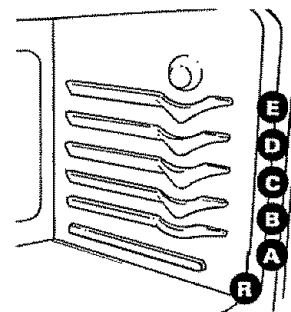

Automatic Oven Shut Off

As a safety feature, this oven will automatically shut itself off after 12 hours. On models with touch pad clock controls this feature may be deactivated to allow the oven to be left on for more than 12 hours.

To deactivate the Automatic Oven Shut-Off, press and hold both the increase and decrease MIN. pads for about 4 seconds. The display will change from time of day to show "off".

To reactivate the feature, press and hold both the increase and the decrease MIN. pads for about 4 seconds. The display will change from time of day to show "on".

Oven Moisture

As your oven heats up, the temperature change of the air in the oven may cause water droplets to form on the door glass. These droplets are harmless and will evaporate as the oven continues to heat up.

Baking

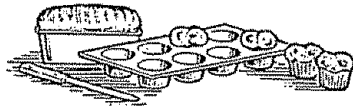

Do not lock the oven door with the latch during baking. The latch is used for self-cleaning only.

Your oven temperature is controlled very accurately using an oven control system. It is recommended that you operate the oven for a number of weeks to become familiar with your new oven's performance. If you think an adjustment is necessary, see the Adjust the Oven Thermostat section.

How to Set Your Range for Baking

To avoid possible burns, place the shelves in the correct position before you turn the oven on.

1. Close the oven door. Turn the OVEN SET knob to the temperature you desire.
2. Check the food for doneness at the minimum time on the recipe. Cook longer if necessary.
3. Turn the OVEN SET knob to OFF and then remove the food.

Oven Shelves

Arrange the oven shelf or shelves in the desired locations while the oven is cool. The correct shelf position depends on the kind of food and the browning desired. As a general rule, place most foods in the middle of the oven, on either shelf position B or C. See the following chart for suggested shelf positions.

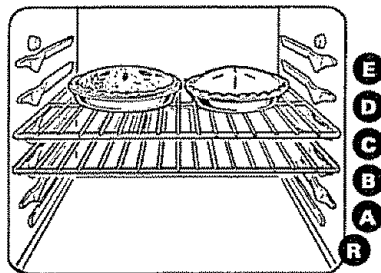

| Type of Food | Shelf Position |
|----------------------|---------------------|
| Angel food cake | A |
| Biscuits or muffins | B or C |
| Cookies or cupcakes | B or C |
| Brownies | B or C |
| Layer cakes | B or C |
| Bundt or pound cakes | A or B |
| Pies or pie shells | B or C |
| Frozen pies | A (on cookie sheet) |
| Casseroles | B or C |
| Roasting | B or R |

Preheating

Preheat the oven if the recipe calls for it. Preheat means bringing the oven up to the specified temperature before putting the food in the oven. To preheat, set the oven at the correct temperature—selecting a higher temperature does not shorten preheat time.

Preheating is necessary for good results when baking cakes, cookies, pastry and breads. For most casseroles and roasts, preheating is not necessary. For ovens without a preheat indicator light or tone, preheat 10 minutes. After the oven is preheated place the food in the oven as quickly as possible to prevent heat from escaping.

Baking Pans

Use the proper baking pan. The type of finish on the pan determines the amount of browning that will occur.

- Dark, rough or dull pans absorb heat resulting in a browner, crisper crust. Use this type for pies.
- Shiny, bright and smooth pans reflect heat, resulting in a lighter, more delicate browning. Cakes and cookies require this type of pan.
- Glass baking dishes also absorb heat. When baking in glass baking dishes, the temperature may need to be reduced by 25°F. (13°C.).

Pan Placement

For even cooking and proper browning, there must be enough room for air circulation in the oven. Baking results will be better if baking pans are centered as much as possible rather than being placed to the front or to the back of the oven.

Pans should not touch each other or the walls of the oven. Allow 1- to 1½-inch (2.5- to 4-cm) space between pans as well as from the back of the oven, the door and the sides. If you need to use two shelves, stagger the pans so one is not directly above the other.

Baking Guides

When using prepared baking mixes, follow package recipe or instructions for the best baking results.

(continued next page)

Baking (continued)

Cookies

When baking cookies, flat cookie sheets (without sides) produce better-looking cookies. Cookies baked in a jelly roll pan (short sides all around) may have darker edges and pale or light browning may occur.

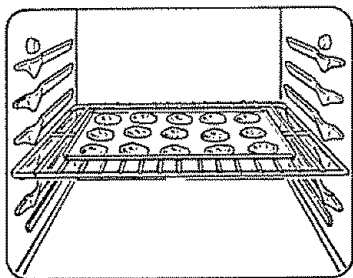

Do not use a cookie sheet so large that it touches the walls or the door of the oven.

For best results, use only one cookie sheet in the oven at a time.

Pies

For best results, bake pies in dark, rough or dull pans to produce a browner, crisper crust. Frozen pies in foil pans should be placed on an aluminum cookie sheet for baking since the shiny foil pan reflects heat away from the pie crust; the cookie sheet helps retain it.

Cakes

When baking cakes, warped or bent pans will cause uneven baking results and poorly shaped products. A cake baked in a pan larger than the recipe recommended will usually be crisper, thinner and drier than it should be. If baked in a pan smaller than recommended, it may be undercooked and batter may overflow. Check the recipe to make sure the pan size used is the one recommended.

Aluminum Foil

Never entirely cover a shelf with aluminum foil. This will disturb the heat circulation and result in poor baking. A smaller sheet of foil may be used to catch a spillover by placing it on a lower shelf several inches below the food.

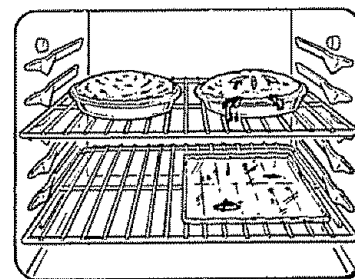

Don't Peek

Set the timer for the estimated cooking time and do not open the door to look at your food. Most recipes provide minimum and maximum baking times such as "bake 30–40 minutes."

DO NOT open the door to check until the minimum time. Opening the oven door frequently during cooking allows heat to escape and makes baking times longer. Your baking results may also be affected.

Timed Baking (on some models)

How to Time Bake

Do not lock the oven door with the latch during timed baking. The latch is used for self-cleaning only.

The oven control allows you to turn the oven on or off automatically at specific times that you set. Examples of Immediate Start (oven turns on now and you set it to turn off automatically) and Delay Start and Stop (setting the oven to turn on automatically at a later time and turn off at a preset Stop Time) will be described.

NOTE: Before beginning, make sure the oven clock shows the correct time of day.



To set the clock, first press the CLOCK pad. Then press the HOUR and MIN. pads until the correct time of day is displayed.

How to Set Immediate Start and Automatic Stop

To avoid possible burns, place the shelves in the correct position before you turn the oven on.

The oven will turn on immediately and cook for a selected length of time. At the end of Cook Time the oven will turn off automatically.



1. Press the COOK TIME ON/OFF pad.

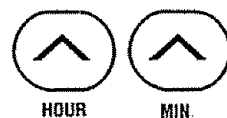

2. Press the HOUR and MIN. pads until the desired length of baking time appears in the display.



3. Turn the OVEN SET knob to the desired temperature.

4. The oven will turn on. The display will show the Cook Time remaining. When the oven reaches the set temperature, a tone sounds. The oven will continue to cook for the programmed amount of time, then shut off automatically.

5. When the oven automatically turns off the AUTOMATIC OVEN light will flash and the oven will signal. Turn the OVEN SET knob to OFF to stop the flashes and signal.

6. Remove the food from the oven. Remember, foods that are left in the oven continue cooking after the controls are off.

NOTE: Foods that spoil easily, such as milk, eggs, fish, stuffings, poultry and pork, should not be allowed to sit for more than 1 hour before or after cooking. Room temperature promotes the growth of harmful bacteria. Be sure that the oven light is off because heat from the bulb will speed harmful bacteria growth.

(continued next page)

Timed Baking (continued)

How to Set Delay Start and Automatic Stop

Quick Reminder:

1. Press the COOK TIME ON/OFF pad.
2. Press the HOUR and MIN. pads to set the desired length of cooking time.
3. Press the START TIME ON/OFF pad.
4. Press the HOUR and MIN. pads to set the time of day you want cooking to start.
5. Turn the OVEN SET knob to the desired temperature.

To avoid possible burns, place the shelves in the correct position before you program the oven.

You can set the oven control to delay-start the oven, cook for a specific length of time and then turn off automatically.

For example: Let's say it's 2:00 and dinner time is shortly after 7:00. The recipe suggests 3 hours cooking time at 325°F. (163°C.).



1. Press the COOK TIME ON/OFF pad.



2. For 3 hours of cooking time, press the HOUR pad until "3:00" appears in the display.



3. Press the START TIME ON/OFF pad.

4. Press the HOUR pad until "4:00" appears in the display. The timer is now set to start baking in 2 hours, at 4:00.

5. Turn the OVEN SET knob to the desired temperature [in this example 325°F. (163°C.)].

The oven is now set to start at 4:00 and cook for 3 hours at a temperature of 325°F. (163°C.). At the end of the 3 hour cooking time (7:00), the oven will automatically turn off. When the oven automatically turns off the AUTOMATIC OVEN light will flash and the oven will signal. Turn the OVEN SET knob to OFF to stop the flashes and signal.

6. Remove the food from the oven. Remember, even though the oven shuts off automatically, foods continue cooking after controls are off.

NOTE:

- The low temperature zone of this range [between WARM and 200°F. (93°C.)] is available to keep hot cooked foods warm. Food kept in the oven longer than two hours at these low temperatures may spoil.
- Foods that spoil easily, such as milk, eggs, fish, stuffings, poultry and pork, should not be allowed to sit for more than one hour before or after cooking. Room temperature promotes the growth of harmful bacteria. Be sure that the oven light is off because heat from the bulb will speed harmful bacteria growth.

Questions and Answers

Q. Can I use the minute timer during oven cooking?

A. The minute timer can be used during any cooking function.

Q. Can I change the time of day on the clock while I'm Time Baking in the oven?

A. The time of day on the clock should not be changed during any program that uses the oven timer. You must either stop those programs or wait until they are finished before changing the time.

Adjust the Oven Thermostat—Do It Yourself!

You may find that your new oven cooks differently than the one it replaced. We recommend that you use your new oven for a few weeks to become more familiar with it, following the times given in your recipes as a guide.

If you think your new oven is too hot or too cold, you can adjust the thermostat yourself. If you think it is too hot, adjust the thermostat to make it cooler. If you think it is too cool, adjust the thermostat to make it hotter.

We do not recommend the use of inexpensive thermometers, such as those found in grocery stores, to check the temperature setting of your new oven. These thermometers may vary 20–40°F. (11–22°C.).

To Adjust the Thermostat:

1. Put the OVEN SET knob in the OFF position.



2. Press and hold the HOUR increase and the HOUR decrease pads for 5 seconds until the display changes.



3. Immediately, before display changes back, press the HOUR increase or decrease pad to increase or decrease the temperature in 5 degree increments.

The oven temperature can be increased up to 35°F. (19°C.) hotter or decreased 35°F. (19°C.) cooler.

If the oven adjustment is set cooler than the factory setting a minus sign “-” and the offset temperature will appear in the display.

4. Wait several seconds for the control to automatically set and return to its previous setting.

NOTE: This adjustment will not affect the broiling or the self-cleaning temperatures. The adjustment will be retained in memory after a power failure.

To Adjust the Temperature on Models with Only an OVEN SET Knob

1. Put the knob in the OFF position.
2. Pull the knob off by pulling straight out.
3. Press and hold the HOTTER or COOLER button for 5 seconds to make the oven 20°F. (11°C.) hotter or 20°F. (11°C.) cooler.

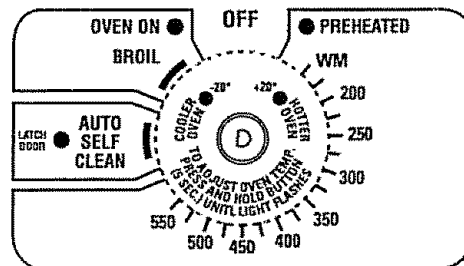

(appearance may vary)

When you are adjusting the thermostat, the following lights will flash indicating where the thermostat will be set when you release the adjustment button:

OVEN ON indicates the thermostat will be set at the factory setting.

PREHEATED indicates the thermostat will be set 20°F. (11°C.) hotter.

SELF CLEAN DOOR LATCH indicates the thermostat will be set 20°F. (11°C.) cooler.

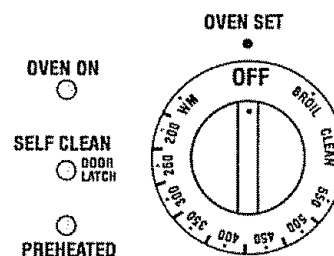

4. After you have made the adjustment, replace the knob.

Roasting

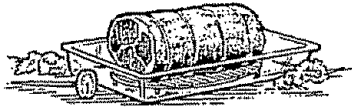

Do not lock the oven door with the latch during roasting. The latch is used for self-cleaning only.

Roasting is cooking by dry heat. Tender meat or poultry can be roasted uncovered in your oven. Roasting temperatures, which should be low and steady, keep spattering to a minimum.

The oven has a special low shelf position (R) just above the oven bottom. Use it when extra cooking space is needed, for example, when roasting a large turkey. The shelf is not designed to slide out at this position.

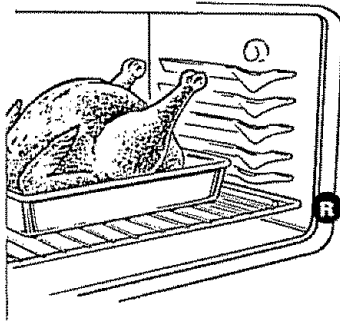

Roasting is really a baking procedure used for meats. Therefore, the oven controls are set for Baking. (You may hear a slight clicking sound indicating the oven is working properly.)

Most meats continue to cook slightly while standing after being removed from the oven. Recommended standing time for roasts is 10 to 20 minutes. This allows the roasts to firm up and makes them easier to carve. The internal temperature will rise about 5° to 10°F. (3° to 6°C.). If you wish to compensate for the temperature rise, remove the roast from the oven when its internal temperature is 5° to 10°F. (3° to 6°C.) less than the temperature shown in the Roasting Guide.

Remember that food will continue to cook in the hot oven and therefore should be removed when the desired internal temperature has been reached.

1. Position oven shelf at position B for small size roast [3 to 5 lbs. (1.3 to 2.3 kg)] and at position R for larger roasts.

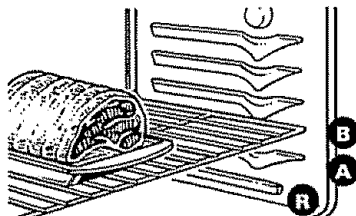

2. Check the weight of the meat. Place the meat fat-side-up or the poultry breast-side-up on roasting grid in a shallow pan. The melting fat will baste the meat. Select a pan as close to the size of the meat as possible. (The broiler pan with grid is a good pan for this.)

3. Turn the OVEN SET knob to the desired temperature. See the Roasting Guide for temperatures and approximate cooking times.
4. When roasting is finished, turn the OVEN SET knob to OFF and then remove the food from the oven.

Dual Shelf Cooking

This allows more than one food to be cooked at the same time. For example: While roasting a 20-lb. (10 kg) turkey on shelf position R, a second shelf (if so equipped) may be added on position D so that scalloped potatoes can be cooked at the same time. Calculate the total cooking time to enable both dishes to complete cooking at the same time. Allow 15–20 minutes of additional cooking time for the potatoes.

Use of Aluminum Foil

You can use aluminum foil to line the broiler pan. This makes clean up easier when using the pan for marinating, cooking with fruits, cooking heavily cured meats or basting food during cooking. Press the foil tightly around the inside of the pan.

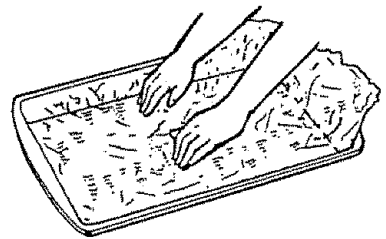

Frozen Roasts

Frozen roasts of beef, pork, lamb, etc., can be started without thawing, but allow 15 to 25 minutes per pound (450 grams) additional time [15 minutes per pound for roasts under 5 pounds (2.3 kg), more time for larger roasts].

Make sure poultry is thawed before roasting. Unthawed poultry often does not cook evenly. Some commercial frozen poultry can be cooked successfully without thawing. Follow the directions given on the package label.

Roasting Guide

| Type | Oven Temperature | Doneness | Approximate Roasting Time in Minutes per Pound | | Internal Temperature |
|--|----------------------------------|--------------------------------|---|---|--|
| Meat | | | 3 to 5 lbs. (1.4 to 2.3 kg) | 6 to 8 lbs. (2.7 to 3.6 kg) | |
| Tender cuts; rib, high quality sirloin tip, rump or top round* | 325°F (163°C.) | Rare: Medium: Well Done: | 24-35 35-39 39-45 | 18-25 25-31 31-33 | 140-150°F. (60-66°C.)† 150-160°F. (66-71°C.) 170-185°F. (77-85°C.) |
| Lamb leg or bone-in shoulder* | 325°F (163°C.) | Rare: Medium: Well Done: | 21-25 25-30 30-35 | 20-23 24-28 28-33 | 140-150°F. (60-66°C.)† 150-160°F. (66-71°C.) 170-185°F. (77-85°C.) |
| Veal shoulder, leg or loin* | 325°F (163°C.) | Well Done: | 35-45 | 30-40 | 170-180°F. (77-82°C.) |
| Pork loin, rib or shoulder* | 325°F (163°C.) | Well Done: | 35-45 | 30-40 | 170-180°F. (77-82°C.) |
| Ham, precooked | 325°F (163°C.) | To Warm: | 18-23 minutes per pound (450 grams) any weight | | 115-125°F. (46-52°C.) |
| Poultry | | | 3 to 5 lbs. (1.4 to 2.3 kg) | Over 5 lbs. (2.3 kg) | |
| Chicken or Duck Chicken pieces | 325°F (163°C.) 350°F (177°C.) | Well Done: Well Done: | 35-40 35-40 | 30-35 | 185-190°F. (85-88°C.) 185-190°F. (85-88°C.) |
| Turkey | 325°F (163°C.) | Well Done: | 10 to 15 lbs. (4.5 to 6.8 kg) 16-22 | Over 15 lbs. (6.8 kg) 12-19 | In thigh: 185-190°F. (85-88°C.) |

*For boneless rolled roasts over 6" (15 cm) thick, add 5 to 10 minutes per pound (450 grams) to times given above.

†The U.S. Department of Agriculture says, "Rare beef is popular, but you should know that cooking it to only 140°F. (60°C.) means some food poisoning organisms may survive." (Source: Safe Food Book. Your Kitchen Guide. USDA Rev. June 1985.)

Broiling



Do not lock the oven door with the latch during broiling. The latch is used for self-cleaning only.

Broiling is cooking food by direct heat from above the food. Most fish and tender cuts of meat can be broiled. Follow these directions to keep spattering and smoking to a minimum.

The oven door should be closed during broiling.

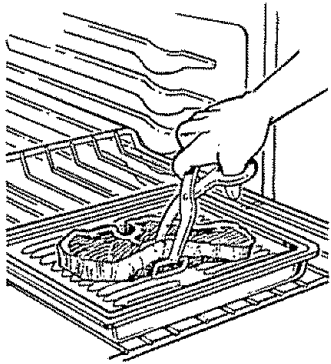

Turn the food only once during cooking. Time the foods for the first side according to the Broiling Guide.

Turn the food, then use the times given for the second side as a guide to the preferred doneness.

1. If the meat has fat or gristle around the edge, cut vertical slashes through both about 2" (5 cm) apart. If desired, the fat may be trimmed, leaving a layer about 1/8" (3 mm) thick.
2. Place the meat on the broiler grid in the broiler pan which comes with the range. Always use the grid so fat drips into the broiler pan; otherwise the juices may become hot enough to catch fire.
3. Position the shelf on the recommended shelf position as suggested in Broiling Guide.
4. Close the oven door but do not latch it. **If the door latch is moved to the right during a broil operation the door may lock and you may not be able to open it until the oven cools.**
5. Turn the OVEN SET knob to BROIL.
6. When broiling is finished, turn the OVEN SET knob to OFF. Remove the broiler pan from the range and serve the food immediately. Leave the pan outside the range to cool.

Use of Aluminum Foil

You can use aluminum foil to line your broiler pan and broiler grid. However, you must mold the foil tightly to the grid and cut slits in it just like the grid.

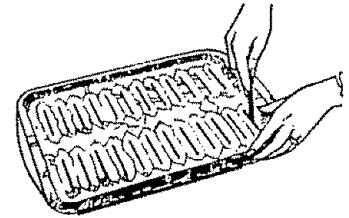

Without the slits, the foil will prevent fat and meat juices from draining to the broiler pan. The juices could become hot enough to catch on fire. If you do not cut the slits, you are frying, not broiling.

Questions & Answers

Q. When broiling, is it necessary to always use a grid in the pan?

A. Yes. Using the grid suspends the meat over the pan. As the meat cooks, the juices fall into the pan, thus keeping the meat drier. Juices are protected by the grid and stay cooler, thus preventing excessive spatter and smoking.

Q. Should I salt the meat before broiling?

A. No. Salt draws out the juices and allows them to evaporate. Always salt after cooking. Turn the meat with tongs; piercing the meat with a fork also allows the juices to escape. When broiling poultry or fish, brush each side often with butter.

Q. Why are my meats not turning out as brown as they should?

A. Check to see if you are using the recommended shelf position. Broil for the longest period of time indicated in the Broiling Guide. Turn the food only once during broiling.

Broiling Guide

The oven door must be closed during broiling.

- Always use the broiler pan and grid that comes with your range. It is designed to minimize smoking and spattering by trapping juices in the shielded lower part of the pan.
- For steaks and chops, slash fat evenly around outside edges of meat. To slash, cut crosswise through outer fat surface just to the edge of the meat. Use tongs to turn meat over to prevent piercing the meat and losing juices.
- If desired, marinate meats or chicken before broiling. Or brush with barbecue sauce last 5 to 10 minutes only.
- When arranging food on the pan, do not let fatty edges hang over the sides because dripping fat could soil the oven.
- The broiler does not need to be preheated. However, for very thin foods, or to increase browning, preheat if desired.
- Frozen steaks can be broiled by positioning the broiler pan and grid at next lowest shelf position and increasing cooking time given in this guide 1½ times per side.

| Food | Quantity and/or Thickness | Shelf Position | 1st Side Minutes | 2nd Side Minutes | Comments |
|--|--|----------------|------------------|-------------------|---|
| Bacon | 1/2 lb. (227 g) (about 8 thin slices) | C | 4 | 3 | Arrange in single layer. |
| Ground Beef Well Done | 1 lb. (450 g) (4 patties) 1/2"-3/4" (13-19 mm) thick | D | 10-11 | 7 | Space evenly. Up to 8 patties take about same time. |
| Beef Steaks Rare | 1" (2.5 cm) thick | C | 9 | 7 | Steaks less than 1" (2.5 cm) thick cook through before browning. Pan frying is recommended. |
| Medium | [1-1½ lbs. (450 g-680 g)] | C | 12 | 5-6 | |
| Well Done | | C | 13 | 8-9 | |
| Rare | 1½" (3.8 cm) thick | C | 10 | 6-7 | Slash fat. |
| Medium | [2-2½ lbs. (907 g-1.13 kg)] | C | 12-15 | 10-12 | |
| Well Done | | C | 25 | 16-18 | |
| Chicken | 1 whole [2-2½ lbs. (907 g-1.13 kg)], split lengthwise Bone-in, 4 bone-in breasts | B B | 30-35 25-30 | 15-20 10-15 | Reduce times about 5 to 10 minutes per side for cut-up chicken. Brush each side with melted butter. Broil with skin side down first. |
| Bakery Products Bread (Toast) or Toaster Pastries | 2-4 slices 1 pkg. (2) | D | 2-3 | 1/2-1 | Space evenly. Place English muffins cut-side-up and brush with butter, if desired. |
| English Muffins | 2, split | D | 3-5 | | |
| Lobster Tails | 2-4 [6-8 oz. (170 g-227 g) each] | C | 13-16 | Do not turn over. | Cut through back of shell and spread open. Brush with melted butter before broiling and after half of broiling time. |
| Fish | 1 lb. (450 g) fillets 1/4"-1/2" (6-13 mm) thick | D | 6 | 6 | Handle and turn very carefully. Brush with lemon butter before and during broiling, if desired. Preheat broiler to increase browning. |
| Ham Slices Precooked | 1" (2.5 cm) thick 1/2" (13 mm) thick | C D | 8 6 | 8 6 | Increase times 5 to 10 minutes per side for 1½" (3.8 cm) thick or home cured. |
| Pork Chops Well Done | 2 [1/2" (13 mm) thick] 2 [1" (2.5 cm) thick], about 1 lb. (450 g) | D D | 10 15 | 8 8 | Slash fat. |
| Lamb Chops Medium | 2 [1" (2.5 cm) thick], about 10-12 oz. (284-340 g) | D D | 8 10 | 4-7 10 | Slash fat. |
| Well Done | | | | | |
| Medium | 2 [1½" (3.8 cm) thick], about 1 lb. (450 g) | D D | 10 17 | 4-6 12-14 | |
| Wieners, similar precooked sausages, bratwurst | 1 lb. (450 g) pkg. (10) | D | 6 | 1-2 | If desired, split sausages in half lengthwise; cut into 5-6" (13-15 cm) pieces. |

Operating the Self-Cleaning Oven

Normal Cleaning Time: 4 hours and 20 minutes

Before a Clean Cycle

We recommend venting with an open window or using a ventilation fan or hood during the first self-clean cycle.

1. Remove the broiler pan, broiler grid, all cookware and any aluminum foil from the oven—they cannot withstand the high cleaning temperatures.

NOTE: Take the shelves out of the oven before you begin the self-clean cycle.

2. Wipe up heavy soil on the oven bottom. **If you use soap, rinse thoroughly before self-cleaning to prevent staining.**

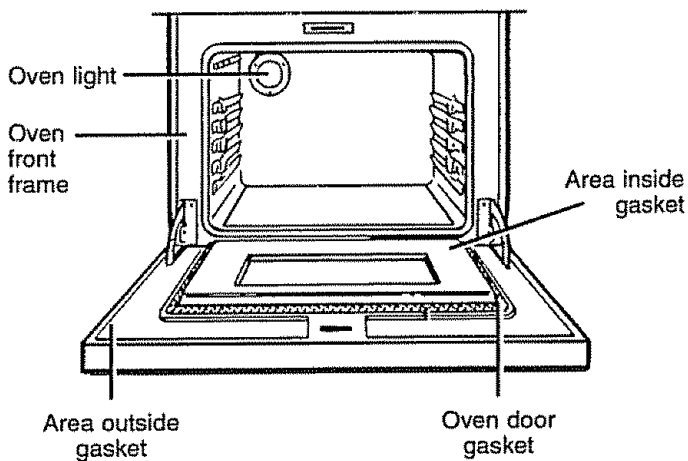

3. Clean spatters or soil on the oven front frame and the oven door outside the gasket with a dampened cloth. The oven front frame and the oven door outside the gasket do not get cleaned by the self-clean cycle. On these areas, use detergent and hot water or a soap-filled steel wool pad. Rinse well with a vinegar and water solution. This will help prevent a brown residue from forming when the oven is heated. Buff these areas with a dry cloth. Do not clean the gasket.

Do not use abrasives or oven cleaners. Clean the top, sides and outside front of the oven door with soap and water.

Make sure the oven light bulb cover is in place.

Do not rub or clean the door gasket—the fiberglass material of the gasket has an extremely low resistance to abrasion. An intact, well-fitting oven door gasket is essential for energy-efficient oven operation and good baking results. If you notice the gasket becoming worn, frayed or damaged in any way or if it has become displaced on the door, you should have it replaced.

4. **Close the oven door and make sure the oven light is off.** If the oven light is not turned off, the life of the bulb will be shortened or it may burn out immediately. The door latches automatically after the clean cycle is set.

CAUTION: The grates and drip pans (on some models) should never be cleaned in the self-cleaning oven.

Do not use commercial oven cleaners or oven protectors in or near the self-cleaning oven.

A combination of any of these products plus the high clean cycle temperatures may damage the porcelain finish of the oven.

How to Set the Oven for Cleaning

Quick Reminder:

1. Latch the door.
2. Turn the OVEN SET knob to CLEAN.

If the oven is too hot and you start to set a clean cycle, you will not be able to slide the latch.

Allow additional time for cooling before you try to set the cycle.

1. Follow directions to prepare the oven for cleaning.
2. Slide the latch handle to the right as far as it will go.

Never force the latch handle. Forcing the handle will damage the door lock mechanism.

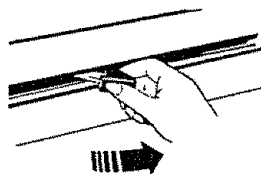

3. Turn the OVEN SET knob to CLEAN. The SELF CLEAN DOOR LATCH, AUTOMATIC OVEN, OVEN ON and COOK TIME ON/OFF lights will glow.

NOTE: If you turn the OVEN SET knob before you slide the latch, the SELF CLEAN DOOR LATCH light will flash. Slide the latch to the right.

Clean cycle time is normally 4 hours and 20 minutes. On some models you can change the Clean Time to anywhere between 3 hours and 5 hours, and 59 minutes, depending on how dirty your oven is.

You have one minute to change your Clean Time. Use the HOUR and MIN. pads to change the total Clean Time.

Both the OVEN ON light and the SELF CLEAN DOOR LATCH light will flash when the Clean Time is finished.

After using the clean cycle, the door latch and the OVEN SET knob must be returned to their original positions before you can use the oven.

When the SELF CLEAN DOOR LATCH light flashes, slide the latch handle to the left as far as it will go, turn the OVEN SET knob to OFF and open the door.

Never force the latch handle. Wait until the SELF CLEAN DOOR LATCH light flashes and the latch slides easily. Forcing the latch handle may damage the door lock.

To Stop A Clean Cycle

1. Turn the OVEN SET knob to OFF.
2. Wait until the oven has cooled below the locking temperature to unlatch the door. You will not be able to open the door right away unless the oven has cooled below the locking temperature.

After a Clean Cycle

You may notice some white ash in the oven. Just wipe it up with a damp cloth after the oven cools.

If white spots remain, remove them with a soap-filled steel wool pad. Be sure to rinse thoroughly with a vinegar and water mixture. These deposits are usually a salt residue that cannot be removed by the clean cycle.

If the oven is not clean after one clean cycle, repeat the cycle.

NOTE:

- You cannot set the oven for cooking until the oven is cool enough for the door to be unlatched.
- While the oven is self-cleaning, you can press the CLOCK pad to display the time of day. To return to the clean count down, press the COOK TIME ON/OFF pad.

(continued next page)

Operating the Self-Cleaning Oven (continued)

How to Set Delay Start of Cleaning (on some models)

Quick Reminder:

1. Latch the door.
2. Turn the OVEN SET knob to CLEAN.
3. Press the START TIME ON/OFF pad.
4. Press the HOUR and MIN. pads to set the time of day you want cleaning to start. The self-clean cycle will automatically begin at the time you selected.

Delay Start is setting the oven timer to start the clean cycle automatically at a later time than the present time of day.

For example: Let's say it is 7:00 and you want the oven to begin self-cleaning at 9:00 after you're finished in the kitchen. The oven is just soiled a normal amount so the normal Clean Time of 4 hours and 20 minutes is preferred.

1. Follow steps to prepare the oven for cleaning.
2. Slide the latch handle to the right as far as it will go.
Never force the latch handle. Forcing the handle will damage the door lock mechanism.
3. Turn the OVEN SET knob to the CLEAN position.
4. Press the START TIME ON/OFF pad.

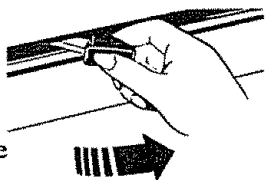

5. Press the HOUR pad until 9:00 appears in the display. The timer is now set to start cleaning in 2 hours, at 9:00.

The self-clean cycle will be set to automatically begin at 9:00 and finish at 1:20.

Both the OVEN ON light and the SELF CLEAN DOOR LATCH light will flash when the Clean Time is finished.

6. When the SELF CLEAN DOOR LATCH light flashes, slide the latch handle to the left as far as it will go, turn the OVEN SET knob to OFF and open the door.

Never force the latch handle. Wait until the SELF CLEAN DOOR LATCH light flashes and the latch slides easily. Forcing the latch handle may damage the door lock.

Questions and Answers

Q. Can I use commercial oven cleaners on any part of my self-cleaning oven?

A. No cleaners or coatings should be used around any part of this oven. If you do use them and do not thoroughly rinse the oven with water, wiping it absolutely clean afterwards, the residue can scar the oven surface and damage metal parts the next time the oven is automatically cleaned.

Q. What should I do if excessive smoking occurs during cleaning?

A. This is caused by excessive soil. Turn the OVEN SET knob to OFF. Open the windows to rid room of smoke. Wait until the SELF CLEAN DOOR LATCH light goes off. Wipe up the excess soil and reset the clean cycle.

Q. Is the "crackling" or "popping" sound I hear during cleaning normal?

A. Yes. This is the sound of the metal heating and cooling during both the cooking and cleaning functions.

Q. Should there be any odor during the cleaning?

A. Yes, there will be an odor during the first few cleanings. Failure to wipe out excessive soil might also cause a strong odor when cleaning.

Q. Why do I have ash left in my oven after cleaning?

A. Some types of soil will leave a deposit which is ash. It can be removed with a damp sponge or cloth.

Q. If my oven clock is not set to the correct time of day, can I still self-clean my oven?

A. If the clock is not set to the correct time of day, you will not be able to set a delay clean to end at a specific time.

Q. What causes the hair-like lines on the enameled surface of my oven?

A. This is a normal condition, resulting from heating and cooling during cleaning. These lines do not affect how your oven performs.

Q. Can I cook food on the cooktop while the oven is self-cleaning?

A. Yes. While the oven is self-cleaning, you can use the cooktop just as you normally do.

Q. The SELF CLEAN DOOR LATCH light flashes when I set the clean cycle. What's wrong?

A. The SELF CLEAN DOOR LATCH light will flash until the latch is moved to the right.

Q. Can I clean the woven gasket around the oven door?

A. No, this gasket is essential for a good oven seal, and care must be taken not to rub, damage or move this gasket.

Care and Cleaning

Proper care and cleaning are important so your range will give you efficient and satisfactory service. Follow these directions carefully in caring for it to help assure safe and proper maintenance.

BE SURE ELECTRICAL POWER IS DISCONNECTED BEFORE CLEANING ANY PART OF YOUR RANGE.

Sealed Burner Assemblies

(on some models)

CAUTION: DO NOT OPERATE THE BURNER WITHOUT ALL BURNER PARTS AND DRIP PANS (IF SO EQUIPPED) IN PLACE.

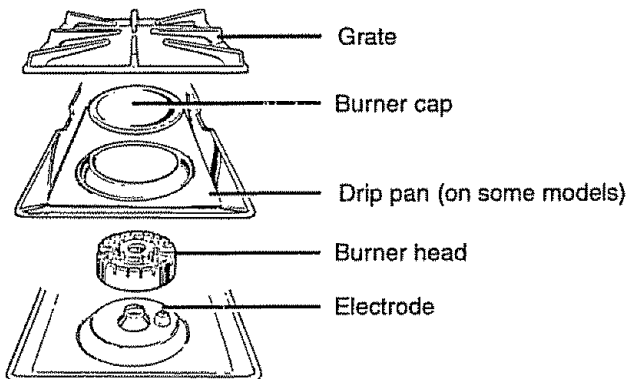

Turn all controls off before removing burner parts and drip pans (if so equipped).

The burner grates, caps, heads and drip pans (if so equipped) can be lifted off, making them easy to clean.

The electrode of the spark igniter is exposed when the burner head is removed. When one burner is turned to LITE, all the burners spark. Do not attempt to disassemble or clean around any burner while another burner is on. An electric shock may result, which could cause you to knock over hot cookware.

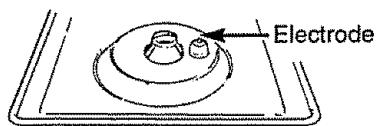

Burner Heads

(on sealed burners only)

For proper ignition, make sure the small hole in the section that fits over the electrode is kept open. A sewing needle or wire twist tie works well to unclog it.

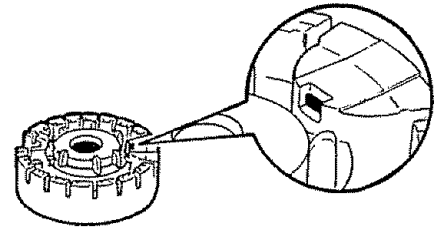

The slits in the burner heads of your range must be kept clean at all times for an even, unhampered flame.

You should clean the surface burners routinely, especially after bad spillovers, which could clog these openings.

To remove burned-on food, soak the burner heads in a solution of mild liquid detergent and hot water for 20-30 minutes. For more stubborn stains, use a toothbrush.

Before putting the burner head back, shake out excess water and then dry it thoroughly by setting it in a warm oven for 30 minutes.

Replace the burner caps. Make sure that caps are replaced on the correct size burner. There is one small, 2 medium and one large cap.

NOTE: On some models the caps are all the same size and can be used in any of the 4 needed locations.

Burner Caps

(on sealed burners only)

Lift off when cool. Wash burner caps in hot, soapy water and rinse with clean water. You may scour with a plastic scouring pad to remove burned-on food particles.

Dry them in a warm oven or with a cloth—don't reassemble them wet. Replace the burner caps.

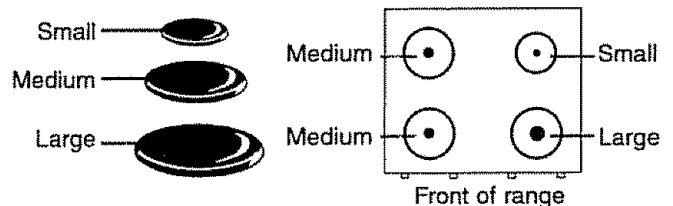

Make sure that caps are replaced on the correct size burner. There is one small, 2 medium and one large cap.

NOTE: On some models the caps are all the same size and can be used in any of the 4 needed locations.

Care and Cleaning (continued)

Standard Twin Burners

(on some models)

CAUTION: DO NOT OPERATE THE BURNER WITHOUT ALL BURNER PARTS AND DRIP PANS (IF SO EQUIPPED) IN PLACE.

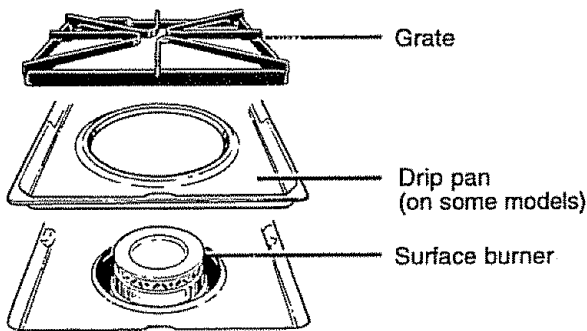

On models with standard twin burners, the cooktop lifts up for easy access.

Turn all controls off before removing burner parts and drip pans (if so equipped).

The burner grates and drip pans (if so equipped) can be lifted off, making them easy to clean.

The holes in the surface burners of your range must be kept clean at all times for proper ignition and an even, unhampered flame.

You should clean the surface burners routinely, especially after bad spillovers, which could clog these holes. Wipe off surface burners. If heavy spillover occurs, remove the surface burners from the range. Burners lift out for cleaning. Lift up the cooktop and then lift out the surface burners.

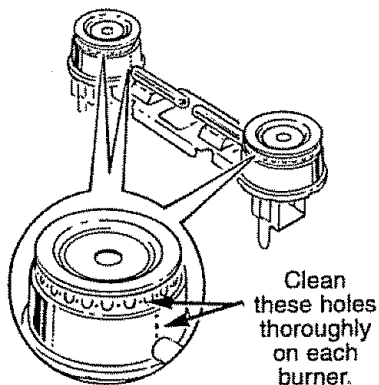

To remove burned-on food, soak the surface burner in a solution of mild liquid detergent and hot water. Soak the surface burner for 20 to 30 minutes. For more stubborn stains, use a cleanser like Soft Scrub® brand or Bon Ami® brand. Rinse well to remove any traces of the cleanser that might clog the surface burner openings. Do not use steel wool because it will clog the surface burner openings and scratch the surface burners. If the holes become clogged, clean them with a sewing needle or twist tie.

Before putting the surface burner back, shake out excess water and then dry it thoroughly by setting it in a warm oven for 30 minutes. Then place it back in the range, making sure it is properly seated and level.

Check the flame pattern of each burner. If the flames are "jumpy" (not steady), clean the holes again with a sewing needle or twist tie.

Lift-Up Cooktop

(on models with standard twin burners)

Clean the area under the cooktop often. Built-up soil, especially grease, may catch on fire.

To make cleaning easier, the cooktop may be lifted up.

To raise the cooktop:

1. Be sure the burners are turned off.
2. Remove the grates.
3. Grasp the two front burner wells and lift up.

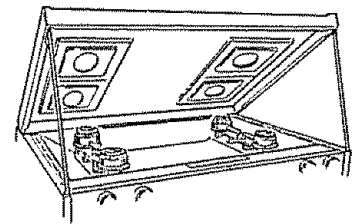

Some models have dual support rods that will hold the cooktop up while you clean underneath it.

After cleaning under the cooktop with hot, soapy water and a clean cloth, lower the cooktop. Be careful not to pinch your fingers. Lower cooktop gently to avoid blowing out pilot flames (on models with standing pilots).

Burner Grates

Lift out when cool.

The grates should be washed regularly and, of course, after

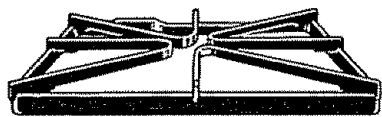

spillovers. Wash them in hot, soapy water and rinse with clean water. After cleaning, dry them thoroughly by putting them in a warm oven for a few minutes. Do not put the grates back on the range while they are wet. When replacing the grates, be sure they're positioned securely over the burners.

To prevent rusting on cast iron grates, apply a light coating of cooking oil on the bottom of the grates.

To get rid of burned-on food, place the grates in a covered container (or plastic bag) with 1/4 cup (62 ml) ammonia to loosen the soil. Let sit overnight (or approximately 12 hours), then scrub with a soap-filled scouring pad if necessary. Rinse grates thoroughly and dry completely before replacing them on the range top.

Although they're durable, the grates will gradually lose their shine, regardless of the best care you can give them. This is due to their continual exposure to high temperatures.

Do not operate a burner for an extended period of time without cookware on the grate. The finish on the grate may chip without cookware to absorb the heat.

CAUTION: Do not clean the grates in a dishwasher or in a self-cleaning oven.

Drip Pans

(on some models)

Remove the grates and lift out the drip pans. The drip pans can be cleaned in a dishwasher or by hand.

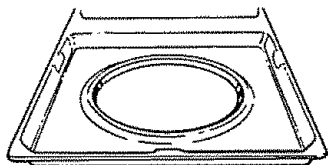

To get rid of burned-on food, place the drip pans in a covered container (or plastic bag) with 1/4 cup (62 ml) ammonia to loosen the soil. Then scrub with a soap-filled scouring pad if necessary.

When replacing the drip pans, make sure they are in the correct position.

CAUTION: Do not clean the drip pans in a self-cleaning oven.

Oven Air Vents

Never block the vents (air openings) of the range. They provide the air inlet and outlet that are necessary for the range to operate properly with correct combustion. Air openings are located at the rear of the cooktop, at the top and bottom of the oven door, and at the bottom of the range, under the kick panel, storage drawer or broiler drawer (depending on the model).

Cooktop Surface

(on some models)

To avoid damaging the porcelain enamel surface of the cooktop and to prevent it from becoming dull, clean up spills right away. Foods with a lot of acid (tomatoes, sauerkraut, fruit juices, etc.) or foods with high sugar content could cause a dull spot if allowed to sit. When the surface has cooled, wash and rinse.

For other spills such as fat splatterings, etc., wash with soap and water once the surface has cooled. Then rinse and polish with a dry cloth.

Do not store flammable materials in an oven or near the cooktop. Do not store or use combustible materials, gasoline or other flammable vapors and liquids in the vicinity of this or any other appliance.

Brushed Chrome Cooktop

(on some models)

Clean the brushed chrome top with warm, soapy water or Bon Ami® brand cleanser and immediately dry it with a clean, soft cloth. Take care to dry the surface following the "grain." To help prevent finger marks after cleaning, spread a thin film of baby oil on the surface. Wipe away excess oil with a clean, soft cloth.



(continued next page)

Care and Cleaning (continued)

Broiler Pan and Grid

After broiling, remove the broiler pan from the oven or broiler compartment (depending on your model). Remove the grid from the pan. Carefully pour out grease from the pan into a proper container. Wash and rinse the broiler pan and grid in hot water with a soap-filled or plastic scouring pad.

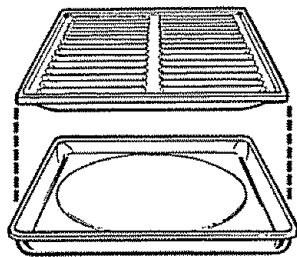

If food has burned on, sprinkle the grid with detergent while hot and cover with wet paper towels or a dishcloth. Soaking the pan will remove burned-on foods.

Both the broiler pan and grid can also be cleaned in a dishwasher.

Do not store a soiled broiler pan and grid anywhere in the range.

CAUTION: Do not clean the broiler pan or grid in a self-cleaning oven.

Oven Shelves



Clean the shelves with an abrasive cleanser or steel wool. After cleaning, rinse the shelves with clean water and dry with a clean cloth.

NOTE: Take the shelves out of the oven before you begin the self-clean cycle.

Oven Bottom

The oven bottom has a porcelain enamel finish. To make cleaning easier, protect the oven bottom from excessive spillovers by placing a cookie sheet on the shelf below the shelf you are cooking on. You can use aluminum foil if you do not cover the whole shelf. This is particularly important when baking a fruit pie or other foods with a high acid content. Hot fruit fillings or other foods that are highly acidic (such as tomatoes, sauerkraut and sauces with vinegar or lemon juice) may cause pitting and damage to the porcelain enamel surface and should be wiped up immediately.

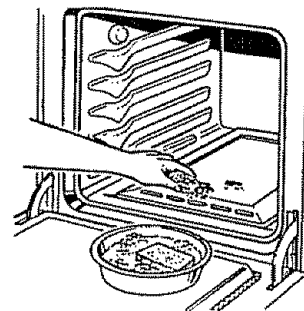

To clean up spillovers, use soap and water, an abrasive cleaner or soap-filled steel wool pad. Rinse well to remove any soap before self-cleaning.

Surface Light and Starter

(on some models)

CAUTION: Do not touch the bulb with wet hands or when bulb is hot. Never wipe the light area with a wet cloth. Electrical power must be shut off if you have to replace a bulb.

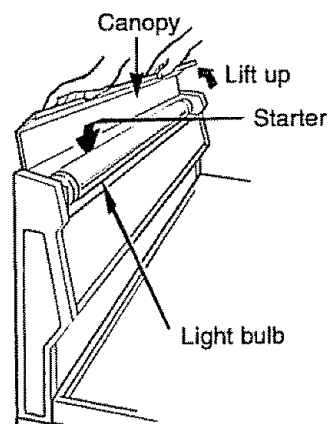

To replace the bulb:

1. With one hand at each end of the hinged canopy, grasp it by the front edge and flip it up.
2. Remove the fluorescent light bulb. Replace the bulb with one of the same length and wattage.
3. Lower the canopy.

To replace the starter:

1. Open the canopy and remove the bulb as explained above.
2. Grasp the starter, turn it counterclockwise about one-quarter turn and lift out. Replace with one of the same wattage.

3. Replace the bulb and lower the canopy.

Oven Light Replacement

(on some models)

CAUTION: Before replacing your oven light bulb, disconnect electrical power to the range at the main fuse or circuit breaker panel. Be sure to let the light cover and bulb cool completely.

The oven light (bulb) is covered with a removable glass cover that is held in place with a bail-shaped wire. Remove the oven door, if desired, to reach the cover easily.

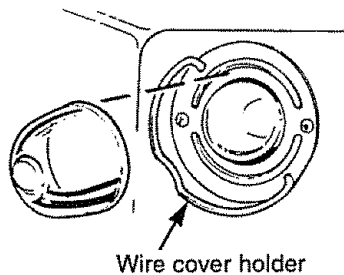

To remove:

1. Hold a hand under the cover so it doesn't fall when released. With fingers of the same hand, firmly push back the wire cover holder. Lift off the cover. **DO NOT REMOVE ANY SCREWS TO REMOVE THE COVER.**
2. Do not touch a hot bulb with a wet cloth. Replace the bulb with a 40-watt household appliance bulb.

To replace cover:

1. Place it into the groove of the light receptacle. Pull the wire forward to the center of the cover until it snaps into place. When in place, the wire holds the cover firmly. Be certain the wire is in the depression in the center of the cover.
2. Connect electrical power to the range.

Lift-Off Oven Door

The oven door is removable, but it is heavy. You may need help removing and replacing the door.

To remove the door, open it a few inches to the special stop position that will hold the door open. Grasp firmly on each side and lift the door straight up and off the hinges.

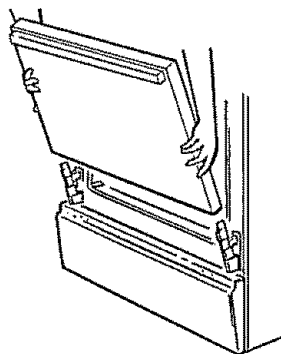

NOTE: Be careful not to place hands between the hinge and the oven door frame as the hinge could snap back and pinch fingers.

To replace the door, make sure the hinges are in the special stop position. Position the slots in the bottom of the door squarely over the hinges. Then lower the door slowly and evenly over both hinges at the same time. If the hinges snap back against the oven frame, pull them back out.

TO CLEAN THE DOOR:

(Do not immerse the door in water.)

Inside of the door:

- Because the area inside the gasket is cleaned during the self-clean cycle, you do not need to clean this by hand. Any soap left on the liner causes additional stains when the oven is heated.
- The area outside the gasket can be cleaned with a scouring pad.
- **Do not rub or clean the door gasket**—the fiberglass material of the gasket has an extremely low resistance to abrasion. An intact and well-fitting oven door gasket is essential for energy-efficient oven operation and good baking results. If you notice the gasket becoming worn, frayed or damaged in any way or if it has become displaced on the door, you should have it replaced.

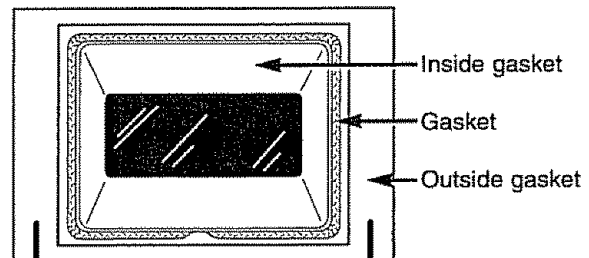

Outside of the door:

- Use soap and water to thoroughly clean the top, sides and front of the oven door. Rinse well. You may also use a glass cleaner to clean the glass on the outside of the door.
- Spillage of marinades, fruit juices, tomato sauces and basting materials containing acids may cause discoloration and should be wiped up immediately. When the surface is cool, clean and rinse.
- **Do not use oven cleaners, cleansing powders or harsh abrasives on the outside of the door.**

(continued next page)

Care and Cleaning (continued)

Removable Kick Panel

(on some models)

The kick panel may be removed for cleaning under the range.

To remove, lift up the bottom of the panel slightly to disengage the panel from the tabs at the base of the range. Pull the bottom of the panel forward until the spring clips are released at the top of the panel.

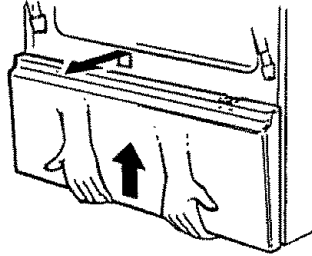

To replace, insert the two slots at the bottom of the panel onto the two tabs at the base of the range and push the top of the panel forward to engage the spring clips.

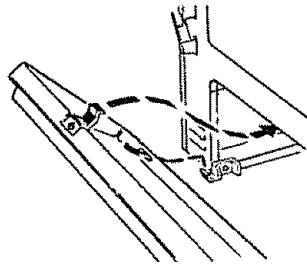

Removable Broiler Drawer

(on some models)

To remove:

1. When the broiler is cool, remove the grid and pan.
2. Pull the broiler drawer out until it stops, then push it back in about one inch.
3. Grasp the handle, lift and pull the broiler drawer out. Clean the broiler drawer with hot, soapy water.

To replace:

Hold the broiler drawer in the raised position as you slide it partway into the range. Then lower the drawer and push it completely closed.

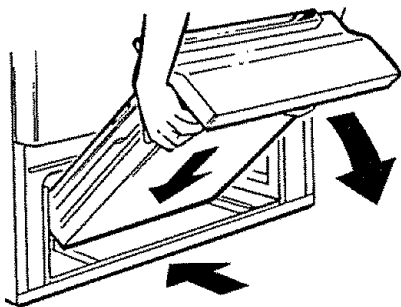

Removable Storage Drawer

(on some models)

The storage drawer is a good place to store cookware and bakeware. Do not store plastics and flammable material in the drawer.

Do not overload the storage drawer. If the drawer is too heavy, it may slip off the track when opened.

The storage drawer may be removed for cleaning under the range. Clean the storage drawer with a damp cloth or sponge. Never use harsh abrasives or scouring pads.

To remove the storage drawer:

1. Pull the drawer straight out until it stops.
2. Tilt the front of the drawer up and free of the range.

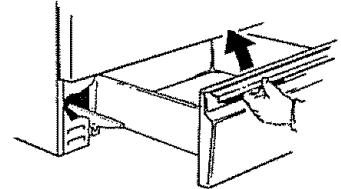

To replace the storage drawer:

1. Set the stops on the back of the drawer over the stops in the range.
2. Slide the drawer evenly and straight back, so that the rails in the range are engaged.

Control Panel and Knobs

It's a good idea to wipe the control panel after each use of the oven. Clean with mild soap and water, or vinegar and water, rinse with clean water and polish dry with a soft cloth.

Do not use abrasive cleansers, strong liquid cleaners, plastic scouring pads or oven cleaners on the control panel—they will damage the finish. A 50/50 solution of vinegar and hot water works well.

The control knobs may be removed for easier cleaning. To remove the knob, pull it straight off the stem. If knob is difficult to remove, place a towel or dishcloth between the knob and control panel and pull gently. Wash the knobs in soap and water, or vinegar solution, but do not soak.

Metal parts can be cleaned with soap and water. Do not use steel wool, abrasives, ammonia, acids or commercial oven cleaners. Dry with a soft cloth.

Installation Instructions

FOR YOUR SAFETY

If you smell gas:

1. Open windows.
2. Don't touch electrical switches.
3. Extinguish any open flame.
4. Immediately call your gas supplier.

FOR YOUR SAFETY

Do not store or use combustible materials, gasoline or other flammable vapors and liquids in the vicinity of this or any other appliance.

BEFORE YOU BEGIN

Read these instructions completely and carefully.

IMPORTANT: Save these instructions for the local electrical inspector's use.

INSTALLER: Leave these instructions with the appliance after installation is completed.

CONSUMER: Keep this Use and Care Manual and the Installation Instructions for future use.

This appliance must be properly grounded.

WARNING

Improper installation, adjustment, alteration, service or maintenance can cause injury or property damage. Refer to this manual. For assistance or additional information, consult a qualified installer, service agency, manufacturer (dealer) or the gas supplier.

Never reuse old flexible connectors. The use of old flexible connectors can cause gas leaks and personal injury. Always use **NEW** flexible connectors when installing a gas appliance.

CAUTION

Do not attempt to operate the oven of this range during a power failure (electric ignition models only).

IMPORTANT

Remove all packing material and literature from oven before connecting gas and electrical supply to range.

DIMENSIONS AND CLEARANCES

Provide adequate clearances between the range and adjacent combustible surfaces.

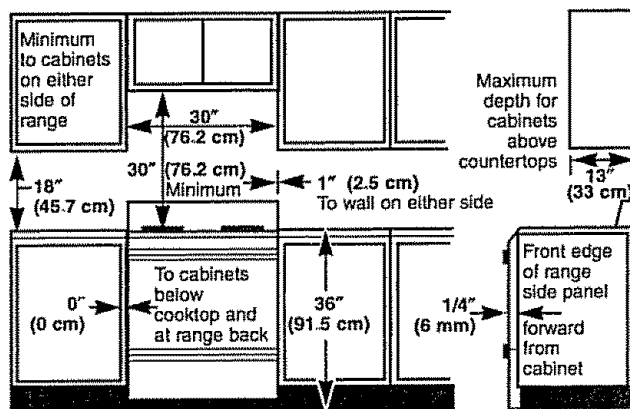
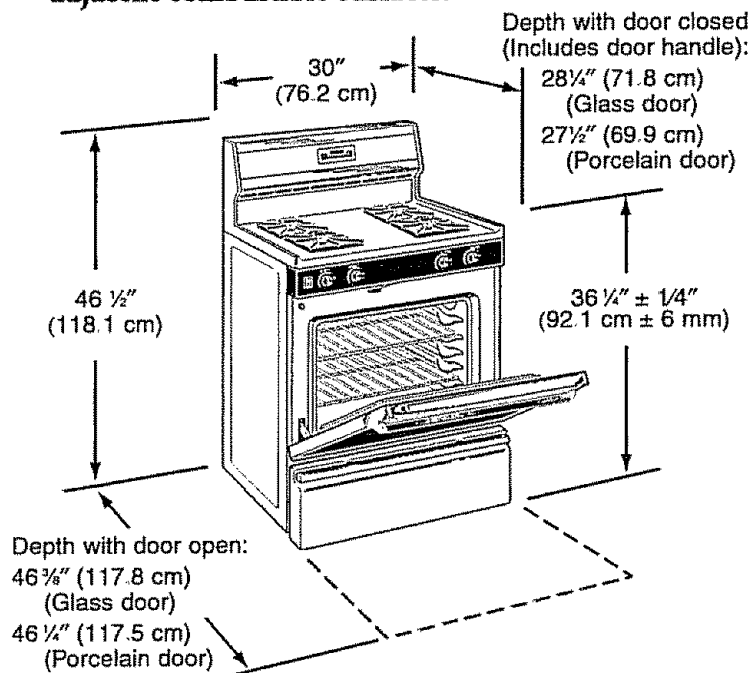

(continued next page)

Important Safety Instructions

- Installation of this range must conform with local codes, or in the absence of local codes, with the National Fuel Gas Code, ANSI Z223.1, latest edition. In Canada, installation must conform with the current Natural Gas Installation Code, CAN/CGA-B149.1 or the current Propane Installation Code, CAN/CGA-B149.2 and with local codes where applicable.

This range has been design-certified by the American Gas Association according to ANSI Z21.1, latest edition and Canadian Gas Association according to CAN/CGA-1.1 latest edition. As with any appliance using gas and generating heat, there are certain safety precautions you should follow. You will find these precautions in the Important Safety Instructions section in the front of this manual. Read them carefully.

- Have your range installed by a qualified installer.
 - Your range must be electrically grounded in accordance with local codes or, in the absence of local codes, in accordance with the National Electrical Code (ANSI/NFPA 70, latest edition). In Canada, electrical grounding must be in accordance with the current CSA-C22.1 Canadian Electrical Code Part 1 and/or local codes. See Electrical Connections in this section.
 - Before installing your range on linoleum or any other synthetic floor covering, make sure the floor covering can withstand 180°F. (82°C.) without shrinking, warping or discoloring. Do not install the range over carpeting unless a sheet of 1/4" (6 mm) thick plywood or similar insulator is placed between the range and carpeting.
 - Make sure the wall coverings around the range can withstand heat generated by the range up to 200°F. (93°C.).
 - Avoid placing cabinets above the range. To reduce the hazard caused by reaching over the open flames of operating burners, install a ventilation hood over the range that projects forward at least 5" (12.7 cm) beyond the front of the cabinets.
- The ventilating hood must be constructed of sheet metal not less than 0.0122" (.31 mm) thick. Install above the cooking top with a clearance of not less than 1/4" (6 mm) between the hood and the underside of the combustible material or metal cabinet. The hood must be at least as wide as the appliance and centered over the appliance. Clearance between the cooking surface and the ventilation hood surface **MUST NEVER BE LESS THAN 24" (61 cm)**.
EXCEPTION: Installation of a listed microwave oven or cooking appliance over the cooktop shall conform to the installation instructions packed with that appliance.
 - If cabinets are placed above the range, allow a minimum clearance of 30" (76.2 cm) between the cooking surface and the bottom of unprotected cabinets.
 - If a 30" (76.2 cm) clearance between cooking surface and overhead combustible material or metal cabinets cannot be maintained, protect the underside of the cabinets above the cooking top with not less than 1/4" (6 mm) insulating millboard covered with sheet metal not less than 0.0122" (.31 mm) thick.
 - Clearance between the cooking surface and protected cabinets **MUST NEVER BE LESS THAN 24" (61 cm)**. The vertical distance from the plane of the cooking surface to the bottom of adjacent overhead cabinets extending closer than 1" (2.5 cm) to the plane of the range sides must not be less than 18" (45.7 cm). (See the Dimensions and Clearances illustration in this section.)
 - **CAUTION:** Items of interest to children should not be stored in cabinets above a range or on the backsplash of a range—children climbing on the range to reach items could be seriously injured.

WARNING

All ranges can tip and injury could result. To prevent accidental tipping of the range, attach an approved Anti-Tip device to the wall. (See Installing the Anti-Tip Device in this section.) To check if the device is installed and engaged properly, carefully tip the range forward. The Anti-Tip device should engage and prevent the range from tipping over.

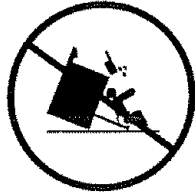

If you pull the range out from the wall for any reason, make sure the Anti-Tip device is engaged when you push the range back against the wall.

- For your safety, never use your range for warming or heating the room. Your oven and cooktop are not designed to heat your kitchen. Top burners should not be operated without cookware on the grate. Such abuse could result in fire and damage to your range and will void your warranty.
- Do not store or use combustible materials, gasoline or other flammable vapors and liquids in the vicinity of this or any other appliance. Explosions or fires could result.
- Do not use oven for a storage area. Items stored in the oven can ignite.
- Do not let cooking grease or other flammable materials accumulate in or near the range.

GENERAL

- See the Dimensions and Clearances illustration in this section for all rough-in and spacing dimensions. These dimensions must be met for safe use of your range. The location of the electrical outlet and pipe opening (see Gas Pipe and Electric Outlet Locations) may be adjusted to meet specific requirements.
- The range may be placed with 0" (0 cm) clearance (flush) at the back wall and side walls of the range.

LOCATION

Do not locate the range where it may be subject to strong drafts. Any openings in the floor or wall behind the range should be sealed. Make sure the openings around the base of the range that supply fresh air for combustion and ventilation are not obstructed by carpeting or woodwork.

PROTECT YOUR FLOOR

Your range, like many other household items, is heavy and can settle into soft floor coverings such as cushioned vinyl or carpeting. Use care when moving the range on this type of flooring. It is recommended that the following simple and inexpensive instructions be followed to protect your floor.

The range should be installed on a sheet of plywood (or similar material). *When the floor covering ends at the front of the range*, the area that the range will rest on should be built up with plywood to the same level or higher than the floor covering. This will allow the range to be moved for cleaning or servicing.

MODEL AND SERIAL NUMBER LOCATION

Depending on your range, you'll find the model and serial numbers on a label on the front frame of the range, behind the storage drawer, broiler drawer or kick panel.

TOOLS YOU WILL NEED

- Phillips and flat-blade screwdrivers
- Pencil and ruler
- Two pipe wrenches (one for backup)
- 1 $\frac{3}{8}$ " open-end or adjustable wrench
- Nut drivers or wrenches: 3/16" and 1/4"

ADDITIONAL MATERIALS YOU MAY NEED

- Gas line shut-off valve
- Pipe joint sealant or UL-approved pipe thread tape with Teflon* that resists action of natural and LP gases
- Flexible metal appliance connector (1/2" I.D.). A 5-foot (1.5 m) length is recommended for ease of installation but other lengths are acceptable. Never use an old connector when installing a new range.
- Flare union adapter for connection to gas supply line (3/4" or 1/2" NPT x 1/2" I.D.)
- Flare union adapter for connection to pressure regulator on range (1/2" NPT x 1/2" I.D.)

*Teflon: Registered trademark of DuPont

(continued next page)

Installation Instructions (continued)

PREPARATION

- Remove all tape and packaging. Lift up the cooktop (on models with standard twin burners) and remove any packing material under it. Make sure the standard twin burners are properly seated and level.
- Remove plastic film that covers some chrome parts (around oven door, side trim).
- Take the accessory pack out of the oven.
- Check to be sure that no range parts have come loose during shipping.

STEP 1

Provide Adequate Gas Supply

Your range is designed to operate at a pressure of 4" (10.2 cm) of water column on natural gas or, if designed for LP gas (propane or butane), 10" (25.4 cm) of water column. Make sure you are supplying your range with the type of gas for which it is designed. This range is convertible for use on natural or propane gas. If you decide to use this range on LP gas, conversion must be made by a qualified LP installer before attempting to operate the range on that gas.

For proper operation, the pressure of natural gas supplied to the regulator must be between 4" (10.2 cm) and 13" (33 cm) of water column. For LP gas, the pressure supplied must be between 10" (25.4 cm) and 13" (33 cm) of water column. When checking for proper operation of the regulator, the inlet pressure must be at least 1" (2.5 cm) greater than the operating (manifold) pressure as given above. The pressure regulator located at the inlet of the range manifold must remain in the supply line regardless of whether natural or LP gas is being used. A flexible metal appliance connector used to connect the range to the gas supply line should have an I.D. of 1/2" and be 5 feet (1.5 m) in length for ease of installation. In Canada, flexible connectors must be single wall metal connectors no longer than 6 feet (1.8 m) in length.

STEP 2

Connect the Range to Gas

Shut off the main gas supply valve before disconnecting the old range and leave it off until new hook-up has been completed. Don't forget to relight the pilot on other gas appliances when you turn the gas back on.

Because hard piping restricts movement of the range, the use of an A.G.A.-certified flexible metal appliance connector is recommended unless local codes require a hard-piped connection. Never use an old connector when installing a new range. If the hard piping method is used, you must carefully align the pipe; the range cannot be moved after the connection is made.

To prevent gas leaks, put pipe joint compound on, or wrap pipe thread tape with Teflon* around, all male (external) pipe threads.

*Teflon: Registered trademark of DuPont

Gas Pipe and Electric Outlet Locations for Models Equipped with Sealed Burners

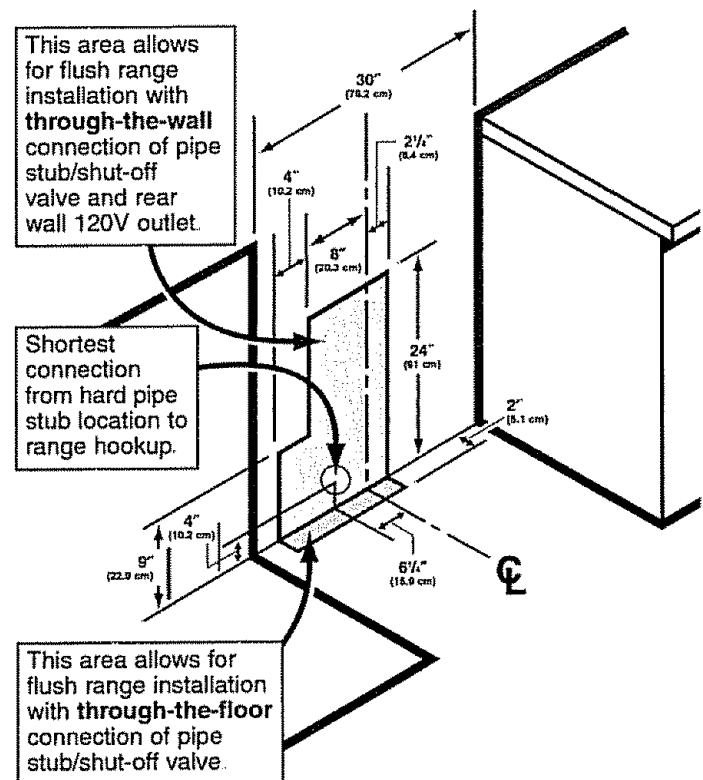

Gas Pipe and Electric Outlet Locations for Models Equipped with Standard Twin Burners

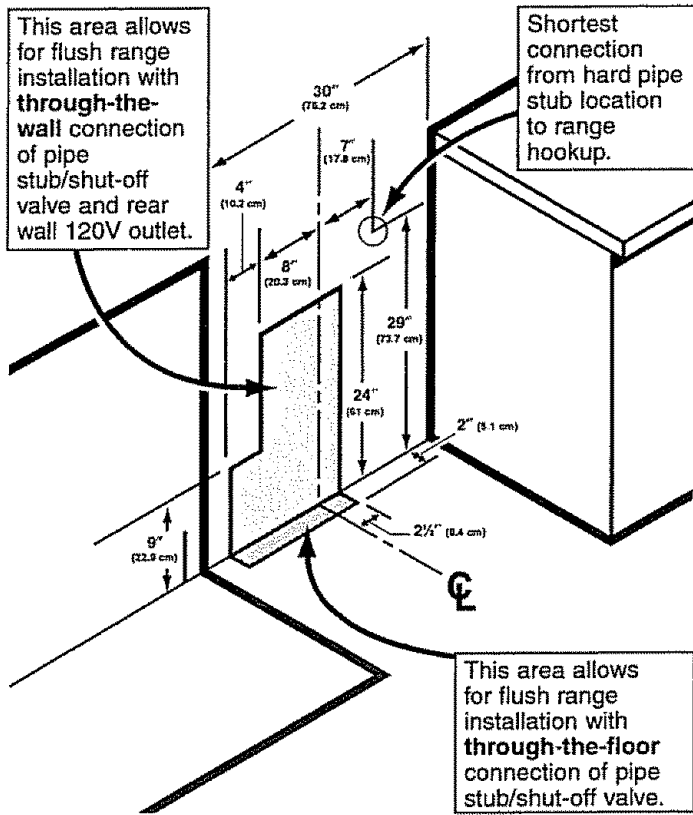

Flexible Connector Hookup for Models Equipped with Sealed Burners

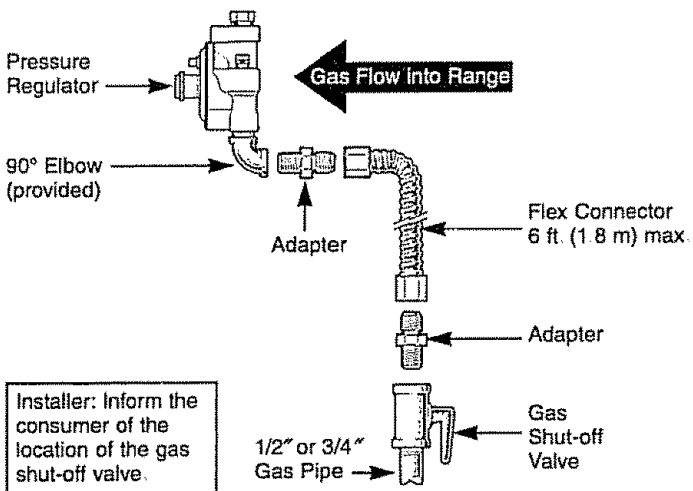

Rigid Pipe Hookup for Models Equipped with Sealed Burners

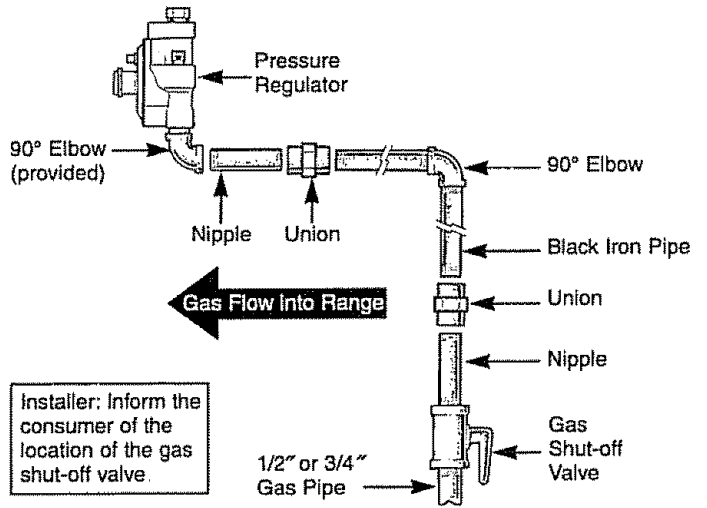

Flexible Connector and Rigid Pipe Hookup for Models Equipped with Standard Twin Burners

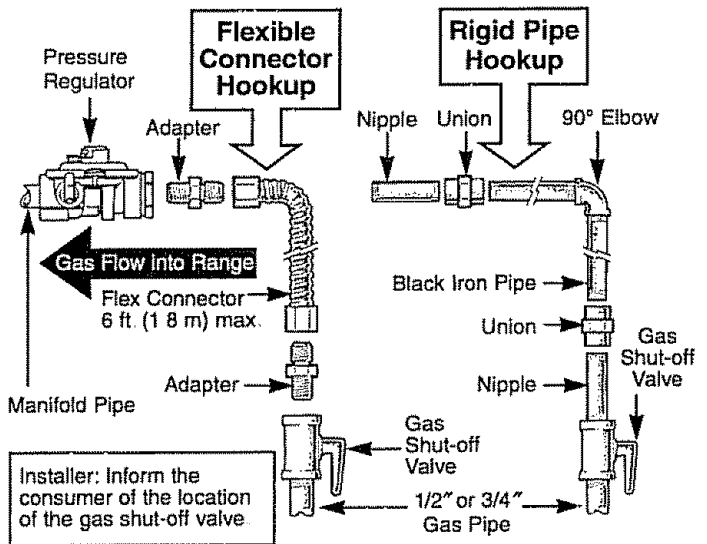

(continued next page)

Installation Instructions (continued)

1. Install a manual gas line shut-off valve in the gas line in an easily accessed location outside of the range. Make sure everyone operating the range knows where and how to shut off the gas supply to the range.
2. Install male 1/2" flare union adapter to the 1/2" NPT internal thread elbow at inlet of pressure regulator. On models equipped with standard twin burners, install the male pipe thread end of the 1/2" flare union adapter to the 1/2" NPT internal thread at inlet of pressure regulator. Use a back-up wrench on the regulator fitting to avoid damage.

When installing the range from the front, remove the 90° elbow for easier installation.

3. Install male 1/2" or 3/4" flare union adapter to the NPT internal thread of the manual shut-off valve, taking care to back up the shut-off valve to keep it from turning.
4. Connect flexible metal appliance connector to the adapter on the range. Position range to permit connection at the shut-off valve.
5. When all connections have been made, make sure all range controls are in the OFF position and turn on the main gas supply valve. Use a liquid leak detector at all joints and connections to check for leaks in the system.

CAUTION: DO NOT USE A FLAME TO CHECK FOR GAS LEAKS.

When using test pressures greater than 1/2 psig to pressure test the gas supply system of the residence, disconnect the range and individual shut-off valve from the gas supply piping. When using test pressures of 1/2 psig or less to test the gas supply system, simply isolate the range from the gas supply system by closing the individual shut-off valve.

STEP 3 Electrical Connections

(on some models)

Electrical Requirements

120-volt, 60 Hertz, properly grounded branch circuit protected by a 15-amp or 20-amp circuit breaker or time delay fuse.

Extension Cord Cautions

Because of potential safety hazards associated with certain conditions, we strongly recommend against the use of an extension cord. However, if you still elect to use an extension cord, it is absolutely necessary that it be a UL-listed, 3-wire grounding-type appliance extension cord and that the current carrying rating of the cord in amperes be equivalent to, or greater than, the branch circuit rating.

Grounding—IMPORTANT (Please read carefully)

FOR PERSONAL SAFETY, THIS APPLIANCE MUST BE PROPERLY GROUNDED.

The power cord of this appliance is equipped with a three-prong (grounding) plug which mates with a standard three-prong grounding wall receptacle to minimize the possibility of electric shock hazard from this appliance.

PREFERRED METHOD

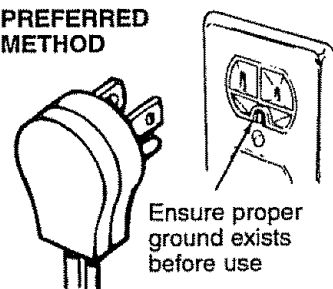

The customer should have the wall receptacle and circuit checked by a qualified electrician to make sure the receptacle is properly grounded.

Where a standard two-prong wall receptacle is encountered, it is the personal responsibility and obligation of the customer to have it replaced with a properly grounded three-prong wall receptacle.

DO NOT, UNDER ANY CIRCUMSTANCES, CUT OR REMOVE THE THIRD (GROUND) PRONG FROM THE POWER CORD.

A: Usage Situations Where Appliance Power Cord Will Be Disconnected Infrequently.

TEMPORARY METHOD

(Adapter plugs not permitted in Canada)

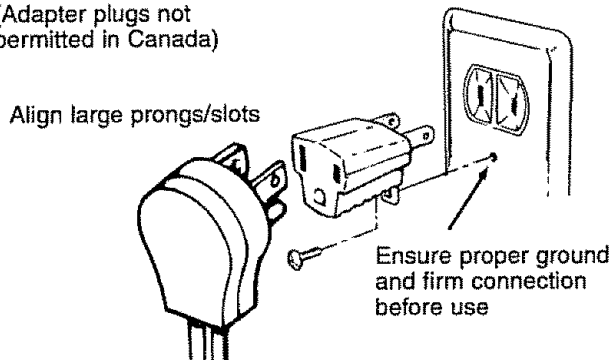

An adapter may be used only on a 15-amp circuit. Do not use an adapter on a 20-amp circuit. Where local codes permit, a **TEMPORARY CONNECTION** may be made to a properly grounded two-prong wall receptacle by the use of a UL-listed adapter, available at most hardware stores. The larger slot in the adapter must be aligned with the larger slot in the wall receptacle to provide proper polarity in the connection of the power cord.

CAUTION: Attaching the adapter ground terminal to the wall receptacle cover screw does not ground the appliance unless the cover screw is metal, and not insulated, and the wall receptacle is grounded through the house wiring. The customer should have the circuit checked by a qualified electrician to make sure the receptacle is properly grounded.

When disconnecting the power cord from the adapter, always hold the adapter with one hand. If this is not done, the adapter ground terminal is very likely to break with repeated use. Should this happen, **DO NOT USE** the appliance until a proper ground has again been established.

B: Usage Situations Where Appliance Power Cord Will Be Disconnected Frequently.

Do not use an adapter plug in these situations because disconnecting of the power cord places undue strain on the adapter and leads to eventual failure of the adapter ground terminal. The customer should have the two-prong wall receptacle replaced with a three-prong (grounding) receptacle by a qualified electrician before using the appliance.

The installation of appliances designed for mobile home installation must conform with the Manufactured Home Construction and Safety Standard, Title 24 CFR, Part 3280 (formerly the Federal Standard for Mobile Home Construction and Safety, Title 24, HUD, Part 280) or, when such standard is not applicable, the Standard for Manufactured Home Installations, latest edition (Manufactured Home Sites, Communities and Set-Ups), ANSI A225.1, latest edition, or with local codes. In Canada, mobile home installation must be in accordance with the current CAN/CSA Z240/Mtd Mobile Home Installation Code.

Electric Disconnect

1. Locate disconnect plug on the range back.
2. Pinch sides of connector and pull out of range back.

You will have this disconnect plug:

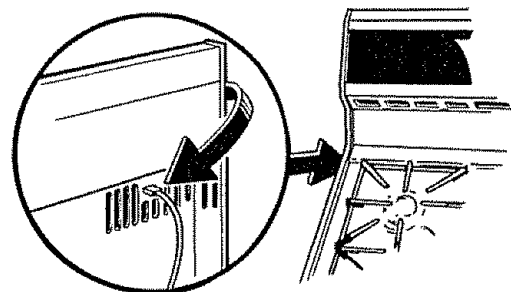

STEP 4

Seal the Openings

Seal any openings in the wall behind the range and in the floor under the range when hookups are completed.

(continued next page)

Installation Instructions (continued)

STEP 5 Check Ignition of Surface Burners

Operation of all cooktop and oven burners should be checked after the range and gas supply lines have been carefully checked for leaks.

Electric Ignition Models

Select a top burner knob and simultaneously push in and turn to LITE position. You will hear a snapping sound indicating proper operation of the spark module. Once the air has been purged from the supply lines, burners should light within 4 seconds. After burner lights, rotate knob out of the LITE position. Try each burner in succession until all burners have been checked.

Quality of Flames

The combustion quality of burner flames needs to be determined visually.

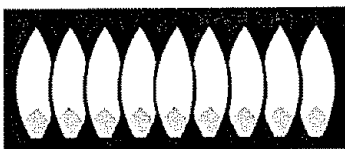

(A) Yellow flames—Call for service

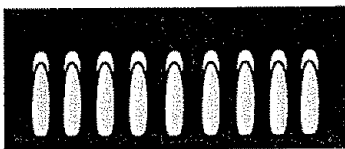

(B) Yellow tips on outer cones—Normal for LP gas



(C) Soft blue flames—Normal for natural gas

If burner flames look like (A), call for service. Normal burner flames should look like (B) or (C), depending on the type of gas you use.

With LP gas, some yellow tipping on outer cones is normal.

STEP 6 Check Ignition of Oven Burner

Your oven is designed to operate quietly and automatically. To operate the oven, turn the OVEN SET knob to a setting above 300°F. (149°C.). After 30–90 seconds, the oven burner will ignite and burn until the set temperature is reached. The oven burner will continue to cycle on and off as necessary to maintain the oven at the temperature indicated by the OVEN SET knob.

To check ignition of the broil burner, turn the OVEN SET knob to BROIL. After 30–90 seconds, the broil burner will ignite.

Electric ignition models require electrical power to operate. In case of a power outage, the oven burners on these models cannot be lit manually with a match. Gas will not flow unless the glow bar is hot.

If the oven is in use when a power outage occurs, the oven burner will shut off and cannot be re-lit until power is restored.

STEP 7 Adjust Broil and Oven Burner Air Adjustment Shutters If Necessary

Air adjustment shutters for the top and bottom burners regulate the flow of air to the flames.

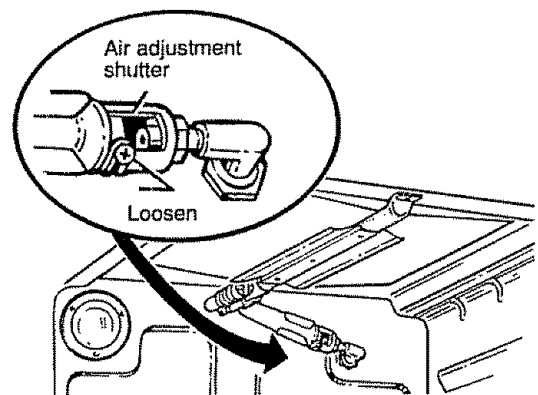

The air adjustment shutter for the top (broil) burner is in the center of the rear wall of the oven.

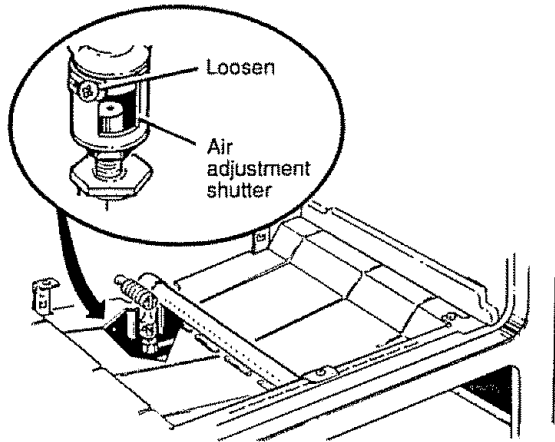

The shutter for the bottom (oven) burner is near the back wall behind the storage drawer or kick panel (depending on the model). Remove the drawer or panel. See the Care and Cleaning section in this guide.

To adjust the flow of air to either burner, loosen the Phillips head screw and rotate the shutter toward open or closed position as needed.

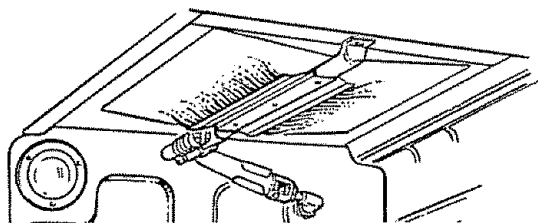

The flames for the top (broil) burner should burn steady with approximately 1" blue cones and should not extend out over the edges of the burner baffle.

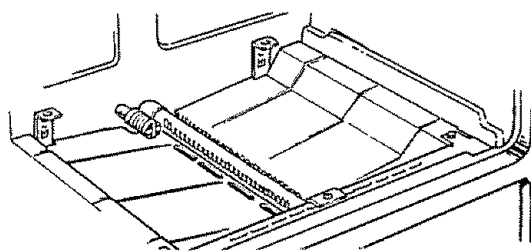

To determine if the bottom burner flames are burning properly, remove the oven bottom. Flames should have approximately 1" blue cones and, if range is supplied with natural gas, should burn with no yellow tipping. (With most LP gas, small yellow tips at the end of outer cones are normal.) Flames should not lift off burner ports. If lifting is observed, gradually reduce air shutter opening until flames are stabilized.

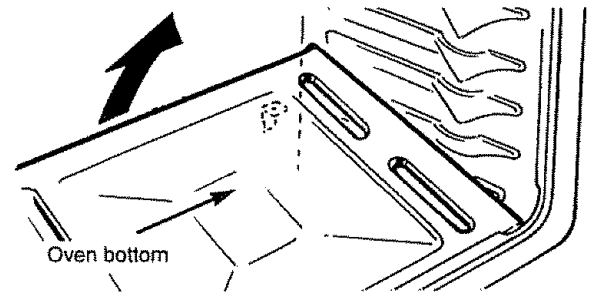

To remove the oven bottom:

1. Remove the knurled screws holding down rear of the oven bottom.
2. Grasp the oven bottom at finger slots on each side.
3. Lift the rear of the oven bottom enough to clear the lip of the range frame, then pull out.

STEP 8 Leveling the Range

1. Remove the storage drawer, broiler drawer or kick panel.
2. Use a 3/16" open-end or socket wrench to back out both rear leveling legs approximately two turns.
3. Use a 1 1/8" open-end or adjustable wrench to back out the front leveling legs two turns.
4. Install the oven shelves in the oven, then position the range where it will be installed.
5. Check for levelness by placing a spirit level or a partially filled cup of water on one of the oven shelves. If using a spirit level, take two readings—with the level placed diagonally first in one direction and then the other.
6. Adjust the leveling legs until the range is level.
7. After the range is level, slide the range away from the wall so that the Anti-Tip device can be installed.

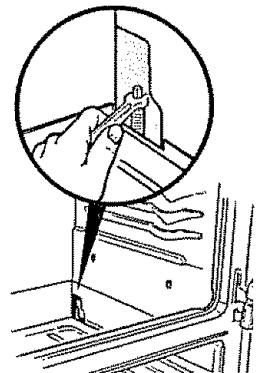

(continued next page)

Installation Instructions (continued)

STEP 9 Installing the Anti-Tip Device

WARNING:

- Range must be secured with an approved Anti-Tip device.
- Unless properly installed, the range could be tipped by you or a child standing, sitting or leaning on an open door.
- After installing the Anti-Tip device, verify that it is in place by carefully attempting to tilt the range forward.
- This range has been designed to meet all recognized industry tip standards for all normal conditions.
- The use of this device does not preclude tipping of the range when not properly installed.
- If the Anti-Tip device supplied with the range does not fit this application, use the universal Anti-Tip device WB02X7909.

1. Mark the wall where the RIGHT EDGE of the range is to be located. Be sure to allow for the countertop overhang if you intend to install the range next to cabinets.

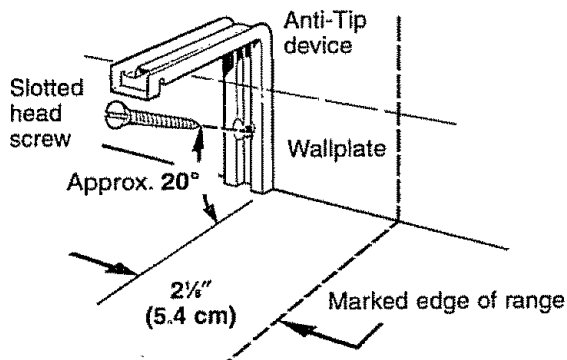

2. Locate the outside edge of the device $2\frac{1}{8}$ " (5.4 cm) toward the center of the range from the marked edge of the range.
3. Using the device as a template, mark the position of the hole for the screw.
4. For wood construction, drill a pilot hole at an angle of 20 degrees from the horizontal. A nail or awl may be used if a drill is not available.

Mount the Anti-Tip device with the screw provided.

For cement or concrete construction, you will need a $\frac{1}{4}$ " x $1\frac{1}{2}$ " lag bolt and a $\frac{1}{2}$ " O.D. sleeve anchor, which are not provided. Drill the recommended size hole for the hardware.

Install the sleeve anchor into the drilled hole and then install the lag bolt through the device. The bolts must be properly tightened as recommended for the hardware.

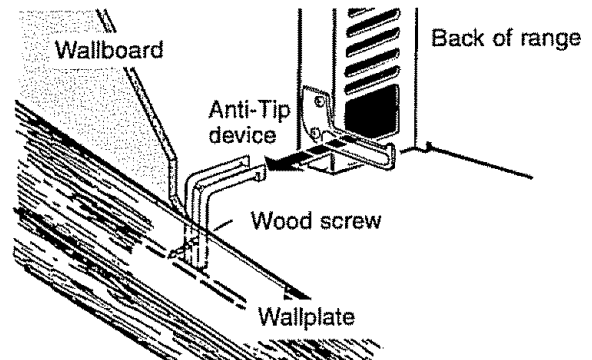

5. Slide the range against the wall, and check for proper installation by grasping the front edges of the rear surface unit openings and carefully attempting to tilt the range forward.

**WHEN ALL HOOKUPS ARE COMPLETED:
MAKE SURE ALL OF THE CONTROLS ARE LEFT IN THE OFF POSITION.
MAKE SURE THE FLOW OF COMBUSTION AND VENTILATION AIR TO THE RANGE IS UNOBSTRUCTED.**

Converting to LP gas

(or converting back to natural gas from LP)

This range leaves the factory set for use with natural gas. If you want to convert to LP gas, the conversion must be performed by a qualified LP gas installer.

The conversion instructions, sticker and LP orifices can be found attached to the range next to the pressure regulator.

There is a second set of instructions included in the envelope containing the product wiring diagrams on the back of the range. Keep these instructions and the orifices in case you want to convert back to natural gas.

Questions? Before You Call for Service...

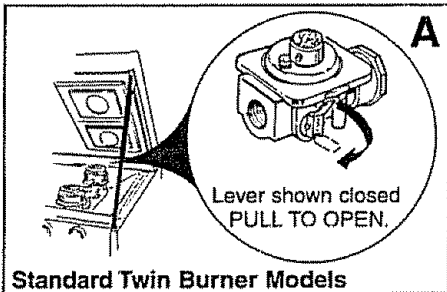
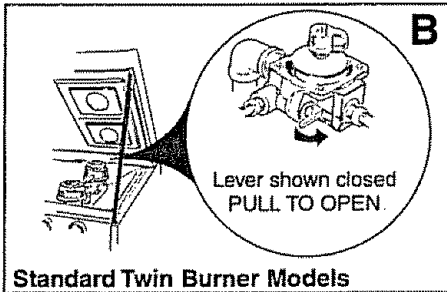
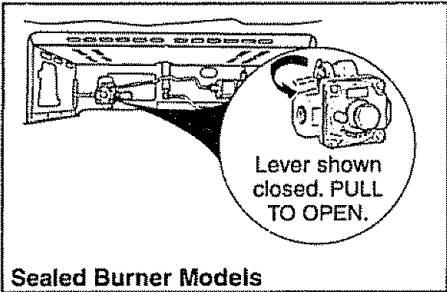
| PROBLEM | POSSIBLE CAUSE |
|--|---|
| TOP BURNERS DO NOT LIGHT OR DO NOT BURN EVENLY | <ul style="list-style-type: none"> • Make sure electrical plug is plugged into a live power outlet. • Burner holes on the side or around the top of burner may be clogged. Remove burners (on models with standard twin burners) or burner heads (on models with sealed burners) or burner caps on spill-proof models, and clean them with a sewing needle or twist tie. Make sure you do not enlarge the holes. On spill-proof models, check electrode area for burned-on food or grease. • Make sure drip pans are installed correctly. |
| BURNER FLAMES VERY LARGE OR YELLOW | <ul style="list-style-type: none"> • If range is connected to LP gas, contact the person who installed your range or made the conversion. |
| SURFACE BURNERS LIGHT BUT OVEN DOES NOT | <ul style="list-style-type: none"> • The oven gas shut-off valve may have accidentally been moved during cleaning or moving. <p>To check the oven gas shut-off valve on standard twin burner models, raise the cooktop and look for the gas shut-off lever at the extreme right rear corner. Follow the directions in box A or B that match your regulator type.</p> <div style="display: flex; justify-content: space-around;"> <div data-bbox="598 842 1042 1131">  <p style="text-align: center;">A</p> <p style="text-align: center;">Standard Twin Burner Models</p> </div> <div data-bbox="1065 842 1509 1131">  <p style="text-align: center;">B</p> <p style="text-align: center;">Standard Twin Burner Models</p> </div> </div> <p>To check the oven gas shut-off valve on sealed burner models, remove the storage drawer, broiler drawer or kick panel and look for the gas shut-off lever at the back of the range.</p> <div data-bbox="598 1274 1042 1564">  <p style="text-align: center;">Sealed Burner Models</p> </div> |

(continued next page)

Questions? Before You Call for Service... (continued)

| PROBLEM | POSSIBLE CAUSE |
|---|---|
| CLOCK AND TIMER DO NOT WORK | <ul style="list-style-type: none"> • Range electrical plug must be securely seated in a live power outlet. Check for blown fuse or tripped circuit breaker. • Check for power outage. • Review the Oven Control, Clock and Timer section of this guide. |
| “F—AND A NUMBER” FLASH IN THE DISPLAY | <ul style="list-style-type: none"> • If the time display flashes “F—and a number”, you have a function error code. If a function error code appears during the self-cleaning cycle, check the oven door latch. The latch may have been moved, even if only slightly, from the latched position. Make sure the latch is moved to the right as far as it will go. Turn the OVEN SET knob to off. Allow the oven to cool for one hour. Put the oven back into operation. • Disconnect all power to the range for 5 minutes and then reconnect power. If the failure code repeats, then call for service. |
| THE DISPLAY GOES BLANK OR INDICATOR LIGHTS COME ON WHEN THE RANGE IS NOT IN USE | <ul style="list-style-type: none"> • Disconnect power to the range at the fuse box or circuit breaker for at least 10 seconds. Turn power back on. If the indicator lights are still on, call for service. |
| SELF CLEAN DOOR LATCH LIGHT FLASHES | <ul style="list-style-type: none"> • The OVEN SET knob is set at CLEAN before the door latch handle is moved to the right. |
| OVEN LIGHT DOES NOT COME ON | <ul style="list-style-type: none"> • Bulb may be loose or burned out. • Electrical plug must be plugged into a live power outlet. |
| SURFACE LIGHT DOES NOT WORK | <ul style="list-style-type: none"> • Fluorescent bulb is loose or defective. Adjust or replace. • Switch operating light is broken. Call for service. |
| OVEN WILL NOT WORK | <ul style="list-style-type: none"> • Plug on the range is not completely inserted in the electrical outlet. • The circuit breaker in your house has been tripped, or a fuse has been blown. • Door left in lock position after self-cleaning. • Oven controls not properly set. |
| OVEN TEMPERATURE TOO HOT OR TOO COLD | <ul style="list-style-type: none"> • The oven thermostat needs adjustment. See the Adjust the Oven Thermostat—<i>Do It Yourself</i> section. |
| FOOD DOES NOT ROAST OR BAKE PROPERLY | <ul style="list-style-type: none"> • Oven controls not properly set. See the Baking or Roasting section. • Shelf position is not correct. • Incorrect cookware or cookware of improper size is being used. • Oven thermostat needs adjustment. See the Adjust the Oven Thermostat—<i>Do It Yourself</i> section. • Clock not set correctly. • Aluminum foil used improperly in the oven. • Oven bottom not securely seated in position. |

| PROBLEM | POSSIBLE CAUSE |
|---------------------------------------|---|
| FOOD DOES NOT BROIL PROPERLY | <ul style="list-style-type: none"> • Oven controls not properly set. See the Broiling section. • Oven door and/or broiler drawer not closed. • Improper shelf position being used. See the Broiling section. • Food is being cooked on a hot pan. • Cookware is not suited for broiling. • Aluminum foil used on the broiler pan grid has not been fitted properly and slit as recommended. • Oven bottom not securely seated in position. |
| OVEN WILL NOT SELF-CLEAN | <ul style="list-style-type: none"> • Oven temperature is too high to set self-cleaning operation. Allow the range to cool to room temperature and reset the controls. • OVEN SET knob not set to CLEAN. • Door latch handle not moved all the way to the right. |
| OVEN NOT CLEAN AFTER CLEAN CYCLE | <ul style="list-style-type: none"> • Oven controls not set properly. See the Operating the Self-Cleaning Oven section. • Heavily soiled ovens require at least 4 hours and 20 minutes of cleaning time. • Heavy spillovers should be cleaned up before starting clean cycle. |
| OVEN DOOR WILL NOT UNLOCK | <ul style="list-style-type: none"> • The oven must cool below the locking temperature after the clean cycle is complete. Do not lock door with door latch except when using the self-clean feature or the oven may lock. |
| DOOR ACCIDENTALLY LOCKED WHILE BAKING | <ul style="list-style-type: none"> • Turn the OVEN SET knob to OFF. |
| STRONG ODOR | <ul style="list-style-type: none"> • Improper air/gas ratio in oven. Adjust oven burner air shutter. • An odor from the insulation around the oven liner is normal for the first few times oven is used. This is temporary. |

For the repair or replacement parts you need

Call 7 am - 7 pm, 7 days a week

1-800-366-PART

(1-800-366-7278)

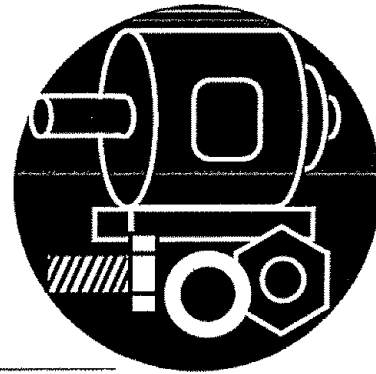

For in-home major brand repair service

Call 24 hours a day, 7 days a week

1-800-4-MY-HOMESM

(1-800-469-4663)



**For the location of a
Sears Repair Service Center in your area**

Call 24 hours a day, 7 days a week

1-800-488-1222



**For information on purchasing a Sears
Maintenance Agreement or to inquire
about an existing Agreement**

call 9 am - 5 pm, Monday-Saturday

1-800-827-6655



SEARS

REPAIR SERVICES

America's Repair Specialists

KENMORE GAS RANGE WARRANTY

FULL ONE-YEAR WARRANTY ON THE FUNCTIONING OF ALL PARTS EXCEPT GLASS PARTS

If, within one year from the date of installation, any part, other than a glass part, fails to function properly due to a defect in material or workmanship, Sears will repair or replace it, free of charge.

FULL 30-DAY WARRANTY ON GLASS PARTS AND FINISH OF PORCELAIN ENAMEL, PAINTED OR BRIGHT METAL FINISHED PARTS

If, within 30 days from the date of installation, any glass part or the finish on any porcelain enamel, painted or bright metal part is defective in material or workmanship, Sears will replace the part, free of charge.

FULL 90-DAY WARRANTY ON MECHANICAL ADJUSTMENTS

For 90 days from the date of installation, Sears will provide, free of charge, any mechanical adjustments necessary for proper operation of the range, except for normal maintenance.

If the range is subjected to other than private family use, the above warranty coverage is effective for only 90 days.

WARRANTY SERVICE IS AVAILABLE BY CONTACTING THE NEAREST SEARS SERVICE CENTER/DEPARTMENT IN THE UNITED STATES.

This warranty applies only while this product is in use in the United States. This warranty gives you specific legal rights, and you may also have other rights which vary from state to state.

SEARS, ROEBUCK AND CO., DEPT. 702PSO, 3333 Beverly Rd., Hoffman Estates, IL 60179

Dear Customer: Our constant efforts are directed toward making sure your new Kenmore Range will arrive at your home in perfect condition and will give you proper performance. As part of these efforts, we feel it is our responsibility to provide you with this warranty for your range.

WE SERVICE WHAT WE SELL

"We Service What We Sell" is our assurance to you that you can depend on Sears for service because Sears service is nationwide. Your Kenmore Range has added value when you consider that Sears has a service unit near you staffed by Sears trained technicians...professional technicians specifically trained on Sears appliances, having the parts, tools and equipment to ensure that we meet our pledge to you—"We Service What We Sell!"

TO FURTHER ADD TO THE VALUE OF YOUR RANGE, BUY A SEARS MAINTENANCE AGREEMENT.

Kenmore Ranges are designed, manufactured and tested for years of dependable operation. Yet, any modern appliance may require service from time to time. The Sears warranty plus the Sears Maintenance Agreement provides protection from unexpected repair bills and assures you of enjoying maximum counter unit efficiency.

Here's a comparative warranty and Maintenance Agreement chart showing you the benefits of a Sears Range Maintenance Agreement.

CONTACT YOUR SEARS SALESPERSON OR LOCAL SEARS SERVICE CENTER TODAY AND PURCHASE A SEARS MAINTENANCE AGREEMENT.

| Years of Ownership Coverage | | 1st Year | 2nd Year | 3rd Year |
|-----------------------------|--|--------------|----------|----------|
| 1 | Replacement of Defective Parts other than Porcelain or Glass | W | MA | MA |
| 2 | Mechanical Adjustment | 90 DAYS W | MA | MA |
| 3 | Porcelain and Glass Parts | 30 DAYS W | MA | MA |
| 4 | Annual Preventive Maintenance Check at your request | MA | MA | MA |

W - Warranty

MA - Maintenance Agreement

America's Best Selling Appliance Brand

Sold by SEARS, ROEBUCK AND CO., Hoffman Estates, IL 60179

Free Manuals Download Website

<http://myh66.com>

<http://usermanuals.us>

<http://www.somanuals.com>

<http://www.4manuals.cc>

<http://www.manual-lib.com>

<http://www.404manual.com>

<http://www.luxmanual.com>

<http://aubethermostatmanual.com>

Golf course search by state

<http://golfingnear.com>

Email search by domain

<http://emailbydomain.com>

Auto manuals search

<http://auto.somanuals.com>

TV manuals search

<http://tv.somanuals.com>