

RCA

Camcorder User's Guide

Changing Entertainment. Again.



CC6384/CC6394

Important Information

WARNING

To reduce the risk of fire or electric shock, do not expose this product or AC charger to rain or moisture.

WARNING

RISK OF ELECTRIC SHOCK
DO NOT OPEN

To reduce the risk of electric shock, do not remove cover (or back). No user serviceable parts inside. Refer servicing to qualified service personnel.



This symbol indicates "dangerous voltage" inside the product that presents a risk of electric shock or personal injury.



This symbol indicates important instructions accompanying the product.

To reduce risk of injury, charge only rechargeable batteries recommended by the manufacturer for this product. Other types of batteries may burst causing damage and personal injury.

FCC Regulations state that unauthorized changes or modifications to this equipment may void the user's authority to operate it.

Product Registration

Please fill out the product registration card and return it immediately. Returning this card allows us to contact you if needed.

Keep your sales receipt for proof of purchase to obtain warranty parts and service and attach it here. Record the serial number and model numbers located on the bottom of the camcorder.

Model No. _____

Serial No. _____

Purchase Date. _____

Purchased From. _____

Chapter 1: Connections & Setup

Parts Checklist	6
Buttons and Controls	7
Getting Started	9
Unpack the camcorder and accessories	9
Adjust the hand strap	10
Attach the lens cap	10
Attach the power supply	11
Turn on the camcorder	12
Set the video light (Off/AUTO/ON) switch to AUTO	12
Insert a cassette tape	13
Use the LCD monitor or viewfinder to see what's recording	14
Start recording	15
Play your recording	15
Turn off the camcorder	16
Powering the Camcorder	16
Charging the Battery	16
Refreshing the Battery	18
Battery Level Icon	19
Battery Care and Storage	19
Using the Power Supply	20
Using the Shoulder Strap	21
Setting the Date and Time	22
Setting the Recording Format (for CC6394 only)	23
Additional Notes about S-VHS and S-VHS ET Cassette Tapes	24
Setting the Tape	
Recording Speed	25
Setting the Tape Length	26

Chapter 2: Using the Monitors

Seeing What You Are Recording	28
Using the LCD Monitor	28
Using the Viewfinder	29
On-screen Icons	30
Warning Icons	30

(continued on the next page)

Table of Contents

Recording and Playback Icons	31
Other Icons	35

Chapter 3: Recording

Recording Details	38
Journalistic Shooting	38
Self-Recording	39
Quick Review	39
Retake	39
Digital and Optical Zooming	40
Using Steady Pix™	41
Using the Video Light	42
Recording Tips	44

Chapter 4: Playback

Playback Options	46
Basic Playback	46
Still Playback Mode	49
Shuttle Search	50
Choose your Connection	51
Using the Cassette Tape Adapter	51
Connecting to a TV (or VCR) with Audio/Video Input Jacks	54
Playback on a TV (or VCR) with Audio/Video Input Jacks	55
Tape Dubbing	56

Chapter 5: Digital Still Camera

Digital Still Camera Recording and Playback	58
Setting the Picture Quality	59
Selecting a Snapshot Mode	60
Taking Snapshots	62
Normal Playback	64
Slide Show	65

Table of Contents

Index	65
Index Playback	66
Protecting Images	67
Unprotecting Images	68
Deleting Images	69
Initializing the Built-in Memory	70
System Requirements for Picture Navigator	72
Connecting To A Windows® PC	73

Chapter 6: Advanced Features

Using the Menus For Advanced Adjustment.....	76
Menu Definitions	77
Camera Menu	77
System Menu	77
System Menu (continued)	78
Using the Advanced Features	80
Fade/Wipe Effects	80
Program AE With Special Effects	82
Digital Effects	83
Exposure Control	84
Focusing	85
White Balance Adjustment	87
Date/Time Insert	89
Instant Titles	90
Animation	91
Time-Lapse	92

Chapter 7: Other Information

Troubleshooting	94
Final Notes	99
Care and Cleaning	102
Care and Maintenance	102
Proper Care and Storage	103
Tape Care and Storage	104
CD-ROM Care	104

(continued on the next page)

Table of Contents

Things to Avoid	105
Traveling Tips	106
Specifications	107
Customer Assistance and Service	109
Limited Warranty	111
FCC Declaration of Conformity and Industry Canada Information ..	115
Optional Accessories	116
Accessories Order Form	119
Index	122

Connections & Setup

Chapter Overview:

- Parts Checklist
- Buttons and Controls
- Getting Started
- Powering the Camcorder
- Using the Shoulder Strap
- Setting the Date and Time
- Setting the Recording Format
- Setting the Tape Recording Speed
- Setting the Tape Length

Changing Entertainment. Again.



Connections & Setup

Parts Checklist

Make sure the box includes the items shown here:

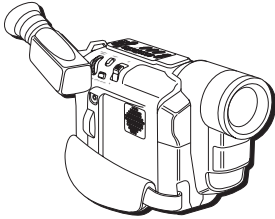

Camcorder

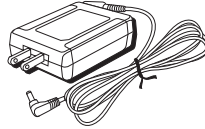

AC power supply
Part # 250814



Battery pack
Part # 244427 (FB1260)
(CC6394 only)
Part # 244265 (CC6384 only)

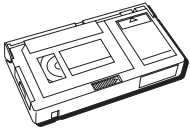

Cassette tape adapter
Part # 244270



**AA battery for
cassette tape
adapter**



Lens cap
Part # 251624



Shoulder strap
Part # ACS091

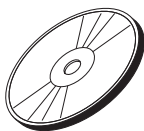

**Imaging software
CD-ROM**
Part # 247954

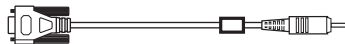

PC connection cable (for Windows® PC)
Part # 247952

Caution

Never use the power supply for any purpose other than charging the FB1260 battery pack or for supplying power to the camcorder.

Buttons and Controls

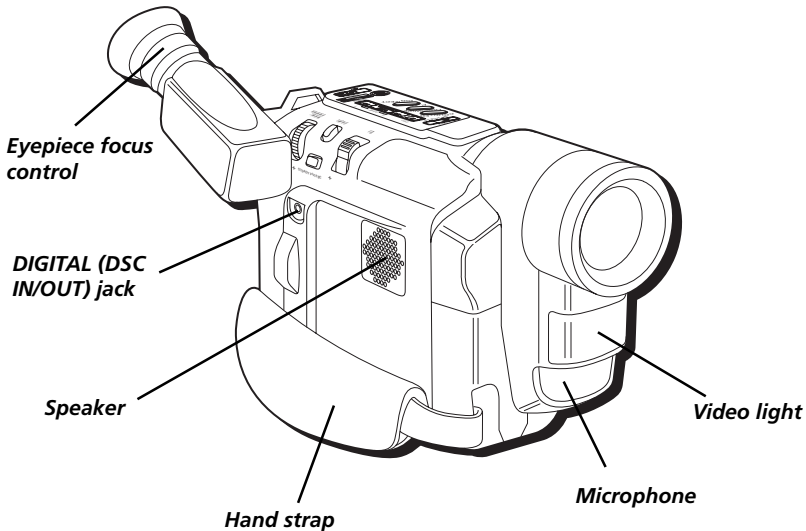
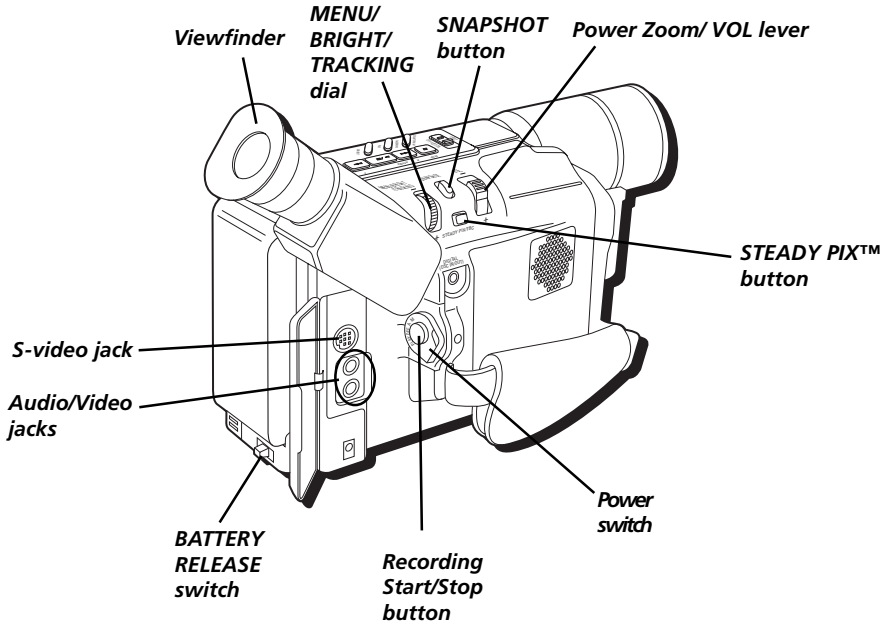

Connections & Setup

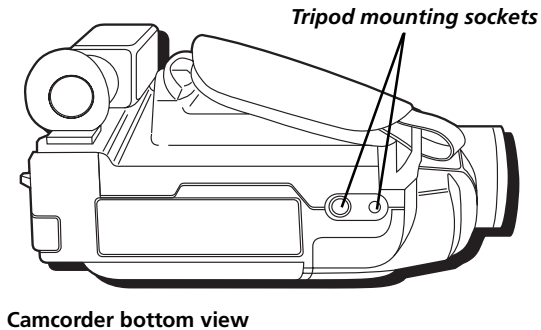
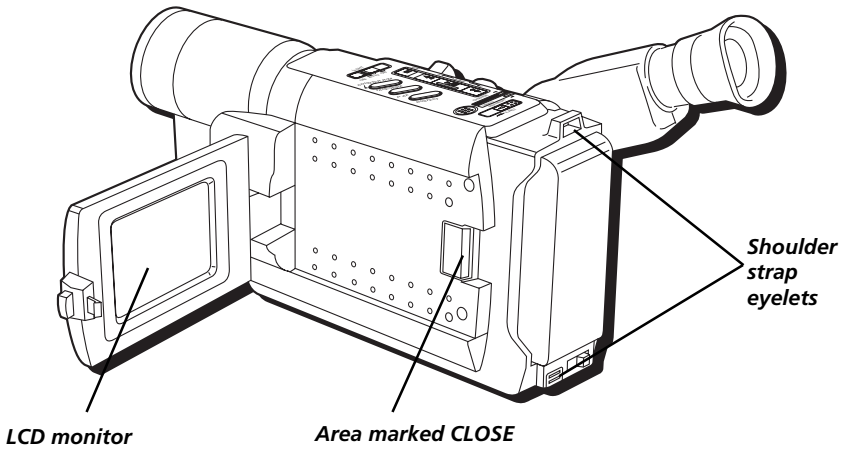
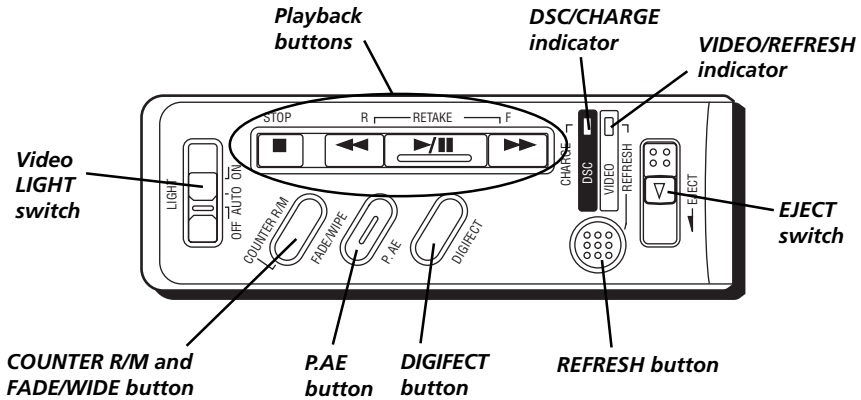

Getting Started

This section describes the basics on how to set up your camcorder to record for the first time. Refer to the other sections for detailed operation and feature options.

Unpack the camcorder and accessories

- The items shown are packed with the camcorder. If any pieces are missing or appear damaged, contact your dealer immediately.
- Remove the plastic film that covers the front and side logos on the camcorder. Use your fingernail, not anything sharp, to remove.
- Save all packing materials and box in case the camcorder ever needs to be shipped or stored.

Adjust the hand strap

1. Lift the flap on the hand strap and separate the Velcro strip.
2. Insert your hand so your fingers can comfortably reach the buttons.
3. Adjust the strap to fit snugly.
4. Refasten the strap, and fold the flap back down.

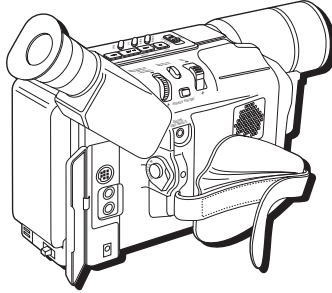

Attach the lens cap

To protect the lens, attach the provided lens cap to the camcorder as shown in the illustration.

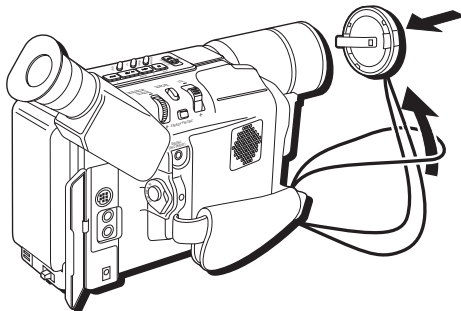

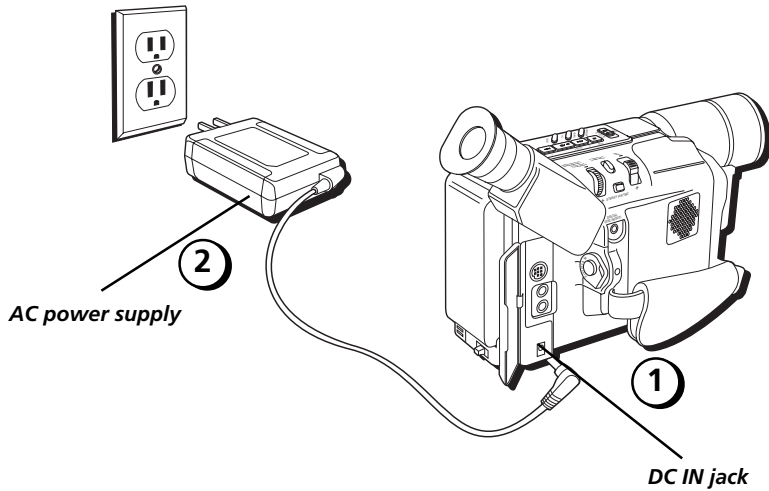

Attach the power supply

Since the battery must be charged before it can be used the first time, you need to use an AC outlet to power the camcorder.

1. Plug the small end of the power supply into the DC IN jack on the camcorder.
2. Plug the other end of the power supply into a working AC outlet.

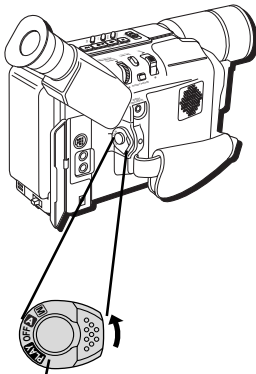

Power switch

Turn on the camcorder

Set the Power switch to the desired setting, either automatic (A) or manual (M) record mode, powered off (OFF), or in playback mode (PLAY).

The VIDEO indicator comes on when the camcorder is turned on.

Automatic recording A places the camcorder into AutoShot™ mode. Focus, exposure, iris control, white balance, and the video light are controlled by the camcorder during automatic recording.

Manual recording mode M allows you to control many of the camcorder's special features, including accessing the menus and setting the clock.

Notes:

- Many special effects don't operate in AutoShot mode (see pages 77-79 for more information).
- The camcorder automatically turns off to save battery power if you leave it in record-standby mode for more than five minutes. To turn it back on, set the Power switch to OFF, then back to automatic or manual record mode.

VIDEO indicator

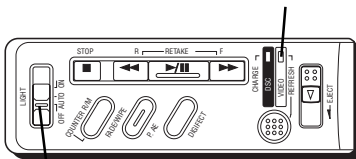

Video LIGHT switch

Set the video light (OFF/AUTO/ON) switch to AUTO

Slide the video LIGHT switch to AUTO. In this setting, the video light automatically turns on when more light is needed.

Insert a cassette tape

1. Make sure the camcorder is connected to a power supply.
2. Open the LCD monitor fully or adjust the viewfinder.
3. With the camcorder set to **A** (automatic record), slide the EJECT switch until the cassette tape holder opens. Don't force the camcorder open.
4. Insert a tape with the tape wheel facing up and the tape window facing out.

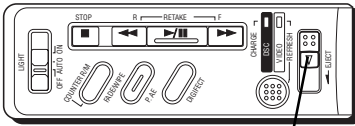

EJECT switch

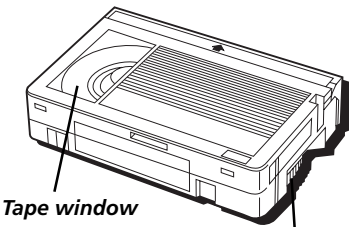

Tape window

Tape wheel

5. Push on the area marked CLOSE until the cassette tape holder locks into place. (PAUSE appears on the LCD or in the viewfinder.)

Notes:

- Make sure the tape is not slack when loading the cassette tape. If there is any slack, turn the wheel on the cassette tape in the direction of the arrow to take up the slack.
- Make sure the Erase Protection tab is in the position that allows recording. If not, slide the tab. Some tapes have removable tabs. If the tab has been removed, cover the hole with adhesive tape.

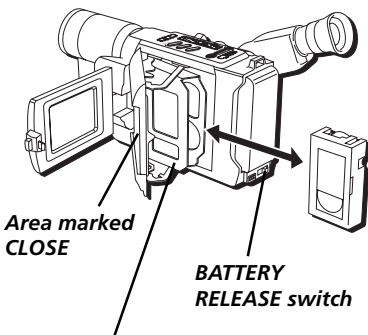

Area marked CLOSE

BATTERY RELEASE switch

Cassette tape holder

Caution: Closing the LCD monitor while the cassette tape holder is still open may damage the LCD monitor.

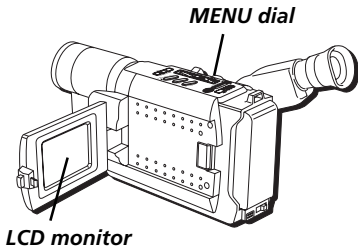

Use the LCD monitor or viewfinder to see what's recording

Using the LCD monitor

1. Remove the lens cap.
2. Open the monitor 90° from the camcorder body.
3. Tilt the monitor 180° forward or 90° down as required for convenient viewing while recording.
4. To adjust the brightness of the LCD monitor, rotate the MENU dial.

Notes:

- *Adjusting the LCD monitor brightness does not affect the recorded image on the tape.*
- *When the LCD monitor opens more than 25°, the viewfinder automatically turns off. When the LCD monitor is closed, the viewfinder automatically turns on.*

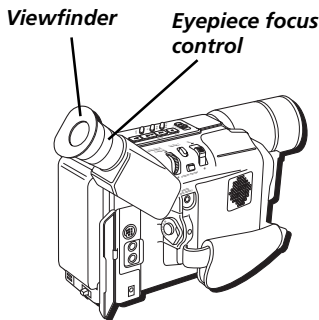

Using the viewfinder

1. Remove the lens cap.
 2. Close the monitor.
- Note:** *If the monitor is open more than 25°, the viewfinder turns off.*
3. Adjust the viewfinder to a comfortable position.
 4. Turn the eyepiece focus control to adjust the focus of the viewfinder for your vision.

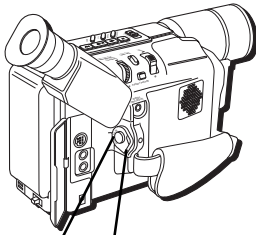

Recording Start/Stop button

Power switch

Start recording

1. Remove the lens cap.
2. Set the Power switch to **A** (automatic record). (The VIDEO indicator comes on.)
3. Press and release the Recording Start/Stop button to start recording. **REC** (▶▶) appears in the viewfinder or LCD monitor (but won't show up in the recording)).
4. When finished recording, press and release the Recording Start/Stop button again to stop recording. The camcorder is now in the record-pause mode. (**PAUSE** appears in the viewfinder or on the LCD monitor.)

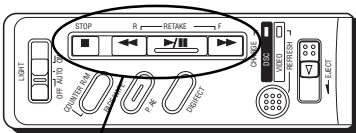

Playback buttons on top of the camcorder include:

- Stop** (■),
Rewind (◀◀)
Play/Pause (▶/||)
Fast Forward (▶▶).

Play your recording

1. Set the Power switch to **PLAY**. (The VIDEO indicator comes on.)
2. Press the Rewind button ◀◀ to reverse the tape to the beginning. When rewound completely, the camcorder automatically stops.
3. Press the Play/Pause button ▶/|| to start playback. View the recording using the LCD monitor or viewfinder.
4. Press the Stop button ■ when finished playing the tape.

Notes:

- *Sound will play back if the LCD monitor is open or closed. To adjust the volume, use the Zoom Lever (also labeled VOL - +).*
- *More information about using the LCD monitor and viewfinder can be found on pages 28-29.*

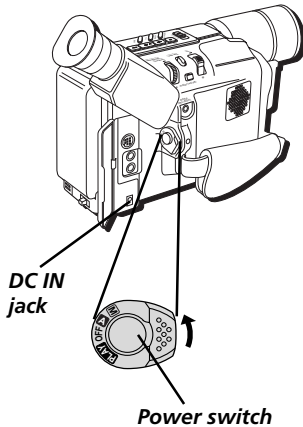

Turn off the camcorder

1. Set the Power switch to OFF.
2. Close the LCD monitor.

Powering the Camcorder

You can power your camcorder with a battery or AC power.

Charging the Battery

1. Set the Power switch to OFF.
2. Make sure the battery is attached to the camcorder. Hook the top end of the battery to the camcorder and push the battery in until it locks in place.

Important: If the battery pack is attached in the wrong position, a malfunction may occur.

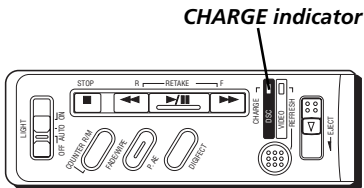

3. Plug the small end of the power supply into the DC IN jack on the camcorder and the other end into an AC outlet. (The CHARGE indicator blinks.)
4. When the CHARGE indicator stops blinking but stays on, charging is finished. Make sure the Power switch is set to OFF, then unplug the power supply from the AC outlet and from the camcorder.

Important: Before detaching the power source, make sure the camcorder's power is turned off. Failure to do so can result in a camcorder malfunction.

Tip

Before extended use, it is recommended that you prepare enough battery packs to cover 3 times the planned shooting time.

Notes:

- If a protective cap is on the battery, remove it before use or charging.
- When charging a battery for the first time or after a long storage period, the CHARGE indicator may not come on. Remove the battery and try again.
- Charge the battery in temperatures between 50° and 90° Fahrenheit (10-35° Celsius).
- Charging times are based on a fully discharged battery and vary depending on ambient temperature and battery condition.

Approximate charging time

Battery	Charging Time
244265 (for CC6384)	approx. 2 hrs. 20 min.
FB1260 (for CC6394)	approx. 90 min.

Approximate recording time (in minutes)

Battery	Viewfinder on	LCD monitor on
244265 (for CC6384)	130, (75*)	105, (60*)
FB1260 (for CC6394)	80, (45*)	65, (35*)

* when the video light is on

Note: Recording time is reduced significantly when you use the Zoom or Record-Standby modes repeatedly or when you use the LCD monitor repeatedly.

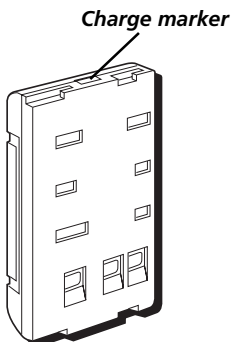
**Using the Charge Marker**

A charge marker is provided on the battery pack to help you remember whether it has been charged or not. Two colors are provided (red and black)—you choose which one means charged and which means discharged.

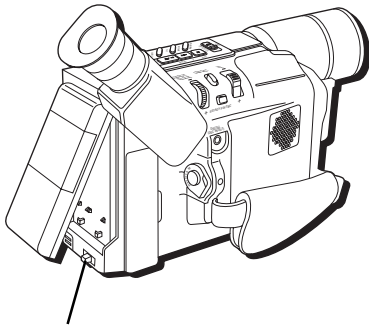

**BATTERY
RELEASE switch**

Removing the Battery

Slide the BATTERY RELEASE switch and pull out the battery pack.

Refreshing the Battery

If you charge a battery before it has been fully discharged, the battery's capacity may be reduced over time. We recommend you discharge or "refresh" your battery before recharging it.

1. Follow steps 1-3 in "Charging the Battery" (*see page 16*).
2. Press and hold the REFRESH button for 2 seconds. (The REFRESH indicator blinks. When the battery has been refreshed, charging automatically starts and the CHARGE indicator blinks.)

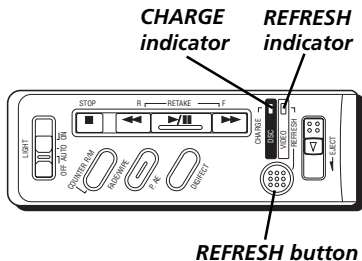

Notes:



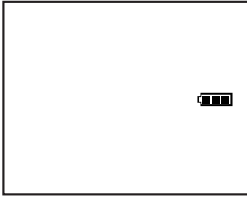

- If you store a partially charged battery for a long period of time, its performance is reduced.
- During charging or discharging, the camcorder can't be operated.
- Charging and discharging isn't possible if the wrong type of battery is used.
- If the battery operation time remains extremely short even after having been fully charged, the battery is worn out and needs to be replaced. Please purchase a new one.



Battery Level Icon

The battery level icon appears in the viewfinder or LCD monitor and reveals the amount of power left in the rechargeable battery.

Note: *The battery level icon is not recorded on the tape.*

-  This icon appears when battery is fully charged.
-  The icon changes to show that you've used some of the battery's power.
-  As you use more of the battery's power, the icon changes again.
-  This battery icon flashes in the viewfinder or LCD monitor when the battery power is almost gone. The camcorder turns off automatically after a few seconds.

Battery Care and Storage

- After repeated charging and use, battery life gradually decreases. When operation time is too short to be useful, the battery should be replaced.
- If the battery pack becomes too hot, remove it from the camcorder and let it cool down.
- Do not short the battery's terminals.
- Do not attempt to disassemble or modify the battery. There are no user-serviceable parts inside.
- Use the battery only with specified adapter/chargers and camcorders.
- Throwing the battery into a fire or exposing it to excessive heat – over 149°F (65°C) could be hazardous.

ATTENTION: The EPA certified RBRC® Battery Recycling Seal on the nickel-cadmium (Ni-Cd) battery indicates Thomson Consumer Electronics is voluntarily participating in an industry program to collect and recycle these batteries at the end of their useful life, when taken out of service in the United States or Canada. The RBRC® program provides a convenient alternative to placing used Ni-Cd batteries into the trash or the municipal waste stream, which may be illegal in your area. Please call 1-800-8-BATTERY™ for information on Ni-Cd battery recycling and disposal bans/restrictions in your area. Thomson Consumer Electronics' involvement in this program is part of our commitment to preserving our environment and conserving our natural resources.



Connections & Setup

Using the Power Supply

The power supply attaches to the camcorder and lets you power it directly from standard household power. The power supply operates on 110-240 volts, 50/60 Hz, so it can be used virtually anywhere in the world to power the camcorder or recharge the battery.

1. Plug the small end of the power supply into the DC IN jack on the camcorder.
2. Plug the other end of the power supply into a working AC outlet (110-240V, 50/60Hz).

Caution: Never use this power supply for any purpose other than charging the FB1260 or supplying power to the camcorder.

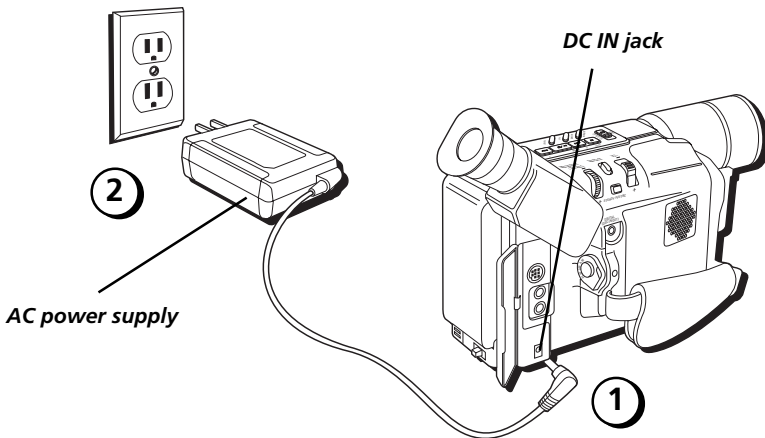

Removing the power supply

1. Make sure the Power switch is set to OFF.
2. Unplug the power supply from the AC outlet.
3. Unplug the small end of the power supply from the DC IN jack on the camcorder.

Important: Before detaching the power source, make sure the camcorder's power is turned off. Failure to do so can result in a camcorder malfunction.

Using an Optional Plug Adapter in Foreign Countries

An optional plug adapter might be required in some countries.

1. Plug the power supply's plug into the AC plug adapter.
2. Plug the AC plug adapter into the AC outlet.

Using the Shoulder Strap

The camcorder's shoulder strap is designed to let you carry the camera from your shoulder and – when ready– bring the camcorder to shooting position in one quick movement.

1. Following the illustration, thread the strap through the eyelet.
2. Fold the strap back and thread it through the buckle.
3. Repeat the procedure to attach the other end of the strap to the other eyelet located under the hand strap. Make sure the strap is not twisted.

Caution: When carrying the camcorder with the shoulder strap, you should close the LCD monitor and rotate the viewfinder down. This helps prevent possible damage to the monitor or viewfinder from bumping against your body as you move. Make sure the shoulder strap is firmly attached before using it to carry the camcorder.

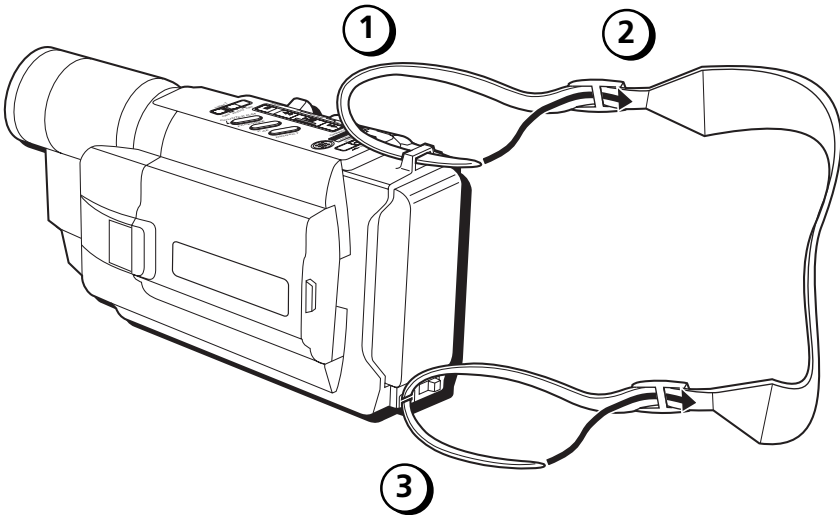

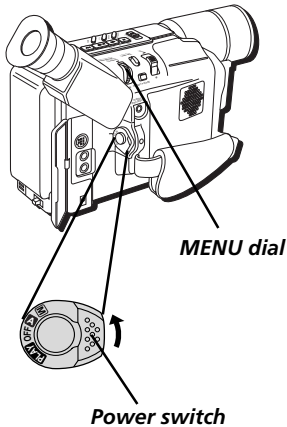

Setting the Date and Time

You need to set the date and time before they can be displayed.

Date and time information is recorded onto the tape at all times, but its display can be turned on or off during playback (see page 89).

1. Set the Power switch to (manual record). (The VIDEO indicator comes on.)
2. Press in the MENU dial. (The *CAMERA MENU* appears.)
3. Rotate the MENU dial to highlight *TO SYSTEM MENU*. Press in the MENU dial to select it. (The *SYSTEM MENU* appears.)
4. Rotate the MENU dial to highlight *NEXT*. Press in the MENU dial to select it. (The second page of the *SYSTEM MENU* appears.)
5. Rotate the MENU dial to highlight *DATE/TIME*. Press in the MENU dial to select it. (The *DATE/TIME* menu appears.)
6. Rotate the MENU dial to the item you want to change (year, month, day, and time). Press in the MENU dial to select it. When the setting starts blinking, rotate the MENU dial to adjust it. When the correct setting appears, press in the MENU dial to select it.
7. When finished, rotate the MENU dial to select *EXIT*. Then press in the MENU dial twice.

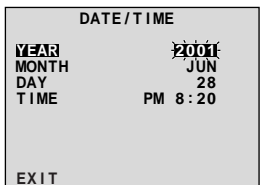
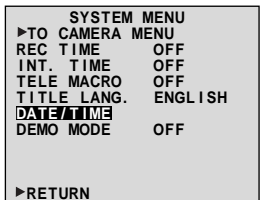
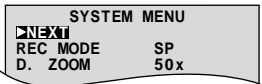

Note: To make the date and time appear in the camcorder's display or on the TV, see page 89.

Important: A separate internal battery is used for the time and date. Under normal conditions, this battery should last for 10 years or more. If you should need to replace it, see your nearest RCA authorized service center.

Setting the Recording Format (for CC6394 only)

You need to select what kind of tape you are using or type of recording you wish to perform.

1. Set the Power switch to (manual record). (The VIDEO indicator comes on.)
2. Press the MENU dial in. (The *CAMERA MENU* appears.)
3. Rotate the MENU dial to highlight *TO SYSTEM MENU*. Press in the MENU dial to select it. (The *SYSTEM MENU* appears.)
4. Rotate the MENU dial to highlight *S-VHS ET*. Press the MENU dial to select it. (The *S-VHS ET* menu appears.)
 - If you are using a standard VHS-C tape, rotate the MENU dial to *S-VHS ET*. Press in the MENU dial to select it.
 - If you are using an S-VHS tape, rotate the MENU dial to *S-VHS*. Press in the MENU dial to select it.
5. Rotate the MENU dial to *ON* if you want to record in S-VHS mode, or *OFF* if you want to record in standard VHS mode. Press the MENU dial to select it.

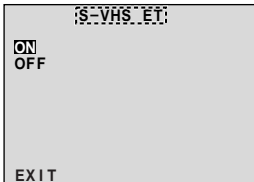
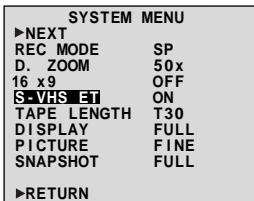

ON Records with S-VHS picture quality on a VHS-C tape. This is called Super VHS ET (Expansion Technology). Also records in S-VHS when you are using an S-VHS tape.

OFF Factory preset: records in VHS.

Notes:

- When the S-VHS ET mode is engaged, S-ET is displayed.
- During S-VHS record mode, S is displayed.
- When S-VHS ET or S-VHS recording starts, S-VHS REC is displayed for approximately 3 seconds.
- If a tape is not loaded, S-VHS is displayed.

Additional Notes about S-VHS and S-VHS ET Cassette Tapes

- *Use S-VHS tapes for storing recordings for an extended period or for recording important scenes, as they enable higher-quality recording and playback.*
- *With some tapes, better picture quality may not be obtained even with S-VHS ET recording. It is recommended that you do a test recording beforehand to ensure if better results can be obtained.*
- *If the S-VHS ET mode or recording format is switched during recording, the playback picture will be blurred at the switching point.*
- *Noise may appear on-screen when tapes recorded in the SLP mode are played back.*
- *Tapes recorded in S-VHS or S-VHS ET mode can be played back not only on this camcorder but also on a Super VHS VCR, an S-VHS ET VCR, or a VCR equipped with the SQPB (S-VHS QUASI PLAYBACK) function.*
 - *When tapes recorded in S-VHS or S-VHS ET mode are played back on a VCR equipped with the SQPB (S-VHS QUASI PLAYBACK) function, S-VHS picture quality is not available.*
 - *Tapes recorded in S-VHS or S-VHS ET mode may not play back on some VCRs.*
 - *It is recommended to specifically label S-VHS ET recordings so you can easily distinguish them from regular VHS recordings.*
- *To avoid on-screen noise, do not perform Still Playback or Shuttle Search repeatedly.*
- *The S-VHS ET (extended technology) feature does not work with S-VHS tapes.*

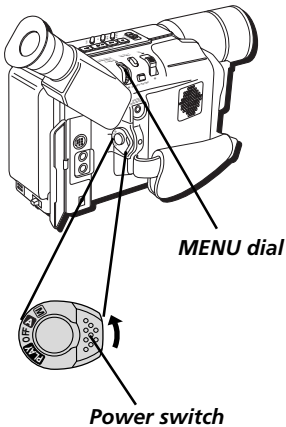

Setting the Tape Recording Speed

You need to select the tape recording speed for the quality of recording you want.

1. Set the Power switch to  (manual record). (The VIDEO indicator comes on.)
2. Press the MENU dial in. (The *CAMERA MENU* appears.)
3. Rotate the MENU dial to highlight *TO SYSTEM MENU*. Press in the MENU dial to select it. (The *SYSTEM MENU* appears.)
4. Rotate the MENU dial to highlight *REC MODE*. Press in the MENU dial to select it. (The *REC MODE* menu appears.)
5. Rotate the MENU dial to highlight *SP* if you want the best recording quality, or *SLP* if you want a lesser-quality recording which provides three times the recording time as SP. Press in the MENU dial to select it.
6. When finished, press in the MENU dial again to exit.

VIDEO indicator

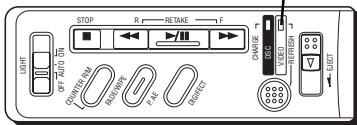

Note: *If the recording speed is switched during the recording, the playback picture will be blurred at the switching point.*

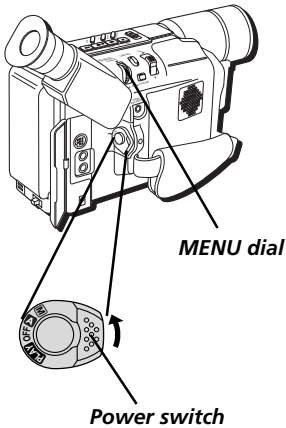

Setting the Tape Length

You need to select the tape length so that the camera can alert you how much time you have left on the tape.

1. Set the Power switch to  (manual record). (The VIDEO indicator comes on.)
2. Press the MENU dial in. (The *CAMERA MENU* appears.)
3. Rotate the MENU dial to highlight *TO SYSTEM MENU*. Press in the MENU dial to select it. (The *SYSTEM MENU* appears.)
4. Rotate the MENU dial to highlight *TAPE LENGTH*. Press in the MENU dial to select it. (The *TAPE LENGTH* menu appears.)
5. Rotate the MENU dial to highlight the length of the tape you are using (T20, T30, T35, T40). (T20=20 minutes, T30=30 minutes, etc. in SP mode.) Press in the MENU dial to select it.
6. When finished, press in the MENU dial again to exit.

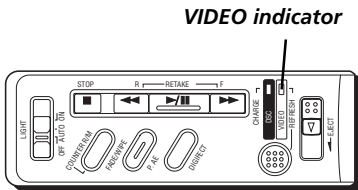

Note: The tape remaining time feature is accurate only if the correct tape length has been selected.

Using the Monitors

Chapter Overview:

- Seeing What You Are Recording
- On-screen Icons

Changing Entertainment. Again.



Seeing What You Are Recording

To see what is recording, use either the LCD monitor or the viewfinder monitor. When the LCD monitor is open more than 25°, the viewfinder turns off. When you close the LCD monitor, the viewfinder turns on.

Using the LCD Monitor

The camcorder's LCD monitor is a miniature color screen that you can use for recording playback.

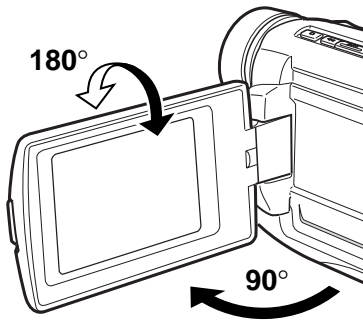

1. Open the LCD monitor at least 25°. The viewfinder turns off.
2. For convenient viewing, the LCD monitor can be tilted once it is open 90° from the camera body. Tilt the monitor forward up to 180° or down up to 90°.
 - From a high angle (such as over a crowd)—tilt the monitor down to record.
 - From a low angle (such as when kneeling)—tilt the monitor up to record.
3. Adjust the brightness of the LCD monitor by turning the bright control (MENU dial). This doesn't affect the brightness of the recording you are making.
 - Turn the dial toward + to brighten the image.
 - Turn the dial toward – to darken the image.
4. When finished recording, close the monitor and lock it into place.

Note: Recording outdoors on bright, sunny days can make the LCD monitor hard to see. Use the viewfinder instead.

Cautions

Never force the LCD monitor to rotate completely around. This could damage both the monitor and/or the camcorder.

When carrying the unit with the shoulder strap, close the monitor to prevent possible damage to it.

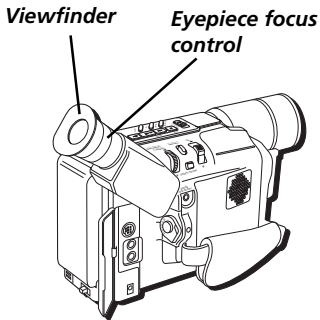

Using the Viewfinder

The camcorder's viewfinder is a miniature monitor that displays in black and white (color for the CC6394). For convenient viewing, rotate the viewfinder up or down.

Note: When the LCD monitor is open more than 25°, the viewfinder turns off.

Eyepiece Focus Control

The eyepiece focus control lets you set the focus of the viewfinder for your vision. If you wear eyeglasses, you probably can operate the camcorder without them.

It is easiest to set the correct focus by focusing on one of the viewfinder's on-screen displays. Look through the viewfinder and adjust the eyepiece focus control for your vision.

Note: The eyepiece focus control does not affect the focus of the image captured by the camcorder.

Cautions

Never force the viewfinder to rotate completely around. This will damage the viewfinder and/or the camcorder.

When carrying the camcorder with the shoulder strap, put the viewfinder down to help prevent possible damage to it.

Using the Monitors

On-screen Icons

Several displays appear on the LCD monitor or in the viewfinder to aid in the operation of the camcorder. Although it may look crowded, all of the icons shown below do not appear on-screen at the same time. Also, not all screen icons are shown in the illustration. Refer to the icon descriptions that follow.

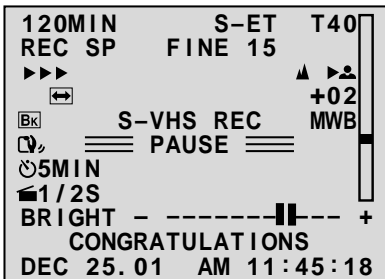

Recording Menu Icons

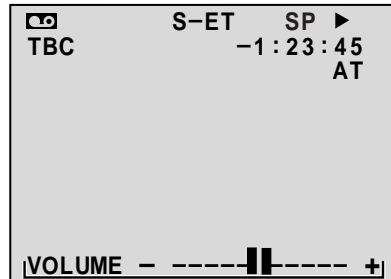

Playback Menu Icons

*S-VHS and S-VHS ET icons are for the CC6394 only.

Warning Icons



Indicates the amount of power left in the rechargeable battery.



An empty battery icon flashes on screen when the battery's power is almost exhausted.



Missing Cassette: Appears when the Power switch is set to either **A** or **M** (automatic or manual record) and no cassette tape is in the camcorder.



Head Cleaning: *HEAD CLEANING REQUIRED USE CLEANING CASSETTE* appears if dirt is detected on the recording heads. Use an optional cleaning cassette to remove dirt.



Condensation: *CONDENSATION, OPERATION PAUSED PLEASE WAIT* appears if moisture occurs inside the camcorder. When this icon appears, wait at least one hour before using the camcorder again.

TAPE END **End of Cassette:** Appears when a tape reaches its end during recording or playback.

LENS CAP **Covered Lens:** Appears briefly after the power is turned on to either automatic or manual record mode and the lens cap is still attached.

E01-E06 **Safeguard:** The error icons (E01-E06) show what type of malfunction has occurred. If an error icon and warning appear, turn the unit off, remove the power supply (battery, etc.) and wait a few minutes for the warnings to clear. If they do, you can resume using the camcorder. If the warnings remain, consult your nearest RCA authorized service center.

Recording and Playback Icons







Auto Date, Date, Time, or Date and Time Icons

DEC 25. 01 Indicates the current date and time and is recorded when they are displayed (*see page 89*).

AM 11:45:18

Using the Monitors

Special Effect Icons

-  **SEPIA** Appears when you select *SEPIA* to give your recordings a brown-tone like old photographs.
-  **SPORTS** Appears when you select *SPORTS* to record fast-moving action, such as sporting events.
- SD:SHADOW** Appears when you select *SD:SHADOW* to darken the picture and reduce glare.
- HZ: HAZE** Appears when you select *HZ:HAZE* to soften the picture and give it a misty white effect.
-  **TWILIGHT** Appears when you select *TWILIGHT* to record scenes at twilight, fireworks, etc.
-  **2**
S1/2000 Appears when you select *1/2000* to record faster-moving action than the *SPORTS* mode.
-  **NEGA POSI** Appears when you select *NEGA POSI* to reverse the colors and create a negative image.
-  **MOSAIC** Appears when you select *MOSAIC* to record scenes in a mosaic pattern.
-  **STRETCH** Appears when you select *STRETCH* to record scenes which are double the horizontal width of the picture.
- B/W**
MONOTONE Appears when you select *B/W MONOTONE* to record scenes in classic black and white.

Preset Titles

- The preset title selected in the *TITLE* menu appears here. It will be recorded on the tape when it appears.

M. W. B. (Manual White Balance) Icons

The icon for the manual white balance selected in the *M.W.B.* menu appears here.



Appears when you select  :*FINE* to record outdoors on a sunny day.



Appears when you select  :*CLOUD* to record outdoors on a cloudy day.



Appears when you select  :*HALOGEN* to record using halogen or tungsten lighting.

MWB

MWB appears when you select *MWB* to adjust the color temperatures.

Status Icons



Appears when the camcorder is recording.



Appears during record-standby.



Appears when the camcorder plays a tape.



Appears during play-pause.



Appears during fast forward and flashes during forward search.



Appears during rewind and flashes during reverse search.

Tracking Icons

AT

Appears during automatic tracking.

MT

Appears during manual tracking.

Using the Monitors

Zoom Icon



Appears when you use the zoom lever.

Bright and Volume Icons

BRIGHT

Appears when you adjust the brightness of the monitor with the BRIGHT dial.

VOLUME

During playback, the *VOLUME* icon appears when you adjust the volume of the speaker with the VOL control (also zoom lever).

Exposure Icon



This icon appears when you are adjusting brightness manually using the *EXPOSURE* menu.

Fade and Wipe Icons

Press the FADE/WIPE button to display the icon for the fade or wipe you want to select.



Appears when you select black fade.



Appears when you select mosaic fade.



Appears when you select shutter wipe.



Appears when you select slide wipe.



Appears when you select door wipe.



Appears when you select corner wipe.



Appears when you select window wipe.

Focus Icons





Appear when you are adjusting focus manually using the *FOCUS* menu. The icons also flash when the auto-focus system cannot operate properly or you can't adjust the focus any farther.

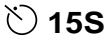

These icons flash while you adjust manual focus (*see page 86*).

Animation and Time-Lapse Recording Icons



Appears when you select the interval time for time-lapse recording ( *15S*, *30S*, *1MIN*, or *5MIN*; *15S=15 seconds*, *30S=30 seconds*, etc.).



Appears when you select the recording time for animation or time-lapse recording ( *1/4S*, *1/2S*, *1S*, or *5S*; *1/4S=1/4 of a second*, *1/2S=1/2 of a second*, etc.) (*see pages 91-92*).

Other Icons

Steady Pix Icon



Appears when you are using Steady Pix (*see page 41*).

Tape Length Icon



Indicates what tape length you have selected (*T20*, *T30*, *T35*, or *T40*; *T20=20 minutes*, *T30=30 minutes*, etc.) (*see page 26*).

Tape Speed Icon



Indicates what tape speed you have selected (*SP/SLP*) (*see page 25*).

Using the Monitors

TBC (Time Base Corrector) Icon

TBC Appears when the time base corrector is turned on (*see page 48*).

Time Counter Icon

M0:00:00 Appears during playback. It is not recorded. An *M* appears in front of the time counter when memory-stop is on (*see page 49*).

Time-Remaining Icon

120MIN Indicates the approximate time remaining on the tape.

Picture Quality Icon

FINE 30 Indicates the quality of picture you have selected and the number of pictures remaining for that quality (*see page 59*).

Snapshot Icon

P Indicates the type of snapshot selected (other than *FULL*) (*see page 60*).

- *P* is displayed for *PIN-UP*.
- *M4* is displayed for *MULTI-4*.
- *M9* is displayed for *MULTI-9*.

Recording

Chapter Overview:

- Recording Details
- Recording Tips

Changing Entertainment. Again



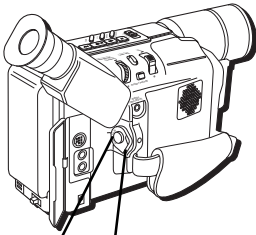

Power switch

Recording Start/
Stop button

Recording Details

1. Remove the lens cap.
2. Set the Power switch to **A** or **M** (automatic record or manual record mode). (The VIDEO indicator comes on.)
3. Open the LCD monitor or adjust the viewfinder.
4. Press and release the Recording Start/Stop button to start recording. (▶▶▶ appears in the viewfinder or LCD monitor (but won't be recorded.))
5. When finished recording, press and release the Recording Start/Stop button again to stop recording. The camcorder is now in the record-pause mode. (PAUSE appears in the viewfinder or on the LCD monitor.)

VIDEO indicator

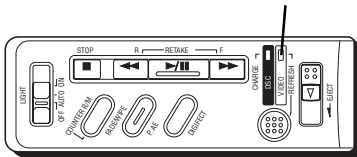

Notes:

- If the Record-Standby mode continues for 5 minutes without performing Zoom or any other operations, the camcorder's power shuts off automatically. Set the Power switch to OFF, and then back to **A** or **M** to turn the camcorder on again.
- If you are recording on a tape from the middle (such as when a tape is removed and reinserted during recording), use the Retake function (see page 39) to find the end of the last recording so you do not erase any of it.
- To remove the icons from the camcorder's display during recording, see page 78.

Journalistic Shooting

In some situations, different shooting angles may provide more dramatic results. Hold the camcorder in the desired position and tilt the LCD monitor in the most convenient direction. It can rotate 270° (90° downward, 180° upward).

Self-Recording

You can shoot yourself while viewing your own image in the LCD monitor. Open the LCD monitor and tilt it upward 180° so that it faces forward, then point the lens toward yourself and start recording.

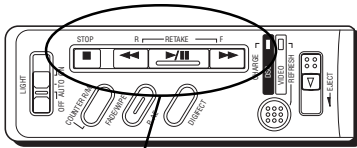

Rewind and RETAKE buttons

Quick Review

You can check the end of the last recording.

1. Make sure the camcorder is in the Record–Standby mode.
2. Press ◀◀ and release quickly. (The tape is rewound for approximately 2 seconds and played back automatically, then pauses in Record–Standby mode for the next shot.)

Note: Distortion may occur at the start of playback. This is normal.

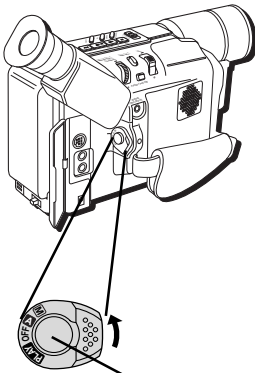

Recording Start/Stop button

Retake

You can also rerecord certain segments.

1. Make sure the camcorder is in the Record–Standby mode.
2. Press and hold either RETAKE button to reach the start point for new recording. Pressing ▶▶ forwards the tape and pressing ◀◀ reverses it.
3. Press the Recording Start/Stop button to start recording.

Note: Noise bars appear and pictures may become monochrome or darken during Retake. This is normal.

Digital and Optical Zooming

You can zoom in and out for close-up or wide-angle shots by moving the zoom lever on the camcorder. The camcorder automatically focuses at most distances when zooming. Optical zooming is possible up to 16 times, and digital zooming allows up to 400 times normal magnification.

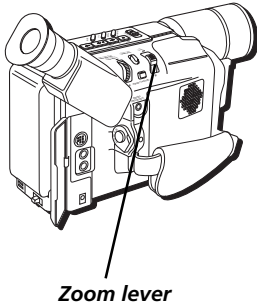

Using the Zoom Lever (*W* and *T*)

To zoom in tight (telephoto) or out wide (wide angle), rotate the zoom lever to either *T* or *W*.

With telephoto zooming it is possible to capture images to a maximum of 400 times normal magnification. To do this, the camcorder uses technology to artificially enhance the image.

Optical zoom is the natural, non-enhanced magnification that the camcorder's lens will support. This camcorder has an optical zoom of 16 times (16X).

When using the zoom lever, an icon appears on screen to display the approximate zoom ratio.

Notes:

- *While zooming, focusing may become unstable. If so, set the zoom while in record-standby mode and adjust the image using manual focus (see page 86). Once the focus is set, zoom the camcorder in or out while recording.*
- *The zoom level icon moves during zoom. Once it reaches the top of the zoom icon bar, all magnification from that point is through digital processing.*
- *During digital zoom, the quality of image may suffer.*

Tip

The further you rotate the zoom lever, the quicker the zoom action.

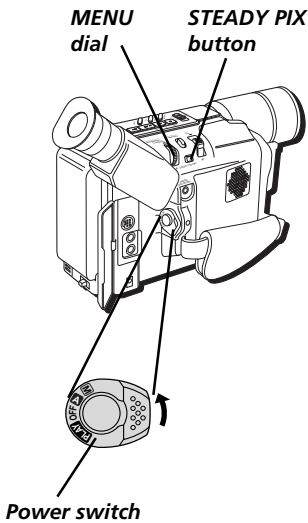

Using Digital Zoom

You can use digital zoom to magnify images to a maximum of 400 times normal magnification.

1. Set the Power switch to  (manual record). If the DSC indicator is on, press REFRESH for approximately 1 second to select VIDEO.
2. Press in the MENU dial. (The *CAMERA MENU* appears.)
3. While *TO SYSTEM MENU* is highlighted, press in the MENU dial again. (The *SYSTEM MENU* appears.)
4. Rotate the MENU dial to highlight *D. ZOOM*. Press in the MENU dial to select it. (The *D. ZOOM* menu appears.)
5. Rotate the MENU dial to highlight the desired setting. Press in the MENU dial to select it.
6. Press in the MENU dial again to exit.

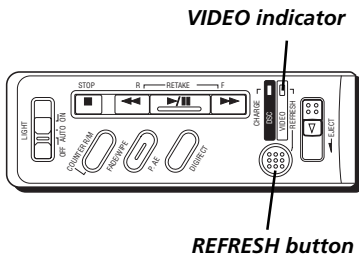

Using Steady Pix™

Digital Image Stabilization is used to compensate for unstable images cause by camera shake, especially at high magnifications.

To turn on image stabilization, press the STEADY PIX button.  appears.)

To turn off image stabilization, press STEADY PIX again. (The icon disappears.)

Notes:

Accurate stabilization may not be possible if hand shake is excessive, or when recording the following:

- *subjects with vertical or horizontal stripes.*
- *dark or dim subjects.*
- *subjects with excessive backlighting.*
- *scenes with movement in various directions.*
- *scenes with low-contrast backgrounds.*

Switch off stabilization when the camcorder is mounted to a tripod.

The  icon blinks or disappears if image stabilization can't be used.

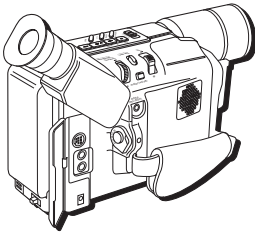

Using the Video Light

To brighten the scene when natural lighting is too dim, the camcorder uses a built-in video light.

You can turn on the video light at all times, set to turn on automatically when the camcorder senses additional light is needed, or turn off altogether.

Set the LIGHT switch as desired:

- OFF** Turns off the light.
- AUTO** Automatically allows the camcorder to turn on the light when there is insufficient lighting on the subject.
- ON** Keeps the light on at all times as long as the camcorder is turned on.

VIDEO indicator

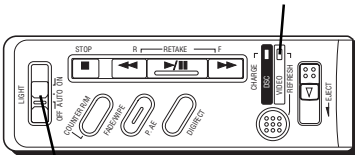

VIDEO light switch

Video Light Details

Even if the battery icon (⏻) doesn't blink due to low battery charge, the camcorder may turn off automatically when you turn on the video light, or if the video light is turned on when you start a recording.

When LIGHT OFF/AUTO/ON switch is set to *AUTO*:

- The video light may keep turning on and off depending on the lighting conditions. If this happens, manually switch the light ON or OFF using the LIGHT OFF/AUTO/ON switch.
- If the Sports or High Speed Shutter mode is turned on, the video light is likely to stay on.
- While in Twilight mode, the light won't activate.

Notes:

- The video light can only be used when the camcorder is on.
- Set the white balance to artificial light (☀️) when using the video light to avoid a "washed-out" look.
- When not using the video light, turn it off to save battery power.

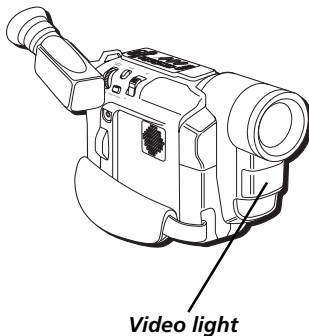

Video light



Cautions

- *Never operate the video light closer than 1 foot to people or other objects.*
- *The video light becomes very hot. Do not touch it during use or right after use. Serious injury may result.*
- *Do not place the camcorder in a carrying case right after using the light.*
- *Never operate the video light close to flammable or explosive material.*
- *Consult your nearest RCA authorized service center to replace the video light.*
- *The video light and bulb need to cool for approximately 30 minutes after use before the bulb assembly is replaced.*

Recording Tips

- To improve picture quality and color reproduction, try to make sure indoor scenes are well-lit.
- Don't move the camcorder rapidly from side-to-side while recording. A steady, gradual "pan" avoids blurring and "jitter".
- Use the viewfinder or LCD monitor to make sure the camcorder is level while recording so that your scene isn't "tilted."
- Do not bump or tap the camcorder's microphone while recording as this sound will be recorded.
- Include close-ups of individuals when taping family outings or group functions.
- Fading in and out of scenes makes your videos appear more professional.
- Learn to use the special effects to add variety to your recordings.
- Be aware of video and audio backgrounds. Background details barely noticed while recording may show up as visual "clutter" on your recording. Background noises (especially TV sets, radios, household appliances, traffic sounds, etc.) might detract from the sound you want to record.
- Avoid long "still" shots of landmarks and scenic attractions. Recordings are more interesting if they include people and details. "Local color" gives travel videos lasting appeal. To add interest, consider recording a familiar or landmark scene from an unfamiliar vantage point.

Playback

Chapter Overview:

- Playback Options
- Choose Your Connection

Changing Entertainment. Again.



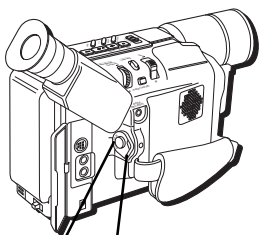

Power switch

Playback Options

The camcorder's playback features include displaying still images and high-speed shuttle search. In this section, you'll also learn how to connect your camcorder to a TV, VCR, or computer.

Playback features (Play, Pause, Forward, Reverse, Stop) can be handled using the camcorder's buttons.

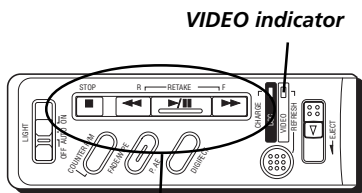

Playback buttons

Basic Playback

1. Insert a tape.
2. Set the Power switch to **PLAY** (playback mode). (The VIDEO indicator comes on.)
3. Press **▶/||** (Play-Pause button) to start playback.
 - To stop playback, press **■** (Stop button).
 - Press **◀◀** (Rewind button) to reverse playback direction, or the **▶▶** (Fast Forward button) to advance the tape while in stop mode.



Notes:

- *If stop mode continues for 5 minutes when power is supplied from a battery, the camcorder shuts off automatically to conserve power. To turn the camcorder on again, set the Power switch to OFF, then to back to **PLAY** (playback mode).*
- *When the Power switch is set to **PLAY** and the LCD monitor is opened at an angle of 25° or more, the LCD monitor switches on and the viewfinder switches off automatically to save power.*

Tips

The playback picture can be viewed in the viewfinder (with the LCD monitor shut), on the LCD monitor, or on a connected TV (see page 54).

You can also view the playback picture on the LCD monitor with it flipped over and retracted.

- If a blank portion on the tape is played back, the screen may become black. This is not a malfunction.
- LCD monitor/viewfinder indications:
 - When power is supplied from a battery,  appears. When power is supplied through the power supply,  does not appear.
 - When a tape is stopped, no icons appear.

BRIGHT dial **VOL lever**

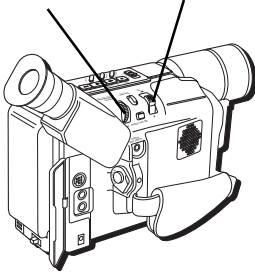

Adjusting the LCD Monitor Brightness

Rotate the BRIGHT dial towards + to brighten, or - to darken.

Controlling Speaker Volume

Slide the Zoom Lever (VOL.-+) towards + to turn up the volume, or towards - to turn down the volume.

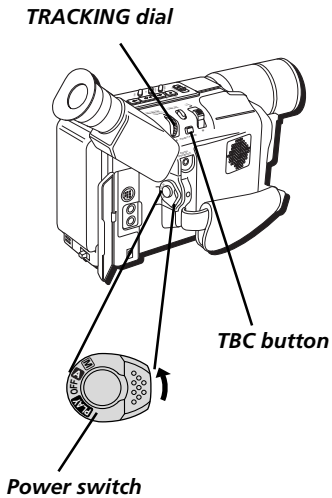

Adjusting the Tracking

You may need to eliminate noise bars that appear on-screen during playback. The default setting is Auto Tracking.

- 1) Press in the TRACKING dial for approximately 2 seconds. (*MT* appears).
 - 2) Rotate the TRACKING dial until the noise bars disappear.
- To return to Auto Tracking, press in the TRACKING dial for approximately 2 seconds or set the Power switch to OFF and then to **PLAY** again. *AT* blinks. (When Auto Tracking finishes, the icon disappears.)
 - When noise bars appear during playback, the camcorder enters the Auto Tracking mode and *AT* appears
 - Manual Tracking may not work with tapes that were recorded on other VCRs or camcorders.

Using TBC (Time Base Corrector)

You may need to remove jitter from fluctuating video signals to deliver a stable picture even with old tapes. The default setting is for TBC to be activated.

To activate the TBC mode, press the TBC button during playback for more than 1 second. (*TBC* appears.)

To deactivate TBC, press the TBC button during playback for more than 1 second. (*TBC* disappears.)

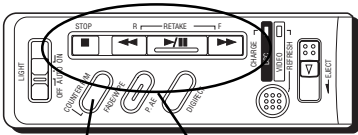

**COUNTER R/M Playback buttons
button**

Using Counter Memory

Counter Memory makes it easier to locate a specific tape segment.

1. Press and hold the COUNTER R/M button for more than 1 second. (The counter resets to 0:00:00.)
 2. Press COUNTER R/M for less than 1 second. (*M* appears.)
 3. After recording or playback, press ■, then ◀◀. (The tape automatically stops at or near 0:00:00.)
 4. Press ▶▶ to start playback.
- The counter memory functions both in the Fast-Forward and Rewind modes.
 - To disable the Counter Memory Function, press COUNTER R/M for less than 1 second until *M* disappears.

Still Playback Mode

Still playback pauses the tape, freezing a single frame.

1. Press the Play/Pause button (▶/||) during playback to freeze the image.
 2. To resume normal playback, press the Play/Pause button again.
- Video “noise” appears on the screen and the picture may become monochrome during still playback. This is normal.
 - If pause continues for more than a few minutes, the camcorder may turn off.
 - After approximately 5 minutes in stop mode, the power turns off automatically.

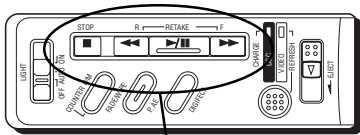

Playback buttons

Shuttle Search

Shuttle search allows high-speed searching in either forward or reverse directions.

1. Press ►► or ◀◀ during playback.
 2. To resume normal playback, press ►||.
- During playback, press and hold ◀◀ or ►►. The search continues as long as you hold down the button. Once released, normal playback resumes.
 - A slight mosaic effect appears on screen during shuttle search. This is normal.
 - Video “noise” appears on the screen and the picture may become monochrome during shuttle search. This is normal.

Choose your Connection

This manual includes information for some basic types of connections. You may also need to refer your TV and VCR user's guides for specific instructions.

Cassette tape adapter

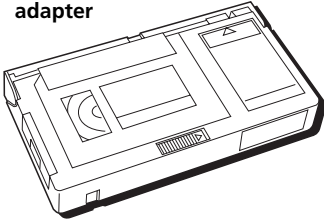

Using the Cassette Tape Adapter

Before choosing a connection, you may find it easier to use the cassette tape adapter.

The camcorder uses a smaller size tape, but records in standard VHS format. The cassette tape adapter allows you to play your VHS-C tapes in a VCR just like other standard VHS tapes.

Insert the VHS-C tape into the cassette tape adapter. Insert the adapter into the VHS VCR like a normal VHS tape.

Battery compartment cover

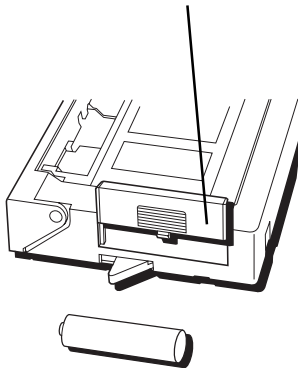

1. Remove battery compartment cover.
2. Install supplied "AA" battery so positive (+) and negative (-) ends align properly with (+) and (-) terminals in battery compartment.
3. Replace battery compartment cover.

Notes:

- *Replace the battery when the load time becomes much longer than normal.*
- *Remove the battery from the cassette tape adapter if it is not used for a month or more. This prevents possible damage from battery leakage. If leakage occurs, wipe up the liquid inside the compartment and replace the battery with a new one.*

VHS-C tape

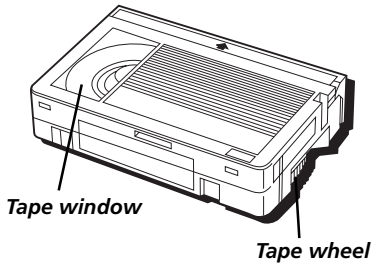

Cassette tape adapter

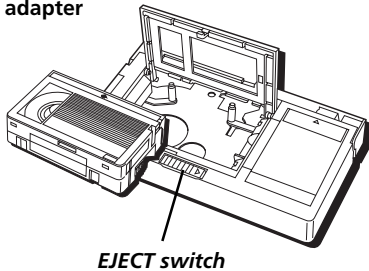

Inserting the Tape into the Cassette Tape Adapter

1. Before inserting the tape into the adapter, remove any slack in the tape by turning the tape wheel on the side of the tape.
2. Slide EJECT to the right to open the tape compartment lid.
3. Insert the tape with the tape window on the left and facing up.

Allow the tape to drop into the adapter. **Do not force the tape.**

4. Gently close the tape compartment lid until it locks into place. Make sure the tape reel area under the adapter is free to turn while the tape is loading.

Note: You should hear a whirring sound while the tape loads.

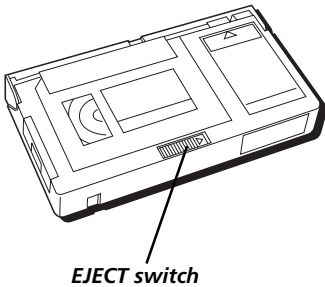

Removing the Tape from the Cassette Tape Adapter

1. Slide the adapter's EJECT switch to the right. The load detector extends from the side and the whirring sound indicates the tape is being released before the adapter's tape compartment lid opens.
2. Use the access hole on the bottom of the adapter to push the tape up and remove it from the adapter.
3. Gently close the adapter's tape compartment lid.

Caution: If the load detector is still extending from the side of the cassette tape adapter after you've attempted to load the tape, loading is not complete. Try to load the tape again. Attempting to insert the cassette tape adapter into a VCR with the load detector extended may cause damage to the adapter and/or VCR.

Caution: Do not touch the reels during loading and unloading. It could cause injury or damage the cassette tape adapter or tape.

Notes:

- *Tapes recorded in S-VHS or S-VHS ET mode cannot be played back on a regular VHS VCR. Playback is possible with a VCR equipped with the S-VHS or SQPB (S-VHS QUASI PLAYBACK) function (CC6394 only).*
- *During special-effect playback (still frame, etc.), the picture may vibrate or noise bars may appear on the screen.*
- *To record on a VCR using a compact tape and the adapter, cover the adapter's recording safety hole with adhesive tape.*

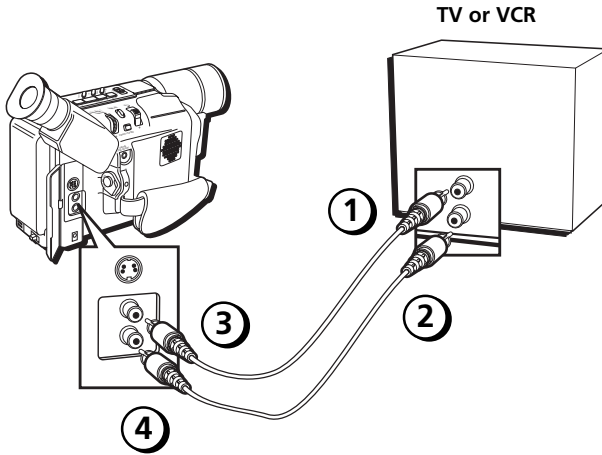

Connecting to a TV (or VCR) with Audio/Video Input Jacks

To connect your camcorder to a TV monitor (or VCR) with audio/video input jacks, you need an optional audio/video cable, such as VH83 (see page 117). If your TV is already connected to a VCR, attach the camcorder to the VCR and watch what the camcorder is recording or playing on the TV.

1. Attach the white plug on one end of the audio/video cable to the AUDIO IN jack on the TV (or VCR).
2. Attach the yellow plug to the VIDEO IN jack on the TV (or VCR).
3. Attach the white plug on the other end of the audio/video cable to the A (audio) jack (located under the small cover) on the side of the camcorder.
4. Attach the yellow plug to the yellow V (video) jack on the camcorder.

Notes:

- If your TV (or VCR) has stereo AUDIO IN jacks, you need a Y-adapter to hear both channels.
- If your TV or VCR has an S-Video input jack, connect the camcorder to the TV or VCR using an optional S-Video cable. This can improve the picture quality (CC6394 only).

Optional S-video and Audio Connection (CC6394 only)

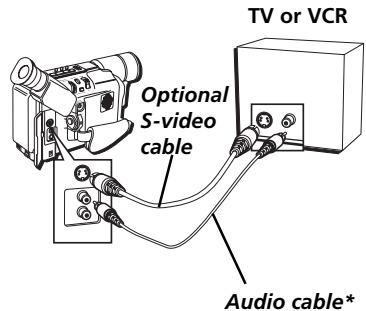

*An audio cable must also be used when using an S-video connection. The S-video cable only transfers video information.

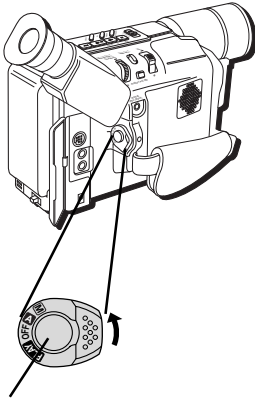

Power switch

Playback on a TV (or VCR) with Audio/Video Input Jacks

1. Turn on the TV and tune it to the video input channel or turn on VCR and place it in the “line” or “camera mode”. (If your VCR does not have a “line” or “camera mode”, consult the VCR owner’s manual.) Operate the TV as you normally do to see the signal coming from the VCR.
2. Set the Power switch to playback **PLAY** mode. (The VIDEO indicator comes on.)
3. Press **▶/||**.
 - During playback, use the playback features (see page 46).
4. Press STOP when you are finished.

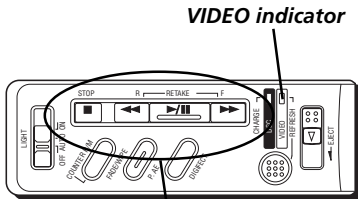

Playback buttons

Notes:

- *It is recommended to use the power supply instead of the battery pack for power to achieve uniform playback.*
- *Adjust the TV sound volume to its minimum level to avoid a sudden burst of sound when the camcorder is turned on.*
- *If you have a TV or speakers that are not specially shielded, do not place the speakers next to the TV as interference will occur in the camcorder playback picture.*
- *To view the picture and sound from the camcorder without recording, set the camcorder's Power switch to **A** or **M**, then set your TV to the appropriate input mode.*

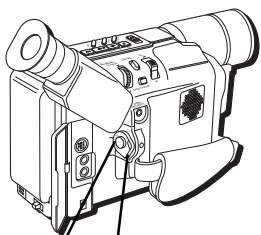

Power switch

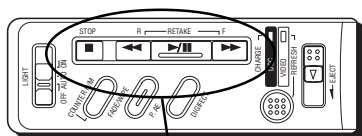

Playback buttons

Tape Dubbing

1. Following the illustration in this chapter, connect the camcorder and the VCR.
2. Set the camcorder's Power switch to **PLAY**, turn on the VCR's power, and insert the appropriate tapes in the camcorder and the VCR.
3. Make sure the VCR is in the appropriate AUX mode and the Record-Pause mode.
4. Use the camcorder's Play mode to find a spot just before the edit-in point. Once it is reached, press **▶/||** on the camcorder.
5. When you're ready to start recording, press **▶/||** on the camcorder and press the appropriate record button on the VCR.
6. When you want to stop recording, press the VCR's pause button and press **▶/||** on the camcorder.
7. Repeat steps 4 through 6 for additional editing, then stop the VCR and camcorder when finished.

Note: If you wish to dub still images recorded with the DSC indicator on, play back the still images, and instead of doing the above steps 4 through 6, engage the VCR's Record mode

Digital Still Camera

Chapter Overview:

- Digital Still Camera Recording and Playback
- System Requirements for Picture Navigator
- Connecting to a Windows® PC

Changing Entertainment. Again.



Digital Still Camera Recording and Playback

When using the Digital Still Camera (DSC) feature, still pictures are recorded in the camcorder's built-in memory. These pictures can be transferred to a PC, saved, and edited using the included cable and software.

You can choose the quality of the pictures you want to record and four types of snapshots. These snapshots can be viewed, protected, and deleted from memory.

Note: *Some sample pictures have been stored in memory, and you can use the delete function to remove them.*

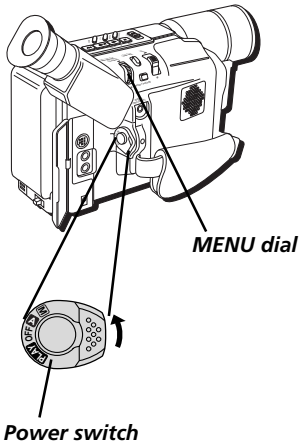

Setting the Picture Quality

You can adjust the picture quality to fine or standard, depending on what kind of picture you want. Because standard quality pictures take up less memory, the camera can store more of them than in fine mode.

1. Set the Power switch to  (manual record). (The VIDEO indicator comes on.)
2. Press the MENU dial in. (The *CAMERA MENU* appears.)
3. Rotate the MENU dial to highlight *TO SYSTEM MENU*. Press in the MENU dial to select it. (The *SYSTEM MENU* appears.)
4. Rotate the MENU dial to highlight *PICTURE*. Press in the MENU dial to select it. (The *PICTURE* menu appears.)
5. Rotate the MENU dial to highlight *FINE* or *STANDARD*.

VIDEO indicator

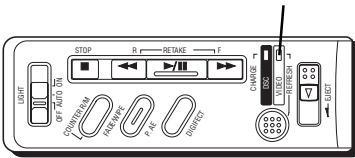

Note: The number of storable images depends on the selected picture mode as well as the composition of the subjects in the images.

Picture Quality Mode	Approx. Number of Storable Pictures*
<i>FINE</i>	30
<i>STANDARD</i>	60

* The numbers listed above are applicable when the camcorder's memory is empty (when there are no sample snapshots stored).

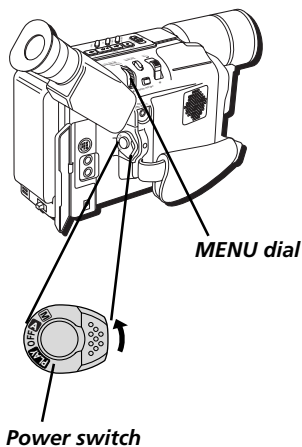

Selecting a Snapshot Mode

You can choose from 4 ways to display your digital pictures, including full, pin-up, multi-4, and multi-9.

1. Set the Power switch to  (manual record). The VIDEO or DSC indicator comes on.
2. If the DSC indicator is not on, press the REFRESH button for approximately 1 second. (The DSC indicator comes on.)
3. Press the MENU dial in. (The *CAMERA MENU* appears.)
4. Rotate the MENU dial to highlight *TO SYSTEM MENU*. Press in the MENU dial to select it. (The *SYSTEM MENU* appears.)
5. Rotate the MENU dial to highlight *SNAPSHOT*. Press in the MENU dial to select it. (The *SNAPSHOT* menu appears.)
6. Rotate the MENU dial to highlight the type of snapshot you want to take.

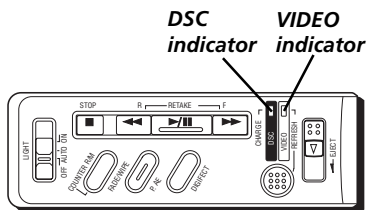



- Select *FULL* to take a full screen snapshot with no frame.



- Select *PIN-UP* to have the snapshot framed like a picture.

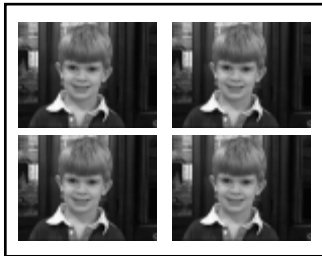

- Select *MULTI-4* to take four snapshots in a quick progression (giving the illusion of movement) and place all four snapshots within one shot.

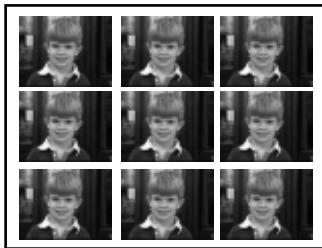

- Select *MULTI-9* to take nine snapshots in a quick progression (giving the illusion of movement) and place all nine images within one shot.

Note: *Snapshots taken in a dark area may become coarse and lose their true colors.*

SNAPSHOT button

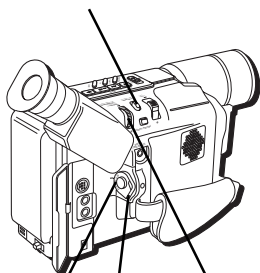

MENU dial

Power switch

Taking Snapshots

1. Remove the lens cap.
2. Set the Power switch to **M** or **A** (manual or automatic record). (The VIDEO or DSC indicator comes on.)
3. If the DSC indicator is not on, press the REFRESH button for approximately 1 second. (The DSC indicator comes on.)
4. When you're ready to take a picture, press SNAPSHOT.

Notes:

- When the remaining picture number icon blinks 0, you must delete some pictures before you can store new ones.
- Some sample images have been stored in the built-in memory at the factory. If you want to delete them, first unprotect them (see page 68), then delete them (see page 69).
- If a snapshot is taken while the camcorder is in the 16 x 9 mode (see page 78), the snapshot image is recorded without the black bars at the top and bottom of the screen.
- During the DSC recording, the zooming (see page 40), Steady Pix™ (see page 41) and Video Light (see page 42) functions can be operated.
- Snapshots are taken in a format based on JPEG (Joint Photographic Experts Group).
- When you use the LCD monitor outdoors under direct sunlight, the LCD monitor may be difficult to see. If this happens, close the LCD monitor and use the viewfinder instead.
- To store the snapshots you shot, we recommend that you transfer them to a computer and save them on disk (see page 73), or transfer them to a VCR connected to the camcorder and record them onto a tape.

DSC indicator **VIDEO indicator**

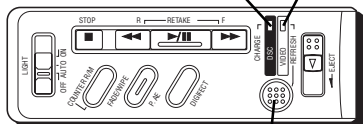

REFRESH button

Quick Review (to check the last shot stored in the built-in memory)

1. Set the Power switch to **M** or **A** (manual or automatic record). (The VIDEO or DSC indicator comes on.)
2. If the DSC indicator is not on, press REFRESH for approximately 1 second. (The DSC indicator comes on.)
3. Press **◀◀** and release quickly. (The snapshot is displayed for approximately 3 seconds. *DELETE? PRESS PLAY BUTTON* appears.)
 - To delete the snapshot, press **▶▶**.
 - If you want to keep it, wait for the delete message to disappear.

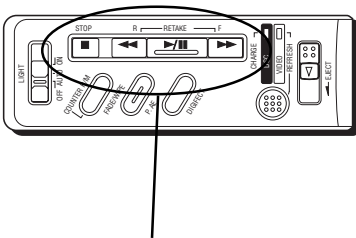

Playback buttons

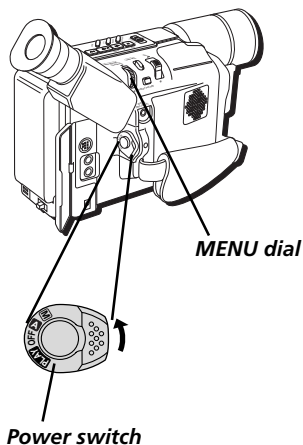

Normal Playback

The snapshots you take are automatically numbered, then stored in numerical order in the built-in memory. You can view them using the Index and Slideshow features.

1. Set the Power switch to **PLAY**. (The VIDEO or DSC indicator comes on.)
2. If the DSC indicator is not on, press REFRESH for approximately 1 second. (The DSC indicator comes on and a snapshot stored in memory is displayed.)
3. To go to the previous picture, press ◀◀. To go to the next picture, press ▶▶.

Notes:

- When no snapshots are stored in memory, the screen is blue.
- When the Power switch is set to **PLAY** and the LCD monitor is opened at an angle of 60° or more, the LCD monitor switches on and the viewfinder switches off automatically to save power.
- The playback picture can be viewed in the viewfinder (with the LCD monitor shut), on the LCD monitor or on a connected TV (see page 54).
- When viewing a picture on a connected TV, it may jitter slightly.
- You can also view the picture on the LCD monitor with it flipped over and retracted.
- To brighten the LCD monitor, rotate the BRIGHT dial towards +. To darken the LCD monitor, rotate it towards -.
- Don't worry about overwriting your pictures. New pictures are automatically stored after the last one you took.

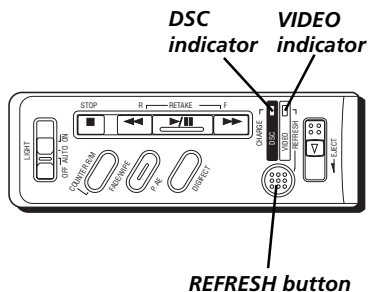

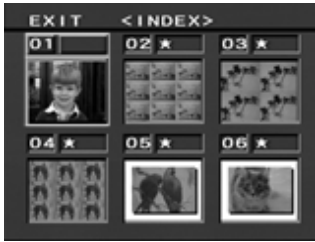

Slide Show

You can automatically look at all the snapshots stored in memory in numerical order.

1. Set the Power switch to **PLAY**. (The VIDEO or DSC indicator comes on.)
2. If the DSC indicator is not on, press REFRESH for approximately 1 second. (The DSC indicator comes on and a snapshot stored in memory is displayed.)
3. Press in the MENU dial. (The DSC menu appears.)
4. Rotate the MENU dial to highlight *SLIDE SHOW*. Press in the MENU dial to select it. (The slide show starts.)

Note: To stop the slide show, press in the MENU dial twice.

Index

With the Index feature, you can view your snapshots in groups of 6. This also allows you to see which picture mode was selected for each picture and which ones are protected against accidental erasure.

01: Index number

The first snapshot taken is index #01. Let's say, for example, that a total of 10 images are stored (index number: 01 to 10) in memory. If three images (numbers 02, 04, and 06) are deleted from memory, the remaining images are automatically moved up to fill any gaps in the numerical sequence. Therefore, the number of remaining images is 7, and the new index numbers range from 01 to 07.

★ : Picture mode

This icon tells you what the picture mode is of the snapshot. There are 2 modes available: *FINE* and *STANDARD* (see page 59). A star is displayed next to snapshots shot in the *FINE* mode. There are no marks next to snapshots shot in the *STANDARD* mode.

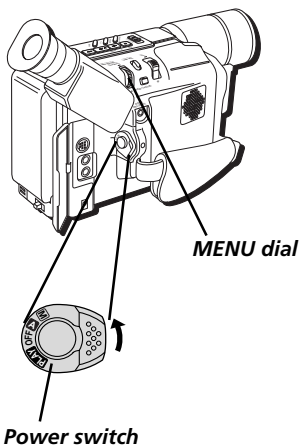

: Protect icon

When an image is protected against accidental erasure, the padlock icon appears next to the picture mode icon.

Selected Image

The image you have selected is highlighted with a box. Rotate the MENU dial to move the box to another image.

Index Playback

1. Set the Power switch to **PLAY**. (The VIDEO or DSC indicator comes on.)
2. If the DSC indicator is not on, press REFRESH for approximately 1 second. (The DSC indicator comes on and a snapshot stored in memory is displayed.)
3. Press in the MENU dial. (The *DSC* menu appears.)
4. Rotate the MENU dial to highlight *INDEX*. Press in the MENU dial to select it. (The index of the images in memory appears.)

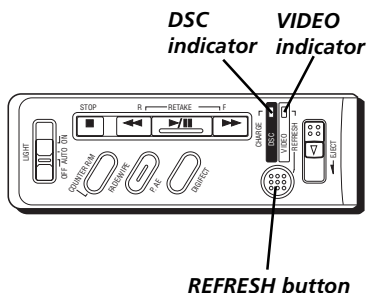



Padlock icon

Protecting Images

The Protect mode helps prevent images from being erased. When the padlock icon appears next to the Picture Mode icon, that image can't be deleted.

1. Set the Power switch to **PLAY**. (The VIDEO or DSC indicator comes on.)
2. If the DSC indicator is not on, press REFRESH for approximately 1 second. (The DSC indicator comes on and a snapshot stored in memory is displayed.)
3. Press in the MENU dial. (The *DSC* menu appears.)
4. Rotate the MENU dial to highlight *PROTECT*. Press in the MENU dial to select it. (The index of the images in memory appears.)
5. Rotate the MENU dial to highlight the image you want to protect. Press in the MENU dial to select it. A padlock icon appears on the image. It can't be deleted now. Repeat this procedure for all images you want to protect.

Important: *When the memory is initialized or corrupted, even protected images are deleted. If you don't want to lose important images, transfer them to a PC and save them.*

Unprotecting Images

1. Set the Power switch to **PLAY**. (The VIDEO or DSC indicator comes on.)
2. If the DSC indicator is not on, press REFRESH for approximately 1 second. (The DSC indicator comes on and a snapshot stored in memory is displayed.)
3. Press in the MENU dial. (The *DSC* menu appears.)
4. Rotate the MENU dial to highlight *PROTECT*. Press in the MENU dial to select it. (The index of the images in memory appears.)
5. Rotate the MENU dial to highlight the image you want to unprotect. Press in the MENU dial to select it. (The padlock icon disappears from the image.) It can now be deleted. Repeat this procedure for all images you want to unprotect.



The image is no longer protected.

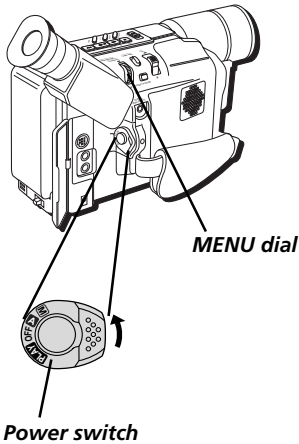

Deleting Images

You can delete your snapshots one at a time or all at once.

Deleting Select Images

1. Set the Power switch to **PLAY**. (The VIDEO or DSC indicator comes on.)
2. If the DSC indicator is not on, press REFRESH for approximately 1 second. (The DSC indicator comes on and a snapshot stored in memory is displayed.)
3. Press in the MENU dial. (The *DSC* menu appears.)
4. Rotate the MENU dial to highlight *DELETE*. Press in the MENU dial to select it. (The *DELETE* menu appears.)
5. Rotate the MENU dial to highlight *SELECT*. Press in the MENU dial to select it. (The index of the images in memory appears.)
6. Rotate the MENU dial to highlight the image you want to delete.
7. Press in the MENU dial to select it. (A red "X" appears on the image.)
8. When finished, rotate the MENU dial to *NEXT* at the top of the screen. Press in the MENU dial to select it.
9. Rotate the MENU dial to highlight *ENTER*. (The image(s) are deleted.)

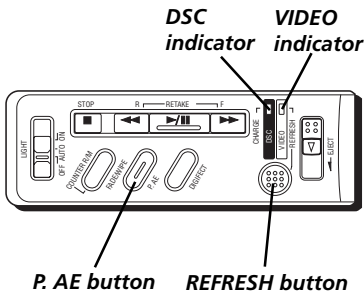

Note: To cancel deleting images, rotate the MENU dial to highlight *CANCEL* and press it twice.

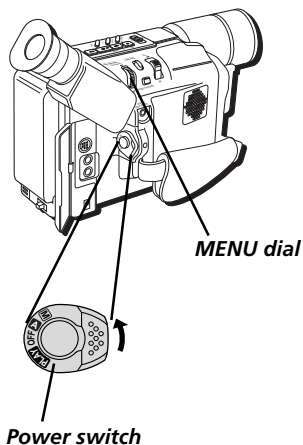

Initializing the Built-in Memory

External noise and interference (from a TV, a radio, etc.) might prevent your camcorder from functioning properly. If images can't be stored or deleted, you may need to initialize the memory. This will erase all the images (including protected images).

If you want to keep any of the snapshots that are stored in memory, you need to transfer them to a PC and save them first before initializing the memory. If image data is corrupt, transfer is impossible.

1. Set the Power switch to **PLAY**.
2. If the DSC indicator is not on, press REFRESH for approximately 1 second. (The DSC indicator comes on and a snapshot stored in memory is displayed.)
2. Press P.AE for more than 5 seconds. (The *FORMAT* menu appears.)
3. Rotate the MENU dial to select *CANCEL* or *ENTER*. Press in the MENU dial to select it.
 - *CANCEL* does not initialize the memory.
 - *ENTER* initializes the memory. (While the camcorder's memory is being erased, *ENTER* blinks. When finished, the screen becomes blue.)

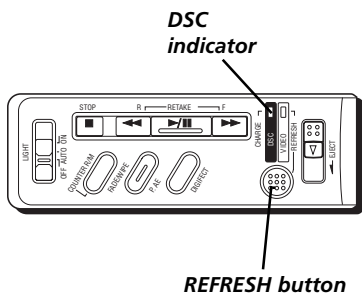

Very important: Never turn off the camcorder or remove the power (battery or AC) while the memory is being erased. The built-in memory may become corrupt.

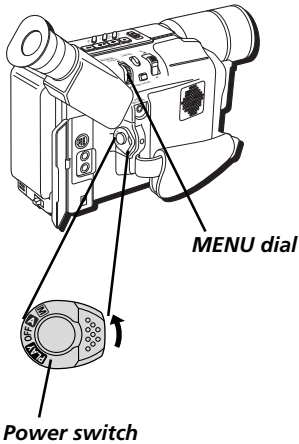

Deleting All Images

1. Set the Power switch to **PLAY**. (The VIDEO or DSC indicator comes on.)
2. If the DSC indicator is not on, press REFRESH for approximately 1 second. (The DSC indicator comes on and a snapshot stored in memory is displayed.)
3. Press in the MENU dial. (The *DSC* menu appears.)
4. Rotate the MENU dial to highlight *DELETE*. Press in the MENU dial to select it. (The *DELETE* menu appears.)
5. Rotate the MENU dial to highlight *ALL*. Press in the MENU dial to select it.
6. Rotate the MENU dial to highlight *ENTER*. (The images are deleted.)

Note: To cancel deleting images, rotate the MENU dial to highlight *CANCEL* and press it twice.

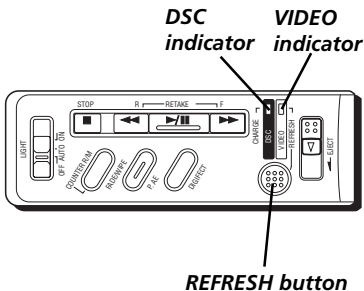

Very important: Never turn off the camcorder or remove the power (battery or AC) while the memory is being erased. The built-in memory may become corrupt.

Notes:

- Protected images (see pages 67-68) cannot be deleted with the above operation. To delete them, remove protection first.
- If the remaining number of shots is not 30 in the *FINE* mode or 60 in the *STANDARD* mode after you have deleted all the images, initialize the camcorder's memory (see page 70).

System Requirements for Picture Navigator

- 66 MHz or faster (Pentium recommended) for Microsoft® Windows® 98 or later
- CPU 468DX2/50 MHz or faster for Microsoft® Windows® 95 or later
- 16MB RAM
- 6MB free hard disk space
- CD-ROM drive
- Color display capable of at least 640 x 680 pixels, 256 colors (recommended 800 x 600 pixels, 32,000 colors)
- 1 free serial transmission port, compatible with 9600 bps or higher transmission rate, connectable to RS-232C with 9-pin serial connector

Note: *An optional 9-pin serial conversion adapter is required for computers using a serial communication port other than a standard 9 pin.*

- Mouse (Windows® compatible)

* Microsoft® and Windows® registered trademarks of Microsoft Corporation.

Connecting To A Windows® PC

Image data stored in the camcorder's built-in memory can be transferred to a Windows® PC and saved using the image transfer software, Picture Navigator.

To assure safety, make sure all units are turned off before making any connection.

1. Insert the Picture Navigator CD-ROM into your drive.
2. Double click the installer icon and follow the on-screen instructions to install the software.
3. Connect the camcorder's DIGITAL jack to the COM Port (RS-232C) on a Windows® PC, using the PC connection cable.

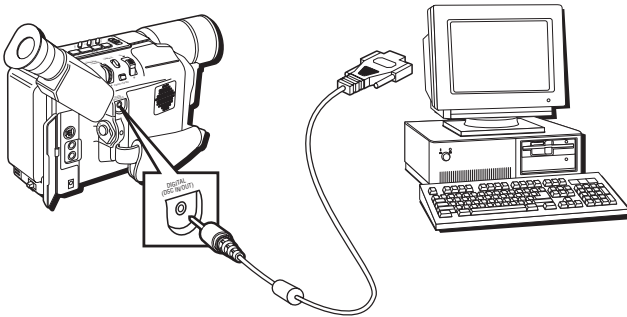

4. Set the Power switch to **PLAY**. (The VIDEO or DSC indicator comes on.)
5. If the DSC indicator is not on, press REFRESH for approximately 1 second. (The DSC indicator comes on and a snapshot stored in memory is displayed.)
 - When transferring snapshots to a computer, be sure that the snapshot is displayed on the screen before continuing.
6. Launch the software on your Windows® PC and transfer the snapshots stored in the camcorder's memory to your Windows® PC. Refer to the software's instruction manual on the CD-ROM for details.
 - During transfer of the snapshot, the camcorder's screen becomes blue and *PC MODE* is displayed. After transferring is finished, the screen displays the same snapshot as in step 5.
7. Close the software, then turn off the camcorder.

Windows® is a trademark of Microsoft Corporation, registered in the U.S.A. and other countries.

Notes:

- *Before transferring snapshots from your personal computer to the camcorder's built-in memory, check that the desired Picture Mode has been selected for the images (see page 60). The snapshots will be transferred from the personal computer in the selected Picture Mode.*
- *When transferring snapshots from your personal computer to the camcorder, make sure the number of images to be transferred is smaller than the camcorder's remaining number of shots available.*
- *Use the power supply instead of the battery pack to power the camcorder.*
- *The snapshots stored in the camcorder's memory are not automatically removed after you transfer them to the PC. You'll still need to delete them.*

Advanced Features

Chapter Overview:

- Using the Menus for Advanced Adjustment
- Menu Definitions
- Using the Advanced Features

Changing Entertainment. Again.



Using the Menu For Advanced Adjustment

This camcorder is equipped with an on-screen menu system that simplifies many of the more detailed camcorder settings.

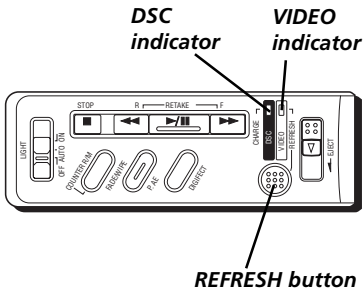
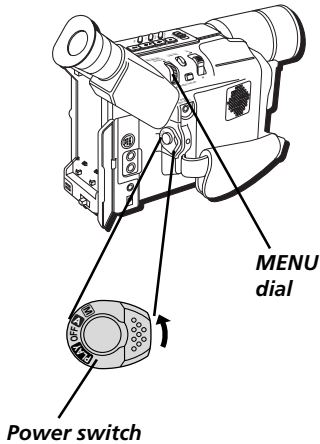

1. Set the Power switch to manual record (M). Press REFRESH for approximately 1 second to select VIDEO or DSC according to each function's "*"/**" explanation described at the bottom of pages 77 and 79.
2. Press in the MENU dial. The *CAMERA MENU* appears.
3. Rotate the MENU dial to highlight the desired function.
 - To go from the *CAMERA MENU* to the *SYSTEM MENU*, rotate the MENU dial to highlight *TO SYSTEM MENU*. Press in the MENU dial to select it. The *SYSTEM MENU* is composed of 2 pages. To go to the next page, rotate the MENU dial to highlight *NEXT*. Press in the MENU dial to select it.
 - To return to the *CAMERA MENU* from page 2 of the *SYSTEM MENU*, rotate the MENU dial to highlight *TO CAMERA MENU*. Press in the MENU dial to select it.
4. Press in the MENU dial to display the menu for the function you have selected and rotate it to select the desired setting.
5. Press in the MENU dial. The *CAMERA MENU* or the *SYSTEM MENU* reappears with *RETURN* highlighted.
6. Press in the MENU dial to exit.

Menu Definitions

The following charts will help you get acquainted with the various menus and some brief definitions of their features. For more detailed explanation, refer to the corresponding sections.

Camera Menu

FOCUS	Refer to Focusing (<i>see page 85</i>).
EXPOSURE	Refer to Exposure Control (<i>see page 84</i>).
M.W.B.	Refer to White Balance Adjustment and Manual White Balance Operation (<i>see pages 87-88</i>).
TITLE*	Allows you to superimpose one of eight preset titles (<i>see page 90</i>).
DATE/TIME DISP.*	Makes the date/time settings appear in the camcorder or on a connected monitor (<i>see page 89</i>).

System Menu

This menu can't be accessed while recording.

REC MODE*	Allows you to set the recording mode (SP or SLP) (<i>see page 25</i>).	
D. ZOOM	50X	Factory Preset: Allows you to use the Digital Zoom. By digitally processing and magnifying images, zooming is possible from 16X (the optical zoom limit), to a maximum of 50X digital magnification.
	400X	Allows you to use the Digital Zoom. By digitally processing and magnifying images, zooming is possible from 16X (the optical zoom limit), to a maximum of 400X digital magnification.
	OFF	Digital Zoom isn't available. Only optical zoom (maximum 16x magnification) can function. When set to OFF during Digital Zoom, zoom magnification changes to 16X.

* Activated only when VIDEO is selected (the DSC indicator is not on). If DSC is selected (the DSC indicator is on), this function will not be activated even though the highlight bar on the menu will move to that position.

Functions listed without an asterisk are available when either DSC or VIDEO is selected.

Advanced Features

System Menu (continued)

16 x 9	OFF	Factory Preset: Doesn't display black bars.
	ON	Allows you to record black bars at the top and bottom of the screen to produce a cinema-like wide-screen effect. If you take a snapshot in the 16x9 mode, the snapshot is recorded without the black bars.
S-VHS ***	ON	Factory preset: Records in S-VHS format on a VHS or S-VHS tape (<i>see page 23</i>).
(S-VHS ET ***)	OFF	Records in S-VHS ET format on a VHS tape (<i>see page 23</i>).
TAPE LENGTH		Allows you to set the tape length depending on the tape used (<i>see page 26</i>).
DISPLAY	FULL	Factory Preset: Make all of the icons appear on the LCD monitor/viewfinder during playback or recording.
	SIMPLE	Make the following icons disappear from the LCD monitor/viewfinder during recording or playback: cassette warning, tape remaining time, battery pack remaining power icon and tape length icon.
PICTURE**		Refer to Picture Mode Setting (<i>see page 59</i>).
SNAPSHOT**	FULL	Displayed when DSC (the DSC indicator is on), is selected (<i>see pages 60-61</i>).
	PIN-UP	
	MULTI-4	
	MULTI-9	
REC TIME*		Refer to Animation and Time-Lapse (<i>see pages 91-92</i>).
INT. TIME		Refer to Time-Lapse (<i>see page 92</i>).
TELE MACRO	OFF	Factory preset (OFF) : Usually the distance to a subject where the lens is in focus depends on the zoom magnification. Unless there is a distance of more than 1 m (3.23 ft.) to the subject, the lens is out of focus at the maximum telephoto setting. When set to ON, you can shoot a subject as large as possible at a distance of approximately 60 cm (23-5/8"). Depending on the zoom position, the lens may go out of focus.
	ON	

TITLE LANG*		Allows you to select the language (ENGLISH, FRENCH, or SPANISH) of Instant Titles (<i>see page 90</i>).
DATE/TIME		Allows you to set the current date and time (<i>see page 22</i>).
DEMO MODE*	ON	<p>Factory Preset: Demonstrates certain functions automatically. When <i>DEMO MODE</i> is set to <i>ON</i> and you have exited all menus, the demonstration starts.</p> <p>Operating the Power zoom lever during the demonstration stops the demonstration temporarily. If the Power zoom lever is not moved for more than 1 minute after that, the demonstration will resume.</p> <p>To cancel the demo mode, rotate the Power switch to  (manual record) and press in the MENU dial while the demo is in progress. This takes you directly to the DEMO MODE menu (so you will not have to go through the main menu). Rotate the MENU dial to highlight <i>OFF</i>. Then press in the MENU dial again to select it.</p> <p>Note: When a tape is loaded in the camcorder, the demonstration is not available.</p>
	OFF	Automatic demonstration will not take place.

* Activated only when VIDEO is selected (the DSC indicator is not on). If DSC is selected (the DSC indicator is on), this function will not be activated even though the highlight bar on the menu will move to that position.

** Activated only when DSC is selected (the DSC indicator comes on). If VIDEO is selected (the DSC indicator is not on), this function will not be activated even though the highlight bar on the menu will move to that position.

Functions listed without */** are available when either DSC or VIDEO is selected.

*** S-VHS ET is displayed when a VHS tape is loaded, and S-VHS is displayed when an S-VHS tape is loaded (*see page 23*). If a tape is not loaded, S-VHS appears.

S-VHS ET is preset to OFF.

Using the Advanced Features

Fade/Wipe Effects

These effects let you make professional-looking scene transitions. Fade-ins or wipe-ins work at recording start, and fade-outs or wipe-outs work at recording end.

1. Set the Power switch to  (manual record).
2. If the DSC indicator comes on, press REFRESH for approximately 1 second to select VIDEO.
3. Press FADE/WIPE repeatedly until the desired mode's name and icon appear. (They are displayed for approximately 2 seconds, then the name disappears so that only the icon remains.)
4. Press the Recording Start/Stop button to activate fade-in/out or wipe-in/out.
5. To cancel a fade or wipe, press FADE/WIPE repeatedly until *OFF* appears. (*OFF* is displayed for approximately 2 seconds and the fade/wipe standby mode is cancelled.)

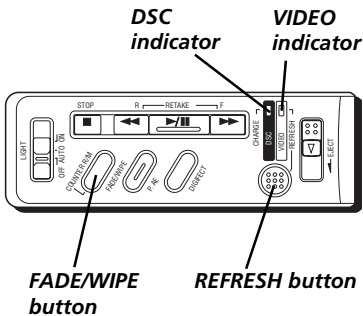
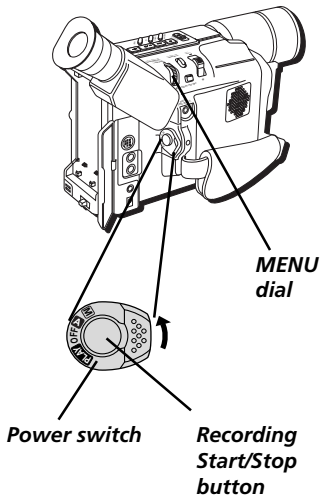

Fades

FADER

Fades in/out to a black screen.

MOSAIC

Gradually turns/returns the picture into/from a mosaic pattern.

Wipes



SHUTTER

Wipes in as a black screen from the top and bottom, closing over the image like a shutter. Wipes out as a new image, pushing open the black screen vertically from the center.



SLIDE

Wipes in as a black screen moves in from the left to gradually cover the image. Wipes out as a new image moves in from right to left.



DOOR

Wipes in as the two halves of a black screen open to the left and right, revealing the scene. Wipes out and the black screen reappears from left and right to cover the scene.



CORNER

Wipes in on a black screen from the upper right to the lower left corner, revealing the scene. Wipes out from lower left to upper right, leaving a black screen.



WINDOW

Wipes in on a black screen from the center of the screen towards the corners, revealing the scene. Wipes out from the corners to the center, leaving a black screen.

Note: Pressing and holding the Recording Start/Stop button allows you to vary the length for the image during fade in/out or wipe in/out.

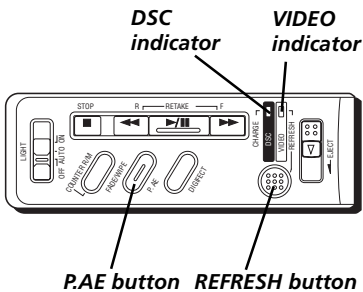
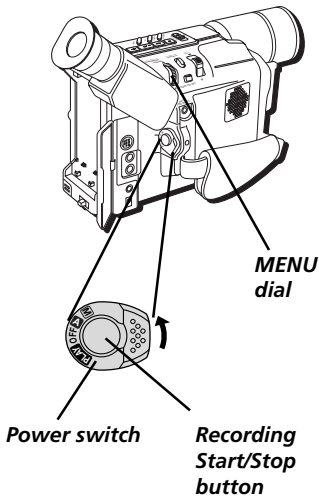

Program AE With Special Effects

1. Set the Power switch to **M** (manual record).
2. Press REFRESH for approximately 1 second to select VIDEO or DSC.
3. Press P.AE repeatedly until the desired mode's name and icon appear. (They are displayed for approximately 2 seconds, then the name disappears so that only the icon remains.)
4. To cancel the effect, press P.AE repeatedly until *OFF* appears. *OFF* is displayed for approximately 2 seconds.

Note: Only one mode can be engaged at a time.

SPORTS

High shutter speed clearly captures fast-moving action.

SD : SHADOW

A black mist darkens the picture, as when an ND filter is used. Helps to counter the effects of glare on the subject.

HZ : HAZE

Makes the picture look misty white, as if you're using an external fog filter and softens the image.

TWILIGHT

Dusk, twilight scenery, fireworks, etc., look more natural and dramatic. When Twilight mode is selected:

- Auto gain control is turned off.
- White Balance is set to *FINE* (day mode), but can also be manually changed to another mode (*see page 87*).
- Auto Focus becomes available only in the range of 10 m (32 ft.) to infinity. To focus when the subject-to-camera distance is less than 10 m (32 ft.), use manual focusing (*see page 86*).

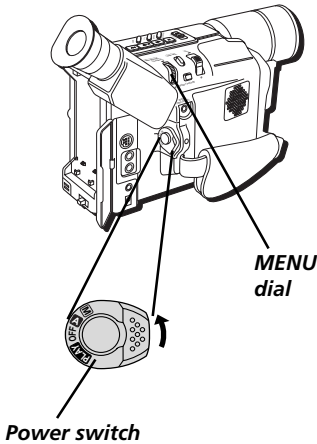

S1/2000

(1/2000 sec. High Speed Shutter)

Captures faster action than Sports mode.

Notes:

- The screen becomes slightly dark in the High Speed Shutter mode. Use in well-lit situations.
- In the High Speed Shutter or Sports modes, picture color may be adversely affected if the subject is lit by alternating discharge-type light sources such as fluorescent or mercury-vapor lights.

Digital Effects

1. Set the Power switch to (manual record).
2. Press REFRESH for approximately 1 second to select VIDEO or DSC.
3. Press DIGIFECT repeatedly until the desired mode's name and icon appear. (They are displayed for approximately 2 seconds, then the name disappears so that only the icon remains.)
4. To cancel the effect, press DIGIFECT repeatedly until OFF appears. (OFF is displayed for approximately 2 seconds.)

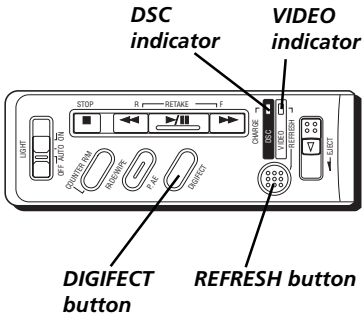

SEPIA

Recorded scenes have a brownish tint like old photos. Combine this with the 16x9 mode (*see page 78*) for a classic look.

B/W MONOTONE

Recorded scenes are shot in black and white. Combine this with the 16x9 mode (*see page 78*) for a classic look.

Advanced Features

NEGA POSI (Negative Positive)

The colors of a picture are reversed.

MOSAIC

Turns recorded scenes into a mosaic pattern.

STRETCH

Doubles the width of the picture horizontally.

Note: *Digital Effects can be changed during recording or during Record-Standby.*

Exposure Control

This feature automatically adjusts the iris for the best available picture quality, but you can override it and make the adjustment manually. Manual exposure adjustment is recommended in the following situations:

- When shooting using reverse lighting or when the background is too bright.
 - When shooting on a reflective natural background such as at the beach or when skiing.
 - When the background is overly dark or the subject light.
1. Set the Power switch to  (manual record).
 2. Press REFRESH for approximately 1 second to select VIDEO or DSC.
 3. Press in the MENU dial. (The *CAMERA MENU* appears.)
 4. Rotate the MENU dial to highlight *EXPOSURE*. Press in the MENU dial to highlight it. (The *EXPOSURE* menu appears.)
 5. Rotate the MENU dial to highlight *MANU*(manual). Press in the MENU dial to select it. (The menu disappears and *00* (exposure control level counter) appears.)
 - To brighten the image, rotate the MENU dial downward. (The exposure control level counter increases (maximum +06)).
 - To darken the image, rotate the MENU dial upward. (The exposure control level counter decreases (maximum -06)).
 6. Press in the MENU dial to select it.
 7. When finished, press in the MENU dial again to exit.

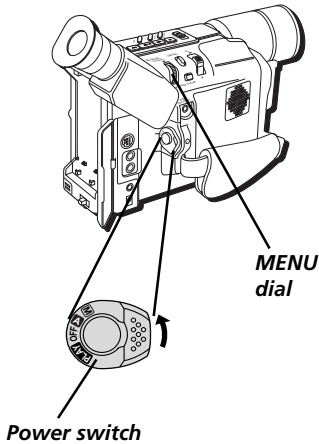

Notes:

- To return to the factory setting, select *AUTO* in step 5.
- To readjust exposure, repeat the procedure from step 3.

Focusing

Auto Focus

The camcorder's Full Range automatic focus system offers continuous shooting ability from close-up to infinity. However, correct focus may not be obtainable in the situations listed below (in these cases use manual focusing):

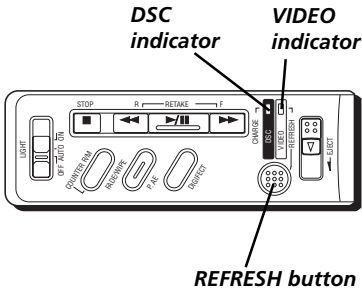

- When two subjects overlap in the same scene.
- When illumination is low. The low-contrast warning ▲👤 appears.
- When the subject has no contrast (difference in brightness and darkness), such as a flat, one-color wall, or a clear, blue sky. The low-contrast warning ▲👤 appears.
- When a dark object is barely visible in the viewfinder. The low-contrast warning ▲👤 appears.
- When the scene contains small patterns or identical patterns that are regularly repeated.
- When the scene is affected by sunbeams or light reflecting off the surface of a body of water.
- When shooting a scene with a high-contrast background.

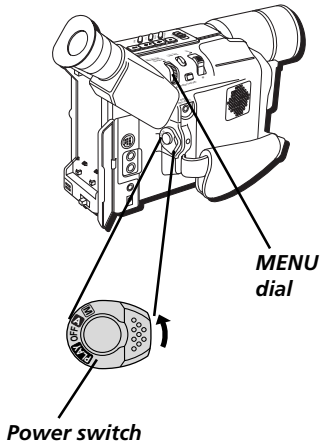





Manual Focus



Make the necessary viewfinder adjustments to use the viewfinder (*see page 29*).

1. Set the Power switch to  (manual record). Press REFRESH for approximately 1 second to select VIDEO or DSC.
2. Press the MENU dial in. (The *CAMERA MENU* appears.)
3. Rotate the MENU dial to highlight *FOCUS*. Press in the MENU dial to select it. (The *FOCUS* menu appears.)
4. Rotate the MENU dial to highlight *MANU*. Press in the MENU dial to select it. (The menu disappears and  appears.) The focus is locked at this point.
5. When finished, press in the MENU dial again to exit. ( reappears to indicate the focus is locked.)

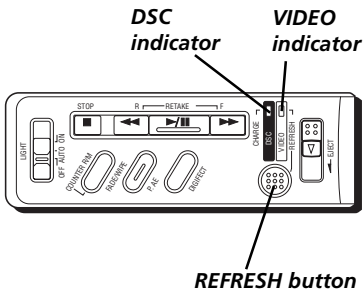
- To focus on a subject that's farther away, rotate the MENU dial upward.  appears and blinks.
- To focus on a nearer subject, rotate the MENU dial downward.  appears and blinks.



Notes:

- *If the lens is smeared or blurred, accurate focusing isn't possible. Keep the lens clean, wiping it with a piece of soft cloth if it gets dirty. If condensation occurs, wipe the lens with a soft cloth or wait for it to dry naturally.*
- *When shooting a subject close to the lens, zoom out first (*see page 40*). When zooming in the auto focus mode, the camcorder could automatically zoom out depending on the distance between the camcorder and the subject.*
- *To return to Auto Focus, highlight AUTO in step 4.*
- *To readjust Manual Focus, repeat the procedure from step 2.*
- *When the focus level cannot be adjusted any farther or closer,  or  blinks.*

White Balance Adjustment

White balance refers to the correctness of color reproduction under various lighting. If the white balance is correct, all other colors will be accurately reproduced.

The white balance is usually adjusted automatically. However, more advanced camcorder operators control this function manually to achieve a more professional color/tint reproduction.

1. Set the Power switch to  (manual record). Press REFRESH for approximately 1 second to select VIDEO or DSC.
2. Press in the MENU dial. (The *CAMERA MENU* appears.)
3. Rotate the MENU dial to highlight *M.W.B.* Press in the MENU dial to select it. (The *M.W.B.* menu appears.)
4. Rotate the MENU dial to highlight the desired setting.

AUTO

White balance is adjusted automatically (factory preset).

 : **FINE**

Outdoors on a sunny day.

 : **CLOUD**

Outdoors on a cloudy day.

 : **HALOGEN**

A video light or similar type of lighting is used.

MWB

White balance is set manually.

Notes:

- To return to automatic white balance, select *AUTO* in step 4. Or rotate the Power switch to  (automatic record).
- White balance cannot be used when the *SEPIA* or *MONOTONE* mode (see page 83) is activated.

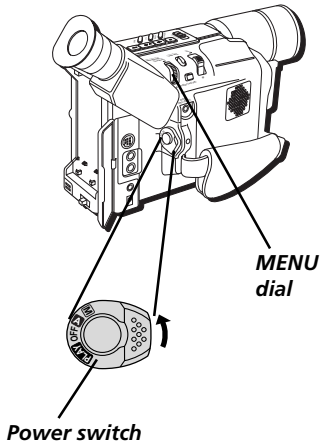

Manual White Balance

Perform Manual White Balance when shooting under various types of lighting.

1. Follow steps 1 through 4 of the white balance adjustment, and highlight *MWB*.
2. Hold a sheet of plain white paper in front of the subject. Adjust zoom or position yourself so that the white paper fills the screen.

Note: *It may be difficult to focus on the white paper. In such a case, adjust focus manually (see page 86).*

3. Press in the MENU dial until *MWB* begins blinking.
 4. When finished, press in the MENU dial to exit.
- To change the tint for recording in step 2, substitute colored paper for white. The white balance is adjusted based on the color, changing the tint.

Red paper = deeper green

Blue paper = orange

Yellow paper = deeper purple.

Notes:

- A subject can be shot under various types of lighting conditions indoors (natural, fluorescent, candlelight, etc.). Because the color temperature is different depending on the light source, the subject tint will differ depending on the white balance settings. Use this function for a more natural result.
- Once you adjust white balance manually, the setting is retained even if the power is turned off or the battery removed.

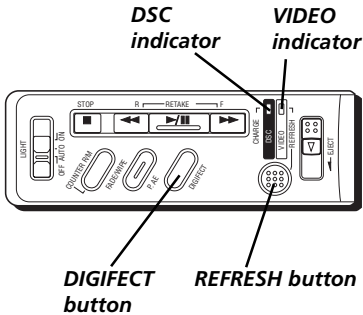

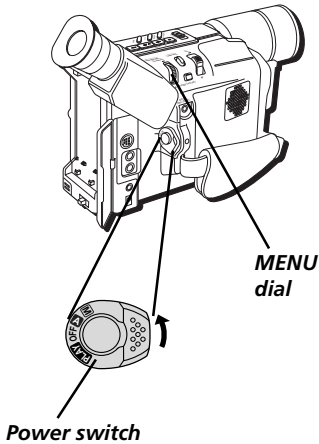

Date/Time Insert

You can display the date and time in the camcorder or on a connected TV, as well as to record them manually or automatically.

You should have already performed the Date/Time Setting procedure (see page 22).

1. Set the Power switch to  (manual record). If the DSC indicator is on, press REFRESH for approximately 1 second to select VIDEO.
2. Press in the MENU dial. (The *CAMERA MENU* appears.)
3. Rotate the MENU dial to highlight *DATE/TIME DISP.* Press in the MENU dial to select it. (The *DATE/TIME DISP.* menu appears.)
4. Rotate the MENU dial to highlight the desired mode. Press in the MENU dial to select it. (The desired mode is activated.)

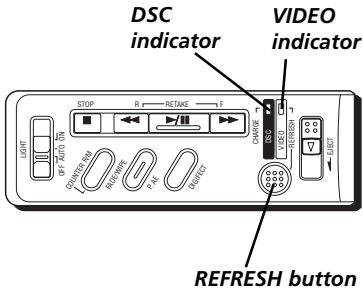

Notes:

DISPLAY

- The selected display can be recorded.
- If you do not want to record the display, select the OFF mode before shooting.
- The date/time is displayed during the VIDEO mode only, and it is recorded only onto the tape.

AUTO DATE

- In this mode, the date is replaced after 5 seconds with AUTO DATE but isn't recorded.
- Your camcorder automatically records the date for about 5 seconds after you do the following:
 - Change the date.
 - Load a tape.
 - Select Auto Date Record mode by rotating the MENU dial.

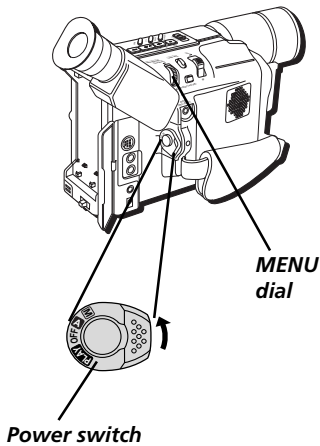

Instant Titles

The camcorder has 8 preset titles in memory. You can superimpose one of them over the video image.

Instant Titles can be displayed in English, French, and Spanish.

1. Set the Power switch to  (manual record). If the DSC indicator is on, press REFRESH for approximately 1 second to select VIDEO.
2. Press in the MENU dial. (The *CAMERA MENU* appears.)
3. Rotate the MENU dial to highlight *TITLE*. Press in the MENU dial to select it. (The *TITLE* menu appears.)
4. Rotate the MENU dial to highlight the desired mode. Press in the MENU dial to select it.

Notes:

- The title is displayed during the VIDEO mode only, and it is recorded only onto the tape.
- The selected title will remain until OFF is selected in the TITLE Menu.

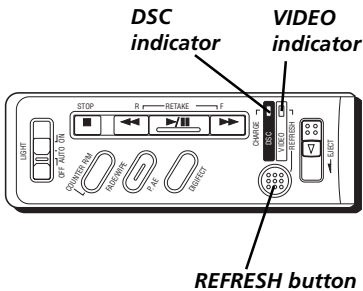

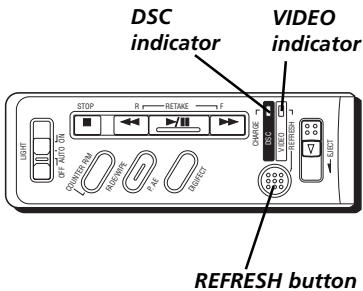
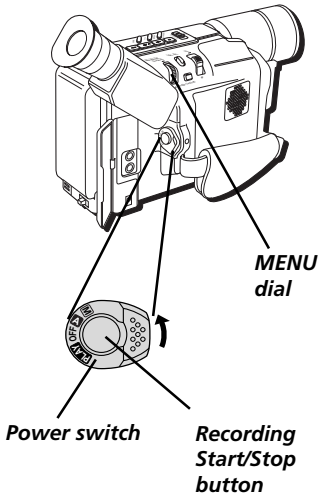

Animation

You can shoot a series of pictures, each slightly different, of the same object for a brief period of time.

1. Set the Power switch to \square (manual record). If the DSC indicator is on, press REFRESH for approximately 1 second to select VIDEO.
2. Make sure the recording mode is set to SP.
3. Press in the MENU dial. (The *CAMERA MENU* appears.)
4. Rotate the MENU dial to highlight *TO SYSTEM MENU*. Press in the MENU dial to select it. (The *SYSTEM MENU* appears.)
5. Rotate the MENU dial to highlight *NEXT*. Press in the MENU dial to select it. (The next page of the *SYSTEM MENU* appears.)
6. Rotate the MENU dial to highlight *REC TIME*. Press in the MENU dial to select it. (The *REC TIME* menu appears.)
7. Rotate the MENU dial to select the desired recording time. Press in the MENU dial to select it. (The *SYSTEM MENU* reappears with *RETURN* highlighted.)
8. Press the MENU dial in again to close the *SYSTEM MENU*.
9. Press the Recording Start/Stop button after focusing on the subject. The recording stops automatically after the selected period of time. Repeat for the desired number of pictures.
10. To stop the Animation mode, set *REC TIME* in the *SYSTEM MENU* to *OFF*.

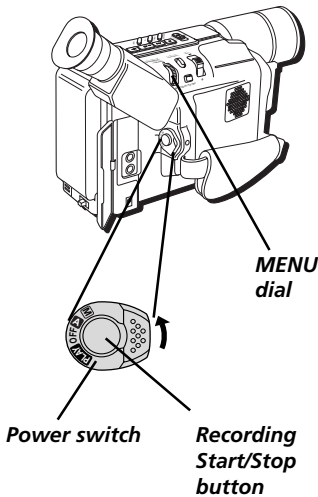

Time-Lapse

You can record sequentially at preset time spans. Leaving the camcorder aimed at a specific subject, you can record subtle changes over an extended period of time.

1. Set *REC TIME* using steps 1-7 of Animation (see page 91).
2. Rotate the MENU dial to highlight *INT. TIME*. Press in the MENU dial to select it. (The *INT. TIME* menu appears.)
3. Rotate the MENU dial to highlight the desired interval time. Press in the MENU dial to select it.
4. When finished, press in the MENU dial again to exit.
5. Press the Recording Start/Stop button. (Recording and intervals alternate automatically.)
6. To release the Time-Lapse mode, press the Recording Start/Stop button to display \equiv PAUSE \equiv . Then set *REC TIME* and *INT. TIME* in the menus to *OFF*.

Notes (for Animation and Time-Lapse):

- For best results, make sure the camcorder is secured when shooting in Animation or Time-Lapse mode.
- Fade-in/out or wipe-in/out can't be performed during Animation or Time-Lapse shooting.
- After using Animation or Time-Lapse recording, make sure the modes are deactivated.
- Animation and Time-Lapse are cancelled when the power is shut off or when the tape is ejected.

Other Information

Chapter Overview:

- Troubleshooting
- Final Notes
- Care and Cleaning
- Traveling Tips
- Specifications
- Customer Assistance and Service
- Limited Warranty
- FCC Declaration of Conformity and Industry Canada Information
- Optional Accessories
- Index

Changing Entertainment. Again.



Troubleshooting

If you're having problems with your camcorder, try the solutions in this section. If the problem still exists, please consult your nearest RCA authorized service center.

External noise and interference (from a TV, a radio, etc.) might prevent your camcorder from functioning properly. In such cases, first disconnect its power supply unit (battery pack, AC power supply, etc.); and then reconnect it and proceed as usual from the beginning.

Power Problems

No power is supplied.

- The battery pack has not been attached correctly (*see page 16*).
- The battery pack is not charged (*see page 16*).
- The power supply has not been correctly connected (*see page 11*).

The power suddenly goes off and does not come back on by itself.

- Turn the Power switch off and then on again.
- The battery pack has completely discharged.
- Remove the tape and disconnect the power source, then after a few minutes, try reconnecting and turning the power back on. If it still does not come on, consult your nearest RCA authorized service center.

Feature and Function Problems

Some menus or features are not available.

The Power switch is set to **A**. Set it to **M** and try again.

During recording, the icons do not appear.

Set *DISPLAY* to *FULL* in the *SYSTEM MENU* (*see page 78*).

Vertical white lines appear when shooting a very bright object.

This sometimes occurs when there is a lot of contrast between the background and the object. It is not a defect of the camcorder. Try shooting from a different angle or adjusting the lighting conditions.

Bright, crystal-shaped spots appear in the LCD monitor and the viewfinder.

Sunlight is directly entering the lens. This is not a defect of the camcorder.

The rear of the LCD monitor is hot.

The light used to illuminate the LCD monitor causes it to be hot. Close the LCD monitor to turn it off or set the Power switch to OFF, and let the unit cool down.

Colored bright spots appear all over the LCD monitor or the viewfinder.

The LCD monitor and the viewfinder are made with high-precision technology. However, black spots or bright spots of light (red, green or blue) may appear constantly on the LCD monitor or in the viewfinder. These spots are not recorded on the tape. This is not due to any defect of the unit.

The icons and the picture color on the LCD monitor are not clear.

This may occur when the surface or the edge of the LCD monitor is pressed.

The LCD monitor, the viewfinder and the lens are dirty.

Wipe them gently with soft cloth. Gently wipe the LCD monitor in a semicircle because wiping strongly spreads the stain and it won't come out easily.

An error number (i.e. E03) appears.

Turn the camcorder's power off, then disconnect the power source. After a few minutes, try turning the power on again.

The image is out of focus.

The eyepiece focus control needs to be adjusted (*see page 29*).

The scene being shot is adversely affecting the operation of Auto Focus (*see page 85*).

Even though the lens cap is detached, the *LENS CAP* warning icon (*see page 31*) blinks.

The *LENS CAP* warning icon may blink when the camcorder is used in dark areas, regardless of whether the lens cap is attached or detached.

Other Information

Recording Problems

Recording cannot be performed.

Make sure the Erase Protection tab is in the position that allows recording. If not, slide the tab. Some tapes have removable tabs. If the tab has been removed, cover the hole with adhesive tape.

If DSC is selected, it isn't possible to record onto the tape. Press REFRESH for approximately 1 second to select VIDEO.

Recording does not start.

The camcorder Power Switch has not been set to **A** or **M** (*see page 12*).

Animation or Time-Lapse is not available.

Before recording in the Animation mode at the very beginning of a tape, set the camcorder to the Recording mode for about 5 seconds, so that the tape runs smoothly. Using the Fade-in function at this point is a good way to begin an animated program.

Playback Problems

The tape is running, but there is no playback picture.

The TV has not been set to its VIDEO input channel.

If Audio/Video connection is used, the TV's VIDEO/TV switch has not been set to VIDEO.

Playback can't be performed.

If DSC is selected, it isn't possible to play a tape. Press REFRESH for approximately 1 second to select VIDEO.

Playback picture is blurred or interrupted.

The video heads are dirty or worn out. Consult your nearest RCA authorized service center for head cleaning or replacement.

The tape stops during fast-forward or rewind.

The Counter Memory Function has been activated (*see page 49*).

Rewinding or fast-forwarding can't be performed.

The tape is already fully wound on one reel or the other.

The picture is blurred in the Quick Review or Retake mode.

This is normal while recording in the SLP mode. Some noise may be present while recording in the SP mode.

The date and time displays disappear.

If you remove the power source from the camcorder while the power is on, all settings and selections are erased. Make sure to turn the camcorder's power off before disconnecting the power source.

The wrong date and time are displayed/recorded.

If you have not performed Date/Time Setting (*see page 22*), the date and time are not displayed/recorded correctly. Be sure that Date/Time setting is carried out.

The tape won't eject.

The battery pack is running low.

If the LCD monitor is not open more than 60°, the EJECT switch does not function.

Digital Still Camera Problems

Although SNAPSHOT is pressed, the snapshot isn't stored in the built-in memory.

When the remaining picture number icon blinks 0, you must delete some pictures before you can store new ones (see page 69).

It isn't possible to shoot in succession.

It takes approximately 2 seconds to store a snapshot in memory. You'll have to wait until the snapshot is stored before taking another picture.

Although ALL is selected in the DELETE menu, all snapshots can't be deleted.

The Protecting Images function is in effect for some snapshots. If they are not necessary, cancel the Protecting Images function, then try deleting all snapshots again (see pages 68-69).

If images cannot be deleted, even after you have unprotected them, you may need to initialize the memory. This will erase all the images (including protected) (see page 70).

There seems to be a problem with storing images in memory.

Try to delete some of the images, then try to take a few more snapshots. If that doesn't work, you may need to save any remaining images to a PC and initialize the memory. This will erase all the images (including protected) from memory (see page 70).

Date/Time Insert isn't performed while shooting a snapshot.

You can't display the date/time on a snapshot.

Instant Titles aren't displayed while shooting a snapshot.

You can't display the Instant Titles on a snapshot.

Some settings can't be changed in the DSC menu.

You can't set *REC TIME* and *INT. TIME* in the DSC menu.

Final Notes

Power

- Perform charging where the temperature is between 10°C and 35°C (50°F and 95°F). 20°C to 25°C (68°F to 77°F) is the ideal temperature range for charging. If the environment is too cold, charging may be incomplete.
- Charging times are for a fully discharged battery pack.
- Charging time varies according to the ambient temperature and the status of the battery pack.
- To avoid interference with reception, do not use the AC power supply near a radio.
- Since the AC power supply processes electricity internally, it becomes warm during use. Be sure to use it only in well-ventilated areas.
- The following stops charging or discharging:
 - Setting the Power switch to **PLAY** , **A**, or **M**.
 - Disconnecting the AC power supply from the camcorder.
 - Unplugging the AC power supply's cord from the AC outlet.
 - Detaching the battery from the camcorder.

Date/Time Settings

- The date/time cannot be stored in memory if the built-in clock battery runs out. Consult an authorized RCA dealer for replacement, or set the date/time as necessary before you start shooting.

Video Recording

- When the Power switch is set to **A** or **M** and the LCD monitor is opened at an angle of 25° or more, the LCD monitor switches on and the viewfinder switches off automatically to save power.
- The cassette tape holder can't be opened unless a power supply is attached.
- There may be a delay after you slide EJECT until the cassette tape holder opens. Do not use force.
- The time required to calculate the remaining tape length, and the accuracy of the calculation, may vary according to the type of tape used.
- The tape remaining time icon is accurate only if the correct tape length has been selected (*see page 26*).
- *TAPE END* appears when the tape reaches its end, and the power goes off automatically if left in this condition for 5 minutes.
TAPE END also appears when a tape whose tape is already at its end is loaded.
- If the Recording Start/Stop button is pressed after the Record-Standby mode has continued for over 5 minutes, recording may not start immediately.
- While shooting, sound is not heard from the speaker.

TBC (Time Base Corrector)

- The *TBC* icon turns yellow (gray with a camcorder equipped with a black/white viewfinder) while TBC is working.
- TBC does not work during still playback and shuttle search.
- The *TBC* icon turns white while TBC is not operative.
- It may take a few seconds before TBC actually starts working.
- The picture may be distorted if the TBC mode is activated or deactivated at the edit-in/-out points or when normal playback resumes after still playback or shuttle search.
- If the playback picture is distorted when TBC is set to on, turn off TBC.

Tapes

- A power supply must be attached to load or eject a tape.
- When loading a tape, it takes a few seconds for the cassette tape holder open. Never apply force to the holder or door cover as this might result in damage to the camcorder and void the warranty.
- If the cassette tape holder does not open after a few seconds, close the holder door and try again. If it still does not open, turn the camcorder off, then on again.
- If the tape does not load properly, open the cassette tape holder door and fully remove the unit. Wait a few minutes and reinsert it.
- When the camcorder is suddenly moved from a cold environment to a warm environment, wait a short time before opening the cassette tape holder door.
- Closing the cassette tape holder door before the holder comes out may damage the camcorder.
- Even when the camcorder is turned off, a tape can still be loaded or unloaded. After the cassette tape holder is closed with the camcorder switched off, though, it may not recede. **Turn the power on before loading or unloading tapes.**
- When recording, once the cassette tape holder door is open, a blank portion will be recorded on the tape or a previously recorded scene will be taped over regardless of whether the tape holder came out or not.

Care and Cleaning

After Using the Camcorder

1. Set the Power switch to OFF.
2. Open the LCD monitor at least 60°.
3. Slide the EJECT switch to open the cassette tape holder, then remove the tape.
4. Press the area marked CLOSE to close and lock the cassette tape holder.
5. Close and lock the LCD monitor.
6. Slide the BATTERY RELEASE switch and remove the battery pack.
7. Reattach the lens cap.

Cleaning The Camcorder

1. Clean the exterior, wiping gently with a soft cloth. For heavy dirt, use diluted, mild soap and wring the cloth well. Then wipe again with a dry cloth.
2. Open the LCD monitor and wipe it gently with a soft, dry cloth. Close it when done.
3. To clean the lens, blow it with air using a blower brush. Wipe gently with lens cleaning paper.
4. To clean the viewfinder, raise it to the vertical position. Turn the eyepiece counterclockwise and pull it out. Insert a lens blower or soft cloth into the gap to clean the interior. Reattach the eyepiece and turn it clockwise until it snaps into place.

Notes:

- *Avoid using strong cleaning agents such as alcohol.*
- *Cleaning should be done only after the power supply has been disconnected.*
- *Mold may form if the lens is left dirty.*
- *When using a cleaner or chemically treated cloth, refer to the cautions of each product.*

Proper Care and Storage

- Keep dirt from entering the camcorder's cassette tape door. Dust and grit are abrasive and cause excessive wear to both the recording/playback heads and tapes.
- Always cap the lens when the camcorder is not in use.
- Before handling the camcorder, make sure your hands and face are free from any chemical products such as suntan lotion, as it might damage the finish.
- The camcorder might be damaged by improper storage or handling. Do not subject the camcorder to swinging, shaking, or dropping.
- Do not store the camcorder in temperatures below -22°F (-30°C) or above 149°F (65°C).
- When the camcorder is not in use, always remove the tape and AC power supply/charger or battery.
- Retain the original carton for future storage or shipping purposes.

Tape Care and Storage

- When finished with a tape, rewind it, remove it from the camcorder, and label it. Protect the tape using the erase protection tab if necessary.
- Store tapes vertically in their protective cases at normal room temperatures. Never leave the camcorder or tapes in a car or outdoors for an extended period of time. Excessive heat or cold might damage tapes.
- Keep tapes away from strong magnetic fields such as electric motors, speakers and other devices.
- Keep dust from entering the cassette tape compartment. All dust is abrasive and causes excessive wear on the tape and the camcorder's recording and playback heads.
- Never use tapes with damaged or spliced tape.
- Do not use a tape if it has been damaged or exposed to moisture. The tape might jam and/or damage the camcorder.

CD-ROM Care

- Take care not to soil or scratch the mirror surface (opposite to the printed surface). Do not write anything or put a sticker on either the front or back surface. If the CD-ROM gets dirty, gently wipe it with a soft cloth outward from the center hole using a circular motion.
- Do not use conventional disc cleaners or cleaning spray.
- Do not bend the CD-ROM or touch its mirror surface.
- Do not store your CD-ROM in a dusty, hot or humid environment. Keep it away from direct sunlight.

Things to Avoid

- Do not attempt to disassemble the camcorder. There are no user-serviceable parts inside.
- Avoid operating the camcorder immediately after moving it from a cold location to a warm location. Give the camcorder 1-1/2 to 2 hours to reach a stable temperature before inserting a tape.
- In cold to warm conditions, condensation might occur causing the tape to stick to the recording heads and damage the camcorder or tapes.
- Never aim the camcorder at the sun or other bright objects.
- Do not leave the camcorder in direct sunlight for extended periods of time. The resulting heat buildup might permanently damage the camcorder's internal parts or reduce the life of the clock battery.
- Do not operate the camcorder in extremely humid environments.
- Do not operate the camcorder near the ocean as salt water or spray might damage the internal parts of the camcorder.
- Do not operate the camcorder for extended periods in temperatures below 40°F (4°C) or above 95°F (35°C).
- Do not expose the camcorder or power supply/charger to rain or moisture. If any component becomes wet, turn off the power and take the unit to an authorized RCA camcorder service provider.
- Do not use an power supply/charger or batteries other than the ones specified for the camcorder. Using the wrong accessories might cause damage to the camcorder.

Traveling Tips

- Write down your camcorder's serial number and keep it separate from the camcorder when traveling. If your camcorder is lost or stolen, you will be able to identify it.
- Use extra care to avoid damage to your camcorder and accessories when operating them at a beach or pool. Spray, sand, and dust should be avoided. If your lens has been exposed to the elements, clean it only with proper lens cleaning supplies.
- Make sure you have any plug adapters that you might need before taking your camcorder to other countries. Consult your dealer for advice.
- Carry your camcorder in a carrying case when traveling. See the accessories section (*page 116*) for a case designed especially for this camcorder. An ordinary suitcase or carry bag does not offer the protection your camcorder needs. Treat your camcorder as carry-on luggage to protect it from rough handling.

Specifications

Camcorder

Format

S-VHS*/VHS NTSC standard

Power source

DC 11 V $\overline{\text{---}}$ (Using AC power supply)

DC 6 V $\overline{\text{---}}$ (Using battery pack)

Power consumption

Viewfinder on:

4.7 W (CC6384)

4.4 W (CC6394)

LCD monitor on:

5.2 W (CC6384)

5.4 W (CC6394)

Video light: 3.0 W

Signal system

NTSC-type

Video recording system

Luminance: FM recording

Color: Converted sub-carrier direct recording conforms to VHS standard

Cassette tape

S-VHSC/VHS-C cassette tape

Tape speed

SP: 33.35 mm/sec. (1-5/16 ips)

SLP: 11.12 mm/sec. (7/16 ips)

Recording time (max.)

SP: 40 minutes

SLP: 120 minutes (with TC-40)

D.S.C. format

Recording format: Digital data storage (based on JPEG)

Recording medium: Built-in flash memory, 2 Mbyte

Number of storable shots

FINE mode: approx. 30 shots

STANDARD mode: approx. 60 shots

Image size: 640 x 480 pixels (when captured on a PC)

Operating temperature

0°C to 40°C (32°F to 104°F)

Operating humidity

35% to 80%

Storage temperature

-20°C to 50°C (-4°F to 122°F)

Weight

Approx. 900 g (2.0 lbs)

Dimensions (W x H x D)

206 mm x 112 mm x 118 mm (8-1/8" x 4-7/16" x 4-11/16") (with the LCD monitor closed and with the viewfinder fully tilted downward)

Pickup

1/4" format CCD

Lens

F1.6, f = 3.9 mm to 62.4 mm, 16:1 power zoom lens with auto iris and macro control, filter diameter 40.5 mm

Viewfinder

CC6384: Electronic viewfinder with .5" black and white CRT.

CC6394: Electronic viewfinder with 0.44" color LCD

White balance adjustment

Auto/Manual adjustment

LCD monitor system

CC6384: 2.5" diagonally measured, LCD panel/TFT active matrix

CC6394: 3" diagonally measured, LCD panel/TFT active matrix

Speaker

Monaural

Audio/Video Jacks

Video

1 V (p-p), 75 Ω unbalanced, analog output (via Video output connector)

Audio

300 mV (rms), 1 k Ω analog output (via Audio output connector)

* CC6394 only

(continued on the next page)

Other Information

Digital

ø2.5 mm, 4-pole, mini-head jack

S-Video*

Y : 1 V (p-p), 75 Ω , analog output C : 0.29 V (p-p),
75 Ω , analog output

AC Power Supply

Power requirement

U.S.A. and Canada: AC 120 V, 60 Hz

Other countries: AC 110 V to 240 V*, 50 Hz/60 Hz

Output

DC 11 V $\overline{\text{---}}$, 1 A

Dimensions (W x H x D)

59 mm x 31 mm x 69 mm (2-3/8" x 1-1/4" x 2-3/4")

Weight

Approx. 130 g (0.29 lbs)

* CC6394 only

Customer Assistance and Service

You can reach Thomson at the following number:

800-283-6503

(Toll free inside U.S.A.)

Our toll-free camcorder number operates from 8 a.m. to 5 p.m. CST Monday – Friday for U.S. customers only

Thomson provides a toll-free telephone number to help with any problems encountered with the camcorder. Many problems can be diagnosed over the phone, but, if necessary, repair or replacement will be arranged. For faster service, have the camcorder's model/serial number and date of purchase ready when you call. If your unit is out of warranty, we will quote the cost of a repair or replacement unit to you.

Returning equipment to Thomson for repair or exchange

If we are unable to resolve your problem over the phone, we will gladly service your unit or exchange it for a new or refurbished camcorder. Refer to the limited warranty on the reverse side to learn about your specific rights and responsibilities.

Always consult Thomson and get a Service Request number before returning anything! Obtain a Service Request (SR) number from the telephone representative before returning your equipment to avoid delays, accounting errors, or even loss of your unit.

Important information to customers who ship defective equipment to Thomson Consumer Electronics

The Thomson representative who authorized the return of your equipment will give you an SR number over the phone. They will also provide you with instructions on where and how to return your camcorder. Write the number in large, clear characters on the outside of the box. To avoid confusion and misunderstandings, shipments without an SR number clearly visible on the outside of the box will be returned to you at your expense.

Include a brief note describing the problem and any conversations about the problem you have had with Thomson personnel.

Include your name, address and model/serial number of the camcorder. These numbers are located on the bottom of the camcorder.

If the camcorder is within the warranty period, please provide a copy of the bill of sale to verify purchase date. Use the original box and packing material to protect the equipment from damage in shipment.

For your protection, insure all shipments for full replacement value and use a reliable shipper. Thomson assumes no responsibility for warranty shipments from the customer to the factory if not shipped in the manner prescribed by Thomson.

Limited Warranty

What your warranty covers:

- Any defect in materials or workmanship.

For how long after your purchase:

- 90 days for labor charges.
- One year for parts.

The warranty period for rental units begins with the first rental or 45 days from date of shipment to the rental firm, whichever comes first.

What we will do:

During the initial 90 days

- Exchange your camcorder with a new or refurbished unit, or repair your camcorder. The option will be ours. There will be no cost to you.

After the 90 days and within one year

- Exchange your camcorder with a new or refurbished unit, or repair your camcorder. The option will be ours. Parts will be provided at no charge, but you will be responsible for the cost of labor required for the repair.

How you get service:

- Call 1-800-283-6503 and have your unit's date of purchase and model/serial number ready. The model/serial number information is on the bottom of your camcorder.
- A representative will troubleshoot your problem over the phone. If the representative determines that you should receive a replacement unit, you will be provided with a Service Request (SR) number and the location of a nearby exchange point if one exists. No returns will be accepted without the SR number.

Other Information

To receive a replacement Camcorder before you return yours:

Option I

1. Provide your Discover, MasterCard, or Visa account number and expiration date to our phone representative. This is for security purposes. If we receive your unit, excluding all accessories, within 14 days from the date you were provided the SR number, only items not covered by warranty will be charged to your account. **IF YOUR UNIT IS NOT RECEIVED WITHIN 14 DAYS, THE SUGGESTED RETAIL VALUE OF THE CAMCORDER WILL BE CHARGED TO YOUR CREDIT CARD.** This amount, less \$10.00 handling, will be credited if the unit is subsequently received.
2. We will send you a replacement unit.
3. Ship the unit back to us, excluding all accessories, using the replacement unit's carton. Shipping instructions will be included in the carton along with your SR number which will allow you to easily ship the unit back to us. **Make sure you insure your shipment in case of damage or loss.** Include with the shipment:
 - Evidence of purchase date, such as a bill of sale to verify your unit's warranty eligibility.
 - A brief note describing your camcorder's problem.
 - Your name, address and phone number.

Return transportation, storage, handling, and insurance costs are your sole responsibility. We accept no liability in case of damage or loss.

Option II

1. For a fee of \$10.00, we will send a replacement unit to the exchange point.
2. The exchange location will notify you of its arrival.
3. Take your unit, excluding all accessories, and your evidence of purchase date, such as a bill of sale, to the exchange location and you will be provided the new or refurbished unit.
4. If the repairs were covered by your warranty, you will not be billed.

To receive a replacement unit after we have received your unit:

1. **Write the SR number on the outside of the carton used to return the unit. Make sure you insure your shipment in case of damage or loss.**
2. Carefully pack the unit, excluding all accessories, using the original box and packing material if possible.
3. Include with the shipment:
 - Evidence of purchase date, such as a bill of sale, to verify your unit's warranty eligibility.

- A brief note describing your camcorder's problem.
- Your name, address and phone number.

Return transportation, storage, handling, and insurance costs are your sole responsibility. We accept no liability in case of damage or loss.

4. The representative will advise the address to mail a cashier's check or money order for payment if there are any out of warranty labor or parts charges and you elect not to use your credit card.
5. Upon receipt of your product, a new or refurbished unit will be shipped to you.

To have your Camcorder repaired by an Authorized RCA Camcorder Service Center:

- Check with your dealer or call 1-800-336-1900 for the Authorized RCA Camcorder Service Center nearest you.
- Take your unit to the Authorized RCA Camcorder Service Center of your choice.
- Show the Authorized RCA Camcorder Service Center representative evidence of purchase date, such as a bill of sale.
- Pick up your camcorder when repairs are complete.

What your warranty does not cover:

- Adjustment of customer controls.
- Damage from misuse or neglect.
- A unit that has been modified or incorporated into other products or is used for institutional or other commercial purposes.
- Batteries for remote control and clock.
- Cleaning of video/audio heads.
- Camcorders purchased or serviced outside the U.S.A.
- Return transportation, storage and handling costs of your unit, including insurance for loss or damage.
- Acts of nature, such as but not limited to lightning damage.

Product Registration:

- Please complete and mail the Product Registration Card packed with your camcorder. It will make it easier to contact you should it ever be necessary. The return of the card is not required for warranty coverage.

Other Information

How State Law relates to warranty:

- This warranty gives you specific legal rights and you also may have other rights that vary from state to state.

If you purchased your camcorder outside the United States:

- This warranty does not apply. Contact your dealer for warranty information.

Service calls that do not involve defective materials or workmanship are not covered by this warranty. Costs of such calls are the sole responsibility of the purchaser.

FCC Declaration of Conformity and Industry Canada Information

FCC Regulations state that unauthorized changes or modifications to this equipment may void the user's authority to operate it.

This device complies with part 15 of FCC Rules. Operation is subject to the following two conditions: (1) This device may not cause harmful interference, and (2) This device must accept any interference received, including interference that may cause undesired operation.

This Class B digital apparatus complies with the Canadian ICES-003.

Cet appareil numérique de la Classe B est conforme a la norme NMB-003 du Canada.

This equipment has been type tested and found to comply with the limits for a Class B Digital Device in accordance with the specifications in Part 15 of the FCC rules. These rules are designed to provide reasonable protections against radio and television interference in a residential installation. This equipment generates, uses and can radiate radio frequency energy and, if not installed and used in accordance with the instructions, may cause harmful interference to radio communications. However, there is no guarantee that interference will not occur in a particular installation.

If this equipment does cause interference to radio or television reception (which you can determine by turning the equipment off and on), try to correct the interference by one or more of the following measures:

Reorient or relocate the receiving antenna (that is, the antenna for the radio or television that is "receiving" the interference).

Change the position of the Camcorder with respect to the radio or television equipment that is receiving interference.

Move the Camcorder away from the equipment that is receiving interference.

Plug the Camcorder into a different wall outlet so that the Camcorder and the equipment receiving interference are on different branch circuits.

If these measures do not eliminate the interference, please consult your dealer or an experienced radio/television technician for additional suggestions. Also, the Federal Communications Commission has prepared a helpful booklet, "How To Identify and Resolve Radio/TV Interference Problems." This booklet is available from the U.S. Government Printing Office, Washington D.C. 20402. Please specify stock number 004-000-00345-4 when ordering copies.

For more information on FCC conformity: Thomson Consumer Electronics, Inc., 10330 N. Meridian St., Indianapolis IN 46290; 1-800-587-5850.

Optional Accessories

We invite you to take a look at some great ideas for sparking creativity and adding to the fun of using your camcorder. The following pages have a selection of accessories to help make your memorable moments look and sound even better.

These accessories are designed to make the process of recording and watching your videos more enjoyable.

To order accessories, contact your local Dealer.

If a dealer is not nearby, all accessories are available through toll-free ordering or by using the order form found on page 119.

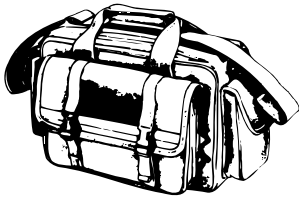

AC201A Soft Carrying Case

Custom compact soft case designed especially to provide protection and utility for your camcorder and most accessories. Rugged fabric lined with soft nonabrasive material and generous padding. Has three outside pockets with storage for lens filters, adapters, batteries, and tapes.

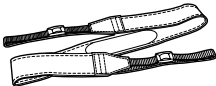

ACS091 Shoulder Strap

Designed to replace the shoulder strap that came with your camcorder.

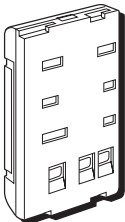

244265 (for CC6384) or 244427 (FB1260) (for CC6394) Rechargeable Battery Pack

Replacement battery for the one that came with your camcorder.

All specifications and descriptions of accessories are subject to change without notice.

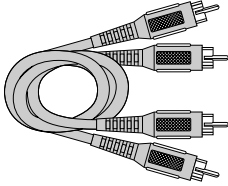

VH83 A/V Cable

Used to attach the camcorder to an external component like a TV or VCR.

Using the Optional AC088 Tripod

Mounting the camcorder on a tripod, such as AC088, keeps the camcorder steady and produces excellent video results.

This tripod's fluid-effect head provides smooth camera pan and tilt. The quick-release mount makes it easy to attach or remove the camcorder. The grooved, tubular 3-section leg design folds down to 26" when not in use. Rubber feet allow for sure footing.

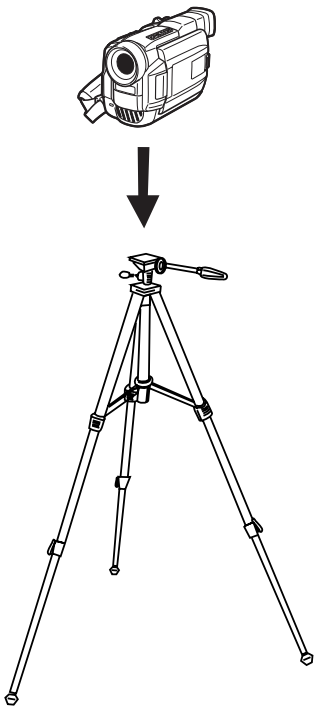

Cautions:

- Before using a tripod, make sure it is stable enough to hold the camcorder without falling over. Do not transport the camcorder attached to the tripod.
- When attaching your camcorder to a tripod, be careful not to force the tripod screw into the camcorder's tripod mounting hole.
- The tripod screw should not protrude into the camcorder more than approximately three-eighths (3/8) of an inch. Forcing the screw could damage the mounting hole on the bottom of the camcorder.

Other Information

To order accessories, contact your local Dealer.

If a dealer is not nearby, you can also follow the directions below to order by telephone or direct-by-mail.

United States and Canada Orders

To place your order by phone, have your Visa, MasterCard, or Discover card ready and call the toll-free number listed below.

Use this number only to place an order for accessory items listed on this order form.

1-800-338-0376

To place your order by mail, detach and mail the completed order form with credit card information, money order, or check in U.S. currency (made payable to Thomson Consumer Electronics, Inc.) to the following address:

Video Accessories

PO Box 8419

Ronks, PA 17573

Accessories Order Form

Description	Part No.	Price	Qty.	Total
Super Lightweight Tripod	AC088	\$ 49.95		
Soft Camcorder Case	AC201A	\$ 34.95		
Shoulder Strap	ACS091	\$ 12.95		
Rechargeable Battery (2 hour) (for CC6384)	244265	\$ 59.99		
Rechargeable Battery (1 hour) (for CC6394)	244427	\$ 49.95		
A/V Cable	VH83	\$ 5.95		
Extended Life Battery	BB99L	\$ 69.99		

All prices subject to change without notice.

Total Merchandise \$ _____

Sales Tax \$ _____

We are required by law to collect the appropriate sales tax for each individual state, county, and locality to which the merchandise is being sent. **5.00**

Shipping and Handling \$ _____

Total Amount Enclosed **\$ _____**

Use VISA, MasterCard, or Discover.
Money order or check must be in U.S.
currency only. No COD or cash.

Detach Here



Please complete other side also

Other Information

Charge your order on your VISA, MasterCard,
or Discover Card by filling in below

USE YOUR CREDIT CARD

IMPORTANT: Copy complete account number from your VISA card

Expiration date:



IMPORTANT: Copy complete account number from your MasterCard

Expiration date:



IMPORTANT: Copy complete account number from your Discover Card

Expiration date:



AUTHORIZED SIGNATURE

Prices are subject to change without notice.

Print or type your name and
address clearly.



A complete and correct order will
save you days of waiting.

Name: _____
Street: _____
_____ Apt: _____
City: _____
State: _____ Zip: _____

Please make sure that both sides of this form have been filled out completely.

- Allow 4 weeks for delivery.
- All accessories are subject to availability.

Detach Here



This Page Left Blank Intentionally

A

- A (audio) and V (video) jacks 54
- Accessories 116
 - order form 119
- Additional notes about S-VHS and S-VHS ET Cassette 24
- Advanced features 80
- Animation 91
- Animation and Time-Lapse recording icons 35
- Area marked close 13
- Audio/video input jacks 54
- Auto Focus 85
- Automatic Recording
 - AutoShot 12

B

- Basic playback 46
- Battery
 - care and storage 19
 - life 19
- Bright and volume icons 34
- Buttons and controls 7

C

- Cassette
 - adapter 51
- Cassettes
 - care and storage 101
 - record protection tab 13
- Charge marker 17
- Charging the battery 16
- Choose your connection 51
- Cleaning 102
- Clock adjustment 22
- Connecting to a TV (or VCR) with A/V inputs 54
- Connecting to a Windows® PC 73
- Counter memory 49
- Customer assistance and service 109

D

- Date and time
 - setting 22
- Date/time insert 89
- Deleting all images 71
- Deleting Images 69
- Deleting select images 69
- Digital and optical zoom 40
- Digital effects 83
- Digital still camera recording and playback 58
- Digital zoom 41

E

- Exposure control 84
- Exposure icons 34
- Eyepiece focus control 29

F

- Fade and wipe icons 34
- Fade/wipe effects 80
- FCC declaration of conformity 115
- Final notes 99
- Focus icons 35
- Focusing 85

G

- Getting started 9

H

- Handstrap
 - adjusting 10

I

- Important information 2
- Index 65
- Index number 65

Index playback 66
Industry Canada information 115
Initializing the built-in memory 70
Insert a cassette tape 13
Instant titles 90

J

Journalistic shooting 38

L

LCD monitor 14, 28
LCD monitor brightness
 adjusting 47
Lens cap
 attaching 10
Limited warranty 111

M

Manual focus 86
Manual white balance 88
Manual White balance icons 33
Menu definitions 77
MENU/BRIGHT dial 14
Menus 76

O

On-screen icons 30
Optical zoom 40
Order form 119
Other icons 35

P

Parts checklist 6
Picture mode 65
Picture quality
 setting 59
Picture quality icon 36

Playback
 basic 46
 normal 64
 still 49
 using cassette adapter 51
Playback on a TV (or VCR) with
 A/V inputs 55
Playback options 46
Plug adapter 20
Power supply 20
 attaching 11
POWER switch 55
Power zoom lever
 volume control 47
Powering the camcorder 12, 16
Preset titles 33
Product registration 2
Program AE with special
 effects 82
Protect icon 66
Protecting images 67

Q

Quick review 39, 63

R

Record protection tab 13
Recording
 icon 15, 38
 playing back 15
Recording and playback icons 31
Recording format
 setting 23
Recording tips 44
Refreshing the battery 18
Removing the battery 18
Removing the power supply 20
Retake 39

S

- S-video and audio connection 54
- Seeing what you are recording 28
- Selected image 66
- Self-recording 39
- Service 109
- Shoulder strap 6, 21
- Shuttle search 50
- Slide show 65
- Snapshot icon 36
- Snapshot mode
 - selecting 60
- Snapshots
 - taking 62
- Speaker volume 47
- Specifications 107
- Start recording 15
- Status icons 33
- Steady Pix icon 35
- Steady Pix™ 41
- Still playback 49
- STOP button 55
- System requirements for Picture Navigator 72

T

- Tape care and storage 104
- Tape dubbing 56
- Tape length
 - setting 26
- Tape length icon 35
- Tape recording speed
 - setting 25
- Tape speed icon 35
- TBC (Time Base Corrector) 48
- TBC (Time Base Corrector)
 - icon 36
- Time counter icon 36
- Time-Lapse 92
- Time-remaining icon 36
- Tips
 - traveling 105
- Title menu 33
- Tracking
 - adjusting 48
- Tracking icons 33
- Traveling tips 106
- Troubleshooting 94
- Turning off the camcorder 16

U

Unprotecting images 68

V

Video light 12, 42

Video light details 42

Viewfinder 14

W

W and T (zoom lever) 40

Warning icons 30

Warranty 111

White balance adjustment 87

Wipes 81

Z

Zoom level icon 34

Zoom lever 34, 40

Zooming

digital 40

optical 40

zoom lever 40

Please do not send any products to the Indianapolis address listed in this manual or on the carton. This will only add delays in service for your product.

 **THOMSON CONSUMER ELECTRONICS**

**10330 North Meridian Street
Indianapolis, IN 46290**

©2001 Thomson Consumer Electronics, Inc.

Trademark(s)® Registered

Marca(s) Registrada(s)

Printed in Japan

TOCOM 1571624B

Part No. LYT0730-001A(VP)

Free Manuals Download Website

<http://myh66.com>

<http://usermanuals.us>

<http://www.somanuals.com>

<http://www.4manuals.cc>

<http://www.manual-lib.com>

<http://www.404manual.com>

<http://www.luxmanual.com>

<http://aubethermostatmanual.com>

Golf course search by state

<http://golfingnear.com>

Email search by domain

<http://emailbydomain.com>

Auto manuals search

<http://auto.somanuals.com>

TV manuals search

<http://tv.somanuals.com>