



VS110

*SEAL·a·meal*  
VACUUM FOOD SEALER



"Saving Families Food, Money, and Time  
for over 35 years...and counting!"

## Owner's Guide

# READ AND SAVE THESE INSTRUCTIONS

## IMPORTANT SAFEGUARDS

When using electrical appliances, basic safety precautions should always be followed, including the following:

1. Read the instructions carefully.
2. Do not use the Food Sealer on wet or hot surfaces, or near a heat source.
3. Do not immerse any part of the Food Sealer, power cord or plug into water or other liquid.
4. To disconnect, unplug the power cord from the electrical outlet. Do not disconnect by pulling on the cord.
5. Do not operate the Food Sealer with a damaged power cord or plug.
6. Do not operate the Food Sealer if it malfunctions or is in any way damaged. If the cord or the machine is damaged, it must be returned to an authorized service center. See warranty for more information.
7. Use only accessories or attachments recommended by Rival®.
8. Use the Food Sealer only for its intended use.
9. Close supervision is required when this product is used near children.
10. This appliance should not be operated by children.
11. Do not allow the Food Sealer to be used as a toy.
12. Do not operate from wall mount position.

## SAVE THESE INSTRUCTIONS

This appliance is for HOUSEHOLD USE ONLY. No user-serviceable parts inside. Power unit never needs lubrication. Do not attempt to service this product. A short power supply cord is provided to reduce the risk resulting from becoming entangled in or tripping over a longer cord.

## SAVE THESE INSTRUCTIONS (CONT.)

An extension cord may be used when care is exercised in its use. When an extension cord is used the marked electrical rating of the electrical cord shall be the same or more than the rating of the sealer. The extension cord shall be arranged so that it does not drape over the counter top where it is capable of being tripped over, snagged, or pulled on unintentionally, especially by children.

Always use Food Sealer on a level, flat surface.

### POLARIZED PLUG



This appliance has a polarized plug (one blade is wider than the other). To reduce the risk of electric shock, this plug is intended to fit into a polarized outlet only one way. If the plug does not fit fully into the outlet, reverse the plug. If it still does not fit, contact a qualified electrician. Do not attempt to modify the plug in any way. If the plug fits loosely into the AC outlet or if the AC outlet feels warm do not use that outlet.

*Thank you for purchasing the Rival® Seal-a-Meal® Vacuum Food Sealer, which has been saving families food, money, and time for over 35 years. Seal-a-Meal® enables you to preserve your food purchases by providing an airtight seal that protects from spoilage and freezer burn for extended periods of time.*

*Your unit includes the following:*

- 1 - Food Sealer
- 2 - 8" x 10' Rolls
- 2 - 11" x 10' Rolls
- 10 - 1-Quart Bags
- 5 - 1-Gallon Bags

*Supplemental rolls and pre-cut bags can be purchased when needed. Additionally, this unit is compatible with Rival® Seal-a-Meal® accessories, including our universal mason jar sealers and canisters with lids. Please visit us at [www.rivalproducts.com](http://www.rivalproducts.com) to learn more about how to purchase bags and accessories, or to learn more about our products in general.*

## KNOW YOUR SEAL-A-MEAL® VACUUM FOOD SEALER

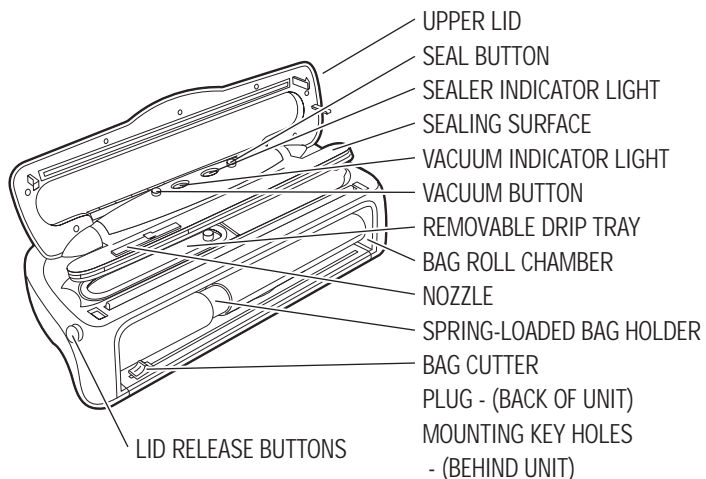

## MOUNTING YOUR SEAL-A-MEAL® VACUUM FOOD SEALER

1. Bore two holes (300 mm apart; 6 mm diameter) along a straight line on the wall.
2. Hammer one screw anchor into each wall hole.
3. Screw the screws into screw anchors leaving 8 mm head outside of the wall.
4. Hang sealer on the screw heads.

**Note:** Mounting is for storage only. The item should not be used on the wall.

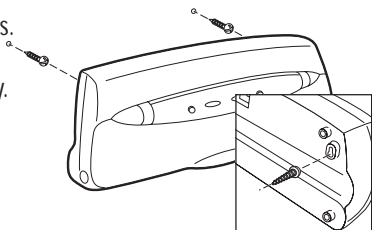

-4-

## ABOUT YOUR SEAL-A-MEAL® BAGS

Seal-a-Meal® bags are provided in two different ways – on customizable Rolls (8" and 11" wide) and pre-cut bags (1-Quart and 1-Gallon sizes). Our durable bags are made of high-density material that can be frozen, boiled, are microwave safe and are reusable. The pattern that appears on the bag helps provide an airtight seal that lasts longer than standard zip or sandwich bags.

## HOW TO USE YOUR SEAL-A-MEAL® VACUUM FOOD SEALER WITH THE INTEGRATED BAG ROLL

1. Plug in the power cord.
2. Open the lid.
3. Place the open end of the Roll onto the sealer surface.
4. Close lid until it locks into place.
5. Press the SEAL BUTTON and The Seal-a-Meal® Vacuum Food Sealer will automatically start sealing that end of the bag.
6. Once the sealing INDICATOR LIGHT goes off, open the lid by pressing the LID RELEASE BUTTONS located at the sides of the unit.
7. Remove bag from unit.
8. Cut a piece from the Roll that is long enough to cover the item you wish to seal, leaving extra room to allow for contraction when the item is sealed. Use the integrated BAG CUTTER located along the front of the unit to ensure a safe, even cut.
9. Place item you wish to seal into bag. Make sure item is laying flat, or is placed how you want it to be stored.
10. Open the lid.

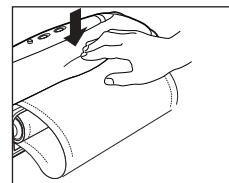
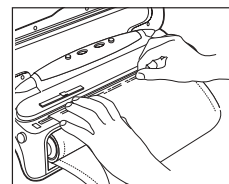
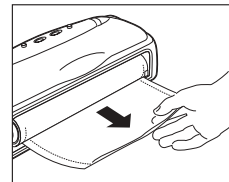

-5-

## HOW TO USE YOUR SEAL-A-MEAL® VACUUM FOOD SEALER WITH THE INTEGRATED BAG ROLL (CONT.)

- Place the open end of the bag around the NOZZLE so it is completely inside the bag (See Fig.1).

**Hint:** Align the left side of the bag with the left edge of the NOZZLE.

- Close lid until it is locked into place.

- Press the VACUUM BUTTON and The Seal-a-Meal® Vacuum Food Sealer will now vacuum the air out of the bag. The VACUUM INDICATOR LIGHT will go ON. Once all of the air is removed, the unit will automatically switch to sealing, making sure the bag is securely heat-sealed. The SEALING INDICATOR LIGHT will go ON. Once the bag is completely sealed both lights will go OFF and the motor stops automatically.

- Once the lights go OFF, open the lid by pressing the LID RELEASE BUTTONS located at the sides of the unit.

**WARNING:** Even though element is not powered when lid is opened, it may still be hot!

- Remove bag from unit and store in the refrigerator, freezer, cabinet, etc.

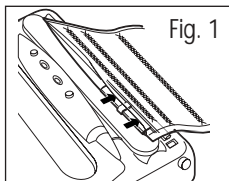

## HOW TO USE YOUR SEAL-A-MEAL® VACUUM FOOD SEALER WITH THE INDIVIDUAL BAGS

- Plug in the power cord.
- Place item you wish to seal into bag. Make sure item is flat, or is placed how you want it to be stored.
- Open the lid.
- Place the open end of the bag around the NOZZLE so that it is completely inside the bag (See Fig.1).

**Hint:** Align the left side of the bag with the left edge of the NOZZLE.

## HOW TO USE YOUR SEAL-A-MEAL® VACUUM FOOD SEALER WITH THE INDIVIDUAL BAGS (CONT.)

- Close lid until it is locked into place.
- Press the VACUUM BUTTON and The Seal-a-Meal® Vacuum Food Sealer will now vacuum the air out of the bag. The VACUUM INDICATOR LIGHT will go ON. Once all of the air is removed, Seal-a-Meal® will automatically switch to sealing, making sure the bag is securely heat-sealed. The SEALING INDICATOR LIGHT will go ON. Once the bag is completely sealed both lights will go OFF and the motor stops automatically.
- Once the lights go OFF, open the lid by pressing the LID RELEASE BUTTONS located at the sides of the unit.
- Remove bag from unit and store in the refrigerator, freezer, cabinet, etc.

**WARNING:** Even though element is not powered when lid is opened, it may still be hot!

**Note:** The unit has a cool down period between vacuuming cycles. This will last approximately 30 seconds. Your unit will not vacuum during this period. After 30 seconds the unit will be able to vacuum seal once again.

### Hints

- Liquids should be frozen prior to vacuum sealing.
- Freeze foods that are soft, such as cakes, pies, dips, mashed potatoes, etc. so they maintain their shape when sealed.
- Remove excess juices before sealing when possible.
- Be sure to empty and clean drip tray prior to storing your food sealer.

## HOW TO USE YOUR SEAL-A-MEAL® VACUUM FOOD SEALER TO SEAL BAGS WITHOUT VACUUMING

- Place item in bag.
- Load bag on sealing surface.
- Close lid.
- Press SEAL BUTTON.

### REPLACING THE INTEGRATED ROLLS

1. The bag holder is spring-loaded. Place your hand on one end of the holder, using your other hand to push one end of the holder into the other until it is no longer connected in the slot.
  2. Pull open end of holder away from BAG ROLL CHAMBER, while simultaneously pulling the holder out of the slot located on the opposite end of the BAG ROLL CHAMBER.
  3. Slide bags onto the holder.
  4. Place one end of holder back into the slot located within the BAG ROLL CHAMBER.
- Note:** Make sure bags are positioned to roll out from the bottom of the roll rather than the top.
5. Push in open end of holder so that it retracts into the other end.
  6. Align the holder with the slot on the open end.
  7. Release open end of holder until it connects into the open slot.

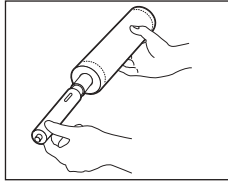
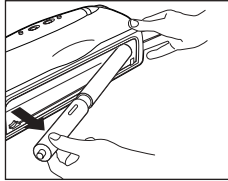

### REPLACING THE BLADE IN YOUR INTEGRATED BAG CUTTER

1. Unscrew the three screws from the bottom panel.
2. Remove the bottom panel.
3. Replace the old knife blade with the new one.
4. Close the bottom panel.
5. Use screw driver to screw tightly the three screws.

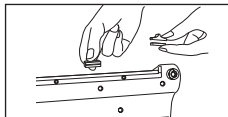
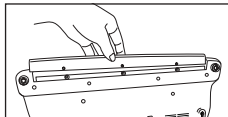
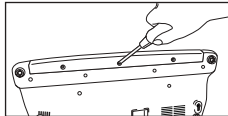

### CARE AND CLEANING

#### CLEANING THE FOOD SEALER

- Always unplug the unit before cleaning.
- Always remove from wall mounted position prior to cleaning.
- Do not immerse in water.
- Do not use abrasives to clean the unit.
- Wipe the outside of the unit with a damp cloth and soap.
- To clean the inside of the unit, wipe away any food or liquid with a paper towel.
- Dry thoroughly before using again.

#### CLEANING THE REMOVABLE DRIP TRAY

The Seal-a-Meal® Vacuum Food Sealer is equipped with a REMOVABLE DRIP TRAY that allows you to thoroughly clean it between uses. When storing foods such as beef or chicken, juices tend to collect on the drip tray. Follow these simple instructions to do so:

- Lift tab on one end of the REMOVABLE DRIP TRAY to release it from the drip tray compartment.

**Note:** Take care not to spill inside the drip tray compartment.

- Clean the tray with soap and warm water.
- Thoroughly dry the REMOVABLE DRIP TRAY prior to placing back into the drip tray compartment.
- Align the center of the REMOVABLE DRIP TRAY with the vacuum port in the center of the drip tray compartment, so that the tab is on the right and the drip tray is beneath the NOZZLE.
- Press down on the center until it is securely fastened in the drip tray compartment.

**HINT:** The REMOVABLE DRIP TRAY can be placed in the dishwasher for thorough cleaning if desired.

## CARE AND CLEANING (CONT.)

**NOTE:** The **NOZZLE** and **REMOVABLE DRIP TRAY** contains Microban antimicrobial protection, which inhibits the growth of stain and odor causing bacteria and keeps the unit cleaner between cleanings. Normal cleaning practices should be maintained. Does not protect user from food borne illnesses.

### CLEANING THE BAGS

- Wash bags in warm, soapy water.
- Bags can be washed in the dishwasher if desired. Turn bags inside out and spread them over the top rack.
- Allow bags to dry completely before using.

**Note:** If bags have been used to store chicken, meat, etc. it is not recommended to reuse them.

## TIPS AND TRICKS

**BUY IN BULK AND KEEP IT FRESH FOR EXTENDED PERIODS OF TIME WITH SEAL-A-MEAL® VACUUM FOOD SEALER**

- Buying in bulk can save you thousands of dollars per year. See this chart below...
- Save over 20 times your initial investment in the Seal-a-Meal® Vacuum Food Sealer

**BULK FOOD COMPARISON CHART**

ITEM	APPROXIMATE STANDARD PKG PRICE /LB	APPROXIMATE BULK PKG PRICE/LB	% SAVINGS PER LB	\$ SAVINGS PER LB	APPROXIMATE POUNDS PURCHASED PER YEAR (4 people)	TOTAL FOOD SAVINGS
Beef(USDA Choice)	\$5.99	\$4.49	25 %	\$1.50	225	\$336.94
Poultry(Chicken Breasts)	\$4.49	\$3.37	25 %	\$1.12	225	\$252.56
Pork	\$4.69	\$3.52	25 %	\$1.17	100	\$117.25
Fish	\$6.99	\$5.59	20 %	\$1.40	50	\$69.90
Cheeses	\$4.49	\$3.14	30 %	\$1.35	125	\$168.38
Fruits	\$4.99	\$3.74	25 %	\$1.25	500	\$623.75
Vegetables	\$1.99	\$1.49	25 %	\$0.50	1,000	\$497.50
Coffee(Beans)	\$8.99	\$5.99	33 %	\$3.00	15	\$45.00
						\$2,111.28

## TIPS AND TRICKS (CONT.)

### PREPARE MEALS IN ADVANCE

- Prepare large quantities of food, and then divide into meal-size portions. Seal in bags for tomorrow, next week, next month, etc.

### KEEP LEFTOVERS AS FRESH AS THE DAY THEY WERE PREPARED

- After dinner, store leftovers in a Seal-a-Meal® bag, and keep in refrigerator or freezer for a later date.

Your Seal-a-Meal® Vacuum Food Sealer is equipped to work with external canisters and mason jars. Please visit our website to purchase a Seal-a-Meal® accessory kit and to learn more about our products.

### PERFECT FOR FISHING AND HUNTING

- Keep your catch fresh for when you're ready to prepare them as a meal. Seal-a-Meal® Vacuum Food Sealer keeps them fresh and prevents freezer burn during extended periods of time in the freezer.

### IT'S NOT JUST FOR FOOD

- Store clothing in Seal-a-Meal® bags to prevent potential damage when stored in an attic or closet.
- Protect valuable documents, photos, etc. by sealing them in an airtight Seal-a-Meal® bag.
- Place cardboard or some stiff material on both sides of your documents or photos to ensure that they maintain their continuity and shape.
- Keep your belongings clean and dry during boating or camping outings. Simply seal your clothing or materials prior to your trip for an airtight seal when packed.

## TROUBLESHOOTING

### NOTHING HAPPENS WHEN I PRESS THE VACUUM BUTTON

- 1) Make sure the power cord is correctly plugged into the electrical outlet.
- 2) Make sure the power cord is not damaged in any way.
- 3) Make sure the electrical outlet is operative by plugging in another appliance. If it is not, please check the circuit breakers or fuses in your home.
- 4) The unit is equipped with a cool down period between vacuum cycles. Please wait 30 seconds and try again.

### AIR IS NOT REMOVED FROM THE BAG

- 1) Make sure the NOZZLE is completely inside the bag (refer to the "How to Use Your Food Sealer" section of the manual to determine if you are doing it correctly).
- 2) Check that the bag is sealed at one end and has no holes. Seal the bag with air in it and put it in water. Apply pressure to the bag. If there are bubbles present there is a leak, and a new bag should be used.
- 3) Verify that the REMOVABLE DRIP TRAY is in the drip tray compartment and seated properly (refer to "How to Clean the Removable Drip Tray" section of the manual).
- 4) Make sure lid is completely latched into place.

### AIR WAS INITIALLY REMOVED FROM THE BAG, BUT SOME HAS SINCE ENTERED THE BAG

- 1) Check the seal of the bag. There may be a hole or wrinkle that is allowing air to re-enter the bag. Carefully cut the bag open and re-seal it, or use an entirely new bag.
- 2) Make sure there is no moisture or juices from the food present within the bag. You may need to cut open the bag and re-seal it, or use an entirely new bag. Foods with excess liquids should be frozen prior to vacuum sealing. Please refer to the "Hints" section on page 7.

-12-

## TROUBLESHOOTING (CONT.)

- 3) Make sure there were no food items with sharp edges that may have punctured the bag. If you find a puncture hole seal the item in an entirely new bag.

### THE BAG MELTS

- 1) The sealing strip may have been too hot during the sealing process. Allow the unit to cool for 30 seconds between uses. If the bag continues to melt, allow unit to cool with the lid in the upright position for 1-2 minutes before using.

### THE BAG WILL NOT SEAL

See "Air Was Initially Removed from Bag" section on previous page.

**Note:** In the event the bag does not seal, the seal button can be manually pressed during the vacuum process to seal the bag.

## MARINATING IDEAS

The Food Sealer can be used to quickly marinate foods more thoroughly than standard marinating methods. Simply prepare a marinade (see suggestions below), and vacuum seal it along with the food in a Seal-a-Meal® Bag.

### ZESTY LIME MARINADE

½ cup of fresh lime juice  
 2 lbs. grated lime peel  
 ½ cup of olive oil  
 2 cloves of garlic - minced  
 ¼ cup of cilantro – chopped fresh  
 2 tsp. of red pepper flakes  
 Salt & pepper to taste

In a bowl, stir all ingredients until well blended. This is enough marinade for 2 pounds and works well with chicken, beef, fish or shrimp.

-13-

## MARINATING IDEAS (CONT.)

### JERK MARINADE

1 white onion, chopped  
 ¼ cup of scallions, chopped  
 2 tsp. of thyme  
 3 tsp. of brown sugar  
 1 tsp. of allspice  
 ¼ tsp. of ground nutmeg  
 1 tsp. black pepper  
 2 tsp. of red pepper flakes  
 ¼ cup of light soy sauce  
 ¼ cup of vegetable oil  
 3 lbs. of balsamic vinegar  
 ¼ tsp. of Tabasco sauce

Combine all ingredients in a food processor. Using the pulse switch or low speed mix ingredients until completely blended. This is enough marinade for 2 pounds and excellent with all food, especially chicken and beef.

### GARLIC ROSEMARY MARINADE

¼ cup of fresh rosemary, chopped  
 5 cloves of garlic, chopped  
 ½ cup of fresh lemon juice  
 ½ cup of extra virgin olive oil  
 Salt & pepper to taste

Combine all ingredients in a food processor using the pulse button or the low speed or mix ingredients in a bowl. Do not over process; visible pieces of rosemary should remain. Works best with lamb, chicken or pork.

## MARINATING IDEAS (CONT.)

### CITRUS MARINADE

Zest of 1 lemon – reserve the juice  
 Zest of 1 orange – reserve the juice  
 ¼ cup of Soy sauce  
 2 tbs. Ginger root – chopped  
 4 garlic cloves  
 ¼ cup of honey

Combine the juice of the orange and lemon with the soy sauce in a bowl. Add the remaining ingredients into the bowl. Use a whisk to mix all of the ingredients. This is enough marinade for 2 pounds and works best with pork or chicken.

### BOURBON MARINADE

½ cup sugar, brown  
 ½ cup Dijon mustard  
 ½ cup bourbon  
 ½ cup soy sauce  
 1 clove of garlic chopped  
 2 tbs. Worcestershire sauce  
 1 medium onion chopped  
 Pepper to taste

In a bowl whisk the sugar, mustard, bourbon and soy sauce. When well blended stir the remaining ingredients in. This is enough marinade for 2 pounds and can be used for any beef, chicken, pork or shellfish.

### SPICY RUM MARINADE

2 Jalapeno pepper- stems and seeds removed  
 ¾ cup of dark rum  
 ½ cup of lime juice  
 ¾ cup of vegetable oil  
 ¼ cup tbs. of cilantro, chopped  
 4 cloves of garlic minced  
 1 tsp. of red pepper flakes

In a food processor or blender puree the pepper, rum and lime juice. Then add the remaining ingredients. This is enough marinade for 2 pounds and works best with shrimp, chicken or beef.



### LIMITED ONE-YEAR WARRANTY

Rival® warrants this product to be free from defects in materials or workmanship for one (1) year from date of original purchase. If you have a claim under this warranty please follow these procedures:

- 1) Within the first 45 days from date of original purchase, defective product should be returned to original place of purchase for replacement (with proof-of-purchase).
- 2) Within the first 12 months from date of purchase Rival will repair or replace (at no charge) the defective product if it is delivered freight prepaid during that period to an authorized service station. To obtain warranty service visit:

[www.rivalproducts.com](http://www.rivalproducts.com)

Or, you may write to Rival c/o The Holmes Group, attention: Consumer Returns, 32 B Spur Drive, El Paso, TX 79906. Proof of purchase is required when requesting warranty service - SAVE YOUR SALES RECEIPT. This warranty is extended only to the original purchaser and does not apply to commercial use, unreasonable use, or to damage to the product (not resulting from defect or malfunction) while in the possession of the consumer. **Rival disclaims all responsibility for consequential, incidental, or commercial losses caused by the use of this product.** Some states do not allow this exclusion or limitation of incidental or consequential losses, so the foregoing disclaimer may not apply to you. This warranty gives you specific legal rights, and you may also have other legal rights which vary from state to state.



©2003, Rival®

A Division of The Holmes Group

MICROBAN is a registered trademark of  
Microban Products Company.

Printed in China

VS110/428-0320  
VS11003EM2

## Free Manuals Download Website

<http://myh66.com>

<http://usermanuals.us>

<http://www.somanuals.com>

<http://www.4manuals.cc>

<http://www.manual-lib.com>

<http://www.404manual.com>

<http://www.luxmanual.com>

<http://aubethermostatmanual.com>

Golf course search by state

<http://golfingnear.com>

Email search by domain

<http://emailbydomain.com>

Auto manuals search

<http://auto.somanuals.com>

TV manuals search

<http://tv.somanuals.com>