

# OPERATOR'S MANUAL

## Expand-it™

### Hedge Trimmer Attachment

#### UT15703A

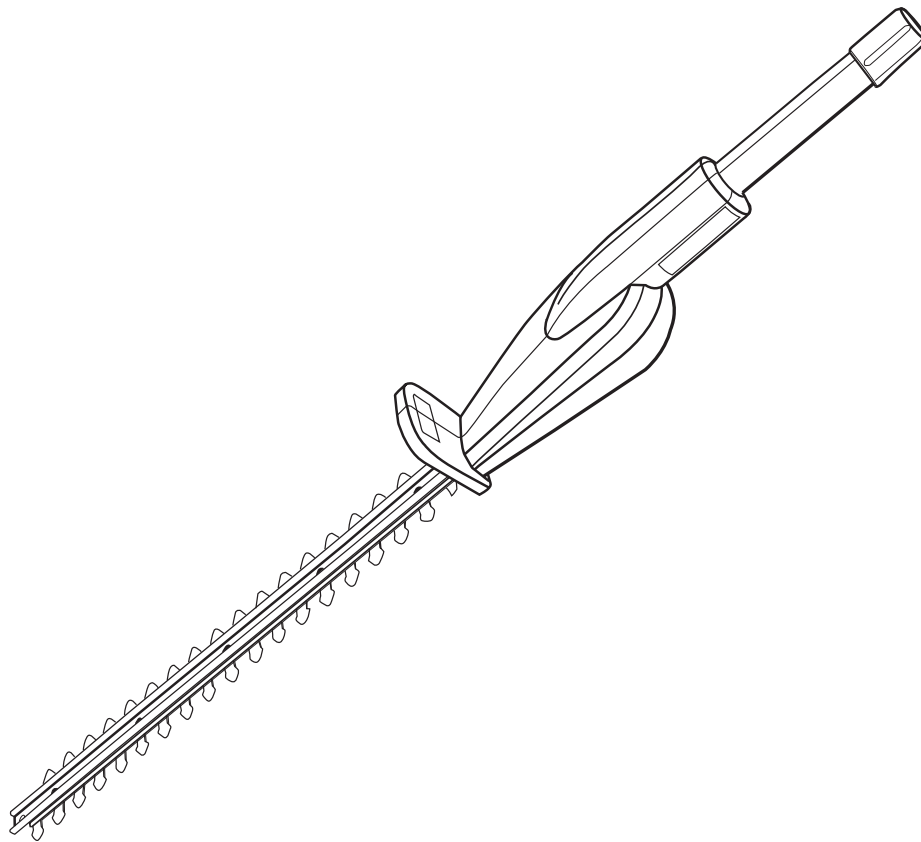

Your Expand-it™ Hedge Trimmer Attachment has been engineered and manufactured to a high standard for dependability, ease of operation, and operator safety. When properly cared for, it will give you years of rugged, trouble-free performance.



**WARNING:** To reduce the risk of injury, the user must read and understand the operator's manual before using this product.

Thank you for buying an Expand-it™ Product.

---

## SAVE THIS MANUAL FOR FUTURE REFERENCE

---

# TABLE OF CONTENTS

---

■ Introduction.....	2
■ General Safety Rules .....	3
■ Specific Safety Rules.....	3
■ Symbols .....	4
■ Features .....	5
■ Assembly .....	7
■ Operation .....	7-8
■ Maintenance .....	9
■ Exploded View and Parts List.....	10
■ Warranty.....	11
■ Parts, Ordering, and Service.....	12

## INTRODUCTION

---

With the Expand-it™ Hedge Trimmer Attachment you can create a professionally landscaped look for your yard. Safety, performance, and dependability have been given top priority in the design of this hedge trimmer attachment making it easy to maintain and operate.

# GENERAL SAFETY RULES

---

## **WARNING:**

**Read and understand all instructions.** Failure to follow all instructions listed below, may result in electric shock, fire, and/or serious personal injury.

## SAVE THESE INSTRUCTIONS

- Read these instructions and the instructions for the power head thoroughly before using hedge trimmer.
- Know the tool. Read and understand the operator's manual and observe the warnings and instruction labels affixed to the tool.
- Do not allow children or untrained individuals to use this unit.
- Wear safety glasses or goggles that are marked to comply with ANSI Z87.1 standards and hearing protection when operating this unit.
- Wear heavy long pants, boots, and gloves. Do not wear loose fitting clothing, short pants, jewelry of any kind, or go barefoot.
- Secure long hair so it is above shoulder level to prevent entanglement in any moving parts.
- Keep all bystanders, children, and pets at least 50 ft. away.
- Stay alert, watch what you are doing, and use common sense when operating a power tool. Do not use tool while tired or under the influence of drugs, alcohol, or medication. A moment of inattention while operating power tools may result in serious personal injury.
- Do not operate in poor lighting.
- Do not overreach. Keep proper footing and balance at all times. Proper footing and balance enables better control of the tool in unexpected situations.
- Keep all parts of your body away from any moving part.
- Do not touch areas around the muffler or cylinder of the power head. These parts get hot from operation. Failure to heed this warning could result in possible serious personal injury.
- Always stop the engine and remove the spark plug wire or disconnect from power supply before making any adjustments or repairs except for carburetor adjustments.
- Inspect unit before each use for loose fasteners and damaged or missing parts. Correct before using the hedge trimmer attachment. Failure to do so can cause serious injury.
- Use only original manufacturer's replacement parts. Failure to do so may cause poor performance, possible injury, and will void your warranty.
- Do not, under any circumstance, use any attachment or accessory on this product, which was not provided with the product, or identified as appropriate for use with this product in the operator's manual.
- Avoid dangerous environments. Do not use the attachment in damp or wet locations. Do not use in rain.
- Use the right attachment. Do not use attachment for any job except that for which it is intended.
- Do not use on a ladder or unstable support. Stable footing on a solid surface enables better control of the tool in unexpected situations.
- Do not force the hedge trimmer. It will do the job better and with less likelihood of a risk of injury at the rate for which it was designed.
- Keep hands away from cutting area. Keep hands away from blades. Do not reach underneath work or around or over the blade while blade is rotating. Do not attempt to remove cut material when blade is moving.
- Blade coasts after being turned off.







## SPECIFIC SAFETY RULES

---



- Use heavy gloves when operating the hedge trimmer and when installing or removing blades.
- Always stop the engine and remove the spark plug wire before attempting to remove any obstruction caught or jammed in the blade or before removing and installing the blade.
- Replace any blade that has been damaged. Always make sure blade is installed correctly and securely fastened before each use. Failure to do so can cause serious injury.
- Never cut any material over 3/8 in. diameter.
- Maintain a firm grip on both handles while cutting with a blade. Keep the blade away from body.
- Do not use trimmer without front handles in place. Keep both hands on handles when the unit is in use.
- To avoid accidental starting, never carry the unit with the engine running.
- To prevent electrical shock or serious personal injury, do not use this product with any AC power head.
- Save these instructions. Refer to them frequently and use them to instruct others who may use this tool. If you loan someone this tool, loan them these instructions also to prevent misuse of the product and possible injury.

# SYMBOLS

Some of the following symbols may be used on this tool. Please study them and learn their meaning. Proper interpretation of these symbols will allow you to operate the tool better and safer.

SYMBOL	NAME	EXPLANATION
	Safety Alert Symbol	Precautions that involve your safety.
	Read Your Operator's Manual	To reduce the risk of injury, user must read and understand operator's manual before using this product.
	Eye, Hearing and Head Protection	Always wear safety goggles or safety glasses with side shields or a full face shield, as well as hearing protection when operating this product.
	Keep Bystanders Away	Always keep bystanders at least 50 ft. away.
	Hot Surface	To reduce the risk of injury or damage, avoid contact with any hot surface.
	Sharp Blade	Sharp cutting blades. To prevent serious injury, do not touch cutting blades.
	Risk of Electrocution	DANGER! Risk of electrocution!

The following signal words and meanings are intended to explain the levels of risk associated with this product.

SYMBOL	SIGNAL	MEANING
	<b>DANGER:</b>	Indicates an imminently hazardous situation, which, if not avoided, will result in death or serious injury.
	<b>WARNING:</b>	Indicates a potentially hazardous situation, which, if not avoided, could result in death or serious injury.
	<b>CAUTION:</b>	Indicates a potentially hazardous situation, which, if not avoided, may result in minor or moderate injury.
	<b>CAUTION:</b>	(Without Safety Alert Symbol) Indicates a situation that may result in property damage.

## SERVICE

Servicing requires extreme care and knowledge and should be performed only by a qualified service technician. For service we suggest you return the product to your nearest **AUTHORIZED SERVICE CENTER** for repair. When servicing, use only identical replacement parts.



### WARNING:

To avoid serious personal injury, do not attempt to operate this product until you read thoroughly and understand completely the operator's manual. Save this operator's manual and review frequently for continuing safe operation and instructing others who may use this product.



### WARNING:



The operation of any power tool can result in foreign objects being thrown into your eyes, which can result in severe eye damage. Before beginning power tool operation, always wear safety goggles or safety glasses with side shields, or a full face shield when needed. We recommend Wide Vision Safety Mask for use over eyeglasses or standard safety glasses with side shields. Always use eye protection which is marked to comply with ANSI Z87.1.

## SAVE THESE INSTRUCTIONS

# FEATURES

## PRODUCT SPECIFICATIONS

Cutting Capacity..... 3/8 in.

Effective Cutting Area..... 17-1/2 in.

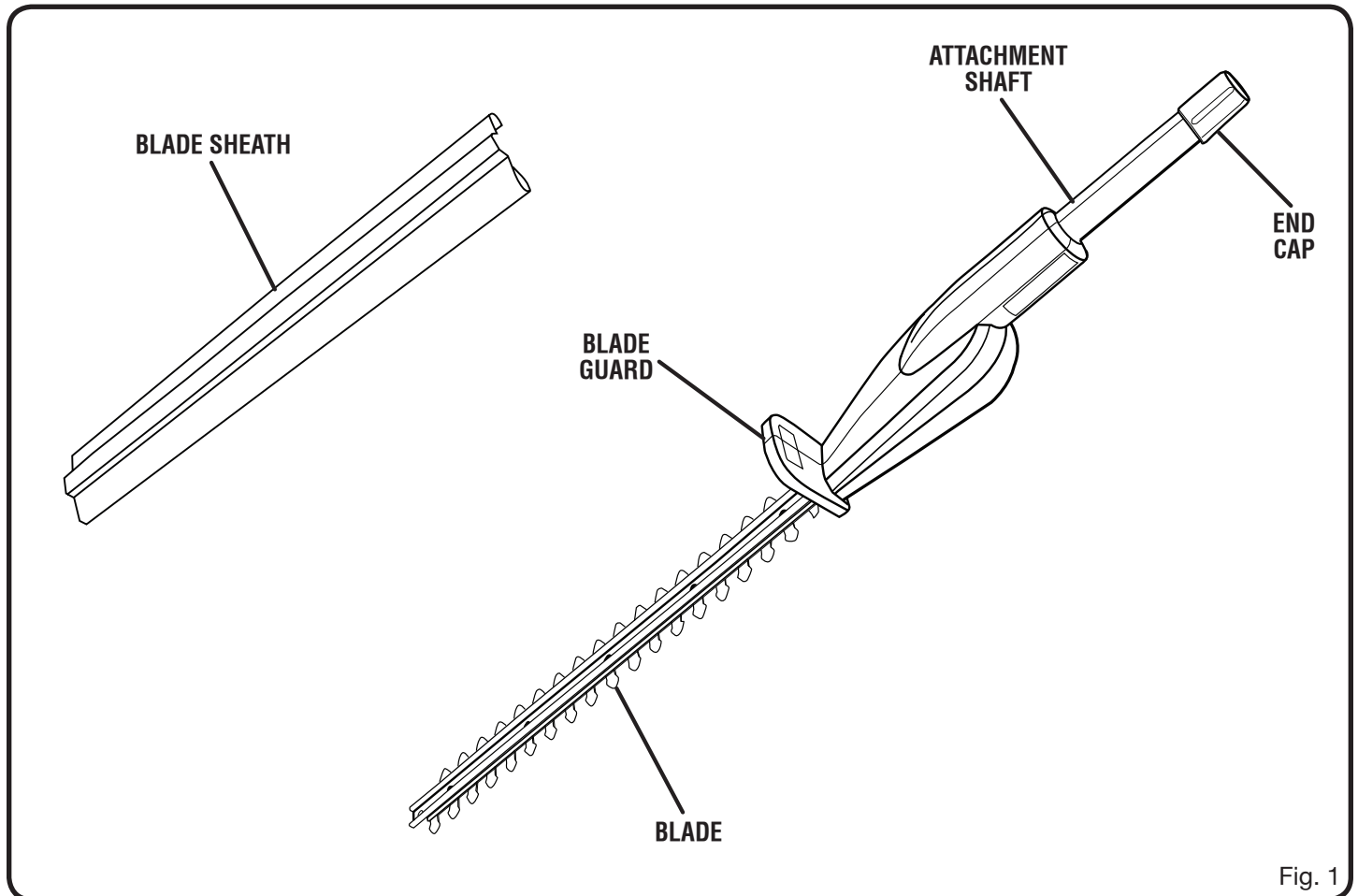

Fig. 1

## KNOW YOUR HEDGE TRIMMER ATTACHMENT

See Figure 1.

Before using this product, familiarize yourself with all operating features and safety requirements.

## BLADE SHEATH

Always use the blade sheath to cover the blade when the trimmer attachment is not in use.

# ASSEMBLY

## UNPACKING

This product has been shipped completely assembled.

- Carefully remove the items from the box. Make sure that all items listed in the packing list are included.
- Inspect the product carefully to make sure no breakage or damage occurred during shipping.
- Do not discard the packing material until you have carefully inspected and satisfactorily operated the tool.
- If any parts are damaged or missing, please call 1-800-242-4672 for assistance.

## PACKING LIST

Expand-it™ Hedge Trimmer Attachment  
(Completely Assembled)

Blade Sheath

Hanger Cap

Operator's Manual

### **⚠ WARNING:**

If any parts are damaged or missing, do not operate this tool until the parts are replaced. Failure to heed this warning could result in serious personal injury.

### **⚠ WARNING:**

Do not attempt to modify this tool or create accessories not recommended for use with this tool. Any such alteration or modification is misuse and could result in a hazardous condition leading to possible serious personal injury.

### **⚠ WARNING:**

Do not connect to power head until assembly is complete. Failure to comply could result in accidental starting and possible serious personal injury.

### **⚠ WARNING:**

Do not remove the blade sheath until the hedge trimmer is fully assembled and ready to use. Failure to comply could result in possible serious personal injury.

## ATTACHING THE HEDGE TRIMMER ATTACHMENT TO THE POWER HEAD

See Figure 2.

### **⚠ WARNING:**

Never attach or adjust any attachment while power head is running. Failure to stop the engine may cause serious personal injury.

The hedge trimmer attachment connects to the power head by means of a coupler device.

- Loosen the knob on the coupler of the power head shaft and remove the end cap from the attachment shaft.
- Push in the button located on the hedge trimmer attachment. Align the button with the guide recess on the extension shaft coupler and slide the two shafts together. Rotate hedge trimmer attachment until button locks into the positioning hole.
- Tighten the knob securely.

**NOTE:** If the buttons do not release completely in the positioning holes, the shafts are not locked into place. Slightly rotate from side to side until the button is locked into place.

**NOTE:** Use only the specified positioning hole for this attachment.

### **⚠ WARNING:**

Be certain the knob is fully tightened before operating equipment. Check it periodically for tightness during use to avoid serious injury.

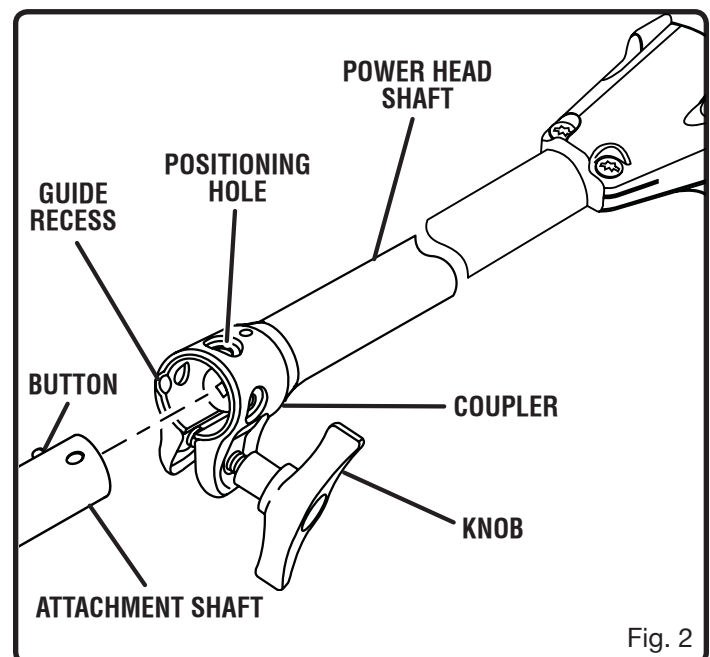

Fig. 2

# ASSEMBLY

## REMOVING THE ATTACHMENT FROM THE POWER HEAD

For removing or changing the attachment:

- Loosen the knob.
- Push in the button and twist the shafts to remove and separate ends.

## ATTACHING THE STORAGE HANGER

See Figure 3.

There are two ways to hang the attachment for storage.

- To use the hanger cap, push in the button and place the hanger cap over end of the lower end attachment shaft. Slightly rotate the cap from side to side until the button locks into place.
- The secondary hole in the attachment shaft can be used for hanging purposes as well.

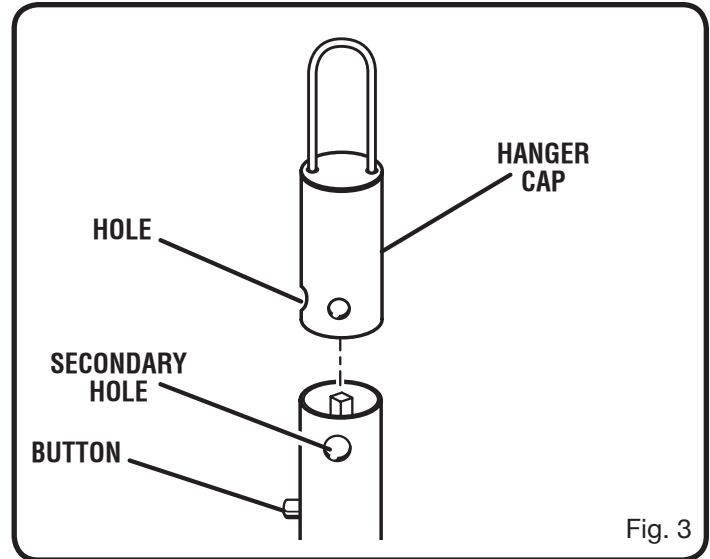

Fig. 3

# OPERATION

### **WARNING:**

Do not allow familiarity with tools to make you careless. Remember that a careless fraction of a second is sufficient to inflict serious injury.

### **WARNING:**

Always wear safety goggles or safety glasses with side shields when operating power tools. Failure to do so could result in objects being thrown into your eyes resulting in possible serious injury.

### **WARNING:**

Do not use any attachments or accessories not recommended by the manufacturer of this tool. The use of attachments or accessories not recommended can result in serious personal injury.

### **WARNING:**

Hedge trimmer blades are extremely sharp. Do not remove the blade sheath until the hedge trimmer is fully assembled and ready to use. Always use caution when removing the blade sheath. Failure to comply could result in possible serious personal injury.

## APPLICATIONS

You may use this tool for the purpose listed below:

- Trimming and shaping hedges and shrubbery

## OPERATING TIPS

See Figures 4 - 5.

### **WARNING:**

Always keep both hands on the hedge trimmer handles. Never hold shrubs with one hand and operate hedge trimmer with the other. Failure to heed this warning can result in serious injury.

### **WARNING:**

Clear the area to be cut before each use. Remove all objects such as cords, lights, wire, or string which can become entangled in the cutting blade and create a risk of serious personal injury.

# OPERATION

## **⚠ WARNING:**

To avoid burns from hot surfaces, never operate unit with the bottom of the engine above waist level.

- Do not force the hedge trimmer through heavy shrubbery. This can cause the blades to bind and slow down. If the blades slow down, reduce the pace.
- Do not attempt to cut stems or twigs that are larger than 3/8 in. thick, or those obviously too large to feed into the cutting blade. Use a non-powered hand saw or pruning saw to trim large stems.
- If blades do become jammed, stop the engine, allow the blades to stop, and remove the obstruction.
- If desired, you can use a string to help cut your hedge level. Decide how high you want the hedge. Stretch a piece of string along the hedge at the desired height. Trim the hedge just above the guide line of string. Trim the side of a hedge so that it will be slightly narrower at the top. More of the hedge will be exposed when shaped this way, and it will be more uniform.
- Always wear gloves when using the hedge trimmer. When trimming new growth, use a wide sweeping action, so that the stems are fed directly into the cutting blade. Older growth will have thicker stems and will be trimmed easiest by using a sawing movement.

## OPERATING THE HEDGE TRIMMER

See Figure 6.

## **⚠ WARNING:**

Read the safety information for safe operation using the blade. Extreme care must be taken when using blades to ensure safe operation. Refer to *Specific Safety Rules*.

- Always hold hedge trimmer with both hands when operating. Use a firm grip on the handles. The unit is used for cutting in either direction in a slow, sweeping action from side to side.
- The hedge trimmer should be positioned so that your body will not come into contact with the muffler on the power head. Stand so that you are stable and balanced on both feet.
- Inspect and clear the area of any hidden objects.
- Never use the hedge trimmer near power lines, fencing, posts, buildings, or other immovable objects.
- Never use a blade after hitting a hard object without first inspecting it for damage. Do not use if any damage is detected.

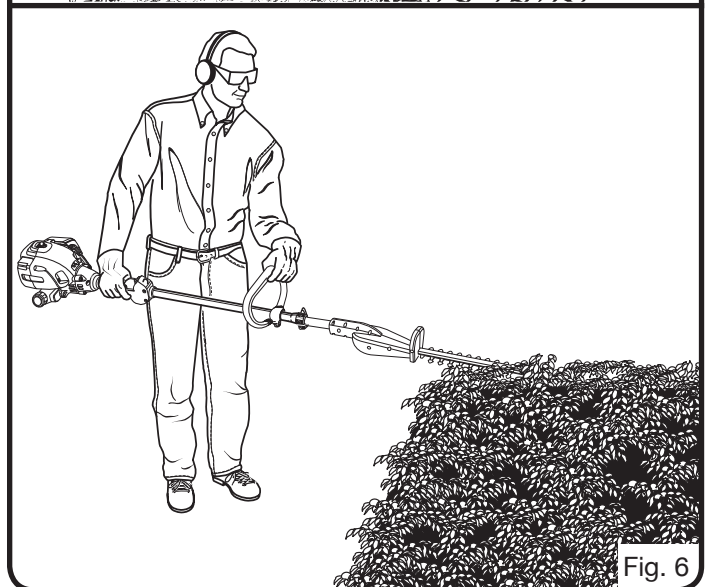
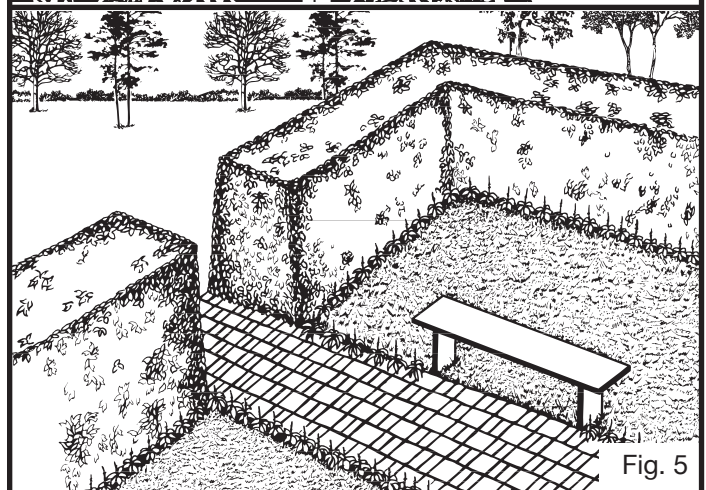



# MAINTENANCE

## **WARNING:**

When servicing, use only identical replacement parts. Use of any other parts may create a hazard or cause product damage.

## **WARNING:**

Always wear safety goggles or safety glasses with side shields during power tool operation or when blowing dust. If operation is dusty, also wear a dust mask.

## **WARNING:**

Blades are sharp. To reduce the possibility of serious injury, always wear gloves when performing maintenance on the hedge trimmer blades. When handling blade assembly, do not place your hand or fingers between blades or in any position where they could get pinched or cut. NEVER touch blades or perform maintenance while the hedge trimmer attachment is attached to the engine.

## BLADE CARE

- Lubricate the cutting blade after each use.
- Periodically inspect the blade for damage and wear.
- If it becomes necessary to have the blade replaced, take the hedge trimmer to an authorized service center.

## LUBRICATING THE BLADE

See Figure 7.

For easier operation and longer blade life, lubricate the blade before and after each use.

- Lay hedge trimmer on a flat surface.

- Use a brush to remove debris or clippings from the blade. Wipe any remaining debris away with a clean cloth.
- Apply light weight machine oil along the edge of the top blade. Wipe any excess oil from the blade.

Occasionally, you should oil the hedge trimmer during use. Before oiling, stop the hedge trimmer, remove the attachment, then oil. You can then resume trimming. Do not oil while hedge trimmer is running.

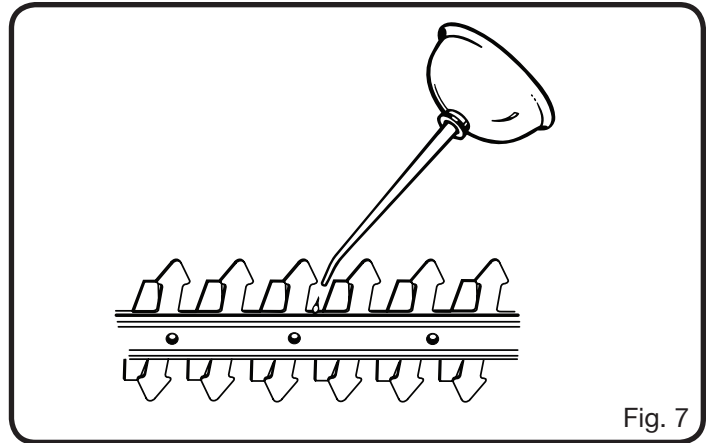
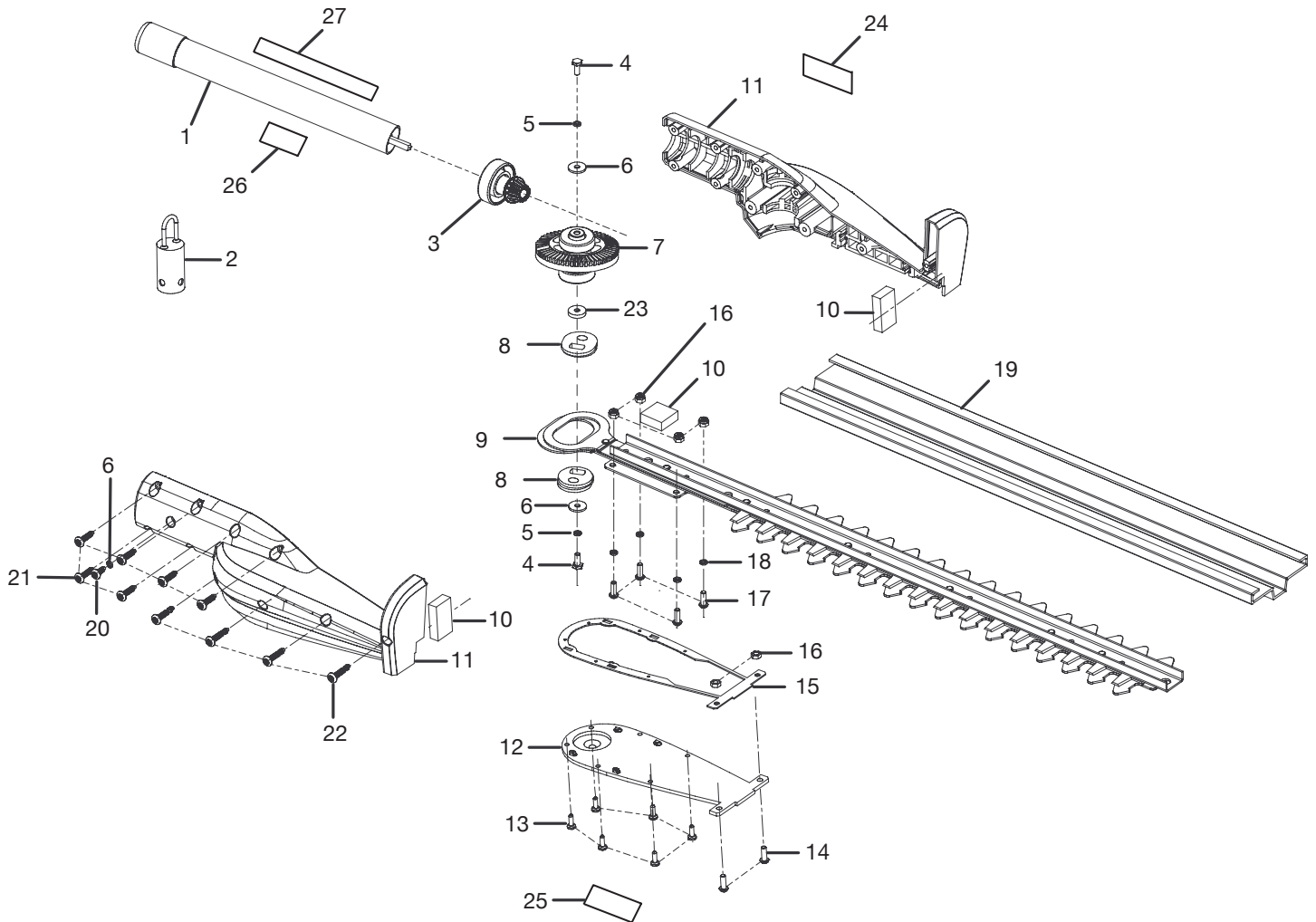

Fig. 7

## STORING THE HEDGE TRIMMER

- Clean the hedge trimmer thoroughly and lubricate before storing.
- Store the hedge trimmer in a dry, well-ventilated place that is inaccessible to children.
- Keep away from corrosive agents such as garden chemicals and de-icing salts.
- Always place the blade sheath on the cutting blade before storing or when the hedge trimmer is not in use.

# EXPLODED VIEW AND PARTS LIST



Key No.	Part Number	Description	Qty.	Key No.	Part Number	Description	Qty.
1	308828001	Lower Drive Shaft Assembly.....	1	17	660924002	* Screw (M4 x 16 mm).....	4
2	518019001	Hanger Cap.....	1	18	678346001	Spring Washer .....	4
3	308829001	Pinion Assembly .....	1	19	518463001	Blade Sheath .....	1
4	660927001	* Screw (M5 x 11.8 mm).....	2	20	660925001	* Screw (M4 x 9 mm).....	1
5	678343001	Spring Washer .....	3	21	660927002	* Screw (M5 x 14.5 mm).....	6
6	678341001	Washer.....	2	22	660926001	* Screw (M5 x 26.5 mm).....	4
7	308830001	Output Shaft Assembly.....	1	23	638342001	Cam Spacer .....	1
8	678350001	Cam .....	2	24	940726005	Logo Label.....	1
9	308548001	Blade Assembly .....	1	25	940680005	Hot Surface Label .....	1
10	901382001	Felt.....	3	26	940724003	Data Label.....	1
11	308827001	Housing Assembly .....	1	27	940657014	Warning Label.....	1
12	518464001	Housing Bottom Plate.....	1		960227042	Operator's Manual (Not Shown) .....	1
13	660923001	* Screw (M3.5 x 8 mm).....	6				
14	660924001	* Screw (M4 x 12 mm).....	2				
15	591617001	Seal.....	1				
16	678344002	* Nut (M4) .....	6				

**\* STANDARD HARDWARE ITEM – MAY BE PURCHASED LOCALLY**

# WARRANTY

---

## LIMITED WARRANTY STATEMENT

Techtronic Industries North America, Inc., warrants to the original retail purchaser that this EXPAND-IT brand product is free from defect in material and workmanship and agrees to repair or replace, at Techtronic Industries North America, Inc.'s discretion, any defective product free of charge within these time periods from the date of purchase.

- One year for the following units: all Yard Broom, Trimlite, and Bandit models;
- Two years if the product is used for personal, family or household use;
- 90 days if used for any other purpose, such as commercial or rental.

This warranty extends to the original retail purchaser only and commences on the date of the original retail purchase.

Any part of the product found in the reasonable judgment of Techtronic Industries North America, Inc., to be defective in material or workmanship will be repaired or replaced without charge for parts and labor by an Expand-it authorized service center.

The product, including any defective part, must be returned to an Expand-it authorized service center within the warranty period. The expense of delivering the product to the service center for warranty work and the expense of returning it back to the owner after repair or replacement will be paid by the owner. Techtronic Industries North America, Inc.'s responsibility in respect to claims is limited to making the required repairs or replacements and no claim of breach of warranty shall be cause for cancellation or rescission of the contract of sale of any EXPAND-IT brand product. Proof of purchase will be required by the dealer to substantiate any warranty claim. All warranty work must be performed by an Expand-it authorized service center.

This warranty is limited to ninety (90) days from the date of original retail purchase for any EXPAND-IT brand product that is used for rental or commercial purposes, or any other income-producing purpose.

This warranty does not cover any product that has been subject to misuse, neglect, negligence, or accident, or that has been operated in any way contrary to the operating instructions as specified in this operator's manual. This warranty does not apply to any damage to the product that is the result of improper maintenance or to any product that has been altered or modified. The warranty does not extend to repairs made necessary by normal wear or by the use of parts or accessories which are either incompatible with the EXPAND-IT brand product or adversely affect its operation, performance, or durability.

In addition, this warranty does not cover:

- A. Tune-ups – Spark Plugs, Carburetor, Carburetor Adjustments, Ignition, Filters
- B. Wear items – Bump Knobs, Outer Spools, Cutting Lines, Inner Reels, Starter Pulleys, Starter Ropes, Drive Belts, Tines, Felt Washers, Hitch Pins, Mulching Blades, Blower Fans, Blower and Vacuum Tubes, Vacuum Bags and Straps, Guide Bars, Saw Chains

Techtronic Industries North America, Inc., reserves the right to change or improve the design of any EXPAND-IT brand product without assuming any obligation to modify any product previously manufactured.

ALL IMPLIED WARRANTIES ARE LIMITED IN DURATION TO THE STATED WARRANTY PERIOD. ACCORDINGLY, ANY SUCH IMPLIED WARRANTIES INCLUDING MERCHANTABILITY, FITNESS FOR A PARTICULAR PURPOSE, OR OTHERWISE, ARE DISCLAIMED IN THEIR ENTIRETY AFTER THE EXPIRATION OF THE APPROPRIATE TWO-YEAR, ONE-YEAR, OR NINETY-DAY WARRANTY PERIOD. TECHTRONIC INDUSTRIES NORTH AMERICA, INC.'S OBLIGATION UNDER THIS WARRANTY IS STRICTLY AND EXCLUSIVELY LIMITED TO THE REPAIR OR REPLACEMENT OF DEFECTIVE PARTS AND TECHTRONIC INDUSTRIES NORTH AMERICA, INC., DOES NOT ASSUME OR AUTHORIZE ANYONE TO ASSUME FOR THEM ANY OTHER OBLIGATION. SOME STATES DO NOT ALLOW LIMITATIONS ON HOW LONG AN IMPLIED WARRANTY LASTS, SO THE ABOVE LIMITATION MAY NOT APPLY TO YOU. TECHTRONIC INDUSTRIES NORTH AMERICA, INC., ASSUMES NO RESPONSIBILITY FOR INCIDENTAL, CONSEQUENTIAL, OR OTHER DAMAGES INCLUDING, BUT NOT LIMITED TO, EXPENSE OF RETURNING THE PRODUCT TO AN EXPAND-IT AUTHORIZED SERVICE CENTER AND EXPENSE OF DELIVERING IT BACK TO THE OWNER, MECHANIC'S TRAVEL TIME, TELEPHONE OR TELEGRAM CHARGES, RENTAL OF A LIKE PRODUCT DURING THE TIME WARRANTY SERVICE IS BEING PERFORMED, TRAVEL, LOSS OR DAMAGE TO PERSONAL PROPERTY, LOSS OF REVENUE, LOSS OF USE OF THE PRODUCT, LOSS OF TIME, OR INCONVENIENCE. SOME STATES DO NOT ALLOW THE EXCLUSION OR LIMITATION OF INCIDENTAL OR CONSEQUENTIAL DAMAGES, SO THE ABOVE LIMITATION OR EXCLUSION MAY NOT APPLY TO YOU.

This warranty gives you specific legal rights, and you may also have other rights which vary from state to state.

This warranty applies to all EXPAND-IT brand products manufactured by or for Techtronic Industries North America, Inc., and sold in the United States and Canada.

To locate your nearest Expand-it authorized service center, dial 1-800-242-4672.



## Free Manuals Download Website

<http://myh66.com>

<http://usermanuals.us>

<http://www.somanuals.com>

<http://www.4manuals.cc>

<http://www.manual-lib.com>

<http://www.404manual.com>

<http://www.luxmanual.com>

<http://aubethermostatmanual.com>

Golf course search by state

<http://golfingnear.com>

Email search by domain

<http://emailbydomain.com>

Auto manuals search

<http://auto.somanuals.com>

TV manuals search

<http://tv.somanuals.com>