



# USER MANUAL

HMX-F80BP/HMX-F80SP  
HMX-F800BP/HMX-F800SP

Digital Camcorder

[www.samsung.com/register](http://www.samsung.com/register)





**For video recording, use a memory card that supports faster write speeds.**

- Recommended Memory Card: 6MB/s (Class 6) or above.

# Before reading this user manual

## SAFETY WARNINGS

What the icons and signs in this user manual mean;

Safety Icon	Meaning
 WARNING	There is a potential risk of death or serious injury.
 CAUTION	There is a potential risk of personal injury or damage to the product.
	To reduce the risk of fire, explosion, electric shock, or personal injury when using your camcorder, follow these basic safety precautions.
	Here are hints or page number references you will find helpful when you operate the camcorder.
	Settings required before using a function.

These warning signs are here to prevent injury to you and others. Please follow them explicitly. After reading this section, keep it in a safe place for future reference.

## PRECAUTIONS

### Warning!

- When using the AC power adaptor with your camcorder, connect the adaptor to an outlet with protective grounding.
- Do not expose the camcorder battery to direct sunlight, heaters, radiators, fire, or any source of excessive heat.

### Caution

If you replace the battery with the wrong battery, you can cause an explosion. Replace only with the same battery or an equivalent type.

To disconnect the apparatus from the mains, the plug must be pulled out from the mains socket, therefore the mains plug shall be readily operable.

## IMPORTANT INFORMATION ON USE

### About this user manual

Thank you for purchasing this Samsung Camcorder. Please read this user manual carefully before you use the camcorder and keep it handy for future reference. Should your camcorder fail to operate correctly, refer to Troubleshooting. → pages 91–100

### This User Manual covers models HMX-F80 and HMX-F800.

- Illustrations of model HMX-F80 are used in this user manual.
- The displays in this user manual may not be exactly the same as those you see on the LCD screen.
- Designs and specifications of the camcorder and other accessories are subject to change without any notice.
- Before use, read 'Safety information' carefully and then use the product properly.
- Samsung is not responsible for any injury or damage caused by not following the user manual.
- In this manual, a 'memory card (card)' means a SD, SDHC, or SDXC.
- In this user manual's function description tables, the icon shown in the on-screen display column will appear on the screen when you set the corresponding function.  
Ex) **720X576/50p (16:9) - Video Resolution** Submenu item  
→ page 53

Item	Use	On-screen display
<b>720X576/50p (16:9)</b>	Records in 720x576 (50p) resolution with 16:9 aspect ratio.	

If you set **720X576/50p (16:9)**, the corresponding icon (  ) will appear on the screen.

### The following terms are used in this manual:

- 'Scene' refers to the point where you press the **[Recording start/stop]** button to start recording until you press again to stop recording.
- The terms 'photo' and 'still image' are used interchangeably with the same meaning.

### Before using this camcorder

- **This camcorder records video in H.264 (MPEG4/AVC) format.**
- **You can play back and edit the video recorded by the camcorder on a personal computer using the internal software of this camcorder.**
- **Please note that this camcorder is not compatible with other digital video formats.**
- **Before recording important video, make a trial recording.**  
Play back your trial recording to make sure the video and audio have been recorded properly.
- Recorded contents may be lost due to a mistake when handling this camcorder or memory card, etc. Samsung will not provide compensation for damages due to the loss of recorded contents.
- **Make a backup of important recorded data.**  
Protect your important recorded data by copying the files to a PC. We also recommend you copy it from your PC to other recording media for storage. Refer to the software installation and USB connection guide.
- **Copyrights: Please note that this camcorder is intended for individual use only.**  
Data recorded on the storage media in this camcorder using other digital/analog media or devices is protected by the Copyright Act and cannot be used without permission of the owner of the copyright, except for personal enjoyment. Even if you record an event such as a show, performance, or exhibition for personal enjoyment, we strongly recommend that you obtain permission beforehand.

- For Open Source licences information, refer to the 'Opensource-F80.pdf' in the provided CD-ROM.

### Notes regarding trademarks

- All the trade names and registered trademarks mentioned in this manual or other documentation provided with your Samsung product are trademarks or registered trademarks of their respective holders. Furthermore, '™' and '®' are not mentioned in each case in this manual.
- SD, SDHC and SDXC logos are trademarks of SD-3C, LLC.
- Microsoft®, Windows®, Windows Vista®, Windows® 7, and DirectX® are either registered trademarks or trademarks of the Microsoft Corporation in the United States and/or other countries.
- Intel®, Core™, Core 2 Duo®, and Pentium® are the registered trademarks or trademarks of the Intel Corporation in the United States and other countries.
- AMD and Athlon™ are either registered trademarks or trademarks of AMD in the United States and other countries.
- Macintosh, Mac OS are either registered trademarks or trademarks of Apple Inc. in the United States and/or other countries.
- YouTube is a trademark of Google Inc.
- Flickr is a trademark of Yahoo.
- Facebook is a trademark of Facebook Inc.
- Twitter is a trademark of Twitter Inc.
- Picasa is a trademark of Google Inc.
- Adobe, the Adobe logo, and Adobe Acrobat are either registered trademarks or trademarks of Adobe Systems Incorporated in the United States and/or other countries.

# Safety information

The safety precautions illustrated below are to prevent personal injury or material damages. Heed all instructions carefully.

 **WARNING**  
Means that there is a potential risk of serious personal injury.

 **CAUTION**  
Means that there is a potential risk of personal injury or damage to the product.

 Prohibited action.

 Do not disassemble the product.

 Do not touch the product.

 Unplug from the power supply.

 This precaution must be followed.

## WARNING



Do not overload outlets or extension cords as this may result in abnormal heat or fire.



Using the camcorder at temperatures over 60°C(140°F) may result in fire. Keeping the battery at a high temperature may cause an explosion.



Do not allow water or metal and inflammable matter to enter the camcorder or power adaptor. Doing so may pose a fire hazard.

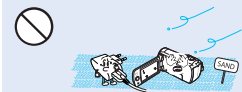

No sand or dust! Fine sand or dust entering the camcorder or power adaptor could cause malfunctions or defects.

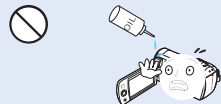

No oil! Oil entering the camcorder or power adaptor could cause electric shock, malfunctions or defects.



Do not aim the camcorder directly into the sun. Doing so could cause eye injuries, as well as lead to malfunctioning of internal parts of the product.



Do not bend the USB cable or damage the power adaptor by pressing on it with a heavy object. There may be a risk of fire or electric shock.

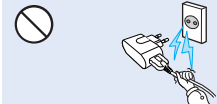

Do not disconnect the adaptor by pulling on its USB cable, as this could damage the cable.

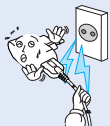

Do not use the power adaptor if it has damaged, split or broken cords or wires. Doing so may cause fire or electric shock.

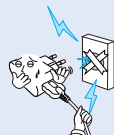

Do not connect the power adaptor unless the plug can be fully inserted with no part of the blades exposed.



Do not dispose of battery in a fire as it may explode.

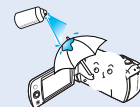

Never use cleaning fluid or similar chemicals to clean the camcorder. Do not spray cleaners directly on the camcorder.



Keep the camcorder away from water when using it near the beach or pool or when it rains. There is a risk of malfunction or electric shock.



Keep the used lithium battery or memory card out of the reach of children. If the lithium battery or memory card is swallowed by a child, consult physician immediately.



Do not plug or unplug the power adaptor with wet hands. There is a risk of electric shock.

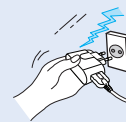

Keep the power adaptor unplugged when not in use or during lightning storms. There is a risk of fire.



When cleaning the power adaptor, unplug the power adaptor. There is a risk of malfunction or electric shock.



If the camcorder emits an abnormal sound or smell, or smokes, unplug the power adaptor immediately and request service from a Samsung service centre. There is a risk of fire or personal injury.

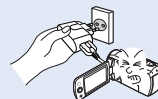

If the camcorder malfunctions, immediately detach the power adaptor or battery from the camcorder. There is a risk of fire or injury.

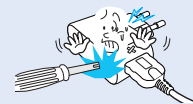

Do not attempt to disassemble, repair, or modify the camcorder or the power adaptor to avoid a risk of fire or electric shock.

### ⚠ CAUTION

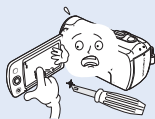

Do not press the surface of the LCD with force, or hit it with a sharp object. If you push the LCD surface, display unevenness may occur.

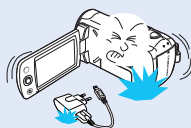

Do not drop or expose the camcorder, battery, power adaptor or other accessories to severe vibrations or impact. This may cause a malfunction or injury.

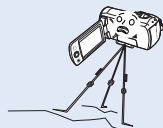

Do not use the camcorder on a tripod (not supplied) in a place where it is subject to severe vibrations or impact.

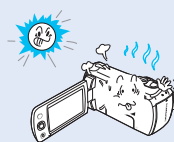

Do not use the camcorder near direct sunlight or heating equipment. This may cause a malfunction or injury.



Do not leave the camcorder in a closed vehicle for a long time where the temperature is very high.

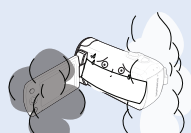

Do not expose the camcorder to soot or steam. Thick soot or steam could damage the camcorder case or cause a malfunction.

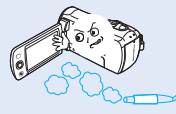

Do not use the camcorder near dense exhaust gas generated by gasoline or diesel engines, or corrosive gas such as hydrogen sulphide. Doing so may corrode the external or internal terminals, disabling normal operation.

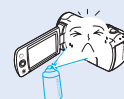

Do not expose the camcorder to insecticide. Insecticide entering the camcorder could cause the product to fail to operate normally. Turn the camcorder off and cover it with vinyl sheet, etc. before using insecticide.



Do not expose the camcorder to sudden changes in temperature or high humidity. There is also a risk of defect or electric shock when using outdoors during lightning storms.



Do not place the camcorder down on the open LCD screen.

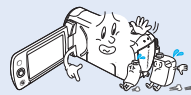

Do not wipe the camcorder body with benzene or thinner. The exterior coating could peel off or the case surface could deteriorate.

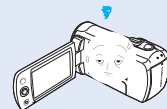

Do not leave the LCD screen open when not using the camcorder.



Do not hold the camcorder by the LCD screen when lifting it. The LCD screen could detach and the camcorder may fall.

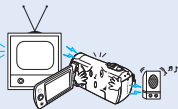

Do not use the camcorder near a TV or radio. Interference from the camcorder could cause noise on the TV or in the radio broadcast.



Do not use the camcorder near sources of strong radio waves or magnetic fields such as speakers and large motors. Noise from these sources could distort the video or audio you are recording.



Use Samsung-approved accessories only. Using products from other manufacturers may cause overheating, fire, explosion, electric shock or personal injuries caused by abnormal operation.

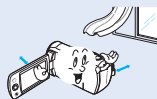

Place the camcorder on a stable surface that is well ventilated.

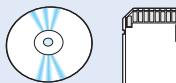

Keep important data separately. Samsung is not responsible for data loss.

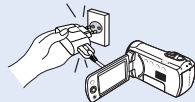

Only plug the power adaptor plug into a socket that is easily accessible. If any problem occurs with the product, you must pull the plug out of the socket to disconnect the power completely. Turning off the power button on the product does not completely.

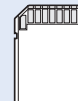

Other manufacturers of optional accessories compatible with this camcorder are responsible for their own products. Use the optional accessories according to the safety instructions. Samsung is not responsible for any malfunction, risk of fire, electric shock, or damages caused by using unauthorised accessories.

# Contents

---

Before reading this user manual .....	2	Getting ready to start recording .....	30
SAFETY WARNINGS .....	2	INSERTING AND EJECTING A MEMORY CARD (NOT SUPPLIED) ..	30
PRECAUTIONS .....	2	SELECTING A SUITABLE MEMORY CARD (NOT SUPPLIED) .....	31
IMPORTANT INFORMATION ON USE .....	2	RECORDABLE TIME AND CAPACITY .....	33
Safety information .....	4	ATTACHING THE STRAP .....	34
Quick start guide .....	10	ADJUSTING THE LCD SCREEN .....	34
Getting to know the camcorder .....	13	Basic recording .....	35
WHAT'S INCLUDED WITH YOUR CAMCORDER .....	13	RECORDING VIDEOS .....	35
LOCATION OF CONTROLS .....	14	RECORDING PAUSE/RESUME .....	36
IDENTIFYING THE SCREEN DISPLAYS .....	16	TAGGING AND CAPTURING GREAT MOMENTS WHILE RECORDING (MY CLIP FUNCTION) .....	37
Getting started .....	19	RECORDING PHOTOS .....	38
INSERTING/EJECTING THE BATTERY .....	19	RECORDING WITH EASE FOR BEGINNERS (SMART AUTO) .....	39
CHARGING THE BATTERY .....	20	ZOOMING IN/OUT .....	40
CHECKING THE BATTERY STATE .....	21	USING THE BACK LIGHT BUTTON .....	41
Basic operation of the camcorder .....	24	Basic playback .....	42
TURNING YOUR CAMCORDER ON/OFF .....	24	CHANGING THE PLAYBACK MODE .....	42
SWITCHING TO THE POWER SAVING MODE .....	24	PLAYING BACK VIDEOS .....	43
SETTING THE DATE/TIME FOR THE FIRST TIME .....	25	PLAYING BACK MY CLIP .....	45
SETTING THE OPERATION MODES .....	26	USING THE SMART BGM FUNCTION .....	45
SWITCHING THE INFORMATION DISPLAY MODE .....	26	TAGGING AND CAPTURING GREAT MOMENTS WHILE PLAYING BACK VIDEO .....	46
USING THE SHORTCUT MENU (OK GUIDE) .....	27	VIEWING PHOTOS .....	47
SELECTING THE LANGUAGES .....	29	ZOOMING DURING PHOTO PLAYBACK .....	48
		Using the menu items .....	49
		HANDLING MENUS .....	49
		MENU ITEMS .....	50



<b>Advanced recording</b> .....	<b>52</b>	Auto LCD Off .....	76
iSCENE .....	52	Beep Sound .....	77
Video Resolution.....	53	Shutter Sound .....	77
Photo Resolution .....	54	Auto Power Off.....	78
White Balance .....	54	PC Software.....	78
Face Detection .....	56	Format.....	79
EV (Exposure Value) .....	57	Default Set.....	79
C.Nite.....	58	Language .....	79
Focus .....	58	<b>Connecting to a TV</b> .....	<b>80</b>
Anti-Shake(HDIS).....	60	CONNECTING TO A HIGH DEFINITION TV WITH HDMI .....	80
Digital Special Effect .....	61	CONNECTING TO A REGULAR TV .....	81
Zoom Type.....	62	VIEWING ON A TV SCREEN.....	82
Cont. Shot.....	63	<b>Dubbing videos</b> .....	<b>83</b>
Time Lapse REC .....	64	DUBBING TO VCR OR DVD/HDD RECORDERS.....	83
Guideline .....	66	<b>Using with a windows computer</b> .....	<b>84</b>
<b>Advanced playback</b> .....	<b>67</b>	WHAT YOU CAN DO WITH A WINDOWS COMPUTER .....	84
Thumbnail View Option.....	67	USING THE Intelli-studio PROGRAMME.....	85
PlayOption .....	68	USING AS A REMOVABLE STORAGE DEVICE .....	89
Smart BGM Option.....	68	<b>Troubleshooting</b> .....	<b>91</b>
Delete.....	70	WARNING INDICATORS AND MESSAGES .....	91
Delete My Clip .....	71	SYMPTOMS AND SOLUTIONS.....	94
Protect .....	72	<b>Maintenance &amp; additional information</b> .....	<b>101</b>
Slide Show .....	73	MAINTENANCE.....	101
File Info.....	73	USING YOUR CAMCORDER ABROAD .....	102
<b>Other settings</b> .....	<b>74</b>	GLOSSARY .....	103
Storage Info.....	74	<b>Specifications</b> .....	<b>104</b>
File No.....	74		
Date/Time Set .....	75		
Date/Time Display .....	75		
LCD Brightness .....	76		

# Quick start guide

This quick start guide introduces the basic operation and features of your camcorder. See the reference pages for more information.

## STEP 1: Get ready

- 1 Insert the battery into the battery slot. → page 19

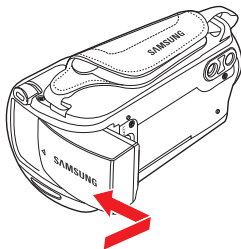

- 2 Charge the battery fully. → page 20

- 3 Insert a memory card. → page 30

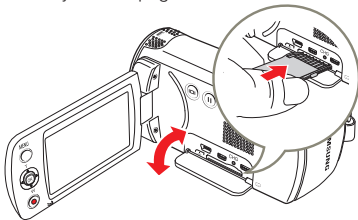

## STEP 2: Record videos and photos

- 1 Open the LCD screen and press the **[Power (⏻)]** button to turn on the camcorder.
  - Set the **[Lens cover open/close]** switch to open (☾).  
→ page 15

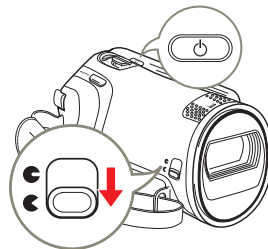

- 2 To record videos, press the **[Recording start/stop]** button or, to record photos, press the **[PHOTO]** button. → pages 35, 38

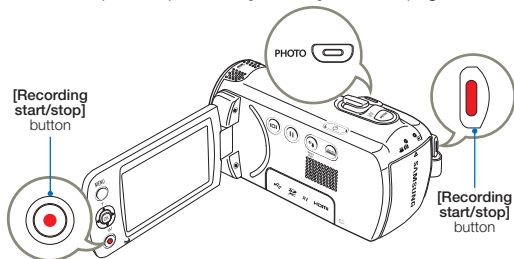

## STEP 3: Play back videos or photos

### Viewing videos or photos on the LCD screen

You can find recordings quickly by using the thumbnail view.

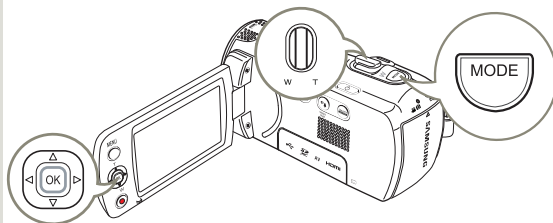

- 1 Press the **[MODE]** button to select the playback (▶) mode.
- 2 Select the video or photo thumbnail view by using the **[Zoom]** lever.
- 3 Use the **[Control (Up/Down/Left/Right)]** button to select a desired video or photo, and then press the **[Control (OK)]** button.

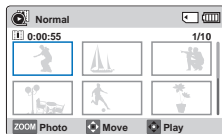

### Viewing on a TV

You can enjoy detailed, brilliant quality videos on a connected TV.  
 ▶ pages 80~82

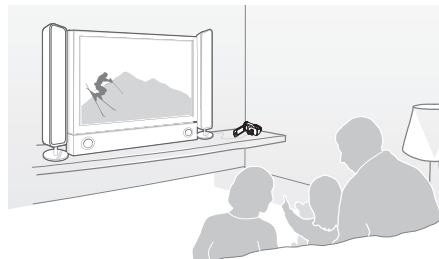

## STEP 4: Save recorded videos / photos

Using the Intelli-studio programme built in to your camcorder, you can import videos and photos into your computer and edit or share the videos and photos with your friends and family. For details, see pages 85~88.

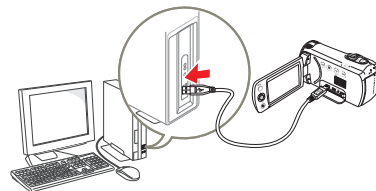

## Importing and viewing videos/photos from the camcorder to your PC

- 1 Start the Intelli-studio programme by connecting the camcorder to your PC with a USB cable.
  - A new file saving screen appears with the Intelli-studio main window. Click **Yes**, and the uploading procedure starts.
- 2 Any new files are saved to your PC and registered to **Contents Manager** in the Intelli-studio programme.
  - You can arrange the files by different criteria such as Face, Date, Location, etc.

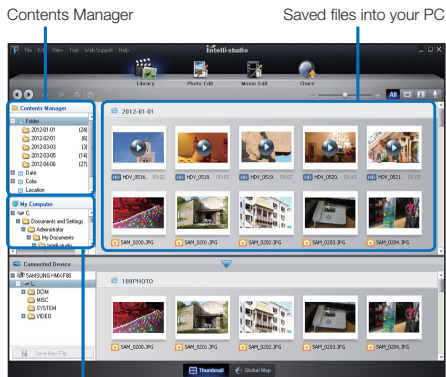

Folders directory on your PC

- 3 Double-click the file you would like to play back.

## Sharing videos/photos on Web sites

Share your contents with the world by uploading photos and videos directly to a web site with a single click.

Click the **Share** (📧) → **Upload** tab on the browser. ↪ page 88

 Intelli-studio runs automatically when you connect the camcorder to a Windows computer (if you have set **PC Software: On**). ↪ page 78

## STEP 5: Delete videos or photos

If the camcorder's storage media is full, you cannot record new videos or photos. Delete videos or photos you have saved to your computer from the camcorder's storage media. Then you can record new videos or photos on newly freed up space.

[MODE] button → Playback (▶) mode → [MENU] button → Delete ↪ page 70

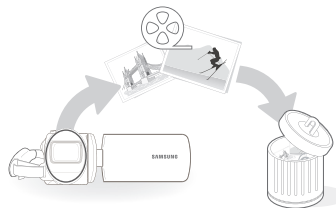

# Getting to know the camcorder

## WHAT'S INCLUDED WITH YOUR CAMCORDER

Your new camcorder comes with the following accessories. If any of these items is missing from your box, call Samsung's Customer Care Centre.

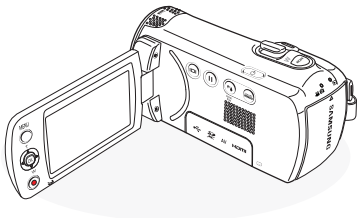

Model name	Colour	Internal memory	Lens
HMX-F80BP HMX-F800BP	Black	-	52x (Optical), 65x (Intelli), 130x (Digital)
HMX-F80SP HMX-F800SP	Sliver	-	

 Although the models have some features that are different, they operate in the same way.

## Checking your accessories



Battery



Power adaptor



USB cable



Audio/Video cable



User manual CD

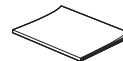

Quick start guide

## Optional accessories



Micro HDMI cable



Carrying case



Memory card



External battery charger



- The exact appearance of each item may vary by model.
- The contents may vary depending on the sales region.
- You can purchase parts and accessories after consulting with your local Samsung dealer. SAMSUNG is not responsible for reduced battery life time or malfunctions caused by any unauthorised use of accessories such as the power adaptor or the batteries.
- A memory card is not included. See page 31 for memory cards compatible with your camcorder.
- Your camcorder includes the user manual CD and the printed quick start guide.

## LOCATION OF CONTROLS

### Front & Left

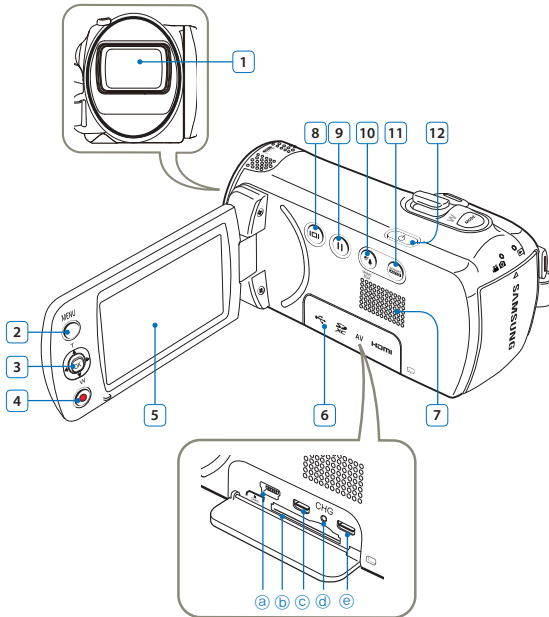

- |    |   |
|----|---|
| 1  | Lens  |
| 2  | MENU button   |
| 3  | Control (Up/Down/Left/Right/OK) button / Zoom (T/W) button  |
| 4  | Recording start/stop button   |
| 5  | LCD screen  |
| 6  | Memory card/Jack cover<br>a USB jack (↔)<br>b Memory card slot (SD)<br>c AV jack (AV)<br>d CHG (charging) indicator<br>e HDMI jack (HDMI) |
| 7  | Internal speaker  |
| 8  | Display (Ⓢ) button  |
| 9  | Recording pause/resume (⏸) button   |
| 10 | Back light (Ⓢ) button / SMART BGM button  |
| 11 | SMART AUTO (SMART AUTO) button  |
| 12 | Power (⏻) button  |

## Right/Top & Bottom

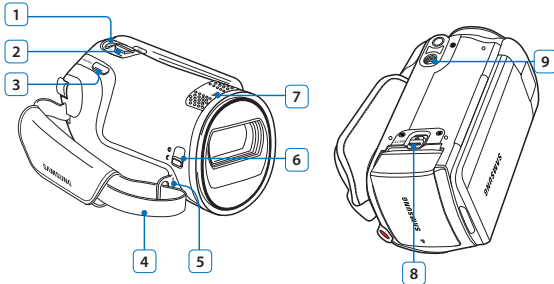

- 1 MODE button
- 2 Zoom lever (T/W)
- 3 PHOTO / My Clip button
- 4 Strap
- 5 Strap hook
- 6 Lens cover open (☐)/close (●) switch
- 7 Internal microphone
- 8 Battery release switch (BATT.)
- 9 Tripod receptacle

## Rear

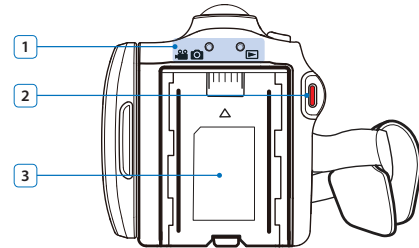





- 1 Mode indicator  
📹 📷 : Recording mode (Video/Photo)  
▶ : Playback mode
- 2 Recording start/stop button
- 3 Battery slot

 Be careful not to cover the internal microphone and lens during recording.

## IDENTIFYING THE SCREEN DISPLAYS

The available functions vary depending on the selected operation mode. Different indicators appear depending on the setting values.







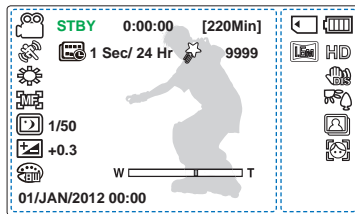







- The On Screen Display (OSD) below appears when the camcorder is in the recording (   ) mode only.
- Press the [MODE] button to select the recording (   ) mode.  page 26

### Video and Photo recording mode









- This camcorder provides one combined video and photo recording mode. You can easily record videos or photos in the same mode without having to change it.
- The on-screen indicators are based on an 16GB SDHC memory card capacity.
- The settings of functions marked with \* do not remain when the camcorder turns off.
- For enhanced performance, the display indications and the order are subject to change without prior notice.
- The total number of recordable photos is based on the available space on the storage media.
- The maximum number the photo counter can display is 9,999.

### Left of the LCD screen

Indicator	Meaning
 	Recording mode (Video/Photo)
STBY / ● /    / ►	Operating status (standby/ recording/pause/photo capturing)
0:00:00 [220Min]	Time counter (video recording time, remaining recordable time)
 / SMART AUTO	iSCENE* / Smart Auto
	Time Lapse REC*
	My Clip
9999	Photo image counter (total number of recordable photos)
	White Balance*
	Manual focus*
 1/50	C.Nite
 +0.3	EV (Exposure Value)*
w  T w  T	Zoom (optical zoom / intelli zoom / digital zoom)
	Digital Special Effect
01/JAN/2012 00:00	Date/Time Display

### Right of the LCD screen

Indicator	Meaning
	Storage media (memory card)
	Battery info. (remaining battery level)
 , HD	Photo Resolution, Video Resolution
	Anti-Shake(HDIS)
	Back light
	Continuous shot
	Face Detection





- The On Screen Display (OSD) below appears in the video playback (🎞️) mode only.
- Press the [MODE] button to select the playback (▶️) mode. ➡️ page 26

## Video playback mode: Thumbnail view

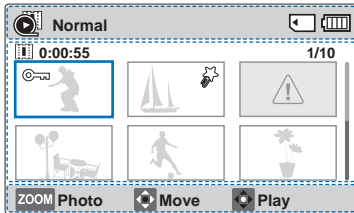

### Top of the LCD screen

Indicator	Meaning
	Video playback mode
	Storage media (memory card)
	Battery info (remaining battery level)

### Centre of the LCD screen

Indicator	Meaning
0:00:55	Recorded time
1/10	Current video / total number of recorded videos
	Protect
	My Clip
	Error file
	Scroll bar

### Bottom of the LCD screen

Indicator	Meaning
ZOOM	Button guide

## Video playback mode: Single view

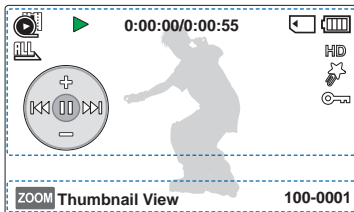

### Top of the LCD screen

Indicator	Meaning
	Video playback mode
	Playback status (playback/pause/search/skip)
0:00:00/0:00:55	Time code (elapsed time / recorded time)

Indicator	Meaning
	My Clip
	Protect
	Shortcut menu

	Storage media (memory card)
	Battery info (remaining battery level)
	PlayOption
HD	Video Resolution

### Bottom of the LCD screen

Indicator	Meaning
ZOOM	Button guide
100-0001	File name (file number)



- This On Screen Display (OSD) below appears in the photo playback (📷) mode only.
- Press the [MODE] button to select the playback (▶️) mode. ↪️ page 26

## Photo playback mode: Thumbnail view

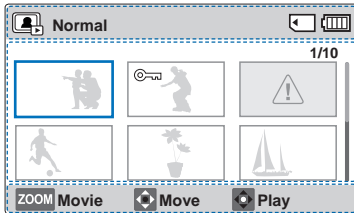

### Top of the LCD screen

Indicator	Meaning
	Photo playback mode
	Storage media (memory card)
	Battery info (remaining battery level)

### Centre of the LCD screen

Indicator	Meaning
<b>1/10</b>	Current photo / total number of recorded photos
	Protect
	Error file
	Scroll bar

### Bottom of the LCD screen

Indicator	Meaning
	Button guide

## Photo playback mode: Single view

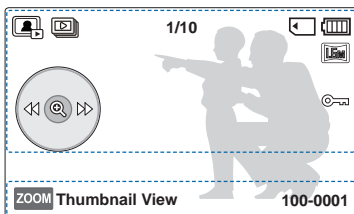

### Top of the LCD screen

Indicator	Meaning
	Photo playback mode
	Slide Show
<b>1/10</b>	Current photo / total number of recorded photos
	Storage media (memory card)
	Battery info (remaining battery level)
	Photo Resolution

Indicator	Meaning
	Protect
	Shortcut menu

### Bottom of the LCD screen

Indicator	Meaning
	Button guide
<b>100-0001</b>	File name (file number)

# Getting started

## INSERTING/EJECTING THE BATTERY

### To insert the battery

Insert the battery into the battery slot until it softly clicks.

- Make sure that the SAMSUNG logo on the battery is facing you when the camcorder is placed as shown in the figure.

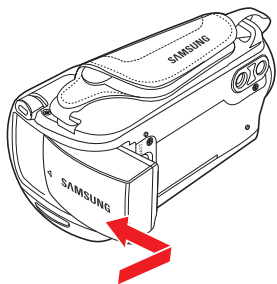

### To eject the battery

- 1 Gently push the **[Battery release (BATT.)]** switch in the direction shown in the figure to eject the battery.
- 2 Push down, and then lift the battery out in the direction shown in the figure.

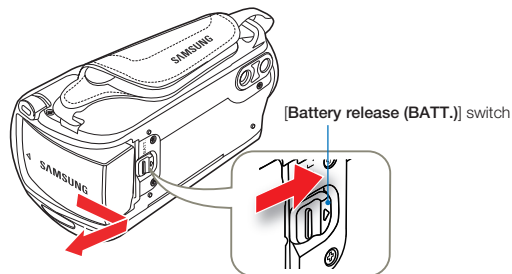

- Use only Samsung-approved batteries. Do not use batteries from other manufacturers. Otherwise, there is a danger of overheating, fire or explosion.
- Samsung is not responsible for the problems caused by unapproved batteries.
- Remove the battery from the camcorder when the camcorder is not in use.
- We recommend you purchase one or more additional batteries to allow continuous use of your camcorder.

## CHARGING THE BATTERY

You can charge the battery with the USB cable and power adaptor.

- ✔ Make sure that you use the supplied USB cable or power adaptor to charge the battery. If you use any other power adaptor for the camcorder, it will not work properly or the battery may not be charged. It may also cause electric shock or result in fire.

### To charge the battery with the power adaptor

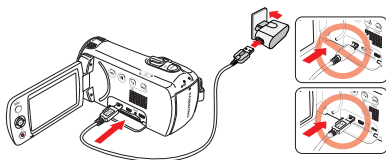

### To charge the battery by connecting to a PC

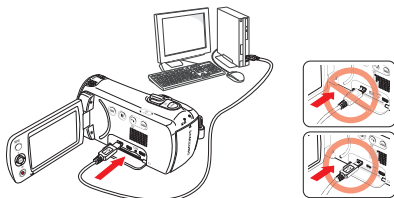

- 1 Insert the battery into the camcorder. ➤page 19
- 2 Open the jack cover of the camcorder.
- 3 Charge the battery using the USB cable and power adaptor.
  - The CHG (charge) indicator lights up and charging starts. When the battery is fully charged, the charging (CHG) indicator turns green. ➤page 21

- ⚠
  - Charging the battery at low temperature may take longer or the battery may not charge fully (green indicator will not turn on).
  - Make sure that there are no foreign substances on the plug or in the socket when you connect the power adaptor to the camcorder.
  - When using the power adaptor, place it close to the wall outlet. If you experience a malfunction while using the camcorder, separate the power adaptor immediately from the wall outlet.
  - Do not use the power adaptor in a tight space, such as between furnishings.
  - Make sure to turn off the camcorder before disconnecting the power adaptor. Otherwise, you can damage the storage media or data.
- 👉
  - When recording indoors with a wall outlet available, it is convenient to use the power adaptor instead of the battery.
  - We recommend you charge the battery in a place with an ambient temperature between 10°C and 30°C (50°F–86°F).
  - If the camcorder is turned on, the battery will still charge, but more charging time will be needed. We recommend you keep the camcorder turned off while it charges.
  - You cannot operate the camcorder using USB power only. Use the power adaptor or battery to power the camcorder.
  - If you use the camcorder while you are charging the battery, charging may take longer.
  - An AC plug adaptor is required in some foreign countries. If you need one, purchase it from your distributor.

## CHECKING THE BATTERY STATE

You can check the charging state and remaining battery capacity.

### To check the charging state

The colour of the CHG lamp indicates the charging state.

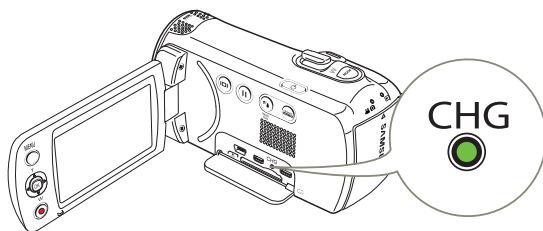

### Charging (CHG) lamp

Charging state	Charging	Fully charged	Error
LED colour	Orange (Orange)	Green (Green)	Orange blink (Orange blink)

### Battery level display

The battery level display shows the amount of battery power remaining in the battery.



Battery Level Indicator	State	Message
	Fully charged	-
	75%~50%	-
	50%~25%	-
	25%~5%	-
	less than 5%	-
	Exhausted (flickers): The device will soon turn off. Change the battery as soon as possible.	-
-	The device will be forced to turn off after 3 seconds.	<b>Low battery</b>

The figures above are based on a fully charged battery at normal temperature. Low ambient temperature may affect the use time.

### Available charging and running time for the battery

Battery Type		IA-BP105R		IA-BP210R	
Charging time	To charge the battery with the power adaptor	approx. 160 min.		approx. 300 min.	
	To charge the battery by connecting to a PC	approx. 160 min.		approx. 300 min.	
Resolution		HD	SD	HD	SD
Continuous recording time		approx. 100 min.	approx. 80 min.	approx. 200 min.	approx. 160 min.
Playback time		approx. 200 min.		approx. 400 min.	

- Charging time: Approximate time in minutes required to fully charge a completely exhausted battery.
- Recording/Playback time: Approximate time available when you have fully charged the battery.
- The time is only for reference. Times shown above are measured under Samsung's test conditions. Your times may differ, depending on your usage and conditions.
- The recording and playback times will be shorter when you use your camcorder in low temperatures.
- We recommend using the power adaptor when using the Time Lapse REC function.

### Continuous Recording (without zoom)

The continuous recording time shows the available recording time when you record without using any other function after recording starts.

The battery may discharge 1.5 times faster than this reference if you use the record start/stop, the zoom, and the playback functions. Prepare additional batteries with the expectation that the actual recording time is about 60% of the times listed above.

### Using an AC power source

We recommend that you use the power adaptor to power the camcorder from a household AC outlet when recording and playing back the camcorder indoors. The connection is the same as that for battery charging. [▶page 20](#)



- The charging time will vary depending on the amount of charge left in the battery.
- Depending on your PC specifications, the charging time can be prolonged.

## About the battery

- **Battery properties**

A lithium-ion battery is small-sized and has a high capacity. Low ambient temperature (below 10°C (50°F)) may shorten its usage time and affect its function. Before recording in low temperatures, put the battery into your pocket to warm it, then install it in the camcorder.

- **Make sure to store the battery separately after use.**

- A small amount of battery power is consumed when the battery is stored in the camcorder even if the camcorder power is off.
- The battery may be completely discharged, if it has been installed and left in the camcorder for a long period of time. If this occurs, the battery may not fully operate even if you charge it.
- If the battery is not used for a long time, fully charge the battery and then, using your camcorder, drain the charge completely. Do this once every 3 months to keep the battery functioning properly. To store the battery, remove it from your camcorder and put it in a cool, dry place.

- **Charge an extra battery before using the camcorder outdoors in cold temperatures.**

- The cold temperature may shorten the length of time you can use the battery before needing to recharge it.
- Carry the supplied USB cable and power adaptor to charge the battery while travelling.

- **Check whether the battery terminal is damaged if the battery falls or is dropped.**

- If you install a battery with the damaged terminal into the camcorder, you can damage the camcorder.

- **Remove the battery and the memory card from the camcorder and disconnect the power adaptor after use.**

- Store the battery in a stable, cool and dry place. (Recommended temperature : 15°C~25°C (59°F~77°F), recommended humidity: 40%~60%)
- Temperatures that are too high or too low shorten the battery lifetime.
- The battery terminals can become rusty or malfunction if the battery is stored in a smoky or dusty location.

- **Recycle or dispose of your dead batteries properly.**

- **The battery lifetime is limited.**

- Battery capacity decreases over time and through repeated use. If decreased usage time between charges becomes significant, it is probably time to replace the battery with a new one.
- Each battery's life is affected by storage, and operating and environmental conditions.

# Basic operation of the camcorder

## TURNING YOUR CAMCORDER ON/OFF

- 1 Open the LCD screen and press the **[Power (⏻)]** button to turn on the camcorder.
  - Set the **[Lens cover open/close]** switch to open (☑).
- 2 To turn off the camcorder, press the **[Power (⏻)]** button.

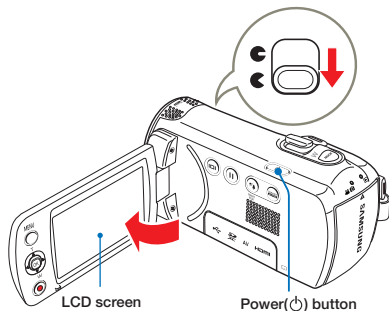

 The camcorder operates the self-diagnosis function when powered on. If a warning message appears, refer to 'warning indicators and messages' (pages 91~93) and take corrective action.

### When using this camcorder for the first time

When you use your camcorder for the first time or reset it, the Date/Time Set screen appears at start-up.  
Set the date and time.  page 25

## SWITCHING TO THE POWER SAVING MODE

If you need to use camcorder for the extended time, the following functions enable you to prevent unnecessary energy consumption.

### Sleep mode

The camcorder switches to the sleep mode when the LCD screen is closed, and then, if idle for more than 20 minutes, the camcorder turns off. However, if **Auto Power Off: 5 Min** is set, the camcorder turns off in 5 minutes.

If you open the LCD screen during sleep mode, the sleep mode ends and the camcorder returns to the last operation mode used.

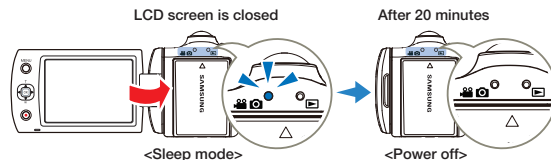

-  The power saving mode does not work in the following situations:
- While recording, playing back, or displaying a slide show.
  - When the LCD screen is opened.
- The camcorder consumes less battery power in the power saving mode. However, if you plan to use the camcorder for an extended time, we recommend you turn off the camcorder by pressing the **[Power (⏻)]** button when not using it.



## SETTING THE DATE/TIME FOR THE FIRST TIME

You can set the date and time of your local area when you turn on this camcorder for the first time.

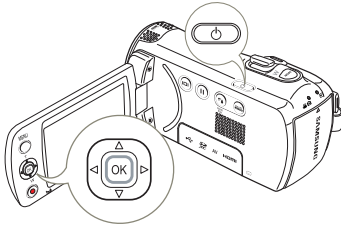

- Open the LCD screen and press the **[Power (⏻)]** button to turn on the camcorder.
  - The Date/Time Set screen appears.
- Select the date and time information, and change the setting values by using the **[Control (Up/Down/Left/Right)]** button.
- Make sure the clock is correctly set, and then press the **[Control (OK)]** button.



- The year can be set up to 2037.
- Set **Date/Time Display** to On. ↪ page 75
- After setting, the date and time are automatically recorded on a special data area of the storage media.

### Internal rechargeable battery

- Your camcorder includes an internal rechargeable battery that retains the date and time settings even after the power is turned off.
- Once this battery is depleted, the current date/time values are all reset to defaults, and you need to recharge the internal rechargeable battery. The date/time must be set again.

### Charging the internal rechargeable battery

- The internal battery is always recharged while your camcorder is connected to the power adaptor or while the battery is attached.
- If you do not connect the camcorder to power adaptor or do not attach the battery for about 48 hours, the internal battery fully discharges. If this occurs, charge the internal battery by connecting to the supplied USB cable and power adaptor for 12 hours.

## SETTING THE OPERATION MODES

You can switch the operation mode in the following order each time you press the **[MODE]** button.

Recording mode (  ) ↔ Playback mode (  )

- Each time the operation mode changes, the respective mode indicator light turns on.

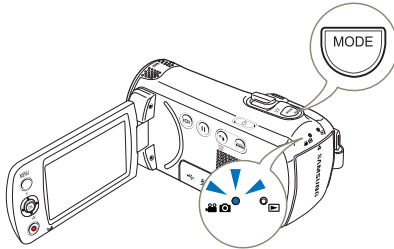

Mode	Indicator	Functions
Recording mode		To record videos or photos.
Playback mode		To play back videos or photos.

 This camcorder provides one recording mode for both video and photo recordings. You can easily record videos or photos in the same mode without having to switch modes.

## SWITCHING THE INFORMATION DISPLAY MODE

You can switch the on-screen information display mode.

Press the **[Display (  )]** button.

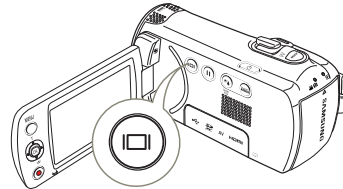

- The full and minimum display modes will alternate.



<Full display mode>



<Minimum display mode>

-  Warning indicators and messages may appear depending on the recording conditions.
- In the menu screen, the **[Display (  )]** button will be deactivated.

### USING THE SHORTCUT MENU (OK GUIDE)

The shortcut menu (OK guide) represents the most frequently accessed functions for the selected mode. Pressing the **[Control (OK)]** button will display the shortcut menu of frequently used functions on the LCD screen.

An example: Setting EV (Exposure Value) in the recording mode using the shortcut menu (OK guide).

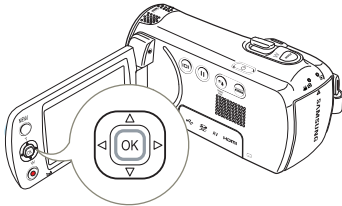

- 1 Press the **[Control (OK)]** button in STBY mode.
  - The shortcut menu (OK guide) appears.

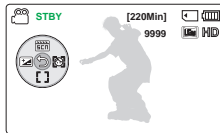

- 2 Press the **[Control (Left)]** button to select **EV** function.

- Press the **[Control (Left/Right)]** button to adjust the exposure while viewing the image on the LCD screen.

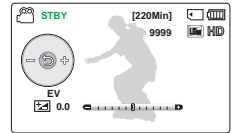





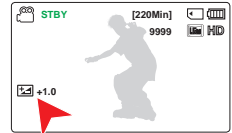







- 3 Press the **[Control (OK)]** button to confirm your selection.

- Press the **[Control (OK)]** button to exit the shortcut menu.
- The exposure value setting is applied and the indicator (EV) and setting value appear.



- The shortcut menu (OK guide) cannot be used in the SMART AUTO mode.
- The example above shows how to set EV in the recording mode using the shortcut menu. The setting procedure could be different for other menu items.
- The shortcut menu appears briefly. The shortcut menu reappears when you press the **[Control (OK)]** button.

## SHORTCUT FUNCTION USING THE CONTROL BUTTONS

Button	Recording (  ) mode	Playback (  ) mode		Menu selection
		Video playback (  ) mode	Photo playback (  ) mode	
 <b>OK</b>	 <ul style="list-style-type: none"> <li>- Access the shortcut menu</li> <li>- Confirm selection</li> <li>- Exit the shortcut menu</li> </ul>	 <ul style="list-style-type: none"> <li>- Access the shortcut menu</li> <li>- Playback / Pause</li> </ul>	 <ul style="list-style-type: none"> <li>- Access the shortcut menu</li> <li>- Playback zoom</li> </ul>	Confirms selection
 <b>UP</b>	<ul style="list-style-type: none"> <li>- iSCENE</li> <li>- Zoom (tele)</li> </ul>	Increases the volume	-	Moves the cursor up
 <b>DOWN</b>	<ul style="list-style-type: none"> <li>- Focus</li> <li>- Zoom (wide)</li> </ul>	Decreases the volume	-	Moves the cursor down
 <b>LEFT</b>	EV	<ul style="list-style-type: none"> <li>- Search playback RPS (Reverse Playback Search) rate: x2→x4→x8→x16</li> <li>- Previous skip playback</li> </ul>	Previous image	Moves to the previous menu
 <b>RIGHT</b>	Face Detection	<ul style="list-style-type: none"> <li>- Search playback FPS (Forward Playback Search) rate: x2→x4→x8→x16</li> <li>- Next skip playback</li> </ul>	Next image	Moves to the next menu

## SELECTING THE LANGUAGES

You can select a language to appears on the LCD screen.

- 1 Press the [MENU] button → [Control (Left/Right)] button → **Settings**.
- 2 Press the [Control (Up/Down)] button to select **Language**, and then press the [Control (OK)] button.
- 3 Press the [Control (Up/Down)] button to select the desired OSD language, and then press the [Control (OK)] button.
  - The OSD language appears in the selected language.
- 4 Press the [MENU] button to exit the menu.

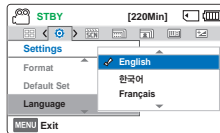
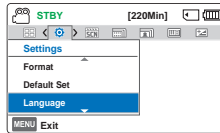

### Submenu items

English	한국어	Français
Deutsch	Italiano	Español
Português	Nederlands	Svenska
Suomi	Norsk	Dansk
Polski	Čeština	Slovensky
Magyar	Română	Български
Ελληνικά	српски	Hrvatski
Українська	Русский	中文
日本語	ไทย	Türkçe
ایرانی	العربية	עברית



- **Language** options may be changed without prior notice.
- The selected language remains even without the battery.
- The date and time format may change depending on the language you selected.

# Getting ready to start recording

## INSERTING AND EJECTING A MEMORY CARD (NOT SUPPLIED)

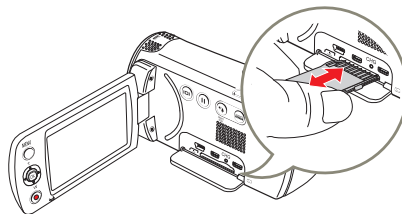
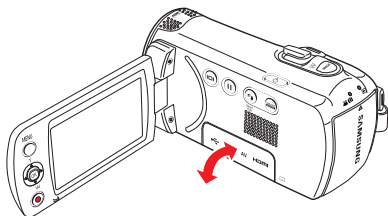

### To insert a memory card

- 1 Turn the camcorder off.
- 2 Open the memory card cover as shown in the figure.
- 3 Insert the memory card into the card slot until it softly clicks.
  - Make sure that the camcorder is placed as shown above and the terminal portion of the card is facing up.
- 4 Close the cover.

-  • To avoid data loss, turn off the camcorder by pressing the **[Power (⏻)]** button before inserting or ejecting the memory card.
- Be careful not to push the memory card too hard. The memory card may suddenly pop out.
- If you eject the memory card from the camcorder while it keeps turning on, the camcorder turns off.

-  Your camcorder supports only SD, SDHC, and SDXC cards.  
Compatibility with this camcorder may vary depending on the card manufacturer and type.

### To eject a memory card

- 1 Turn the camcorder off.
- 2 Open the memory card cover as shown in the figure.
- 3 Gently push the memory card to eject it.
- 4 Pull the memory card out of the memory card slot and close the cover.

### SELECTING A SUITABLE MEMORY CARD (NOT SUPPLIED)

#### Compatible memory cards

- You can use SD, SDHC, and SDXC cards with this camcorder. We recommend you use an SDHC card. This camcorder supports SD cards up to 2GB. We cannot guarantee normal operation with SD cards bigger than 2GB.
- MMC (Multi Media Card) and MMC Plus are not supported.
- Compatible memory card capacity:
  - SD: 1GB~2GB
  - SDHC: 4GB~32GB
  - SDXC: ~up to 64GB
- When you use unauthorised memory cards, the camcorder can not record videos correctly and your recordings may be lost.
- The memory cards released after this camcorder may not be compatible with the camcorder.
- When the camcorder operates with 6MB/s (Class 6) or above memory cards, it can be stable.
- SD/SDHC/SDXC memory cards have a mechanical write-protection switch. Setting the switch prevents accidental erasure of files recorded on the card. To enable writing, move the switch up in the direction of the terminals. To set write protection, move the switch down.
- SDHC/SDXC cards are a higher version of SD memory cards and support higher capacity than SD memory cards.
- SD cards can be used with current SD enabled host devices.

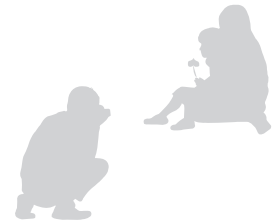
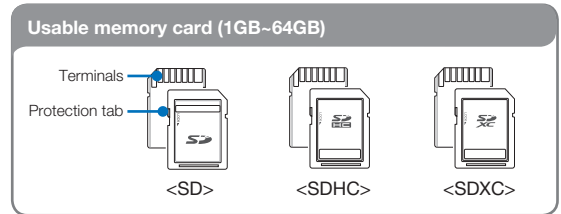

### Handling a memory card

- Damaged data may not be recoverable. We recommend you make a back-up of important data separately on the hard disk of your PC.
- Turning the power off or removing a memory card during an operation such as formatting, deleting, recording, and playback may cause data loss.
- If you modify the name of a file or folder stored in the memory card with your PC, your camcorder may not recognise the modified file.
- The memory card does not support any data recovery mode. Therefore, care should be taken in case the memory card is damaged while recording.
- Make sure to format the memory card on this camcorder. If the memory card had been formatted by a PC or other device, using it on this camcorder without formatting may find trouble with recording and/or playback. Samsung is not responsible for damage of recorded contents caused by such reasons.
- You have to format newly-purchased memory cards, memory cards with data that your camcorder cannot recognise or with data saved by other devices. Note that formatting erases all data on the memory card and deleted data cannot be recovered.
- A memory card has a certain life span. If you cannot record new data, you have to purchase a new memory card.
- Do not bend, drop, or subject the card to strong impacts.
- Do not place foreign substances on the memory card terminals. Use a soft dry cloth to clean the terminals if required.
- Do not paste anything other than the label provided with the card on the label pasting area of the card.
- Do not use a damaged memory card.
- Be careful to keep the memory card out of the reach of children, who might swallow it.

The camcorder supports SD, SDHC, and SDXC memory cards, giving you a wider choice of cards!

The data storage speed of cards may differ, depending on the manufacturer and production system.

- SLC (single level cell) system: faster write speed enabled.
- MLC (multi level cell) system: only lower write speed is supported.

For best results, we recommend using a memory card that supports a faster write speed.

Using a lower write speed memory card for recording video may cause difficulties when storing.

You may even lose your video data during the recording. In an attempt to preserve every bit of the recorded video on a low speed card, the camcorder forcibly stores the video on the memory card and displays a warning:

**Low speed card. Please record at a lower resolution.**

If you are unavoidably using a low speed memory card, the resolution and quality of the recording may be lower than the value you set. ➔page 53

The higher the video resolution and quality, the more memory the camcorder uses.



- Samsung is not responsible for data loss due to misuse, including loss caused by any PC virus.
- We recommend using a memory card case to avoid data loss that can be caused by moving the card or by static electricity.
- After a period of use, the memory card may get warm. This is normal and is not a malfunction.



## RECORDABLE TIME AND CAPACITY

### Recordable time available for video

Resolution	Storage media capacity						
	1GB	2GB	4GB	8GB	16GB	32GB	64GB
<b>1280X720/25p</b>	13	27	55	110	220	440	890
<b>720X576/50p (16:9)</b>	13	27	55	110	220	440	890
<b>720X576/50p (4:3)</b>	13	27	55	110	220	440	890

(Unit: Approximate minutes of recording)

### Recordable number of photos

Resolution	Storage media capacity						
	1GB	2GB	4GB	8GB	16GB	32GB	64GB
<b>1696x954 (16:9)</b>	1,650	3,290	6,630	9,999	9,999	9,999	9,999
<b>1280x720 (16:9)</b>	2,270	4,550	9,160	9,999	9,999	9,999	9,999
<b>1600x1200 (4:3)*</b>	1,520	3,030	6,110	9,999	9,999	9,999	9,999
<b>800x600 (4:3)*</b>	2,990	5,970	9,999	9,999	9,999	9,999	9,999

(Unit: Approximate number of images)

1GB  $\approx$  1,000,000,000 bytes : Actual formatted capacity may be less as the internal firmware uses a portion of the memory.



- The figures in the table may differ depending on the actual recording conditions and subject.
- The higher the resolution, the more memory is used.
- Lower resolution increases the recording time, but the image quality may suffer.
- The bit rate automatically adjusts to the recording image. Accordingly, the recording time may vary.
- Memory cards bigger than 64GB may not operate normally.
- The recording length of a Time Lapse REC may vary depending on settings.
- A memory card that is used to store a video can have un-writable areas, which may result in reduced recording time and free memory space.
- The maximum continuous recording time is under 20 minutes. The maximum video file size is 1.8GB. When a video recording time is more than 20 minutes or a video file exceeds 1.8GB, a new video file is created automatically.
- The maximum number of recordable photo and video files is 9,999, respectively.
- Resolutions marked with \* are the resolutions of photos to be recorded when you set video resolution to **720X576/50p (4:3)**.

### ATTACHING THE STRAP

Adjust the length of strap so that the camcorder is stable when you press the **[Recording start/stop]** button with your thumb.

 If you adjust the strap too tightly and use excessive force to insert your hand, the strap hook of the camcorder may be damaged.

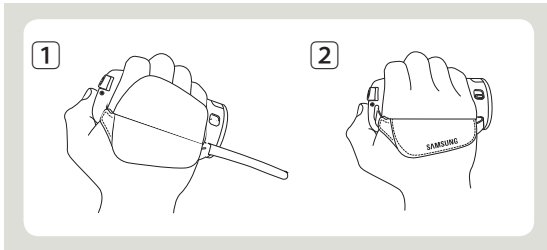



### ADJUSTING THE LCD SCREEN

The wide LCD screen on your camcorder offers high quality image viewing.

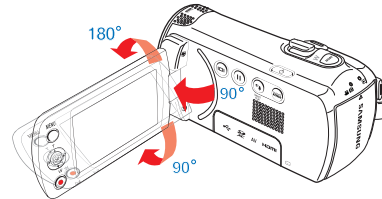
- 1 Open the LCD screen with your finger.
  - The screen opens up to 90°.
- 2 Rotate the LCD screen towards the lens.
  - You can rotate it up to 180° towards the lens and up to 90° backwards. To view recordings more conveniently, rotate the screen by 180° towards the lens, and then fold it back to the body.



 Excessive rotation may damage the connective hinge between the screen and the camcorder.

- 
- When the LCD screen is rotated by 150°–180°, the left and right sides of the subject are shown in reverse, which produces a horizontally flipped image.
  - Remove fingerprints or dust on the screen with a soft cloth.
  - To adjust the LCD brightness, see page 76.

# Basic recording

## RECORDING VIDEOS

Set the desired resolution before recording. ↪ page 53



- Insert a memory card. ↪ page 30
- Open the Lens cover by using the [Lens cover open/close] switch. ↪ page 15
- Press the [Power (⏻)] button to turn on the camcorder.
- Select the recording (📹) mode by pressing the [MODE] button. ↪ page 26



This camcorder features two [Recording start/stop] buttons. One is on the rear side of the camcorder and the other is on the LCD screen. Select the one that works best for you.

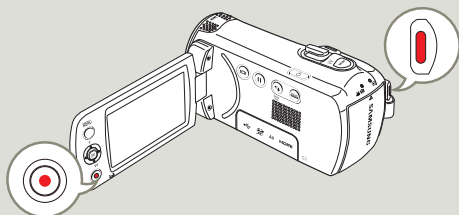

- 1 Select a subject to record.
  - Adjust the LCD screen to the best angle for recording.
  - Use the [Zoom] lever or [Zoom] button to adjust the size of the subject. ↪ page 40
- 2 Press the [Recording start/stop] button.
  - The recording (●) indicator appears and recording starts.
- 3 To stop recording, press the [Recording start/stop] button again.

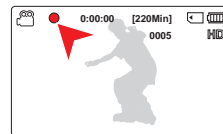

- If power is interrupted or an error occurs during recording, the video may not be recorded.
- Samsung is not responsible for any damage caused by a failure of normal recording or playback operations caused by memory card error.
- Note that damaged data cannot be recovered.
- Do not turn off the camcorder or remove the memory card while accessing the storage media. Doing so may damage the storage media or the data in the storage media.



- For on-screen information display, see pages 16–18.
- For approximate recording times, see page 33.
- Eject the battery when you have finished recording to prevent unnecessary battery power consumption.
- For various functions available when you record videos, see pages 52–66.
- During recording, some button operations are unavailable. ([MODE] button, [MENU] button, etc.)
- Sound is recorded from the internal stereo microphone on the top-front of the camcorder. Take care that this microphone is not blocked.
- Before recording an important video, make sure to test the recording function to check if there is any problem with the audio or video recording.
- You can adjust the brightness of the LCD screen in the menu options. Adjusting the LCD screen does not affect the image being recorded. → page 76
- You cannot use a locked memory card for recording. You will see a message saying recording is disabled due to the lock.
- Recording videos in a quiet environment increases microphone sensitivity that may record surrounding ambient noise. The increasing microphone sensitivity can let the camcorder record zoom noises during zooming (the sound of the zoom mechanism etc).
- When you record indoors or in the dark places, ISO sensitivity is automatically adjusted. It can make interference effects on images and you cannot view the images recorded in the dark places correctly. We recommend you to use professional camcorders like a infrared camcorder when recording at night.
- An image can be shaken when the Anti-Shake(HDIS) function is enabled if the camcorder is mounted on a tripod or fixed on a place. Release the Anti-Shake(HDIS) function when the camcorder is mounted on a tripod.

## RECORDING PAUSE/RESUME

The camcorder allows you to pause temporarily while recording a video. With this function, you can record separate scenes as a single video.

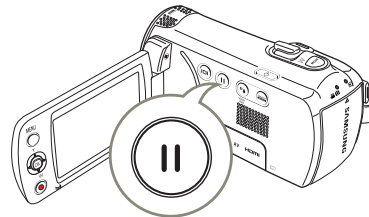

- 1 Press the **[Recording start/stop]** button.

- The recording (●) indicator appears and recording starts.

- 2 Press the **[Recording pause/resume (⏸)]** button.

- The recording pauses and the indicator (⏸) appears.
- To continue the recording, press the **[Recording pause/resume (⏸)]** button.



- If you connect your camcorder to a PC using a USB cable when recording is paused, the camcorder will connect to the PC after it saves the video it has recorded up to the pause.
- If you remove the memory card when the camcorder is in Pause mode, the camcorder turns off the power and will not save any of the video it has recorded.

## TAGGING AND CAPTURING GREAT MOMENTS WHILE RECORDING (MY CLIP FUNCTION)

What is My Clip function? You can tag good scenes while recording and enjoy the scenes tagged as 'My Clip' (📌) from a long video. The camcorder can also capture photos while tagging the scenes. The My Clip function can work by pressing the **[PHOTO]** button.

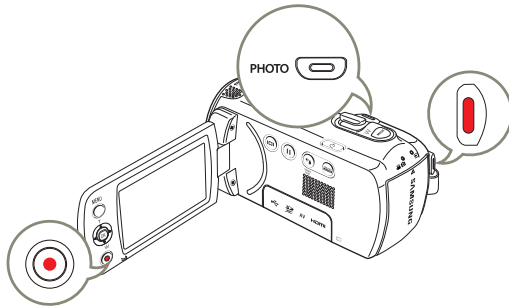

- 1 Press the **[Recording start/stop]** button.
  - The recording (●) indicator appears and recording starts.
- 2 Press the **[PHOTO]** button every great moment while recording.
  - The camcorder tags the scenes as My Clip (📌) and captures photos at the same time.
- 3 To stop recording, press the **[Recording start/stop]** button again.

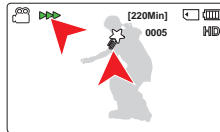

### Understanding My Clip function

Captured photos are saved on the photo thumbnail view.

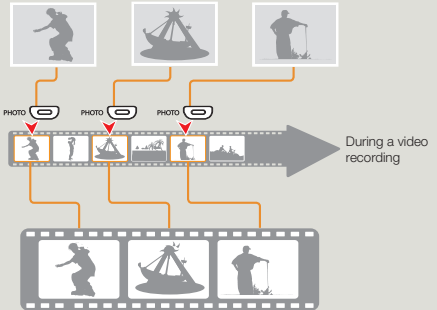

You can extract and playback the scenes tagged as 'My Clip' (📌) from a video. ➔page 45

- The camcorder can tag up to 5 as 'My Clip' and capture up to 5 photos while recording a video.
- The camcorder tags the scene recorded between before 3 seconds and after 5 seconds when pressing the **[PHOTO]** button while recording.
- Photos are captured in the video recording resolution.
- While time lapse recording, My Clip function does not operate.
- You can also tag any scenes of a video by pressing the **[PHOTO]** button during a video playback. ➔page 46
- The captured photos are not recorded if an error occurs during video recording or the camcorder does not complete recording successfully.

## RECORDING PHOTOS

Set the desired resolution before recording. ↪ page 54



- Insert a memory card. ↪ page 30
- Open the Lens cover by using the [Lens cover open/close] switch. ↪ page 15
- Press the [Power (⏻)] button to turn on the camcorder.
- Select the recording (📷) mode by pressing the [MODE] button. ↪ page 26

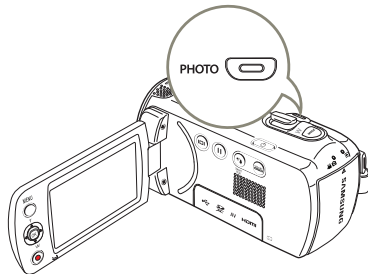

- 1 Select a subject to record.
  - Adjust the LCD screen to the best angle for capturing.
  - Use the [Zoom] lever or [Zoom] button to adjust the size of the subject. ↪ page 40

- 2 Adjust the subject at the centre of the LCD screen.
- 3 Fully press the [PHOTO] button.

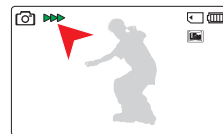

- The shutter sound is heard (when **Shutter Sound: On** is set).
- To continue capturing, wait until the current photo is completely saved on the storage media.



Do not turn off the camcorder or remove the memory card when taking photos as it may damage the storage media or data.





- **This camcorder provides one combined video and photo recording mode. You can easily record videos or photos in the same mode without having to change it.**
- The recordable number of photos varies depending on the photo resolution. ↪ page 33
- Audio is not recorded when you take photos.
- For the on-screen display information, see pages 16–18.
- You can adjust the brightness of the LCD screen in the menu options. Adjusting the LCD screen does not affect the image being recorded. ↪ page 76
- For various functions available during recording, see pages 52–66.
- Photo files conform to the DCF (Design rule for Camera File system) standard, established by JEITA (Japan Electronics and Information Technology Industries Association).



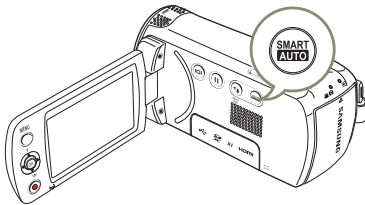



## RECORDING WITH EASE FOR BEGINNERS (SMART AUTO)

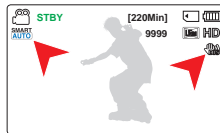

User-friendly SMART AUTO optimises your camcorder to the recording conditions automatically, providing beginners with the best performance.



- Press the **[SMART AUTO]** button.
  - The SMART AUTO () and Anti-Shake(HDIS) () icons appear on the screen at the same time.
- Adjust the subject on the LCD screen.
  - The camcorder automatically detects the scene (Landscape, etc.) and adjusts the camcorder settings accordingly.
  - The appropriate scene icon appears on the LCD screen.



Scene icons	Meaning
	Appears when recording a night scene.
	Appears when recording with a very bright background.
	Appears when recording indoors.
	Appears when recording a close-up.
	Appears when recording a landscape.
	Appears when recording a portrait.
	Appears when recording a portrait outdoors at night.

- Press the **[Recording start/stop]** button or **[PHOTO]** button.
  - pages 35, 38
- To cancel the SMART AUTO mode, press the **[SMART AUTO]** button again.
  - The SMART AUTO () and Anti-Shake(HDIS) () icons disappear from the screen.
    - When there is no detected scene, the icon () appears.
    - The camcorder may not detect the Portrait mode when recording a face, depending on the position of the face or brightness.
    - Depending on conditions such as lighting, shaking of the camcorder, or distance to the subject, the camcorder may detect the image you see on the LCD screen as a different scene type each time you apply SMART AUTO.
    - The Portrait and Night portrait modes can work when the **Face Detection** is set to **On** only. pages 56
    - Buttons unavailable during SMART AUTO operation: **[MENU]** button, **[Control (OK)]** button, etc. Most settings are automatically adjusted in SMART AUTO mode. To set or adjust functions on your own, release the SMART AUTO mode first.
    - SMART AUTO must be set before recording.

## ZOOMING IN/OUT

Use the zoom function for close-up or wide-angle recording. This camcorder allows you to record using 52x optical power zoom, 65x Intelli-zoom and 130x digital zoom.

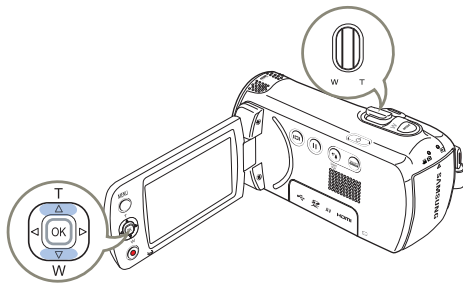

### To zoom in (T)

Slide the **[Zoom]** lever towards **[T]** (telephoto).  
(Or press the **[Control (Up)]** button on the LCD screen.)

- The distant subject is gradually magnified.

### To zoom out (W)

Slide the **[Zoom]** lever towards **[W]** (wide-angle).  
(Or press the **[Control (Down)]** button on the LCD screen.)

- The subject gets smaller and further away.
- The smallest zoom ratio is the subject's original size in the zoom-out.

W: Wide-angle



T: Telephoto



- Zoom magnification over 65x is done through digital image processing, and is therefore called digital zoom. Digital zooming is possible up to 130x. → page 62
- To maintain sharp focus, the minimum possible distance between the camcorder and subject is about 1 cm (about 0.39 inch) for wide-angle and 1 m (about 39.4 inches) for telephoto.
- Optical zoom preserves image quality, but the image quality may suffer when you use digital zoom.
- Fast zooming or zooming in a subject that is a good distance away may cause the camcorder to focus slowly. If this occurs, use **Focus: Manual**. → page 58
- We recommend you use **Anti-Shake(HDIS)** for handheld recording when the subject is zoomed in and enlarged.
- Frequent use of the zoom function consumes more power.
- If you zoom when recording, the camcorder may record the sound of the **[Zoom]** lever or **[Zoom]** button operating.
- When you use the zoom function, you can decrease its speed by slowly moving the **[Zoom (T/W)]** lever. Moving the lever quickly increases the zoom speed. However, you cannot use the **[Zoom (T/W)]** button on the display to adjust the zoom speed.
- When Video Resolution is set to **1280x720/25p**, the Intelli Zoom function does not operate.



## USING THE BACK LIGHT BUTTON

When a subject is lit from behind, this function compensates for lighting so that the subject is not too dark.

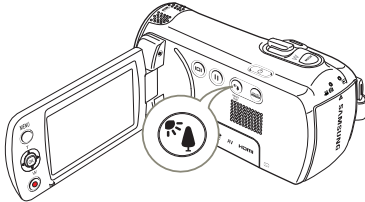

Press the **[Back light (☀🌳)]** button to toggle the back light mode between On and Off.

 Back lighting influences recording when the subject is darker than the background:

- The subject is in front of a window.
- The subject is against a snowy background.
- The subject is outdoors and the background is overcast.
- The light sources are too bright.
- The person to be recorded is wearing white or shiny clothes and is placed against a bright background.
- The person's face is too dark to distinguish his/her features.



<Backlight off>



<Backlight on>

# Basic playback

## CHANGING THE PLAYBACK MODE

- You can switch to the playback mode by pressing the **[MODE]** button.
- The recorded videos or photos appears in thumbnail view and the most recently created file is highlighted in the thumbnail view.
- The camcorder selects the thumbnail display options based on the standby mode you used the last time. However, you can choose the video or photo thumbnail view display options by using the **[Zoom]** lever.

### Understanding how to change the operation modes

You can easily change the playback mode by using the buttons as shown in the following figures:

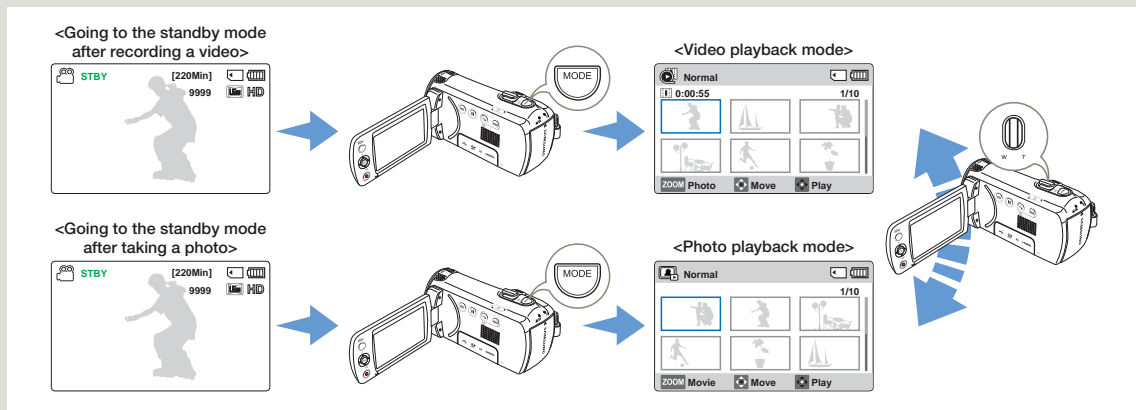

## PLAYING BACK VIDEOS

You can preview recorded videos in a thumbnail view, find your desired video quickly, and play back directly.



- Insert a memory card. ↪ page 30
- Open the LCD screen and press the [Power (⏻)] button to turn on the camcorder.
- This function works only in the video playback (🎞️) mode. ↪ page 26

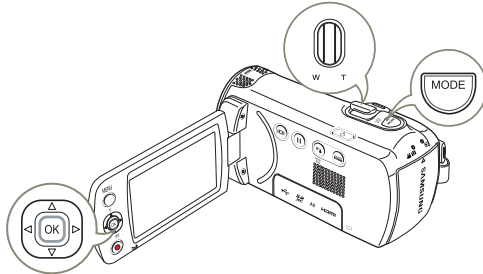

### 1 Select the video thumbnail view.

- You can easily switch between video and photo thumbnail view using the [Zoom] lever.
- The playback time of the selected file and the thumbnail showing the video playback will appear on the screen.

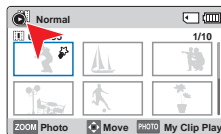

### 2 Use the [Control (Up/Down/Left/Right)] button to select the desired videos, and then press the [Control (OK)] button.

- The camcorder plays back the video you selected and the shortcut menu for playback appears for a short time.
- The selected videos play back according to the **PlayOption** setting. ↪ page 68
- If you play back a video tagged as My Clip, the My Clip (👤) icon on the LCD screen appears. The colour of the My Clip icon is changed to yellow at the scenes tagged as My Clip (for 8 seconds).

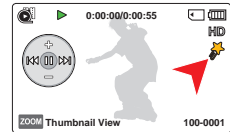

### 3 To stop playback and return to the thumbnail view, use the [Zoom] lever.



Do not power off the camcorder or eject the memory card during video playback. Doing so may damage the recorded data.



- The loading time of a video may vary depending on the video file's size and video resolution.
- Video files may not play back on the camcorder in the following cases:
  - A video recorded on another device.
  - A video whose file format is not supported by the camcorder.
- The internal speaker automatically turns off when the Audio/Video cable is connected to the camcorder. (When the camcorder is connected to an external device, adjust the volume using the connected external device.)
- You can play back recorded video files on a TV or a PC. ↪ pages 80, 85
- For various functions available during playback, see page 44.

## Various playback operations

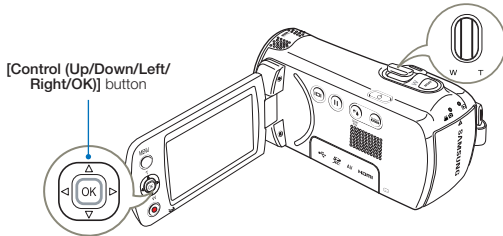

### Playback/Pause/Stop

- 1 Playback and pause alternate when you press the **[Control (OK)]** button during playback.
- 2 Use the **[Zoom]** lever to stop playback and return to the thumbnail view.

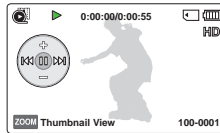

### Search playback

- 1 During playback, press and hold the **[Control (Left/Right)]** button for reverse search/forward search.
- 2 Pressing the **[Control (Left/Right)]** button to repeatedly increases the search speed for each direction.
  - RPS (Reverse Playback Search) rate: x2 → x4 → x8 → x16
  - FPS (Forward Playback Search) rate: x2 → x4 → x8 → x16
- 3 To resume normal playback, press the **[Control (OK)]** button.



### Skip playback

- During playback, press the **[Control (Right)]** button to locate the start point of the next file. Pressing the **[Control (Right)]** button repeatedly skips files in the forward direction.
- During playback, press the **[Control (Left)]** button to locate the start point of the current file. Pressing the **[Control (Left)]** button repeatedly skips files in the reverse direction.
- Press the **[Control (Left)]** button within 3 seconds from the start point of the current file to skip back to the previous file.

### To adjust the volume during video playback

Press the **[Control (Up/Down)]** button to increase or decrease the volume.

- You can hear the recorded sound from the internal speaker.
- The level can be set anywhere between 0 and 10.

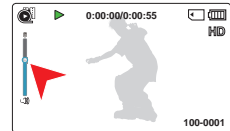

- If you close the LCD screen during playback, you may not hear the sound from the speaker.
- You can hear the recorded sound only when the playback is at normal speed.
- When playing back the My Clip tags, the search playback function does not operate.

## PLAYING BACK MY CLIP

You can extract and play back the scenes tagged as 'My Clip' from a video.

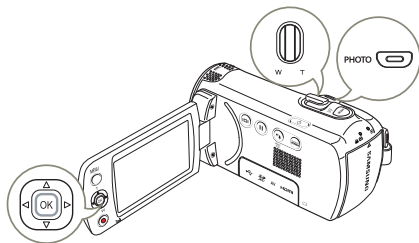

- 1 Select the video thumbnail view.
- 2 Use the [Control (Up/Down/Left/Right)] button to select the video tagged as My Clip (👉), and then press the [PHOTO] button.
  - The camcorder plays back the tagged scenes sequentially.
- 3 To stop playback and return to the thumbnail view, use the [Zoom] lever.

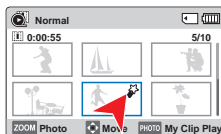

## USING THE SMART BGM FUNCTION

You can enjoy music during video playback. If the original sound in the video is big, the background music will be decreased naturally. On the other hand, if the original sound in the video is small, the background music will be increased naturally.

- ☑ This function works only in the video playback (📺) mode.
  - ➔ page 26

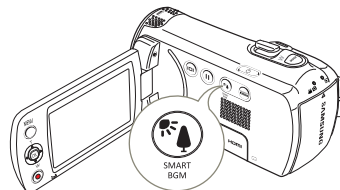

Select the desired video to play back and then press the [SMART BGM] button.

- To cancel, press the [SMART BGM] button again.

- 🔧 You can change the background music in the Smart BGM Option.
  - ➔ page 68

### TAGGING AND CAPTURING GREAT MOMENTS WHILE PLAYING BACK VIDEO

You can tag good scenes during playback to enjoy the only scenes tagged as 'My Clip' (👉) and you can capture photos.

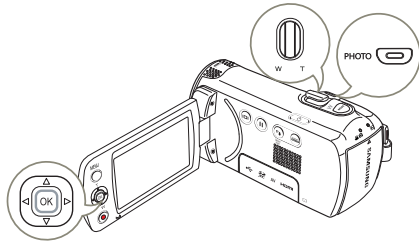

- 1 Select the video thumbnail view.
- 2 Use the **[Control (Up/Down/Left/Right)]** button to select the desired videos, and then press the **[Control (OK)]** button.
  - The camcorder plays back the video you selected and the shortcut menu for playback appears for a short time.



- 3 Aim the camcorder at the scene you want and then press the **[PHOTO]** button.
  - The camcorder tags the scenes as My Clip (👉) and captures photos at the same time.
- 4 To stop playback and return to the thumbnail view, use the **[Zoom]** lever.

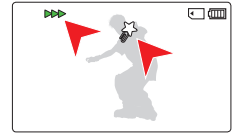

- During a video playback, the camcorder can tag up to 20 as 'My Clip' from a video and capture photos until the available remaining capacity of the storage media.
- Photos are captured in the same resolution of the video recording.
- If you press the **[PHOTO]** button while extracting and playing back the scenes tagged as My Clip, the camcorder switches to STBY mode.

## VIEWING PHOTOS

You can view recorded photos by using various playback functions.



- Insert a memory card. ↪ page 30
- Open the LCD screen and press the **[Power (⏻)]** button to turn on the camcorder.
- This function works only in the photo playback (📷) mode. ↪ page 26

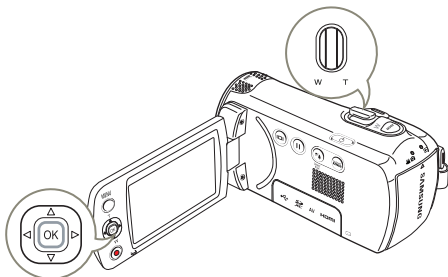

1 Select the photo thumbnail view.

- You can easily switch between video and photo thumbnail view using the **[Zoom]** lever.

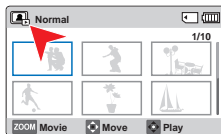

2 Use the **[Control (Up/Down/Left/Right)]** button to select the desired photos, and then press the **[Control (OK)]** button.

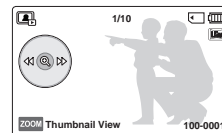

- The camcorder displays the photo you selected in full screen view and the shortcut menu for playback appears for a short time.
- To view the previous/next photo, press the **[Control (Left/Right)]** button.

3 To return to the thumbnail view, use the **[Zoom]** lever.



Do not power off the camcorder or eject the memory card during photo playback. Doing so may damage the recorded data.



- Loading time may vary depending on the size and quality of the selected photo file.
- Your camcorder may not play back the following photo files normally:
  - The photo has been recorded on another device.
  - The photo is in a file format not supported by this camcorder (a format that does not conform to DCF standards).

### ZOOMING DURING PHOTO PLAYBACK

You can magnify a playback image by using the zoom function.

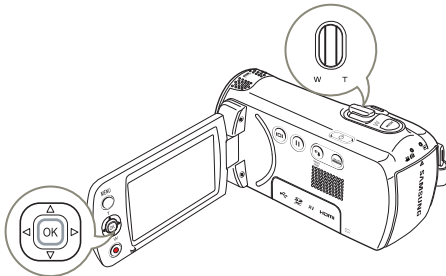

- 1 Select the photo you want to magnify. → page 47
- 2 Adjust the magnification with the **[Control (OK)]** button.
  - The screen is framed and the image is magnified starting from the centre of the image.
  - You can zoom in from x1.3 to x2.0.

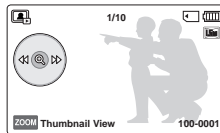

- 3 Press the **[Control (Up/Down/Left/Right)]** button to view the area you want on the magnified photo.
- 4 To cancel, use the **[Zoom]** lever.

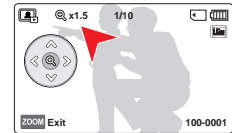

- ⚠ Photos recorded on other devices or those edited on a PC cannot be magnified.
- While you are using the playback zoom, you cannot select other images.



# Using the menu items

## HANDLING MENUS

The instructions below are examples of how to access and use menu items using the [MENU] button. When you access and use other menu items, use these examples as guides.

- ✓ Press the [MODE] button to select the recording (  ) mode.   
 ↪ page 26

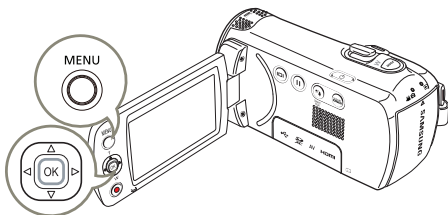

- 1 Press the [MENU] button.
  - The menu screen appears.
- 2 Press the [Control (Left/Right)] button to select **Video Resolution**.
  - The Video Resolution function is used here as an example.

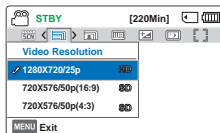

- 3 Press the [Control (Up/Down)] button to select the desired submenu item, and then press the [Control (OK)] button.
- 4 When you finish making settings, press the [MENU] button to exit.

- ✍ • While you are using certain menu items, some other menu items cannot be used at the same time or may be greyed out. For more information, see 'Troubleshooting' on page 100.
- For easy understanding, the menu setting procedures in the example above are explained using the simplest methods. Menu setting methods can differ depending on the menu options you choose.
- You can also access the shortcut menu using the [Control (OK)] button.   
 ↪ page 27

## MENU ITEMS



- The items available in each menu vary depending on the operation mode.
- For item operation details, see the page number listed under Page in the table.

### Recording menu items

Items	Default value	Page
<b>iSCENE</b>	Auto	52
<b>Video Resolution</b>	1280X720/25p	53
<b>Photo Resolution</b>	1696x954 (16:9)	54
<b>White Balance</b>	Auto	54
<b>Face Detection</b>	Off	56
<b>EV</b>	-	57
<b>C.Nite</b>	-	58
<b>Focus</b>	Auto	58
<b>Anti-Shake(HDIS)</b>	Off	60
<b>Digital Special Effect</b>	Off	61
<b>Zoom Type</b>	Optical Zoom	62
<b>Cont. Shot</b>	Off	63
<b>Time Lapse REC</b>	Off	64
<b>Guideline</b>	Off	66
<b>Settings</b>	-	74

### Playback menu items

● : Accessible  
 × : Not accessible

Items	Video playback mode (  )	Photo playback mode (  )	Default value	Page
<b>Thumbnail View Option</b> (Thumbnail view only)	●	●	Normal	67
<b>PlayOption</b>	●	×	Play All	68
<b>Smart BGM Option</b> (Single view only)	●	×	The Flea Waltz	68
<b>Delete</b>	●	●	-	70
<b>Delete My Clip</b>	●	×	-	71
<b>Protect</b>	●	●	-	72
<b>Slide Show</b>	×	●	-	73
<b>File Info</b>	●	●	-	73
<b>Settings</b>	●	●	-	74

### Setting menu items

● : Accessible  
 ✕ : Not accessible

Items	Recording mode 	Playback mode (Thumbnail view)		Playback mode (Single view)		Default values	Page
		Video	Photo	Video	Photo		
Storage Info	●	●	●	●	●	-	74
File No.	●	●	●	●	●	Series	74
Date/Time Set	●	●	●	●	●	-	75
Date/Time Display	●	●	●	●	●	Off	75
LCD Brightness	●	●	●	●	●	Normal	76
Auto LCD Off*	●	●	●	●	●	On	76
Beep Sound	●	●	●	●	●	On	77
Shutter Sound	●	●	●	●	●	On	77
Auto Power Off*	●	●	●	●	●	5 Min	78
PC Software	●	●	●	●	●	On	78
Format	●	●	●	●	●	-	79
Default Set	●	●	●	✕	✕	-	79
Language	●	●	●	●	●	English	79

-  Menu options and default values may be changed without prior notice.
- There are some functions you cannot activate simultaneously in the menu. These items are greyed out. You cannot select the grey menu items.
- In general, functions in both the thumbnail display and full image display employ the same methods, while their detailed options may be different.
- Items marked with \* are available only when the camcorder is powered by the battery.

# Advanced recording

## iSCENE





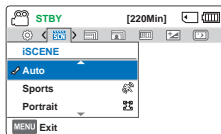

This camcorder automatically can set the shutter speed and aperture according to the subject and brightness for optimum recording.



-  Select the recording (  ) mode by pressing the [MODE] button.  page 26

- 1 Press the [MENU] button → [Control (Left/Right)] button → iSCENE.
- 2 Select the desired submenu item with the [Control (Up/Down)] button, and then press the [Control (OK)] button.
- 3 Press the [MENU] button to exit the menu.



### Submenu Items

Items	Use	On-screen display
Auto	Use this setting for regular recording conditions. The camcorder automatically adjusts the aperture value and shutter speed for optimum recording.	-
Sports	For recording rapidly moving subjects. Example: When recording sports.	
Portrait	For recording a portrait image. Use this setting to capture natural skin tones.	
Spotlight	For recording subjects under strong light. For example, under stage spotlights in theaters.	
Beach & Snow	Use where sunlight or the reflection of light is intense. Example: a beach or snow field.	
Food	For recording objects close-up in high colour saturation.	
Waterfall	For recording a waterfall or fountain.	

 You can also set iSCENE with the shortcut menu.  page 27

## Video Resolution

You can select the resolution of a video to be recorded.

Select the recording (  ) mode by pressing the [MODE] button. [↪ page 26](#)

- 1 Press the [MENU] button → [Control (Left/Right)] button → **Video Resolution**.
- 2 Select the desired submenu item with the [Control (Up/Down)] button, and then press the [Control (OK)] button.
- 3 Press the [MENU] button to exit the menu.

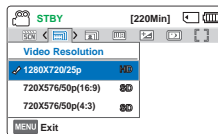

- 50p indicates the camcorder will record in progressive scan mode at 50 frames per second.
- 25p indicates the camcorder will record in progressive scan mode at 25a frames per second.
- Recorded files are encoded using Variable Bit Rate (VBR). VBR is an encoding system that automatically adjusts the bit rate according to the image being recorded.
- High resolution images occupy more memory space than low resolution images. If you select the higher resolution, there is less space to record videos in the memory.
- The recording times depend on the resolution of a video to be recorded. [↪ page 33](#)

### Submenu Items

Items	Use	On-screen display
<b>1280x720/25p</b>	Records in 1280x720 (25p) resolution.	<b>HD</b>
<b>720x576/50p (16:9)</b>	Records in 720x576 (50p) resolution with 16:9 aspect ratio.	<b>SD</b>
<b>720x576/50p(4:3)</b>	Records in 720x576 (50p) resolution with 4:3 aspect ratio.	<b>SD</b>

## Photo Resolution

You can select the quality of photo images to be recorded.

- ✓ Select the recording (  ) mode by pressing the [MODE] button. ➔ page 26



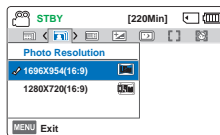

- 1 Press the [MENU] button → [Control (Left/Right)] button → **Photo Resolution**.



- 2 Select the desired submenu item with the [Control (Up/Down)] button, and then press the [Control (OK)] button.

- 3 Press the [MENU] button to exit the menu.

### Submenu Items

Items	Use	On-screen display
1696x954(16:9)	Record in 1696x954 resolution.	
1280x720(16:9)	Record in 1280x720 resolution.	
1600x1200(4:3)*	Record in 1600x1200 resolution.	
800x600(4:3)*	Record in 800x600 resolution.	



- Other devices may not display photos recorded by your camcorder if those devices do not support high resolution.
- For photo development, the higher the resolution, the finer the image quality.
- The number of recordable images differs according to the photo resolution you select. ➔ page 33
- High resolution images occupy more memory space than low resolution images. If you select a higher resolution for your photos, you will have less space to store photos in the memory.
- Resolutions marked with \* are the resolutions of photos to be recorded when you set video resolution to 720X576/50p (4:3).

## White Balance

Using the White Balance function, you can select a setting that matches the light illuminating the subject you are shooting (Daylight, Fluorescent, etc.) or let the camcorder make all adjustments automatically. Based on your selection, the camcorder automatically adjusts the colour of the subject so the colours in your recording look natural.

- ✓ Select the recording (  ) mode by pressing the [MODE] button. ➔ page 26

- 1 Press the [MENU] button → [Control (Left/Right)] button → **White Balance**.

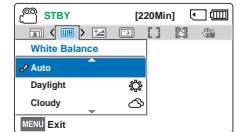

- 2 Select the desired submenu item with the [Control (Up/Down)] button, and then press the [Control (OK)] button.





- 3 Press the [MENU] button to exit the menu.



### Understanding White Balance

The White Balance (WB) process removes unrealistic colour casts so that white objects are rendered white in your image and all other colours look natural. Proper white balance has to take into account the 'colour temperature' of a light source, which refers to the relative warmth or coolness of white light.

## Submenu items

Items	Use	On-screen display
<b>Auto</b>	To let the camcorder adjust the white balance automatically according to the lighting conditions.	-
<b>Daylight</b>	For recording in clear, outdoor lighting.	
<b>Cloudy</b>	For recording in the shade or cloudy weather.	
<b>Fluorescent</b>	For recording under white fluorescent lights.	
<b>Tungsten</b>	For recording under halogen lamps and incandescent lights.	
<b>Custom WB</b>	Lets you manually adjust the white balance to match the light source or situation.	

## To set the white balance manually

- 1 Select **Custom WB**.
  - The indicator () and message **Set White Balance** appear.
- 2 Frame a white object such as a piece of paper so as to fill the screen. Use an object that is not transparent.
  - If the object filling the screen is not focused, correct the focus using **Focus: Manual**.  
 ↳ page 58
- 3 Press the **[Control (OK)]** button.
  - The camcorder applies the stored white balance the next time you record.
- 4 Press the **[MENU]** button to exit the menu.

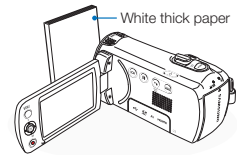
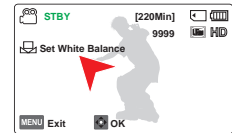

-  • A subject can be recorded under various types of lighting conditions indoors (natural, fluorescent, candlelight, etc.). Because the colour temperature is different depending on the light source, the subject's tint will differ, affecting the subject's white balance. Use this function to correct the white balance and provide a more natural result.
- When you set white balance manually, the object you frame must be white. Otherwise your camcorder may not detect an appropriate setting value.
- The adjusted setting remains until you set the white balance again.
- During normal outdoor recording, setting to **Auto** may provide better results.
- Cancel the digital zoom function for clear and precise setting.
- Reset the white balance if light conditions change.

## Face Detection

Face Detection detects and recognises face-like shapes and adjusts focus, colour, and exposure automatically. Also, it adjusts recording conditions so that they are optimised for the face detected.

- ✓ Select the recording (  ) mode by pressing the [MODE] button. [page 26](#)

- 1 Press the [MENU] button → [Control (Left/Right)] button → **Face Detection.**

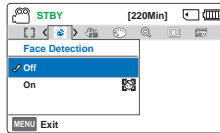

- 2 Select the desired submenu item with the [Control (Up/Down)] button, and then press the [Control (OK)] button.
- 3 To exit the menu, press the [MENU] button.



### Submenu Items

Items	Use	On-screen display
Off	To disable the function.	-
On	To detect faces automatically and set the optimal recording values.	

### Examples of the Face detection mode

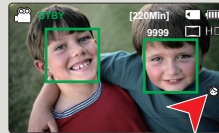
When you set **Face detection** to **On**, the face detection frame appears around faces as shown in the figure below. The camcorder can detect up to three faces.



- ✎ The Face Detection indicator (  ) and Face Detection frame (  ) are not recorded.
- Face Detection may not operate depending on the recording conditions. For example, the Face Detection frame may appear on a 'face-like' shape, even when the subject is not a person's face. If this occurs, turn off the Face Detection function.
- The Face Detection frame will not work on the side of a person's face or if the illumination is too low. You must be facing subjects 'head-on' and have enough illumination.
- You can also set the face detection with the shortcut menu. [page 27](#)





## EV (Exposure Value)

The camcorder usually adjusts the exposure automatically. You can also manually adjust the exposure to your preference.

- Select the recording (  ) mode by pressing the [MODE] button. [page 26](#)

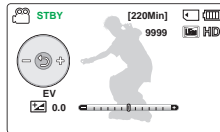
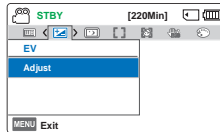
- 1 Press the [MENU] button → [Control (Left/Right)] button → **EV**.
- 2 Press the [Control (OK)] button.
- 3 Press the [Control (Left/Right)] button to adjust the exposure while viewing the image on the LCD screen.
  - EV values (  ): -2.0, -1.6, -1.3, -1.0, -0.6, -0.3, 0, +0.3, +0.6, +1.0, +1.3, +1.6, +2.0



- 4 Confirm your selection by pressing the [Control (OK)] button.
  - The camcorder will apply the exposure value setting and the indicator (  ) and setting value appear.
  - To cancel the adjusted exposure value manually, select 0 in Step 3.

### Understanding EV (Exposure Value)

Exposure value is the total amount of light allowed to fall on the photographic media (Image sensor) during the process of taking photos or videos. The higher the number, the greater the exposure. For example, + 0.3 lets in more light than -0.3.



Darker (-) Brighter (+)

 0.0 

-  You can also set EV with the shortcut menu. [page 27](#)

## C.Nite

You can adjust the shutter speed when recording a slow moving object or a brighter image in dark places without compromising colours.

- Select the recording (  ) mode by pressing the [MODE] button. →page 26

1 Press the [MENU] button → [Control (Left/Right)] button → C.Nite.

2 Select the desired submenu item with the [Control (Up/Down)] button, and then press the [Control (OK)] button.

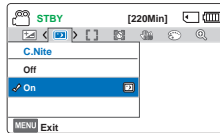

3 Press the [MENU] button to exit the menu.

### Submenu Items

Items	Use	On-screen display
Off	To disable the function.	-
On	To record a brighter image by extending the low shutter speed range to 1/50 or 1/25.	



- When you use C.Nite, the image takes on a slow motion like effect. In addition, the focus adjusts slowly and white dots may appear on the screen. This is not a defect.
- When Video Resolution is set to **1280x720/25p**, the C.Nite function does not operate.

## Focus

When you turn the camcorder on, focus is always set to automatic. You can also set the focus manually.

- Select the recording (  ) mode by pressing the [MODE] button. →page 26

1 Press the [MENU] button → [Control (Left/Right)] button → Focus.

2 Select the desired submenu item with the [Control (Up/Down)] button, and then press the [Control (OK)] button.

3 Press the [MENU] button to exit the menu.

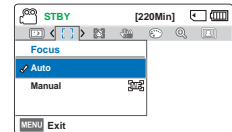

### Submenu Items

Items	Use	On-screen display
Auto	In most situations, it is better to use the automatic focus feature, as it enables you to concentrate on the creative side of your recording.	-
Manual	To focus manually. Manual focusing may be necessary under certain conditions that make automatic focusing difficult or unreliable.	

## Adjusting the focus manually

This camcorder automatically focuses subjects from close-up to infinity. However, the correct focus may not be obtained depending on the recording conditions. In this case, use the manual focus mode.

- 1 Press the **[Control (Up/Down)]** button to select **Manual**.

- The manual focus adjustment indicator appears.

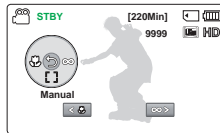

- 2 Press the **[Control (Left/Right)]**

button to select the desired indicator to adjust focus, and then press the **[Control (OK)]** button.

- The manual focus setting will be applied and the (加減) indicator appears.

### Focusing on a nearer or farther subject

To focus on a nearer subject, press the **[Control (Left)]** button.  
To focus on a further subject, press the **[Control (Right)]** button.

- The nearer or further icon (←/→) appears between the indicators when focus adjustment reaches the end.
- The adjusted value is applied right after you press the **[Control (Left/Right)]** button to adjust the focus.

<Nearer subject>



<Further subject>



### Examples of the Manual focus mode

- When the subject is dark.
- When the background is too bright.
- When you view the subject through a window that is stained or wet.
- When the subject has dense horizontal or sloping stripes.
- When the subject is distant and behind a nearby wire fence.
- Walls, atmosphere and other low-contrast subject.
- When the subject is emitting or reflecting strong light.
- When you are focusing on a subject near the boundary of the frame.



- You can also adjust the focus with the shortcut menu. ↪ page 27
- Manual focusing focuses on a point in the framed scene while auto focusing focuses on the centre area automatically.
- The Auto Focus (AF) setting is useful when you operate the zoom function because you might not be able to keep accurate focus after the zoom ratio has been changed.
- When **Zoom Type** is set to **Digital Zoom**, manual focusing will not focus with accuracy. Before focusing manually, check if the **Digital Zoom** is turned off. ↪ page 62

## Anti-Shake(HDIS)

Use the Anti-Shake(HDIS) function to compensate for unstable images caused by shaking movements while holding the camcorder.

 Select the recording (  ) mode by pressing the [MODE] button.  page 26

1 Press the [MENU] button → [Control (Left/Right)] button → **Anti-Shake(HDIS)**.

2 Select the desired submenu item with the [Control (Up/Down)] button, and then press the [Control (OK)] button.

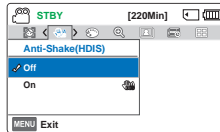

3 Press the [MENU] button to exit the menu.

### Submenu Items

Items	Use	On-screen display
Off	To disable the function.	-
On	To enable the Anti-Shake(HDIS) function to compensate for shaking movements.	

### Use the Anti-Shake function in the following cases

- When recording while using the zoom extensively.
- When recording a close up picture of a small object.
- When recording while walking, or in a moving car.



-  The camcorder automatically activates the **Anti-Shake(HDIS)** function in the Smart Auto mode.
- Gross camcorder shake may not be entirely corrected even if **Anti-Shake(HDIS)** is **On**. Firmly hold the camcorder with both hands.
- When this function is **On**, the actual movement of the subject and the movement displayed on the screen may be slightly different.
- When recording in dark lighting at high magnification while this function is **On**, after-images may stand out. In this case, we recommend using a tripod (not supplied) and turning **Anti-Shake(HDIS)** to **Off**.

## Digital Special Effect

Using the digital special effect function gives your recording a creative look.

 Select the recording (  ) mode by pressing the [MODE] button. [page 26](#)

- 1 Press the [MENU] button → [Control (Left/Right)] button → **Digital Special Effect.**
- 2 Select the desired submenu item with the [Control (Up/Down)] button, and then press the [Control (OK)] button.
- 3 Press the [MENU] button to exit the menu.

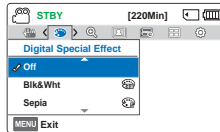

### Examples of 7 digital effect options



**Off**  
Disables the function.



**Blk&Wht** (  )  
This mode changes the image into black and white.



**Sepia** (  )  
This mode gives images a reddish brown pigment.



**Negative** (  )  
This mode reverses the colours and the brightness and creates a negative look.



**Dazzle** (  )  
This mode creates a brighter image by increasing colour saturation.



**Noir** (  )  
This mode creates a stronger image by increasing contrast.



**Western** (  )  
This mode creates a faded and old film vintage look.

## Zoom Type

The camcorder offers three types of zoom: optical, intelligent, and digital zoom.

- ✓ Select the recording (  ) mode by pressing the [MODE] button. → page 26

- 1 Press the [MENU] button → [Control (Left/Right)] button → **Zoom Type.**

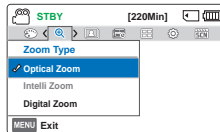

- 2 Select the desired submenu item with the [Control (Up/Down)] button, and then press the [Control (OK)] button.
- 3 Press the [MENU] button to exit the menu.

### Submenu Items

Items	Use
<b>Optical Zoom</b>	To use optical zoom, up to 52X.
<b>Intelli Zoom</b>	<ul style="list-style-type: none"> <li>• The camcorder zooms the full width of the image sensor to obtain a larger zoom range without any deterioration in image quality.</li> <li>• Intelli-zoom is available up to 65X.</li> </ul>
<b>Digital Zoom</b>	<ul style="list-style-type: none"> <li>• When this option is selected, the camcorder will automatically switch to the digital zoom if you zoom in beyond the optical or intelligent zoom range.</li> <li>• Digital zoom is available up to 130X.</li> </ul>

### Digital zoom range

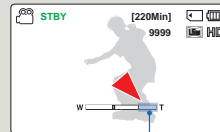

The right side of the bar shows the digital zooming zone. The zooming zone appears when you move the [Zoom] lever or [Zoom] button.

- ✎ With the digital zoom, the image is digitally processed more than the intelli or optical zoom modes. As a result, the image resolution may deteriorate. The image quality may deteriorate depending on how much you zoom in on the subject.
- The zoom range will change depending on the aspect ratio of the video.

## Cont. Shot

The Continuous Shot function allows you to capture photos in rapid succession to give you more photo-taking opportunities when recording moving subjects.

-  Select the recording (   ) mode by pressing the [MODE] button. →page 26

- 1 Press the [MENU] button → [Control (Left/Right)] button → **Cont. Shot**.
- 2 Select the desired submenu item with the [Control (Up/Down)] button, and then press the [Control (OK)] button.
- 3 Press the [MENU] button to exit the menu.

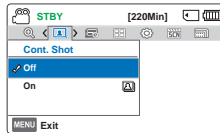

### Submenu Items

Items	Use	On-screen display
Off	To record only one photo image.	-
On	While you are pressing the [PHOTO] button, the camcorder can take up to 30 photos continuously.	

-  • The number of recordable photos depends on the photo's resolution and the memory space.
- If an error occurs (Card full, etc.) during continuous shot, the recording stops and an error message appears.

## Time Lapse REC

Using the Time Lapse feature, you can programme your camcorder to create a time lapse video by recording a series of frames over a set period of time with a set time interval between each frame. The Time Lapse feature lets you create time lapse videos of blooming flowers and similar subjects.



- Select the recording ( ) mode by pressing the [MODE] button. → page 26
- To record in the Time Lapse REC mode, you must set the recording interval between frames (Interval) using the menu.

- 1 Press the [MENU] button → [Control (Left/Right)] button → **Time Lapse REC**.
- 2 Press the [Control (Up/Down)] button to select **On**, then press the [Control (OK)] button.
  - The recording interval and total recording time items appear.
- 3 Set the desired recording interval (Sec) with [Control (Up/Down)] button.

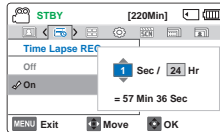
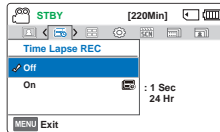

- 4 Move to the next setting (**Hr**) by pressing the [Control (Left/Right)] button, and then set the desired total recording time in the same way.
- 5 Press the [Control (OK)] button to finish the setting, and then press the [MENU] button to exit the menu.
- 6 After setting the Time Lapse REC mode, press the [Recording start/stop] button.
  - The Time Lapse REC starts.
  - Depending on the selected total recording time and recording interval, image frames are captured by each scene.

### Submenu items

Items	Use	On-screen display
Off	To disable the function.	-
On	<ul style="list-style-type: none"> <li>• Interval (Sec): To set the time interval between image captures. 1 → 3 → 5 → 10 → 15 → 30 (Seconds)</li> <li>• REC Limit (Hr): To set the total time of recording. 24 → 48 → 72 → ∞ (Hours)</li> </ul>	



During Time Lapse recording, the **C.Nite** function does not work.



### Example of Time Lapse Recording

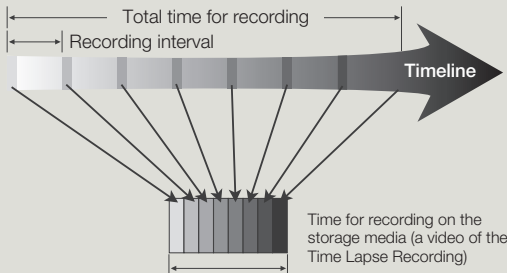

The Time Lapse Recording function records image frames at a predefined interval over the total recording time to produce a time-lapse video.

For example, the Time Lapse Recording is useful for filming in the following situations:

- Blooming flowers
- A bird building a nest
- Clouds rolling by in the sky

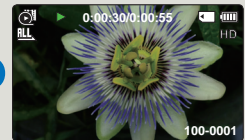
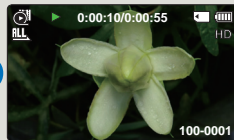
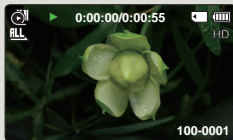

- Time Lapse Recording mode is released once recording has been finished. To start another Time Lapse Recording, repeat steps 1 to 6 on the previous page.
- According to the video resolution, 50 or 25 captured images compose a video of 1 second length. Since the minimum length of a video that your camcorder can save is one second, the interval defines the total minimum recording time for the Time Lapse Recording. For example, if you set the interval to **30 Sec**, you need to set the recording time for the Time Lapse Recording to at least 25 or 13 minutes to record a minimum video length of 1 second (50 or 25 images).
- Press the **[Recording start/stop]** button if you want to stop the Time Lapse Recording.
- Audio is not recorded during time lapse recording.
- The maximum continuous recording time is under 20 minutes. The maximum video file size is 1.8GB. When a video recording time is more than 20 minutes or a video file exceeds 1.8GB, a new video file is created automatically.
- If the battery charge is exhausted during time lapse recording, the camcorder saves recording up to that point and switches to standby mode. After a while, it displays a warning message, then turns off automatically.
- If the storage media becomes full during time lapse recording, the camcorder switches to the standby mode after saving the recording up to the maximum memory available.
- We recommend using the power adaptor for a Time Lapse Recording instead of the battery.
- When a time lapse recording starts, the message of Time Lapse Recording will blink even if you switch the information display mode to the minimum display mode. This is normal operation. Do not remove the power source or memory card from the camcorder.

## Guideline

This camcorder provides 3 types of guidelines to help you to set a balanced image composition on the screen.

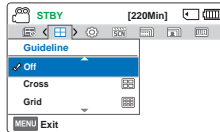

 Select the recording (   ) mode by pressing the [MODE] button. [page 26](#)

- 1 Press the [MENU] button → [Control (Left/Right)] button → **Guideline.**



- 2 Select the desired submenu item with the [Control (Up/Down)] button, and then press the [Control (OK)] button.
- 3 Press the [MENU] button to exit the menu.

## Submenu Items

Items	Use	On-screen display
<b>Off</b>	To cancel the guideline function.	-
<b>Cross</b>	Use when focusing a subject in the centre.	
<b>Grid</b>	Use when recording a subject in a horizontal or vertical composition or shooting with the tele macro function.	
<b>Safety Zone</b>	Positioning subjects within the Safety Zone rectangle ensures they will be recorded.	

-  Positioning a subject at the cross point of a guideline provides a balanced composition.
- Guidelines are not recorded.

# Advanced playback

## Thumbnail View Option

The Thumbnail View Option lets you sort thumbnails of the recorded videos or photos by different display options.

- Press the [MODE] button to select the playback (▶) mode. ↪ page 26
- Select the video or photo thumbnail view. ↪ page 42

1 Press the [MENU] button → [Control (Left/Right)] button → **Thumbnail View Option.**

2 Select the desired submenu item with the [Control (Up/Down)] button, and then press the [Control (OK)] button.

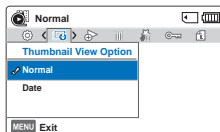

### Submenu Items

Items	Use
<b>Normal</b>	To display the thumbnails of files in the order in which the files were recorded.
<b>Date</b>	To sort the thumbnails of recorded files by the date when the files were recorded.

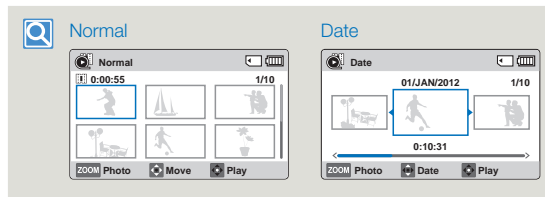

 This function is available in the thumbnail view only.

## PlayOption

You can set a specific playback style according to your preference.

- Press the **[MODE]** button to select the playback (▶) mode.
  - ▶ page 26
- Select the video thumbnail view. ▶ page 42

1 Press the **[MENU]** button → **[Control (Left/Right)]** button → **PlayOption**.

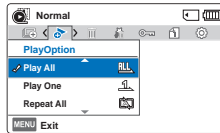

2 Select the desired submenu item with the **[Control (Up/Down)]** button, and then press the **[Control (OK)]** button.

3 Press the **[MENU]** button to exit the menu.

### Submenu Items

Items	Use	On-screen display
<b>Play All</b>	To play back from the selected video to the last video.	
<b>Play One</b>	To play back the selected video only once.	
<b>Repeat All</b>	To play back all videos repeatedly.	
<b>Repeat One</b>	To play back the selected video repeatedly.	

## Smart BGM Option

You can play back a video with background music by selecting the desired background.

- Press the **[MODE]** button to select the playback (▶) mode.
  - ▶ page 26
- This function is available in the video single view only.

1 Press **[MENU]** button → **[Control (Left/Right)]** button → **Smart BGM Option**.

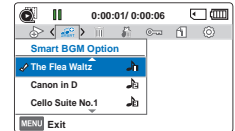

2 Select the desired submenu item with the **[Control (Up/Down)]** button, and then press the **[Control (OK)]** button.

3 Press the **[MENU]** button to exit the menu.

- To play back the selected background music with a video, press the **[SMART BGM]** button when the video plays back. To stop the background music, press the **[SMART BGM]** button again.

### Submenu Items

Items	Use
<b>The Flea Waltz</b>	To play back The Flea Waltz.
<b>Canon in D</b>	To play back Canon in D.
<b>Cello Suite No.1</b>	To play back Cello Suite No.1.
<b>Nocturne</b>	To play back Nocturne.
<b>Random</b>	To play back from The Flea Waltz to Nocturne randomly.

- When you change a background music by pressing the **[MENU]** button while the video is playing back, the video will be paused. Press the **[Control (OK)]** button to play back the paused video again with the changed background music.

## Using external songs as background music (Smart BGM II)

You can enjoy external songs by saving them into a memory card, as well as the sounds in Smart BGM Option of the camcorder.



- Insert a memory card.
- Prepare external songs for background music.

## To set external songs as background music

You should convert your songs to a compatible format using the Intelli-studio programme built in your camcorder to be recognised by the camcorder.

- 1 Connect the camcorder to a PC with the USB cable to run the Intelli-studio programme. → page 85
- 2 Click **Tool** on the Intelli-studio screen → **Sending song for Smart BGM.**

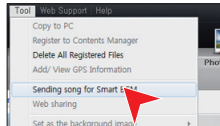

- 3 Click **Browse** on the Smart BGM screen to select the desired song.
- 4 Change the song's name to be recognised by the camcorder, and then click **Send** → **Yes**.
  - The song is converted to the m4a file and transferred into the memory card in the camcorder.
- 5 When the transferring finishes, click **OK**.
  - You can save up to 5 converted songs into the memory card in the camcorder.



- 6 The song saved into the memory card appears on the **Smart BGM Option** menu in video playback mode. → page 68

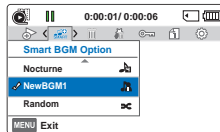

## To delete the external songs in the memory card

You can delete the external songs from **Manage BGM** in the Smart BGM screen or from the BGM folder in the memory card.

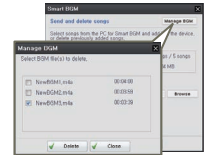

In the case of the camcorder sold in Europe, you should save external songs as follows.

- 1 Follows steps 1~3 as the figure on the left.
- 2 Change the external song's name → select a location to save it → click **Convert** → **Yes**.
  - The BGM folder is automatically created in the selected location, and then the external song is converted to the m4a file and saved in the BGM folder.
- 3 Connect a memory card to your PC → copy the BGM folder (including converted external songs) from the PC to the memory card → disconnect the memory card from the PC, and then insert it to the camcorder.
- 4 On the **Smart BGM Option** menu in video playback mode, select an external song as background music.

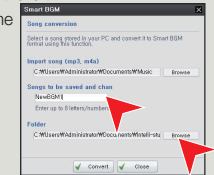

## To delete the external songs in the memory card

- 1 Eject the memory card from the camcorder, and then connect it to your PC.
- 2 Delete the desired external songs from the BGM folder.



- The camcorder can recognise the external songs converted by the Intelli-studio programme only.
- The file formats of external songs to be converted by the Intelli-studio programme are mp3 and m4a formats.
- External songs are saved into the BGM folder in the memory card.
- If you transfer the converted m4a files into the BGM folder in the memory card, you can use them as Smart BGM.

## Delete

You can erase your recordings one by one or all at once.



- Press the [MODE] button to select the playback (▶) mode. ↪ page 26
- Select the video or photo thumbnail view. ↪ page 42

- Press the [MENU] button → [Control (Left/Right)] button → **Delete**.
- Select an option by pressing the [Control (Up/Down)] button, and then press the [Control (OK)] button.

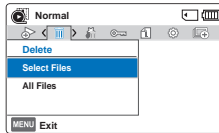

- If you selected **Select Files**, image thumbnails will appear.
  - Use the [Control (Up/Down/Left/Right)] button to move to the photo or video you want to delete.
  - Press the [Control (OK)] button to mark images for deletion. The garbage can icon (🗑️) appears on the photo or video.
  - Repeat Steps a) and b) for each photo or video you want to delete.
  - Press the [MENU] button to delete the photos and videos you selected.
  - The message corresponding to the selected option appears. Use the [Control (Left/Right)] button to select **Yes**, and then press the [Control (OK)] button.

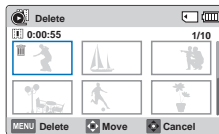

- If you selected **All Files**, the message corresponding to the selected option will appear. Use the [Control (Left/Right)] button to select **Yes**, and then press the [Control (OK)] button.

### Submenu Items

Items	Use
<b>Select Files</b>	To delete the selected videos or photos.
<b>All Files</b>	To delete all videos or photos, except for the protected files.



- Deleted images cannot be recovered.
- Do not remove the power adaptor or memory card while deleting files, otherwise the storage media may be damaged.



- You can also delete your recordings in the single view.
- To protect important images from accidental deletion, activate image protection. ↪ page 72
- Protected images cannot be deleted. To delete a protected image, cancel the protect function first. ↪ page 72
- If the write protection tab on a memory card is set to lock, you cannot delete.
- You can also format the storage media to delete all the images at once. Be aware that all files and data including protected files will be erased. ↪ page 79
- The Delete function does not operate if the battery charge is insufficient. We recommend you use the power adaptor to avoid power-loss while deleting.

## Delete My Clip

You can delete the tag from a video tagged as 'My Clip'.



- Press the [MODE] button to select the playback (▶) mode.  
↳ page 26
- Select the video thumbnail view. ↳ page 42

1 Press the [MENU] button → [Control (Left/Right)] button → **Delete My Clip**.

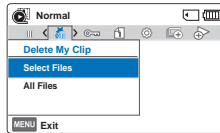

2 Select an option by pressing the [Control (Up/Down)] button, and then press the [Control (OK)] button.

3 If you selected **Select Files**, image thumbnails will appear.

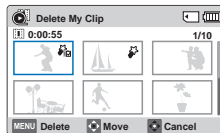

- Use the [Control (Up/Down/Left/Right)] button to move to the video tagged as My Clip (🗑️).
- Press the [Control (OK)] button. The garbage can icon (🗑️) appears on the video.
- Repeat Steps a) and b) for each video tagged as My Clip (🗑️).
- Press the [MENU] button to delete all tags from the videos you selected.
- The message corresponding to the selected option appears. Use the [Control (Left/Right)] button to select **Yes**, and then press the [Control (OK)] button.

4 If you selected **All Files**, the message corresponding to the selected option will appear. Use the [Control (Left/Right)] button to select **Yes**, and then press the [Control (OK)] button.

### Submenu Items

Items	Use
<b>Select Files</b>	To delete the My Clip tags from the selected videos.
<b>All Files</b>	To delete the My Clip tags from all videos.



Deleted My Clip tags cannot be recovered.



You can also delete the My Clip tags from the videos in the single view.

## Protect

You can protect important saved videos or photos from accidental deletion. You cannot delete protected images unless you release the protection or format the memory.



- Press the [MODE] button to select the playback (▶) mode. ↪page 26
- Select the video or photo thumbnail view. ↪page 42

1 Press the [MENU] button → [Control (Left/Right)] button → **Protect**.

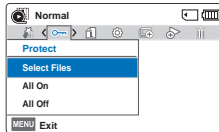

2 Select an option by pressing the [Control (Up/Down)] button, and then press the [Control (OK)] button.

3 If you selected **Select Files**, image thumbnails will appear.

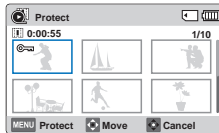

- Use the [Control (Up/Down/Left/Right)] button to move to the photo or video you want to protect.
- Press the [Control (OK)] button to mark images for protection. The key icon (Ⓞ) appears on the photo or video.
- Repeat Steps ② and ③ for each photo or video you want to protect.
- Press the [MENU] button to protect the photos and videos you selected.
- The message corresponding to the selected option appears. Use the [Control (Left/Right)] button to select **Yes**, and then press the [Control (OK)] button.

- If you selected **All On**, the message corresponding to the selected option will appear. Use the [Control (Left/Right)] button to select **Yes**, and then press the [Control (OK)] button.
- If you selected **All Off**, the message corresponding to the selected option will appear. Use the [Control (Left/Right)] button to select **Yes**, and then press the [Control (OK)] button.

### Submenu Items

Items	Use
<b>Select Files</b>	To protect the selected videos or photos from deletion.
<b>All On</b>	To protect all videos or photos.
<b>All Off</b>	To cancel the protection for all videos or photos.



- You can also protect you recordings in the single view.
- If the write protection tab on a memory card is set to lock, you cannot set image protection. ↪page 31



## Slide Show

You can enjoy a slide show with various effects.

- Press the **[MODE]** button to select the playback (▶) mode.
  - ▶ page 26
- Select the photo thumbnail view. ▶ page 42

- 1 Press the **[MENU]** button → **[Control (Left/Right)]** button → **Slide Show**.
- 2 Select an option by pressing the **[Control (Up/Down)]** button, and then press the **[Control (OK)]** button.
- 3 Press the **[MENU]** button to exit the menu.

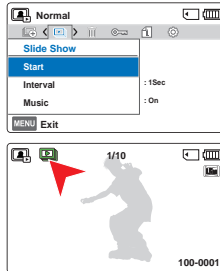

### Submenu Items

Items	Use
<b>Start</b>	To start a slide show from the current image. <ul style="list-style-type: none"> <li>- The indicator (▶) appears.</li> <li>- To stop the slide show, press the <b>[Control (OK)]</b> button again.</li> <li>- To return to the thumbnail view, move the <b>[Zoom]</b> lever.</li> </ul>
<b>Interval</b>	Continuously plays back photos at the interval you select. You can choose <b>1sec</b> or <b>3sec</b> .
<b>Music</b>	You can turn the internal background music on or off. This camcorder has 4 default background melodies stored in the boot-up flash memory. If the music is on when the slide show starts, the 4 melodies will play back in shuffle mode.

## File Info

You can see the image information for all images.

- Press the **[MODE]** button to select the playback (▶) mode.
  - ▶ page 26

- 1 Press the **[MENU]** button → **[Control (Left/Right)]** button → **File Info** → **[Control (OK)]** button.
  - The file selection screen appears.
- 2 Select the desired video or photo by pressing the **[Control (Up/Down/Left/Right)]** button, and then press the **[Control (OK)]** button.
  - The following information for the selected file appears:
    - Date
    - Duration (Video only)
    - Size
    - Resolution
- 3 Press the **[MENU]** button to exit the menu.

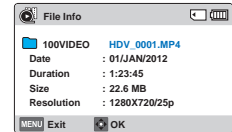
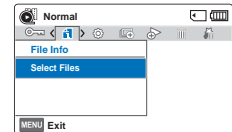

# Other settings

## Storage Info

Storage Info displays the storage information for the storage media.

- 1 Press the **[MENU]** button → **[Control (Left/Right)]** button → **Settings** → **[Control (Up/Down)]** button → **Storage Info** → **[Control (OK)]** button.

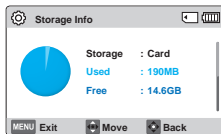

- Press the **[Control (Up/Down)]** button to move the screen up or down and view additional information.
  - You can check the used memory, available memory, and the available recordable time for each recording resolution.
- 2 Press the **[MENU]** button to exit the menu.



- If there is no storage media inserted, it cannot be selected and will be dimmed on the menu.
- The actual capacity may be less than the capacity displayed on the LCD screen as the camcorder's system files occupy a part of the capacity.

## File No.

The camcorder assigns file numbers to recorded files in the order they were recorded.

- 1 Press the **[MENU]** button → **[Control (Left/Right)]** button → **Settings** → **[Control (Up/Down)]** button → **File No.** → **[Control (OK)]** button.
- 2 Select the desired submenu item with the **[Control (Up/Down)]** button, and then press the **[Control (OK)]** button.
- 3 To exit the menu, press the **[MENU]** button.

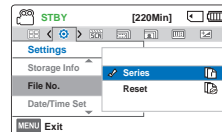
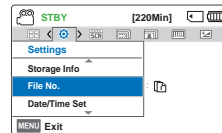

## Submenu Items

Items	Use
<b>Series</b>	Assigns file numbers in sequence even if you have inserted a different memory card, formatted the card, or deleted all files. The file number is reset only when a new folder is created.
<b>Reset</b>	Resets the file number to 0001.





When you set **File No.** to **Series**, each file is assigned a different number to avoid duplicating file names. It is convenient when you want to manage your files on a computer.

## Date/Time Set

By setting the date and time, you can display the date and time of a recording during playback.

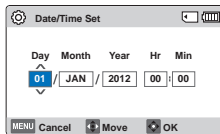
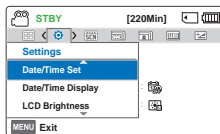
- 1 Press the **[MENU]** button → **[Control (Left/Right)]** button → **Settings** → **[Control (Up/Down)]** button → **Date/Time Set** → **[Control (OK)]** button.
- 2 Select the date or time information, and change the setting values by pressing the **[Control (Up/Down/Left/Right)]** button.
- 3 Make sure the clock is correctly set, and then press the **[Control (OK)]** button.



 The year can be set up to 2037.

## Date/Time Display

You can set whether or not the date and/or time appear on the LCD screen.

- 1 Press the **[MENU]** button → **[Control (Left/Right)]** button → **Settings** → **[Control (Up/Down)]** button → **Date/Time Display** → **[Control (OK)]** button.
- 2 Select the desired submenu and menu item with the **[Control (Up/Down)]** button, and then press **[Control (OK)]** button.
- 3 Press the **[MENU]** button to exit the menu.
  - The date/time appears on the LCD screen according to the selected option.

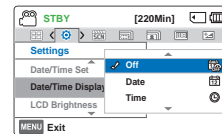
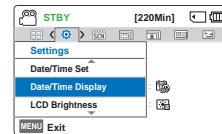

### Submenu Items

Items	Use	On-screen display
Off	Not to display the current date/time.	-
Date	To display the current date.	01/JAN/2012
Time	To display the current time.	00:00
Date & Time	To display the current date and time.	01/JAN/2012 00:00

 When the internal battery is depleted, the date/time will read **01/JAN/2012 00:00**.

## LCD Brightness

You can adjust the brightness of the LCD screen to compensate for ambient lighting conditions.

- 1 Press the **[MENU]** button → **[Control (Left/Right)]** button → **Settings** → **[Control (Up/Down)]** button → **LCD Brightness** → **[Control (OK)]** button.
- 2 Select the desired submenu and menu item with the **[Control (Up/Down)]** button, and then press **[Control (OK)]** button.
- 3 Press the **[MENU]** button to exit the menu.

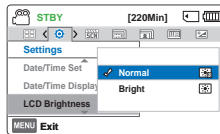
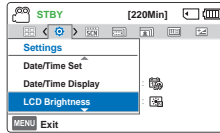

### Submenu Items

Items	Use
<b>Normal</b>	Standard brightness.
<b>Bright</b>	Brightens the LCD screen.



- If the surrounding is too bright, adjust the brightness of the LCD screen.
- Adjusting the LCD screen does not affect the image being recorded.
- A brighter LCD screen consumes more power.

## Auto LCD Off

To reduce power consumption, the brightness of the LCD screen is automatically dimmed if the camcorder is idle for more than 2 minutes.

- 1 Press the **[MENU]** button → **[Control (Left/Right)]** button → **Settings** → **[Control (Up/Down)]** button → **Auto LCD Off** → **[Control (OK)]** button.
- 2 Select the desired submenu item with the **[Control (Up/Down)]** button, and then press the **[Control (OK)]** button.
- 3 Press the **[MENU]** button to exit the menu.

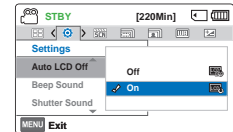
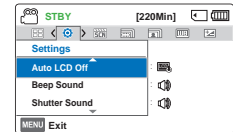

### Submenu Items

Items	Use
<b>Off</b>	To disable the function.
<b>On</b>	When the camcorder is idle for more than 2 minutes in the STBY mode, or for more than 5 minutes when recording a video, the power saving mode starts by dimming the LCD screen.



- When the **Auto LCD Off** function is enabled, you can press any button on the camcorder to return LCD brightness to normal.
- Auto LCD Off will be disabled in the following case:
  - If the power cable (Power adaptor, USB cable) is connected.

## Beep Sound

When Beep Sound is on, the camcorder sounds a beep when you press a button.

- 1 Press the **[MENU]** button → **[Control (Left/Right)]** button → **Settings** → **[Control (Up/Down)]** button → **Beep Sound** → **[Control (OK)]** button.
- 2 Select the desired submenu item with the **[Control (Up/Down)]** button, and then press the **[Control (OK)]** button.
- 3 Press the **[MENU]** button to exit the menu.

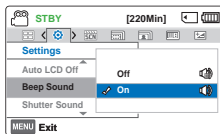
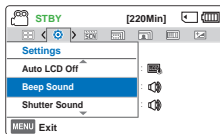

### Submenu Items

Items	Use
Off	Disables the function.
On	To have the camcorder beep every time you press a button.

-  The Beep Sound function is suspended in the following cases:
- During recording and playback
  - Pause while recording
  - When the camcorder has a cable connection. (AV cable, micro HDMI cable, etc.)

## Shutter Sound

You can turn the shutter sound the camcorder emits when you press the **[PHOTO]** button on or off.

- 1 Press the **[MENU]** button → **[Control (Left/Right)]** button → **Settings** → **[Control (Up/Down)]** button → **Shutter Sound** → **[Control (OK)]** button.
- 2 Select the desired submenu item with the **[Control (Up/Down)]** button, and then press the **[Control (OK)]** button.
- 3 Press the **[MENU]** button to exit the menu.

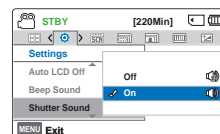
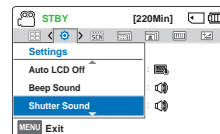

### Submenu Items

Items	Use
Off	To turn the shutter sound off.
On	To turn the shutter sound on. It will sound when you press the <b>[PHOTO]</b> button.

## Auto Power Off

You can set your camcorder to turn off automatically if it is idle for 5 minutes without an operation. This function will prevent unnecessary power consumption.

- 1 Press the [MENU] button → [Control (Left/Right)] button → Settings → [Control (Up/Down)] button → Auto Power Off → [Control (OK)] button.
- 2 Select the desired submenu item with the [Control (Up/Down)] button, and then press the [Control (OK)] button.
- 3 Press the [MENU] button to exit the menu.

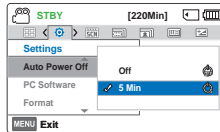
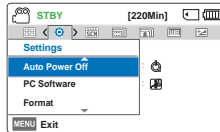

### Submenu Items

Items	Use
Off	To disable the function.
5 Min	The camcorder turns off if idle for 5 minutes without performing an operation.

- Auto Power Off does not work in the following situations:
  - If the power cable (Power adaptor, USB cable) is connected.
  - While the following functions are in operation; **Delete: All Files**, **Protect: All On**.
  - While recording, playing back (except pause), or playing back a photo slide show.
- To operate the camcorder again, press the [Power (⏻)] button.

## PC Software

If you set PC Software to On, you can use the built-in PC software easily by connecting a USB cable between the camcorder and your PC. Using the software, you can download stored video and photo images on the camcorder to your PC's hard disk. You can also edit video and photo files using the PC software.

- 1 Press the [MENU] button → [Control (Left/Right)] button → Settings → [Control (Up/Down)] button → PC Software → [Control (OK)] button.
- 2 Select the desired submenu item with the [Control (Up/Down)] button, and then press the [Control (OK)] button.
- 3 Press the [MENU] button to exit the menu.

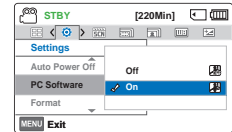
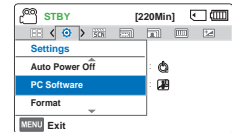

### Submenu Items

Items	Use
Off	To disable the function.
On	To launch the built-in editing software when you connect the camcorder to a PC with a USB cable.

- PC Software is compatible with Windows operating systems only.



## Format

Use the Format function if you want to delete all files completely or to correct problems on the storage media.

 Insert a memory card. [↪ page 30](#)

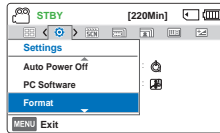
- 1 Press the **[MENU]** button → **[Control (Left/Right)]** button → **Settings** → **[Control (Up/Down)]** button → **Format** → **[Control (OK)]** button.
- 2 Select **Yes** by pressing the **[Control(Left/Right)]** button, and then press the **[Control (OK)]** button.





-  Do not remove the memory card or perform any other operation (such as turning off the power) during formatting. Also, be sure to use the provided power adaptor, as the recording media may be corrupted if the battery becomes exhausted during formatting.
- If the storage media becomes corrupted, format it again.
-  Do not format the storage media on a PC or other device. Make sure to format the storage media on this camcorder.
- Format the memory card in the following cases:
  - Before using a new memory card
  - If the memory card was formatted on other devices
  - If the memory card was used to record on other devices
  - If the camcorder cannot read the memory card
- A memory card with the protection tab set to lock will not be formatted.
- If there is no storage media inserted, it cannot be selected and will be dimmed in the menu.
- You cannot format when the battery power is insufficient. We recommend you use the power adaptor to avoid loss of power while formatting.

## Default Set

You can restore all menu settings to their defaults.

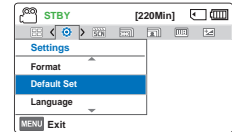
- 1 Press the **[MENU]** button → **[Control (Left/Right)]** button → **Settings** → **[Control (Up/Down)]** button → **Default Set** → **[Control (OK)]** button.
- 2 Select **Yes** if you want all the settings return to the defaults.



-  Do not turn off the power while using this function.
- After resetting the camcorder, reset the **Date/Time Set**. [↪ page 25](#)
- The Default Set function does not affect the files recorded on the storage media.

## Language

You can select a desired language to display the menu and messages in. [↪ page 29](#)

# Connecting to a TV

## CONNECTING TO A HIGH DEFINITION TV WITH HDMI

You can view High Definition (HD) quality videos recorded in HD resolution on an HDTV using an HDMI connection. This camcorder supports HDMI output to deliver high-definition video transfer.

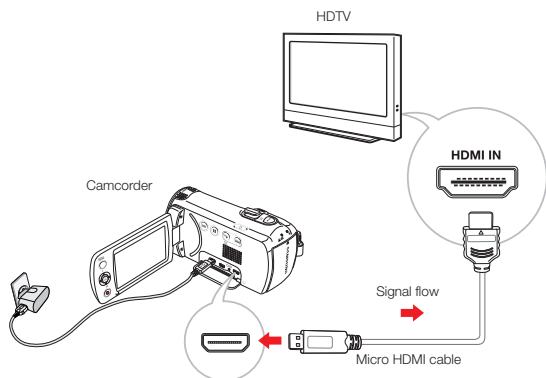

### Using a micro HDMI cable

- 1 Turn on the camcorder.
  - If you do not turn on the camcorder first, the camcorder may fail to recognise the connected TV.
- 2 Connect the camcorder to the TV with a micro HDMI cable.
- 3 Set the TV's input or source selector to the HDMI input you've attached the camcorder to.
  - Refer to the TV's instruction manual to see how to select the TV's input or source.
- 4 Start to play back images. →page 42



### Understanding the HDMI

HDMI (High Definition Multimedia Interface) is a compact audio/video interface for transmitting uncompressed digital data.



- You can use only a D to A type micro HDMI cable with this camcorder.
- The HDMI jack on the camcorder is for output only.
- Use only HDMI 1.3 cable when connecting to the HDMI jack of this camcorder. If the camcorder is connected with HDMI cables that are not version 1.3, the screen display may not work.



## CONNECTING TO A REGULAR TV

You can view images recorded with your camcorder on a regular TV that supports standard definition. This camcorder supports the composite output for standard definition video transfer.

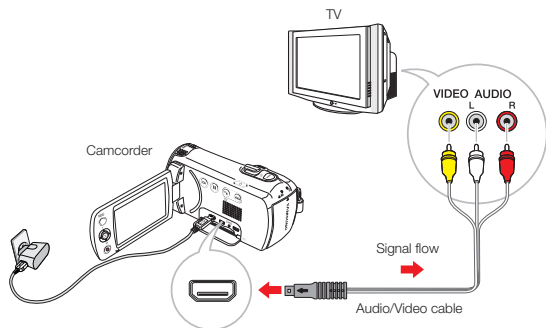

### Connecting an Audio/Video cable for the composite output



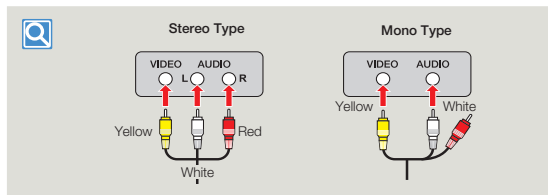

- 1 Connect the camcorder to a TV with an Audio/Video cable.
  - Turn on the camcorder, and then connect an Audio/Video cable. If you do not turn on the camcorder first, the camcorder may fail to recognise the connected TV.
- 2 Set the TV's input or source selector to the input you've attached the camcorder to.
  - Refer to the TV's instruction manual to see how to select the TV input.
- 3 Start to play back images. ➔ page 42



- When you connect the camcorder to a TV, the LCD screen of the camcorder turns off automatically.
- Make sure you've connected the camcorder to the correct input jacks. The TV screen may not display the right image information if connected incorrectly.
- Do not use excessive force when connecting the cables.
- We recommend you use the power adaptor as the power source.
- When connecting to a TV using the Audio/Video cable, match the colour of the cables to the colour of the corresponding jacks.
- Video input may appear green depending on the TV. If this occurs, connect the yellow plug of the Audio/Video cable to the green jack of the TV.
- If your TV has one audio jack (mono input), connect the yellow plug of the Audio/Video cable to the video jack, the white plug to the audio jack, and leave the red plug unconnected.
- When you connect the camcorder to a TV using the Audio/Video cable, images recorded in high definition image quality (1280x720/25p) play back in standard definition image quality.
- When the camcorder is connected to a TV with more than one kind of cable, the camcorder outputs video signals in the following order of priority: HDMI → Audio/Video (composite) output

## VIEWING ON A TV SCREEN

## Image display depending on LCD and TV screen ratio

Recording ratio	Appearance on Wide Screen (16:9) TV	Appearance on 4:3 TV
Images recorded in a 16:9 ratio		
Images recorded in a 4:3 ratio		

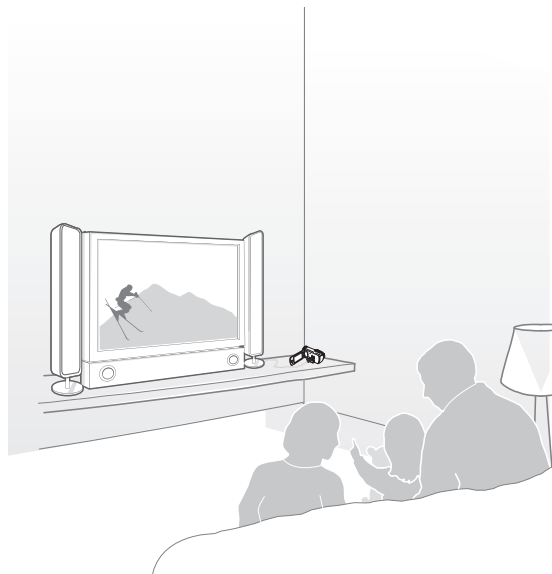

Adjust the volume to a moderate level. If the volume is too high, the video may include the noise.

# Dubbing videos

## DUBBING TO VCR OR DVD/HDD RECORDERS

You can dub images recorded on your camcorder to other recording devices, such as VCRs or DVD/HDD recorders.



- Videos are dubbed to the other recording device via analogue data transfer. (composite connection) Use the supplied Audio/Video cable.
- Use the power adaptor to power the camcorder when you dub to a VCR or DVD/HDD recorder.

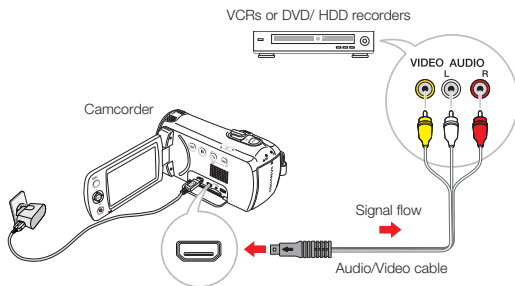

- 1 Insert the storage media in the recording device.
- 2 Connect your camcorder to the recording device (VCR or DVD/ HDD recorders) with the supplied Audio/Video cable.
- 3 Start the playback on your camcorder, and record it on the recording device.
  - Refer to the instruction manuals supplied with your recording device for details.
- 4 When dubbing finishes, stop the recording device, and then your camcorder.



- Videos recorded on this camcorder can only be dubbed using the Audio/Video cable in SD (standard definition) image quality, regardless of the recording resolution (HD/SD).
- To copy a video recorded in HD (high definition) image quality, use the built-in software of your camcorder, and then copy the video to your computer. ↪ page 85
- Since dubbing is performed via analogue data transfer, the image quality may deteriorate.
- To record the date/time, display it on the LCD screen. ↪ page 75

# Using with a windows computer

## WHAT YOU CAN DO WITH A WINDOWS COMPUTER

You can perform the following functions by connecting your camcorder to your Windows computer with a USB cable and using the Intelli-studio editing software built into your camcorder.

### Main Functions

- Intelli-studio editing software's main functions
  - Playing back recorded videos or photos.
  - Editing recorded videos or photos.
  - Uploading the recorded videos and photos to YouTube, Flickr or Facebook, etc.
- You can transfer or copy the files (videos and photos) saved on the storage media into your computer.

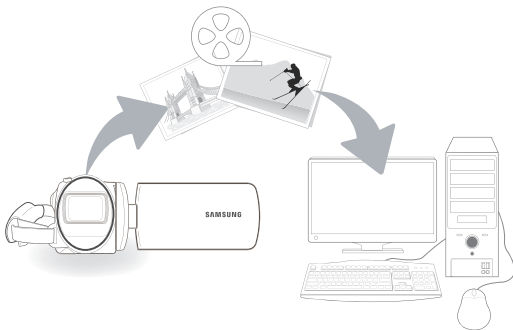

### System Requirements

Your computer must meet the following requirements to run Intelli-studio:

Items	System Requirements
OS	Microsoft Windows XP SP2, Windows Vista, or Windows 7
CPU	Intel® Core 2 Duo® 1.66 GHz or higher is recommended AMD Athlon™ X2 Dual-Core 2.2 GHz or higher is recommended (Notebook: Intel Core2 Duo 2.2GHz or AMD Athlon X2 Dual-Core 2.6GHz or higher is recommended)
RAM	1GB or higher is recommended
Video Card	NVIDIA GeForce 8500 or higher, ATI Radeon HD 2600 series or higher
Display	1024 x 768, 16-bit colour or higher (1280 x 1024, 32-bit colour recommended)
USB	USB 2.0
Direct X	DirectX 9.0c or higher
Recommended Memory Card	6MB/s (Class 6) or above



- System requirements mentioned above are recommendations. Even on a system that satisfies the requirements, Intelli-studio may not operate optimally.
- On a slower than recommended computer, video playback may skip frames or operate unexpectedly.
- If the version of DirectX on your computer is lower than 9.0c, install DirectX 9.0c or higher.
- We recommended you transfer recorded videos to a PC before playing back or editing the videos.
- To run Intelli-studio, a laptop computer requires faster and better components than a desktop PC.
- Intelli-studio is not Mac OS compliant.
- The programmes may not work properly on 64-bit editions of Windows XP, Windows Vista, and Windows 7.

### USING THE Intelli-studio PROGRAMME

Intelli-studio is a built-in programme that allows you to play back and edit files. You can upload files to web sites, such as YouTube or Flickr.

#### Step 1. Connecting the USB cable

- 1 Set **PC Software to On**.
  - This is the default setting.
- 2 Connect the camcorder to a PC with the USB cable.
  - A new file saving window appears along with the Intelli-studio main window. If your camcorder has no new files, the pop-up window for saving new files will not appear.
  - Depending on your version of Windows, the Windows removable disk window may also appear.

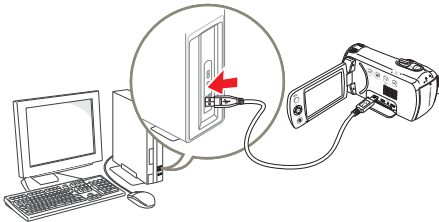

- 3 Click **Yes** in the new file saving window. The uploading procedure starts. Click **Yes** to confirm.
  - If you do not want to save any new files, select **No**.

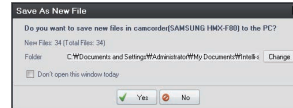

#### To disconnect the USB cable

To disconnect the USB cable after completing the file transfer, you must follow these steps:



1. Click the **Safely Remove Hardware** icon on the taskbar.
2. Select **USB Mass Storage Device**, and then click **Stop**.
3. If the **Stop a Hardware device** window appears, click **OK**.
4. Disconnect the USB cable from the camcorder and PC.

- Use the provided USB cable. (Supplied by Samsung)
- Make sure you insert the USB plug into the USB jack with the plug facing in the correct direction.
- When the USB cable is connected, turning the camcorder on or off may cause the PC to malfunction.
- If you disconnect the USB cable from the PC or the camcorder while transferring files, the data transmission will stop and the data may be damaged.
- If you connect the camcorder to a PC via a USB HUB or simultaneously connect the camcorder along with other USB devices, the camcorder may not work properly. If this occurs, remove all USB devices from the PC, and then reconnect the camcorder.
- Intelli-studio may not automatically run. If this occurs, access My Computer or Windows Explorer, open the drive that corresponds to your camcorder, find Intelli-studio, and then run iStudio.exe.

## Step 2. About the Intelli-studio main window

When the Intelli-studio starts up, video and photo thumbnails appear in the main window.

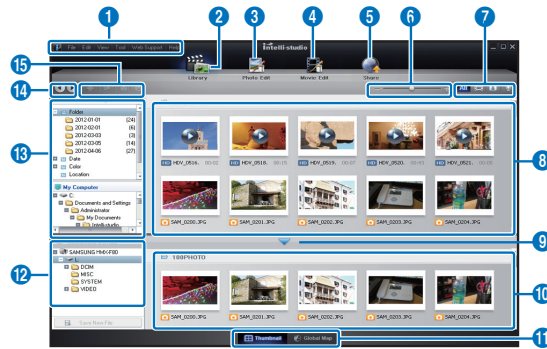

- If you install Intelli-studio on your PC, the programme will launch more quickly. To install the programme, select **Tool → Install Intelli-studio on PC**.
- You can update the latest version of Intelli-studio software by clicking on **Web Support → Update Intelli-studio → Start Update**.
- You can update the firmware of this camcorder by selecting **Web Support → Upgrade firmware for the connected device** from the programme toolbar.
- The camcorder's built-in Intelli-studio software is intended for home use. It is not for precision or industrial productions. For these applications, we recommend an editing software designed for professional use.



For details, select **Help → Help** on the Intelli-studio screen.

No.	Description
1	Menu items
2	Display files in the selected folder.
3	Switch to Photo edit mode.
4	Switch to Video edit mode.
5	Switch to Share mode.
6	Enlarge or reduce the thumbnails in the list.
7	Select a file type.
8	View videos and photos of the selected folder on your computer.
9	Show or hide videos and photos of the connected device.
10	View videos and photos of the selected folder on the device.
11	View files as thumbnails or on a map
12	Browse folders in the connected device.
13	Browse folders stored on your computer
14	Move to the previous or next folder
15	Print files, view files on a map, store files in Contents Manager, or register faces.

### Step 3. Playing back videos or photos

You can play back the recordings conveniently using the Intelli-studio application.

- 1 With Intelli-studio, click the desired folder to display your recordings.
  - Video or photo thumbnails appear on the screen, depending on the folder you selected.
- 2 Choose the video or photo that you want to play back.
  - You can view the file information by moving the mouse over the file.
  - If you click a video thumbnail once, the video plays back inside the thumbnail frame, allowing you to search for a desired scene with ease.
- 3 After you select the video or photo you want, double-click to play back.
  - Playback starts and the controls appear.

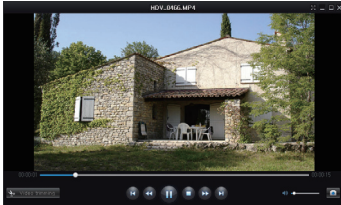

Intelli-studio supports the following file formats:  
- Video formats: MP4 (Video: H.264, Audio: AAC), WMV (WMV 7/8/9)  
- Photo formats: JPG, GIF, BMP, PNG, TIFF

### Step 4. Editing videos or photos

You can edit the videos or photos in various ways with various functions. (Change Size, Fine-Tuning, Image Effect, Insert Frame, etc.) Before editing a video or photo in Intelli-studio, make a backup copy of the video or photo file and store it on your computer for safe-keeping using My Computer or Windows Explorer.

- 1 Choose the videos or photos you want to edit.
- 2 Click **Movie Edit** (🎬) or **Photo Edit** (🖼️) according to the selected file on the Intelli-studio browser.
  - The selected file appears in the editing window.
- 3 Edit a video or photo with various edit functions.

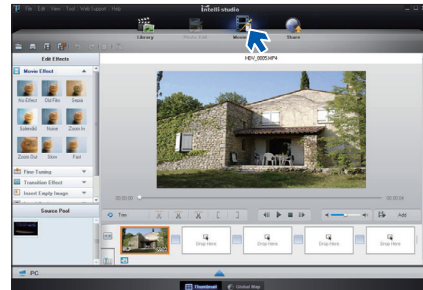

### Step 5. Sharing the videos/photos online

Share your contents with the world by uploading photos and videos directly to a web site with one click.

- 1 Choose the videos or photos you want to share.
- 2 Click **Share** (  ) on the Intelli-studio browser.
  - The selected file appears in the sharing window.

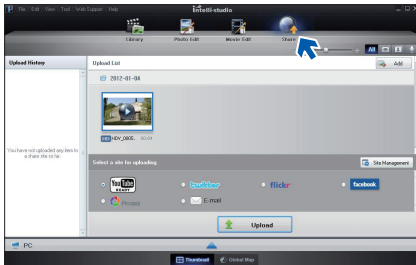

- 3 Click the web site you would like to upload files to.
  - You can choose **YouTube, twitter, Flickr, Facebook, Picasa, Email**, or another web site you want to use for your site management.

- 4 Click **Upload** to start uploading.
  - A pop-up window appears to open the web browser of the selected site or a pop-up window appears asking for your ID and password.

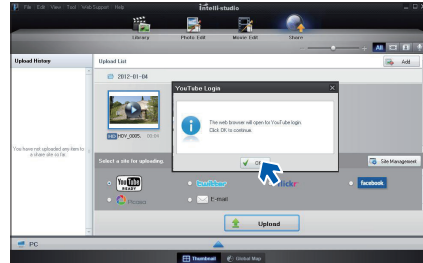

- 5 Enter your ID and the password to access.
  - Access to the web site contents can be limited depending on your web access environment.



The allowed total recording time for individual videos and the capacity available for uploading videos can differ, depending on each web site's policy.



## USING AS A REMOVABLE STORAGE DEVICE

You can transfer recorded data to a Windows computer by connecting the USB cable to the camcorder.

### Viewing and transferring the contents of storage media

- 1 Set **PC Software to Off**.  
↳ page 78
- 2 Insert a memory card.  
↳ page 30
- 3 Connect the camcorder to the PC with the USB cable.  
↳ page 85
  - The **Removable Disk** or **Samsung** window appears on the PC's screen after a moment.
  - Select **Open folders to view files using Windows Explorer** and then click **OK**.

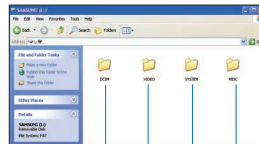
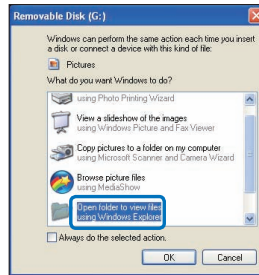

Photos Videos  
System folder  
Setting folder

- 4 The folders in the storage media appear.
  - Different file types are stored in different folders.
- 5 Copy and paste or drag and drop the files from the storage media to your PC.



- If the **Removable Disk** window does not appear, confirm the connection (↳ page 85) or repeat steps 1 through 3 again. When the removable disk does not appear automatically, open the removable disk folder of My Computer.
- If the connected camcorder's disk drive does not open or the context menu that appears when right-clicking your mouse (open or browse) appears broken, your computer may be infected by an Autorun virus. Be sure to update your antivirus software to the latest version.

### Structure of folders and files on the storage media

- The folder and file structure for the storage media is as follows.
- Do not arbitrarily change or remove the folder or file name. It may not be playable.

#### Videos (H.264) ①

- HD-quality videos have an HDV\_####.MP4 name format.
- SD-quality videos have an SDV\_####.MP4 name format.
- The file number automatically increases when a new video clip file is created.
- Up to 9,999 files can be stored in one folder. A new folder is created when the number files in a folder exceeds 9,999.
- The folder names are given in the following order: 100VIDEO, 101VIDEO, etc. The maximum number of folders is 999.
- The camcorder can create a maximum of 9,999 files in a storage media.

#### Photos ②

- As with video clip files, the file number automatically increases when a new image file is created.
- Photo files have a SAM\_####.JPG format. A new folder stores files starting with SAM\_0001.JPG.
- Folder names increase in this order: 100PHOTO→101PHOTO etc.

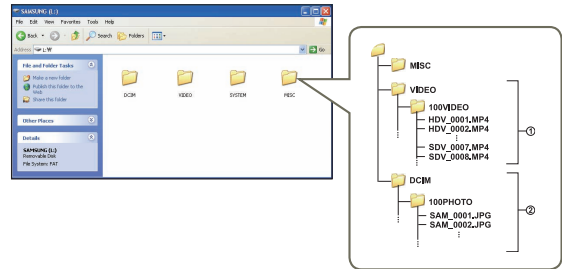

### File format

#### Video files

- Videos are compressed in H.264 format. The file extension is '.MP4'.
- Refer to page 53 for video resolution.

#### Photo files

- Photos are compressed in JPEG (Joint Photographic Experts Group) format. The file extension is '.JPG'.
- Refer to page 54 for photo resolution.



Do not modify the name of a movie file recorded by the camcorder. For proper playback, the camcorder requires the original folder and file name.

# Troubleshooting





## WARNING INDICATORS AND MESSAGES

Before contacting a Samsung authorised service centre, perform the following simple checks. They may save you the time and expense of an unnecessary call.



### Power source

Message	Icon	Informs that...	Action
<b>Low Battery</b>	-	The battery is almost discharged.	<ul style="list-style-type: none"><li>• Replace with a charged battery or use the power adaptor.</li><li>• Charge the battery.</li></ul>
<b>Check authenticity of the battery.</b>	-	The battery failed to authenticate.	<ul style="list-style-type: none"><li>• Check the battery's authenticity. Change to an authentic and charged Samsung battery.</li><li>• We recommend you use only genuine Samsung batteries in this camcorder.</li></ul>
<b>This is not a rated adaptor. Use only the rated adaptor that we provided.</b>		The power adaptor failed to authenticate.	<ul style="list-style-type: none"><li>• Check the power adaptor's authenticity.</li><li>• We recommend you use only genuine Samsung power adaptors in this camcorder.</li></ul>

### Storage media

Message	Icon	Informs that...	Action
<b>Insert Card</b>		There is no memory card inserted in the memory card slot.	<ul style="list-style-type: none"><li>• Insert a memory card.</li></ul>
<b>Card Full</b>		There is not enough space to record on the memory card.	<ul style="list-style-type: none"><li>• Back-up important files to your PC or another storage media and delete unnecessary files in the memory card.</li></ul>
<b>Card Error</b>		The memory card has some problem and cannot be recognised.	<ul style="list-style-type: none"><li>• Format the memory card or replace it with a new one.</li></ul>
<b>Card Locked</b>		The write protection tab on the memory card has been set to lock.	<ul style="list-style-type: none"><li>• Release the write protection tab.</li></ul>

## Storage media

Message	Icon	Informs that...	Action
Not Supported Card		The memory card is not supported in this camcorder.	<ul style="list-style-type: none"> <li>Change to the memory card that we recommended.</li> </ul>
Please format		The memory card is not formatted.	<ul style="list-style-type: none"> <li>Format the memory card using the menu.</li> </ul>
Low speed card. Please record a lower resolution.	-	The memory card is not fast enough to record at this resolution.	<ul style="list-style-type: none"> <li>Record video at a lower resolution.</li> <li>Change the memory card to a faster one. ↪ page 32</li> </ul>

## Recording

Message	Icon	Informs that...	Action
Write Error	-	Some problems occurred while writing data to storage media.	<ul style="list-style-type: none"> <li>Format storage media using the menu after backing-up important files to your PC or another storage media.</li> </ul>
Release the Smart Auto	-	You cannot operate some functions manually when SMART AUTO is activated.	<ul style="list-style-type: none"> <li>Release the SMART AUTO function.</li> </ul>
The number of video files is full. Cannot record video.	-	The number of video files that can be stored is 9,999.	<ul style="list-style-type: none"> <li>Delete unnecessary files from the storage media.</li> <li>Back up files to your PC or another storage media and delete files.</li> <li>Change to another card which has enough free space.</li> <li>Set <b>File No.</b> to <b>Reset</b>.</li> <li>Format the storage media.</li> </ul>
The number of photo files is full. Cannot take a photo.	-	The number of photo files that can be stored is 9,999.	<ul style="list-style-type: none"> <li>Delete unnecessary files on the storage media.</li> <li>Back up files to your PC or another storage media and delete files.</li> <li>Change to another card which has enough free space.</li> <li>Set <b>File No.</b> to <b>Reset</b>.</li> <li>Format the storage media.</li> </ul>

### Recording

Message	Icon	Informs that...	Action
<b>File number is full. Cannot record video.</b>	-	Folder and file number have reached the maximum number and you cannot record.	<ul style="list-style-type: none"> <li>Set <b>File No.</b> to <b>Reset</b> and format the storage media. Remember to back up important files before formatting.</li> </ul>
<b>File number is full. Cannot take a photo.</b>	-	Folder and file number have reached the maximum number and you cannot record.	<ul style="list-style-type: none"> <li>Set <b>File No.</b> to <b>Reset</b> and format the storage media. Remember to back up important files before formatting.</li> </ul>
<b>Check the lens cover.</b>		Lens cover is closed.	<ul style="list-style-type: none"> <li>Open the lens cover.</li> </ul>

### Playback

Message	Icon	Informs that...	Action
<b>Read Error</b>	-	Some problems occurred when reading data from storage media.	<ul style="list-style-type: none"> <li>Format the storage media using the menu after backing up important files to PC or another storage device.</li> </ul>
<b>Corrupted file</b>	-	This file cannot be read.	<ul style="list-style-type: none"> <li>Format the storage media after backing up important files to a PC or another storage device.</li> </ul>

### SYMPTOMS AND SOLUTIONS

If these instructions do not solve your problem, contact the nearest Samsung authorised service centre.

#### Power

Symptom	Explanation/Solution
The camcorder does not turn on.	<ul style="list-style-type: none"> <li>The battery may not be installed on your camcorder. Insert a battery into the camcorder.</li> <li>The inserted battery may be discharged. Charge the battery or replace it with a charged one.</li> <li>If you use a power adaptor, make sure it is properly connected to the wall outlet.</li> <li>Remove the battery or unplug the power adaptor, and then reconnect the power supply to the camcorder before turning it on.</li> </ul>
The power automatically turns off.	<ul style="list-style-type: none"> <li>If no button is pressed for about 5 minutes, the camcorder is automatically turned off (<b>Auto Power Off</b>). To disable this option, change the setting of <b>Auto Power Off</b> to <b>Off</b>.</li> <li>Use the power adaptor.</li> </ul>
Power cannot be turned off .	<ul style="list-style-type: none"> <li>Remove the battery or unplug the power adaptor, and then reconnect the power supply to the camcorder before turning it on.</li> </ul>
The battery is quickly discharged.	<ul style="list-style-type: none"> <li>The temperature is too low.</li> <li>The battery is not fully charged. Recharge the battery.</li> <li>The battery has reached the end of its lifespan and cannot be recharged. Use another battery.</li> </ul>

#### Displays

Symptom	Explanation/Solution
The TV screen or LCD display has distorted images or has stripes at the top/ bottom or on the left/right.	<ul style="list-style-type: none"> <li>This can occur when recording or viewing a 16:9-ratio image on a 4:3-ratio TV, or vice versa. For more details, see the display specification. ➤page 82</li> </ul>

### Displays

Symptom	Explanation/Solution
Unknown indicator appears on the screen.	<ul style="list-style-type: none"> <li>A warning indicator or message appears on the screen. ↪pages 91-93</li> </ul>
An afterimage remains on the LCD screen.	<ul style="list-style-type: none"> <li>This occurs if you disconnect the power adaptor or remove the battery before turning the power off.</li> </ul>
The image on the LCD screen looks dark.	<ul style="list-style-type: none"> <li>Ambient light is too bright. Adjust the brightness and angle of the LCD.</li> </ul>

### Storage media

Symptom	Explanation/Solution
Memory card functions are not operable.	<ul style="list-style-type: none"> <li>Insert a memory card into your camcorder properly. ↪page 30</li> <li>If you use a memory card formatted on a computer, format it again directly on your camcorder. ↪page 79</li> </ul>
Image cannot be deleted.	<ul style="list-style-type: none"> <li>You cannot delete the images protected by another device. Release the protection of the image on the device. ↪page 72</li> <li>Release the lock on the write-protect tab of the memory card (SDHC memory card, etc.), if any. ↪page 31</li> </ul>
You cannot format the memory card.	<ul style="list-style-type: none"> <li>Release the lock on the write-protect tab of the memory card (SDHC memory card, etc.), if any. ↪page 31</li> <li>The memory card is not supported on your camcorder or the card has some problems.</li> </ul>
The data file name is not indicated correctly.	<ul style="list-style-type: none"> <li>The file may be corrupted.</li> <li>The file format is not supported by your camcorder.</li> <li>Only the file name appears if the directory structure does not comply with the international standard.</li> </ul>
Your computer does not recognise an SDXC memory card.	<ul style="list-style-type: none"> <li>SDXC memory cards use the exFAT file system. To use SDXC memory cards on a Windows XP computer, download and update the exFAT file system driver from the Microsoft website.</li> </ul>
Your TV or computer cannot display photos and videos that are stored on an SDXC memory card.	<ul style="list-style-type: none"> <li>SDXC memory cards use the exFAT file system. Ensure that the external device is compatible with the exFAT file system before connecting the product to the device.</li> </ul>

### Recording

Symptom	Explanation/Solution
<p>Pressing the <b>[Recording start/stop]</b> button does not start recording.</p>	<ul style="list-style-type: none"> <li>• There is not enough free space to record on the storage media.</li> <li>• Make sure the memory card is inserted and write-protect tab is set to unlock.</li> <li>• The internal temperature of your camcorder is unusually high. Turn off your camcorder and leave it for a while in a cool place.</li> <li>• Your camcorder is damp and moist inside (condensation). Turn off your camcorder and leave it for about 1 hour in a cool place.</li> </ul>
<p>The actual recording time is less than the estimated time.</p>	<ul style="list-style-type: none"> <li>• The estimated recording time may vary depending on the contents and the features you used.</li> <li>• Recording a fast-moving subject increases the bit rate and consequently the amount of storage space required for the recording, which can lead to a shorter available recording time.</li> </ul>
<p>The recording stops automatically.</p>	<ul style="list-style-type: none"> <li>• There is no more free space for recording on the storage media. Back up important files to your PC, and then format the storage media or delete the unnecessary files.</li> <li>• If you frequently record or delete files, the performance of the storage media will deteriorate. In this case, reformat the storage media.</li> <li>• If you use a memory card with a low writing speed, the camcorder automatically stops recording the videos and the corresponding message appears on the LCD screen.</li> </ul>
<p>When recording a subject illuminated by bright light, vertical lines appear.</p>	<ul style="list-style-type: none"> <li>• The camcorder is unable to record these levels of brightness.</li> </ul>



### Recording

Symptom	Explanation/Solution
When the screen is exposed to direct sunlight during recording, the screen turns red or black for an instant.	<ul style="list-style-type: none"> <li>Do not expose the LCD screen to direct sunlight.</li> </ul>
During recording, the date/time does not appear.	<ul style="list-style-type: none"> <li>Set <b>Date/Time Display</b> to on. ↪page 75</li> </ul>
The beep sound is not heard.	<ul style="list-style-type: none"> <li>Set the <b>Beep Sound</b> to <b>On</b>.</li> <li>The beep sound is temporarily off while the camcorder records videos.</li> <li>When the Audio/Video cable jack or micro HDMI cable jack is connected to the camcorder, the beep sound will automatically turn off.</li> </ul>
There is a time difference between the point where you press the <b>[Recording start/stop]</b> button and the point where the recorded video starts/stops.	<ul style="list-style-type: none"> <li>On your camcorder, there may be a slight time delay between the point where you press <b>[Recording start/stop]</b> button and the actual point where the recorded video starts/stops. This is not an error.</li> </ul>
You cannot record a photo image.	<ul style="list-style-type: none"> <li>Set your camcorder to the recording mode. ↪page 26</li> <li>Release the lock on the write-protection tab of the memory card if set. ↪page 31</li> <li>The storage media is full. Use a new memory card or format the storage media. ↪page 79 Remove unnecessary images. ↪page 70</li> </ul>

## Adjusting the image during recording

Symptom	Explanation/Solution
Focus does not adjust automatically.	<ul style="list-style-type: none"> <li>• Set <b>Focus</b> to <b>Auto</b>. ➔page 58</li> <li>• The recording conditions are not suitable for auto focus. Adjust the focus manually. ➔page 58</li> <li>• The lens is dusty on the surface. Clear the lens and check the focus.</li> <li>• You are recording in a dark place. Increase the brightness.</li> </ul>
The image appears too bright or flickering, or changes in colour.	<ul style="list-style-type: none"> <li>• This occurs when recording images under a fluorescent lamp, sodium lamp, or mercury lamp. Cancel <b>iSCENE</b> to minimise these phenomena. ➔page 52</li> </ul>

## Playback on your camcorder

Symptom	Explanation/Solution
The video does not play back.	<ul style="list-style-type: none"> <li>• Press the <b>[MODE]</b> button to set the video playback mode.</li> <li>• Image files recorded on another camcorder may not play back on your camcorder.</li> <li>• Check out memory card compatibility. ➔page 31</li> </ul>
The Skip or Search function does not work properly.	<ul style="list-style-type: none"> <li>• If the temperature inside the camcorder is too high, it cannot function properly. Turn the camcorder off, wait for a few moments, and then turn it on again.</li> </ul>
Playback is interrupted unexpectedly.	<ul style="list-style-type: none"> <li>• Check if the power adaptor or battery is properly connected and stable.</li> </ul>
You cannot hear sound when playing back a Time Lapse recording.	<ul style="list-style-type: none"> <li>• The Time Lapse REC function does not record sound.</li> </ul>
Photos stored on a storage media do not appear in the actual size.	<ul style="list-style-type: none"> <li>• Photos recorded on other devices may not appear at actual size. This is not an error.</li> </ul>

## Playback on other devices (TV, etc.)

Symptom	Explanation/Solution
You cannot view the image or hear the sound on the connected device.	<ul style="list-style-type: none"> <li>• Connect the audio line of the Audio/Video cable jack to your camcorder and the connected device (TV, DVD recorder, etc). (Red colour- right, White colour- left)</li> <li>• The Audio/Video cable jack or micro HDMI cable jack is not connected properly. Make sure that the Audio/Video cable jack or micro HDMI cable jack is connected to the proper jack. ➔page 81</li> </ul>
You cannot dub correctly using the HDMI cable.	<ul style="list-style-type: none"> <li>• You cannot dub images using the HDMI cable.</li> </ul>

### Connecting to a computer

Symptom	Explanation/Solution
When accessing videos, a computer does not recognise your camcorder.	<ul style="list-style-type: none"> <li>• Disconnect the USB cable from the computer and camcorder, restart the computer, then reconnect it correctly.</li> </ul>
Cannot play back a video file properly on a PC.	<ul style="list-style-type: none"> <li>• You need to install a video codec on the PC to play back the files recorded by your camcorder. Install or run the internal edit software (Intelli-studio).</li> <li>• Make sure you insert the connector in the correct direction, and connect the USB cable to the USB jack on your camcorder firmly. Disconnect the cable from the computer and camcorder, restart the computer. Reconnect it properly.</li> <li>• Your computer may not have the necessary performance specifications to play back a video file. Check the recommended computer specifications.</li> </ul>
Intelli-studio does not function properly.	<ul style="list-style-type: none"> <li>• Exit the Intelli-studio application, and restart the Windows computer.</li> <li>• Intelli-studio is not Mac OS compliant.</li> <li>• Set <b>PC Software</b> to <b>On</b> in the Settings menu.</li> </ul>
The image or sound of the video file recorded by your camcorder does not play back correctly on your PC.	<ul style="list-style-type: none"> <li>• The image or sound of the video file may stop playing back temporarily depending on the data transfer speed of PC. Copy the video file to your PC and then play it back on the PC.</li> <li>• If you connect the camcorder to your PC that the PC does not support Hi-Speed USB (USB2.0), the image or sound of the video file may not play back correctly. Video files copied to the PC are not affected by it.</li> </ul>
The playback screen is paused or distorted.	<ul style="list-style-type: none"> <li>• Check the system requirements to play back a video. ➔ page 84</li> <li>• Exit all other applications running on the computer.</li> <li>• If you play back the recorded file by connecting the camcorder to your PC, the file may not play back smoothly depending on the data transfer speed of PC.</li> </ul>

## Dubbing with other devices

Symptom	Explanation/Solution
You cannot dub correctly using the Audio/Video cable.	<ul style="list-style-type: none"> <li>The Audio/Video cable is not connected properly. Make sure that the Audio/Video cable is connected to the proper jacks, i.e. to the input jacks of the device used for dubbing an image from your camcorder.  ↳page 83</li> </ul>

## General operations

Symptom	Explanation/Solution
The date and time are incorrect.	<ul style="list-style-type: none"> <li>Has the camcorder been left unused for a long period of time?  The backup internal rechargeable battery may be discharged. ↳page 25</li> </ul>
Pressing a button will not turn on or operate the computer.	<ul style="list-style-type: none"> <li>Remove the battery or unplug the power adaptor, and then reconnect the power supply to the camcorder before turning it on.</li> </ul>

## Menu items that cannot be used at the same time

Symptom	Explanation/Solution						
Menu items are greyed out.	<ul style="list-style-type: none"> <li>You cannot select greyed items if items in the menu displays grey. If you have not inserted a memory card in the camcorder, all functions that require a memory card (<b>Storage Info</b>, <b>Format</b>, etc.) are dimmed in the menu and you cannot select them. Insert a memory to set the functions.</li> </ul>						
	<table border="1"> <thead> <tr> <th>Cannot use</th> <th>Because of the following settings</th> </tr> </thead> <tbody> <tr> <td> <b>Anti-Shake(HDIS)</b>  <b>Face Detection</b>  <b>Back light</b> </td> <td> <b>Digital Special Effect</b> </td> </tr> <tr> <td> <b>C.Nite, Intelli Zoom</b> </td> <td> <b>Video Resolution : 1280x720/25p</b> </td> </tr> </tbody> </table>	Cannot use	Because of the following settings	<b>Anti-Shake(HDIS)</b> <b>Face Detection</b> <b>Back light</b>	<b>Digital Special Effect</b>	<b>C.Nite, Intelli Zoom</b>	<b>Video Resolution : 1280x720/25p</b>
	Cannot use	Because of the following settings					
	<b>Anti-Shake(HDIS)</b> <b>Face Detection</b> <b>Back light</b>	<b>Digital Special Effect</b>					
<b>C.Nite, Intelli Zoom</b>	<b>Video Resolution : 1280x720/25p</b>						

# Maintenance & additional information

## MAINTENANCE

### Cautions when storing

- For safekeeping of the camcorder, turn off the camcorder.
  - Remove the battery and power adaptor.
  - Remove the memory card.

### Cleaning the camcorder

Before cleaning, turn off the camcorder and remove the battery and power adaptor.

- **To clean the exterior**
  - Wipe gently with a soft dry cloth. Do not apply excessive force when cleaning. Gently rub the surface.
  - Do not use benzene or thinner to clean the camcorder. The exterior coating could peel off or the case could deteriorate.
- **To clean the LCD screen**

Wipe very gently with a soft dry cloth. Be careful not to damage the screen.

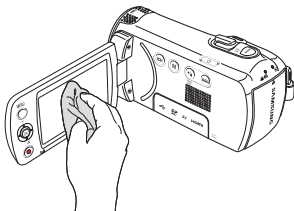

- **To clean the lens**

Use a air brush to remove dust, and then wipe the lens gently with a soft cloth.  
If necessary, wipe gently with lens paper or tissue.

  - Mould may form if the lens is left dirty.
  - If the lens looks dim, turn off the camcorder and leave it off for about 1 hour.

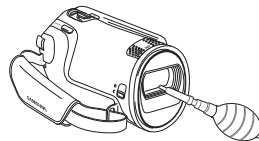

### LCD screen

- **To prolong its service life, do not rub the LCD screen with a coarse cloth.**
- **Be aware of the following LCD screen phenomena. They are not malfunctions.**
  - When you use the camcorder, the surface around the LCD screen may heat up.
  - If you leave the power on for a long time, the surface around the LCD screen becomes hot.
  - When using the camcorder in cold conditions, an afterimage may appear on the LCD screen.
- An LCD screen is manufactured using advanced technology which creates screens with pixel failure rates of less than 0.01%. However, a black or bright spot (red, blue, white) may appear in the centre of the LCD screen and up to two spots may appear outside the centre. These spots, which are normally incurred during the manufacturing process, do not affect the recorded images.



When there is dew condensation, put the camcorder aside for a while before using

- What is dew condensation?  
Dew condensation happens when a camcorder is moved to a location where there is a significant temperature difference from the previous location. The dew condenses on the external or internal parts of the camcorder, and on the reflection lens. If there is dew on or in your camcorder, it may cause the camcorder to malfunction or damage the camcorder when you turn the power on.
- Exactly when does dew condensation occur?  
When you move the camera to a location with a higher temperature than the previous location, or when you move it to a hot area suddenly. Examples:
  - You record outside in cold weather during the winter and then move the camera in indoors.
  - You record outside in hot weather after being indoors or inside a car where the A/C was running.
- What can I do?
  - Turn the power off, detach the battery, and leave the camcorder in a dry area for 1~2 hours before using it.



- Use the camcorder only after dew condensation has completely disappeared.
- Be sure to use the recommended accessories supplied with the camcorder. For service, contact your nearest Samsung authorised service centre.

## USING YOUR CAMCORDER ABROAD

- Each country or region has its own electric and colour systems.
- Before using your camcorder abroad, check the following items.

### Power sources

The power adaptor provided lets you power, recharge, and use your camcorder in any country/region that has the power in the 100 V to 240 V, 50/60 Hz range. You may need a commercially available AC plug adaptor depending on the design of local wall outlets.

### On TV colour systems

Your camcorder is a PAL based camcorder. If you want to view your recordings on a TV or copy them to an external device, it must be a PAL based TV or external device and have the appropriate Audio/Video jacks. Otherwise, you may need to use a separate video format transcoder (For example, a PAL to NTSC format converter).



The format transcoder is not provided by Samsung.

### PAL-compatible countries/regions

Australia, Austria, Belgium, Bulgaria, China, CIS, Czech Republic, Denmark, Egypt, Finland, France, Germany, Greece, Great Britain, Holland, Hong Kong, Hungary, India, Iran, Iraq, Kuwait, Libya, Malaysia, Mauritius, Norway, Romania, Saudi Arabia, Singapore, Slovak Republic, Spain, Sweden, Switzerland, Syria, Thailand, Tunisia, etc.

### NTSC-compatible countries/regions

Bahamas, Canada, Central America, Japan, Korea, Mexico, Philippines, Taiwan, United States of America, etc.



You can make recordings with your camcorder and view pictures on the LCD screen anywhere in the world.

### GLOSSARY

#### AF (Auto Focus)

A system that automatically focuses the camcorder lens on the subject. Your camcorder uses the contrast to focus automatically.

#### Aperture

The aperture controls the amount of light that reaches the camcorder's sensor.

#### Camcorder shake (Blur)

If the camcorder is moved while the shutter is open, the entire image may appear blurred. This occurs more often when the shutter speed is slow. Prevent camcorder shake by raising the sensitivity, using a faster shutter speed. Alternately, use a tripod, the DIS or OIS function to stabilise the camcorder.

#### Composition

Composition in photography means arranging objects in a photo. Usually, abiding by the rule of thirds leads to a good composition.

#### Complementary Metal-Oxide-Semiconductor (CMOS)

CMOS is an image sensor producing images approaching the quality of CCD (charge coupled device) sensors. It consumes less power, meaning a longer battery life on your camcorder.

#### Digital zoom

A feature that artificially increases the amount of zoom available with zoom lens (Optical zoom). When using the Digital zoom, the image quality will deteriorate as the magnification increases.

#### Effective Pixel Count

Unlike the total pixel count, this is the actual number of pixels used to capture an image.

#### EV (Exposure Value)

All the combinations of the camcorder's shutter speed and lens aperture that result in the same exposure.

#### Exposure

The amount of light allowed to reach the camcorder's sensor. Exposure is controlled by a combination of the shutter speed, the aperture value, and ISO sensitivity.

#### Focal length (f)

The distance from the middle of the lens to its focal point (in millimeters). Longer focal lengths result in narrower angles of view and the subject is magnified. Shorter focal lengths result in wider angles of view.

#### F. No (F-Number)

The F-number defines the brightness of lens. Smaller number lens has generally brighter image. The F-number is directly proportional to the focal length and inversely proportional to the lens diameter.

\*F.No=focal length/diameter of lens aperture

#### MPEG-4 AVC/H.264

MPEG-4 AVC/H.264 defines the latest video coding format standardised by the ISO/IEC and the ITU-T, in 2003. Compared with the conventional MPEG-2 format, MPEG-4 AVC/H.264 has more than twice the efficiency. Your camcorder employs MPEG-4 AVC/H.264 to encode high definition videos.

#### Optical zoom

This is a general zoom which can enlarge images with a lens and does not deteriorate quality of images.

#### Quality

An expression of the rate of compression used in a digital image. Higher quality images have a lower rate of compression, which usually results in a larger file size.

#### Resolution

The number of pixels present in a digital image. High resolution images contain more pixels and typically show more detail than low resolution images.

#### Shutter speed

Shutter speed refers to the amount of time it takes to open and close the shutter, and it is an important factor in the brightness of a photo, as it controls the amount of light which pass through the aperture before it reaches the image sensor. A fast shutter speed allows less time to let light in and the photo becomes darker and more easily freezes subjects in motion.

#### White balance (colour balance)

An adjustment of the intensities of colours (typically the primary colours red, green, and blue), in an image. The goal of adjusting the white balance, or colour balance, is to correctly render the colours in an image.

# Specifications

<b>Model name</b>	HMX-F80BP/HMX-F80SP/HMX-F800BP/HMX-F800SP	
<b>System</b>	Video signal	PAL
	Picture compression format	H.264/AVC
	Audio compression format	AAC (Advanced Audio Coding)
	Image device	1/3.2" CMOS
	Effective pixels	Approx. 920,000 pixels
	Total pixels	Approx. 5 Mega pixels
	Lens	2.0 to 4.9, 52x (Optical), 65x (Intelli), 130x (Digital) Electronic zoom lens
	Focal length	2.1mm~109.2mm
<b>LCD screen</b>	Size/dot number	2.7 inches wide, 230k
	LCD screen method	TFT active matrix system
<b>Connectors</b>	Composite video out	1.0V (p_p), 75Ω, analogue
	Audio output	-7.5dBm 47KΩ, analogue, stereo
	HDMI output	D type connector (Micro HDMI)
	USB output	mini USB-B type (USB2.0 High Speed)
<b>General</b>	Power source	5.0V (Using the power adaptor), 3.7V (Using Lithium Ion battery)
	Power source type	Power supply (100V~240V) 50/60Hz, Lithium Ion battery
	Power consumption	2.4W ( LCD on)
	Operating temperature	0°C~40°C (32°F~104°F)
	Operating humidity	10% ~80%
	Storage temperature	-20°C~60°C (-4°F~140°F)
	Dimensions (W x H x D)	Approx. 53.9mm×56.4mm×119.0mm (2.05"×2.3"×4.43")
	Weight	Approx. 220g (0.485lb) (without battery and memory card)
Internal MIC	Omni-directional stereo microphone	

※ These technical specifications and design may be changed without notice.



# Contact SAMSUNG WORLD WIDE

If you have any questions or comments relating to Samsung camcorders, please contact the SAMSUNG customer care centre.

Region	Country	Contact Centre ☎	Web Site
North America	CANADA	1-800-SAMSUNG(726-7864)	www.samsung.com
	MEXICO	01-800-SAMSUNG(726-7864)	www.samsung.com
	U.S.A	1-800-SAMSUNG(726-7864)	www.samsung.com
Latin America	ARGENTINE	0800-333-3733	www.samsung.com
	BRAZIL	0800-124-421, 4004-0000	www.samsung.com
	CHILE	800-SAMSUNG(726-7864) From mobile 02-482 82 00	www.samsung.com
	BOLIVIA	800-10-7260	www.samsung.com
	COLOMBIA	01-8000112112	www.samsung.com
	COSTA RICA	0-800-507-7267	www.samsung.com
	DOMINICA	1-800-751-2676	www.samsung.com
	ECUADOR	1-800-10-7267	www.samsung.com
	EL SALVADOR	800-6225	www.samsung.com
	GUATEMALA	1-800-299-0013	www.samsung.com
	HONDURAS	800-27919267	www.samsung.com
	JAMAICA	1-800-234-7267	www.samsung.com
	NICARAGUA	00-1800-5077267	www.samsung.com
	PANAMA	800-7267	www.samsung.com
	PERU	0-800-777-08	www.samsung.com
	PUERTO RICO	1-800-682-3180	www.samsung.com
	TRINIDAD & TOBAGO	1-800-SAMSUNG(726-7864)	www.samsung.com
	VENEZUELA	0-800-100-5303	www.samsung.com
Europe	ALBANIA	42 27 5755	www.samsung.com
	AUSTRIA	0810 - SAMSUNG (7267864, € 0.07/min)	www.samsung.com www.samsung.com/be (Dutch) www.samsung.com/be_fr (French)
	BELGIUM	02-201-24-18	

Region	Country	Contact Centre ☎	Web Site
Europe	BOSNIA	05 133 1999	www.samsung.com
	BULGARIA	07001 33 11	www.samsung.com
	CROATIA	062 SAMSUNG(062 726 7864)	www.samsung.com
	CZECH	800 - SAMSUNG(800-726786)	www.samsung.com
	DENMARK	70 70 19 70	www.samsung.com
	FINLAND	030 - 6227 515	www.samsung.com
	FRANCE	01 48 63 00 00	www.samsung.com
	GERMANY	01805 - SAMSUNG (726-7864 € 0,14/Min)	www.samsung.com
	CYPRUS	8009 4000 only from landline	www.samsung.com
	GREECE	80111-SAMSUNG (80111 726 7864) only from land line (+30) 210 6897691 from mobile and land line	www.samsung.com
	HUNGARY	06-80-SAMSUNG(726-7864)	www.samsung.com
	ITALIA	800-SAMSUNG(726-7864)	www.samsung.com
	KOSOVO	+381 0113216899	www.samsung.com
	LUXEMBURG	261 03 710	www.samsung.com
	MACEDONIA	023 207 777	www.samsung.com
	MONTENEGRO	020 405 888	www.samsung.com
	NETHERLANDS	0900-SAMSUNG (0900-7267864) (€ 0,10/Min)	www.samsung.com
	NORWAY	815-56 480	www.samsung.com
	POLAND	0 801-1SAMSUNG(172-678) +48 22 607-93-33	www.samsung.com
	PORTUGAL	808 20-SAMSUNG (808 20 7267)	www.samsung.com
	RUMANIA	08010 SAMSUNG (08010 726 7864) only from landline (+40) 21 206 01 10 from mobile and land line	www.samsung.com

Region	Country	Contact Centre ☎	Web Site
Europe	SERBIA	0700 Samsung (0700 726 7864)	www.samsung.com
	SLOVAKIA	0800 - SAMSUNG(0800-726 786)	www.samsung.com/sk
	SPAIN	902 - 1 - SAMSUNG (902 172 678)	www.samsung.com
	SWEDEN	0771 726 7864 (SAMSUNG)	www.samsung.com
	Switzerland	0848 - SAMSUNG(7267864, CHF 0.08/min)	www.samsung.com/ch www.samsung.com/ch_fr/ (French)
	U.K	0330 SAMSUNG (7267864)	www.samsung.com
	EIRE	0818 717100	www.samsung.com
	LITHUANIA	8-800-77777	www.samsung.com
	LATVIA	8000-7267	www.samsung.com
	ESTONIA	800-7267	www.samsung.com
CIS	RUSSIA	8-800-555-55-55	www.samsung.com
	GEORGIA	8-800-555-555	www.samsung.com
	ARMENIA	0-800-05-555	www.samsung.com
	AZERBAIJAN	088-55-55-555	www.samsung.com
	KAZAKHSTAN	8-10-800-500-55-500(GSM: 7799)	www.samsung.com
	UZBEKISTAN	8-10-800-500-55-500	www.samsung.com
	KYRGYZSTAN	00-800-500-55-500	www.samsung.com
	TADJIKISTAN	8-10-800-500-55-500	www.samsung.com
	UKRAINE	0-800-502-000	www.samsung.ua www.samsung.com/ua_ru
	BELARUS	810-800-500-55-500	www.samsung.com
MOLDOVA	00-800-500-55-500	www.samsung.com	
Asia Pacific	AUSTRALIA	1300 362 603	www.samsung.com
	NEW ZEALAND	0800 SAMSUNG (0800 726 786)	www.samsung.com
	CHINA	400-810-5858	www.samsung.com
	HONG KONG	(852) 3698-4698	www.samsung.com/hk www.samsung.com/hk_en/
	INDIA	1800 1100 11, 3030 8282, 1800 3000 8282 1800 266 8282	www.samsung.com
	INDONESIA	0800-112-8888, 021-5699-7777	www.samsung.com

Region	Country	Contact Centre ☎	Web Site	
Asia Pacific	JAPAN	0120-327-527	www.samsung.com	
	MALAYSIA	1800-88-9999	www.samsung.com	
	PHILIPPINES	1-800-10-SAMSUNG(726-7864) for PLDT 1-800-3-SAMSUNG(726-7864) for Digitel 1-800-8-SAMSUNG(726-7864) for Globe 02-5805777	www.samsung.com	
	SINGAPORE	1800-SAMSUNG(726-7864)	www.samsung.com	
	THAILAND	1800-29-3232, 02-689-3232	www.samsung.com	
	TAIWAN	0800-329-999 0266-026-066	www.samsung.com	
	VIETNAM	1 800 588 889	www.samsung.com	
	Middle East	U.A.E	800-SAMSUNG (726-7864)	www.samsung.com
		OMAN	800-SAMSUNG(726-7864)	www.samsung.com
		KUWAIT	183-2255	www.samsung.com
BAHRAIN		8000-4726	www.samsung.com	
Egypt		08000-726786	www.samsung.com	
JORDAN		800-22273	www.samsung.com	
IRAN		021-8255	www.samsung.com	
Morocco		080 100 2255	www.samsung.com	
Saudi Arabia		9200-21230	www.samsung.com	
Turkey		444 77 11	www.samsung.com	
Africa	NIGERIA	0800-726-7864	www.samsung.com	
	Ghana	0800-10077 0302-200077	www.samsung.com	
	Cote D' Ivoire	8000 0077	www.samsung.com	
	Senegal	800-00-0077	www.samsung.com	
	Cameroon	7095- 0077	www.samsung.com	
	KENYA	0800 724 000	www.samsung.com	
	UGANDA	0800 300 300	www.samsung.com	
	TANZANIA	0685 88 99 00	www.samsung.com	
	SOUTH AFRICA	0860-SAMSUNG(726-7864)	www.samsung.com	



### **Correct disposal of batteries in this product**

(Applicable in the European Union and other European countries with separate battery return systems)

This marking on the battery, manual or packaging indicates that the batteries in this product should not be disposed of with other household waste at the end of their working life. Where marked, the chemical symbols Hg, Cd or Pb indicate that the battery contains mercury, cadmium or lead above the reference levels in EC Directive 2006/66. If batteries are not properly disposed of, these substances can cause harm to human health or the environment.

To protect natural resources and to promote material reuse, please separate batteries from other types of waste and recycle them through your local, free battery return system.



### **Correct Disposal of This Product (Waste Electrical & Electronic Equipment)**

(Applicable in the European Union and other European countries with separate collection systems)

This marking on the product, accessories or literature indicates that the product and its electronic accessories (e.g. charger, headset, USB cable) should not be disposed of with other household waste at the end of their working life. To prevent possible harm to the environment or human health from uncontrolled waste disposal, please separate these items from other types of waste and recycle them responsibly to promote the sustainable reuse of material resources.

Household users should contact either the retailer where they purchased this product, or their local government office, for details of where and how they can take these items for environmentally safe recycling. Business users should contact their supplier and check the terms and conditions of the purchase contract. This product and its electronic accessories should not be mixed with other commercial wastes for disposal.



### **RoHS compliant**

Our product complies with “The Restriction Of the use of certain Hazardous Substances in electrical and electronic equipment”, and we do not use the 6 hazardous materials- Cadmium (Cd), Lead (Pb), Mercury (Hg), Hexavalent Chromium (Cr +6), Poly Brominated Biphenyls (PBBs), Poly Brominated Diphenyl Ethers (PBDEs)- in our products.

## Free Manuals Download Website

<http://myh66.com>

<http://usermanuals.us>

<http://www.somanuals.com>

<http://www.4manuals.cc>

<http://www.manual-lib.com>

<http://www.404manual.com>

<http://www.luxmanual.com>

<http://aubethermostatmanual.com>

Golf course search by state

<http://golfingnear.com>

Email search by domain

<http://emailbydomain.com>

Auto manuals search

<http://auto.somanuals.com>

TV manuals search

<http://tv.somanuals.com>