

ENGLISH

Video Camcorder

8mm
COLOUR LCD

VP-L800U/L800/L850/L850D/L870

8 VP-L800U

Hi 8 VP-L800/L850/L850D/L870

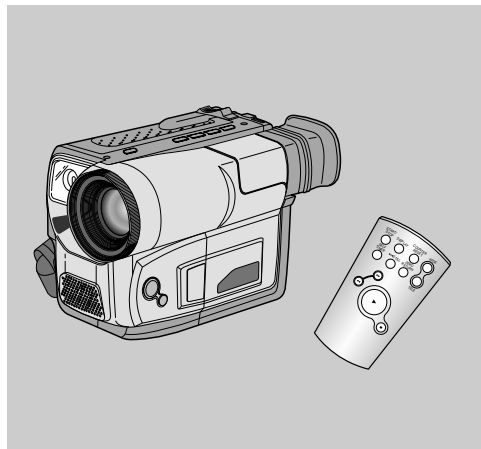

Owner's Instruction Book

Before operating the unit, please read this instruction book thoroughly, and retain it for future reference.



ELECTRONICS



This product meets the intent of
Directive 89/336 CEE, 73/23 CEE, 93/68 CEE.

GB

Table of Contents

Precautions and Safety Instructions

Getting to Know Your Camcorder

Features	8
Descriptions	
■ Front View/Side View/Rear View	9, 10, 11
■ OSD (On Screen Display)	12
Accessories Supplied with Camcorder	14
Remote Control (VP-L850/L850D/L870 only)	15
■ Self Recording with the Remote Control	15

Preparing

Adjusting the Hand Strap and Shoulder Strap	16
Lithium Battery Installation	17
Connecting the Power Source	18
■ To use the AC Power Adapter	18
■ To use the Battery Pack	19
Using the Battery Pack	20
■ The time table of Continuous Recording time	20
■ Display of Battery Level	21
Inserting and Ejecting a Cassette	22

Basic Shooting

Making your first recording	23
Tips for Stable recording	25
■ Recording with the LCD display	25
■ Recording with the Viewfinder	25
Adjusting the LCD	26
Adjusting Focus of the VIEWFINDER	27
Playing back the tape on the LCD	28
■ Adjusting the LCD during PLAY	29
■ Controlling the Sound from the Speaker	29
■ Viewing a Still Picture	29
■ Picture Search	29

Advanced Shooting

Zooming In and Out	30
Digital Zoom	31
EASY mode (for beginners)	33
CUSTOM-Creating your own customized recording settings	34
DIS (Digital Image Stabilizer, VP-L850/L850D/L870 only)	35
MF/AF (Manual Focus/Auto Focus)	36

Table of Contents (continued)

BLC (Back light compensation).....	37
Program AE (Automatic Exposure).....	38
DSE (Digital Special Effects) in CAMERA mode.....	40
Setting and Recording DATE/TIME.....	42
Selecting and Recording a Title.....	44
Fade In and Out.....	46
PIP (VP-L850/L850D/L870).....	47
Snap Shot (VP-L850/L850D/L870).....	48
White Balance.....	49
Demonstration.....	50
Setting the Date/Title Colour.....	51
Lighting Techniques.....	52
Playing back the Tape	
Viewing on the LCD.....	53
Viewing on a TV monitor.....	53
Various Functions in PLAYER mode.....	55
Adjusting the LCD.....	56
Setting the Speaker ON/OFF.....	56
DSE in PLAYER mode.....	57
Maintenance	
Cleaning and caring for your Camcorder.....	57
■ Cleaning the Viewfinder.....	57
■ Cleaning the LCD Panel.....	57
■ Cleaning the Video Heads.....	58
■ Storing the Camcorder.....	58
USB interface (VP-L870 only)	
Installing USB Media 2.0 Program.....	60
Using Your Camcorder Abroad	
63	
Troubleshooting Check	
Self Diagnosis Display.....	64
Checking.....	65
Moisture Condensation.....	67
Specifications	
68	
Index	
69	
Power Sources(United Kingdom Only)	
71	

Precautions and Safety Instructions

Precautions regarding rotation of LCD screen

Please rotate the LCD screen carefully as illustrated. Over rotation may cause damage to the inside of the hinge that connects the LCD screen to the Camcorder.

- 1) LCD screen closed.
- 2) Standard recording by using the LCD screen.
- 3) Making a recording by looking at the LCD screen from the top.
- 4) Making a recording by looking at the LCD screen from the front.
- 5) Making a recording with the LCD screen closed.

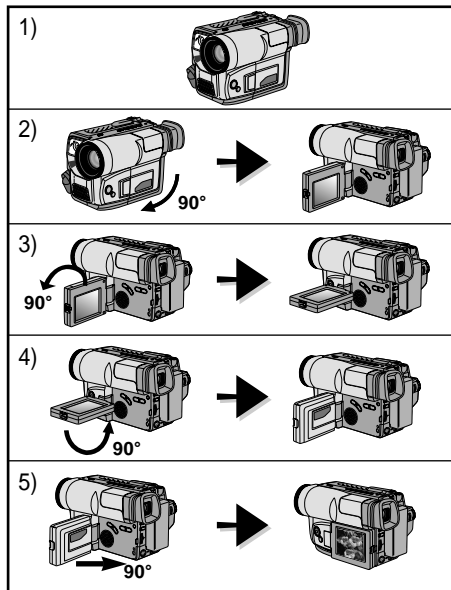

Precautions regarding the LENS

- ☞ Do not point the LENS toward the sun.
Direct sunlight can damage the CCD (Charge Coupled Device).

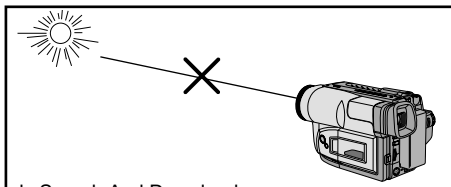

Precautions and Safety Instructions

Precautions regarding the electronic viewfinder

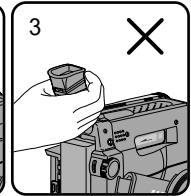
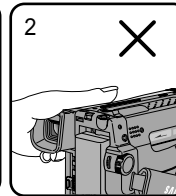
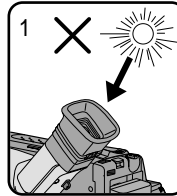

- 1) Do not place the camcorder so that the viewfinder is pointing towards the sun. Direct sunlight can damage the inside of the viewfinder. Be careful when placing the camcorder under sunlight or by a window.
- 2) Do not pick up the camcorder by the viewfinder.
- 3) Over rotation may cause damage to the viewfinder.



Precautions regarding moisture condensation

- 1) A sudden rise in atmospheric temperature may cause condensation to form inside the camcorder.

for example:

- When you take the camcorder from cold temperature outside to warm temperature inside during the winter.
 - When you take the camcorder from cool temperature inside to hot temperature outside during the summer.
- 2) If the “DEW()” protection feature is activated, leave the camcorder in a dry, warm room with the cassette compartment opened and the battery removed.
 - 3) If you want to override the “DEW()” protection feature after it has been unexpectedly activated, detach the battery pack and lithium battery and then replace them. Please make sure that the condensation has disappeared completely. (see page 67)

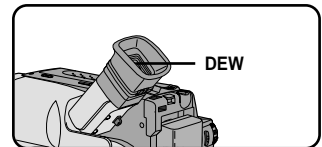

Precautions and Safety Instructions

Precautions regarding the battery pack

- ⌘ Make sure that the battery pack is charged before shooting outdoors.
- ⌘ To preserve battery power, keep your camcorder turned off when you are not operating it.
- ⌘ When your camcorder is in CAMERA mode, if it is left in STANDBY for more than 5 minutes without operation, it will automatically turn off to protect against un-necessary battery discharge.
- ⌘ It is a good idea to use the viewfinder instead of the LCD when shooting for a long time because the LCD uses more battery.
- ⌘ Make sure that the battery pack is fitted firmly into place.
Dropping the battery pack might damage it.
- ⌘ When the battery reaches the end of its life please contact your local dealer
The batteries have to be dealt with as chemical waste.

Precautions regarding the Lithium battery

Warning: Keep the LITHIUM BATTERY out of the reach of children. Should the battery be swallowed, consult a doctor immediately.

- ⌘ The lithium battery maintains the clock function, TITLE, CUSTOM function and preset contents memory; even if the battery pack or AC power adapter is removed.
- ⌘ The lithium battery for the camcorder lasts about 8~10 months under normal operation from time of installation.
- ⌘ When the lithium battery becomes weak or dead, the date/time indicator will flash for about five seconds when you set the power switch to CAMERA. In this case, replace the lithium battery with CR2025 type. (see page 17)

WARNING:

LITHIUM BATTERY MUST BE
RECYCLED OR DISPOSED
OF PROPERLY.



*When the lithium battery becomes weak or dead please contact your local dealer. The batteries have to be disposed of as chemical waste.

Precautions and Safety Instructions

Precautions when Recording or Playback using LCD

- 1) High precision technology is used to manufacture the LCD display. However, there may be some tiny black specks (red, blue or green in colour) that constantly appear on the LCD display. These specks are normal and do not affect the recorded picture in anyway.
- 2) When using the LCD display outdoors or in direct sunlight, it may be difficult to see. In this case, we recommend that you use the viewfinder.
- 3) The LCD display's OSD is turned off when the LCD is turned to the forward facing position.

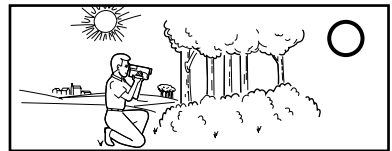
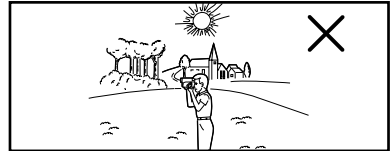

Precautions when using the hand strap

- ⌘ It is very important to adjust the hand strap correctly so that the camera can be held steady. (see page 16)
- ⌘ Do not insert your hand in the hand strap forcibly, as it may result in damaging the velcro locking system.

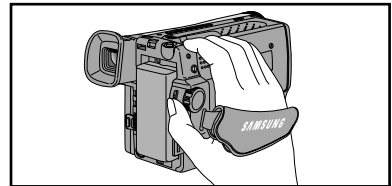

Precautions when cleaning the video heads

- ⌘ To ensure normal recording and clear pictures, ensure that the heads are kept clean. When playing back the pictures, if they are noisy or hardly visible, the video heads may be dirty. If this happens, clean the video heads with a dry type head cleaning tape.
- ⌘ Do not use the wet type of head cleaner as it may damage the video heads. (see page 58)

5 minutes off timer in STANDBY mode

- ⌘ To protect against tape and head-drum wear, your camcorder will automatically turn itself off if left in STANDBY mode without operation for more than 5 minutes.

Getting to Know Your Camcorder

Features

Your camcorder has many features available when recording or during playback.

Snap Shot (VP-L850/L850D/L870 only)

The Snap Shot function allows you to take a still picture as well as time limited audio. (see page 48)

PIP (VP-L850/L850D/L870 only)

The PIP(Picture-In-Picture) function shows the whole shot while recording with the Digital Zoom in use. (see page 47)

BLC

When you shoot a subject with the light source behind the subject or a subject with a light background, the BLC function should be switched on. (see page 37)

■ BLC: Back Light Compensation

DSE (Digital Special Effects)

The DSE gives a creative look to your films by adding various special effects. (see page 40)

Program AE (Auto Exposure)

The Program AE allows the shutter speed and aperture to adjust to the type of picture to be filmed. (see page 38)

DIS (VP-L850/L850D/L870 only)

The DIS(Digital Image Stabilizer) compensates for unstable images caused by hand shake, particularly at high magnification. (see page 35)

22x High ratio zoom lens

This Video camera has a optical zoom capability of up to 22 times magnification of a normal image. (see page 30)

Digital Zoom

Zooms more than 22x are performed digitally.

Macro

The macro function allows you to shoot your subject at close range.

EASY

This mode enables even the beginner to easily make a recording. (see page 33)

Getting to Know Your Camcorder

Front View

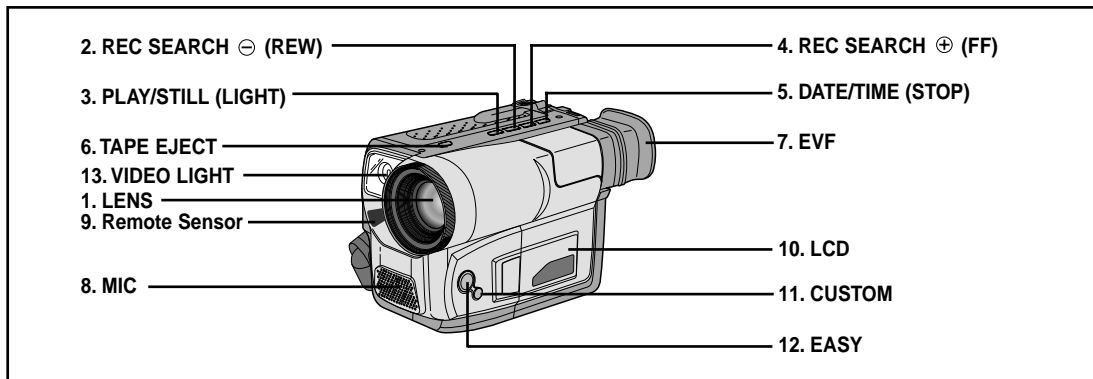

1. **Lens** (see page 68)
2. **REC SEARCH ⊖ (REW)**
REC SEARCH ⊖ works in STANDBY mode. (see page 24)
REW works in PLAYER mode. (see page 55)
3. **PLAY/STILL (LIGHT)** (see page 54)
PLAY/STILL works in PLAYER mode.
LIGHT works in CAMERA mode.
(VP-L850/L850D/L870 only)
4. **REC SEARCH ⊕ (FF)**
REC SEARCH ⊕ works in STANDBY mode. (see page 24)
FF works in PLAYER mode. (see page 55)
5. **DATE/TIME (STOP)**
DATE/TIME works in CAMERA mode. (see page 42)
STOP works in PLAYER mode. (see page 54)
6. **TAPE EJECT** (see page 22)
Use when ejecting the tape.
7. **EVF (Electronic Viewfinder)**
8. **MIC**
MIC works in CAMERA mode.
9. **Remote Sensor**
(VP-L850/L850D/L870 only)
10. **LCD** (see page 26)
11. **CUSTOM**
CUSTOM works in CAMERA mode.
12. **EASY**
EASY works in CAMERA mode.
13. **VIDEO LIGHT**
(VP-L850/L850D/L870 only)

Getting to Know Your Camcorder

Side View

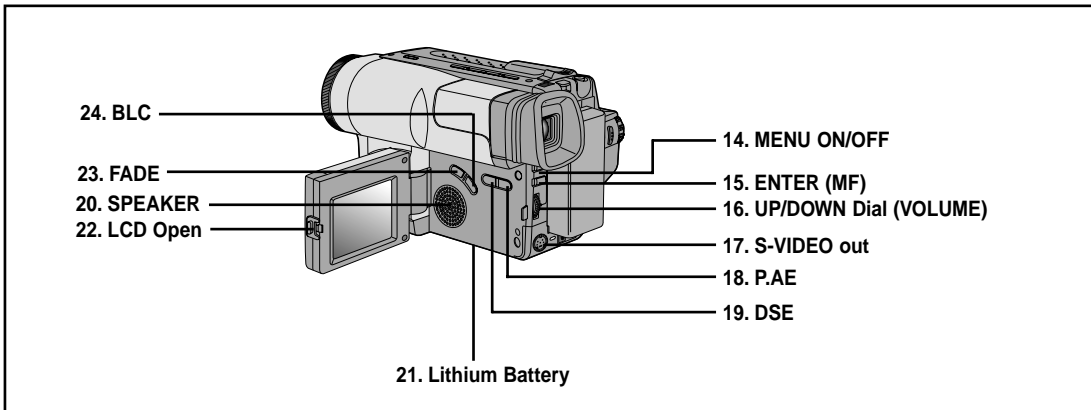

- | | |
|--|--|
| <p>14. MENU ON/OFF (see page 26)
MENU ON/OFF works in CAMERA and PLAYER mode.</p> <p>15. ENTER (MF) (see page 26)
ENTER works in MENU mode.
MF works in CAMERA mode.</p> <p>16. UP/DOWN dial (VOLUME)
UP/DOWN dial works in MENU mode. (see page 26)
VOLUME works in PLAYER mode. (see page 56)</p> <p>17. S-VIDEO out (VP-L800/L850/L850D/L870 only, see page 54)</p> <p>18. PROGRAM AE (see page 38)
PROGRAM AE (Auto Exposure) works in CAMERA mode.</p> | <p>19. DSE (see page 40, 57)
DSE works in CAMERA and PLAYER mode.</p> <p>20. SPEAKER (see page 56)
Speaker works in PLAYER mode.</p> <p>21. Lithium Battery (see page 17)</p> <p>22. LCD open</p> <p>23. FADE (see page 46)
FADE works in CAMERA mode.</p> <p>24. BLC (see page 37)
BLC works in CAMERA mode</p> |
|--|--|

Getting to Know Your Camcorder

Rear View

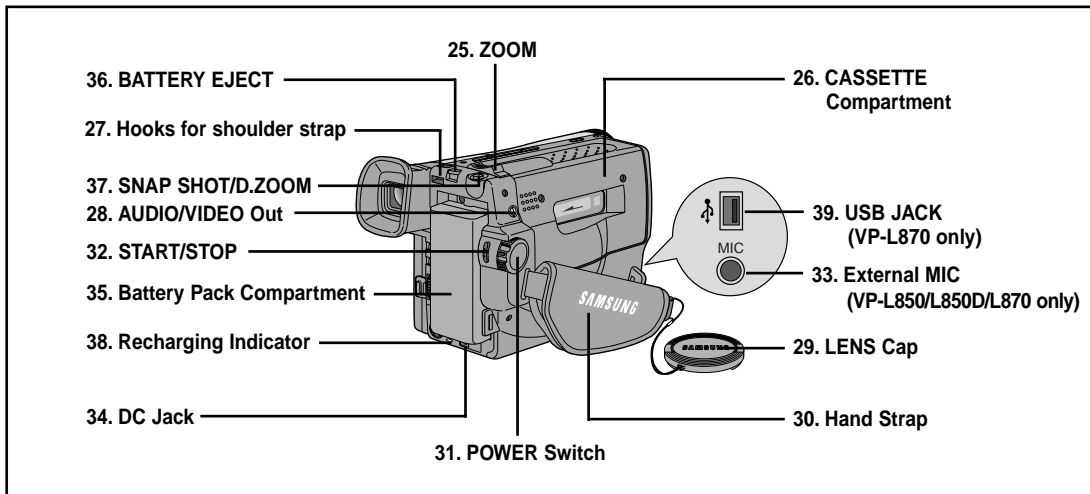

- 25. ZOOM** (see page 30)
- 26. Cassette Compartment**
- 27. Hooks for Shoulder Strap** (see page 17)
- 28. AUDIO/VIDEO out** (see page 53)
- 29. LENS Cap**
- 30. Hand Strap** (see page 16)
- 31. POWER Switch** (see page 18)
- CAMERA : Select to record.
 - OFF : Select to turn off the camcorder.
 - PLAYER : Select to playback.
- 32. START/STOP** (see page 23)
- START/STOP works in CAMERA mode.
- 33. External MIC** (VP-L850/L850D/L870 only, see page 68)
- 34. DC Jack** (see page 18)
- 35. Battery Pack Compartment** (see page 19)
- 36. BATTERY EJECT**
- 37. SNAP SHOT/D.ZOOM**
- SNAP SHOT works in CAMERA mode.
(VP-L850/L850D/L870 only, see page 48)
- D.ZOOM works in CAMERA mode.
(VP-L800U/L800 only, see page 32)
- 38. Recharging Indicator** (see page 19)
- 39. USB JACK** (VP-L870 only, see page 62)

Getting to Know Your Camcorder

OSD (On Screen Display)

- ☞ You can turn the OSD on/off by setting the Display menu on/off.
- ☞ The TITLE, DATE/TIME, EASY and CUSTOM functions can be operated even after the OSD is turned off.
- ☞ The OSD is displayed in the viewfinder and the LCD monitor.

a. Zoom position (see page 30)

Indicates zoom position.

b. DIS (VP-L850/L850D/L870 only) (see page 35)

Indicates DIS is activating.

c. Battery level (see page 21)

Indicates the power left in the battery.



d. Manual Focus (see page 36)

Indicates manual focus is on.

Auto Focus is not displayed.

e. BLC (see page 37)

Indicates BLC is activating.

f. Program AE (see page 38)

Indicates Program AE mode is activating. ()

g. Self record waiting timer. (VP-L850/L850D/L870 only) (see page 15)

Indicates 10 seconds timer.

h. Self record recording timer. (VP-L850/L850D/L870 only) (see page 15)

(30 seconds or END).

i. Date (see page 42)

Displays the date the recording was made.

OSD in CAMERA mode

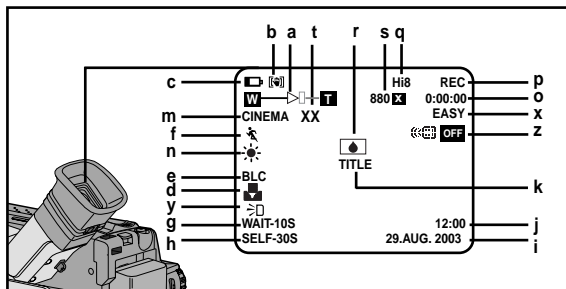

OSD in PLAYER mode

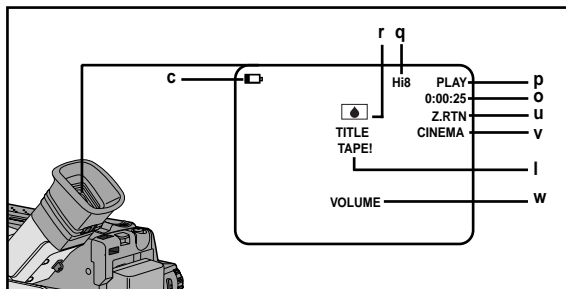

Getting to Know Your Camcorder

OSD (On Screen Display)

- j. **Time (see page 42)**
Shows the time the recording was made.
- k. **Title (see page 44)**
Shows the title of the recording. It is superimposed on the scene.
- l. **Self diagnosis (see page 64)**
(TAPE!, TAPE END!, PROTECTION!) Checks the operation of the Camcorder.
- m. **DSE (Digital Special Effect) (see page 40)**
Indicates the DSE mode is activating.
The operation modes are GHOST, STROBE, SEPIA, B&W, NEG., MIRROR, ART, MOSAIC, 16:9(WIDE) and CINEMA.
- n. **White Balance mode (see page 49)**
Indicates the White Balance mode is activating.
The White Balance modes are AUTO, INDOOR(☼) and OUTDOOR(☼).
- o. **Tape counter**
Indicates amount of the tape used.
- p. **Operation mode**
Indicates the operation mode is activating.
The operation modes are STBY, REC ●, STOP, PLAY(▶), FF(▶▶), REW(◀◀), EJECT.
- q. **Hi8 (VP-L800/L850/L850D/L870 only) (see page 54)**
Indicates the use of the Hi8 tape in CAMERA or PLAYER modes.
In case of not being tape, display Hi8 on the screen in CAMERA or PLAYER modes.
- r. **DEW (☼) condensation (see page 67)**
Monitors the moisture condensation.
- s. **Digital zoom (see page 31)**
Indicates the digital zoom is active.
- t. **Snap Shot (VP-L850/L850D/L870 only) (see page 48)**
Shows the remaining available space for Snap Shots.
- u. **Z.RTN (VP-L850/L850D/L870 only) (see page 55)**
Shows when the zero return is activated.
- v. **PB DSE (see page 57)**
Shows that the PB DSE mode is active.
- w. **VOLUME (see page 56)**
- x. **EASY & CUSTOM**
Shows when the easy or custom mode is active.
- y. **LIGHT (VP-L850/L850D/L870 only)**
Shows when the Light is switched on.
- z. **Remocon (☼ OFF) (VP-L850/L850D/L870 only)**
Indicates the remocon off mode is activated.

Getting to Know Your Camcorder

Accessories Supplied with Camcorder

Make sure that the following basic accessories are supplied with your camcorder.









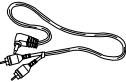

Basic Accessory

1. AC Power Adapter. (see page 18)
2. AC cord. (see page 18)
3. Battery Pack. (see page 19)
4. Audio/Video Cable. (see page 53)
5. Shoulder strap. (see page 17)
6. Instruction Book.
7. Remote Control.
(VP-L850/L850D/L870 only, see page 15)
8. Lithium Battery for Remote Control.
(VP-L850/L850D/L870 only, see page 15)
Lithium Battery for Clock.
(TYPE: CR2025, see page 17)
9. Software CD (VP-L870 only)
10. USB Cable (VP-L870 only)
11. USB AUDIO Cable (VP-L870 only)

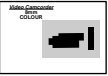
Optional Accessory

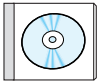
12. Scart adapter. (see page 53)
13. S-VIDEO cable.
(VP-L800/L850/L850D/L870 only, see page 54)

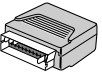
Note: Optional accessories may be included with the camcorder, depending on the country in which it is purchased.

<p>1. AC Power Adapter</p> 	<p>2. AC cord</p> 	<p>3. Battery Pack</p> 
<p>4. AUDIO/VIDEO Cable</p> 	<p>5. Shoulder Strap</p> 	<p>6. Instruction Book</p> 
<p>7. Remote Control</p> 	<p>8. Lithium Batteries</p> 	<p>9. Software CD</p> 
<p>10. USB Cable</p> 	<p>11. USB AUDIO Cable</p> 	
<p>12. Scart adapter</p> 	<p>13. S-VIDEO cable</p> 	

Getting to Know Your Camcorder

Remote Control (VP-L850/L850D/L870 only)

Description of Parts

1. Start/Stop (see page 23)
2. Self Timer
3. Still (see page 55)
4. WIDE (see page 30)
5. TELE (see page 30)
6. Display (see page 12)
7. ► (Play) (see page 54)
8. ►► (FF) (see page 55)
9. ◀◀ (REW) (see page 55)
10. ■ (Stop) (see page 54)
11. Counter Reset (see page 55)
12. Zero Return (see page 55)

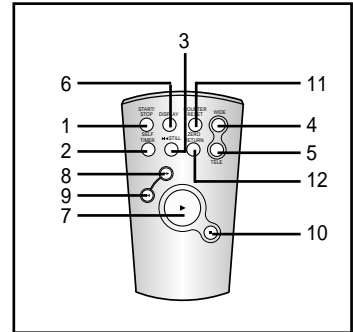

Battery Installation to the Remote Control

- ⚠ You must insert or replace this battery when:
 - The remote works intermittently
 - The remote control doesn't work.
- ⚠ Insert Lithium Battery, following the + and - markings.
- ⚠ Be careful not to reverse the polarity of the battery.

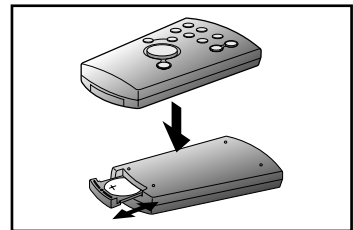

Self Recording with the Remote Control

- ⚠ The Self Timer function on the remote control allows you to start and stop recording automatically.

Example: recording yourself

- ⚠ Two options are available
 - WAIT-10S/SELF-30S: wait 10 seconds, followed by 30 seconds of recording.
 - WAIT-10S/SELF-END: wait 10 seconds, followed by recording until you press the START/STOP button again.

Preparing

1. Set the power switch to CAMERA mode.

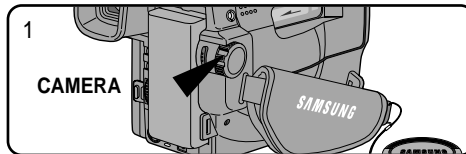

2. Press the Self Timer button on the remote until the appropriate setting is displayed on the LCD:

- WAIT-10S/SELF-30S
- WAIT-10S/SELF-END

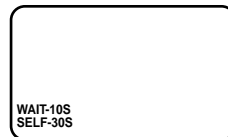
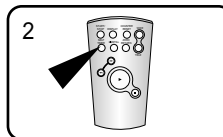

3. To start the delayed recording, press the START/STOP button.

: After waiting for 10 seconds, recording starts.

: If you have selected SELF-30S, recording stops automatically after 30 seconds.

: If you have selected SELF-END, press START/STOP again when you wish to stop recording.

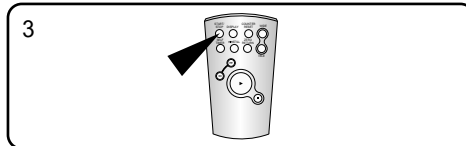

Note: When using the timer, pressing the START/STOP button again, cancel's the timer function.

Adjusting the Hand Strap and Shoulder Strap

Hand Strap

- ⚠ It is very important to adjust the hand strap correctly to ensure the camera can be held steady during use.
- ⚠ The hand strap enables you to:
 - Hold the camcorder in a stable, comfortable position.
 - Press the Zoom and the red Record button without having to change the position of your hand.

1. Pull open the Hand Strap cover and release the Hand Strap, adjust its length and stick it back onto the Hand Strap cover.
2. Close the Hand Strap cover back up again.

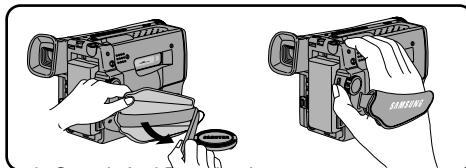

Preparing

Shoulder Strap

⌘ The Shoulder Strap allows you to carry your camcorder with complete safety.

1. Insert each end of the strap into the hooks on the camcorder.
2. Put the end of each strap through the buckle, adjust the length of the strap, then pull it tight in the buckle.

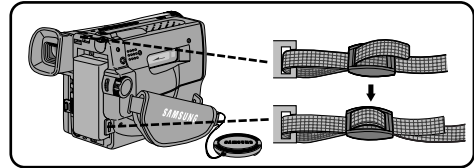

Lithium Battery Installation

- ⌘ The lithium battery maintains the clock function, title and preset contents of the memory; even if the battery pack or AC power adapter is removed.
- ⌘ The lithium battery for the camcorder lasts about 8~10 months from the time of installation under normal operation.
- ⌘ When the lithium battery becomes weak or dead, the date/time indicator flashes for about 5 seconds when you set the power switch to CAMERA.
In this case, replace the lithium battery with CR2025 type.

1. Take out the holder from the lithium battery compartment.
2. Insert the ⊕ side of the lithium battery toward the bottom of the holder.
3. Reinsert the holder into the lithium battery compartment.

Note: The holder must be inserted in the correct direction or it will not fit properly.

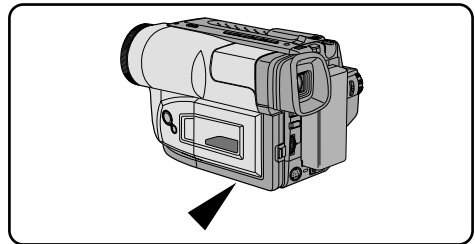

Warning: Keep the LITHIUM BATTERY out of the reach of the children.
Should the battery be swallowed, consult a doctor immediately.

Preparing

Connecting the Power Source

- ⌘ There are two ways to connect to a power source.
 - Using the AC Power Adapter : used for indoor recording.
 - Using the Battery Pack: used for mobile/outdoor recording.

To use the AC Power Adapter

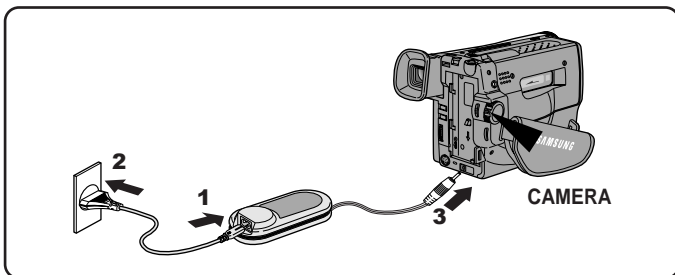

1. Connect the AC Power Adapter to the AC power cord.
2. Connect the AC cord to a wall socket.
Note: The plug and wall socket type can be different according to the regional conditions.
3. Connect the other end of the DC cable to DC jack of the camcorder.
4. Set the camcorder to CAMERA mode.
 - a. Hold down the tab of the power switch and push the switch up to CAMERA mode.
 - b. Make sure that the Lens Cap is removed and secured.
 - c. Open the LCD monitor and make sure that the image appears on the LCD display.
 - The LCD display will switch on automatically when opened more than 30 degrees.

Note: If the adapter is used next to a TV or the camcorder, it may cause interference on the TV or camcorder. Keep the adapter away from the TV, camcorder or the antenna cable during use.

Preparing

To use the Battery Pack

How long will the battery last for shooting?

- ⚠ Depends on how often you are likely to use the zoom feature during recording.

Recharging the Battery Pack

1. Attach the battery pack to the camcorder.

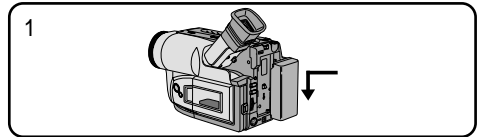

2. Connect the AC Power Adapter to an AC cord and connect the AC cord to a wall socket.

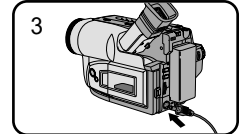
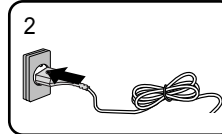

3. Connect DC cable to DC jack of the camcorder.

4. Switch the camcorder off. The charging LED next to the DC IN socket will start blinking to indicate the battery is charging

- Flashing once a second : The battery is less than 50% charged.
- Flashing twice a second : The battery is 50% ~ 75% charged.
- Flashing three times a second : The battery is 75% ~ 100% charged.
- Constantly on : Charging is complete.
- On for a second and off for a second: There is an error and the charger needs to be reset. Remove and replace the DC supply to the camera. If the problem continues, contact the nearest service agent.

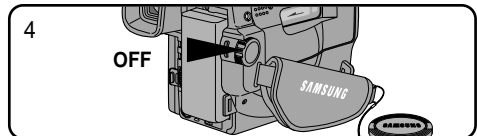

5. If recharging is completed, separate the camcorder, AC power adapter, and battery pack.

- Even if the power is turned off, battery will be discharged.

Note: The battery pack may be slightly charged at the time of purchase.

Download from [Www.Somanuals.com](http://www.Somanuals.com). All Manuals Search And Download.

Preparing

Using the Battery Pack

Table of continuous recording time based on model and battery type.

Model Battery Type	VP-L800U/L800		VP-L850/L850D/L870	
	LCD ON, EVF OFF	LCD OFF, EVF ON	LCD ON, EVF OFF	LCD OFF, EVF ON
SB-L110A	Approximately 90 minutes	Approximately 130 minutes	Approximately 80 minutes	Approximately 120 minutes
SB-L160	Approximately 130 minutes	Approximately 190 minutes	Approximately 120 minutes	Approximately 160 minutes
SB-L320	Approximately 260 minutes	Approximately 390 minutes	Approximately 240 minutes	Approximately 340 minutes

⚠ The continuous recording times given in the table are approximate. Actual recording time may differ depending on usage.

Notes:

- ⚠ The battery pack should be recharged in a room temperature that is between 0°C and 40°C. It should never be charged in a room temperature that is below 0°C.
- ⚠ The life and capacity of the battery pack will be reduced if it is used in temperatures below 0°C, even when it is fully charged.
- ⚠ The life and capacity of the battery pack will be reduced if the battery pack is left in temperatures above 40°C for a long period, even when it is fully recharged.
- ⚠ Do not put the battery pack near any heat source (fire or flames, for example) or leave in direct sunlight.
- ⚠ Do not connect +/- of the battery pack.

Preparing

Display of Battery Level

⌘ The battery level display indicates the amount of power remaining in the battery pack.

1. Fully charged
2. 10~40% consumed
3. 40~60% consumed
4. 60~80% consumed
(prepare a charged one)
5. 80~95% consumed
(change the battery)
6. 100% consumed
(camcorder will turn off soon, change the battery as soon as possible)

⌘ Please refer to the table on page 20 for approximate continuous recording times.

⌘ The recording time is affected by environmental temperature and conditions.

The recording time becomes very short in a cold environment. The continuous recording time in the operating instructions is measured using a fully charged battery pack in 77°F(25°C). As the environmental temperature and conditions may be different when you actually use the camcorder, the remaining battery time may not be the same as the approximate continuous recording times given in these instructions.

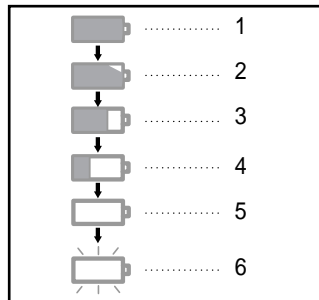

Tips for Battery Identification.

A charge mark is provided on the battery pack to help you remember whether it has been charged or not.

Two colours are provided (red and black)-you may choose which one indicates charged and which indicates discharged.

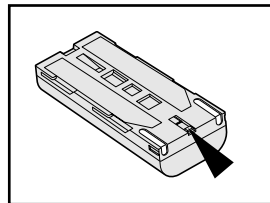

Preparing

Inserting and Ejecting a Cassette

- ⌘ There are several cassette types, depending on:
 - Colour system used
 - Recording/playback time.
 - Hi8/8mm (VP-L800/L850/L850D/L870 is Hi8)

Inserting and Ejecting a Cassette

- ⌘ Check to see if the battery pack is in place or AC adapter is connected.

1. Press EJECT button.

- The compartment opens automatically.
- Insert the cassette with the transparent window facing outward and the protection tab toward the top.

2. Press PUSH mark until the compartment clicks into place.

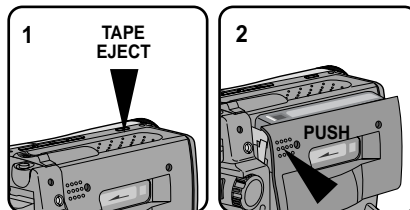

Note: When you have recorded a cassette that you wish to keep, you can protect it from being accidentally erased.

a. Recording Impossible (Protection):

Push the red tab on the cassette to cover up the opening.

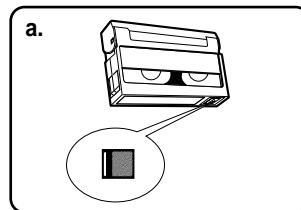

b. Recording possible:

If you no longer wish to keep the recording on the cassette, move the red tab back so that it no longer covers the hole.

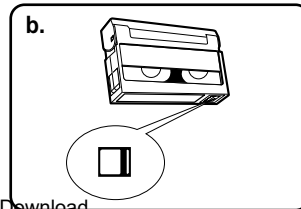

Basic Shooting

Making your First Recording

Please make these preparations before shooting.

- Have you connected a power source?
(Battery Pack or AC Power Adapter)

- Did you set power switch to CAMERA position?

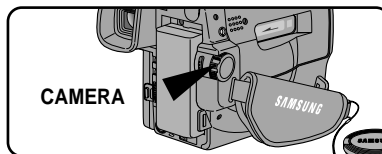
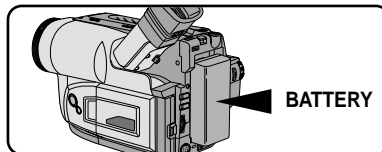

- Have you inserted a cassette? (see page 22)
 - Open the LCD monitor and make sure that STANDBY is displayed in the OSD.
(if the red tab of the cassette is closed, STANDBY will not be displayed)
 - Did you open the LENS CAP?
 - Make sure the image you want to shoot appears in the LCD monitor.
 - Make sure the battery level indicates that there is enough remaining power for shooting. (see page 21)
 - We recommend that beginners, who are using the camcorder for the first time, switch the EASY mode on.
- a. To start shooting, press the red START/STOP button.
Shooting starts and REC should be displayed on the LCD.

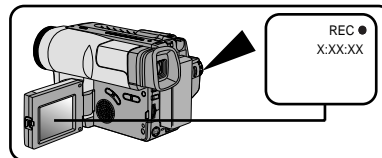

Basic Shooting

- b. To stop shooting, press the red START/STOP button again.
When recording stops, STANDBY will be displayed on the LCD.

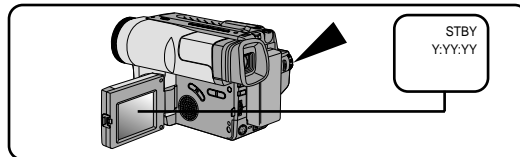

When a cassette is loaded and the camcorder is left in STANDBY mode for over 5 minutes without being used, it will turn off automatically. To use it again, push the red START/STOP button or set power switch to OFF and then back to CAMERA. This Auto Power Off feature is designed to save battery power and to protect the tape Head and tape.

REC SEARCH

- ☞ You can view a recorded picture with REC SEARCH \oplus , \ominus function in STANDBY mode. REC SEARCH \ominus allows you to reverse and REC SEARCH \oplus allows you to forward, for as long as you keep the button pressed.

- ☞ If you press REC SEARCH \ominus button briefly in STANDBY mode, your camcorder will playback in reverse for 3 seconds and return to the original position automatically.

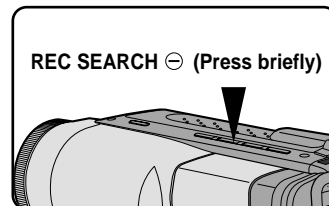
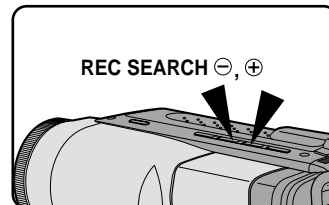

Basic Shooting

Tips for Stable recording

- While recording, it is very important to hold the camcorder correctly.
- When recording, clip the LENS cap on the hand strap to avoid the risk of the lens cap swinging into shot. (refer to figure)

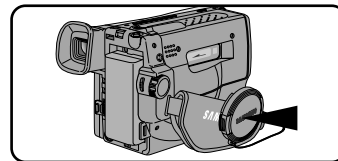

Recording with the LCD display

1. Hold the camcorder firmly using the hand strap. (see page 16)
2. Place your right elbow against your side.
3. Place your left hand under or next to the LCD to support and adjust it.
Do not touch the built-in microphone.
4. Choose a comfortable, stable position for the shots.
You can lean against a wall or on a table for greater stability.
Do not forget to breathe gently.
5. Use the LCD frame as a guide to determine the horizontal plane.
6. Whenever possible, use a tripod.

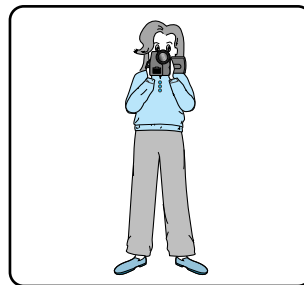

Recording with the Viewfinder

1. Hold the camcorder firmly with the hand strap. (see page 16)
2. Place your right elbow against your side.
3. Place your left hand under the camcorder to support it.
Be sure to not touch the built-in microphone.
4. Choose a comfortable, stable position for the shots.
You can lean against a wall or on a table for greater stability.
Do not forget to breathe gently.
5. Put your eye firmly against the viewfinder.
6. Use the viewfinder frame as a guide to determine the horizontal plane.
7. Whenever possible, use a tripod.

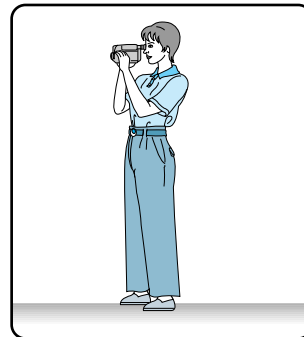

Basic Shooting

Adjusting the LCD

⌘ You can view the image you are recording or watch a playback of recordings made by using your camcorder's 2.5 inch colour Liquid Crystal Display (LCD) screen.

⌘ Under certain conditions you may need to adjust the settings for the LCD display (outdoors for example).

Adjustment can be made to the:

- Brightness
- Colour

1. Make sure that the battery pack is in place.
2. Set power switch to CAMERA mode. (see page 18)
3. Open the LCD display, the LCD will come on.
4. Press the MENU ON/OFF button, the MENU list will be displayed.

5. Turn the UP/DOWN dial until LCD ADJUST is highlighted.

6. Press ENTER.
 ■ The LCD ADJUST MENU will appear.

7. Turn the UP/DOWN dial to adjust the LCD brightness.

8. Press ENTER.
 ■ The cursor will move to the next item.

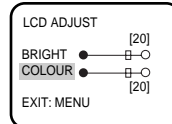
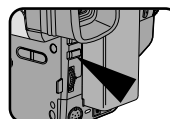
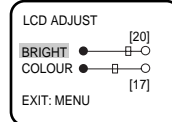
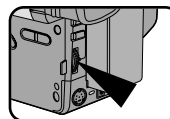
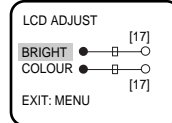
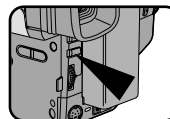
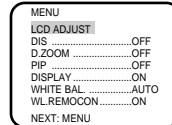
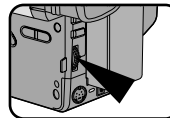
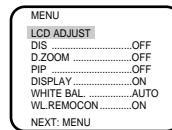
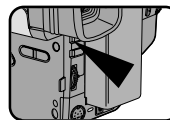

Basic Shooting

9. Turn the UP/DOWN dial to adjust the LCD colour setting.
10. Press the ENTER.
 - For further adjustment, repeat steps 7, 8, 9.
11. Press the MENU ON/OFF button to exit the menus.

Notes:

- If you don't press a button within 30 seconds, the setting will disappear.
- The MENU ON/OFF function will not operate in EASY or REC mode.

Adjusting Focus of the VIEWFINDER

Focus:

Slide the focus adjustment knob on the bottom of the VIEWFINDER to focus the image in the viewfinder.

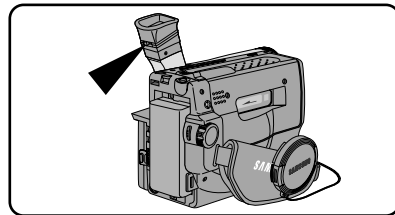

Basic Shooting

Playing back the tape on the LCD

- ⌘ You can watch a recording on the LCD display.
- ⌘ Make sure that the battery pack is in place.

1. Hold down the tab of the power switch and push the switch to select PLAYER mode.
2. Insert the tape you wish to play.
3. Open the LCD display and check that STOP is on the display. Adjust the angle of the LCD display and adjust the brightness or the colour as necessary.
4. Press the ◀◀ (REW) button to rewind the tape to the beginning.
 - To stop REWIND, press the ■ (STOP) button.
 - Camcorder stops automatically after rewinding.
5. Press the ▶▶ (PLAY/STILL) button to start playback.
 - You can see the video you shot on the LCD.
 - To stop the PLAY operation, press the ■ (STOP) button.

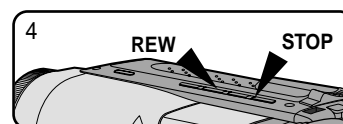
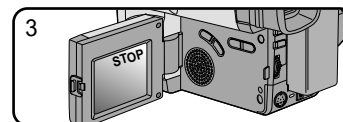
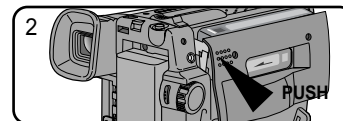
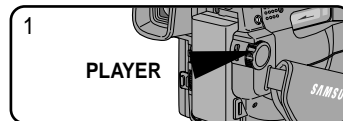

Note: You can also watch a recording on a TV screen.

For more on how to connect the camcorder to a TV or VCR see page 53.

Basic Shooting

Adjusting the LCD during PLAY

The procedure for adjusting the LCD display in PLAYER mode is the same as that for adjusting it in CAMERA mode, except that the power switch must be set to PLAYER instead of CAMERA.

Please refer to page 26.

Controlling the sound from the speaker

- ⌘ You can hear your video's audio track through the built-in speaker when using the LCD display for playback.
- ⌘ The speaker's volume is controlled by the UP/DOWN dial on the camcorder.
- ⌘ The speaker will not work if the LCD display is closed.
- ⌘ If the speaker does not work properly, check the following:
 - Is the LCD monitor closed?
 - Is the volume level adjusted correctly?
 - Is the speaker switched off? (see page 56)

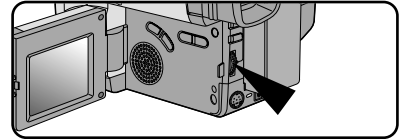

- Notes:**
- Lower the volume if vibration from the built-in speaker causes screen disturbance.
 - The Volume settings will automatically disappear 2 seconds if no further adjustments are made.

Viewing a Still Picture

- Press ►|| (PLAY/STILL) button during playback.
- To resume playback, press the ►|| (PLAY/STILL) button again.



Picture Search

- Keep pressing ►► (FF) or ◀◀ (REW) button during playback.
- To resume normal playback, release the button.

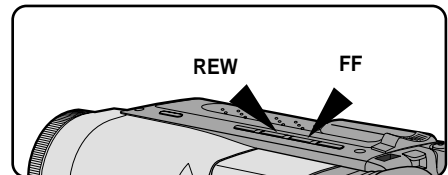

Advanced Shooting

Zooming In and Out

- ⌘ Zoom is only available in CAMERA mode.
 - ⌘ Zooming is a technique that lets you magnify the size of the subject in the picture.
For a more professional looking recording, don't use the zoom function too often.
 - ⌘ There are two zoom speeds to suit different needs :
 - Gradual zoom (9~12 seconds from TELE/WIDE to WIDE/TELE)
 - High-Speed zoom (3~6 seconds from TELE/WIDE to WIDE/TELE)
 - ⌘ Use these features for different shots; please note that over use of the zoom feature can lead to a reduction in available battery time.
1. Move the zoom lever a little for a gradual zoom, move it further for a high-speed zoom. Your zooming is monitored on the OSD.

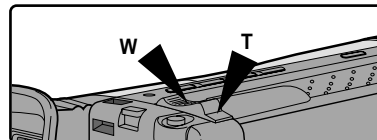

2. T (Telephoto) side:
Subject appears closer.



3. W (Wide angle) side:
Subject appears further away.

**Note: MACRO**

You can record a subject that is at least 1 mm away from the lens surface in the wide angle position.

If you cannot get a sharp focus in telephoto zoom, move the lever to the "W" side until the focus is sharp.

Advanced Shooting

Digital Zoom

- ⌘ Digital Zoom is only available in CAMERA mode.
- ⌘ Magnification above 22x is achieved using digital technology.
- ⌘ The picture quality deteriorates as you go towards the “T” side.
- ⌘ It is recommend that you use the DIS (VP-L850/L850D/L870) feature with the DIGITAL ZOOM for picture stability. (see page 35)

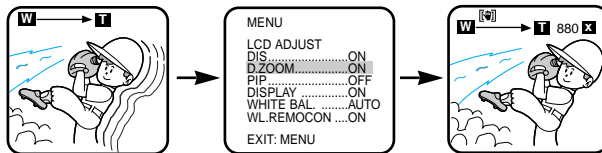

1. Set power switch to CAMERA mode. (see page 18)
 - Open the LCD display and adjust it so that you can see it comfortably.
2. Make sure that the DIGITAL ZOOM feature is switched on. (see page 32)
3. When you move the ZOOM lever to the side labeled “T”, the picture will be magnified upto a maximum of 880 times normal size. (VP-L850D: 990x)



shows the digital zoom area
shows the optical zoom area

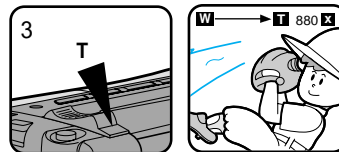

4. If you do not want to use the DIGITAL ZOOM, set the DIGITAL ZOOM function to OFF in the MENU list. (see page 32)

Advanced Shooting

Switching the DIGITAL ZOOM ON/OFF (VP-L850/L850D/L870 only)

⌘ The DIGITAL ZOOM feature is explained on page 31.

1. Set the power switch to CAMERA mode. (see page 18)
2. Press the MENU ON/OFF button.

■ The MENU list will be displayed.

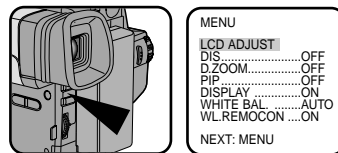

3. Turn the UP/DOWN dial to D. ZOOM.

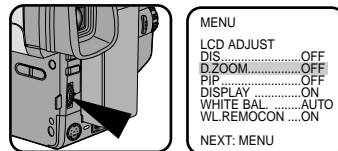

4. Press ENTER.

■ The DIGITAL ZOOM setting will be changed.

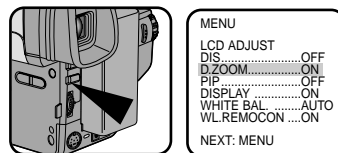

5. Press the MENU ON/OFF button to exit.

In case of VP-L800U/L800

1. Set the power switch to CAMERA mode.
2. Press the D. ZOOM ON/OFF button.
 - The DIGITAL ZOOM gauge should be displayed on the screen, and the DIGITAL ZOOM function is on.
3. To deactivate the DIGITAL ZOOM function, press the D.ZOOM button again.
 - The DIGITAL ZOOM indicators disappear from the screen.

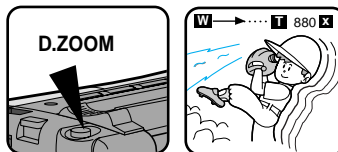

Note: The D.ZOOM ON/OFF function will not operate in EASY mode.

Advanced Shooting

EASY Mode (for Beginners)

- ⌘ Even a beginner can easily make a recording using the EASY mode.
 - The EASY mode only operates in CAMERA mode.
1. Set the power switch to CAMERA mode (see page 18).
 2. By pressing the EASY button, all the functions of the camera will be set to off and the recording settings will be set to the lowest basic mode.
 - Battery level, recording mode, counter, date/time, DIS ([DIS]) will be displayed as the camcorder starts to run.
 - The word "EASY" will appear on the LCD at the same time. However, the Date/Time will only be seen if it has been previously set. (DIS ([DIS]) will be displayed on VP-L850/L850D/L870 only)
 3. Press the START/STOP button to start recording.
 - Recording will begin using the basic automatic environment settings.
 4. Pressing the EASY button again turns the EASY mode off.
 - The camera will return to the settings that were set prior to the EASY mode being switched on.

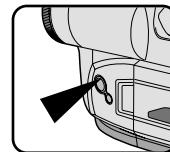
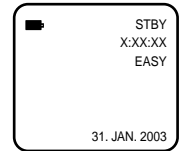
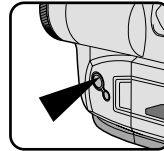

Notes:

- In the EASY mode, the MENU, MF, DSE, P.AE and BLC functions are not available.
- If you want to use these functions, you must first switch the EASY mode off.
- The EASY mode settings are stored in the camera (provided a good lithium battery has been installed).

Advanced Shooting

CUSTOM-Creating your own customized recording settings

- ⌘ You can customize the settings and save them for future use.
 - The CUSTOM function only operates in CAMERA mode.
1. Set the power switch to CAMERA mode. (see page 18)
 2. Press the MENU ON/OFF button, to bring up the MENU list.
 3. Turn the UP/DOWN dial until CUSTOM SET is highlighted.
 4. Press the ENTER button, the CUSTOM menu will appear.
 - Set the status of each item to what you want.
 5. To exit the menu, press the MENU ON/OFF button twice.
 6. By pressing the CUSTOM button, the CUSTOM settings will come up.
 - Date/Time and Title will only appear if these have been set in advance.
 - The word "CUSTOM" will be displayed on the LCD at the same time.

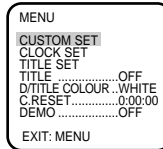
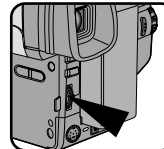
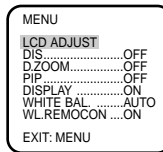
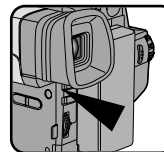

Example: When the CUSTOM SET is set as follows;

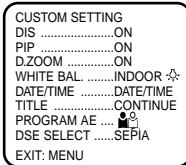
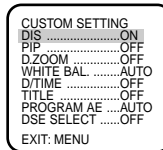
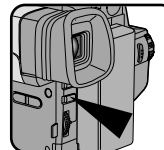

Pressing the CUSTOM button, displays

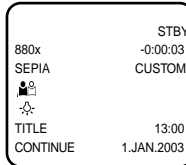

7. Press the START/STOP button to start recording.
 - Recording will begin using the new CUSTOM settings.
8. To switch Custom off, press the CUSTOM button once.
 - The camera will revert to the settings that were set prior to the CUSTOM mode being switched on.

Notes:

- In CUSTOM mode, the DIS and PIP functions are not available.
- If you want to use these, you must first switch the EASY or CUSTOM mode off.
- The CUSTOM settings will be stored in the camera (providing a good lithium battery has been installed).

Advanced Shooting

DIS (Digital Image Stabilizer, VP-L850/L850D/L870 only)

- ⌘ The DIS function only works in CAMERA mode.
- ⌘ DIS (Digital Image Stabilizer) is a handshake compensation function that compensates for any shaking or moving of the hand holding the camcorder (within reasonable limits).
- ⌘ It provides more stable pictures when:
 - Recording with the Zoom.
 - Recording small objects close-up
 - Recording and walking at the same time
 - Recording through the window of a vehicle

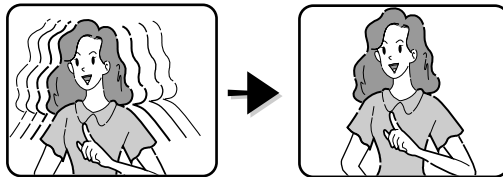

1. Set the power switch to CAMERA mode. (See page 18)
 - Open the LCD display and adjust as necessary.
2. Press the MENU ON/OFF button.
 - The MENU list will be displayed.
3. Turn the UP/DOWN dial until DIS is highlighted.
4. Press ENTER.
 - The DIS setting will be changed.
5. Press MENU ON/OFF button to exit.
 - When the DIS is set, the DIS symbol () will be displayed in the display.

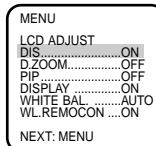
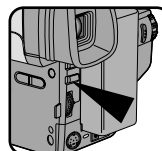
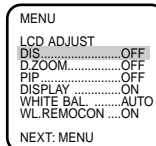
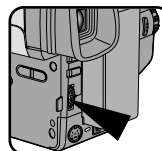
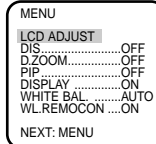
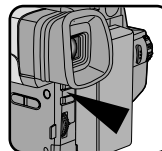

- Notes:**
- It is recommended to deactivate the DIS function when using a tripod.
 - The DIS function will not operate in DSE mode.
 - The MENU ON/OFF function will not operate in EASY mode.

Advanced Shooting

MF/AF (Manual Focus/Auto Focus)

- ⌘ The MF/AF function works only in CAMERA mode.
- ⌘ In most situations, it is better to use the Automatic Focus feature, as it enables you to concentrate on the creative side of your shooting.
- ⌘ Manual focusing may be necessary under certain conditions that make automatic focusing inadequate.

Auto Focusing

- ⌘ The AF (Auto Focus) mode is set automatically when you switch on the Power switch.
- ⌘ If you are inexperienced with camcorders, we recommend that you use the Auto Focus mode.

Manual Focusing

- ⌘ In the following situations, you should obtain better results by adjusting the focus manually.
 - a. A picture containing several objects, some close to the camcorder, others further away.
 - b. A person enveloped in fog or surrounded by snow.
 - c. Very shiny or glossy surfaces like a car.
 - d. People or objects moving constantly or quickly like an athlete or crowd.
1. Set the power switch to CAMERA mode. (see page 18)
 2. Press the MF button.
MF icon will appear in display.
 3. Zoom in on the subject to be shot by pushing the ZOOM tab to the "T" side.

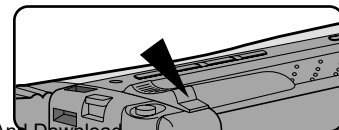
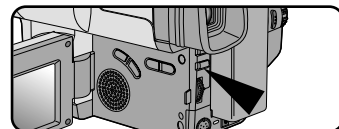
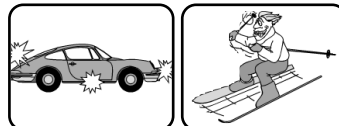

Advanced Shooting

4. Turn the UP/DOWN dial up or down until the object is focused.
5. If you can't get a sharp picture, zoom out until you can.

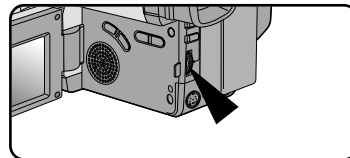

6. To return to AF(Auto Focus), press the MF button again. MF icon will disappear.

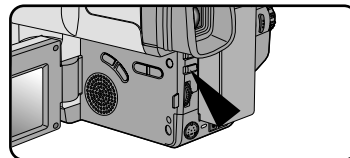

Note: The MF function will not operate in EASY mode.

BLC

BLC only works in CAMERA mode.

Back lighting exists when the subject is darker than the background, such as when:

- The subject is placed in front of a window.
 - The person to be shot is wearing white or shiny clothes so the person's face is too dark to distinguish their features.
 - The subject is outdoors and the background is overcast.
 - Any light sources are too bright.
 - The subject is against a snowy background.
1. Set the power switch to CAMERA mode. (see page 18)
 2. Press the BLC button.
 - Normal - BLC - Normal
 - BLC enhances only the subject.

* BLC off

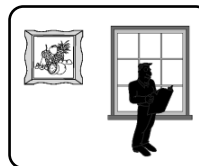



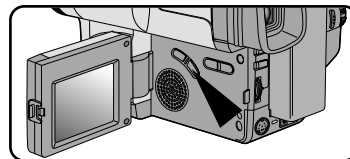

* BLC on



Note: ■ BLC function will not operate in P.AE or EASY mode.







Advanced Shooting

PROGRAM AE (Automatic Exposure)

- ⌘ The PROGRAM AE function only works in CAMERA mode.
 - ⌘ The PROGRAM AE modes allow you to adjust shutter speeds and aperture to suit different recording conditions.
 - ⌘ There are 6 automatic exposure modes.
1. **AUTO mode**
 - Auto balance between the subject and the background.
 - Used in normal conditions.
 - The shutter speed automatically varies from 1/50 to 1/250 second, depending on the picture.
 2. **SPORTS mode** ()
 - For shooting people or objects moving quickly; you should be able to playback the picture in slow motion on an 8 mm VCR or stop on a given image with very little blur.
 3. **PORTRAIT mode** ()
 - For focusing on the subject and not the background.
The PORTRAIT mode is most effective when used outdoors.
 - The shutter speed automatically varies from 1/50 to 1/1000 second, depending on the picture.
 4. **SPOTLIGHT mode** ()
 - To shoot correctly when there is only light on the subject and not the rest of the picture.
 - The shutter speed is 1/50 second.
 5. **SAND/SNOW mode** ()
 - For shooting when the people or objects are darker than the background because of reflected light from sand or snow.
 - The shutter speed automatically varies from 1/50 to 1/250 second, depending on the picture.
 6. **HSS (High Speed Shutter) mode** ()
 - For shooting fast-moving subjects such as the players in golf or tennis games.
 - You may need to light the shooting area.

Advanced Shooting

Setting the PROGRAM AE(Automatic Exposure) mode

1. Set the power switch to CAMERA mode. (see page 18)
2. Press the P.AE button, the () symbol will be displayed.
3. Press the P.AE button until the appropriate symbol is displayed.
( →  →  →  → )
 ■ No Display : Full Auto mode.

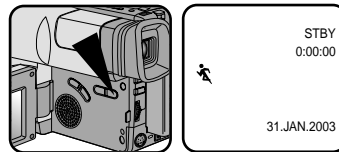

Notes:

- The P.AE chosen will be recorded on the tape.
- To end the P.AE function, press the P.AE button once or several times, until the P.AE Icon is no longer displayed.
- The P.AE function will not operate in EASY or CUSTOM mode.
- The BLC function will not operate in P.AE mode.

Advanced Shooting

DSE (Digital Special Effects) in CAMERA mode

- ⌘ The digital effects enable you to give a creative look to your recording by adding various special effects.
- ⌘ Select the appropriate digital effect for the type of picture that you wish to shoot and the effect that you wish to give.
- ⌘ There are several DSE modes. (VP-L800U/L800: 8 modes, VP-L850/L850D/L870: 10 modes)

1. Normal picture.
2. GHOST: This mode gives the image a dragging effect. (VP-L850/L850D/L870 only)
3. STROBE: This mode shoots by inserting cutting effect on the image. There are 50 field in the normal picture. (VP-L850/L850D/L870 only)
4. SEPIA: This mode gives the image a reddish-brown pigment.
5. B&W(Black & White): This mode makes the image black and white.
6. NEG.(Negative): This mode reverses the colours of the image creating a negative image.
7. MIRROR: This mode cuts the image by half, using the mirror effect.
8. ART: Adds a paint-like effect, called solarization, to the image.
9. MOSAIC: This mode gives the image a checkered design.
10. 16:9(WIDE): This mode provides 16:9(WIDE) television display.
11. CINEMA: This mode covers upper/lower portion of the screen to give a movie-like effect.



- Notes:**
- DIS and PIP function will not operate in DSE mode.
 - DSE function will not operate in EASY mode.

Advanced Shooting

Selecting and recording DSE effects

1. Set the power switch to CAMERA mode. (see page 18)
2. Press the DSE button, GHOST or SEPIA will be displayed.
3. Keep pressing the DSE button, until the desired mode is displayed.
4. Press the START/STOP button to start recording.
5. To exit the DSE functions, press the DSE button once or several times until no DSE mode is displayed on the LCD.

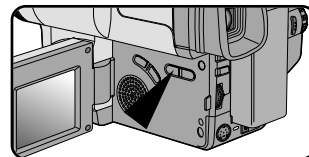
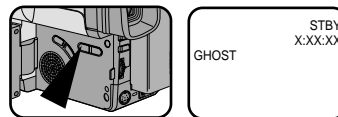

- Notes:**
- It is recommended that you set the DSE mode in STBY mode.
 - DSE functions will not operate in EASY mode.

Advanced Shooting

Setting and Recording DATE/TIME

- ⌘ Setting and recording the date/time is only available in CAMERA mode.
- ⌘ You can record the date/time on your recording, so you know when it was made.
The date and time are recorded whenever they are displayed on the viewfinder or LCD.

Setting a DATE/TIME

- ⌘ Setting the DATE/TIME is possible in STANDBY of CAMERA mode only.

1. Make sure that you have installed the LITHIUM BATTERY. (see page 17)
(The LITHIUM BATTERY is needed to maintain the clock.)
2. Set the power switch to CAMERA mode. (see page 18)
3. Press the MENU ON/OFF button, the MENU list will be displayed.
4. Turn the UP/DOWN dial until CLOCK SET is highlighted.
5. Press ENTER.
 - The DATE and TIME are displayed.
 - The area blinking indicates which part of the DATE or TIME can be edited. The year will be the first area to blink.
6. Turn the UP/DOWN dial to set a desired year.

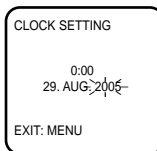
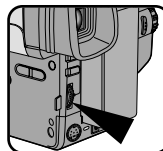
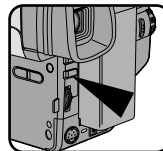
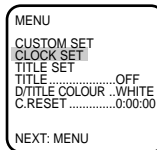
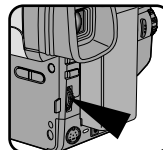
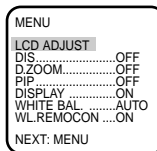
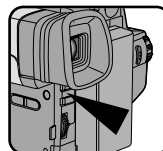

Advanced Shooting

7. Press ENTER.
 - The month setting will blink.
8. Turn the UP/DOWN dial to set the desired month.
9. Press ENTER.
 - The day setting will blink.
10. You set the day, hour and minute by following the same procedures used for setting the year and month.
11. Pressing ENTER after setting the minutes causes the clock setting screen to disappear. The entered date and time will then be displayed.

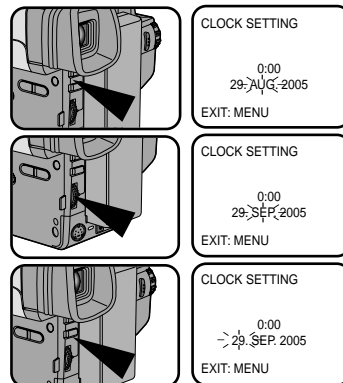

Recording a DATE/TIME

1. Make sure that you have set the DATE/TIME.
2. Set the power switch to CAMERA mode. (see page 18)
 - Open the LCD display and adjust it as necessary.
3. Press the DATE/TIME button the required number of times.
 - To record the date only, press the DATE/TIME button once.
 - To record the date and time, press the DATE/TIME button twice.
4. Press the START/STOP button to start recording with the DATE/TIME in your recording.

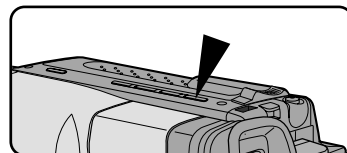

Notes:

- If your date and time settings are not maintained in the camcorder, it means the LITHIUM BATTERY is discharged and should be replaced. (see page 17)
- You cannot hide the recorded date or time during playback.
- The DATE/TIME function will not operate in EASY or CUSTOM mode.

Advanced Shooting

Selecting and Recording a Title

- ⌘ Selecting and recording a TITLE is possible in the CAMERA mode only.
- ⌘ The TITLE feature allows you to select a preset title stored in the camcorder's memory.
- ⌘ You can also select the language of the titles.

Selecting a Language and setting a TITLE

- ⌘ Selecting a language is possible in STANDBY in CAMERA mode only.
 - ⌘ The factory default language is ENGLISH.
You can change the language.
1. Make sure that you have installed the LITHIUM BATTERY or have the adaptor attached. (see page 17)
 2. Set power switch to CAMERA mode. (see page 18)
 - Open the LCD monitor and adjust it so that you can see comfortably.
 3. Press MENU ON/OFF button.
Then the MENU list will appear.
 4. Turn the UP/DOWN dial until TITLE SET is highlighted.
 5. Press ENTER.
 - A list of available languages will appear.

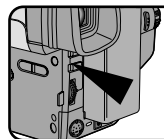

MENU
LCD ADJUST
DIS OFF
D ZOOM OFF
PIP OFF
DISPLAY ON
WHITE BAL AUTO
WL.REMOCON ON
EXIT: MENU

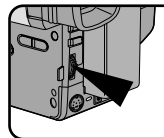

MENU
CUSTOM SET
CLOCK SET
TITLE SET
TITLE OFF
D/TITLE COLOUR ..WHITE
C.RESET 0:00:00
DEMO OFF
EXIT: MENU

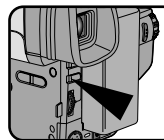

LANGUAGE SELECT
ENGLISH [HAVING FUN]
FRENCH
GERMAN
ITALIAN
SPANISH
RUSSIAN
EXIT: MENU

Advanced Shooting

6. Turn the UP/DOWN dial to select the appropriate language.
 - You may select languages from ENGLISH/FRENCH/GERMAN/ITALIAN/SPANISH/RUSSIAN.
7. Press ENTER.
 - Then, the title list in the language you chose will appear.
8. Turn UP/DOWN dial to whichever TITLE you desire.
9. Press ENTER.
 - The selected title will appear on the screen for 2 ~ 3 seconds and will disappear. At the same, the camcorder will return to the menu mode.



ENGLISH [HAVING FUN]
 FRENCH
 GERMAN
 ITALIAN
 SPANISH
 RUSSIAN



ANNIVERSARY
 CONGRATULATIONS
 GRADUATION
 HAPPY BIRTHDAY
 HAPPY NEW YEAR
 HAVING FUN

Recording a Title

Note: ■ Make sure that you have selected a TITLE.

1. Set power switch to CAMERA mode.
 - Open the LCD monitor and adjust it to see comfortably.
2. Press MENU.
3. Turn the UP/DOWN dial until TITLE.....OFF is highlighted.
4. Press ENTER to choose between OFF, AUTO-10S and CONTINUE.
5. Press START/STOP button to record the title with your picture.
 - If you want to change recording time, select title recording time (OFF, AUTO-10S, CONTINUE) on MENU.

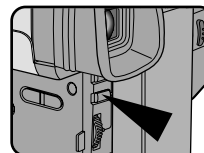

MENU
 CUSTOM SET
 CLOCK SET
 TITLE SET
 TITLE.....CONTINUE
 D/TITLE COLOUR ..WHITE
 C.RESET0:00:00
 DEMOOFF
 EXIT: MENU

Notes: ■ The title moves horizontally from the right side to the left side 10 seconds after you turn on the title.
 ■ MENU ON/OFF function will not operate in EASY or REC mode.

Advanced Shooting

Fade In and Out

- ⌘ The FADE function only works in CAMERA mode.
- ⌘ You can give your films a professional look by using special effects such as fade in at the beginning of a sequence or fade out at the end of a sequence.

To Start Recording

1. Before shooting, hold down the FADE button. The picture and sound gradually disappear (fade out).
2. Press the START/STOP button and at the same time release the FADE button. Recording starts and the picture and sound gradually appear (fade in).

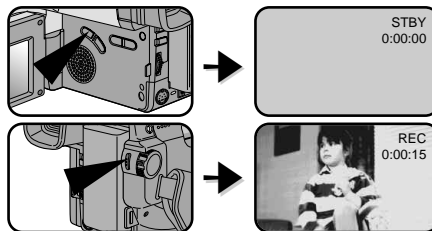

To Stop Recording (use FADE IN / FADE OUT)

3. When you wish to stop recording, hold down the FADE button. The picture and sound gradually disappear (fade out).
4. When the picture has disappeared, press the START/STOP button to stop recording.

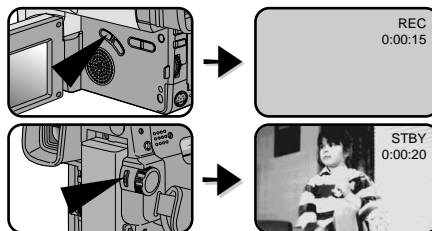

a. FADE OUT
(Approx. 4 seconds)

Press the FADE button

a. FADE OUT

Gradual disappearance



b. FADE IN
(Approx. 4 seconds)

Gradual appearance

b. FADE IN

Release the FADE button

Advanced Shooting

PIP (Picture-In-Picture, VP-L850/L850D/L870 only)

- ⚙ The PIP(Picture-In-Picture) feature works in combination with the DIGITAL ZOOM function by using a small, super imposed screen to show an image that is wider than the image being shot.
This should help you to get a clear idea of what you are recording.
 - The PIP function only works in CAMERA mode.
1. Set the power switch to CAMERA mode.
 2. Turn on the DIGITAL ZOOM. (see page 31)
 3. Press the MENU ON/OFF button, the MENU List will be displayed.
 4. Turn the UP/DOWN dial until PIP.....OFF is highlighted.
 5. Press ENTER, the PIP ON and a small screen should appear.
 6. Check which part you are shooting on the PIP screen, and move the Zoom button to the "T" position to activate the DIGITAL ZOOM mode.
 - Start recording by pressing the START/STOP button when the portion you want to shoot appears.
 7. Setting PIP.....ON to OFF in the MENU will make the small screen disappear and switch the PIP mode off.

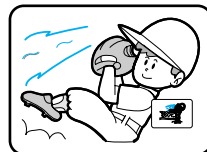
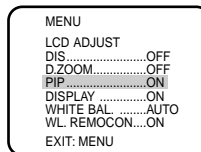
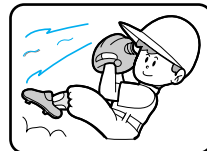
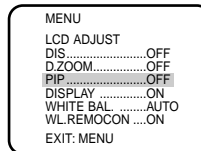
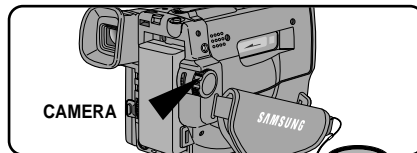

- Notes:**
- The PIP screen will be recorded if it is activated while recording.
 - The MENU ON/OFF function will not operate in EAS or REC mode.
 - PIP function will not operate in DSE mode.

Advanced Shooting

Snap Shot (VP-L850/L850D/L870only)

- ⚙ With the SNAP SHOT feature, your camcorder can function like a normal film camera, allowing you to take single still pictures.
- The SNAP SHOT function only operates in CAMERA mode.

1. Set the power switch to CAMERA mode.

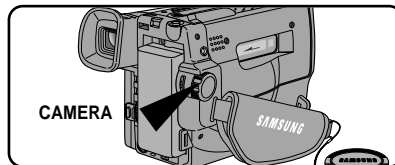

2. Press the SNAP SHOT button when you have the image you wish to photograph in the shot.

- Be careful not to shake your camcorder because the image will be affected by any movement.

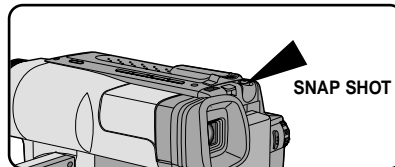

3. Once the SNAP SHOT button has been pressed, your camcorder will automatically return to STANDBY mode after approximately 6 seconds.

- You can check the remaining available SNAP SHOT space by looking at the time displayed on the screen.
- To stop SNAP SHOT shooting, press the SNAP SHOT button again.

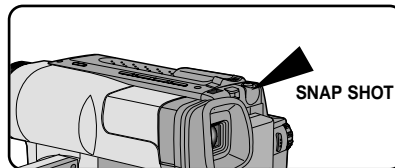

Notes:

- If the camcorder is knocked or shaken while taking a SNAP SHOT, the image may be blurred.
- The SNAP SHOT is activated during shooting.
- The still image will be displayed on the display if the SNAP SHOT button is pressed in CAMERA mode but no tape has been inserted in your camcorder.

Advanced Shooting

White Balance

- ⌘ WHITE BALANCE (WHITE BAL.) is a recording function that preserves the unique colour of the object in any shooting condition.
- ⌘ You may select the appropriate WHITE BALANCE mode to obtain good quality colour of the image.
 - AUTO: This mode is generally used to control the WHITE BALANCE automatically.
 - INDOOR (☀): It controls WHITE BALANCE according to the indoor ambience.
 - OUTDOOR (☀): It controls WHITE BALANCE according to the outdoor ambience.

Setting a White Balance Mode

1. Set the power switch to CAMERA mode.
2. Press the MENU ON/OFF button, the MENU list will be displayed.
3. Turn the UP/DOWN dial until WHITE BAL.AUTO is highlighted.
4. Press ENTER.
 - You can set it to INDOOR (☀) or OUTDOOR (☀) by pressing the ENTER button.
5. Press the MENU ON/OFF button to exit the WHITE BALANCE setting.

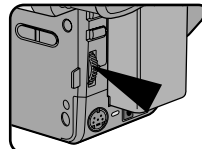

```

MENU
LCD ADJUST
DIS.....OFF
D.ZOOM.....OFF
PIP.....OFF
DISPLAY.....ON
WHITE BAL.....AUTO
WL.REMOCON...ON
EXIT: MENU
  
```

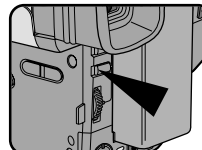

```

MENU
LCD ADJUST
DIS.....OFF
D.ZOOM.....OFF
PIP.....OFF
DISPLAY.....ON
WHITE BAL.....AUTO
WL.REMOCON...ON
EXIT: MENU
  
```

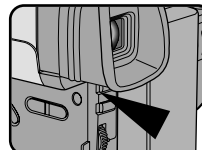

```

MENU
LCD ADJUST
DIS.....OFF
D.ZOOM.....OFF
PIP.....OFF
DISPLAY.....ON
WHITE BAL.....OUTDOOR:☀
WL.REMOCON...ON
EXIT: MENU
  
```

Note: The MENU ON/OFF function will not operate in EASY or REC mode.

Advanced Shooting

Demonstration

- ⌘ Demonstration automatically shows you the major functions that are included with your camcorder so that you may use them more easily.
- ⌘ The DEMO function is only available in CAMERA mode when tape is not in the camcorder.
- ⌘ The Demonstration operates repeatedly until the POWER switch is set to OFF.

1. Set the power switch to CAMERA mode.
2. Press MENU ON/OFF button, then the MENU list will appear.

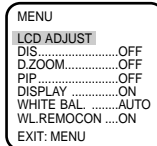
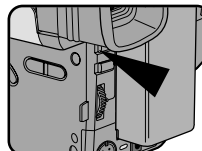

3. Turn the UP/DOWN dial until DEMO is highlighted.

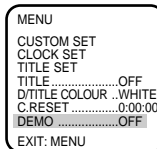
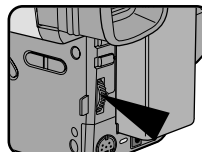

4. Press ENTER to select ON.
 - Demonstration will start.

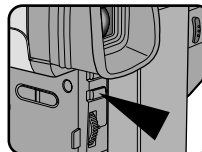

5. Set the POWER switch to OFF to end the Demonstration.

Note: The MENU ON/OFF function will not operate in EASY or REC mode.

Advanced Recording

Setting the Date/Title Colour

1. Set the power switch to CAMERA mode. (see page 22)
2. Press the MENU ON/OFF button.
 - The MENU list will appear.
3. Turn the UP/DOWN dial to D/TITLE COLOUR.....WHITE.
4. Press ENTER.
 - A list of available colour will appear.
5. Turn the UP/DOWN dial to select the appropriate colour.
6. Press ENTER.
7. Press the MENU ON/OFF button to end setting.
 - The Title and Date/Time will appear in the colour you chose.



```

MENU
LCD ADJUST
DIS.....OFF
D.ZOOM.....OFF
PIP.....OFF
DISPLAY.....ON
WHITE BAL.....AUTO
WL.REMOCON.....ON
NEXT: MENU
  
```

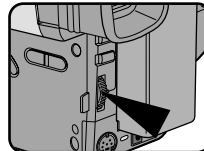

```

MENU
CUSTOM SET
CLOCK SET
TITLE SET
TITLE.....OFF
D/TITLE COLOUR..WHITE
C.RESET.....0:00:00
DEMO.....OFF
EXIT: MENU
  
```

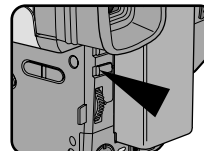

```

DATE/TITLE COLOUR SELECT
[WHITE]
WHITE
YELLOW
CYAN
MAGENTA
RED
GREEN
BLUE
EXIT: MENU
  
```

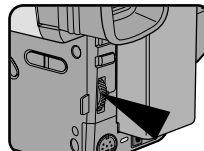

```

DATE/TITLE COLOUR SELECT
[YELLOW]
WHITE
YELLOW
CYAN
MAGENTA
RED
GREEN
BLUE
EXIT: MENU
  
```

Advanced Shooting

Lighting Techniques

- ⌘ When you use your camcorder, there are normally only two main recording environments.
 - You will be shooting outdoors (Normal recording or through an ND(Neutral Density) filter).
 - You will be shooting indoors (Video light recommended or required).
- ⌘ The single greatest influence on picture quality is the level of brightness, measured in lux.
- ⌘ The following table lists a few common situations, the corresponding level of brightness and any associated recommendations.

Situations	Brightness(lux)	Recommendations
◆ Snow-covered mountains or fields.	100,000	ND filter recommended.
◆ Sandy beach on a hot summer's day.	100,000	"
◆ On a sunny day in the middle of the afternoon.	35,000	Normal recording.
◆ On a gloomy day, an hour after the sunrise.	2,000	"
◆ Office with fluorescent lighting near to a window.	1,000	"
◆ On a sunny day, an hour before the sunset.	1,000	"
◆ Department store counter.	500 to 700	"
◆ Room lit by two 30W fluorescent lights.	300	Video light recommended.
◆ Arcade at night.	150 to 200	Video light required.
◆ Candle light.	10 to 15	"

After Shooting

1. Eject the tape that you have shot. (see page 22)
2. If you want to protect the tape against accidental erasing, move the red tab on the cassette over the hole.
3. Set the POWER switch to OFF.
4. Close the LENS cover.
5. Remove the BATTERY PACK from the camcorder.

Playing back the Tape

- ⌘ To view a tape that you have recorded.
- ⌘ Playback function works in PLAYER mode only.
- ⌘ There are two ways to see a tape;
 - To view on the LCD: recommended for outdoor use.
 - To view on a TV monitor: recommended for indoor use.

Viewing on the LCD display

- ⌘ It is practical to view a tape using the LCD display if away from a tv or outdoors. (see page 28)

Viewing on a TV monitor

- ⌘ It is better to use a TV monitor to view tapes indoors.
- ⌘ To play a tape back, the TV must feature a compatible colour system. (see page 63)

Connecting to a TV which has an Audio and Video input jack

- ⌘ Use the Audio/video cable supplied with your camcorder.
 - The yellow one: Video
 - The white one: Audio(L)
- ⌘ You can use a SCART adapter, supplied optionally.
- ⌘ If provided, a SCART adapter would be one of the following two types.
 - Stereo type
 - Mono type

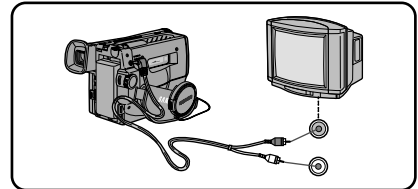

Connecting to a TV which has no Audio and Video input jack

- ⌘ You can connect your camcorder to a TV through a VCR.
 - Set the input selector on the VCR to LINE.
 - The yellow one: Video
 - The white one: Audio(L)
 - You can use a SCART adapter. (supplied optionally)

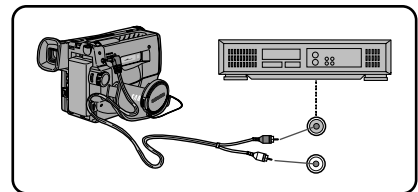

Note: To view the cassette on the television screen, select the channel reserved for your VCR on the television. (Refer to your VCR or television instruction book)

Playing back the Tape

Notes:

- VP-L800U/L800/L850/L850D/L870 feature a monaural audio system.
If your TV or VCR are stereo, connect the audio cable to the input "L" of TV or VCR.
- You can use an S-VIDEO cable to obtain better quality pictures if you have the S-VIDEO connector on your TV.
- Close the LCD panel while viewing playback on a TV screen in order to avoid picture distortion.

Playback

1. Use the TV/VIDEO button to select VIDEO on your TV.
2. Connect a power source (battery or AC Power Adapter) to the camcorder.
Set the power switch to PLAYER mode.
3. Insert the tape you want to watch.
 - Make sure that STOP is displayed.

4. Press the ►|| (PLAY/STILL) button.
 - The picture should appear on the TV after 2 to 3 seconds.
 - Press ■ (STOP) to stop playing.
 - If the tape reaches its end during playback, the tape will rewind automatically.

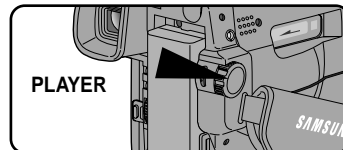

Notes:

- Vibration from the built-in speaker can cause picture distortion.
- It is best to turn the built-in speaker off when your camcorder is connected to the TV.
- The playback system (Hi8/8mm) is selected automatically, depending on the tape format.
- VP-L800/L850/L850D/L870 can playback both Hi8 and 8mm.
- This camcorder does not support LP recording and playback.

Playing back the Tape

Various Functions in PLAYER mode

To view a STILL picture (Playback pause)

- Press ►|| (PLAY/STILL) button during playback.
- To resume playback, press ►|| (PLAY/STILL) button again.

Note: Your camcorder will automatically stop if it is left for more than 5 minutes in STILL mode without operation in order to prevent tape and head-drum wear.

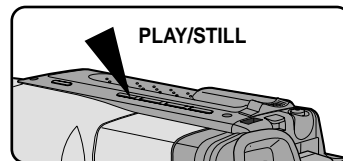

To locate a scene (picture search)

- Press ►► (FF) or ◀◀ (REW) buttons during playback.
- To resume normal playback, release the buttons.

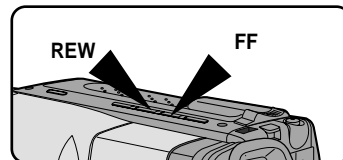

Zero RETURN (VP-L850/L850D/L870)

- ☞ The ZERO RETURN function works in STOP of PLAYER mode.
- ☞ You can Fast Forward or Rewind to 0:00:00 automatically.

1. Set the power switch to PLAYER mode.
 - Make sure that STOP is displayed.
2. Press the Z.RTN button of the Remote Controller.
 - Z.RTN should displayed.
 - FF or REW works automatically.

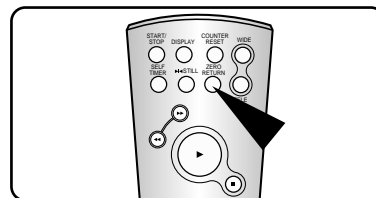

Notes:

- The Z.RTN button does not work when the TAPE COUNTER reads 0:00:00.
- Set the COUNTER RESET to "C.RESET 0:00:00" in MENU mode at the start of the cassette or the required sequence.

When you wish to find this point on the tape again, press Z.RTN button when playback is stopped.

Playing back the Tape

Adjusting the LCD

- ⚠ The procedure for adjusting the LCD display in **PLAYER** mode is the same as the procedure for adjusting the LCD display in **CAMERA** mode, except that the power switch must be set to **PLAYER** instead of **CAMERA**. Please refer to page 26.

Setting the Speaker ON/OFF

- ⚠ The speaker will be turned ON/OFF by opening/closing the LCD.
- ⚠ The speaker ON/OFF setting operates when the LCD is opened. When the **SPEAKER** setting is set to **OFF**, the speaker will be muted even after the LCD display has been opened.

1. Set power switch to **PLAYER** mode.
2. Press **MENU ON/OFF** button, then the **MENU** list will appear.
3. Turn **UP/DOWN** dial to **SPEAKER**.

4. Press **ENTER** to change the setting.
5. Press the **MENU ON/OFF** button again to exit the setting **SPEAKER** setting screen.

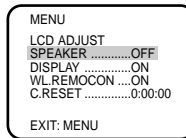
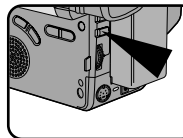
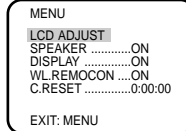
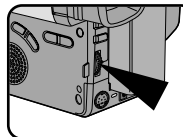

Volume control

- ⚠ The Speakers volume can be controlled by turning the **UP/DOWN** dial during playback.

Note: The volume cannot be changed while the **MENU** list is visible.

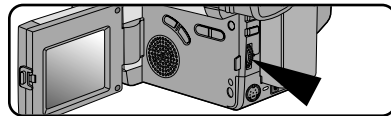

Playing back the Tape

DSE in PLAYER mode

- ⌘ The procedure for using DSE in PLAYER mode is the same as the procedure for using DSE in CAMERA mode, except that the power switch must be set to PLAYER instead of CAMERA. Please refer to pages 40 and 41.
- Note:** The GHOST, STROBE, NEG., MIRROR, MOSAIC, CINEMA and 16:9(WIDE) effects will not operate when your camcorder is in PLAYER mode.
- ⌘ Pressing the DSE button will scroll through the available settings. Stop at the one you require.

Maintenance

Cleaning and Careing for your Camcorder

Cleaning the Viewfinder

◆ Releasing the Eyepiece

1. Pull the viewfinder up and turn the screw counter- clock-wise.
2. Pull the eyepiece away from the viewfinder.
3. Clean the Eyepiece and the VIEWFINDER screen with a soft cloth and cotton swab or a blower.

◆ Reattaching the Eyepiece

4. Replace the Eyepiece on the VIEWFINDER.
5. Replace and tighten the screw.

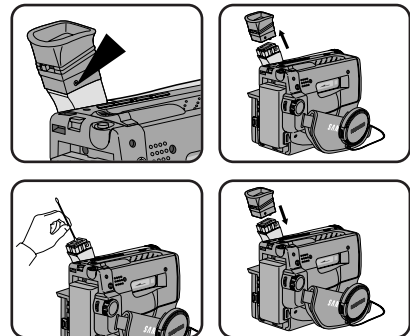

Cleaning the LCD panel

Open the LCD display panel and wipe it gently with a soft cloth. Be careful not to damage the display.

Maintenance

Cleaning the Video Heads

- ☞ To ensure normal recording and clear pictures, clean the video heads.
- ☞ When the playback pictures are noisy or hardly visible, the video heads may be dirty.

- a. Normal Picture
 b, c. Noisy Picture
 If this happens, clean the video heads with a dry type head cleaning cassette.

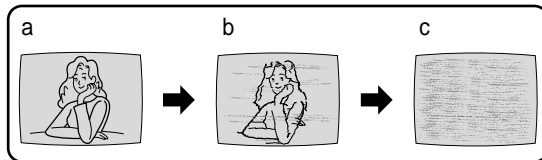

1. Set the power switch to PLAYER mode.
2. Insert the cleaning tape.
3. Press the ►|| (PLAY/STILL) button.
4. Press the ■ (STOP) button after about 30 seconds.

Check the quality of the picture using a video cassette. If it is still bad, repeat the operation.
 If the problem continues, contact your local authorized service centre.

Storing the Camcorder

1. You must detach the BATTERY PACK from the camcorder when storing.
2. Keep the camcorder in a ventilated, dry and warm place.
3. Do not keep the camcorder in a place where the temperature often changes, such as in a car.
4. Keep the camcorder in a stable place.

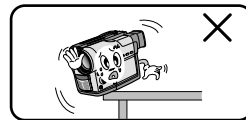
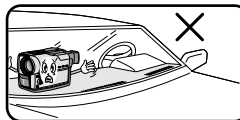
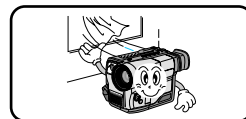
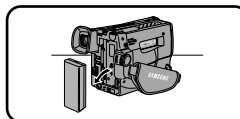

USB interface (VP-L870 only)

● Transferring a Digital Image through a USB Connection

- ⌘ You can easily transfer a still image from a camera, tape, memory to a PC without additional add-on cards via a USB connection.
- ⌘ You can transfer an image to a PC via a USB connection.
- ⌘ If you transfer data to a PC, you need to install the software (Driver, Editing software) supplied with the camcorder.

System Requirements

- CPU : Intel® Pentium II™ processor compatible or better
- Operating system : Windows® 98/98SE/ME/2000/XP
- RAM : 64 MB or more
- CD-ROM: 4x CD-ROM drive
- VIDEO : 65,000-colour or better video display card
- Available USB port
- Hard Disc : 4GB (8GB recommended)

Notes:

- Intel® Pentium II™ is a trademark of the Intel Corporation.
- Windows® is a registered trademark of the Microsoft® Corporation.
- All other brands and names are property of their respective owners.

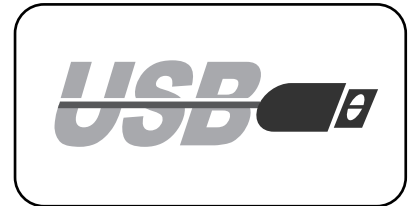

USB interface (VP-L870 only)

Installing USB Media 2.0 Program

- ⌘ Do not connect the camcorder to PC before installing the program.
- ⌘ If another camera or scanner is connected, please disconnect it in advance.
- ⌘ This explanation is based on Windows® 98SE OS.

How to install the program

1. The install program automatically operate when the CD is inserted into CD-ROM.



Note:

If the install program does not operate, please double click Install.exe in CD-ROM Drive.

2. Click  to install the program.
3. Follow the instruction to install.

USB interface (VP-L870 only)

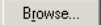
4. The below window displays the folder to install the program.
 - Basically the program is installed in the following folder.
C:\Programfiles\Samsung\USB Media 2.0
 - Click  to change the folder.

5. Connect the camcorder to PC.
6. PC finds a new hardware and install a driver automatically.
7. If the driver is installed, the install is completed.
8. Execute USB Media 2.0 player on the Windows wall paper.

Note:

- USB Media 2.0 User's Manual is included on the accompanying CD in Adobe's Portable Document Format (PDF). The user's manual can be viewed using Acrobat Reader software, which is also included on the CD. (The Acrobat Reader is a freeware product of Adobe Systems, Inc.)

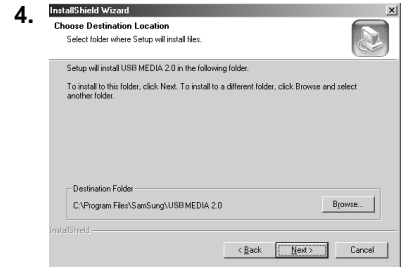

USB interface (VP-L870 only)

Connecting to a PC

1. Connect a USB cable to the USB port on the PC.
2. Connect the other end of the USB cable into the proper terminal on the camcorder. (USB jack)
3. Connect the audio cable to the Line input jack of the PC.
If the PC has no Line input jack, connect the audio cable to the MIC input jack.
In this case, however, a noise may be produced depending on the PC.

Notes:

- If you disconnect the USB cable from the PC or the camcorder while transferring, the data transmission will stop and the data may be damaged.
- If you connect the USB cable to a PC via a USB HUB or simultaneously connect the USB cable along with other USB devices, the camcorder may not work properly.
 - In this case, remove the other USB devices from the PC and reconnect the camcorder.

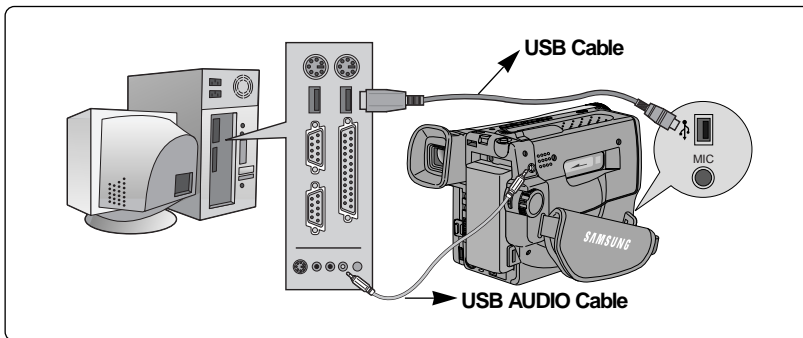

Using Your Camcorder Abroad

Using Your Camcorder Abroad

- ⌘ Each country or area has its own electric and TV colour system.
- ⌘ Before using your camcorder abroad, check the following:

Power sources

- You can use your camcorder in any country or area that uses 100V to 240V, 50/60 Hz.
- Where necessary, use a commercially available AC plug adapter, depending on the power used.

Colour system

- You can view your recording on the LCD or viewfinder.
However, to view a recording on a television or to make a copy to a video cassette recorder, the television or VCR must be PAL: VP-L800U/L800/L850/L850D/L870- compatible and have the appropriate audio/video jacks.

❖ PAL-compatible area

Australia, Austria, Belgium, Bulgaria, China, CIS, Czech Republic, Denmark, Egypt, Finland, France, Germany, Greece, Great Britain, Holland, Hong Kong, Hungary, India, Iran, Iraq, Kuwait, Libya, Malaysia, Mauritius, Rumania, Saudi Arabia, Singapore, Slovak Republic, Spain, Sweden, Switzerland, Syria, Thailand, Tunisia, etc.

❖ NTSC-compatible area

Bahamas, Canada, Central America, Japan, Mexico, Philippines, Korea, Taiwan, United States, etc.



Note: You can make recordings with your camcorder anywhere in the world and you can watch the playback picture on the LCD.

Troubleshooting Check

Troubleshooting Check

- ⌘ Before contacting a service centre, perform the following simple checks. They might save you the time and expense of an unnecessary call.

Self Diagnosis Display

Display	Blinking	Inform that...	Action
	slow	the battery pack is almost discharged.	Exchange it with a charged one.
	fast	the battery pack is fully discharged.	Exchange it with a charged one.
TAPE END!	slow	the tape has almost reached its end.	Prepare a new one.
TAPE END!	no	the tape reached its end.	Change to a new one.
TAPE!	slow	there is no tape in the camcorder.	Insert a tape.
PROTECTION!	slow	the tape is protected from recording.	Check the red tab on the tape is not pushed over the hole.
D.EMG C.EMG R.EMG L.EMG	slow	the camcorder has some mechanical fault.	<ol style="list-style-type: none"> 1. Eject the tape. 2. Set to OFF. 3. Detach the battery. 4. Reattach the battery. <p>* Please contact your local service centre if the problem continues.</p>
	slow	moisture condensation has formed in the camcorder.	see page 67.

Troubleshooting Check

Checking

- ⌘ If you run into any problem using the camcorder, use the following table to try to resolve the problem.
- ⌘ If these instructions do not allow you to solve the problem, take a note of:
 - The model and serial number marked on the bottom of the camcorder.
 - Your warranty, if applicable.
- ⌘ Then contact your nearest authorized service centre.

Symptom	Explanation/Solution
You cannot switch the camcorder on.	<ul style="list-style-type: none"> ◆ Check the battery pack (see page 19) or the AC power adapter. (see page 18)
Start/Stop does not operate while shooting.	<ul style="list-style-type: none"> ◆ Check the POWER, set it to CAMERA. ◆ You have reached the end of the cassette. ◆ Check the record protection tab on the cassette. (see page 22)
The camcorder goes off automatically.	<ul style="list-style-type: none"> ◆ You have left the camcorder set to STANDBY for more than 5 minutes without using it. (see page 24) ◆ The battery pack is fully used up. (see page 21)
The battery pack is quickly exhausted.	<ul style="list-style-type: none"> ◆ The atmospheric temperature is too low. (see page 21) ◆ The battery pack has not been charged fully. (see page 19) ◆ The battery pack is completely dead, and cannot be recharged. Use another battery pack.
You cannot eject the cassette from the compartment.	<ul style="list-style-type: none"> ◆ The battery pack is fully discharged. ◆ A mechanical fault may have occurred. (see page 64)
The DATE/TIME indicator flashes more than 2 times when you set the camcorder to CAMERA.	<ul style="list-style-type: none"> ◆ The lithium battery is not installed or is fully used up. (see page 17)
The playback picture is in poor quality.	<ul style="list-style-type: none"> ◆ The video heads might be dirty. (see page 58)
You can do nothing with the camcorder.	<ul style="list-style-type: none"> ◆ A mechanical fault may have occurred. (see page 64)

Troubleshooting Check

Symptom	Explanation/Solution
A vertical stripe appears when you shoot a bright subject against a dark background. (candle flame, for example)	◆ The contrast between the subject and the background is too great for the camcorder to operate normally. Make the background bright to reduce the contrast or use the BLC function while you are shooting. (see page 37)
The LCD image is poor.	◆ It is recommended that you use the VIEWFINDER when shooting in bright sunlight. (see page 7) ◆ Adjust the LCD (see page 26)
The image in the viewfinder is blurred.	◆ The viewfinder lens has not been adjusted. Turn the viewfinder focus ring until the screen comes into sharp focus. (see page 27)
The tape does not move when you press the Play, Fast Forward or Rewind buttons.	◆ Set the POWER switch to PLAYER. ◆ You have reached the beginning or end of the cassette.
The picture does not appear in the viewfinder.	◆ The LCD display is open.
There is no sound from the SPEAKER when playing back the tape.	◆ Make sure the SPEAKER is ON. (see page 56)
The Date Time or Title disappeared even though you had it set.	◆ The lithium battery is not installed or is fully used up. (see page 17)

Troubleshooting Check

Moisture Condensation

- ⚠ If the camcorder is brought directly from a cold place to a warm place, moisture may form inside the camcorder, on the surface of the tape, or on the lens. In this condition, the tape may stick to the head drum and be damaged or the unit may not operate correctly.

To prevent possible damage under these circumstances, the camcorder has the built-in moisture sensor.

- ⚠ If there is moisture inside the camcorder, "DEW ()" is displayed. If this happens, none of the functions except cassette ejection will work. Open the cassette compartment and remove the battery for at least two hours in a warm dry room. If the DEW protection feature is unexpectedly activated and you want to override it: (Please make sure that the condensation has disappeared completely.)

1. Remove the battery pack.
2. Remove the lithium battery.
3. Put the lithium battery back.
4. Re-fit the battery pack.

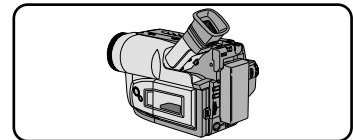
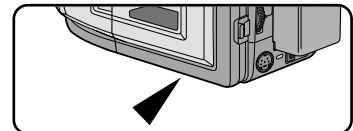
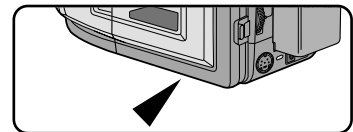
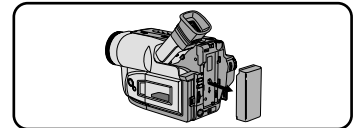
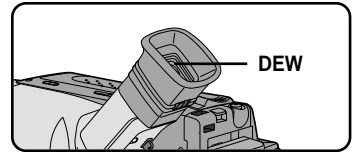

Specifications

⌘ The design and technical specifications may be changed without notice.

System	VP-L800U/L800/L850/L850D/L870
Recording system	Video: 2 rotary heads Helical scanning FM Audio: FM monaural system
Video signal	PAL colour, CCIR standard
Usable cassette	VP-L800U: 8mm VP-L850/L850D/L870: Hi8 or 8 mm
Tape speed	SP: 20.051 mm/sec
Speed mode	Record: SP only Playback: SP only.
Recording time	P5-120: 120 min.
FF or REW time	P5-120: approx. 8 min.
Image device	CCD (Charge Coupled Device)
Optical zoom ratio	22x
Focal length: f	3.6-79.2 mm
F	1.6
Filter diameter	46 mm
Focus system	Inner
Macro	Auto wide macro
Min. Illumination	0.3 lux (visible)
LCD monitor	
Size/Picture cell	2.5 inch/123k
Method	TFT
Connectors	
Video out	Mini jack, 1 Vp-p, 75 ohms, Unbalanced
Audio out	Mini jack, 7.7 dBs, imp.: less than 820 ohms
External mic	Monaural ø3.5 (VP-L850/L850D/L870)
General	
Power requirements	DC 8.4 V (1.5 A)
Power consumption	VP-L800U/L800 : 5.4W, *Recording, LCD ON VP-L850/L850D/L870 : 5.9W
Built-in mic	Condenser mic, omni-directional
Built-in speaker	Dynamic, 0.5 W standard
Operating temperature	0°C to 40°C (32°F to 104°F)
Dimension (W * H * D)	101 * 104 * 174 mm
Weight	780 g

Index

- A -

ABROAD	63
AC POWER ADAPTER.....	18
ADJUST (LCD)	26
AF.....	36
AUDIO	53
AUTO FOCUSING	36
AUTO MODE.....	38
AUTO POWER OFF.....	24

- B -

BATTERY	19
BATTERY LEVEL	21
BATTERY PACK.....	19
BLC	37
BRIGHTNESS.....	26

- C -

CAMERA.....	18
CASSETTE	22
CASSETTE HOLDER	11
CLEANING	58
COLOUR (LCD)	26
CONTENTS	2
COUNTER	55
CUSTOM.....	34

- D -

DATE	42
DATE/TIME.....	42
DC CABLE	18
DEMO	50
DEW	67
DIGITAL ZOOM.....	31
DIMENSION.....	68
DIS	35
DISPLAY	12
DSE.....	40

- E -

EASY	33
EJECT.....	22
ENTER button.....	26
EXTERNAL MIC	68

- F -

FADE IN	46
FADE OUT	46
FF (FAST FORWARD)	55
FILTER DIAMETER	68
FOCAL LENGTH	68

- G -

GHOST	40
-------------	----

- H -

HAND STRAP	16
Hi8.....	54

- L -

LCD	26
LENS.....	9
LITHIUM BATTERY.....	17

- M -

MIRROR.....	40
MOISTURE	67
MOSAIC	40

- N -

ND FILTER.....	52
NEG	40
NTSC	63

Index

- O -

OPERATION MODE.....	13
OSD	12

- P -

PAL	63
PIP	47
PLAY	55
PLAYER	55
PORTRAIT MODE	38
POWER CONSUMPTION.....	68
POWER REQUIREMENT	68
PROGRAM AE	38

- R -

RECHARGING	19
REC SEARCH	24
REMOTE CONTROL	15
REW (REWIND)	55

- S -

SAFETY INSTRUCTION.....	4
SAND/SNOW MODE	38
SELF-30S.....	15
SELF-END	15
SELF DIAGNOSIS	64
SELF RECORD.....	15
SELF TIMER	15
SEPIA.....	40
SHOOTING	23
SHOULDER STRAP	17
SNAP SHOT	48
SPEAKER	56
SPECIFICATION	68
SPORTS MODE.....	38
SPOTLIGHT MODE	38

START/STOP	23
STILL	55
STOP	54
STROBE	40
SYSTEM	68
S-VIDEO	54

- T -

TAPE COUNTER	13
TAPE EJECT	22
TAPE END.....	64
TIME.....	42
TITLE	45
TROUBLE CHECK.....	65
TV MONITOR.....	53

- V -

VIDEO	53
VIDEO HEAD	58
VOLUME	56

- W -

WAIT-10S	15
WEIGHT	68
WHITE BALANCE.....	49

- Z -

ZERO RETURN	55
ZOOM	30

Power Sources (United Kingdom Only)

The main lead on the power adapter is supplied with a molded plug incorporating a fuse.

The value of the fuse is indicated on the pin face of the plug, and if it requires, replacing a fuse approved to BS1362 of the same rating must be used.

Never use the plug with the fuse cover omitted if the cover is detachable.

If a replacement fuse cover is required, it must be of the same colour as the pin face of the plug.

Replacement covers are available with your dealer.

If the fitted plug is not suitable for the power points in your house or the cable is not long enough to reach a power point, you should obtain a suitable safety approved extension lead or consult your dealer for assistance.

However, if there is no alternative to cut off the plug, remove the fuse and then safely dispose of the plug. DO NOT connect the plug to a main socket as there is a risk of shock hazard from the bared flexible cord.

IMPORTANT

The wires in the main lead are coloured in accordance with the following code:

BLUE = NEUTRAL BROWN = LIVE

As these colours may not correspond to the coloured markings identifying the terminals in your plug, proceed as follows:

The BLUE wire must be connected to the terminal marked with the letter N or coloured BLUE or BLACK.

The BROWN wire must be connected to the terminal marked with the letter L or coloured BROWN or RED

WARNING

Do not connect either wire to the earth terminal marked with the letter E or the earth symbol, \perp , or coloured GREEN or GREEN and YELLOW.

NOTE

This page is applicable to Great Britain only.

THIS CAMCORDER IS MANUFACTURED BY:



***Samsung Electronics' Internet Home Page**

United Kingdom	http://www.samsungelectronics.co.uk
France	http://www.samsung.fr
Australia	http://www.samsung.com.au
Germany	http://www.samsung.de
Sweden	http://www.samsung.se
Poland	http://www.samsung.com.pl
Spain	http://www.samsung.es
Italia	http://www.samsung.it

AD68-00607F

Free Manuals Download Website

<http://myh66.com>

<http://usermanuals.us>

<http://www.somanuals.com>

<http://www.4manuals.cc>

<http://www.manual-lib.com>

<http://www.404manual.com>

<http://www.luxmanual.com>

<http://aubethermostatmanual.com>

Golf course search by state

<http://golfingnear.com>

Email search by domain

<http://emailbydomain.com>

Auto manuals search

<http://auto.somanuals.com>

TV manuals search

<http://tv.somanuals.com>