

# SANYO

## VCC-6570P

### INSTRUCTION MANUAL BEDIENUNGSANLEITUNG MANUEL D'INSTRUCTIONS 使用说明书

COLOUR CCD camera  
CCD-Farbkamera  
Caméra CCD COULEUR  
彩色CCD摄像机

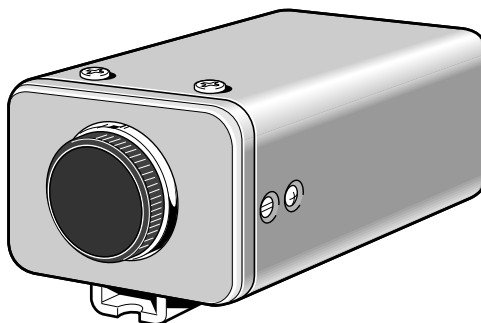

#### About this manual

Before installing and using the camera, please read this manual carefully. Be sure to keep it handy for later reference.

#### Über diese Bedienungsanleitung

Lesen Sie bitte vor der Montage und dem Inbetriebnehmen der Kamera zuerst diese Bedienungsanleitung sorgfältig durch und bewahren Sie sie zum späteren Nachschlagen auf.

#### A propos de ce manuel

Avant d'installer et d'utiliser la caméra, veuillez lire ce manuel attentivement. Gardez-le à portée de main pour toute référence ultérieure.

#### 关于本说明书

在安装和使用摄像机之前，请仔细阅读本使用说明书，并务必保存好本使用说明书，以备今后查阅。

Depending on the conditions of use, installation and environment, please be sure to make the appropriate settings and adjustments. If you need help with installation and/or settings, please consult your dealer.

## CONTENTS

PRECAUTIONS.....	2
PARTS NAMES.....	3
CONCERNING AUTO-IRIS LENSES.....	6
MOUNTING THE LENS.....	7
CONNECTIONS.....	9
SETTINGS.....	11
TROUBLESHOOTING.....	16
SPECIFICATIONS.....	17

## ACCESSORIES

① Lens iris plug (4-pin).....	1 pc.
② Clamping core A.....	1 pc.
③ Clamping core B.....	2 pc.
④ Clamping core C.....	1 pc.

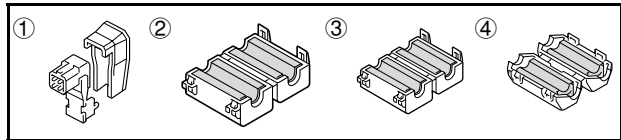

## FEATURES

- Built-in interline transfer method 1/3" CCD, approx. 470,000 picture elements
- Equipped with a DSP (Digital Signal Processor) function
- Horizontal resolution, more than 520 TV lines
- High sensitivity, minimum required illumination is 1.0 lux (F1.2)
- Two types of backlight compensation functions (multi-spot photometry and center focus photometry)
- Low smear, anti-blooming, low lag, no burning and no geometric distortion using the CCD solid state image device.
- 100% solid state components giving excellent immunity to shock and vibration
- Not subject to interference from magnetic or electrostatic fields
- Power supply: 220 – 230 V AC operation

# PRECAUTIONS

---

## ■ In case of problem

Do not use the camera if smoke or a strange odour comes from the unit, or if it seems not to function correctly. Disconnect the power cord immediately, and consult your dealer (or a Sanyo Authorized Service Centre).

## ■ Do not open or modify

Do not open the cabinet, as it may be dangerous and cause damage to the unit. For internal settings and repairs, consult your dealer (or a Sanyo Authorized Service Centre).

## ■ Do not put objects inside the unit

Make sure that no metal objects or flammable substance get inside the camera. If used with a foreign object inside, it could cause a fire, short-circuits or damages.

If water or a liquid gets inside the camera, disconnect the power cord immediately, and consult your dealer (or a Sanyo Authorized Service Centre). Be careful to protect the camera from rain, sea water, etc.

## ■ Be careful when handling the unit

To prevent damages, do not drop the camera or subject it to strong shock or vibration.

## ■ Install away from electric or magnetic fields

If installed close to a TV, radio transmitter, magnet, electric motor, transformer, audio speakers the magnetic field they generate will distort the image.

## ■ Protect from humidity and dust

To prevent damages to the camera, do not install it where there is greasy smoke or steam, where the dampness may get too high, or where there is a lot of dust.

## ■ Protect from high temperatures

Do not install close to stoves, or other heat generating devices, such as spotlights, etc., or where it could be subject to direct sunlight, as that could cause deformation, discoloration or other damages.

Be careful when installing close to the ceiling, in a kitchen or boiler room, as the temperature may raise to high levels.

Install where the temperature range will stay between  $-10^{\circ}\text{C}$  and  $50^{\circ}\text{C}$ .

(no condensation)

## ■ Cleaning

- Dirt can be removed from the cabinet by wiping it with a soft cloth. To remove stains, wipe with a soft cloth moistened with a soft detergent solution and wrung dry, then wipe dry with dry soft cloth.
- Do not use benzine, thinner or other chemical product on the cabinet, as that may cause deformation and paint peeling. Before using a chemical cloth, make sure to read all accompanying instructions. Make sure that no plastic or rubber material comes in contact with the cabinet for a long period of time, as that may cause damage or paint peeling.

# PARTS NAMES

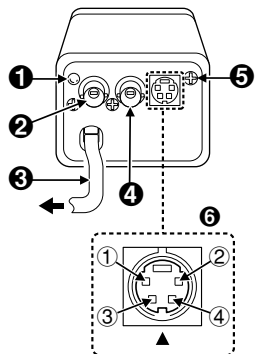

## ❶ Power indicator (POWER)

Comes on when the power to the camera is on.

## ❷ Video output connector (VIDEO OUT: BNC type)

Connect this connector to a device such as a VCR or monitor with a **VIDEO IN** connector.

## ❸ AC power cord

## ❹ External sync composite video signal input connector (VBS IN: BNC type)

Connect to this connector the synchronizing signal output from a synchronizing signal device or the composite signal of a video distributor.

## ❺ Line phase adjustment volume (LINE PHASE)

When using two cameras or more, the image on the monitor may roll vertically when switching sources. This rolling can be minimized by turning this volume.

## ❻ Y/C OUT connector (4 pin)

Separate Y (luminance) and C (chroma) signals are output from this terminal.

A better picture quality is obtained if the monitor or VCR is connected to this connector.

- ❶ Y signal ground
- ❷ C signal ground
- ❸ Y signal: 1.0 Vp-p, 75 ohms, unbalanced, negative sync
- ❹ C signal: 0.3 Vp-p, 75 ohms, unbalanced

# PARTS NAMES

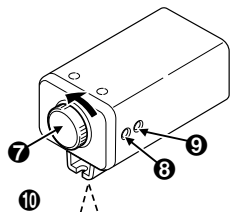

## 7 Lens mount cap

The cap is installed to protect the lens mount section.

Remove the lens mount cap before installing a lens (sold separately).

## 8 Flange-back adjustment screw (FLANGE BACK ADJ.)

## 9 Flange-back lock screw (FLANGE BACK LOCK)

## 10 Camera installation bracket

The bracket can be fixed at the top or bottom of the camera. When fixing the bracket, be sure to use the longer screws and install the shorter screws on the opposite side to seal the openings.

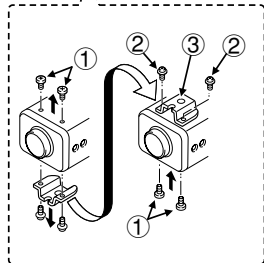

1 Shorter screws: M3 x 4

2 Longer screws: M3 x 6

3 Camera mounting screw hole: 1/4"-20 UNC

### CAUTION:

When installing the camera support, select a location that can support the total weight of the camera and accessories.

# PARTS NAMES

---

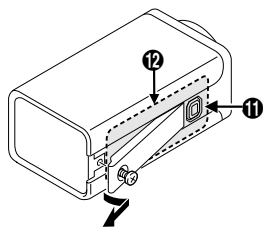

## 11 Lens iris output connector (LENS)

This 4-pin connector is used to send the DC control signal and power supply to an auto-iris type lens.

## 12 Camera setup section (under the cover)

These settings are for when using a 1/3 inch CS mount **DC** (without **EE** internal amplifier) type lens. However, if due to installation conditions or environment the settings may need to be modified for best results (see "**SETTINGS**"). To access the controls, remove the cover fixing screw, then remove the cover.

**NOTE:** When using a 1/2 or 2/3 inch C mount **VIDEO** (with **EE** internal amplifier) auto-iris type lens, set the **A.I. LENS** switch to the **VIDEO** position.

# CONCERNING AUTO-IRIS LENSES

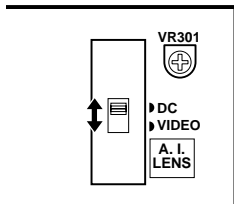

## ■ DC type auto-iris lens

A lens without amplifier circuit that operates only on a DC power source. In general, this type of lens is referred to as DC type coil lens or DC type non-amplifier lens.

(Set the **A.I. LENS** switch to the **DC** position.)

## ■ VIDEO type auto-iris lens

A lens with amplifier circuit that operates on video signal and DC power source. In general, this type of lens is referred to as EE amplifier type lens.

ALC and LEVEL volume level controls are available on the lens for iris adjustments.

(Set the **A.I. LENS** switch to the **VIDEO** position.)

## ■ Compatible auto-iris lenses

1/3 inch Sanyo DC type lens	VIDEO type lens
VCL-CS8LY: Standard angle, $f = 8$ mm	Standard angle, $f = 9$ mm
VCL-CS4LY: Wide angle, $f = 4$ mm	Telephoto angle, $f = 12$ mm
VCL-CS2LY: Ultra-wide angle, $f = 2.8$ mm	Greater telephoto angle, $f = 16$ mm

## ■ If using a VIDEO type auto-iris lens

- Set the **ALC** and **LEVEL** controls on the lens to adjust the iris. Normally the **ALC** volume should be turned all the way to **Av** (Average).
- Depending on the type of lens used, the lens may not perform properly. In such a case, adjust the **LEVEL** volume on the lens casing to correct.

# MOUNTING THE LENS

Please use a DC type auto-iris lens (sold separately).

## Check the lens mount

Do not use a lens if the length "L" is more than 5 mm. That may damage the camera and prevent proper installation.

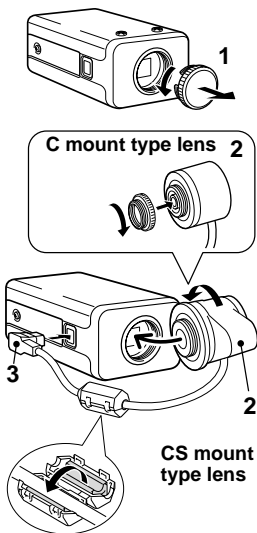
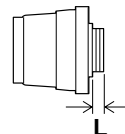

1 Remove the lens mount cap from the camera.

2 Install the auto-iris lens.

### CS mount type lens

Carefully align the lens mount with the camera opening, then turn the lens slowly to install it.

### C mount type lens

To allow for flange-back adjustment, install the C-mount adaptor (option) on the lens mount, then carefully align the lens mount with the camera opening and turn the lens slowly to install it.

3 Connect the lens plug to the lens iris output connector (**LENS**) on the side of the camera.

When using lenses from other makers, the plug shape may not correspond to the terminal on the camera. In such a case, remove the original plug and using a soldering iron, connect the supplied **lens iris plug** according to the diagram. (Refer to page 8.)

**NOTE:** When using an auto-iris lens, the supplied clamping core C must be installed on the lens wire, in order to prevent electromagnetic interference to the other devices connected.



# MOUNTING THE LENS

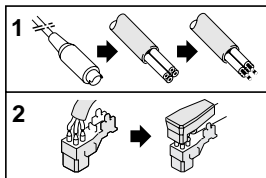

## ■ Rewiring the lens cable in the lens iris plug

### 1 Prepare the lens cable.

Cut the cable at the plug, then remove approx. 8 mm of the cable sheath and strip about 2 mm from each wire.

### 2 Install the lens iris plug.

Solder the cable to the pins following the correct pin layout (refer to the table and illustrations), then close the plug cover.

### Pin layout

	DC type lenses	VIDEO type lenses
①	Brake coil (-)	+12 V DC (50 mA max.)
②	Brake coil (+)	Not used
③	Drive coil (+)	Video output (1.0 V <sub>p-p</sub> , high impedance)
④	Drive coil (-)	Ground (for video signal and DC power)

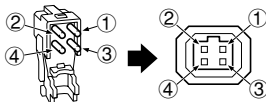

## ■ Flange-back adjustment

If the pick-up surface is not correctly positioned with relation to the lens focal point, the picture will be out of focus (in particular when using auto-iris power zoom lenses, sold separately). If that is the case, adjust the flange-back position as described below.

1 Using a + screwdriver, loosen the **FLANGE BACK LOCK** screw (M2:+).

2 Set the zoom lens to the maximum telephoto position, set the focus using the focus ring on the lens.

3 Set the zoom lens to the maximum wide angle position, set the focus using the **FLANGE BACK ADJ.** screw.

4 Repeat steps 2 and 3, until the image stays in focus when changing from a telephoto shot to a wide angle shot. When the setting is complete, tighten the **FLANGE BACK LOCK** screw.

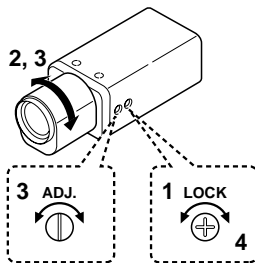

# CONNECTIONS

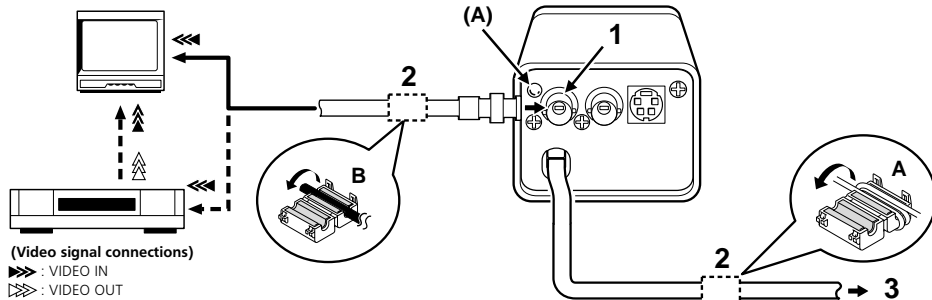

## Basic connection for monitoring or recording

The peripheral devices (VCR, monitor, lens, etc.) and cables are sold separately.

- 1 **Make the video signal connection between the camera and the monitor or time lapse VCR.**
- 2 When using this unit, the supplied clamping core A and B must be installed on the power cord and BNC cable, in order to prevent electromagnetic interference to the other devices connected.
- 3 **Insert the plug of this power cord into a wall outlet.**  
The **POWER** indicator (A) will light. Adjust the picture on the monitor using the Brightness and Contrast controls etc.

### ■ Coaxial cable type and maximum length

- Cable type RG-59U (3C-2V), 250 m maximum.
- Cable type RG-6U (5C-2V), 500 m maximum.
- Cable type RG-11U (7C-2V), 600 m maximum.

### CAUTION:

- The RG-59U type cable should not be run through electrical conduits or through the air.
- Using CCTV/Video-grade coaxial cable.

# CONNECTIONS

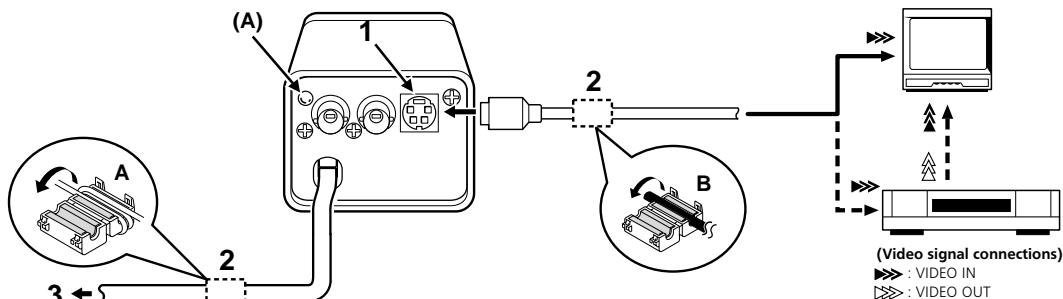

## Connections to the camera Y/C OUT connector

The peripheral devices (VCR, monitor, lens, etc.) and cables are sold separately.

- 1 Using a coaxial cable (twin type, 75 ohms), connect the Y/C OUT connector from the camera to the S-VIDEO input terminal on the monitor or time lapse VCR.
- 2 When using this unit, the supplied clamping core A and B must be installed on the power cord and BNC cable, in order to prevent electromagnetic interference to the other devices connected.
- 3 Insert the plug of this power cord into a wall outlet.  
Then, turn on the power of all the devices connected to the camera.

The **POWER** indicator (A) will light. Adjust the picture on the monitor using the Brightness and Contrast controls.

## CAUTION:

- Please use a monitor with a Y/C or S-VIDEO input terminal, or a time lapse VCR with a S-VIDEO input terminal.
- Use a Mini-DIN (round type, 4-pin) plug to connect to the Y/C connector.  
Never use a coaxial cable longer than 10 metres to connect the camera to the S-VIDEO input terminal.

# SETTINGS

The illustration shows the factory default settings for the switches in the camera setup section.

The camera settings are described on the assumption that a DC type auto iris lens is being used. If you are using a VIDEO type auto iris lens, be sure to read the Note which is given.

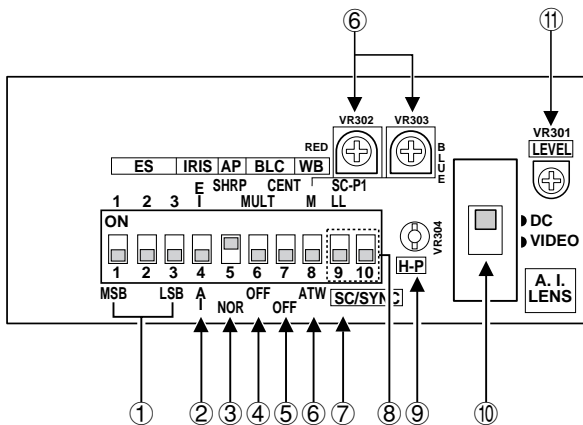

	Control name	Position
①	High speed electronic shutter setting	1/50 sec.
②	Electronic Iris (EI)/Auto iris (AI) setting	AI
③	Aperture compensation setting (Sharp: SHRP/Normal: NOR)	SHRP
④	Backlight compensation setting (BLC) (MULT/OFF)	OFF
⑤	Backlight compensation setting (BLC) (CENT/OFF)	OFF
⑥	White balance switch (M/ATW) and colour (R or B) adjustment volume	ATW
⑦	External sync setting (SYNC: LL/INT)	INT
⑧	External sync setting (SC-P1)	adjustable
⑨	External sync horizontal adjustment (H-P)	adjustable
⑩	Auto-iris lens setting (A.I. LENS), see page 6	DC
⑪	Lens iris level adjustment	adjustable

# SETTINGS





## High speed electronic shutter setting

Normally, the speed setting switches for the high speed electronic shutter are all set to the down (**OFF**) position. This sets the electronic shutter speed to 1/50 sec. The switches can be set as indicated in table **A** to select one of the **8** speeds available.

### CAUTION:

- When using the high speed electronic shutter, the switch **4** must be set to the down (**AI**) position.
- Using the high speed electronic shutter indoors with low lighting, will give darker pictures. In such a case, add some lights to make sure the lighting is sufficient. If the lighting is very bright, pay attention to the light angle in order to avoid or minimize the smear phenomenon effect.

Table A (switch 1 ~ 3)

①	②	③	④	⑤	⑥	⑦	⑧
1/50	1/120	1/250	1/500	1/1000	1/2000	1/4000	1/10000
							
1 2 3	1 2 3	1 2 3	1 2 3	1 2 3	1 2 3	1 2 3	1 2 3

(Unit: sec.)

## Iris function setting

This should normally be set to the down (**AI**) position. Use a manual or fixed iris lens and set the lens aperture to the shortest F stop. Set the switch **4** (**IRIS**) to the up (**EI**) position.



### When using an auto-iris lens (for indoor/outdoor use)

Set the switch **4** (**IRIS**) to the down (**AI**) position.

### Note:

- The electronic iris is suitable for normal indoor use. When the switch **4** (**IRIS**) is set to the up (**EI**) position, do not use an auto-iris lens.
- If used under fluorescent light, the image may flicker. In such a case, change to incandescent lighting or set the switch **4** (**IRIS**) to the down (**AI**) position and use an auto-iris lens.
- When shooting bright subjects, pay attention to the light angle in order to avoid or minimize the smear phenomenon effect.
- If conditions are outside the electronic iris operation range or more than the maximum illumination, it will cause saturation of the CCD. In that case, use a manual iris lens.

## Aperture

The initial setting for switch **5** is up (**SHRP**) so that the contours of the object are emphasized. However, if the contours of the object are already emphasized more than required, set switch **5** to the down (**NOR**) position.



# SETTINGS

## ■ Backlight compensation setting

This camera has two different backlight compensation functions: Normally backlight compensation switch **6 (MULT)** and **7 (CENT)** are set to the down (**OFF**) position. Change the backlight compensation switch settings depending on the conditions.

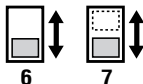

- **MULT mode:** Use this position when applying backlight compensation to the whole of the screen.
- **CENT mode:** Use this position when applying backlight compensation to only the central portion of the screen.

### Note:

- If switches **6** and **7** are set to the up (**ON**) position at the same time, the **MULT** setting will have priority.
- When **MULT** mode is set, scenes with no backlighting may appear extremely dark and the object may appear over-exposed. If this happens, set to **CENT** mode.

### (MULTI mode: 64 sections)

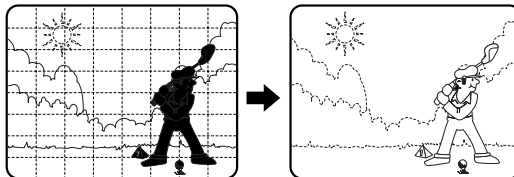

### (CENT mode)

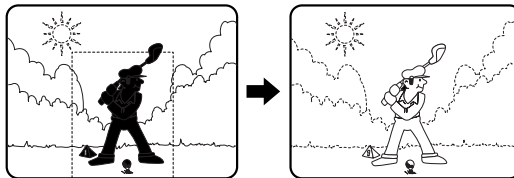

### if using a VIDEO type auto-iris lens

- The **ALC** volume on the lens should be turned all the way to **Av** (Average).
- If the backlight compensation function does not compensate properly for the conditions, set using the **LEVEL** volume on the lens.

# SETTINGS

## ■ White balance adjustment

Normally the switch **8 (WB)** is set to the down (**ATW**: auto white balance) position and the white balance is adjusted automatically. If a manual white balance adjustment is necessary, follow the steps below. Set the switch **8 (WB)** to the up (**M**: manual) position, then adjust the colour.

- Turn **RED** (VR302) to set the red ratio and/or **BLUE** (VR303) to set the blue ratio.

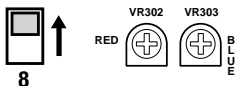

---

## Synchronization settings

The default setting is internal synchronization (**INT**). You can change the power supply synchronization by moving switch **9** to the up (**LL**) position. Refer to “**Line phase adjustment**” for details.

## ■ Line phase adjustment

When using a camera switcher to connect 2 cameras or more to one monitor, there may be a vertical roll of the images when switched. In such a case, set as described below.

- 1 Set the switch **9 (SYNC)** to the up (**LL**) position.
- 2 Switch the display on the monitor from camera 1 to camera 2. Adjust the **LINE PHASE** volume on camera 2 until the vertical roll of the image stops. If more than two cameras are used, please repeat this procedure for all the cameras.

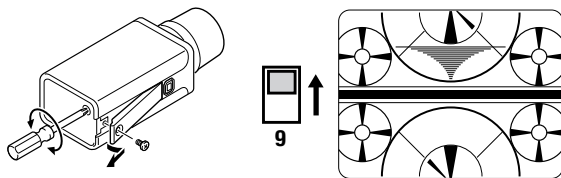

### CAUTION:

If the vertical roll cannot be corrected by setting the **LINE PHASE** volume on camera 2, try setting the **LINE PHASE** volume on camera 1. If it still cannot be corrected, please check that the polarity of the power cords of all connected devices is correct.

# SETTINGS

## External sync adjustment (VBS)

- 1 Connect the VBS signal output for the other camera to the **VBS IN** connector at the rear of this camera.
- 2 If the signals are not synchronized, change the sub-carrier (SC-P1) switches as follows.

Setting	9-pin	10-pin
Default	<b>OFF (down)</b>	<b>OFF</b>
Set to 90° counterclockwise	<b>OFF</b>	<b>ON (up)</b>
Set to 180° counterclockwise	<b>ON</b>	<b>OFF</b>
Set to 270° counterclockwise	<b>ON</b>	<b>ON</b>

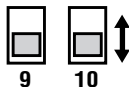

### Note:

- The sub-carrier switches let you make broad adjustments to the sub-carrier phase. If finer adjustments are required, contact the place of purchase.
- The type and length of the cable which is connected to the VBS connector may cause the horizontal synchronization being out of phase. If this happens, adjust **VR304 (H-P: horizontal sync)**.

## Lens iris adjustment

If using a DC type auto-iris lens, you will need to set the **LEVEL** (VR301) volume when shooting in the conditions described below.



**L (counterclockwise):** To decrease the contrast

**H (clockwise):** To increase the contrast

- If shooting simultaneously in a dark room and through a bright window.
- If the subject background is extremely bright or dark.
- If the brightness of the picture on the monitor is not correct.



# TROUBLESHOOTING

---

Before taking the camera for repairs, please check below to make sure that the camera is used correctly. If it still does not perform correctly, please consult your dealer or a Sanyo Authorized Service Centre.

## ■ No picture on the monitor screen

- Is the power turned on to all connected devices? Is the voltage correct?
- Are all the signal connecting cables correctly connected?
- Is the lighting sufficient?
- Has the lens cap been removed?
- Is the lens type (**DC** or **VIDEO**) correctly selected?  
Depending on the type of lens, the **A. I. LENS** switch must be set accordingly.
- Is the iris control correctly set?

## ■ The picture is not clear

- Is the monitor correctly adjusted?
- Is the flange-back position correctly set?
- Is the lens focus correctly adjusted?
- Are the lens surfaces clean?

If there is dust or finger prints on the lens, the image quality will deteriorate. To clean the lens use a soft cloth or a commercially available lens cleaning set.

## SERVICE

This camera is a precision instruments and if treated with care, will provide years of satisfactory performance. However, in the event of a problem, the owner is advised not to attempt to make repairs or open the cabinet. Servicing should always be referred to your dealer or Sanyo Authorized Service Centre.

# SPECIFICATIONS

---

## ■ Camera:

<b>Scanning system</b>	: PAL standard (625 TV lines, 25 frames/sec.)
<b>Interlace</b>	: PLL 2:1 interlace
<b>Image device</b>	: 1/3 inch solid state image device CCD
<b>Picture elements</b>	: 795 (H) x 596 (V)
<b>Effective picture elements</b>	: 752 (H) x 582 (V)
<b>Synchronizing system</b>	: Internal sync, Line lock manually switchable, External sync
<b>Resolution</b>	: 520 TV lines horizontally, 400 TV lines vertically
<b>Video output level</b>	: 1.0 Vp-p/75 ohms, composite
<b>Y/C signal outputs</b>	: Y: Video; 0.7 Vp-p + sync; 0.3 Vp-p/75 ohms C: Burst; 0.3 Vp-p/75 ohms
<b>Video S/N ratio</b>	: More than 48 dB
<b>Minimum required illumination (incandescent lighting)</b>	: Approx. 1.0 lux with a F 1.2 lens
<b>Backlight compensation</b>	: Manual ON/OFF switching, MULT/CENT switching (Active when using an auto-iris lens)
<b>Iris function</b>	: Manual EI/AI switching
<b>Electronic iris range</b>	: 1.0 lux to 50,000 lux (F 1.2 lens)
<b>Electronic shutter</b>	: 8 speeds, selectable by switches: (1/50, 1/120, 1/250, 1/500, 1/1000, 1/2000, 1/4000, 1/10000 sec.)
<b>Flange-back</b>	: 12.5 mm ± 0.5 mm
<b>White balance</b>	: ATW/Manual switching
<b>Lens mount</b>	: CS mount

<b>Environmental conditions</b>	: Temperature: -10°C ~ +50°C Humidity: less than 90% (no condensation)
<b>Power supply</b>	: 220 – 230 V AC ± 10% 50 Hz
<b>Power consumption</b>	: Approx. 4.0 W (with auto iris lens) Approx. 3.0 W (without auto iris lens)
<b>Weight</b>	: Approx. 620 g (without lens)

# SPECIFICATIONS

## ■ Dimensions

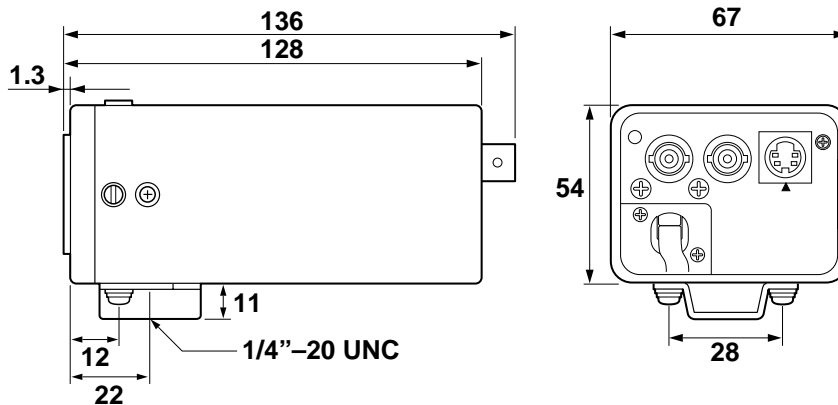

Features and specifications are subject to change without prior notice or obligations.

1AC6P1P2453--  
L53T5/XE (0801KPS-DSP)

Download from [Www.Somanuals.com](http://Www.Somanuals.com). All Manuals Search And Download.

**SANYO**

---

**Sanyo Electric Co, Ltd.**  
Printed in Japan

## Free Manuals Download Website

<http://myh66.com>

<http://usermanuals.us>

<http://www.somanuals.com>

<http://www.4manuals.cc>

<http://www.manual-lib.com>

<http://www.404manual.com>

<http://www.luxmanual.com>

<http://aubethermostatmanual.com>

Golf course search by state

<http://golfingnear.com>

Email search by domain

<http://emailbydomain.com>

Auto manuals search

<http://auto.somanuals.com>

TV manuals search

<http://tv.somanuals.com>