

SHARP®



Free standing type

FU-W53E FU-W43E

AIR PURIFIER OPERATION MANUAL

ENGLISH

*Plasmacluster is a trademark of Sharp Corporation.

Please read before operating your new Air Purifier

The air purifier draws in room air from its air intake, lets the air pass through an Active Carbon Filter (deodorization filter) and a HEPA Filter (dust collection filter) inside of the unit, then discharges the air from its air outlet. The air purifier unit repeats this process by moving its internal fan.

As air passes through the HEPA filter it removes 99.97% of dust particles (as small as 0.3 microns.). The Active Carbon Filter gradually absorbs odour elements as they repeatedly pass through the filter.

Some odour ingredients absorbed by the filters may become separated and may be discharged through the air outlet and result in additional odour. Depending on the usage environment, especially when the product is used in a condition significantly more severe than household use, this odour may become strong in a shorter period than expected.

If the odour persists the filters should be replaced.
Please purchase the optional replacement filter.

NOTE

- The air purifier is designed to remove air-suspended dust and odour, but not harmful gases (for example, carbon monoxide contained in cigarette smoke.) If the odour sources still exist, it cannot completely remove the odour. (for example, odours from construction materials and pet odours.)
- It is suggested to open the window a bit when you are smoking in order to facilitate ventilation.

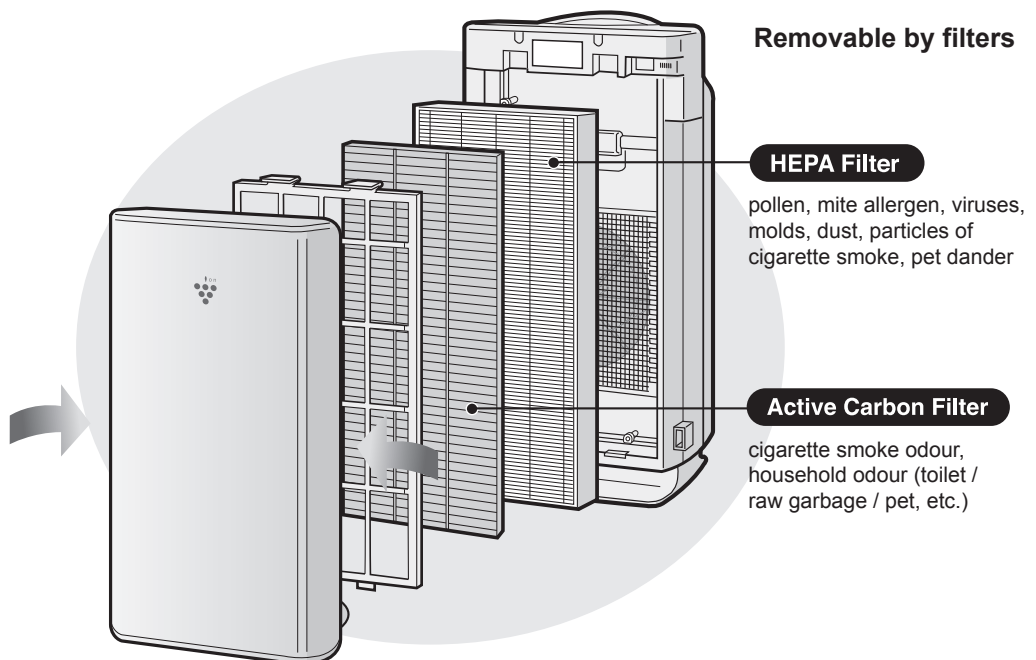

FEATURES

"Plasmacluster" technology

Plasmacluster technology uses plasma discharge to produce and release the same positive and negative ions as those found in nature ("Plasmacluster ions").

This is a unique air cleaning technology of the SHARP CORPORATION for breaking down and eliminating such potential allergens as the fecal matter or corpses of aerial mites*1, viruses *2 and mold and bacteria *3 suspended in the air, and has been substantiated by third-party organizations both in Japan and overseas.

When there is a high density of Plasmacluster ions in the air, the smell of cigarette smoke trapped in curtains or sofas is eliminated in about 80 minutes, and when clothing is hung in a place exposed to the direct air expelled from the unit generating Plasmacluster ions, the smell of sweat is reduced to a virtually imperceptible level in one night (about 6 hours).

*1 Graduate School of Advanced Sciences of Matter, Hiroshima University, Japan

Measurement of action on the potential allergens of aerial mites in (13m²)

*2 Retroscreen Virology, Ltd., London, UK
Measurement of ratio of viruses eliminated from the air in a 1m³ box

*3 Ishikawa Health Service Association, Japan

Measurement of aerial mold and bacteria with an air sampler (13m²)

*4 Japan Spinners Inspecting Foundation, Japan

Evaluation of deodorizing effect on odor-imbued fragments of cloth

CONTENTS

IMPORTANT SAFETY INSTRUCTIONS	E-2
• WARNING	E-2
• CAUTIONS CONCERNING OPERATION ...	E-3
• INSTALLATION GUIDELINES	E-3
• FILTER GUIDELINES	E-3
PART NAMES	E-4
• MAIN UNIT DISPLAY	E-4
• ILLUSTRATIVE DIAGRAM	E-4
• BACK	E-5
• INCLUDED	E-5
PREPARATION	E-6
• FILTER INSTALLATION	E-6
OPERATION	E-8
• MAIN UNIT OPERATION	E-8
CARE AND MAINTENANCE	E-10
• FILTER RESET INDICATOR LIGHT	E-10
• MAIN UNIT	E-10
• FILTER	E-10
• SENSORS	E-10
• WASHABLE ACTIVE CARBON FILTER CARE	E-11
• FILTER REPLACEMENT GUIDELINES	E-12
TROUBLESHOOTING	E-13
SPECIFICATIONS	E-14
INFORMATION ON PROPER DISPOSAL	E-15

Thank you for purchasing the SHARP Air Purifier. Please read this manual carefully for the correct usage information. Before using this product, be sure to read the section: "Important Safety Instructions."

After reading this manual, retain it in a convenient location for future reference.

IMPORTANT SAFETY INSTRUCTIONS

When using electrical appliances, **basic safety precautions** should be followed, including the following:

WARNING - To reduce the risk of electrical shock, fire or injury to persons:

- Read all instructions before using the unit.
- Use only a 220-240 volt outlet.
- **Do not use the unit if the power cord or plug is damaged or the connection to the wall outlet is loosened.**
- Periodically remove dust from the power plug.
- **Do not insert fingers or foreign objects into the intake or air outlet.**
- **When removing the power plug, always hold the plug and never pull the cord.**

Electrical shock and/or fire from short circuit may occur as a result.

- **Do not remove the plug when your hands are wet.**
- **Do not use this unit near gas appliances or fireplaces.**
- **Remove the power plug from the wall outlet before cleaning the unit and when not using the unit.**

Electrical shock from bad insulation and/or fire from short circuit may occur as a result.

- **If the power cord is damaged, it must be replaced by the manufacturer, its service agent, Sharp authorized Service Centre or similarly qualified person in order to avoid a hazard.**
- Do not operate when using aerosol insecticides or in rooms where there is oily residue, incense, sparks from lit cigarettes, chemical fumes in the air or in very high humidity condition, such as a bathroom.
- Be cautious when cleaning the unit. Strong corrosive cleansers may damage the exterior.
- Only Sharp Authorized Service Centre should service this air purifier. Contact the nearest Service Centre for any problems, adjustments, or repairs.
- This appliance is not intended for use by persons (including children) with reduced physical, sensory or mental capabilities, or lack of experience and knowledge, unless they have been given supervision or instruction concerning use of the appliance by a person responsible for their safety.
- Children should be supervised to ensure they do not play with the appliance.

NOTE - Radio or TV Interference

If this air purifier should cause interference to radio or television reception, try to correct the interference by one or more of the following measures:

- Reorient or relocate the receiving antenna.
- Increase the separation distance between the unit and radio/TV receiver.
- Connect the equipment into an outlet on a circuit different from that to which the receiver is connected.
- Consult the dealer or an experienced radio/TV technician for help.

IMPORTANT SAFETY INSTRUCTIONS

CAUTIONS CONCERNING OPERATION

- Do not block the intake and/or air outlet.
- Do not use the unit near or on hot objects, such as stoves or heaters or where it may come into contact with steam.
- Do not lay the unit down when using.
- **Always hold the handle on the back of the unit when moving it.**
Holding the front panel when carrying may cause it to detach, thus dropping the unit and resulting in bodily injury.
- **Do not operate the unit without the filter.**
- **Do not wash and reuse HEPA filter .**
It not only does not improve filter performance, it may cause electric shock or malfunction.
- **Clean the exterior with a soft cloth only.**
The unit surface may be damaged or cracked.
In addition, the sensors may malfunction as a result.

INSTALLATION GUIDELINES

- **During the operation of the product, please place the unit at least 2 m away from equipment which are subject to electrical waves such as televisions, radios or wave clocks.**
- **Avoid a location where the sensor is exposed to direct wind.**
The unit may not operate properly.
- **Avoid locations where curtains, etc., come into contact with the intake or air outlet.**
Curtains, etc., may become dirty or a malfunction may occur.
- **Avoid locations where the unit is exposed to condensation, due to drastic temperature changes.**
(Use under appropriate conditions between 0 and 35°C in the room.)
- **Place on a stable surface with sufficient air circulation.**
When placing the unit on a heavily carpeted area, it may cause the unit to vibrate slightly.
- **Do not install when there is generation of lampblack, such as in a kitchen, etc.**
The unit surface may crack or the sensor may malfunction as a result.
- **Leave about 60cm of space from the wall.**
The wall behind the air outlet may become dirty as time passes. When using the unit for extended period of time in the same location, use a vinyl sheet, etc., to prevent the wall from becoming dirty. In addition, periodically clean the wall.

FILTER GUIDELINES

- Follow the instructions in this manual for correct care and maintenance of the filters.

PART NAMES

MAIN UNIT DISPLAY

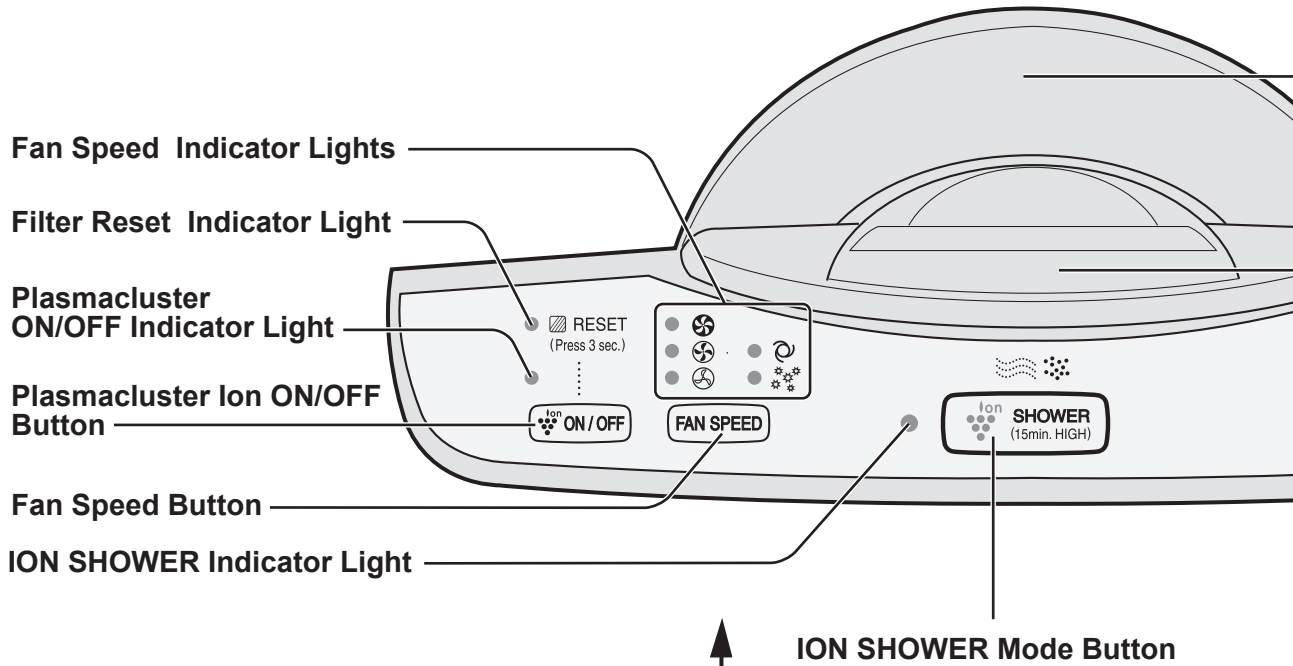

ILLUSTRATIVE DIAGRAM

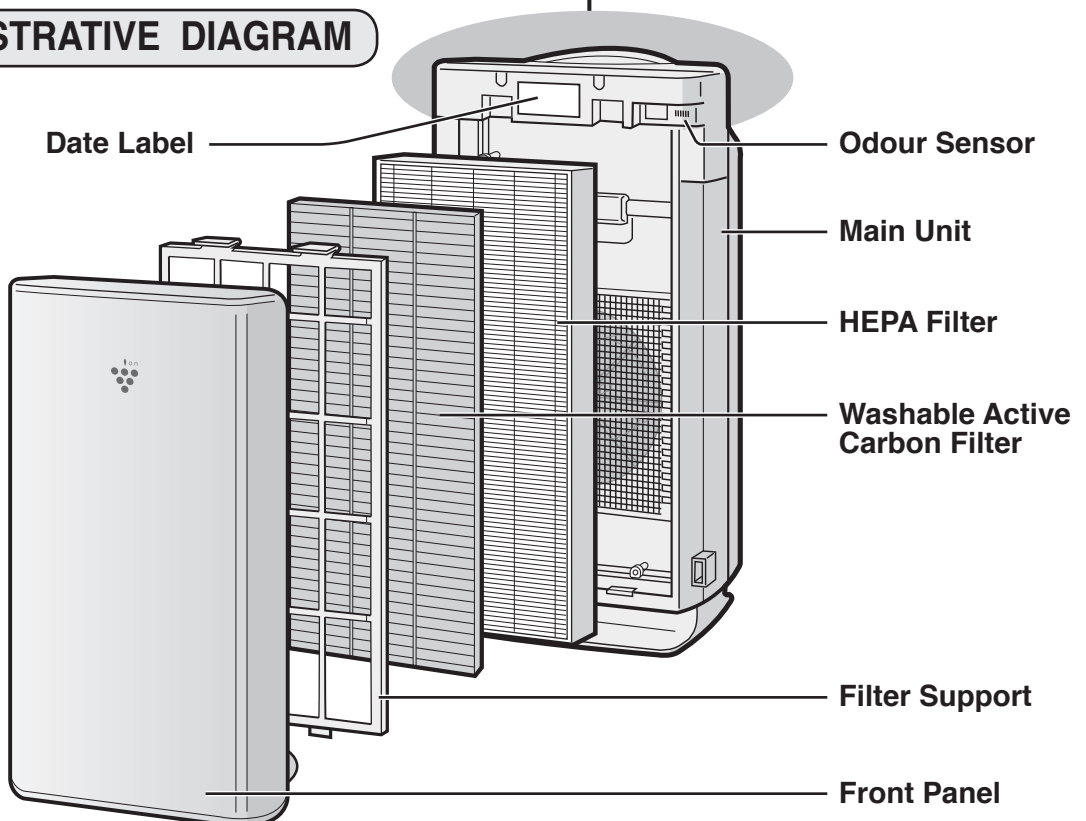

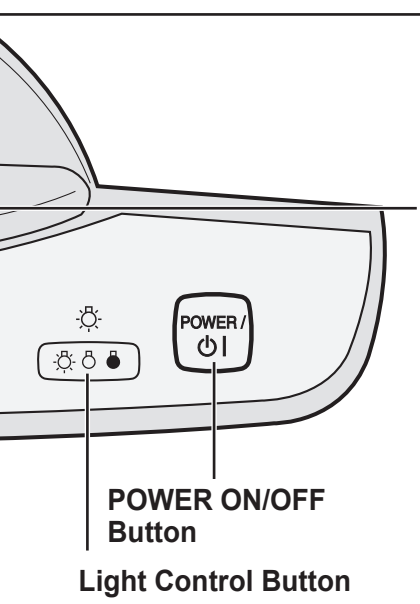

Plasmacluster Indicator Light(Blue)
 Blue : Plasmacluster ON
 Light off : Plasmacluster OFF

CLEAN - SIGN Light

The colour changes according to the air condition.

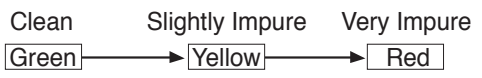

ABOUT THE CLEAN-SIGN

- The condition of the CLEAN-SIGN depends on the room air condition detected by the Dust and Odour Sensors when the plug is inserted into the wall outlet.
- It is possible to have a green CLEAN-SIGN with impurities in the air at the time that the air purifier was just introduced to the room environment. After a while, however, the base impurity rate will be adjusted to detect room air condition correctly.

BACK

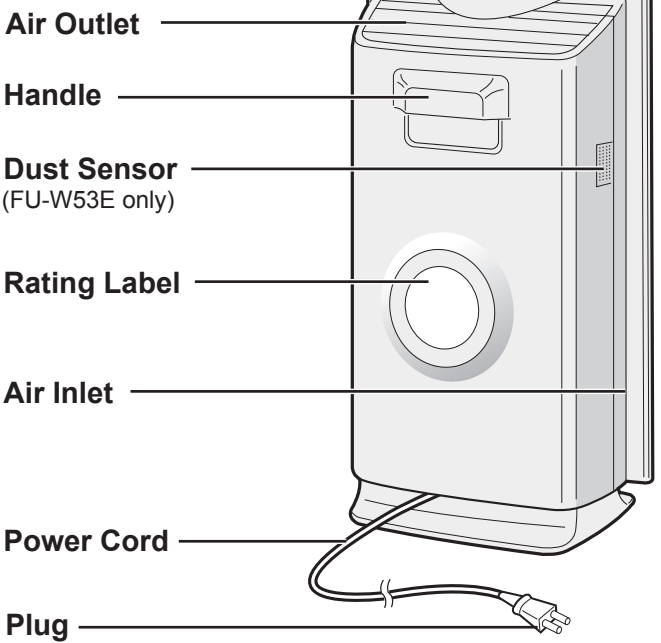

(Shape of plug depends on country.)

INCLUDED

- Operation manual

FILTER INSTALLATION

To maintain the quality of the filters, they are installed in the main unit and packed in plastic bags. Be sure to remove the filters from the plastic bags before using the unit.

1 Remove the filters

- 1 Remove the Front Panel.**
Pull the Front Panel on the lower sides, and lift up.

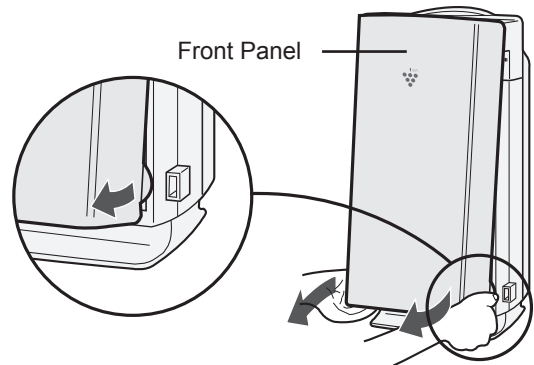

- 2 Remove the Filter Support.**
Push in the hooks on top, then pull the Filter Support.

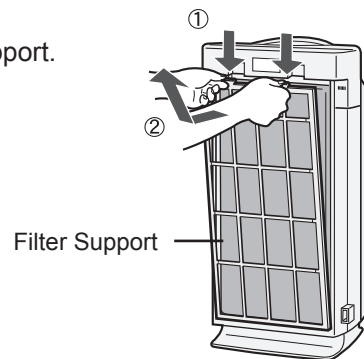

- 3 Remove the Washable Active Carbon Filter (Black) and HEPA Filter (White) from the plastic bags.**

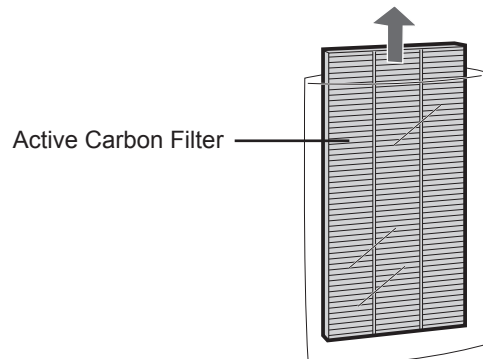
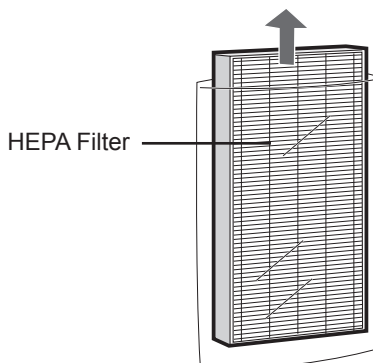

2 Install the filters

- 1 Place the HEPA Filter into the main unit.

Please make sure that the HEPA Filter (blue) and the tab is placed in proper direction.

Do not install the filter backwards or the unit will not operate properly.

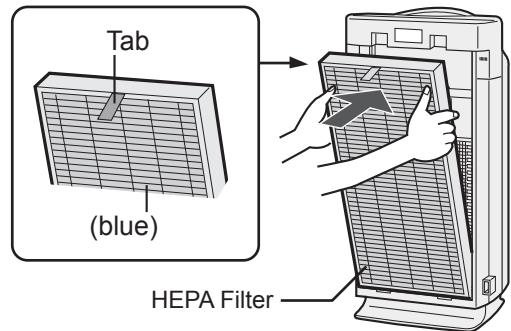

- 2 Insert the Filter Support's 2 bottom tabs (left and right) into the small holes in the unit, and slide the Active Carbon Filter between the HEPA Filter and the Filter Support.

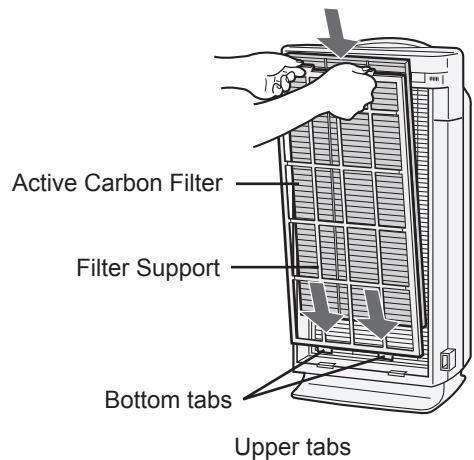

- 3 Gently push in the upper tabs (left and right) to lock in place.

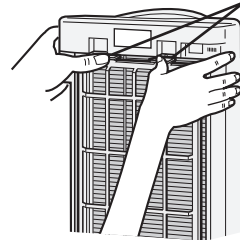

- 4 Fill in the usage start date on the Date Label.

Use the date as a guide for the Filter Replacement schedule.

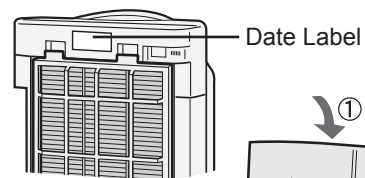

- 5 Replace the Front Panel.

Place the Front Panel from the obliquely upward, then mount the hooks at the bottom.

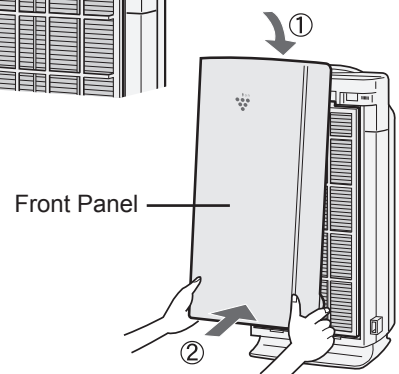

OPERATION

MAIN UNIT OPERATION



Power ON/OFF Button

- Used to start operation (short beep) and stop operation (long beep)
- Plasmacluster Indicator Light and Fan Speed Indicator Light turn on/off.
- Unless the power cord is unplugged, the operation will start in the previous mode.
- When stopping the operation in ION SHOWER mode, the unit will return to the prior ION SHOWER mode.

FAN Speed Indicator Lights

FAN SPEED Button

Plasmacluster ON/OFF Button

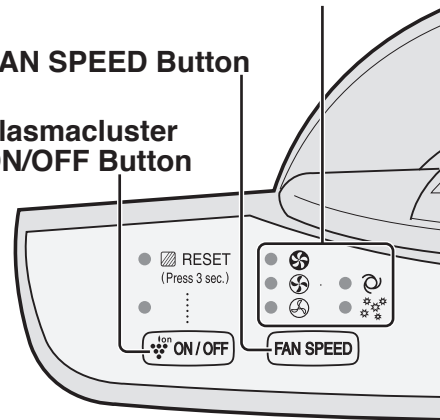

FAN SPEED

FAN SPEED Button

- The operation mode can be switched as below.

AUTO operation

The fan speed is automatically switched (MEDIUM, LOW) depending on the amount of impurities in the air. The sensors detect the impurities for efficient air purification.

POLLEN mode operation

The unit will operate at HIGH* fan speed for 10 minutes, then will alternate between MEDIUM and HIGH* for 20 minutes.

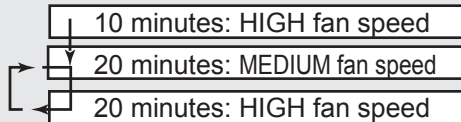

SILENT operation

The unit will operate quietly using minimal air intake.

MEDIUM operation

The unit will operate at a fan speed of MEDIUM.

MAX operation

The unit will operate at a fan speed of MAX.

* HIGH fan speed is an intermediate speed between MEDIUM and MAX.

* LOW fan speed is an intermediate speed between SILENT and MEDIUM.



ION SHOWER Mode Button

When pushing the ION SHOWER Mode button, the ION SHOWER operation will be activated. (Direct start is available even when the unit is not turned on.)

By continuously discharging strong airflow for 15 minutes the unit effectively removes airborne dust, pollen, mold and allergens from the air as they are drawn through the filter system.

•When the operation finishes, the unit will return to the prior operation.

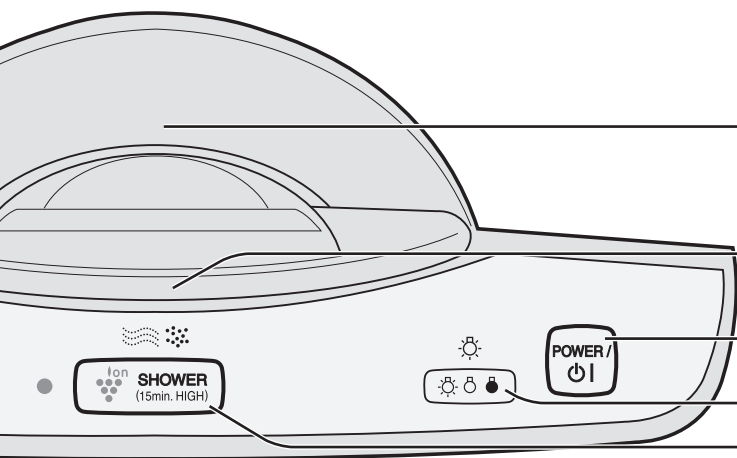

- Plasmacluster Indicator Light
- CLEAN - SIGN Light
- POWER ON/OFF Button
- LIGHT CONTROL Button
- ION SHOWER Mode Button



Plasmacluster ON/OFF Button

Press the Plasmacluster ON/OFF Button to turn Plasmacluster Ion Mode ON and OFF. When Plasmacluster is ON, both the Indicator Light and Plasmacluster Indicator will turn on.

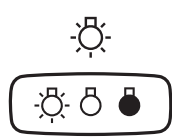

LIGHTS CONTROL Button

Use when the the Plasmacluster Indicator Light and CLEAN-SIGN Light are too bright.

Refer to the diagram on the right to select the desired brightness of the Plasmacluster Indicator Light and CLEAN-SIGN Light.

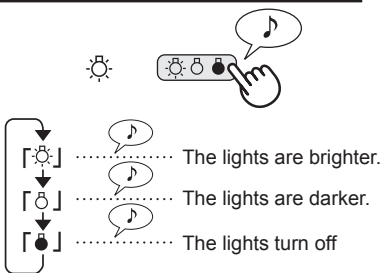

CAUTION

The lights on the front monitor are always brighter when starting.

ADJUSTMENT OF SENSOR DETECTION SENSITIVITY

Set to "low" if CLEAN-SIGN Light is constantly red to reduce sensitivity, and set to "high" if CLEAN-SIGN Light is constantly green to increase sensitivity.

1 With the unit OFF, press the Fan Speed Button for 3 seconds.
The Fan Speed Indicator Lights will display the currently set sensor sensitivity level. The factory setting is Standard, indicated by the MED light.

2 Press the Fan Speed Button to set the desired sensor sensitivity.
Refer to the diagram on the right to select the desired sensor sensitivity level.

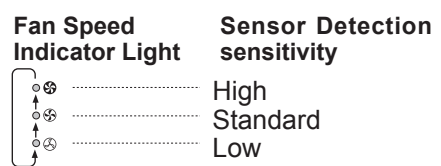

3 Press the Power ON/OFF Button.
Note that if the Power ON/OFF Button is not pushed within 8 seconds of adjusting sensor sensitivity, the setting will be saved automatically. The sensor sensitivity setting will be saved even if the unit is unplugged.

CARE AND MAINTENANCE

To maintain optimum performance of this air purifier, please clean the unit including the sensor and filters periodically. When cleaning the unit, be sure to unplug the power cord, and never handle the plug with wet hands. Electrical shock and/or bodily injury may occur as a result.

FILTER RESET INDICATOR LIGHT

The Filter RESET Indicator Light will illuminate as a reminder to perform maintenance of the Filters and Sensors. The Indicator Light will turn on after approximately 720 hours of use.

After performing maintenance, reset the Filter Reset Indicator. Plug the unit in, turn power ON, and press the Plasmacluster Ion ON/OFF Button for 3 seconds. The Filter Indicator Light will go off. Even if the Filter Indicator Light is already off, the Plasmacluster Ion ON/OFF Button should be pressed to reset the maintenance timer.

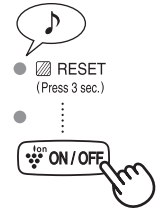

MAIN UNIT

Care Cycle 1 month

To prevent dirt or stains on the main unit, clean as often as necessary. If stains are allowed to remain, they may become hard to clean.

Wipe with a dry, soft cloth

For stubborn stains or dirt, use a soft cloth dampened with warm water.

Do not use volatile fluids

Benzene, paint thinner, polishing powder, etc., may damage the surface.

Do not use detergents

Detergent ingredients may damage the unit.

Keep the unit away from water

FILTER

Care Cycle 2 months

Clean the top surface of the Washable Active Carbon Filter lightly with a vacuum cleaner.



SENSORS (DUST SENSOR, ODOUR SENSOR)

Care Cycle 2 months

Remove dust from the surface of the hole of the sensors using a vacuum cleaner.

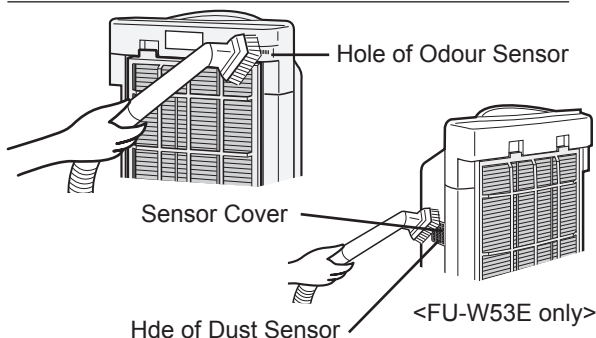

SENSOR FILTER CARE

<FU-W53E only>

Detach the sensor filter and tap it lightly with your hand to remove the dust.

If it is very dirty, wash it with water and then allow it to dry thoroughly.

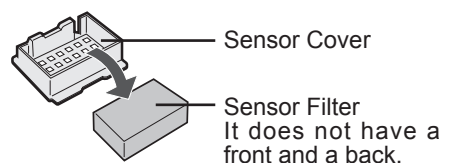

WASHABLE ACTIVE CARBON FILTER CARE

Care Cycle 2 months

**HAND WASH ONLY!
DO NOT TUMBLE DRY!**

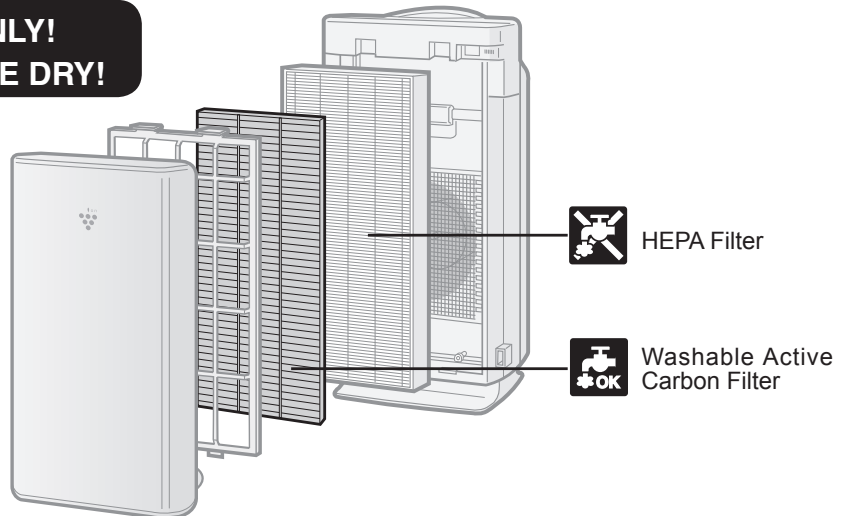

1 Rinse dirt from the WASHABLE ACTIVE CARBON FILTER under lukewarm water.

Remove dust on the washable active carbon filter before washing.

CAUTION

- When washing the filter for the first time, the rinse water may be brown. This does not affect deodorization performance.
- Avoid bending or folding the filter when washing.

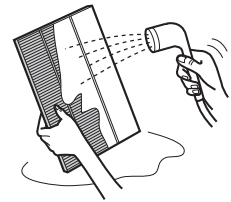

2 Drip dry filter to remove excess water.

3 Dry filter completely in a well ventilated area. If possible, dry outdoors.

Dry filter in a sideways position to avoid warping of the filter. The filter takes about 6 hours to dry out.

CAUTION

- Avoid drying filter outdoors during inclement weather (e.g. rain or cold temperatures).
- Do not allow filter to freeze.
- If filter is dried indoors, take precautions, such as placing towels, etc under the filter to prevent water damage to the floor.

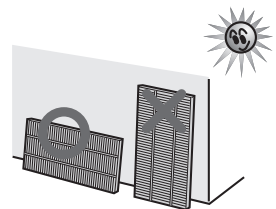

4 Replace the filter in unit. (See E-6).

Dry filter completely before replacing to prevent odours. Do not operate unit without all filters properly installed.

CARE AND MAINTENANCE

FILTER REPLACEMENT GUIDELINES

The replacement period differs depending on the room environment, the usage hours and location of the Air Purifier.

If dust or odour persist, replace the filters.

(Refer to “Please read before operating your new Air Purifier”)

HEPA Filter / Washable Active Carbon Filter

Up to 5 years after opening

Guide for filter replacement timing

- Filter life can be greatly reduced in a poor environment.

The presence of cigarette smoke, pet dander and other concentrations of airborne particles will cause filters to become clogged in less time. Please check filters regularly and replace as needed.

Replacement Filters

Model	• HEPA Filter : 1 unit
FZ-W53SEF	• Washable Active Carbon Filter : 1 unit

REPLACING THE FILTERS

1. See page E-6,7 for directions on how to install the filters when replacing.
2. Fill in the usage start date of the filters on the Date Label.

Disposal of Filters

Please dispose of replaced filters according to the local disposal laws and regulations.

HEPA Filter Materials:

- Filter: Polypropylene
- Frame: Polyester

Active Carbon Filter Materials:

- Deodorizer: Activated charcoal
- Net: Polypropylene 60%, Polyester 40%

TROUBLESHOOTING

Before calling for repair, please review the list below, since the problem may not be a unit malfunction.

SYMPTOM	REMEDY (not a malfunction)
Odours and smoke are not removed.	<ul style="list-style-type: none"> • Clean or replace the filters if they appear to be heavily soiled. (Refer to E-11, E-12)
The CLEAN-SIGN Light lights green even when the air is impure.	<ul style="list-style-type: none"> • The air could be impure at the time the unit was plugged in. (Refer to E-5) Pull out the plug from the electrical outlet, and insert the plug one minute later.
The CLEAN-SIGN Light lights yellow or red even when the air is clean.	<ul style="list-style-type: none"> • The sensitivity of the sensors become unstable when the opening of the odour sensor or dust sensor is dirty or is clogged. Clean the dust around the sensor opening using a vacuum cleaner. (Refer to E-10)
A clicking or ticking sound is heard from the unit.	<ul style="list-style-type: none"> • Clicking or ticking sounds may be audible when the unit is generating ions.
The discharged air has an aroma or odour.	<ul style="list-style-type: none"> • Check to see if the filters are heavily soiled. Replace the filters. • Plasmacluster Air Purifiers emit small traces of ozone which may produce an odour. These ozone emissions are well below safety levels .
The unit does not operate when cigarette smoke is in the air.	<ul style="list-style-type: none"> • Is the unit installed in a location that is difficult for the sensor to detect cigarette smoke? • Are the dust or odour sensor openings blocked or clogged? (In this case, clean the openings.) (Refer to E-10)
The Plasmacluster Indicator Light or the CLEAN-SIGN Light will not activate.	<ul style="list-style-type: none"> • Check to see if the Lights OFF Mode is selected. If so, then press the Light Control Button to activate the indicator lights. (Refer to E-9)

ENGLISH

ERROR DISPLAY

LAMP INDICATION	REMEDY
The "Silent" Fan Speed Indicator Light blinks.	<p>Fan motor disconnected or abnormal. Operation stops.</p> <ul style="list-style-type: none"> • Pressing the POWER ON/OFF button will reset the error display, but if error occurs again, contact the Sharp Service Centre.

SPECIFICATIONS

Model		FU-W53E		
Power supply		220-240V 50/60Hz		
Fan Speed Operation	Fan Speed Adjustment	MAX	MED	SILENT
	Rated Power	42W	15W	3.5W(3.2W) *1
	Fan Speed	318m ³ /hour	204m ³ /hour	36m ³ /hour
Recommended Room Size		~40m ² *2		
High density Plasmacluster ion applicable floor surface		~20m ² *3		
Cord Length		2.0m		
Dimensions		338mm(W)x207mm(D)x620mm(H)		
Weight		6.1kg		

Model		FU-W43E		
Power supply		220-240V 50/60Hz		
Fan Speed Operation	Fan Speed Adjustment	MAX	MED	SILENT
	Rated Power	27W	15W	3.5W(3.2W) *1
	Fan Speed	258m ³ /hour	180m ³ /hour	36m ³ /hour
Recommended Room Size		~32m ² *2		
High density Plasmacluster ion applicable floor surface		~15m ² *3		
Cord Length		2.0m		
Dimensions		314mm(W)x207mm(D)x620mm(H)		
Weight		6.0kg		

*1 Numbers in parentheses indicate the power consumption when the Plasmacluster indicator light and the CLEAN-SIGN light are off.

*2 The applicable floor surface area is appropriate for operating the unit of maximum fan speed.
 •Applicable floor surface area indicates the space where a certain amount of dust particles can be removed in 30 minutes.(JEM1467)

*3 Size of a room in which approximately 7000 ions can be measured per cubic centimeter in the center of the room (at a height of approximately 1.2 meters from the floor) when the product is placed next to a window and run at the MAX operation position.

Standby Power

In order to operate the electrical circuits while the power plug is inserted in the wall outlet, this product consumes about 0.8W of standby power.
 For energy conservation, unplug the power cord when the unit is not in use.



Attention: Your product is marked with this symbol. It means that used electrical and electronic products should not be mixed with general household waste. There is a separate collection system for these products.

A. Information on Disposal for Users (private households)

1. In the European Union

Attention: If you want to dispose of this equipment, please do not use the ordinary dust bin!

Used electrical and electronic equipment must be treated separately and in accordance with legislation that requires proper treatment, recovery and recycling of used electrical and electronic equipment.

Following the implementation by member states, private households within the EU states may return their used electrical and electronic equipment to designated collection facilities free of charge*. In some countries* your local retailer may also take back your old product free of charge if you purchase a similar new one.

*) Please contact your local authority for further details.

If your used electrical or electronic equipment has batteries or accumulators, please dispose of these separately beforehand according to local requirements.

By disposing of this product correctly you will help ensure that the waste undergoes the necessary treatment, recovery and recycling and thus prevent potential negative effects on the environment and human health which could otherwise arise due to inappropriate waste handling.

2. In other Countries outside the EU

If you wish to discard this product, please contact your local authorities and ask for the correct method of disposal.

For Switzerland: Used electrical or electronic equipment can be returned free of charge to the dealer, even if you don't purchase a new product. Further collection facilities are listed on the homepage of www.swico.ch or www.sens.ch.

B. Information on Disposal for Business Users.

1. In the European Union

If the product is used for business purposes and you want to discard it:

Please contact your SHARP dealer who will inform you about the take-back of the product. You might be charged for the costs arising from take-back and recycling. Small products (and small amounts) might be taken back by your local collection facilities.

For Spain: Please contact the established collection system or your local authority for take-back of your used products.

2. In other Countries outside the EU

If you wish to discard of this product, please contact your local authorities and ask for the correct method of disposal.

Memo

SHARP

SHARP ELECTRONICS (Europe) GmbH
SonninstraÙe 3, D-20097 Hamburg

SHARP CORPORATION
OSAKA, JAPAN

Printed in China
TINS-A303KKRZ (CN) 08L- ①

Free Manuals Download Website

<http://myh66.com>

<http://usermanuals.us>

<http://www.somanuals.com>

<http://www.4manuals.cc>

<http://www.manual-lib.com>

<http://www.404manual.com>

<http://www.luxmanual.com>

<http://aubethermostatmanual.com>

Golf course search by state

<http://golfingnear.com>

Email search by domain

<http://emailbydomain.com>

Auto manuals search

<http://auto.somanuals.com>

TV manuals search

<http://tv.somanuals.com>