

SHARP®

MODEL

AL-1556

AL-1566

**DIGITAL MULTIFUNCTIONAL
SYSTEM**

OPERATION MANUAL

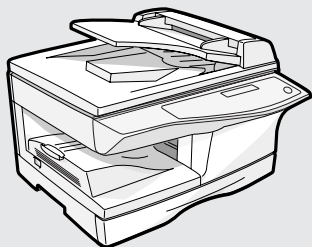

Do not make copies of anything which is prohibited from copying by law. The following items are normally prohibited from copying by national law. Other items may be prohibited by local law.

- Money
- Stamps
- Bonds
- Stocks
- Bank drafts
- Checks
- Passports
- Driver's licenses

In some areas, the "POWER" switch positions are marked "I" and "O" on the copier instead of "ON" and "OFF".

If your copier is so marked, please read "I" for "ON" and "O" for "OFF".

Caution!

For a complete electrical disconnection, pull out the main plug.

The socket-outlet shall be installed near the equipment and shall be easily accessible.

This equipment complies with the requirements of Directives 89/336/EEC and 73/23/EEC as amended by 93/68/EEC.

Dieses Gerät entspricht den Anforderungen der EG-Richtlinien 89/336/EWG und 73/23/EWG mit Änderung 93/68/EWG.

Ce matériel répond aux exigences contenues dans les directives 89/336/CEE et 73/23/CEE modifiées par la directive 93/68/CEE.

Dit apparaat voldoet aan de eisen van de richtlijnen 89/336/EEG en 73/23/EEG, gewijzigd door 93/68/EEG.

Dette udstyr overholder kravene i direktiv nr. 89/336/EEC og 73/23/EEC med tillæg nr. 93/68/EEC.

Quest' apparecchio è conforme ai requisiti delle direttive 89/336/EEC e 73/23/EEC, come emendata dalla direttiva 93/68/EEC.

Η εγκατάσταση αυτή ανταποκρίνεται στις απαιτήσεις των οδηγιών της Ευρωπαϊκής Ένωσης 89/336/EOK και 73/23/EOK, όπως οι κανονισμοί αυτοί συμπληρώθηκαν από την οδηγία 93/68/EOK.

Este equipamento obedece às exigências das directivas 89/336/CEE e 73/23/CEE, na sua versão corrigida pela directiva 93/68/CEE.

Este aparato satisface las exigencias de las Directivas 89/336/CEE y 73/23/CEE, modificadas por medio de la 93/68/CEE.

Denna utrustning uppfyller kraven enligt riktlinjerna 89/336/EEC och 73/23/EEC så som kompletteras av 93/68/EEC.

Dette produktet oppfyller betingelsene i direktivene 89/336/EEC og 73/23/EEC i endringen 93/68/EEC.

Tämä laite täyttää direktiivien 89/336/EEC ja 73/23/EEC vaatimukset, joita on muutettu direktiivillä 93/68/EEC.

The CE mark logo label is affixed on an equipment in case that the directives described in the above sentence are applicable to the product. (This sentence is not applicable in any country where the above directives are not required.)

CONTENTS

| | |
|---------------------------------|---|
| CAUTIONS | 3 |
| ENVIRONMENTAL INFORMATION | 5 |
| INTRODUCTION | 6 |
| MAIN FEATURES | 7 |

1 PREPARATIONS

| | |
|--|----|
| PART NAMES | 9 |
| CHECKING PACKED COMPONENTS AND ACCESSORIES | 12 |
| PREPARING THE MACHINE FOR INSTALLATION | 13 |
| INSTALLING THE TD CARTRIDGE | 14 |
| POWER ON AND OFF | 16 |

2 LOADING PAPER

| | |
|--|----|
| PAPER | 18 |
| LOADING THE PAPER TRAY | 19 |
| BYPASS FEED (including special paper)..... | 21 |
| CHANGING A TRAY'S PAPER SIZE SETTING | 23 |

3 MAKING COPIES

| | |
|--------------------------------------|----|
| NORMAL COPYING..... | 24 |
| SELECTING THE TRAY | 27 |
| MAKING A COPY DARKER OR LIGHTER..... | 28 |
| REDUCTION/ENLARGEMENT/ZOOM | 29 |

4 CONVENIENT COPY FUNCTIONS

| | |
|---|----|
| AUTOMATIC TWO-SIDED COPYING | 30 |
| SORT COPY | 33 |
| COPYING MULTIPLE ORIGINALS ONTO A SINGLE SHEET OF PAPER (2 IN 1 copy)..... | 35 |
| CREATING MARGINS WHEN COPYING (Margin shift)..... | 38 |

5 SET UP THE SOFTWARE

| | |
|---------------------------------|----|
| SOFTWARE FOR AL-1556/1566 | 40 |
| BEFORE INSTALLATION | 41 |
| INSTALLING THE SOFTWARE | 42 |
| SETTING UP BUTTON MANAGER | 55 |

6 PRINTER/SCANNER FUNCTIONS

| | |
|---|----|
| USING THE PRINTER MODE | 60 |
| BASIC PROCEDURE FOR PRINTING | 60 |
| USING THE SCANNER MODE..... | 61 |
| SCANNING USING THE KEYS ON THE MACHINE | 61 |
| SCANNING FROM YOUR COMPUTER..... | 62 |
| OPERATION IN COPY, PRINTER, AND SCANNER MODES | 62 |
| HOW TO USE THE ONLINE MANUAL..... | 63 |

7 USER SETTINGS

| | |
|---|----|
| USER PROGRAMS..... | 64 |
| SELECTING A SETTING FOR A USER PROGRAM..... | 69 |

8 TROUBLESHOOTING AND MAINTENANCE



| | |
|---|----|
| DISPLAY MESSAGES | 71 |
| TROUBLESHOOTING THE MACHINE..... | 73 |
| PROBLEMS DURING SETUP THE SOFTWARE..... | 77 |
| MISFEED REMOVAL..... | 80 |
| TD CARTRIDGE REPLACEMENT..... | 85 |
| DRUM CARTRIDGE REPLACEMENT..... | 86 |
| CHECKING THE TOTAL COUNT AND DRUM CARTRIDGE LIFE..... | 87 |
| CLEANING THE MACHINE | 88 |
| ABOUT SUPPLIES AND OPTIONS..... | 91 |

9 APPENDIX

| | |
|----------------------------------|-----|
| SPECIFICATIONS..... | 92 |
| SOFTWARE LICENSE..... | 96 |
| MATERIAL SAFETY DATA SHEET | 98 |
| INDEX..... | 106 |

CAUTIONS

Caution label on the machine

The label ( ) in the fusing area of the machine indicates the following:

 : Caution, risk of danger

 : Caution, hot surface

Cautions on using the machine

Follow the cautions below when using this machine.

Warning:

- The fusing area is hot. Exercise care in this area when removing misfed paper.
- Do not look directly at the light source. Doing so may damage your eyes.
- Do not switch the machine rapidly on and off. After turning the machine off, wait 10 to 15 seconds before turning it back on.
- Machine power must be turned off before installing any supplies.

Caution:

- Place the machine on a firm, level surface.
- Do not install the machine in a humid or dusty location.
- When the machine is not used for a long time, for example for consecutive holidays, turn the power switch off and remove the power cord from the outlet.
- When moving the machine, be sure to turn the power switch off and remove the power cord from the outlet.
- Do not cover the machine with a dust cover, cloth or plastic film while the power is on. Doing so may prevent heat radiation, damaging the machine.
- Use of controls or adjustments or performance of procedures other than those specified herein may result in hazardous radiation exposure.
- The socket-outlet shall be installed near the machine and shall be easily accessible.

Important points when selecting an installation site

Do not install your machine in areas that are:

- damp, humid, or very dusty
- exposed to direct sunlight
- poorly ventilated
- subject to extreme temperature or humidity changes, e.g., near an air conditioner or heater.

Be sure to allow the required space around the machine for servicing and proper ventilation.

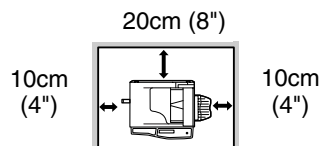

Cautions on handling the machine

Be careful in handling the machine as follows to maintain the performance of this machine.

Do not drop the machine, subject it to shock or strike it against any object.

Do not expose the drum cartridge to direct sunlight.

- Doing so will damage the surface (green portion) of the drum cartridge, causing smudges on copies.

Store spare supplies such as drum cartridges and TD cartridges in a dark place without removing from the package before use.

- If they are exposed to direct sunlight, smudges on copies may result.

Do not touch the surface (green portion) of the drum cartridge.

- Doing so will damage the surface of the cartridge, causing smudges on copies.

Cautions on laser

| | |
|--------------|-----------------------|
| Wave length | 770 nm – 795 nm |
| Pulse times | 10.24 μ s / 7 mm |
| Output power | 0.17 mW \pm 0.01 mW |

Trademark acknowledgements

- Microsoft® Windows® operating system is a trademark or copyright of Microsoft Corporation in the U.S.A. and other countries.
- Windows® 95, Windows® 98, Windows® Me, Windows NT® 4.0, Windows® 2000, and Windows® XP are trademarks or copyrights of Microsoft Corporation in the U.S.A. and other countries.
- IBM and PC/AT are trademarks of International Business Machines Corporation.
- Acrobat® Reader Copyright® 1987- 2002 Adobe Systems Incorporated. All rights reserved. Adobe, the Adobe logo, Acrobat, and the Acrobat logo are trademarks of Adobe Systems Incorporated.
- All other trademarks and copyrights are the property of their respective owners.

ENVIRONMENTAL INFORMATION



As an ENERGY STAR® Partner, SHARP has determined that this product meets the ENERGY STAR® guidelines for energy efficiency.

A small amount of ozone is produced within the unit during operation. The emission level is insufficient to cause any health hazard.

Note:

The present recommended long term exposure limit for ozone is 0.1ppm (0.2mg/m³) calculated as an 8hr. time-weighted average concentration.

However, since the small amount that is emitted may have an objectionable odor, it is advisable to place the unit in a ventilated area.



USB 2.0 compatible

When connecting the machine by USB 2.0 (Hi-Speed mode), be sure to read "System requirements for USB 2.0 (Hi-Speed mode)" (p.59) to verify that your system and the machine settings are configured appropriately.

INTRODUCTION



Some model may not be available in some countries.

Using the manual

This machine has been designed to provide convenient copying features in a minimum amount of office space and with maximum operational ease. To get full use of all machine features, be sure to familiarize yourself with this manual and the machine. For quick reference during machine use, keep this manual in a handy location.

About the operation manuals

The operation manuals for the machine are as follows:

Operation Manual (this manual)

Explains the machine and how to use it as a copier. Also explains how to install the software that allows the machine to be used as a printer and scanner for your computer.

Online Manual (on the accessory CD-ROM)

This manual explains the procedures for using the machine as a printer or a scanner.

Operation Manual (for facsimile) (for models that have the fax function)

This manual explains the procedures for using the machine as a fax machine.

Conventions used in this manual and online manual

- The illustrations in this manual show the AL-1556. The appearance of your machine may be different depending on the model and options installed, however, the basic operations are the same.
- Where "AL-XXXX" appears in this manual, please substitute the name of your model for "XXXX". For the name of your model, see the operation panel on the machine.
- Illustrations of driver screens and other computer screens show the screens that appear in Windows XP Home Edition. Some of the names that appear in these illustrations may differ slightly from the screens that appear in other operating systems.
- The explanations in this manual assume that the person who will install the product and the users of the product have a working knowledge of Microsoft Windows.
- This operation manual refers to the Reversing Single Pass Feeder as the "RSPF".
- In this manual, the following icons are used to provide the user with information pertinent to the use of the machine.



Warns that injury may result if the contents of the warning are not properly followed.



Cautions that damage to the machine or one of its components may result if the contents of the caution are not properly followed.



Notes provide useful information on the specifications, functions, performance, and operation of the machine.

MAIN FEATURES

High-speed laser copying

First-copy time*¹ at 300 dpi*² is only 9.6 seconds.

Copying speed is 15 copies per minute. This is ideal for business use and provides a big boost to workplace productivity.

*¹ First-copy time may vary depending on the power-supply voltage, ambient temperature, and other operating conditions.

*² "dpi" ("dots per inch") is unit that is used to measure resolution. Resolution indicates how much detail can be reproduced in a printed or scanned image.

High-quality digital image

- High-quality copying at 600 dpi is performed.
- In addition to automatic exposure adjustment, two original modes can be selected: "TEXT" for text-only originals, and "PHOTO" for photographs. The exposure can be adjusted to five levels in each mode.
- The photo mode copying function allows clear copying of delicate halftone original images such as monochrome photos and color photos.

Enhanced copying features

- Zoom copies can be made from 25% to 400% in increments of 1%. (When the RSPF is being used, the zoom copy ratio range is 50% to 200%.)
- Continuous copying of up to 99 copies is possible.
- Sets of output can be offset from each other for easy separation (offset function).
- Sorting by sets is possible without the need for a sorter or other special device (Sort copy).
- Includes convenient features such as margin shift, 2 IN 1 copy, and automatic two-sided copying.

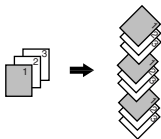

Sort copy

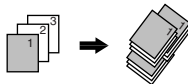

Offset function

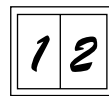

2 IN 1 copy

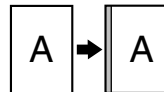

Margin shift

Scan once/Print many

- The machine is equipped with a memory buffer allowing the machine to scan an original once and make up to 99 copies of the scanned image. This improves workflow, reduces operating noise from the machine and reduces wear and tear on the scanning mechanism, which provides for a higher reliability.

LCD panel displays messages

The LCD panel displays messages that show function settings and the status of the machine.

Laser printer function

• Printer function

The accompanying printer driver can be installed to enable use of the machine as a printer.

• Network printer function

A LAN connector is provided as a standard feature that allows the machine to be used as a network printer.

Color scanner function

- The accompanying scanner driver can be installed and the machine connected to a computer using a USB cable to enable use as a scanner.

Environment and people friendly design

- Preheat mode and auto power shut-off mode are provided to reduce power consumption when the machine is not in use.
- A universal design has been implemented in the product whereby the height of the operation panel and shape of the keys are designed to be usable by as many people as possible.

This chapter provides basic information that you should know before using the machine.

PART NAMES

The following illustration shows the part names of the AL-1556.



The illustrations in this manual show the AL-1556. The appearance of your machine may be different depending on the model, however, the basic operations are the same.

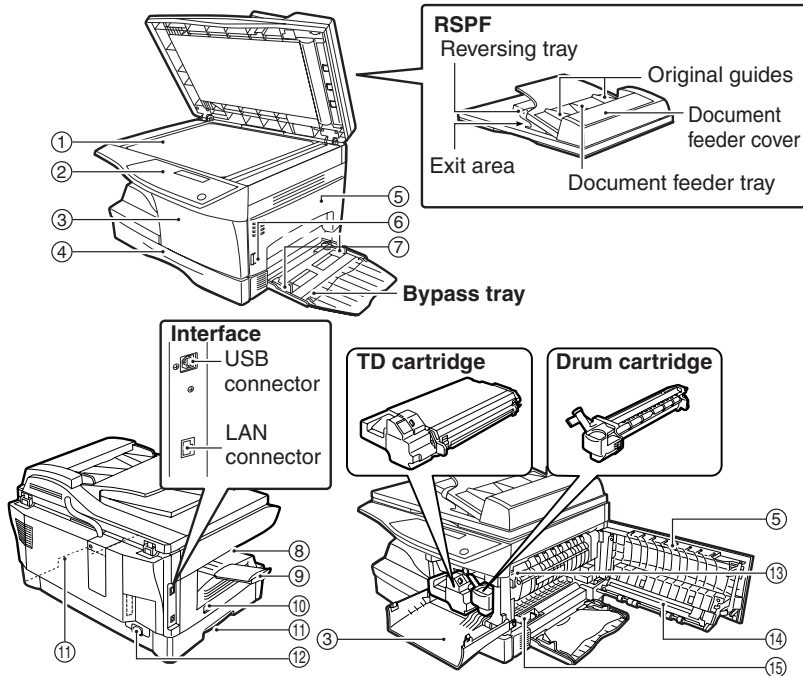

- | | |
|----------------------------|-------------------------------|
| ① Document glass | ⑨ Paper output tray extension |
| ② Operation panel | ⑩ Power switch |
| ③ Front cover | ⑪ Handles |
| ④ Paper tray | ⑫ Power cord socket |
| ⑤ Side cover | ⑬ Fusing unit release lever |
| ⑥ Side cover open button | ⑭ Transfer charger |
| ⑦ Bypass tray paper guides | ⑮ Charger cleaner |
| ⑧ Paper output tray | |



The paper output tray has a paper holder arm. The paper holder arm presses gently on the output paper to stack it.

Operation panel

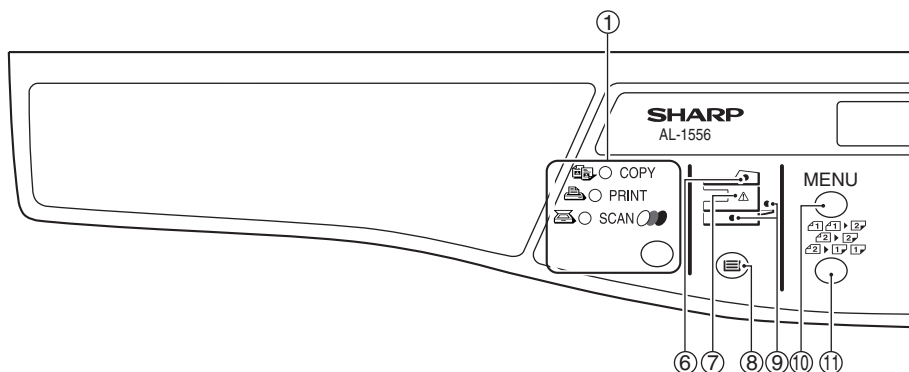

- ① **[MODE SELECT] key / Mode indicators**
Press this key to select the mode. The indicator of the selected mode lights (copy, printer, scanner mode indicators).
- ② **Display**
This shows messages indicating the machine status and any problems that occur, as well as user programs and function setting menus.
- ③ **Numeric keys**
Use these to enter the number of copies and other numerical settings. The keys can also be used to select items in function setting menus.
- ④ **[CLEAR] key (C)**
Use this to clear the set number of copies, as well as cancel a job that is in progress. When a setting menu appears, use this key to move back to the previous menu level.
- ⑤ **Power save indicator**
This lights up when the power save function is activated.
- ⑥ **RSPF indicator**
This lights up when an original is placed in the RSPF.
- ⑦ **Error indicator**
This lights steadily or blinks when a paper misfeed or other error occurs.
- ⑧ **[TRAY SELECT] key ()**
Use to select the paper tray that has the desired paper for copying.
- ⑨ **Tray location indicator**
Indicates the selected paper tray. The indicator blinks when the tray is out of paper or is not closed.
- ⑩ **[MENU] key**
Press this key to select the paper size for copying, to configure a user program or to display the total count.
- ⑪ **[2-SIDED COPY ()] key**
Use to copy both sides of an original.
- ⑫ **[E-SORT/SP.FUN ()] key**
Press to select the sort function, 2 IN 1 copy function, or margin shift function.
- ⑬ **[◀] key (), [▶] key (), [OK] key**
Press the [◀] key () or [▶] key () to select an item in a function setting menu. Press the [OK] key to enter a selection.
- ⑭ **[EXPOSURE ()] key**
Use to switch from auto exposure adjustment to text mode or photo mode.

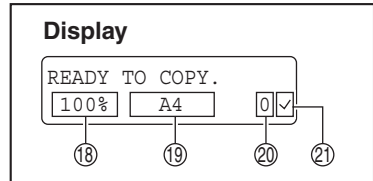
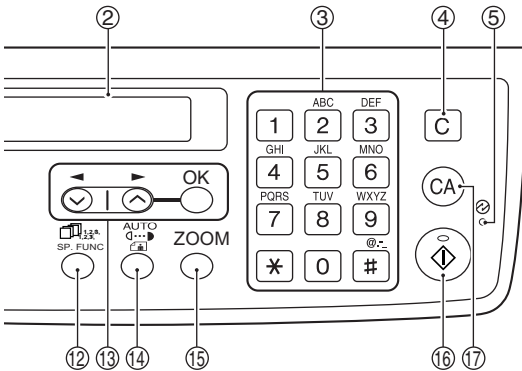

15 [ZOOM] key

Press to select an enlargement or reduction ratio.

To select a preset ratio setting, press the [ZOOM] key and select the desired preset ratio. To select a ratio that is not preset, press the [ZOOM] key, select the preset ratio that is closest to the desired ratio, and then press the [◀] key (▼) or [▶] key (▲) to increase or decrease the ratio in increments of 1%.

16 [START] key (⏻) / Ready indicator

The ready indicator lights up when copying or scanning is possible.

To begin copying, press the [START] key (⏻).

The [START] key (⏻) is also pressed to return to normal operation from auto power shut-off mode.

17 [CLEAR ALL] key (CA)

This returns all functions to the default settings. When pressed in a setting menu, this returns the settings and display to the initial state.

18 Shows the current copy ratio.

19 Shows the selected paper size.

20 Shows the number of copies that has been entered with the numeric keys.

21 A checkmark "✓" appears when the exposure has been changed, or when two-sided copying, sort, 2 IN 1, or margin shift is selected.

CHECKING PACKED COMPONENTS AND ACCESSORIES

Open the carton and check if the following components and accessories are included.

If anything is missing or damaged, contact your authorized service representative.



Note If the machine does not function properly during setup or use, or if a function cannot be used, see "TROUBLESHOOTING AND MAINTENANCE" (p.71).

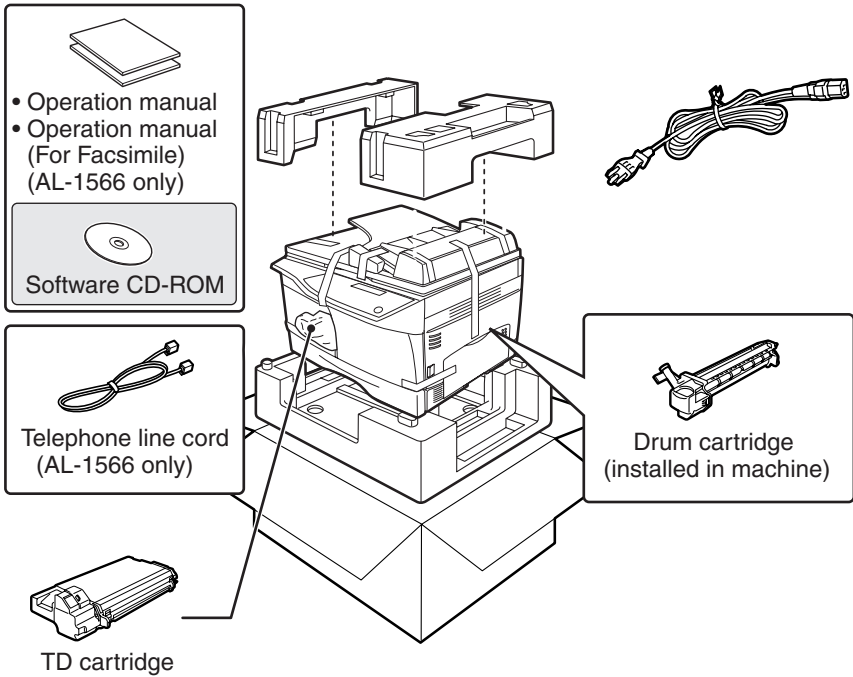

PREPARING THE MACHINE FOR INSTALLATION

- 1** Be sure to hold the handles on both sides of the machine to unpack the machine and carry it to the installation location.

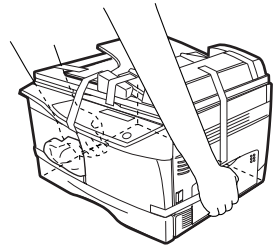

- 2** Remove all pieces of tape shown in the illustration below and then open the RSPF and remove the protective materials. Take out the bag containing the TD cartridge.

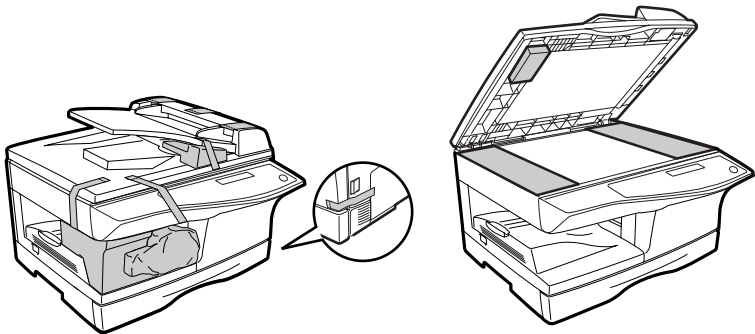

- 3** Release the scan head locking switch.

The scan head locking switch is under the document glass. If the switch is locked (🔒), the machine will not operate. Unlock the switch (🔓) as shown below.

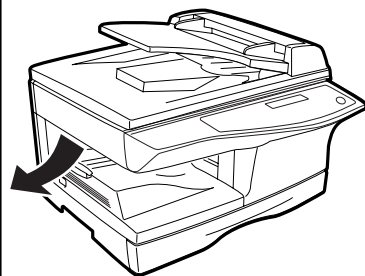
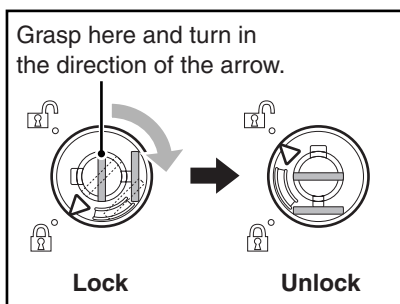

INSTALLING THE TD CARTRIDGE

- 1** Open the bypass tray, and then open the side cover.

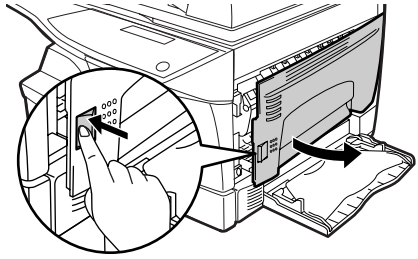

- 2** Press gently on both sides of the front cover to open the cover.

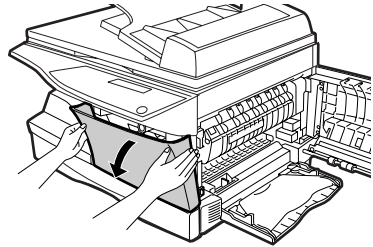

- 3** Remove the TD cartridge from the bag. Remove the protective paper. Hold the cartridge on both sides and shake it horizontally four or five times. Hold the tab of the protective cover and pull the tab to your side to remove the cover.

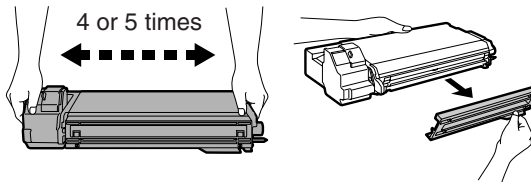

- 4** While pushing the lock release button, gently insert the TD cartridge until it locks into place.

Lock release button

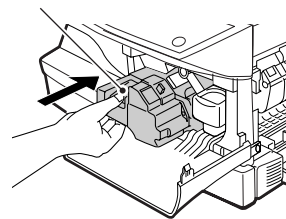

- 5** Close the front cover and then the side cover by pressing the round projections near the side cover open button.

Caution

When closing the covers, be sure to close the front cover securely and then close the side cover. If the covers are closed in the wrong order, the covers may be damaged.

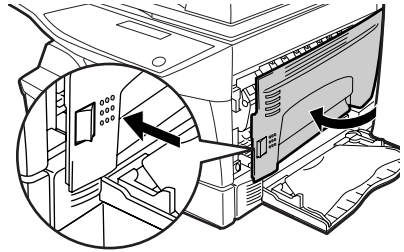
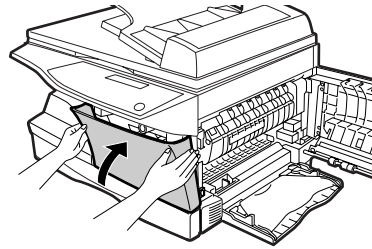

- 6** Ensure that the power switch of the unit is in the OFF position. Insert the attached power cord into the power cord socket at the rear of the unit.

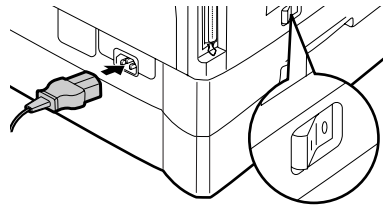

- 7** Plug the other end of the power cord into the nearest outlet.

Caution

Only insert the power cord into a properly grounded wall socket. Do not use extension cords or power strips.

POWER ON AND OFF

The power switch is located on the left side of the machine.



If you use the machine in a country other than the country where the machine was purchased, you will need to make sure that your local power supply is compatible with your model. If you plug the machine into an incompatible power supply, irreparable damage to the machine will result.

Power on

Turn the power switch to the "ON" position.

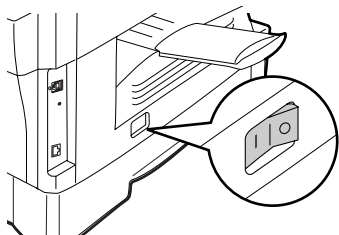

The ready indicator will light up and other indicators which show the initial settings of the display will also light up to indicate the ready condition. For the initial settings, see the "Initial settings" (below).

You can select copy settings and press the [START] key (⊕) during warm-up. Copying will start after warm-up.

The first time the power is turned on after shipment from the factory, a message will appear in the display asking you to select the language. Select the language with the [◀] key (⊙) or [▶] key (⊙) and then press the [OK] key.

Initial settings

The machine reverts to the initial settings when it is first turned on, when the [CLEAR ALL] key (⊕) is pressed, or when no keys are pressed for the preset "AUTO CLEAR" time following the end of a copy job. When the machine reverts to the initial settings, all settings and functions selected to that point are canceled. The "AUTO CLEAR" can be changed in the user programs. (p.64)

When in the copy mode

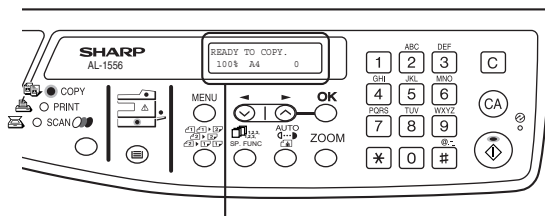

The main screen of copy mode appears.

Copy ratio: 100%, Exposure: Automatic
Copy quantity: 0, All special copier modes: Off

About the scan head

The scan head lamp remains on constantly when the machine is in the ready condition (when the ready indicator is illuminated).

The machine adjusts the scan head lamp periodically to maintain copying quality. At this time, the scan head moves automatically. This is normal and does not indicate machine trouble.

Power off

Make sure that the machine is not in operation and then turn the power switch to the "OFF" position.

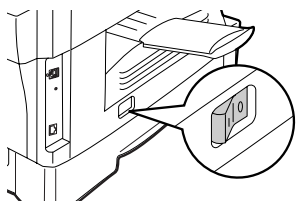

If the power switch is turned off while the machine is in operation, a misfeed may occur and the job that was in progress will be canceled.

In cases where the machine will not be used for a long time, turn off the power switch and remove the power cord from the outlet.

Check the following to make sure the machine is not in operation:

- The ready indicator is lit. (Initial state)
- The power save indicator is lit. (preheat mode or auto shut-off mode)

Power save modes



The machine has two power save modes to reduce overall power consumption and thereby reduce the cost of operation. In addition, these modes conserve natural resources and help reduce environmental pollution. The two power save modes are preheat mode and auto power shut-off mode.

Preheat mode

This function automatically switches the machine to a low power consumption state if the set duration of time elapses without the machine being used when the power is on. In this mode, the power save indicator lights up. Normal operation automatically resumes when a key on the operation panel is pressed, an original is placed, a print job is received.

Auto power shut-off mode

This function automatically switches the machine to a state that consumes even less power than preheat mode if the set duration of time elapses without the machine being used when the power is on. The power save indicator lights up, the display shows a message indicating that the machine is in auto power shut-off mode. To resume normal operation, press the [START] key (⊕). Normal operation also resumes automatically when a print job is received or scanning is begun from a computer. While in auto power shut-off mode, no keys (except the [START] key (⊕)) can be used.



The preheat activation time and the auto power shut-off time can be changed with "PREHEAT MODE" and "AUTO SHUT-OFF TIME" in the user programs. It is suggested that you set times that are appropriate for your usage of the machine. (p.64)

The tray location indicator will blink when there is no paper in the selected paper tray, or when the selected paper tray is not installed or is improperly installed.

PAPER

For best results, use only SHARP recommended paper.

| Paper tray type | Paper type | Size | Weight | Capacity |
|-----------------|----------------------------------|--|---|---|
| Paper tray | Standard paper Recycled paper | A4 B5 A5 | 56 g/m ² to 80 g/m ² | 250 sheets * ¹ (The paper should not exceed the line on the tray) |
| Bypass tray | Standard paper Recycled paper | A4 B5 | 56 g/m ² to 80 g/m ² | 50 sheets * ¹ Load one sheet at a time in the bypass tray. |
| | Thick paper | A5 B6 | 52 g/m ² to 128 g/m ² * ³ | |
| | Transparency film/Labels | A6 Letter Legal Invoice | | |
| | Envelopes * ² | International DL International C5 Monarch Commercial 9 Commercial 10 | | |

*¹ The number of sheets of paper that can be loaded varies depending on the weight of the paper.

*² Do not use non-standard envelopes or envelopes that have metal clasps, plastic snappers, strings, windows, linings, self-adhesive strips, patches or synthetic materials. Do not use envelopes that are filled with air or envelopes that have labels or stamps attached. These will damage the machine.

*³ When loading paper larger than A4 size, do not use paper of weight greater than 105 g/m².

Special papers

Follow these guidelines when using special papers.

- Use SHARP recommended transparency film and label sheets. Using other than SHARP recommended paper may result in misfeeds or smudges on the output. If other than SHARP recommended media must be used, feed each sheet one at a time using the bypass tray (do not attempt continuous copying or printing).
- There are many varieties of special paper available on the market, and some cannot be used with this machine. Before using special paper, contact a SHARP service center.
- Before using other than SHARP recommended paper, make a test copy to see if the paper is suitable.

LOADING THE PAPER TRAY



Make sure that the paper is not torn, is free of dust, and has no wrinkles or curled edges.

- 1** Raise the handle of the paper tray and pull the paper tray out until it stops.

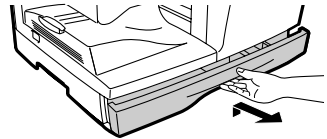

- 2** Remove the pressure plate lock. Rotate the pressure plate lock in the direction of the arrow to remove it while pressing down on the pressure plate of the paper tray.

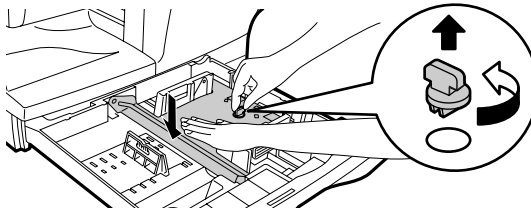

- 3** Store the pressure plate lock which has been removed in step 2. To store the pressure plate lock, rotate the lock to secure it as shown below.

Pressure plate lock

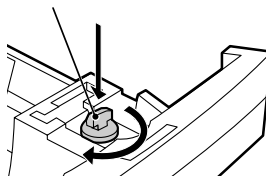

4 Fan the paper and insert it into the tray. Make sure that the edges go under the corner hooks.



- Do not load paper above the maximum height line (▼▼). Exceeding the line will cause a paper misfeed.
- If the paper is not fanned, double-feeds or misfeeds may occur.
- Make sure the stack of paper is straight before loading it. When adding paper, take the remaining paper out and combine it into a single stack with the new paper.
- Make sure that all the paper in the stack is the same size and type.
- When loading paper, ensure that there is no space between the paper and the guide, and make sure that the guide is not set too narrow and causes the paper to bend. Incorrect loading will cause the paper to skew or misfeed.

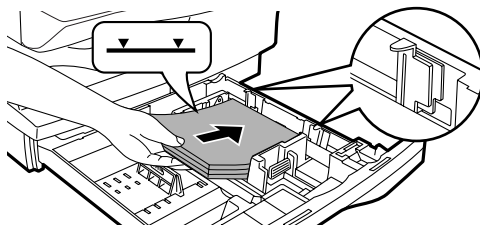

5 Gently push the paper tray back into the machine.



- If you loaded a different size of paper than was loaded previously in the tray, go to "CHANGING A TRAY'S PAPER SIZE SETTING" (p.23)
- When not using the machine for an extended period, remove all paper from the paper tray and store it in a dry place. If paper is left in the machine for an extended period, the paper will absorb moisture from the air, resulting in paper jams.

BYPASS FEED (including special paper)

The bypass tray can be used to feed standard paper, transparency film, labels, envelopes, and other special purpose paper.

Important points when inserting paper in the bypass tray

Up to 50 sheets of standard copy paper can be inserted in the bypass tray. (Capacity will vary depending on the type of paper loaded.)

Be sure to place envelopes horizontally as shown in the following diagram.

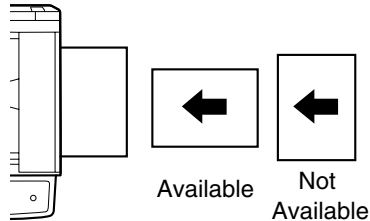

- When loading envelopes, make sure that they are straight and flat and do not have loosely glued construction flaps (not the closure flap).
- Special papers except SHARP recommended transparency film, labels, and envelopes must be fed one sheet at a time through the bypass tray.
- When adding paper, first remove any paper remaining in the tray, combine it with the paper to be added and then reload as a single stack. The paper to be added must be the same size and type as the paper already in the tray.
- Do not use paper that is smaller than the original. This may cause smudges or unclear images.
- Do not use paper that has already been printed on by a laser printer or plain paper fax machine. This may cause smudges or unclear images.

Envelopes

Do not use the following envelopes, as misfeeds will occur.

- Envelopes with metal tabs, clasps, strings, holes, or windows.
- Envelopes with rough fibers, carbon paper, or glossy surfaces.
- Envelopes with two or more flaps.
- Envelopes with tape, film, or paper attached to the flap.
- Envelopes with a fold in the flap.
- Envelopes with glue on the flap to be moistened for sealing.
- Envelopes with labels or stamps.
- Envelopes that are slightly inflated with air.
- Envelopes with glue protruding from the seal area.
- Envelopes with part of the seal area peeled off.
- Be sure to select com9, com10 or Monarch in the paper size setting of the printer driver. (For detailed information on the printer driver, refer to the online manual.)

Loading paper in the bypass tray



Note

- Paper must be fed narrow side first into the feed slot.
- Special papers such as transparency film, labels, and envelopes must be fed one sheet at a time through the bypass tray.
- When copying onto transparency film, remove each copy promptly. Do not let copies stack up.

1 Open the bypass tray and extend the tray.

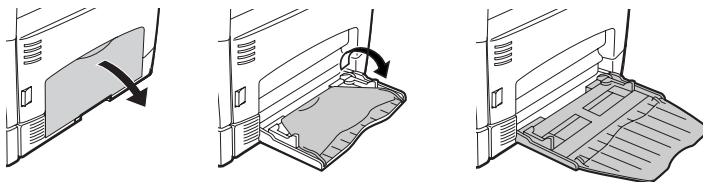

Note

To close the bypass tray, perform step 1 and then step 2 in the illustration and push the round projections at the right of the tray until they click.

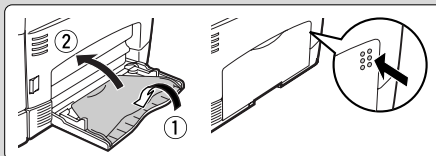

2 Set the bypass tray paper guides to the paper width. Insert the paper (print face down) all the way into the bypass tray.

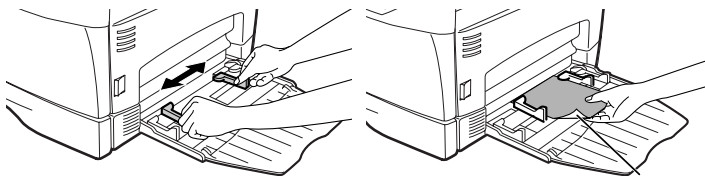

Print face

3 Press the [TRAY SELECT] key (⊞) to select the bypass tray.

CHANGING A TRAY'S PAPER SIZE SETTING

Follow these steps to change a tray's paper size setting.



- The paper size setting cannot be changed when the machine has stopped temporarily due to running out of paper or a misfeed.
- During printing (even in copy mode), the paper size setting cannot be changed.

1 Press the [MENU] key.
Press the [◀] key (⏴) or [▶] key (⏵) until "PAPER SIZE" appears, and then press the [OK] key.

2 Press the [OK] key to select the tray.

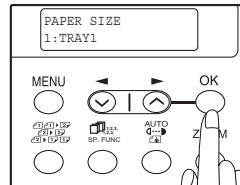

3 Press the [◀] key (⏴) or [▶] key (⏵) to select the paper size, and then press the [OK] key.

The paper size changes as follows each time the [◀] key (⏴) or [▶] key (⏵) is pressed:
"A4" → "B5" → "A5" → "8,5x14" → "8,5x13" → "8,5x11"
→ "5,5x8,5".

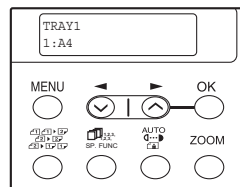

When you have finished configuring the tray's paper size setting, press the [MENU] key.

4 Squeeze the lock lever of the front guide and slide the front guide to match the width of the paper, and move the left guide to the appropriate slot as marked on the tray.

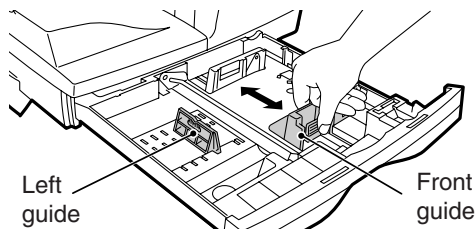

- The front guide is a slide-type guide. Grasp the locking knob on the guide and slide the guide to the indicator line of the paper to be loaded.
- The left guide is an insert-type guide. Remove it and then insert it at the indicator line of the paper to be loaded.

2

This chapter explains basic copying functions.

NORMAL COPYING

Using the document glass



- The document glass can scan up to an A4 original.
- When a copy is made, the edges will not be copied (image loss). For the image loss, see the "SPECIFICATIONS" (p.92).

1 Open the RSPF, and place the original face down on the document glass.

[How to place the original]

Align the original with the original scale and the centering (▶) mark.

Original scale

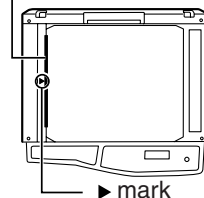

2 Gently close the RSPF.

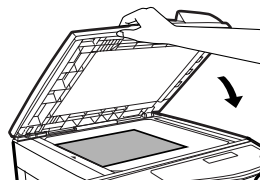

3 Select the number of copies and other copy settings, and then press the [START] key (⊙).



- To stop copying in the middle of a run, press the [CLEAR] key (⊞).
- For the copy settings, see pages 26 through 39.

Copying books or originals with folds or creases

Press down on the RSPF while copying as shown. If the RSPF is not completely closed, shadows may appear on the copy or it may be fuzzy. Straight originals with folds or creases well before placing.

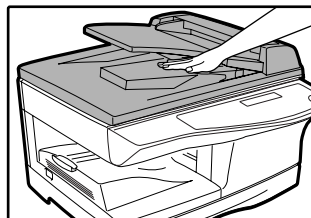

Using the RSPF



- Originals that are A5 to A4 and 52 g/m² to 90 g/m² can be used. A maximum of 30 pages can be placed at once.
- Straighten curled originals before placing them in the document feeder tray. Curled originals may cause misfeeds.
- Place originals horizontally.
- Before placing originals in the document feeder tray, be sure to remove any staples or paper clips from them.
- When a copy is made, the edges will not be copied (image loss). For the image loss, see the "SPECIFICATIONS" (p.92).
- When using the margin shift function, check the position of the margins carefully. (p.38)

1 Make sure that an original has not been left on the document glass.

2 Adjust the original guides to the size of the originals.

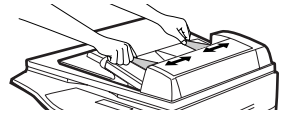

3 Set the original(s) face up in the document feeder tray.

The RSPF indicator on the operation panel will light up. If this indicator does not light up, the originals are not properly set or the RSPF is not properly closed.

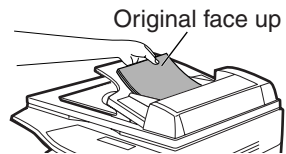

4 Select the number of copies and other copy settings, and then press the [START] key (⏏).



- To stop copying in the middle of a run, press the [CLEAR] key (⏏).
- For the copy settings, see pages 26 through 39.

MAKING COPIES

Originals that cannot be used in the RSPF

The following originals cannot be used. These may cause misfeeds or smudging and unclear images.

- Transparencies, tracing paper, other transparent or translucent paper, and photographs.
- Carbon paper, thermal paper.
- Originals that are creased, folded, or torn.
- Glued originals, cut-out originals.
- Originals with binder holes.
- Originals printed using an ink ribbon (thermal transfer printing), originals on thermal transfer paper.

Stream feeding mode

"SET ORIGINALS FOR STREAM FEEDING" will appear in the display for five seconds after all originals are fed. If a new original is placed in the RSPF during this time, the original will be automatically fed in and copying will begin with the same setting. The stream feeding mode is disabled in "STREAM FEEDING" in the user programs (p.65).



When copying onto paper larger than A4 size, pull out the paper output tray extension.

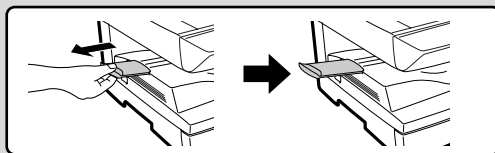

Capacity of paper output tray

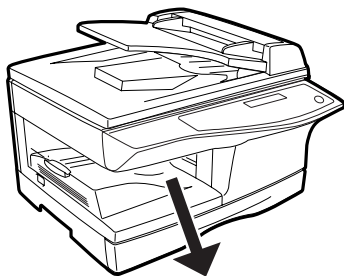

Maximum number of pages that can be held in the tray: 250



- The paper output tray can hold a maximum of 250 pages. If more than 250 pages are allowed to accumulate, a paper jam may occur.
- After removing paper, if you need to return the paper to the paper output tray, lift up the paper holder arm and place the paper under the arm.

Setting the number of copies

Press the numeric keys to set the number of copies.

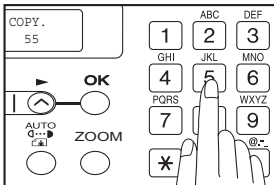

- The set number of copies appears in the display. A maximum of 99 copies can be set.
- If you wish to make only a single copy, copying is possible with the display showing "0".



If you enter the wrong number, press the [CLEAR] key (C) and enter the correct number.

SELECTING THE TRAY

Press the [TRAY SELECT] key (☰).

Each time, you press the [TRAY SELECT] key (☰), the location indicated by the tray location indicator changes in the following order : paper tray → bypass tray.

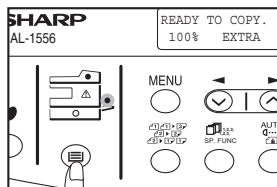

The tray location indicator will blink when there is no paper in the paper tray, or when the tray is not closed or is improperly closed.

MAKING A COPY DARKER OR LIGHTER





Automatic exposure adjustment is initially enabled. This function automatically adjusts the copy image according to the original being copied. If you wish to select the exposure level yourself, follow the steps below. (Select from two original types and five exposure levels for each original type.) The exposure level used in automatic exposure adjustment can also be changed with "AE LEVEL ADJUST" in the user programs (p.67).

Original types



- **AUTO** Automatic exposure adjustment is enabled and the exposure is automatically adjusted according to the original being copied. The exposure is lowered for colored areas and background shadows.
- **TEXT** The exposure is raised for light areas and lowered for dark backgrounds to make text easier to read.
- **PHOTO** ... Halftones in the photo are reproduced with greater clarity.

1 Check the original and place the original(s).

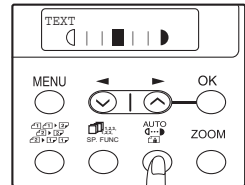

2 Press the [EXPOSURE ()] key to select the original type.

The original image type changes as follows each time the [EXPOSURE ()] key is pressed:
"AUTO" () → "TEXT" () → "PHOTO" ().



To return to auto exposure adjustment, press the [EXPOSURE ()] key until "AUTO" () appears.

3 If needed, adjust the exposure level for **TEXT** () or **PHOTO** ().

For a darker image, press the [▶] key (). For a lighter image, press the [◀] key ().

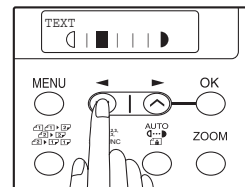

4 Press the [OK] key.

5 Select the number of copies and any other copy settings, and then press the [START] key ().



Exposure value guidelines (When in "TEXT" () setting)

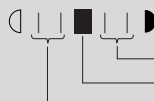

- Colored text or text written in pencil
- Normal originals
- Dark originals like newspapers

REDUCTION/ENLARGEMENT/ZOOM

Copies can be reduced down to 25% or enlarged up to 400%. (When the RSPF is being used, the zoom copy ratio range is 50% to 200%.) The [ZOOM] key can be pressed to quickly select a ratio from among eight preset ratios. In addition, the [◀] key (⏪) and [▶] key (⏩) can be pressed to select the ratio in increments of 1%.

1 Check the original and paper size, and place the original(s).

2 Press the [ZOOM] key.

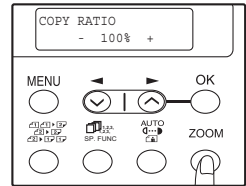

3 Press the [ZOOM] key and/or [◀] key (⏪) or [▶] key (⏩) to select the desired copy ratio and then press the [OK] key.

Selecting a preset ratio

The preset ratios change as follows each time the [ZOOM] key is pressed:

"100%" → "86%" → "70%" → "50%" → "25%" → "400%" → "200%" → "141%".

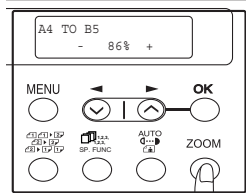

Fine adjustment of the ratio

The ratio can be adjusted from 25% to 400% in increments of 1%.

Use the [◀] key (⏪) or the [▶] key (⏩) for fine adjustment.

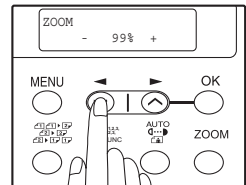

- To return the ratio to 100%, press the [ZOOM] key until 100% appears.
- Press the [ZOOM] key to set the approximate ratio, then press the [◀] key (⏪) or [▶] key (⏩).
- To decrease or increase the zoom ratio rapidly, hold down the [◀] key (⏪) or [▶] key (⏩).
The ratio will stop changing at each of the preset ratios. To continue changing the ratio, release the key and then hold it down again.

4 Select the number of copies and any other copy settings, and then press the [START] key (⏻).

The copy will be delivered to the paper output tray.

3

AUTOMATIC TWO-SIDED COPYING

Two originals can be automatically copied onto both sides of a single sheet of paper. When the RSPF is used, two-sided copies of two-sided originals can easily be made.

| | Original → Paper | | | Usable paper |
|----------------|--------------------------------|--------------------------------|-------------------------------|--|
| Document glass | One-sided original → Two sides | | | A4, B5, A5 • The bypass tray cannot be used. |
| | | | | |
| RSPF | One-sided original → Two sides | Two-sided original → Two sides | Two-sided original → One side | A4, B5, A5 • Special paper cannot be used. • The bypass tray can only be used when making one-sided copies from two-sided originals. |
| | | | | |
| | | | | |

When performing automatic two-sided copying of one-sided originals, the orientation of the copied image can be selected according to the binding position of the paper.

SHORT EDGE: Select when binding the paper at the short edge.



(Paper orientation: Landscape) (Paper orientation: Portrait)

LONG EDGE: Select when binding the paper at the long edge.



(Paper orientation: Landscape) (Paper orientation: Portrait)

Using the document glass

1 Place the original that you wish to copy onto the front side of the paper on the document glass and close the RSPF.

2 Press the [2-SIDED COPY ()] key until "1 TO 2" appears, and then press the [OK] key.

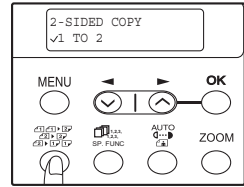

3 Press the [◀] key () or [▶] key () to select the binding edge and then press the [OK] key.

Select "LONG EDGE" or "SHORT EDGE". The "LONG EDGE" and "SHORT EDGE" are shown in the illustration on the preceding page.

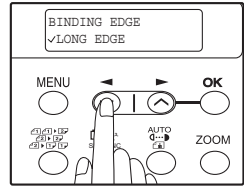

4 Select the number of copies and any other settings, and then press the [START] key ().

The original for the front side is scanned into the memory.



- If you need to clear the data scanned into memory, press the [CLEAR] key ().
- If you wish to cancel two-sided copying and just make a copy of the first original, press the [#] key.

5 When "[START] : NEXT SCAN [#] : START PRINT" appears, remove the first original and then place the original that you wish to copy onto the back side of the paper on the document glass. Close the RSPF.

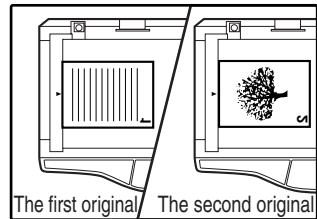

Place the second original in the same orientation as the first original.



6 Press the [START] key ().

The copy will be delivered to the paper output tray.



To cancel automatic two-sided copying, press the [CLEAR ALL] key () or press the [2-SIDED COPY ()] key, select the "1 TO 1", and then press the [OK] key.

4

Using the RSPF

1 Place the original(s) in the RSPF. (p.25)

If you place an odd number of originals for one-sided to two-sided copying, the last page will be one-sided.

2 Press the [2-SIDED COPY] key and select the two-sided copy mode that you wish to use.

The mode changes as follows each time you press the [2-SIDED COPY] key: "1 TO 1", "1 TO 2", "2 TO 2", "2 TO 1"

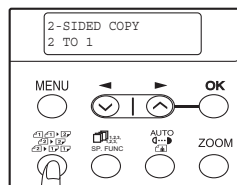

- Two-sided copies from one-sided originals: "1 TO 2"
- Two-sided copies from two-sided originals: "2 TO 2"
- One-sided copies from two-sided originals: "2 TO 1"

3 Press the [OK] key.

If you selected "1 TO 2" in step 2, select "LONG EDGE" or "SHORT EDGE" and press the [OK] key. LONG EDGE and SHORT EDGE are shown in the illustration on page 30.

4 If you selected "2 TO 2" or "2 TO 1", press the [◀] key (⏪) or [▶] key (⏩) to select the original size and then press the [OK] key.

The following original sizes can be selected: "A4", "B5", "A5", "8.5x14", "8.5x13", "8.5x11", "8.5x5.5"

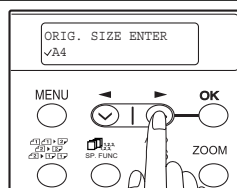

5 Select the number of copies and any other copy settings, and press the [START] key.

The copy will be delivered to the paper output tray.



- To cancel automatic two-sided copying, press the [CLEAR ALL] key (CA) or press the [2-SIDED COPY] key, select the "1 TO 1", and then press the [OK] key.
- Do not touch the reversing tray while automatic two-sided copying is in progress.

SORT COPY

Copies of multiple original pages can be sorted into sets.



The number of pages that can be scanned varies depending on the original type (photo, text, etc.) and the amount of memory allocated to the printer. The amount of memory allocated to the printer can be changed with "MEM. FOR PRINTER" in the user programs. (p.66)

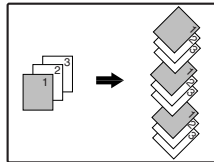

Sort copy

Using the document glass

1 Place the first original. (p.24)

2 Press the [E-SORT/SP.FUN] () key until "SORT" appears and then press the [OK] key.

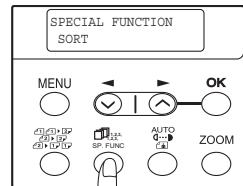

3 Press the [←] key () to move "✓" to the "ON" position and then press the [OK] key.

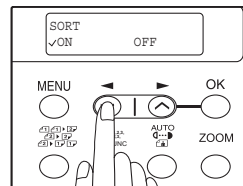



4 Select the number of copies and any other settings, and then press the [START] key () .

"[START] : NEXT SCAN [#] : START PRINT" appears and the original is scanned into memory.

5 Replace the original with the next original, and then press the [START] key () .

Repeat step 5 until all originals have been scanned into memory.





To clear the data in memory, press the [CLEAR] key () . When the [CLEAR] key () is pressed, the number of copies setting is also cleared.

6 When all originals have been scanned, press the [#] key.

The copies are delivered to the paper output tray.



- To cancel the sort copy job, press the [CLEAR] key () .
- To cancel sort copy mode, press the [CLEAR ALL] key () .

4

Using the RSPF

1 Place the originals. (p.25)



- If "SORT AUTO SELCT" is enabled in the user programs, the default output mode for copying from the RSPF is sort mode (p.65). In this case go directly to step 4. A checkmark "✓" will automatically appear in the display (p.11).
- If "SORT AUTO SELECT" is disabled, the default output mode will be non-sort mode. Follow the steps below to select sort mode.

2 Press the [E-SORT/SP.FUN ()] key until "SORT" appears and then press the [OK] key.

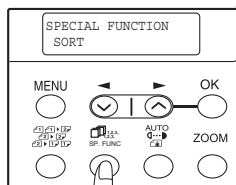

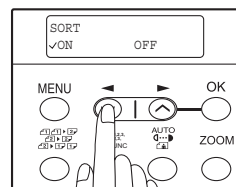

3 Press the [◀] key () to move "✓" to the "ON" position and then the [OK] key.





4 Select the number of copies and any other settings, and then press the [START] key ().

The copies are delivered to the paper output tray.



- To cancel the sort copy job, press the [CLEAR] key ().
- To cancel sort copy mode, press the [CLEAR ALL] key ().

If the memory becomes full

- If the memory becomes full while scanning the originals, "MEMORY FULL, PRESS START TO RESUME" will appear in the display, and the machine will stop copying.
- To copy the originals that have been scanned up to that point, press the [START] key ().
- To clear the data that has been scanned into memory, press the [CLEAR ALL] key () or the [CLEAR] key ().

Offset function during sort copy

The offset function shifts the position of each set of copies in the paper output tray for easy separation.

The offset function can be changed with "OFFSET FUNCTION" in the user programs. (p.65)

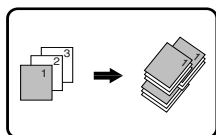

Offset function

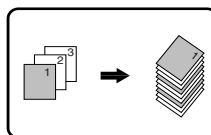

When offset function is disabled

COPYING MULTIPLE ORIGINALS ONTO A SINGLE SHEET OF PAPER (2 IN 1 copy)

Multiple originals can be copied onto a single sheet of paper in a selected layout pattern.

This function is convenient for compiling multi-page reference materials into a compact format, or for providing an overview of all pages of a document on a single page.

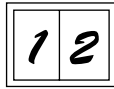

Pattern 1

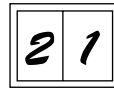

Pattern 2



- An appropriate ratio setting will be automatically selected based on the size of the originals, the size of the paper. When using the document glass, reduction is possible to 25%. When using the RSPF, reduction is possible to 50%. Certain combinations of original size and paper size.
- 2 IN 1 copying cannot be used in combination with the margin shift copying.
- The 2 IN 1 layout pattern can be changed with "LAYOUT IN 2IN1" in the user programs (p.65).
- The bypass tray cannot be used for 2 IN 1 copying.

4

Using the document glass

1 Place the first original. (p.24)

2 Press the [E-SORT/SP.FUN (SP. FUNC)] key until "2IN1" appears and then press the [OK] key.

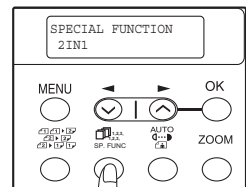

3 Press the [◀] key (✓) to move "✓" to the "ON" position and then press the [OK] key.

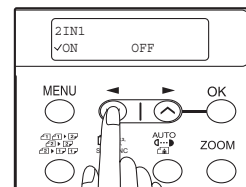

CONVENIENT COPY FUNCTIONS

- 4** Press the [◀] key (⏴) or [▶] key (⏵) to select the original size and then press the [OK] key.

The following original sizes can be selected:
"A4", "B5", "A5", "8.5x14", "8.5x13", "8.5x11",
"8.5x5.5"

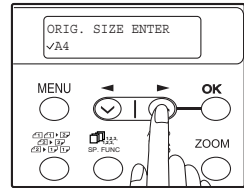

- 5** Set the number of copies and any other settings, and then press the [START] key (⏻).

"[START] : NEXT SCAN [#] : START PRINT" appears and the original is scanned into memory.

To immediately print the scanned image, press the [#] key.

- 6** Replace the original with the next original, and then press the [START] key (⏻).

Repeat step 6 until all originals have been scanned.

Copies will be output each time two originals have been scanned.

If the number of original pages is odd, press the [#] key after all pages have been scanned.



- To clear the data in memory, press the [CLEAR] key (C).
When the [CLEAR] key (C) is pressed, the number of copies setting is also cleared.
- To cancel 2 IN 1 copying, press the [CLEAR] key (C).
- To cancel 2 IN 1 copy mode, press the [CLEAR ALL] key (CA).

Using the RSPF

1 Place the originals. (p.25)

2 Press the [E-SORT/SP.FUN] key until "2IN1" appears and then press the [OK] key.

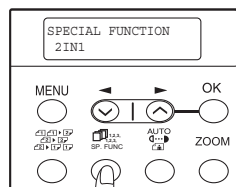

3 Press the [◀] key (✓) to move "✓" to the "ON" position and then press the [OK] key.

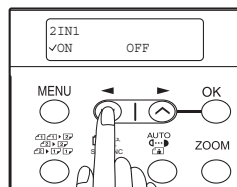

4 Press the [◀] key (✓) or [▶] key (⊙) to select the original size and then press the [OK] key.

The following original sizes can be selected:
 "A4", "B5", "A5", "8.5x14", "8.5x13", "8.5x11",
 "8.5x5.5"

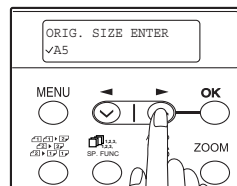

5 Select the number of copies and other settings, and press the [START] key (⊙).

The copy is delivered to the paper output tray.



- To cancel 2 IN 1 copying, press the [CLEAR] key (C).
- To cancel 2 IN 1 copy mode, press the [CLEAR ALL] key (CA).

4

CREATING MARGINS WHEN COPYING

(Margin shift)

The margin shift function is used to automatically shift the text or image or the copy paper approximately 10mm.

As shown below, LONG EDGE or SHORT EDGE can be selected.

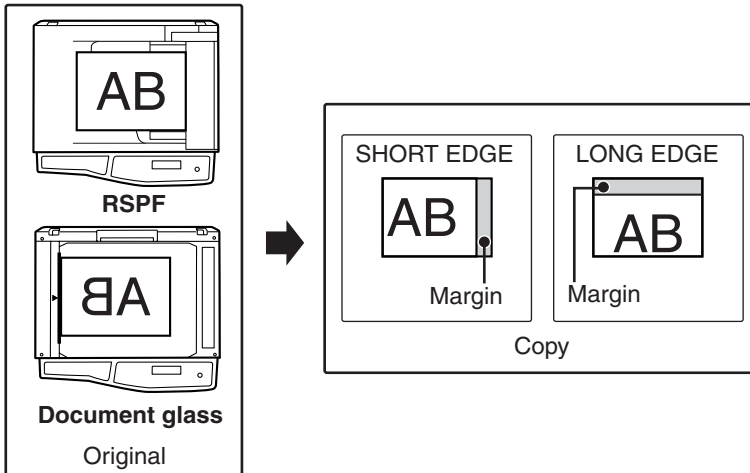

Note

- This feature cannot be used with the 2 IN 1 feature.
- The margin width can be changed with "MARGIN WIDTH" in the user programs. (p.66)
- Note that a margin is created by shifting the image, and thus if the image is shifted too far, the edge of the image may be cut off.

1 Place the original(s).

2 Press the [E-SORT/SP.FUN ()] key until "MARGIN SHIFT" appears and then press the [OK] key.

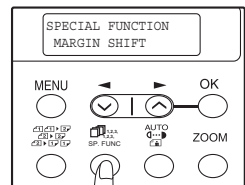

- 3** Press the [◀] key (⏏) to move "✓" to the "ON" position and then press the [OK] key.

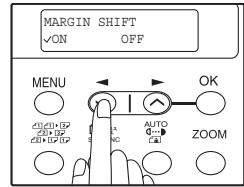

- 4** Press the [◀] key (⏏) or [▶] key (⏏) to select the margin position and then press the [OK] key.
 Select "LONG EDGE" or "SHORT EDGE".
 For the margin position, see the previous page.

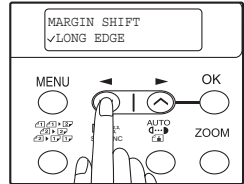

- 5** Select the number of copies and other settings, and then press the [START] key (⏏).
 The copy is delivered to the paper output tray.



- To cancel margin shift copying, press the [CLEAR] key (⏏).
- To cancel margin shift, press the [CLEAR ALL] key (⏏).

This chapter explains how to install and configure the software that is required for the printer and scanner functions of the machine. The procedure for viewing the Online Manual is also explained.

**Note**

- The screen images in this manual are mainly for Windows XP. With other versions of Windows, some screen images may be different from those in this manual.
- Where "AL-XXXX" appears in this manual, please substitute the name of your model for "XXXX". For the name of your model, see the operation panel on the machine.
- This manual refers to the CD-ROM that accompanied the machine simply as "CD-ROM".

SOFTWARE FOR AL-1556/1566

The CD-ROM that accompanies the machine contains the following software:

MFP driver

Printer driver

The printer driver enables you to use the printer function of the machine.

The printer driver includes the Print Status Window. This is a utility that monitors the machine and informs you of the printing status, the name of the document currently being printed, and error messages.

Please note that the Print Status Window does not operate when the machine is used as a network printer.

Scanner driver (USB only)

The scanner driver allows you to use the scanning function of the machine with TWAIN-compliant and WIA-compliant applications.

Sharpdesk (USB only)

Sharpdesk is an integrated software environment that makes it easy to manage documents and image files, and launch applications.

Button Manager (USB only)

Button Manager allows you to use the scanner menus on the machine to scan a document.

**Note**

The scanning feature can only be used with computers that are running Windows 98/Me/2000/XP and are connected to the machine by a USB cable. If you are running Windows 95/NT 4.0 or are connected to the machine by a LAN connection, only the printer function can be used.

BEFORE INSTALLATION

Hardware and software requirements

Check the following hardware and software requirements in order to install the software.

| | |
|---|---|
| Computer type | IBM PC/AT or compatible computer equipped with a USB2.0* ¹ /1.1* ² or 10Base-T LAN interface |
| Operating system* ³ * ⁴ | Windows 95, Windows 98, Windows Me, Windows NT Workstation 4.0 (ServicePack 5 or later)* ⁵ , Windows 2000 Professional* ⁵ , Windows XP Professional* ⁵ , Windows XP Home Edition* ⁵ |
| Display | 800 x 600 dots (SVGA) display with 256 colors (or better) |
| Hard disk free space | 150MB or more |
| Other hardware requirements | An environment on which any of the operating systems listed above can fully operate |

*¹ The machine's USB connector will transfer data at the speed specified by the USB 2.0 (Hi-Speed) only if the Microsoft USB 2.0 driver is preinstalled in the computer, or if the USB 2.0 driver for Windows 2000 Professional/XP that Microsoft provides through its "Windows Update" is installed.

*² Compatible with Windows 98, Windows Me, Windows 2000 Professional, Windows XP Professional or Windows XP Home Edition preinstalled model standardly equipped with a USB port.

*³ Printing is not available in MS-DOS mode.

*⁴ The machine does not support printing from a Macintosh environment.

*⁵ Administrator's rights are required to install the software using the installer.

Installation environment and usable software

The following table shows the drivers and software that can be installed for each version of Windows and interface connection method.

| Cable | Operating system | MFP Driver | | Button Manager | Sharpdesk |
|-------------------|---------------------------------|-------------------------|----------------|----------------|-----------|
| | | Printer driver | Scanner driver | | |
| USB* ¹ | Windows 98/Me/2000/XP | Available* ² | Available | | |
| LAN | Windows 95/98/Me/NT 4.0/2000/XP | | Not Available | | |

*¹ Windows 98/Me does not support USB 2.0. A USB 2.0 connection can be used in Windows 98/Me, however, the performance will be the same as USB 1.1. The print speed based on USB 2.0 specifications can only be attained if your computer is running Windows 2000/XP, you are using a cable that supports USB 2.0 (USB 1.1 or USB 2.0 certified), and the cable is connected to a USB 2.0 port on your computer. If the connection is made through a hub, the hub must support USB 2.0.

*² The printer driver that is installed will vary depending on the type of connection between the machine and your computer.

INSTALLING THE SOFTWARE



Note

- If you need to use a different connection method after installing the software using a USB or network connection, you must first uninstall the software (p.79) and then install it using the new connection method.
- In the following explanations it is assumed that the mouse is configured for right hand operation.
- The scanner feature only works when using a USB cable.
- If an error message appears, follow the instructions on the screen to solve the problem. After the problem is solved, the installation procedure will continue. Depending on the problem, you may have to click the "Cancel" button to exit the installer. In this case, reinstall the software from the beginning after solving the problem.
- When installing Sharpdesk, a minimal version of Internet Explorer 5.01 will be installed on your computer if your computer does not currently have Internet Explorer version 4.01 or later.

Using the machine with a USB connection

1 The USB cable must not be connected to the machine. Make sure that the cable is not connected before proceeding.

If the cable is connected, a Plug and Play window will appear. If this happens, click the "Cancel" button to close the window and disconnect the cable.



Note

The cable will be connected in step 15.

2 Insert the CD-ROM into your computer's CD-ROM drive.

3 Click the "start" button, click "My Computer" () , and then double-click the CD-ROM icon ().

In Windows 98/Me/2000, double-click "My Computer", and then double-click the CD-ROM icon.

4 Double-click the "setup" icon ().



Note

If the language selection screen appears after you double click the "setup" icon, select the language that you wish to use and click the "Next" button. (Normally the correct language is selected automatically.)

5 The "SOFTWARE LICENCE" window will appear. Make sure that you understand the contents of the software licence, and then click the "Yes" button.

6 Read the "Readme First" in the "Welcome" window and then click the "Next" button.

- 7** To install all of the software, click the "Standard" button. To install particular packages, click the "Custom" button. If you selected "Custom", go to step 9.

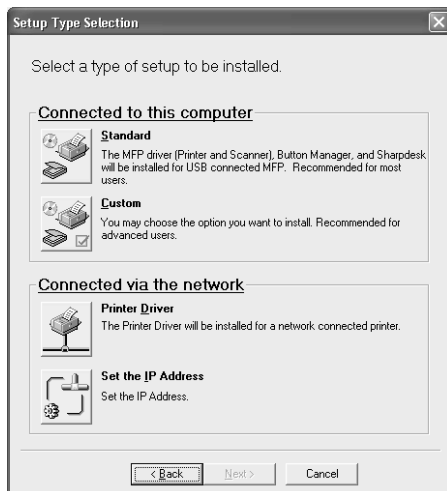

- 8** Read the message in the "Welcome" window and then click the "Next" button.

If you selected "Standard" in step 7, installation will begin. Go to step 14.

- 9** If you clicked the "Custom" button, select the checkboxes of the software packages to be installed and then click the "Next" button.

Click the "Display README" button to show information on packages that are selected.

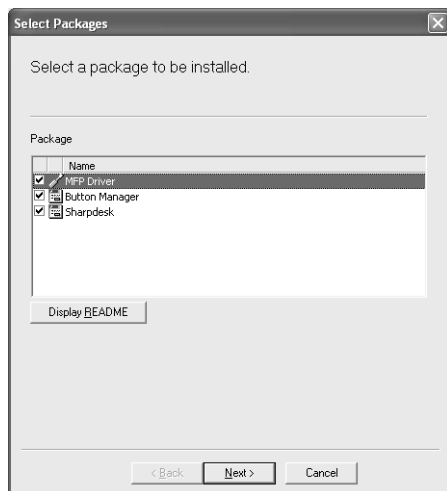

- 10** Check the packages on the screen, and then click the "Start" button.

The software packages to be installed will be displayed on the screen. If an incorrect package is displayed, click the "Back" button and select the correct packages.

11 The files required for installation of the MFP driver are copied (if "MFP Driver" was selected).

Follow the on-screen instructions.



If you are running Windows 2000/XP and a warning message appears regarding the Windows logo test or digital signature, be sure to click "Continue Anyway" or "Yes".

When "The installation of the SHARP software is complete" appears, click the "OK" button.

12 Begin the installation of Button Manager (if "Button Manager" was selected).

Follow the on-screen instructions.

Click the "Finish" button when the message informs you that setup is successful.

The Sharpdesk installer will start.

13 Begin the installation of Sharpdesk (if "Sharpdesk" was selected).

Follow the on-screen instructions.

Click the "Finish" button when the message informs you that Setup is complete.



In Windows 98/Me/2000, if the following screen appears, click the "Skip" button or the "Continue" button as appropriate to continue the Sharpdesk installation.



If "Skip" is selected, the Sharpdesk installation will continue without installing Sharpdesk Imaging.

If "Continue" is selected, Sharpdesk Imaging will be installed. If Imaging for Windows is installed on your computer, Sharpdesk Imaging will overwrite Imaging for Windows.

14 When the "Finish" screen appears, click the "Close" button.**Caution**

If you are running Windows 2000/XP and a warning message appears regarding the Windows logo test or digital signature, be sure to click "Continue Anyway" or "Yes".

A message will appear instructing you to connect the machine to your computer. Click the OK button.

**Note**

- If this is a "Standard" installation, the "Finish" screen will appear after several minutes.
- After the installation, a message prompting you to restart your computer may appear. In this case, click the "Yes" button to restart your computer.

15 Make sure that the power of the machine is turned on, and then connect the USB cable (p. 46).

Windows will detect the machine and a Plug and Play screen will appear.

**Caution**

If the following message appears on your computer screen, close it.

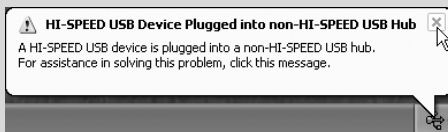

A window regarding "HI-SPEED USB Device" will then appear. Close the window.

This message appears when the machine's USB 2.0 mode is not set to "HI-SPEED". For information on switching the USB 2.0 mode, see Chapter 6, "PRINTER/SCANNER FUNCTIONS".

16 Begin installation of the scanner driver.

"SHARP AL-XXXX" will appear in the "Found New Hardware Wizard" dialog box. Select "Install the software automatically (Recommended)" and click the "Next" button. Follow the on-screen instructions.

**Caution**

If you are running Windows 2000/XP and a warning message appears regarding the Windows logo test or digital signature, be sure to click "Continue Anyway" or "Yes".

**Note**

A "USB 2.0 Composite Device" installation window may appear prior to this procedure. In this case, follow the instructions in the window to install the USB 2.0 Composite Device.

17 Begin installation of the printer driver.

"SHARP AL-XXXX" will appear in the "Found New Hardware Wizard" dialog box. Select "Install the software automatically (Recommended)" and click the "Next" button. Follow the on-screen instructions.



If you are running Windows 2000/XP and a warning message appears regarding the Windows logo test or digital signature, be sure to click "Continue Anyway" or "Yes".

18 Follow the instructions in the Plug and Play screen that appears in your version of Windows to begin the installation.

This completes the installation of the software.

- If you installed Button Manager, set up Button Manager as explained in "SETTING UP BUTTON MANAGER" (p. 55).

Connecting a USB cable

Follow the procedure below to connect the machine to your computer.

A USB cable for connecting the machine to your computer is not included with the machine. Please purchase the appropriate cable for your computer.



- USB is available with a PC/AT compatible computer that was originally equipped with USB and had Windows 98, Windows Me, Windows 2000 Professional, Windows XP Professional or Windows XP Home Edition preinstalled.
- Do not connect the USB cable before installing the MFP driver. The USB cable should be connected during installation of the MFP driver.



- If the machine will be connected using a USB 2.0 port of your computer, please purchase a USB cable that supports USB 2.0.
- The machine's USB connector will transfer data at the speed specified by the USB 2.0 (Hi-Speed) only if the Microsoft USB 2.0 driver is preinstalled in the computer, or if the USB 2.0 driver for Windows 2000 Professional/XP that Microsoft provides through its "Windows Update" Web page is installed.
- To obtain the fastest USB 2.0 data transfer speed, "USB2.0 MODE SWITCH" in the machine's user programs must be set to "HI-SPEED". For more information, see "USER PROGRAMS" (p.68).
- Use the machine's "HI-SPEED" mode only when using a computer that is running Windows 2000/XP.
- Even when the Microsoft USB 2.0 driver is used, it may not be possible to obtain full USB 2.0 speed if a PC card supporting USB 2.0 is used. To obtain the latest driver (which may enable a higher speed), contact the manufacturer of your PC card.
- Connection is also possible using a USB 1.1 port on your computer. However, the specifications will be USB 1.1 specifications (Full-Speed).

- 1 Insert the cable into the USB connector on the machine.

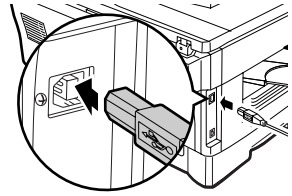

- 2 Insert the other end of the cable into your computer's USB port.

Using the machine as a network printer



- Interface cables for connecting the machine to your computer are not included with the machine. Please purchase the appropriate cable for your computer.
- If you intend to use the machine as a scanner, it must be connected to your computer with a USB interface cable. The scanner function cannot be used if the machine is connected with a LAN cable.
- To install the software using a network connection in Windows 95, Internet Explorer version 4.01 or later must be installed on your computer. If this is not installed, double-click "My Computer" and then double-click the CD-ROM icon. Double-click the "ie501" folder, the "EN" folder, and then "ie5setup.exe".

- 1 Insert the LAN cable into the LAN connector on the machine.

Use a network cable that is shielded.

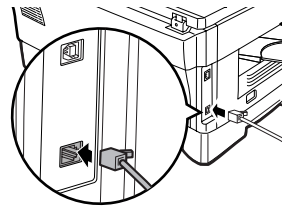

- 2 Turn on the machine.

- 3 Insert the CD-ROM into your computer's CD-ROM drive.

- 4 Click the "start" button, click "My Computer" (), and then double-click the CD-ROM icon ().

In Windows 95/98/Me/NT 4.0/2000, double-click "My Computer", and then double-click the CD-ROM icon.

SET UP THE SOFTWARE

5 Double-click the "setup" icon ().



If the language selection screen appears after you double click the "setup" icon, select the language that you wish to use and click the "Next" button. (Normally the correct language is selected automatically.)

6 The "SOFTWARE LICENCE" window will appear. Make sure that you understand the contents of the software licence, and then click the "Yes" button.

7 Read the "Readme First" in the "Welcome" window and then click the "Next" button.



To set the IP address of the machine, follow the steps below. If the machine is already connected to the network and its IP address has been set, go to "LPR (TCP/IP) direct printing" (p.50).

Set the IP Address

This setting is only required once when using the machine on a network.

8 Click the "Set the IP Address" button.

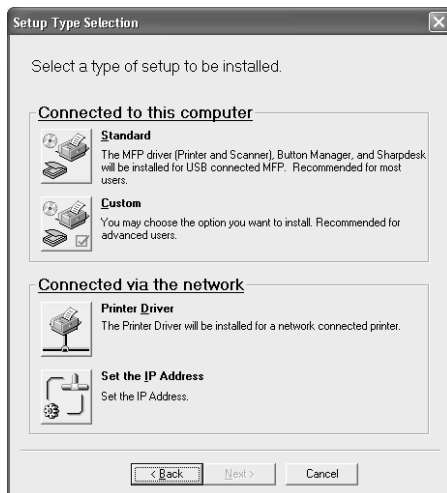

- 9** The printer or printers connected to the network will be detected. Click the printer to be configured (the machine) and click the "Next" button.



Note

- The "Ethernet Address" is indicated on the left side of the machine near the LAN connector.
- If the machine is used on a different network after the IP address is set, the machine will not be recognized. Enter the Ethernet Address and click the "Initialize" button to initialize the IP address. Follow the on-screen instructions to click the "OK" button and then the "Search" button.

- 10** Enter the IP address, subnet mask, and default gateway.

The settings in the above window are examples. Be sure to ask your network administrator for the correct IP address, subnet mask, and default gateway to be entered.



Note

When "Get IP Address Automatically" is selected, the IP address may at times change automatically. This will prevent printing. In this event, select "Assign IP Address" and enter the IP address.

- 11** Click the "Next" button.

5

- 12** Click the "Yes" button.
Go to step 11 on page 51.

LPR (TCP/IP) direct printing

After step 1-7 on page 48

- 8** Click the "Printer Driver" button.

If you have not set the IP Address, click the "Set the IP Address" button in first and go to step 8 on page 48.

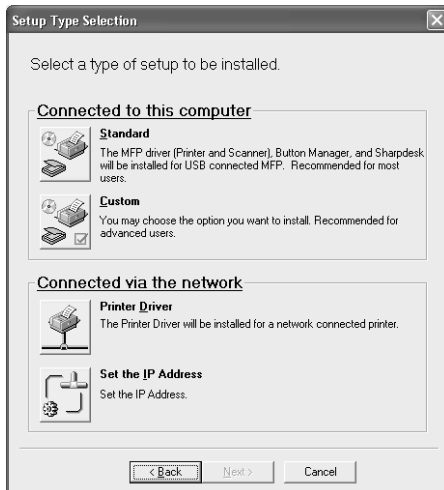

- 9** Read the message in the "Welcome" window and then click the "Next" button.

- 10** Select "LPR (TCP/IP) direct printing" and click the "Next" button.

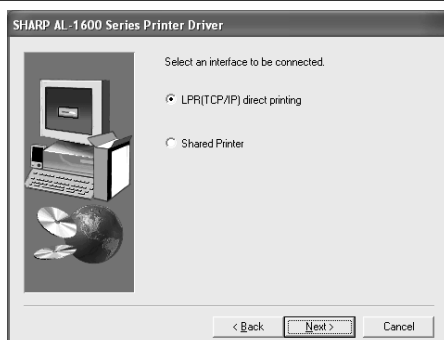

11 The printer or printers connected to the network will be detected. Click the printer to be configured (the machine) and click the "Next" button.

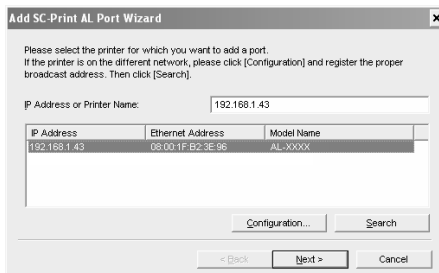

If the machine's IP address cannot be found, make sure the machine is powered on, make sure the network cable is connected correctly, and then click the "Search" button.

12 In the window for setting the destination print port name, make sure that ":lp" appears at the end of the IP address and click the "Next" button.



Any name can be entered in "Printer Port Name" (maximum of 38 characters).

13 A window appears to let you check your entries. Make sure that the entries are correct and then click the "Finish" button.

If any of the entries are incorrect, click the "Back" button to return to the appropriate window and correct the entry.

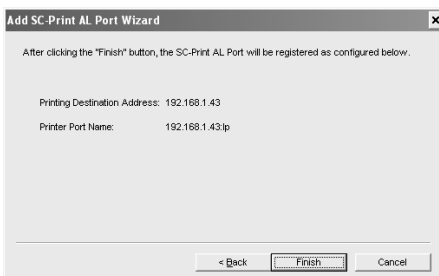

14 When the model selection window appears, select the model name of your machine and click the "Next" button.

For the model name of your machine, see the operation panel on the machine.



A Welcome window may appear before this step. Read the message in the "Welcome" window and then click the "Next" button.

15 Select whether or not you wish the printer to be your default printer and click the "Next" button.



If you are running Windows 2000/XP and a warning message appears regarding the Windows logo test or digital signature, be sure to click "Continue Anyway" or "Yes".

16 When "This installation of the SHARP software is complete" appears, click the "OK" button.

17 When the "Finish" screen appears, click the "Close" button.



After the installation, a message prompting you to restart your computer may appear. In this case, click the "Yes" button to restart your computer.

This completes the installation of the software.

Sharing the printer using windows networking

If the machine will be used as a shared printer on a network, follow these steps to install the printer driver in the client computer.



To configure the appropriate settings in the print server, see the operation manual or help file of your operating system.

1 Insert the CD-ROM into your computer's CD-ROM drive.

2 Click the "start" button, click "My Computer" () , and then double-click the CD-ROM icon ().

In Windows 95/98/Me/NT 4.0/2000, double-click "My Computer", and then double-click the CD-ROM icon.

3 Double-click the "setup" icon ().



If the language selection screen appears after you double click the "setup" icon, select the language that you wish to use and click the "Next" button. (Normally the correct language is selected automatically.)

4 The "SOFTWARE LICENCE" window will appear. Make sure that you understand the contents of the software licence, and then click the "Yes" button.

5 Click the "Printer Driver" button.

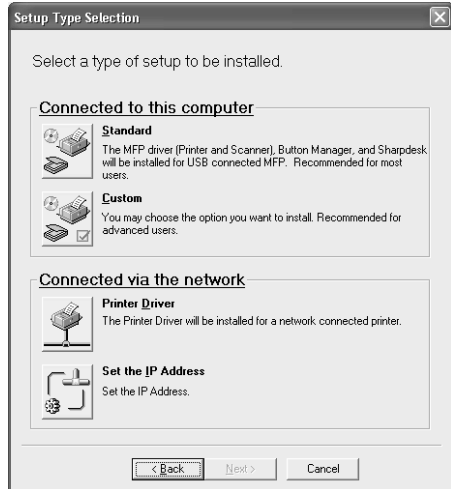

6 Read the message in the "Welcome" window and then click the "Next" button.

7 Select "Shared Printer" and click the "Next" button.

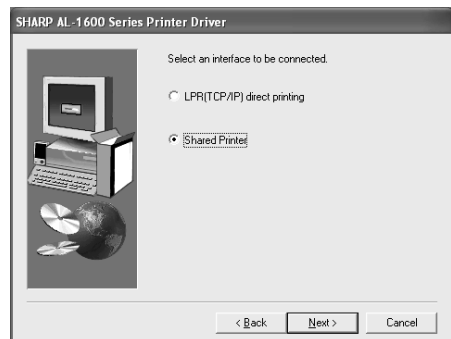

5

SET UP THE SOFTWARE

- 8** For the port to be used, select the machine set as a shared printer, and click the "Next" button.

You can also click the "Add Network Port" button and select the printer to be shared (the machine) by browsing the network in the window that appears.

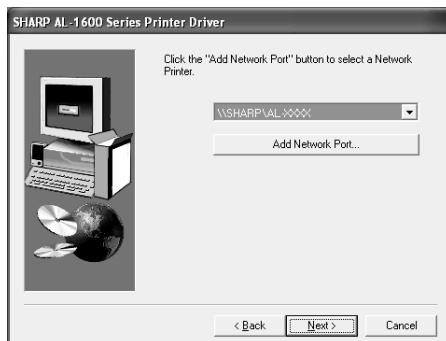

If the shared printer does not appear in the list, check the settings in the printer server.

- 9** When the model selection window appears, select model name of your machine and click the "Next" button.

For the model name of your machine, see the operation panel on the machine.

- 10** Follow the on-screen instructions.

- 11** When the "Finish" screen appears, click the "Close" button.



After the installation, a message prompting you to restart your computer may appear. In this case, click the "Yes" button to restart your computer.

This completes the installation of the software.

SETTING UP BUTTON MANAGER

Button Manager is a software program that works with the scanner driver to enable scanning from the machine.

To scan using the machine, Button Manager must be linked with the scan menu on the machine. Follow the steps below to link Button Manager to scanner events.

Windows XP

- 1** Click the "start" button, click "Control Panel", click "Printers and Other Hardware", and then click "Scanners and Cameras".
- 2** Click the "SHARP AL-XXXX" icon and select "Properties" from the "File" menu.
- 3** In the "Properties" screen, click the "Events" tab.
- 4** Select "SC1:" from the "Select an event" pull-down menu.

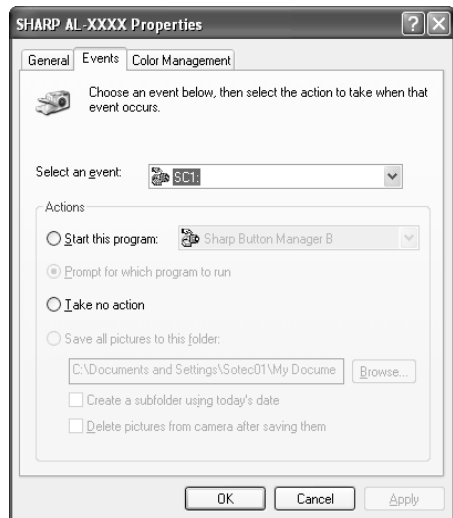

- 5** Select "Start this program" and then select "Sharp Button Manager B" from the pull-down menu.

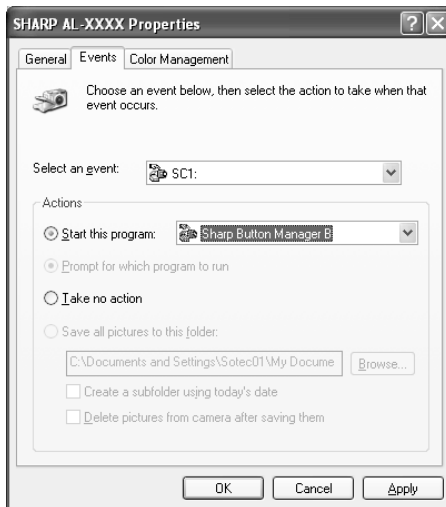

- 6** Click the "Apply" button.

- 7** Repeat Steps 4 through 6 to link Button Manager to "SC2:" through "SC6:".

Select "SC2:" from the "Select an event" pull-down menu. Select "Start this program", select "Sharp Button Manager B" from the pull-down menu, and then click the "Apply" button. Do the same for each ScanMenu through "SC6:".

When the settings have been completed, click the "OK" button to close the screen.

Button Manager is now linked to the scan menu (1 through 6).

The scan settings for each of scan menu 1 through 6 can be changed with the setting window of Button Manager.

For the factory default settings of the scan menu, see "USING THE SCANNER MODE" (p.61). For the procedures for configuring Button Manager settings, see "Button Manager Settings" in the Online Manual.

Windows 98/Me/2000

1 click the "Start" button, select "Settings", and then click "Control Panel".

2 Double-click the "Scanners and Cameras" icon.



If the "Scanners and Cameras" icon does not appear in Windows Me, click "view all Control Panel options".

3 Select "SHARP AL-XXXX" and click the "Properties" button.

In Windows Me, right click "SHARP AL-XXXX" and click "Properties" in the pop-up menu.

4 In the "Properties" screen, click the "Events" tab.

5 Select "SC1:" from the "Scanner events" pull-down menu.

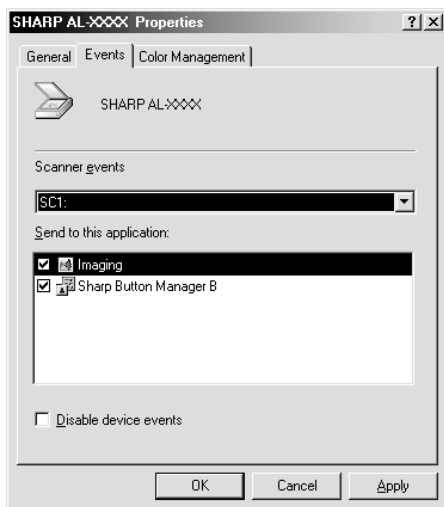
**5**

6 Select "Sharp Button Manager B" in "Send to this application".

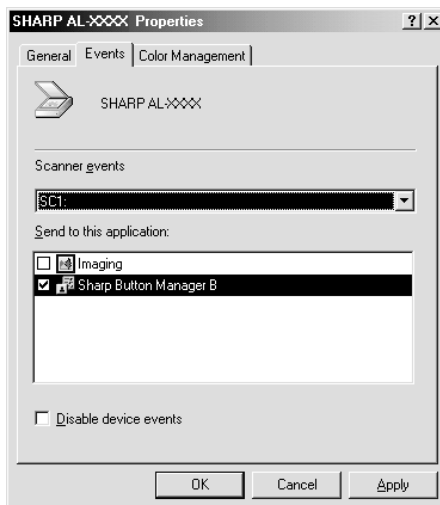

If other applications are shown, deselect the checkboxes for the other applications and leave only the Button Manager checkbox selected.

7 Click the "Apply" button.

8 Repeat Steps 5 through 7 to link Button Manager to "SC2:" through "SC6:".

Select "SC2:" from the "Scanner events" pull-down menu. Select "Sharp Button Manager B" in "Send to this application" and click the "Apply" button. Do the same for each ScanMenu through "SC6:". When the settings have been completed, click the "OK" button to close the screen.

Button Manager is now linked to the scan menu (1 through 6).

The scan settings for each of scan menus 1 through 6 can be changed with the setting window of Button Manager.

For the factory default settings of the scan menu, see "USING THE SCANNER MODE" (p.61). For the procedures for configuring Button Manager settings, see "Button Manager Settings" in the Online Manual.

The machine includes a USB connector and a LAN connector as standard equipment. When the USB connector is used, the printer and scanner functions can be used.

When the LAN connector is used, the printer function can be used.

The machine has the following features:

- High-speed data transfer (when connected to a USB 2.0 connector)
- ROPM* function
- * ROPM is an acronym for "Rip Once Print Many" processing. The ROPM function stores multiple pages of print data in memory before printing. When printing multiple copies, this eliminates the need for the computer to repeatedly transmit the print data.

To use the machine as a printer or scanner, the printer driver or scanner driver must first be installed as explained in the "SET UP THE SOFTWARE".



- If a problem occurs in printer or scanner mode, see the Online Manual.
- When using USB 2.0 (Hi-Speed mode), be sure to read "System requirements for USB 2.0 (Hi-Speed mode)" (below) to verify that your system and the machine settings are configured appropriately.
- The scanning feature is only available when Windows 98/Me/2000/XP and a USB connection are used. The scanning feature is not available when Windows 95/NT 4.0 or a LAN connection is used.

System requirements for USB 2.0 (Hi-Speed mode)

The following system is required to use USB 2.0 (Hi-Speed mode):

- Your computer must be running Windows XP / Windows 2000 and the Microsoft USB 2.0 driver must be pre-installed, or the USB 2.0 driver for Windows XP / Windows 2000 must be installed using Microsoft's Windows Update service.
- The "USB 2.0 MODE SWITCH" setting in the machine's user programs must be set to "Hi-Speed". To change the setting, see "USB 2.0 MODE SWITCH" in the user programs. (p.68).
- * Even when the Microsoft USB 2.0 driver is installed, some USB 2.0 expansion cards are not capable of attaining the speed stipulated by the Hi-Speed standard. This problem can often be fixed by installing a more recent driver for the card. To obtain the most recent driver for your card, contact the card's manufacturer.

USING THE PRINTER MODE

The procedure for loading paper for printing is the same as for loading copy paper. See "LOADING PAPER" (p.18).



- Print jobs received while the machine is copying will be stored in memory. When the copy job is finished, the print jobs will begin printing.
- Printing is not possible when the front or side cover is opened for machine maintenance, or when a misfeed occurs or the machine runs out of paper or toner, or when the drum cartridge reaches its replacement time.

BASIC PROCEDURE FOR PRINTING

The basic procedure for printing is explained in the following. To use convenient printer functions, see the "Online Manual" or the printer driver help file.

1 Make sure that paper is loaded in the tray.

The procedure for loading paper is the same as for copying. See "LOADING PAPER" (p.18) and make sure that the paper you wish to use is loaded.



Make sure that the paper size setting on the machine is the same as the paper size set in the printer driver.

2 Open the file that you wish to print and select "Print" from the File menu.



3 Make sure that the printer driver for the machine is selected, and select print settings in the printer driver.

For information on the settings in the printer driver, see the "Online Manual" or the printer driver help file.

4 Click the "Print" button or the "OK" button to begin printing.

The print job will be delivered to the paper output tray.

Canceling a print job

To cancel a print job, select printer mode with the [MODE SELECT] key on the operation panel of the machine, and then press the [CLEAR] key () or the [CLEAR ALL] key ()



For limitations on copying in print mode, scanner mode limitations, and print mode limitations in copy and scanner mode, see "OPERATION IN COPY, PRINTER, AND SCANNER MODES" (p.62)

USING THE SCANNER MODE

The procedure for placing the original is the same as for copying. See "NORMAL COPYING" (p.24).



Scanner mode cannot be used at the following times:

- A misfeed has occurred (paper misfeed or original misfeed in the RSPF).
- The user programs are being used.
- The tray paper size is being set.
- The machine is being used in copy mode.
- The front cover or side cover is open.

SCANNING USING THE KEYS ON THE MACHINE

When scanning is performed by this method, the application that has been set in Button Manager will automatically start and the scanned image will be pasted into the application.



If the machine is in copy mode, press the [MODE SELECT] key to switch to scanner mode and clear the previously set copy settings.

Scanning from the operation panel of the machine

- 1 Press the [MODE SELECT] key to select scanner mode.**

The "☒" indicator lights up to indicate that scanner mode is selected.

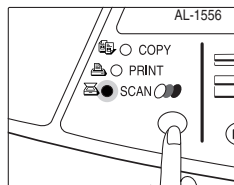

- 2 Place the original. (p.24)**

- 3 Press the [◀] key (⏪) or [▶] key (⏩) to select the desired Button Manager scan menu setting.**

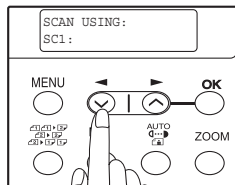

- 4 Press the [START] key (⏻) to begin scanning.**



Scanner mode remains selected after scanning is finished. (To change to a different mode, use the [MODE SELECT] key.)

Button Manager scan menu

For information on Button Manager settings, see the Button Manager help file. The names in the Button Manager menu ("xxxx" in "SC1:xxxx", etc.) can be changed. See the online manual.

SCANNING FROM YOUR COMPUTER

The machine supports the TWAIN standard, making it possible to scan from TWAIN-compliant applications. The machine also supports WIA (Windows Image Acquisition), making it possible to scan from the "Scan and Camera Wizard" in Windows XP. See the Online Manual for the procedures for TWAIN and WIA scanning. For information on TWAIN and WIA settings, see the help file for the scanner driver or Windows Help.

OPERATION IN COPY, PRINTER, AND SCANNER MODES

Some operations cannot be performed simultaneously when the machine is being used in printer mode, copy mode, or scanner mode.

| Modes | | Copying | Printing | Scanning from a computer | Scanning from the machine |
|---------|---|-------------------|-------------------|--------------------------|---------------------------|
| Copy | Copy key input | Yes | Yes | Yes | No |
| | During copying | No | No | No | No |
| Printer | During printing | Yes* ¹ | No | Yes* ³ | Yes* ³ |
| Scanner | During scan preview/ during scanning | No | Yes* ² | No | No |

*¹ During two-sided printing, the copy job begins after the print job finishes.

*² Printing is possible while scanning is taking place. Printing begins after scanning ends when connected by the LAN connector.

*³ Scanning begins after printing ends when connected by the LAN connector and two-sided printing is taking place.

HOW TO USE THE ONLINE MANUAL

The online manual provides detailed instructions for operating the unit as a printer and scanner. It also provides methods for dealing with printing or scanner problems. To access the online manual, your computer must have Acrobat Reader 5.0 or later. If this is not installed, refer to "Installing Acrobat Reader" (below).

1 Turn on your computer.

2 Insert the supplied CD-ROM into your CD-ROM drive.

3 Click the "start" button, click "My Computer" (), and then double-click the CD-ROM () icon.

In Windows 95/98/Me/NT 4.0/2000, double-click "My Computer" and then double-click the CD-ROM icon.

4 Double-click the "Manual" folder, double-click the "English" folder, and then double-click the "AL_1556_1566.pdf" icon.

The window at right will appear.

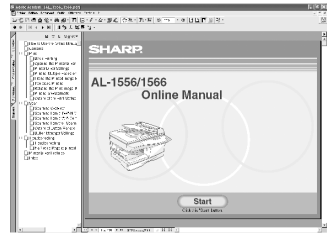

5 Click  to read the online manual.

To close the online manual, click the () button located at the top-right of the window.



- The online manual can be printed out using Acrobat Reader. It is useful to print out sections that you refer to frequently.
- Refer to Acrobat Reader "Help" for more details on the operation and functions of Acrobat Reader.

6

Installing Acrobat Reader

1 Turn on your computer.

2 Insert the CD-ROM into the CD-ROM drive.

3 Click the "start" button, click "My Computer" (), and then double-click the CD-ROM () icon.

In Windows95/98/Me/NT4.0/2000, double-click "My Computer" and then double-click the CD-ROM icon.

4 Double-click the "Acrobat" folder, and then double-click the "ar500enu.exe" icon.

Follow the on-screen instructions to install Acrobat Reader.

7 Chapter 7 USER SETTINGS

The user settings allow you to customize machine settings to better meet your needs.



USER PROGRAMS

The user settings consist of the following items.

To change the user program settings as explained in "SELECTING A SETTING FOR A USER PROGRAM" (p.69).

Copy mode

| Program number | Program name | Setting codes (factory default setting appears in bold) | Explanation |
|----------------|---------------|---|---|
| 1 | AUTO CLEAR | 1: 10 SEC. 2: 30 SEC. 3: 60 SEC. 4: 90 SEC. 5: 120 SEC. 6: OFF | <ul style="list-style-type: none">• Auto clear time automatically returns the copy settings to the initial settings (p.16) if no keys are pressed for a preset period of time following the end of a copy job.• This program is used to select the period of time. Auto clear time can also be disabled. |
| 2 | PREHEAT MODE | 1: 30 SEC. 2: 1 MIN. 3: 5 MIN. 4: 30 MIN. 5: 60 MIN. 6: 120 MIN. 7: 240 MIN. | <ul style="list-style-type: none">• This function automatically switches the machine to a low power consumption state if the set duration of time elapses without the machine being used when the power is on. The power save indicator lights up, however, the keys on the operation panel can be used. Normal operation automatically resumes when a key on the operation panel is pressed, an original is placed, a print job is received. |
| 3 | AUTO SHUT-OFF | 1: ON 2: OFF | <ul style="list-style-type: none">• Use this setting to enable or disable auto power shut-off mode. |

| Program number | Program name | Setting codes (factory default setting appears in bold) | Explanation |
|-----------------------|---------------------|--|--|
| 4 | AUTO SHUT-OFF TIME | 1: 5 MIN. 2: 30 MIN. 3: 60 MIN. 4: 120 MIN. 5: 240 MIN. | <ul style="list-style-type: none"> This function automatically switches the machine to a state that consumes even less power than preheat mode if the set duration of time elapses without the machine being used when the power is on. All lights except the power save indicator go off. To resume normal operation, press the [START] key (). Normal operation also resumes automatically when a print job is received or scanning is begun from a computer. While in auto power shut-off mode, no keys (except the [START] key ()) can be used. |
| 5 | STREAM FEEDING | 1: ON 2: OFF | <ul style="list-style-type: none"> When copying using the RSPF, while "SET ORIGINALS FOR STREAM FEEDING." appears in the display after an original has been scanned (about 5 seconds), a subsequent original can be placed and automatically fed into the machine. |
| 6 | LAYOUT IN 2IN1 | 1: PATTERN 1 2: PATTERN 2 | <ul style="list-style-type: none"> Use this setting to select the layout pattern when two original pages are copied onto a single sheet of paper (see page 35 for the layout patterns). |
| 7 | OFFSET FUNCTION | 1: ON 2: OFF | <ul style="list-style-type: none"> When enabled, this function offsets the position in the paper output tray of sets of copies during copy job, and print jobs when using the printer function. |
| 8 | ROTATE ORIG. IMAGE | 1: ON 2: OFF | <ul style="list-style-type: none"> When two-sided copying is performed, this function rotates the image on the back of the original. This is convenient when binding the copies at the top (tablet binding). |

USER SETTINGS

| Program number | Program name | Setting codes (factory default setting appears in bold) | Explanation |
|----------------|--------------------|--|---|
| 9 | AE/TEXT RESOLUTION | 1: 300dpi 2: 600dpi | <ul style="list-style-type: none"> The copy resolution in auto and text mode is normally 300 dpi. If high-quality copies are preferred, use this setting to change the resolution to 600 dpi. |
| 10 | 2-SIDED COPY MODE | 1: HI-SPEED 2: NORMAL | <ul style="list-style-type: none"> If the memory fills up when two-sided copying is performed, "NORMAL" can be selected to make copying possible. However, "NORMAL" results in a slower copying speed. Normally "HI-SPEED" is selected to enable fast two-sided copying. |
| 11 | MARGIN WIDTH | 1: 5 mm 2: 10 mm 3: 15 mm 4: 20 mm | <ul style="list-style-type: none"> Use this setting to set the margin width. |
| 12 | MEM. FOR PRINTER | 1: 30% 2: 40% 3: 50% 4: 60% 5: 70% | <ul style="list-style-type: none"> Use this to change the proportion of machine memory used for printer mode. |
| 13 | AUTO KEY REPEAT | 1: ON 2: OFF | <ul style="list-style-type: none"> Use this setting to select whether or not holding down a key causes repeated input of the key. For keys that normally cause a set value to increase when held down (for example, holding down the [◀] key (☺) or [▶] key (☹)), this program can be used to have the set value not change when the key is held down. |
| 14 | KEY PRESS TIME | 1: NORMAL 2: 0.5 SEC. 3: 1.0 SEC. 4: 1.5 SEC. 5: 2.0 SEC. | <ul style="list-style-type: none"> Use this setting to select how long a key must be pressed for the input to be accepted. By selecting a longer time, you can prevent settings from being changed by the accidental pressing of a key. |
| 15 | KEY TOUCH SOUND | 1: LOW 2: HIGH 3: OFF | <ul style="list-style-type: none"> This sets the volume of beep signals. (p.70) |

| Program number | Program name | Setting codes (factory default setting appears in bold) | Explanation |
|----------------|------------------|--|---|
| 16 | SOUND AT DEFAULT | 1: ON 2: OFF | <ul style="list-style-type: none"> Use this to sound a beep when a base setting is selected. (p.70) |
| 17 | TONER SAVE MODE | 1: ON 2: OFF | <ul style="list-style-type: none"> This mode reduces toner usage by about 10% when copying. Toner save mode is effective when the exposure mode is AUTO or TEXT. |
| 18 | AE LEVEL ADJUST | 1: SPF/RSPF 2: DOCUMENT GLASS | <ul style="list-style-type: none"> This is used to adjust the exposure level. The automatic exposure level can be adjusted separately for the document glass and the RSPF. The factory default setting for the exposure level is "center". |
| 19 | LANGUAGE | 1: AMERICAN ENGLISH 2: ENGLISH 3: FRENCH 4: SPANISH 5: GERMAN 6: ITALIAN 7: DUTCH 8: SWEDISH 9: NORWEGIAN 10: FINNISH 11: DANISH 12: HUNGARIAN 13: CZECH 14: POLISH 15: RUSSIAN 16: SLOVAK | <p>This is used to set the language used in the display.</p> |
| 20 | RESET FACTORY | 1: Yes 2: No | <p>This is used to return all settings to the factory default settings.</p> |
| 21 | SORT AUTO SELECT | 1: ON 2: OFF | <p>Use this setting to enable or disable sort auto select mode.</p> |



USER SETTINGS

Print mode

| Program number | Program name | Setting codes (factory default setting appears in bold) | Explanation |
|----------------|------------------------------------|--|--|
| 1 | FORCED OUTPUT | 1: ON 2: OFF | When this function is enabled, printing in printer mode will automatically continue using a different size of paper if the specified size of paper runs out in all trays. This feature does not function in copy mode. |
| 2 | USB 2.0 MODE SWITCH * ¹ | 1: FULL-SPEED 2: HI-SPEED | This sets the USB 2.0 data transfer speed. To obtain the fastest speed when using the USB 2.0 connector, first verify that your computer meets the system requirements (operating system and driver), and then use this program to change the USB 2.0 mode to "Hi-Speed". Note that the setting should not be changed while running a TWAIN driver. (For the system requirements, see "System requirements for USB 2.0 (Hi-Speed mode)" (p.59).) |

*¹The scanning speed increases when the USB 2.0 mode is set to "HI-SPEED", however, the printing speed does not increase considerably.

SELECTING A SETTING FOR A USER PROGRAM

1 Press the [MENU] key and then press the [OK] key.

In printer mode, the user programs are accessed by simply pressing the [MENU] key.

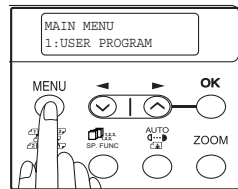

2 Press the [◀] key (⏪) or [▶] key (⏩) to select the item that you wish to configure in the USER PROGRAM items, and then press the [OK] key.

- See "USER PROGRAM" (p.64 to p.68) for the program name and program code.
- You can also select a program by directly entering the program number with the numeric keys.

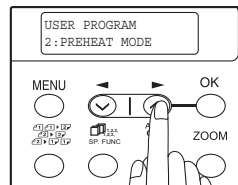

3 Press the [◀] key (⏪) or [▶] key (⏩) to change the setting of the selected item.

See "USER PROGRAM" (p.64 to p.68) for the program code.

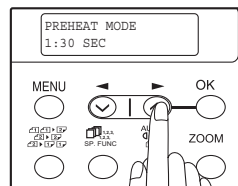

Note

- If you mistakenly select the wrong item, press the [CLEAR] key (⏴) and repeat the procedure from step 2.
- To cancel a setting for a user program, press the [MENU] key.

4 Press the [OK] key.

Your selection appears briefly and then the previous screen appears.



Note

When "AE LEVEL ADJUST" is selected in the user programs and the [OK] key is pressed, the automatic exposure adjustment screen appears. Adjust the exposure and press the [OK] key

USER SETTINGS

Audible signals (key entry beep, invalid key beep, base setting beep)

The machine sounds three different types of beep signals: a key entry beep that sounds when a valid key is pressed, an invalid key beep that sounds when an invalid key is pressed, and a base setting beep that sounds when a setting is the same as the base setting (base settings are explained below). The base setting beep is initially disabled. If you wish to enable the base setting beep, see "SOUND AT DEFAULT" on page 67. If you wish to change the volume of the beep signals or disable them, see "KEY TOUCH SOUND" on page 66.

The beep patterns of each type of beep signal are as follows:

Key entry beep One beep **Base setting beep** Three beeps
Invalid key beep Two beeps

Base settings

The base settings are preset standard selections for each copy setting. The base settings are as follows:

Copy ratio 100% **Paper feed location** Paper tray
Light and Dark level center **AUTO/TEXT/PHOTO** AUTO

Problems related to general use of the machine, the copy function, and software setup are explained here. Be sure to check the problem carefully before calling for service, as many problems can be solved by the user.

If you are unable to solve the problem, turn off the main switch, unplug the power cord from the outlet, and contact your dealer.



For problems related to the printer and scanner functions, see the online manual.

DISPLAY MESSAGES

When the following indicators light up or blink on the operation panel or the following alphanumeric codes appear in the display, solve the problem immediately referring to both the table below and the indicated page.



Be sure to use only genuine SHARP parts and supplies.



| Indication | | Cause and remedy | Page | |
|--|---|--|--|----|
| Lamp indicator | Display | | | |
| Tray location indicator | Blinks | BYPASS : ADD PAPER | The indicated paper tray is not attached, is attached incorrectly, or has run out of paper. | 19 |
| | | TRAY * : ADD PAPER | | |
| | | CLOSE PAPER TRAY * | | |
| Error indicator | Blinks | CLEAR PAPER JAM | A paper misfeed has occurred. Remove the misfeed as explained in "MISFEED REMOVAL". | 80 |
| | | SPF/RSPF JAM. | | |
| | | FRONT OR SIDE COVER OPEN. CLOSE COVERS. | The cover is open. Close the cover. | - |
| | | CLOSE THE SPF/RSPF COVER. | The RSPF cover is open. Close the RSPF cover. | 83 |
| | | REPLACE THE TD CARTRIDGE. | The TD cartridge is empty. Replace the TD cartridge with a new cartridge. (When the indicator blinks, the machine does not operate.) | 85 |
| SYSTEM ERROR [XX - XX] REFER TO USER GUIDE | When [L1-00] appears, the scan head locking switch is locked. Turn off the power, release the scan head locking switch, and turn the power back on. | 13 | | |
| | | The machine will not function. Turn the power switch off, wait about 10 seconds, and then turn on the switch again. If this does not clear the error, remove the power cord from the outlet, and contact your authorized service representative. | - | |

TROUBLESHOOTING AND MAINTENANCE

| Indication | | Cause and remedy | Page |
|--|--------------|--|----------|
| Lamp indicator | Display | | |
| Error indicator | Blinks | REPLACE THE DRUM CARTRIDGE. The drum cartridge has reached the end of its life. Replace it with a new drum cartridge. (When the indicator blinks, the machine does not operate.) | 86 |
| | Steadily lit | TD CARTRIDGE IS NEAR EMPTY. Toner is low. Purchase a new TD cartridge. | 85 |
| | | A DRUM CARTRIDGE WILL BE NEEDED SOON. Less than 1000 sheets can be printed with the current drum cartridge. Purchase a new drum cartridge. | 86 |
| MEMORY FULL, PRESS START TO RESUME. | | Data is being held in memory. Print the data or clear it from memory. | 34 |
| NO 2-SIDED COPY FROM BYPASS TRAY. | | Two sided printing or 2 IN 1 copying is selected when the bypass tray is already selected ,or the bypass tray is selected when two-sided printing or 2 IN 1 copying is already selected. The bypass tray cannot be used. Press the [TRAY SELECT] key (☉) to select a paper tray. | 30 35 |
| NO 2IN1 COPY FROM BYPASS TRAY. | | | |
| NO 2IN1 COPY WITH MARGIN SHIFT. | | 2 IN 1 copy and margin shift cannot be used in combination. | 35 38 |
| ZOOM CAN NOT BE CHANGED IN 2IN1. | | Copy ratio can not be changed in 2 IN 1 copy. | 29 35 |
| THIS MENU IS NOT SELECTABLE WITH DATA. | | This appears if you attempt to change a user program setting while print job is in progress. | 64 |
| INSTALL A TD CARTRIDGE. | | The TD cartridge is not installed correctly. Reinstall the TD cartridge. | 85 |
| NO XX SIZE TRAY | | There is no paper for printing. Press the [MODE SELECT] key to switch to printer mode and follow the instructions in the display. ("XX" indicates paper size) | - |
| CHECK SPF/RSPF. START TO RESUME. | | An original remains on the document glass, or the original is too thick to scan. | 24 |
| | | If the message is no cleared when there is no original on the document glass, the underside of the RSPF is dirty. Clean the underside of the RSPF (especially areas where black lines appear.) | 88 |
| LOAD XX PAPER INTO TRAY. | | Printing is not possible if the paper size setting is different from the size of paper loaded in the tray. Load the same size of paper as the paper size setting and then press the [START] key (☉). Printing will begin. ("XX" indicates paper size) | 19 |
| NO PC COMMUNICATION; CHECK CABLE. | | The machine is not correctly connected to the computer. Check the cable (when using the scanner function). | 46 47 |

TROUBLESHOOTING THE MACHINE

The following problems are related to the general operation of the machine and copying.

| Problem | Cause and solution | Page |
|-----------------------------------|---|----------|
| The machine does not operate. | The machine is not plugged into a power outlet. → Plug the machine into a grounded outlet. | - |
| | Power switch OFF. → Turn the power switch ON. | 16 |
| | The power save indicator is blinking. Indicates that the machine is warming up. → Copies cannot be made until the machine has finished warming up. | - |
| | The front cover or the side cover is not completely closed. → Close the front cover or the side cover. | - |
| | The machine is in auto power shut-off mode. → In auto power shut-off mode, all lights are off except the power save indicator. Press the [START] key (⊕) to resume normal operation. | 17 |
| | The scan head locking switch is locked. → Unlock the scan head locking switch. | 13 |
| Copies are too dark or too light. | Select the correct original type for the original. → Select AUTO (AUTO) with the [EXPOSURE ()] key or press the [◀] key (⊙) or [▶] key (⊕) to manually select an appropriate exposure. → If the copy is too light or too dark even though AUTO (AUTO) was selected with the [EXPOSURE ()] key, adjust the automatic exposure level. | 28 67 |
| | Blank copies. → Place the original face up in the RSPF or face down on the document glass. | 24, 25 |

TROUBLESHOOTING AND MAINTENANCE

| Problem | Cause and solution | Page |
|---|--|--------|
| Part of the image is cut off or there is too much blank space. | The original was not placed in the correct position. → Place the original correctly. | 24, 25 |
| | An appropriate ratio was not used for the size of the original and the size of the paper. → Press the [ZOOM] key to change the ratio to a setting that is suitable for the original and the copy paper. | 29 |
| | The size of paper loaded in the tray was changed without changing the tray's paper size setting. → Be sure to change the tray's paper size setting whenever you change the size of paper loaded in the tray. | 23 |
| Wrinkles appear in the paper or the image disappears in places. | The paper is outside of the specified size and weight range. → Use copy paper within the specified range. | 18 |
| | Paper curled or damp. → Do not use curled or crimped paper. Replace with dry copy paper. During periods when the machine is not used for a long time, remove the paper from the tray and store it in a dark place in a bag to prevent moisture absorption. | - |
| Copies are smudged or dirty. | The document glass or the underside of the RSPF is dirty. → Clean regularly. | 88 |
| | Original smudged or blotchy. → Use a clean original. | - |

TROUBLESHOOTING AND MAINTENANCE

| Problem | Cause and solution | Page |
|---|--|------|
| Paper misfeed. | Misfeed occur. → To remove the misfeed, see "MISFEED REMOVAL". | 80 |
| | The paper is outside of the specified size and weight range. → Use copy paper within the specified range. | 18 |
| | Paper curled or damp. → Do not use curled or crimped paper. Replace with dry copy paper. During periods when the machine is not used for a long time, remove the paper from the tray and store it in a dark place in a bag to prevent moisture absorption. | - |
| | Paper is not loaded properly. → Make sure that the paper is properly loaded. | 19 |
| | Pieces of paper inside machine. → Remove all pieces of misfed paper. | 81 |
| | Too much paper is loaded in the tray. → If the stack of paper is higher than the indicator line on the tray, remove some of the paper and reload so that the stack does not exceed the line. | 19 |
| | Some sheets of paper stick together. → Fan the paper well before loading it. | 20 |
| | The guides on the bypass tray do not match the width of the paper. → Adjust the guides to match the width of the paper. | 22 |
| | The bypass tray extension is not pulled out. → When loading a large size of paper, pull out the extension. | 22 |
| White or black lines appear on copies. | The scanner glass of the RSPF is dirty. → Clean the long narrow glass of the right of the machines platen glass. | 88 |
| | The TD cartridge or drum cartridge is dirty. → Clean the TD cartridge or drum cartridge. | 89 |
| | The transfer charger is dirty. → Clean the transfer charger. | 90 |

TROUBLESHOOTING AND MAINTENANCE

| Problem | Cause and solution | Page |
|--|--|--------|
| Paper size for a paper tray cannot be set. | Copying or printing is performed. → Set the paper size after copying or printing is complete. | - |
| | The machine has stopped temporarily due to running out of paper or a misfeed. → Load paper or remove the misfeed, and then set the paper size. | 23, 80 |
| A copy job stops before it is finished. | "MEMORY FULL, PRESS START TO RESUME." appears in the display. → The memory became full during sort copy. Copy only the originals that have been scanned to that point, or cancel the job and clear the data from memory. | 34 |
| | The tray is out of paper. → Load paper. | 19 |
| The power save indicator is lit. | Other indicators are lit. → If other indicators are lit, the machine is in preheat mode. Press any key on the operation panel to resume normal operation. | 17 |
| | Only the power save indicator is lit. → If only the power save indicator is lit, the machine is in auto power shut-off mode. Press the [START] key (⊕) to resume normal operation. | 17 |
| Error indicator (⚠) is lit or blinking. | See "DISPLAY MESSAGES" to check the meaning of the error indicator and error message in the display, and take appropriate action. | 71 |
| Lighting fixture flickers. | The same power outlet is used for the lighting fixture and the machine. → Connect the machine to a power outlet which is not used for other electric appliances. | - |

PROBLEMS DURING SETUP THE SOFTWARE

If the software does not install correctly, check the following items on your computer. To remove the software, see "Removing the software" (p.79)

MFP driver cannot be installed (Windows 2000/XP)

If the MFP driver cannot be installed in Windows 2000/XP, follow these steps to check your computer's settings.

1 Click the "start" button and then click "Control Panel".

In Windows 2000, click the "Start" button, select "Settings", and then click "Control Panel".

2 Click "Performance and Maintenance", and then click "System".

In Windows 2000, double-click the "System" icon.

3 Click the "Hardware" tab and then click the "Driver Signing" button.

4 Check "What action do you want Windows to take?" ("File signature verification" in Windows 2000).

If "Block" has been selected, it will not be possible to install the MFP driver. Select "Warn" and then install the MFP driver as explained in "INSTALLING THE SOFTWARE".



Plug and play screen does not appear (USB only)

If the Plug and Play screen does not appear after you connect the machine to your computer with a USB cable and turn on the machine, follow the steps below to verify that the USB port is available.

1 Click the "start" button, click "Control Panel", and then click "Performance and Maintenance".

In Windows 98/Me/2000, click the "Start" button, select "Settings", and then click "Control Panel".

2 Click "System", click the "Hardware" tab, and click the "Device Manager" button.

"Universal Serial Bus controllers" will appear in the list of devices.



- In Windows 98/Me, double-click the "System" icon and click the "Device Manager" tab.
- In Windows 2000, double-click the "System" icon, click the "Hardware" tab, and click the "Device Manager" button.
- If the "System" icon does not appear in Windows Me, click "view all Control Panel options".

3 Click the icon beside "Universal Serial Bus controllers".

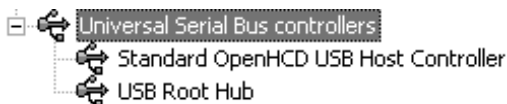

Two items should appear: your controller chipset type and Root Hub. If these items appear, you can use the USB port. If the "Universal Serial Bus controllers" shows a yellow exclamation point or does not appear, you must check your computer manual for USB troubleshooting or contact your computer manufacturer.

4 Once you have verified that the USB port is enabled, install the software as explained in "INSTALLING THE SOFTWARE".

The MFP driver cannot be correctly installed by Plug and Play (Windows 2000/XP) (USB only)

In Windows 2000/XP, if the MFP driver cannot be correctly installed by Plug and Play (for example, Plug and Play takes place without copying the required files for the MFP driver installation), follow these steps to remove unneeded devices and then install the MFP driver as explained in "SET UP THE SOFTWARE" (p.40).

- 1 Click the "start" button, click "Control Panel", and then click "Performance and Maintenance".**

In Windows 2000, click the "Start" button, select "Settings", and then click "Control Panel".

- 2 Click "System", click the "Hardware" tab, and click the "Device Manager" button.**



In Windows 2000, double-click the "System" icon, click the "Hardware" tab, and click the "Device Manager" button.

- 3 Click the  icon beside "Other devices".**

If "AL-XXXX" and "SHARP AL-XXXX" appear, select and delete both of these items.

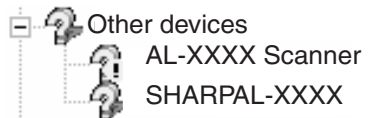

If "Other devices" does not appear, close the "Device Manager" window.

- 4 Install the software as explained in "INSTALLING THE SOFTWARE".**

Removing the software

If you need to remove the software, follow these steps.

- 1 Click the "start" button and then click "Control Panel".**

In Windows 95/98/Me/NT 4.0/2000, click the "Start" button, select "Settings", and then click "Control Panel".

- 2 Click "Add or Remove Programs".**

In Windows 95/98/Me/NT 4.0/2000, double-click the "Add/Remove Programs" icon.

- 3 Select "SHARP AL-1500/1600CS Series MFP (or Printer) Driver" and Button Manager from the list, and remove the software.**

For more information, refer to your operating manual or to the help files for your operating system.

MISFEED REMOVAL

When a misfeed occurs, the error indicator blinks, "CLEAR PAPER JAM" appears in the display, and the machine stops operating. If a misfeed occurs when using the RSPF, "RETURN X ORIGINAL(S) START TO RESUME" will appear in the display. ("X" indicates the number of pages to be returned.) This indicates the number of the originals that must be returned to the document feeder tray after a misfeed. Return the required number of originals. This number will be cleared when copying is resumed or the [CLEAR] key () is pressed. If an original misfeed occurs in the RSPF, the machine will stop and the error indicator will blink. To remove a misfeed from the RSPF, see "D: Misfeed in the RSPF" (p.83).

1 Open the bypass tray and side cover, in that order.

To open the bypass tray, see "Loading paper in the bypass tray" (p.22). To open the side cover, see "INSTALLING THE TD CARTRIDGE" (p.14).

2 Check the misfeed location. Remove the misfed paper following the instructions for each location in the illustration below. If the error indicator blinks, proceed to "A: Misfeed in the paper feed area" (p.81).

If the misfed paper is seen from this side, proceed to "**C: Misfeed in the transport area**". (p.82)

If paper is misfed here, proceed to "**B: Misfeed in the fusing area**". (p.81)

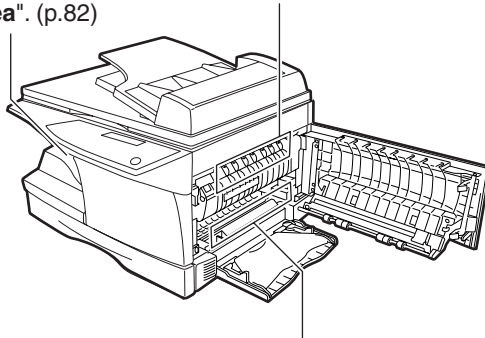

If paper is misfed here, proceed to "**A: Misfeed in the paper feed area**". (p.81)

A: Misfeed in the paper feed area

- 1** Gently remove the misfed paper from the paper feed area as shown in the illustration. If the error indicator blinks and the misfed paper is not visible in the paper feed area, pull out the paper tray and remove the misfed paper. If the paper cannot be removed, proceed to "B: Misfeed in the fusing area".



Warning The fusing unit is hot. Do not touch the fusing unit when removing misfed paper. Doing so may cause a burn or other injury.



- Do not touch the surface of the drum (green portion) of the drum cartridge when removing the misfed paper. Doing so may damage the drum and cause smudges on copies.
- If the paper has been fed through the bypass tray, do not remove the misfed paper through the bypass tray. Toner on the paper may stain the paper transport area, resulting in smudges on copies.

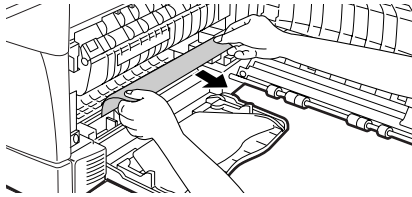

- 2** Close the side cover by pressing the round projections near the side cover open button. The error indicator will go out and the ready indicator will light up.

B: Misfeed in the fusing area

- 1** Lower the fusing unit release lever.

Fusing unit release lever

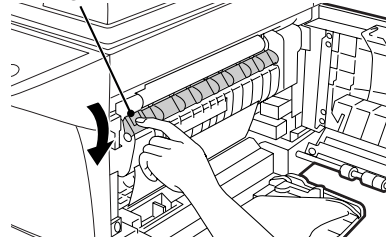

- 2 Gently remove the misfed paper from under the fusing unit as shown in the illustration. If the paper cannot be removed, proceed to "C: Misfeed in the transport area".**

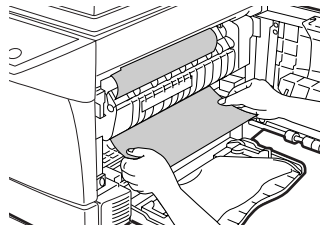

Warning

The fusing unit is hot. Do not touch the fusing unit when removing misfed paper. Doing so may cause a burn or other injury.



Caution

- Do not touch the surface of the drum (green portion) of the drum cartridge when removing the misfed paper. Doing so may cause smudges on copies.
- Do not remove the misfed paper from above the fusing unit. Unfixed toner on the paper may stain the paper transport area, resulting in smudges on copies.

- 3 Raise the fusing unit release lever and then close the side cover by pressing the round projections near the side cover open button. The error indicator will go out and the ready indicator will light up.**

C: Misfeed in the transport area

- 1 Lower the fusing unit release lever.**

See "B: Misfeed in the fusing area" (p.81).

- 2 Open the front cover.**

To open the front cover, see "INSTALLING THE TD CARTRIDGE" (p.14).

- 3 Rotate the roller rotating knob in the direction of the arrow and gently remove the misfed paper from the exit area.**

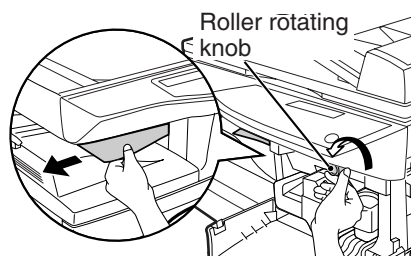

- 4** Raise the fusing unit release lever, close the front cover and then close the side cover by pressing the round projections near the side cover open button. The error indicator will go out and the ready indicator will light up.

**Caution**

When closing the covers, be sure to close the front cover securely and then close the side cover. If the covers are closed in the wrong order, the covers may be damaged.

D: Misfed in the RSPF

An original misfed may occur at one of three locations: if the misfed original is visible in the document feeder tray, (A) in the document feeder tray; if the misfed original is not visible in the document feeder tray, (B) in the exit area or (C) under the document feeder cover. Remove the misfed original following the instructions for each location.

- (A) Open the document feeder cover and pull the original gently to the left and out from the document feeder tray. Close the document feeder cover. Open and close the RSPF to clear the error indicator. If the misfed original cannot be easily removed, proceed to (C).**

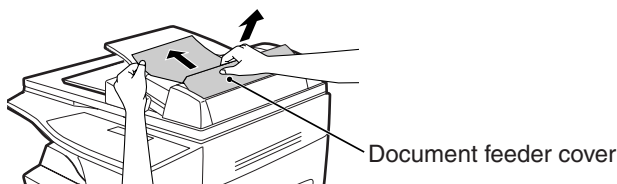

- (B) Open the RSPF and rotate the roller to remove the misfed original from the exit area. If the misfed original cannot be easily removed, proceed to (C).**

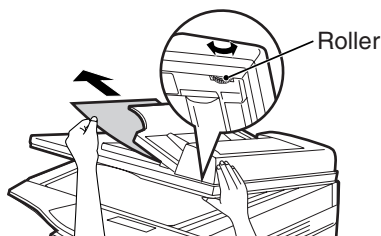

With the RSPF, pull out the reversing tray to remove the misfed original.

**Note**

After removing a misfed original from the exit area of the RSPF, be sure to insert the reversing tray into the exit area until it locks in place.

Reversing tray

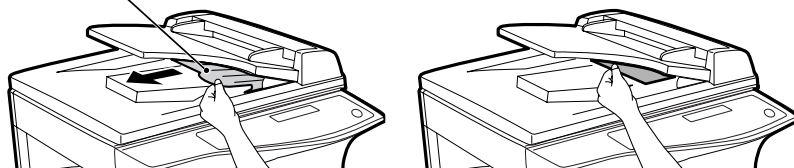

TROUBLESHOOTING AND MAINTENANCE

(C) If the original does not move easily into the exit area, remove it in the direction of the arrow while rotating the roller.

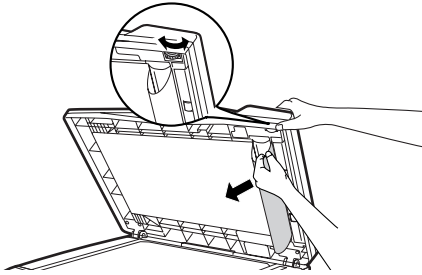

"RETURN X ORIGINAL(S) START TO RESUME" will appear in the display. Return the indicated number of pages to the document feeder tray. Open and close the RSPF to clear the error indicator, and then return the required number of originals. Press the [START] key () to resume copying.

TD CARTRIDGE REPLACEMENT

When toner is low, the error indicator will light up and "TONER IS LOW" will appear in the display. For information on purchasing a new TD cartridge, see "ABOUT SUPPLIES AND OPTIONS" (p.91). If copying is continued while the indicator is lit, copies will gradually become lighter until the toner runs out. When the toner runs out, the machine will stop operating, the error indicator will blink, and "REPLACE THE TD CARTRIDGE" will appear in the display. Follow the procedure below to replace the TD cartridge.



- After the machine stops, it may be possible to make a few more copies by taking the TD cartridge out of the machine, shaking it horizontally, then reinstalling it. If copying is not possible after this operation, replace the TD cartridge.
- During a long copy run of a dark original, "TONER REPLENISHMENT IN PROGRESS" appears in the display, and the machine may stop even though toner is left. The machine will feed toner up to 2 minutes and then the ready indicator will light up. Press the [START] key () to resume copying.

1 Open the bypass tray, side cover, and front cover, in that order.

To open the bypass tray, see "Loading paper in the bypass tray" (p.22). To open the side cover and front cover, see "INSTALLING THE TD CARTRIDGE" (p.14).

2 Gently pull the TD cartridge out while pressing the lock release button.

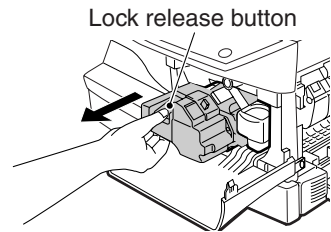

In order to help preserve the global environment, we recycle used TD cartridges. Please read "COPIER TONER CARTRIDGE RECYCLING PROGRAM", which is enclosed in the new TD cartridge package.

3 Install a new TD cartridge. To install the new cartridge, see "INSTALLING THE TD CARTRIDGE" (p.14).

4 Close the front cover and then the side cover by pressing the round projections near the side cover open button. The error indicator will go out and the ready indicator will light up.



When closing the covers, be sure to close the front cover securely and then close the side cover. If the covers are closed in the wrong order, the covers may be damaged.

DRUM CARTRIDGE REPLACEMENT

The useful life of the drum cartridge is approximately 18,000 copies. When the internal counter reaches approximately 17,000 copies, the error indicator will light up and "A DRUM CARTRIDGE WILL BE NEEDED SOON" will appear in the display. For more information on purchasing a drum cartridge, see "ABOUT SUPPLIES AND OPTIONS" (p.91). When the error indicator blinks and "REPLACE THE DRUM CARTRIDGE" appears in the display, the machine will stop operating until the cartridge is replaced. Replace the drum cartridge at this time.

! Caution

Do not remove the protective cover on the drum portion (black paper) of a new drum cartridge before use. The cover protects the drum against external light.

1 Remove the TD cartridge (see "TD CARTRIDGE REPLACEMENT" (p.85)).

2 Hold the drum cartridge handle and gently pull the cartridge out. Dispose of the old drum cartridge in accordance with local regulations.

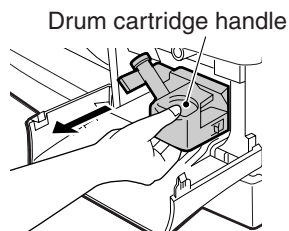

3 Remove the new drum cartridge from the protective bag and remove the protective cover from the cartridge. Gently install the new drum cartridge.

! Caution

Do not touch the surface of the drum (green portion). Doing so may cause smudges on the copies.

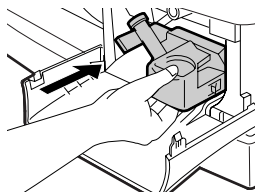
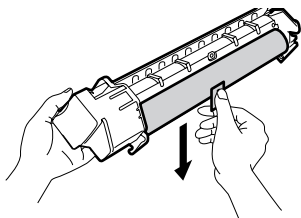

4 Gently install the TD cartridge. To install the TD cartridge, see "INSTALLING THE TD CARTRIDGE" (p.14).

- 5 Close the front cover and then the side cover by pressing the round projections near the side cover open button. The drum replacement required error indicator will go out and the ready indicator will light up.



When closing the covers, be sure to close the front cover securely and then close the side cover. If the covers are closed in the wrong order, the covers may be damaged.

CHECKING THE TOTAL COUNT AND DRUM CARTRIDGE LIFE

You can check the total number of pages output by the machine (all pages printed by the copy function and printer function), as well as the output counts of each function (number of copies, number of scanned pages, number of faxes, etc.) and drum cartridge life. When a count reaches 999,999 it returns to 0.

- 1 Press the [MENU] key. Press the [◀] key (⏴) or [▶] key (⏵) until "TOTAL COUNT" appears, and then press the [OK] key.

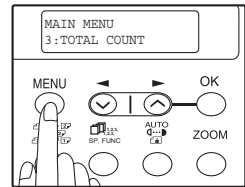

- 2 Press the [◀] key (⏴) or [▶] key (⏵) to display the count of each function.

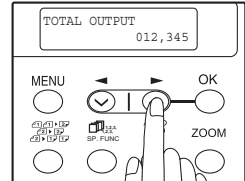

The count of each function changes as follows each the [◀] key (⏴) or [▶] key (⏵) is pressed:

- "TOTAL OUTPUT": Total number of pages output by the machine
- "COPIES": Total number of copies
- "SPF/RSPF": Total number of pages scanned using the RSPF
- "2-SIDED PRINT": Total number of pages printed by two-sided print
- "PRINTS": Total number of pages printed the printer function
- "FAX": Total number of sent and received faxes
- "FAX SEND": Total number of sent faxes
- "SCAN SEND": Total number of scans
- "REMAINING DRUM LIFE": The remaining number of pages that can be printed with the drum cartridge is displayed.

CLEANING THE MACHINE

Proper care is essential in order to get clean, sharp copies. Be sure to take a few minutes to clean the machine on a regular basis.



Do not spray flammable cleaner gas. Gas from the spray may come in contact with the internal electrical components or high-temperature parts of the fusing unit, creating a risk of fire or electrical shock.



- Before cleaning, be sure to turn the power switch off and remove the power cord from the outlet.
- Do not use thinner, benzene or other volatile cleaning agents. Doing so may cause deformation, discoloration, deterioration or malfunction.

Cabinet

Wipe the cabinet with a soft, clean cloth.

Document glass and the back side of the RSPF

Stains on the glass, RSPF scanning window, cover or RSPF roller will also be copied. Wipe the glass, RSPF scanning window, cover and RSPF roller with a soft, clean cloth. If necessary, dampen the cloth with a glass cleaner.

Document glass/scanning window

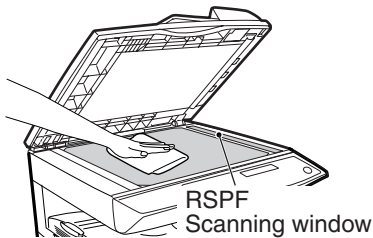

RSPF

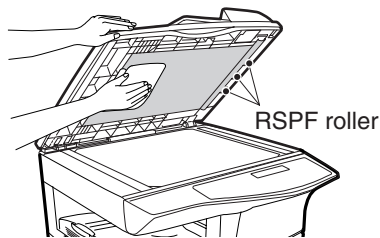

Wipe the area marked by the black line in the illustration. If this area is dirty, copying from the RSPF will not be possible.

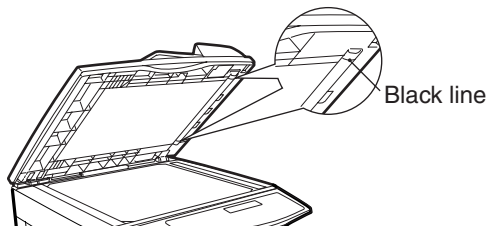

TD cartridge and drum cartridge

1 Remove the TD cartridge and drum cartridge as explained in "TD CARTRIDGE REPLACEMENT" (p.85) and "DRUM CARTRIDGE REPLACEMENT" (p.86).

2 Wipe the parts of the TD cartridge and drum cartridge shown below with a clean cloth.

Wipe only the parts that are indicated in the illustration.

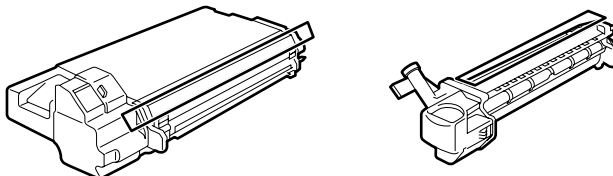

! Caution

- Do not touch the surface of the drum (green portion). Doing so may cause smudges on the copies.
- When cleaning the TD cartridge, do not tilt or shake it. Toner may spill out and soil your clothes.

3 Replace the TD cartridge and drum cartridge as explained in "TD CARTRIDGE REPLACEMENT" (p.85) and "DRUM CARTRIDGE REPLACEMENT" (p.86).

If copies start becoming streaky or blotchy, the transfer charger may be dirty. Clean the charger using the following procedure.

Transfer charger

- 1** Turn the power switch off. (p.17)
- 2** Ensure that the bypass tray is open and then open the side cover while pressing the side cover open button.
- 3** Take the charger cleaner out by holding the tab. Set the charger cleaner onto the right end of the transfer charger, gently slide the cleaner to the left end, and then remove it. Repeat this operation two or three times.



Note

Slide the charger cleaner from the right end to the left end along the groove of the transfer charger. If the cleaner is stopped on the way, smudges on copies may occur.)

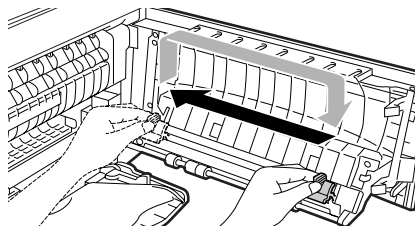
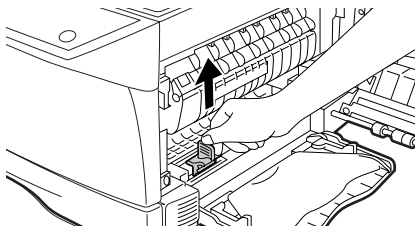

- 4** Return the charger cleaner to its original position. Close the side cover by pressing the round projections near the side cover open button.

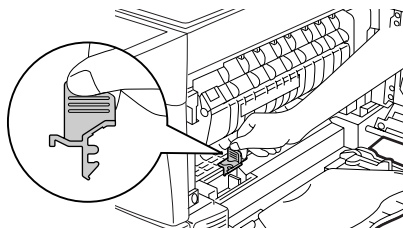

- 5** Turn the power switch on. (p.16)

ABOUT SUPPLIES AND OPTIONS

When ordering supplies, please use the correct part numbers as listed below.



Be sure to use only genuine SHARP parts and supplies.



For best copying results, be sure to use only SHARP Genuine Supplies which are designed, engineered, and tested to maximize the life and performance of SHARP copiers. Look for the Genuine Supplies label on the toner package.

Supply list

| Supply | Part number | Usable life |
|----------------|-------------|------------------------|
| TD cartridge | AL-110DC | Approx. 4,000 sheets * |
| Drum cartridge | AL-100DR | Approx. 18,000 sheets |

* Based on copying onto letter-type paper at 5% toned area
(The life of the TD cartridge which has been included in the machine at the factory is approximately 2,000 sheets.)

Interface cable

Please purchase the appropriate cable for your computer.

USB interface cable

USB cable that supports USB 2.0.

LAN interface cable

Shielded type cable.

SPECIFICATIONS

| Model | AL-1556 | AL-1566 |
|--|---|---------|
| Type | Digital Multifunctional System, Desktop | |
| Photoconductive type | OPC drum | |
| Document glass type | Fixed | |
| Copy/printing system | Dry, electrostatic transfer | |
| Originals | Sheets, bound documents | |
| Originals size | Max. A4 | |
| Copy size | Max. A4 Min. A5 Image loss: Max. 4 mm (leading and trailing edges) Max. 4.5 mm (along other edges in total) Max. 6 mm (trailing edge of the second copy of two-sided copying.) | |
| Copying speed (one-sided copying at 100% copy ratio) | 15 copies/min. (A4) | |
| Continuous copy | Max. 99 copies; subtractive counter | |
| First-copy time* ¹ | Approx. 9.6 sec. | |
| Warm-up time* ¹ | Approx. 0 sec. | |
| Copy ratio | Document glass: Variable: 25% to 400% in 1% increments (total 376 steps) Fixed preset: 25%, 50%, 70%, 86%, 100%, 141%, 200%, 400% RSPF: Variable: 50% to 200% in 1% increments (total 151 steps) Fixed preset: 50%, 70%, 86%, 100%, 141%, 200% | |
| Exposure system | Document glass: Moving optical source, slit exposure (stationary platen) with automatic exposure function RSPF: Moving original | |
| Paper feed | One automatic feeding paper tray (250 sheets each) + bypass tray (50 sheets) | |
| Fusing system | Heat rollers | |

| | | |
|--|---|-----------------|
| Developer system | Magnetic brush development | |
| Light source | Tri-color CCD light source (CCD: 3 components; R, G, and B) | |
| Resolution | Scan: 600 x 300 dpi Output: 600 x 600 dpi(AUTO/TEXT mode) Scan: 600 x 600 dpi Output: 600 x 600 dpi(PHOTO mode) | |
| Gradation | Scanning: 256 Printing: 2 value | |
| Power supply | Local voltage $\pm 10\%$ (For this copier's power supply requirement, see the name plate located on the back of the unit.) | |
| Power consumption | Max. 1.0 kW | |
| Overall dimensions (with bypass tray folded) | 518 mm (W) x 503 mm (D) | |
| Weight*² | Approx. 20 kg | Approx. 20.5 kg |
| Dimensions | 518 mm (W) x 503 mm (D) x 380 mm (H) | |
| Operating conditions | Temperature: 10°C to 30°C, Humidity: 20% to 85% | |
| Noise level | Sound Power Level LWA(1B=10dB) Copying: 6.0[B] Standby: 3.2[B] Sound Pressure Level LpA (bystander positions) Copying: 46[dB(A)] Standby: 17[dB(A)] Sound Pressure Level LpA (operator position) Copying: 48[dB(A)] Standby: 18[dB(A)] Noise emission measurement in accordance with ISO 7779. | |
| Emission concentration (measured according to RAL-UZ62: Edition Jan. 2002). | Ozone: 0.02 mg/m ³ or less Dust: 0.075 mg/m ³ or less Styrene: 0.07 mg/m ³ or less | |

*¹ The first-copy time and warm-up time may vary depending on the power-supply voltage, ambient temperature, and other operating conditions.

*² Not including TD and drum cartridges.

Printer Function

| | |
|-------------------------|---|
| Print speed | 15ppm |
| Resolution | 600 dpi |
| Memory | Approx. 10MB |
| Emulation | SPLC (Sharp Printer Language with Completion) |
| Interface | RJ45 (10 base) USB 2.0 (Full-Speed/Hi-Speed compatible interface) |
| Interface cables | [USB cable] USB cable that supports USB 2.0. Please purchase a commercially available USB cable. [LAN cable] Shielded type cable Please purchase a commercially available LAN cable. |

Scanner Function

| | |
|------------------------------------|--|
| Type | Flatbed scanner |
| Scanning method | Document glass /RSPF |
| Light source | Tri-color CCD light source (CCD: 3 components; R, G, and B) |
| Resolution | Basic: 600 dpi x 1200 dpi Setting range: 50dpi - 9600dpi |
| Original types | Sheet media, books |
| Effective scanning area | 216 mm (Lengthwise) x 356 mm (Width) |
| Scanning speed | 2.88 msec/line |
| Input Data | 1 bit or 12 bit |
| Output Data | R.G.B 1 or 8 bits / pixel / A/D 16 bit |
| Scanning colors | Black and white 2 value, Grayscale, Full color |
| Protocol | TWAIN / WIA (Windows XP only) / STI |
| Interface | USB 2.0 (Full-Speed/Hi-Speed compatible interface) |
| Drop out color | Yes |
| Supported operating systems | Windows98/Me Windows 2000 Professional/Windows XP Home Edition/ Professional (Detailed information can be found in "BEFORE INSTALLATION" (p.41)) |
| Void area | Top and bottom edges 4.0 mm due to scanner driver Right and left edges 4.5 mm |
| Interface cables | [USB cable] USB cable that supports USB 2.0. Please purchase a commercially available USB cable. |
| Scanner utilities | Button Manager / Sharpdesk |



As a part of our policy of continuous improvement, SHARP reserves the right to make design and specification changes for product improvement without prior notice. The performance specification figures indicated are nominal values of production units. There may be some deviations from these values in individual units.

SOFTWARE LICENSE

PLEASE READ THIS LICENSE CAREFULLY BEFORE USING THE SOFTWARE. BY USING THE SOFTWARE, YOU ARE AGREEING TO BE BOUND BY THE TERMS OF THIS LICENSE.

1. License.

The application, demonstration, system and other software accompanying this License, whether on disk, in read only memory, or on any other media (the "Software") and related documentation are licensed to you by SHARP. You own the disk on which the Software is recorded but SHARP and/or SHARP'S Licensors retain title to the Software and related documentation. This License allows you to use the Software on one or more computers connected to a single printer and make one copy of the Software in machine-readable form for backup purposes only. You must reproduce on such copy the SHARP copyright notice, the copyright notice of SHARP'S Licensors and any other proprietary legends of SHARP and/or its Licensors that were on the original copy of the Software. You may also transfer all your license rights in the software, the backup copy of the Software, the related documentation and a copy of this License to another party, provided the other party reads and agrees to the terms and conditions of this License.

2. Restrictions.

The Software contains copyrighted material, trade secrets and other proprietary material which is owned by SHARP and/or its Licensors and in order to protect them you may not decompile, reverse engineer, disassemble or otherwise reduce the Software to a human-perceivable form. You may not modify, network, rent, lease, loan, distribute or create derivative works based upon the Software in whole or in part. You may not electronically transmit the Software from one computer to another or over a network.

3. Termination.

This license is effective until terminated. You may terminate this License at any time by destroying the Software and related documentation and all copies thereof. This License will terminate immediately without notice from SHARP and/or SHARP'S Licensors if you fail to comply with any provision of this License. Upon termination you must destroy the Software and related documentation and all copies thereof.

4. Export Law Assurances.

You agree and certify that neither the Software nor any other technical data received from SHARP, nor the direct product thereof, will be exported outside the United States except as authorized and as permitted by the laws and regulations of the United States. If the Software has been rightfully obtained by you outside of the United States, you agree that you will not re-export the Software nor any other technical data received from SHARP, nor the direct product thereof, except as permitted by the laws and regulations of the United States and the laws and the regulation of the jurisdiction in which you obtained the Software.

5. Government End Users.

If you are acquiring the Software on behalf of any unit or agency of the United States Government, the following provisions apply. The Government agrees:

- (i) if the Software is supplied to the Department of Defense (DoD), the Software is classified as "Commercial Computer Software" and the Government is acquiring only "restricted rights" in the Software and its documentation as that term is defined in Clause 252.227-7013 (c)(1) of the DFARS; and
- (ii) if the Software is supplied to any unit or agency of the United States Government other than DoD, the Government's rights in the Software and its documentation will be as defined in Clause 52.227-19 (c)(2) of the FAR or, in the case of NASA, in Clause 18-52.227-86 (d) of the NASA Supplement to the FAR.

6. Limited Warranty on Media.

SHARP warrants the disks on which the Software is recorded to be free from defects in materials and workmanship under normal use for a period of ninety (90) days from the date of purchase as evidenced by a copy of the receipt. The entire liability of SHARP and/or its Licensors and your exclusive remedy will be replacement of the disk which fails to meet the limited warranty provided by this Clause 6. A disk will be replaced when it is returned to SHARP or a SHARP authorized representative with a copy of the receipt. SHARP will have no responsibility to replace a disk damaged by accident, abuse or misapplication.

ANY IMPLIED WARRANTIES ON THE DISKS, INCLUDING THE IMPLIED WARRANTIES OF MERCHANTABILITY AND FITNESS FOR A PARTICULAR PURPOSE, ARE LIMITED IN DURATION TO NINETY (90) DAYS FROM THE DATE OF DELIVERY. THIS WARRANTY GIVES YOU SPECIFIC LEGAL RIGHTS, AND YOU MAY ALSO HAVE OTHER RIGHTS WHICH VARY FROM JURISDICTION TO JURISDICTION.

7. Disclaimer of Warranty on Software.

You expressly acknowledge and agree that use of the Software is at your sole risk. The software and related documentation are provided "AS IS" and without warranty of any kind and SHARP and SHARP'S Licensor(s) (for the purpose of provisions 7 and 8, SHARP and SHARP'S Licensor(s) shall be collectively referred to as "SHARP") EXPRESSLY DISCLAIM ALL WARRANTIES, EXPRESS OR IMPLIED, INCLUDING, BUT NOT LIMITED TO, THE IMPLIED WARRANTIES OF MERCHANTABILITY AND FITNESS FOR A PARTICULAR PURPOSE. SHARP DOES NOT WARRANT THAT THE FUNCTIONS CONTAINED IN THE SOFTWARE WILL MEET YOUR REQUIREMENTS, OR THAT THE OPERATION OF THE SOFTWARE WILL BE UNINTERRUPTED OR ERROR-FREE, OR THAT DEFECTS IN THE SOFTWARE WILL BE CORRECTED. FURTHERMORE, SHARP DOES NOT WARRANT OR MAKE ANY REPRESENTATIONS REGARDING THE USE OR THE RESULTS OF THE USE OF THE SOFTWARE OR RELATED DOCUMENTATION IN TERMS OF THEIR CORRECTNESS, ACCURACY, RELIABILITY, OR OTHERWISE. NO ORAL OR WRITTEN INFORMATION OR ADVICE GIVEN BY SHARP OR A SHARP AUTHORIZED REPRESENTATIVE SHALL CREATE A WARRANTY OR IN ANY WAY INCREASE THE SCOPE OF THIS WARRANTY. SHOULD THE SOFTWARE PROVE DEFECTIVE, YOU (AND NOT SHARP OR A SHARP AUTHORIZED REPRESENTATIVE) ASSUME THE ENTIRE COST OF ALL NECESSARY SERVICING, REPAIR OR CORRECTION, SOME JURISDICTIONS DO NOT ALLOW THE EXCLUSION OF IMPLIED WARRANTIES, SO THE ABOVE EXCLUSION MAY NOT APPLY TO YOU.

8. Limitation of Liability.

UNDER NO CIRCUMSTANCES INCLUDING NEGLIGENCE, SHALL SHARP BE LIABLE FOR ANY INCIDENTAL, SPECIAL OR CONSEQUENTIAL DAMAGES THAT RESULT FROM THE USE OR INABILITY TO USE THE SOFTWARE OR RELATED DOCUMENTATION, EVEN IF SHARP OR A SHARP AUTHORIZED REPRESENTATIVE HAS BEEN ADVISED OF THE POSSIBILITY OF SUCH DAMAGES. SOME JURISDICTIONS DO NOT ALLOW THE LIMITATION OR EXCLUSION OF LIABILITY FOR INCIDENTAL OR CONSEQUENTIAL DAMAGES SO THE ABOVE LIMITATION OR EXCLUSION MAY NOT APPLY TO YOU.

In no event shall SHARP'S total liability to you for all damages, losses, and causes of action (whether in contract, tort (including negligence) or otherwise) exceed the amount paid by you for the Software.

9. Controlling Law and Severability.

For a portion of the Software related with Apple Macintosh and Microsoft Windows, this license shall be governed by and construed in accordance with the laws of the state of California and Washington, respectively. If for any reason a court of competent jurisdiction finds any provision of this License, or portion thereof, to be unenforceable, that provision of the License shall be enforced to the maximum extent permissible so as to effect the intent of the parties, and the remainder of this License shall continue in full force and effect.

10. Complete Agreement.

This License constitutes the entire agreement between the parties with respect to the use of the Software and related documentation, and supersedes all prior or contemporaneous understandings or agreements, written or oral, regarding such subject matter. No amendment to or modification of this License will be binding unless in writing and signed by a duly authorized representative of SHARP.

Data Revised: Jun.28.2002
 Data Issued: Nov.1.2000
 MSDS NO. F-31001

1. PRODUCT AND COMPANY IDENTIFICATION

Product Name : AL-100TD / DM-150TD / AL-110TD / AL-110DC (Black Toner)
Supplier Identification : Sharp Corporation
 22-22 Nagaïke-cho, Abeno-ku, Osaka, Japan
 Local suppliers are listed below. Please contact the nearest supplier for additional information.

| Area | (Country) | (Name and Telephone Number) |
|---------------|----------------|--|
| North America | U.S.A. | Sharp Electronics Corporation Sharp Plaza, Mahwah, NJ Telephone number for information : 1-800-237-4277 Emergency telephone number : 1-800-255-3924 |
| | Canada | Sharp Electronics of Canada Ltd. Telephone number for information : 905-890-2100 Emergency telephone number : 1-800-255-3924 |
| Oceania | Australia | Sharp Corporation of Australia PTY. Ltd. No1 Huntingwood Drive Huntingwood Blacktown N.S.W. Telephone number for information : 1300-13-50-22 |
| Europe | Germany | Sharp Electronics (Europe) GMBH Sonninstrasse 3, 20097 Hamburg Telephone number to access MSDS : 040-2376-2185 For more information : 040-2376-2613 |
| | United Kingdom | Sharp Electronics (U. K.) Ltd. Telephone number for information : 08705-274-277 |
| | France | Sharp Electronics (France) S.A. Telephone number for information : 01-49-90-34-00 |
| | Austria | Sharp Electronics GMBH Telephone number for information : 01-727-19-0 |
| | Italy | Sharp Electronics (Italia) S.P.A. Telephone number for information : 02895951 |
| | Spain | Sharp Electronics Espana S.A. Telephone number for information : 93-581-97-00 |
| | Netherlands | Sharp Electronics Benelux B.V. Telephone number for information : 30-6359500 |
| | Sweden | Sharp Electronics (Nordic) AB Telephone number for information : 08-634-36-00 |
| | Switzerland | Sharp Electronics(Schweiz)AG Telephone number for information : 01-846-6111 |
| Middle East | U.A.E | Sharp Middle East FZE P.O.Box 17115 Jebel Ali, Dubai Telephone number for information : 04-815311 |

2. COMPOSITION/INFORMATION ON INGREDIENTS

| Substance[] | Preparation[X] | | | | | | |
|----------------------------|---------------------------|-------------------|----------------------|----------------------|----------------|--------------------|--|
| <u>Ingredient</u> | <u>CAS No.</u> | <u>Proportion</u> | <u>OSHA PEL</u> | <u>ACGIH TLV</u> | <u>MAK-TWA</u> | <u>NOHSC-TWA</u> | |
| Styrene-Acrylate copolymer | 29497-14-1 | 35-45% | Not listed | Not listed | Not listed | Not listed | |
| Styrene-homopolymer | 9003-53-6 | 35-45% | Not listed | Not listed | Not listed | Not listed | |
| Carbon black | 1333-86-4 | 5-10% | 3.5mg/m ³ | 3.5mg/m ³ | Not listed | 3mg/m ³ | |
| Iron oxide | 1309-38-2 | 5-10% | Not listed | Not listed | Not listed | Not listed | |
| Polypropylene | 9010-79-1 | 1-5% | Not listed | Not listed | Not listed | Not listed | |
| paraffine | 8002-74-2 | 1-5% | Not listed | Not listed | Not listed | Not listed | |
| Metal Complex dye* | 109125-51-1 84179-66-8 | <1% | 0.5mg/m ³ | 0.5mg/m ³ | Not listed | Not listed | |

*EC No. : 400-110-2, Symbol letter : F, R Phrase : R11

3. HAZARDS IDENTIFICATION

Most Important Hazards and Effects of the Products

Human Health Effects :There are no anticipated carcinogenic effects from exposure based on animal tests performed using toner. When used as intended according to instructions, studies do not indicate any symptoms of fibrosis will occur.

Environmental Effects :No data are available.

Specific hazards :Dust explosion (like most finely divided organic powders)

Directive 1999/45/EC(Europe) :Not classified as dangerous

4. FIRST-AID MEASURES

| | | | |
|----------------------------|--------------------|--------------|----------------------------|
| Route(s) of Entry : | Inhalation? | Skin? | Ingestion? |
| | Yes | No | Possible but very unusual. |

Inhalation :Remove to fresh air. If symptoms occur, consult medical personnel.

Skin Contact :Wash with soap and water for 15 minutes or until particle is removed. If irritation does occur, consult medical personnel.

Eye Contact :Flush eyes immediately with water for 15 minutes. If irritation does occur, consult medical personnel.

Ingestion :Rinse with water and drink several glasses of water. If irritation or discomfort does occur, consult medical personnel.

5. FIRE -FIGHTING MEASURES

Extinguishing Media :water, CO₂, foam and dry chemicals

Special Fire fighting Procedures :None

Fire and Explosion Hazards :Toner material, like most finely divided organic powders, may form an explosive mixture.

6. ACCIDENTAL RELEASE MEASURES

Personal Precautions :None

Environmental Precautions :None

Methods for Cleaning Up :Wipe off with paper or cloth. Do not use vacuum cleaner when a large amount is released. It, like most finely divided organic powders, is capable of creating a dust explosion.

7. HANDLING AND STORAGE

Handling

Technical Measures :None

Precautions :None

Safe Handling Advice :Use of a dust mask is recommended when handling a large quantity of toner or during long term exposure, as with any non-toxic dust. Try not to disperse the particles.

Storage

Technical Measures :None

Storage Conditions :Keep container closed and Store in a cool and dry place. Keep out of the reach of children.

Incompatible Products:None

Data Revised: Jun.28.2002

Data Issued: Nov.1.2000

MSDS NO. F-31001

8. EXPOSURE CONTROL / PERSONAL PROTECTION**Engineering Measures**

Ventilation :None required with intended use.

Exposure limit valuesOSHA-PEL (USA) :15mg/m³ (Total Dust) , 5mg/m³ (Respirable Dust)ACGIH-TLV (USA) :10mg/m³ (Total Dust) , 3mg/m³ (Respirable Dust)**Personal Protective Equipment**

Respiratory Protection :Not required under intended use.

Hand Protection :Not required under intended use.

Eye Protection :Not required under intended use.

Skin Protection :Not required under intended use.

Other Protective equipment :Use of a dust mask and goggles are recommended when handling a large quantity of toner or during long term exposure, as with any non-toxic dust.

9. PHYSICAL AND CHEMICAL PROPERTIES**Appearance**

Physical State : Solid Form: Powder Color: Black Odor: odorless

Ph :Not applicable

Boiling/Melting Point :Not applicable

Softening Point (°C) :No data

Flash Point (°C) :Not applicable

Ignition Point (°C) :No data

Explosion Properties :No data

Density (g/cm³) :1.1 (bulk density : 0.34)

Solubility in water :Negligible

10. STABILITY AND REACTIVITY

Stability :Stable

Hazardous Reactions :Dust explosion, like most finely divided organic powders.

Conditions to avoid :Electric discharge, throwing into fire.

Materials to avoid :Oxidizing Materials

Hazardous Decomposition Products :CO, CO₂ and NO_x

Further Information :None

11. TOXICOLOGICAL INFORMATION**Acute Toxicity**Ingestion (oral) :LD₅₀>2000mg/kg (Rats)Dermal :LD₅₀>2000mg/kg (Rats)

Inhalation :No data

Eye irritation :Not an irritant

Skin irritation :Not an irritant

Skin sensitizer :No sensitization

Mutagenicity :Negative (Ames Test)**Carcinogenicity** :In 1996 the IARC reevaluated carbon black as a Group 2B carcinogen (possible human carcinogen). This classification is given to chemicals for which there is inadequate human evidence, but sufficient animal evidence on which to base an opinion of carcinogenicity. The classification is based upon the development of lung tumors in rats receiving chronic inhalation exposures to free carbon black at levels that induce particle overload of the lung. Studies performed in animal models other than rats did not show any association between carbon black and lung tumors. Moreover, a two-year cancer bioassay using a typical toner preparation containing carbon black demonstrated no association between toner exposure and tumor development in rats.

Data Revised: Jul. 31, 2002

Data Issued: Jun. 1, 1998

MSDS NO. F-00831

Chronic Effect : In a study in rats of chronic inhalation exposure to a typical toner, a mild to moderate degree of lung fibrosis was observed in 92% of the rats in the high concentration (16mg/m³) exposure group, and a minimal to mild degree of fibrosis was noted in 22% of the animals in the middle (4mg/m³) exposure group, but no pulmonary change was reported in the lowest (1mg/m³) exposure group, the most relevant level to potential human exposures.

12. ECOLOGICAL INFORMATION

No data are available.

13. DISPOSAL CONSIDERATION

Waste from residues :Waste material may be dumped or incinerated under conditions which meet all federal, state and local environmental regulations.

Contaminated Packaging :Waste may be disposed or incinerated under conditions which meet all federal, state and local environmental regulations.

14. TRANSPORT INFORMATION

UN Classification :None
Not classified as hazardous for transport.

15. REGULATORY INFORMATION

US Information

TSCA (Toxic Substances Control Act) :

All chemical substances in this product comply with all applicable rules or order under TSCA.

SARA (Superfund Amendments and Reauthorization Act) Title III

302 Extreme Hazardous Substance :None

311/312 Hazard Classification :None

EU Information

1999/45/EC and 67/548/EEC

Symbol & Indication :Not required

R-Phrase :Not required

76/769/EEC :All chemical substances in this product comply with all applicable rules or order under 76/769/EEC.

16. OTHER INFORMATION

NFPA Rating (USA) :Health=1 Flammability=1 Reactivity=0

WHMIS Legislation (Canada) :This product is not a controlled product.

List of R phrases :R11 : Highly flammable

References

IARC (1996) :IARC monographs on the Evaluation of the Carcinogenic Risk of Chemicals to Humans, Vol. 65, Printing Process And Printing Inks, Carbon Black and Some Nitro Compounds, Lyon, pp.149-261

H.Muhle, B.Bellmann, O.Creutzenberg, C.Dasenbrock, H.Ernst, R.Kilpper, J.C.MacKenzie, P.Morrow, U.Mohr,

S.Takenaka, and R.Mermelstein (1991) Pulmonary Response to Toner upon Chronic Inhalation Exposure in Rats.

Fundamental and Applied Toxicology 17, pp.280-299.

The information on this data sheet represents our current data and best opinion as to the proper use in handling of this product under normal conditions. However, all materials may present unknown hazards and should be used with caution. Although certain hazards are described herein, we do not guarantee that these are the only hazards which exist.

Data Revised: Jun.28.2002
 Data Issued: Nov.1.2000
 MSDS NO. F-31001

1. PRODUCT AND COMPANY IDENTIFICATION

Product Name : AL-100TD / DM-150TD / AL-110TD / AL-110DC (Black Developer)
Supplier Identification : Sharp Corporation
 22-22 Nagaike-cho, Abeno-ku, Osaka, Japan

Local suppliers are listed below. Please contact the nearest supplier for additional information.

| Area | (Country) | (Name and Telephone Number) |
|---------------|----------------|--|
| North America | U.S.A. | Sharp Electronics Corporation Sharp Plaza, Mahwah, NJ Telephone number for information : 1-800-237-4277 Emergency telephone number : 1-800-255-3924 |
| | Canada | Sharp Electronics of Canada Ltd. Telephone number for information : 905-890-2100 Emergency telephone number : 1-800-255-3924 |
| Oceania | Australia | Sharp Corporation of Australia PTY. Ltd. No1 Huntingwood Drive Huntingwood Blacktown N.S.W. Telephone number for information : 1300-13-50-22 |
| Europe | Germany | Sharp Electronics (Europe) GMBH Sonninstrasse 3, 20097 Hamburg Telephone number to access MSDS : 040-2376-2185 For more information : 040-2376-2613 |
| | United Kingdom | Sharp Electronics (U. K.) Ltd. Telephone number for information : 08705-274-277 |
| | France | Sharp Electronics (France) S.A. Telephone number for information : 01-49-90-34-00 |
| | Austria | Sharp Electronics GMBH Telephone number for information : 01-727-19-0 |
| | Italy | Sharp Electronics (Italia) S.P.A. Telephone number for information : 02895951 |
| | Spain | Sharp Electronics Espana S.A. Telephone number for information : 93-581-97-00 |
| | Netherlands | Sharp Electronics Benelux B.V. Telephone number for information : 30-6359500 |
| | Sweden | Sharp Electronics (Nordic) AB Telephone number for information : 08-634-36-00 |
| | Switzerland | Sharp Electronics(Schweiz)AG Telephone number for information : 01-846-6111 |
| Middle East | U.A.E | Sharp Middle East FZE P.O.Box 17115 Jebel Ali, Dubai Telephone number for information : 04-815311 |

2. COMPOSITION/INFORMATION ON INGREDIENTS

Substance[] Preparation[X]

| Ingredient | CAS No. | Proportion | OSHA PEL | ACGIH TLV | MAK-TAK | NOHSC-TWA |
|----------------------------|----------------|-------------------|----------------------|----------------------|----------------|----------------------|
| Iron powder | 7439-89-6 | 85-95% | Not listed | Not listed | Not listed | Not listed |
| Styrene-Acrylate copolymer | 29497-14-1 | 1-5% | Not listed | Not listed | Not listed | Not listed |
| Styrene homopolymer | 9003-53-6 | 1-5% | Not listed | Not listed | Not listed | Not listed |
| Carbon black | 1333-86-4 | < 1% | 3.5mg/m ³ | 3.5mg/m ³ | Not listed | 3.5mg/m ³ |

3. HAZARDS IDENTIFICATION

Most Important Hazards and Effects of the Products

Human Health Effects :There are no anticipated carcinogenic effects from exposure based on animal tests performed using toner. When used as intended according to instructions, studies do not indicate any symptoms of fibrosis will occur.

Environmental Effects :No data are available.

Specific hazards :Dust explosion (like most finely divided organic powders)

Directive 1999/45/EC(Europe) :Not classified as dangerous

4. FIRST-AID MEASURES

| | | | |
|----------------------------|--------------------|--------------|----------------------------|
| Route(s) of Entry : | Inhalation? | Skin? | Ingestion? |
| | Yes | No | Possible but very unusual. |

Inhalation :Remove to fresh air. If symptoms occur, consult medical personnel.

Skin Contact :Wash with soap and water for 15 minutes or until particle is removed. If irritation does occur, consult medical personnel.

Eye Contact :flush eyes immediately with water for 15 minutes. If irritation does occur, consult medical personnel.

Ingestion :Rinse with water and drink several glasses of water . If irritation or discomfort does occur, consult medical personnel.

5. FIRE -FIGHTING MEASURES

Extinguishing Media :water, CO₂, foam and dry chemicals

Special Fire fighting Procedures:None

Fire and Explosion Hazards :Toner material, like most finely divided organic powders, it may form an explosive mixture.

6. ACCIDENTAL RELEASE MEASURES

Personal Precautions :None

Environmental Precautions :None

Methods for Cleaning Up :Wipe off with paper or cloth. Do not use vacuum cleaner when a large amount is released. It, like most finely divided organic powders, is capable of creating a dust explosion.

7. HANDLING AND STORAGE

Handling

Technical Measures :None

Precautions :None

Safe Handling Advice :Use of a dust mask is recommended when handling a large quantity of toner or during long term exposure, as with any non-toxic dust. Try not to disperse the particles.

Storage

Technical Measures :None

Storage Conditions :Keep container closed and Store in a cool and dry place. Keep out of the reach of children.

Incompatible Products:None

8. EXPOSURE CONTROL / PERSONAL PROTECTION

Engineering Measures

Ventilation :None required with intended use.

Exposure limit values

OSHA-PEL (USA) :15mg/m³ (Total Dust) , 5mg/m³ (Respirable Dust)

ACGIH-TLV (USA) :10mg/m³ (Total Dust) , 3mg/m³ (Respirable Dust)

Data Revised: Jun.28.2002

Data Issued: Nov.1.2000

MSDS NO. F-31001

Personal Protective Equipment

Respiratory Protection :Not required under intended use.
 Hand Protection :Not required under intended use.
 Eye Protection :Not required under intended use.
 Skin Protection :Not required under intended use.
 Other Protective equipment :Use of a dust mask and goggles are recommended when handling a large quantity of toner or during long term exposure, as with any non-toxic dust.

9. PHYSICAL AND CHEMICAL PROPERTIES**Appearance**

Physical State : Solid Form: Powder Color: Black Odor: odorless

Ph :Not applicable

Boiling/Melting Point :Not applicable**Flash Point (°C)** :Not applicable**Explosion Properties** :No data**Density (g/cm³)** :5.4 (bulk density : 2.09)**Solubility in water** :Negligible**10. STABILITY AND REACTIVITY****Stability** :Stable**Hazardous Reactions** :Dust explosion, like most finely divided organic powders.**Conditions to avoid** :Electric discharge, throwing into fire.**Materials to avoid** :Oxidizing Materials**Hazardous Decomposition Products** :CO, CO₂ and NO_x**Further Information** :None**11. TOXICOLOGICAL INFORMATION****Acute Toxicity**Ingestion (oral) :LD₅₀>2000mg/kg (Rats) (Estimated from the constituent components)Dermal :LD₅₀>2000mg/kg (Rats)

Inhalation :No data

Eye irritation :Not an irritant (Rabbits)

Skin irritation :Not an irritant (Rabbits)

Skin sensitizer :No sensitization

Mutagenicity :Negative (Ames Test)

Carcinogenicity :In 1996 the IARC reevaluated carbon black as a Group 2B carcinogen (possible human carcinogen). This classification is given to chemicals for which there is inadequate human evidence, but sufficient animal evidence on which to base an opinion of carcinogenicity. The classification is based upon the development of lung tumors in rats receiving chronic inhalation exposures to free carbon black at levels that induce particle overload of the lung. Studies performed in animal models other than rats did not show any association between carbon black and lung tumors. Moreover, a two-year cancer bioassay using a typical toner preparation containing carbon black demonstrated no association between toner exposure and tumor development in rats.

Chronic Effect :In a study in rats of chronic inhalation exposure to a typical toner, a mild to moderate degree of lung fibrosis was observed in 92% of the rats in the high concentration (16mg/m³) exposure group, and a minimal to mild degree of fibrosis was noted in 22% of the animals in the middle (4mg/m³) exposure group, but no pulmonary change was reported in the lowest (1mg/m³) exposure group, the most relevant level to potential human exposures.

Data Revised: Jul .31, 2002

Data Issued: Jun. 1, 1998

MSDS NO. F-30831

12. ECOLOGICAL INFORMATION

No data are available.

13. DISPOSAL CONSIDERATION

Waste from residues :Waste material may be dumped or incinerated under conditions which meet all federal, state and local environmental regulations.**Contaminated Packaging** :Waste may be disposed or incinerated under conditions which meet all federal, state and local environmental regulations.

14. TRANSPORT INFORMATION

UN Classification :None
Not classified as hazardous for transport.

15. REGULATORY INFORMATION

US Information

TSCA (Toxic Substances Control Act) :

All chemical substances in this product comply with all applicable rules or order under TSCA.

SARA (Superfund Amendments and Reauthorization Act) Title III

302 Extreme Hazardous Substance :None

311/312 Hazard Classification :None

EU Information

1999/45/EC and 67/548/EEC

Symbol & Indication :Not required

R-Phrase :Not required

76/769/EEC :All chemical substances in this product comply with all applicable rules or order under 76/769/EEC.

16. OTHER INFORMATION

NFPA Rating (USA) :Health=1 Flammability=1 Reactivity=0

WHMIS Legislation (Canada) :This product is not a controlled product.

References

IARC (1996) :IARC monographs on the Evaluation of the Carcinogenic Risk of Chemicals to Humans, Vol. 65, Printing Process And Printing Inks, Carbon Black and Some Nitro Compounds, Lyon, pp.149-261

H.Muhle, B.Bellmann, O.Creutzenberg, C.Dasenbrock, H.Ernst, R.Kilpper, J.C.MacKenzie, P.Morrow, U.Mohr,

S.Takenaka, and R.Mermelstein (1991) Pulmonary Response to Toner upon Chronic Inhalation Exposure in Rats.

Fundamental and Applied Toxicology 17, pp.280-299.

The information on this data sheet represents our current data and best opinion as to the proper use in handling of this product under normal conditions. However, all materials may present unknown hazards and should be used with caution. Although certain hazards are described herein, we do not guarantee that these are the only hazards which exist.

INDEX

Symbols

- [#] key 31, 33, 36
- [◀] key 10, 23, 28, 29, 31
- [▶] key 10, 23, 28, 29, 31

2

- 2 IN 1 copying 35, 65
- [2-SIDED COPY] key 10, 31, 32

A

- About supplies and options 91
- About the scan head 17
- Appendix 92
- Audible signals 66, 70
- Auto clear 16, 64
- Auto power shut-off mode 17, 64, 73
- Automatic two-side copying..... 30
- Automatic two-sided copying 30

B

- Base setting..... 70
- Basic procedure for printing 60
- Before installation 41
- Button Manager 40, 55, 61
- Button Manager scan menu 62
- Bypass tray..... 9, 18, 21
- Bypass tray paper guides..... 9, 22

C

- Cabinet 88
- Canceling a print job..... 60
- Caution
 - Handling the machine..... 4
 - label on the machine 3
 - Selecting an installation site 3
 - Using the machine..... 3
- Changing a tray's paper size settings 23
- Charger cleaner..... 9, 90
- Checking packed components and accessories 12
- Checking the total count..... 87
- Checking the drum cartridge life..... 87
- Cleaning the machine..... 88

- Cleaning the TD cartridge and drum cartridge 89
- [CLEAR ALL] key 11, 16
- [CLEAR] key 10, 24, 80
- Connecting a USB cable 46
- Convenient copy function 30
- Conventions used in this manual and online manual 6

D

- Display..... 10
- Display messages 71
- Document feeder cover 9, 83
- Document feeder tray..... 9, 25
- Document glass.... 9, 24, 31, 33, 35, 88
- Drum cartridge replacement..... 86
- Drum cartridge..... 9, 86, 89
- Drum cartridge handle..... 86

E

- Envelope 18, 21
- Environmental information..... 5
- Error indicator..... 10, 71, 76, 82, 83, 86
- [E-SORT/SP.FUN] key ... 10, 33, 35, 38
- Exit area 9, 83
- [EXPOSURE ()] key 10, 28
- Exposure value guidelines 28

F

- Factory default settings 67
- Front cover 9
- Fusing unit release lever 9, 81, 82

H

- Handles 9, 13
- Hardware and software requirements 41
- How to place the original 24
- How to use the online manual 63

I

| | |
|--|----|
| Initial settings..... | 16 |
| Installation environment and usable software | 41 |
| Installing Acrobat Reader | 63 |
| Installing the software..... | 42 |
| Installing the TD cartridge | 14 |
| Introduction..... | 6 |
| IP address | 48 |

L

| | |
|--|------------|
| Labels..... | 18, 19, 21 |
| LAN connector..... | 9, 47 |
| Loading paper | 18 |
| Loading paper in the bypass tray | 22 |
| Loading the paper tray | 19 |
| Long edge | 30, 38 |
| LPR (TCP/IP) direct printing | 50 |



M

| | |
|------------------------------------|------------|
| Main features..... | 7 |
| Maintenance..... | 71 |
| Margin shift..... | 38, 66 |
| Margin width | 66 |
| Memory full..... | 34 |
| [MENU] key | 10 |
| MFP driver..... | 40, 77 |
| Misfeed removal | |
| - Misfeed in the fusing area | 81 |
| - Paper feed area..... | 81 |
| - RSPF..... | 83 |
| - Transport area..... | 82 |
| Mode indicators | 10 |
| [MODE SELECT] key | 10, 60, 61 |

N

| | |
|----------------------|--------|
| Normal copying | 24 |
| Numeric keys..... | 10, 27 |

O

| | |
|---|--------|
| Offset function | 34, 65 |
| [OK] key..... | 10 |
| Online Manual | 6, 63 |
| Operation in copy, printer, and scanning modes | 62 |
| Operation manual..... | 6 |
| Operation manual (for facsimile) | 6 |
| Operation panel..... | 9, 10 |
| Original guides | 9, 25 |
| Original types | |
| - AUTO (AUTO) | 28 |
| - PHOTO () | 28 |
| - TEXT () | 28 |
| Originals that cannot be used in the RSPF | 26 |

P

| | |
|--|----------------|
| Paper..... | 18 |
| Paper output tray..... | 9 |
| Paper output tray extension | 9, 26 |
| Paper size setting..... | 23 |
| Paper tray..... | 9, 18, 19 |
| Paper type | 18 |
| Plug and play screen does not appear | 78 |
| Power cord | 9, 15 |
| Power off | 17 |
| Power on | 16 |
| Power save indicator..... | 10, 17, 73, 76 |
| Power save modes..... | 17 |
| Power switch | 9, 16, 17 |
| Preheat mode..... | 17, 64 |
| Preparations | 9 |
| Preparing the machine for installation | 13 |
| Preset ratio | 29 |
| Pressure plate lock..... | 19 |
| Printer driver..... | 40 |
| Printer/scanner functions..... | 59 |
| Problems during setup the software | 77 |
| Protective materials..... | 13 |

R

| | |
|----------------------------|---------------------------|
| Ready indicator ... | 11,16, 71, 81, 82, 83 |
| Recycled paper | 18 |
| Removing the software..... | 79 |
| Reversing tray | 9, 83 |
| Roller | 83 |
| Roller rotating knob | 82 |
| ROPM..... | 59 |
| RSPF..... | 9, 25, 32, 34, 37, 83, 88 |
| RSPF indicator | 10, 25, 80 |
| RSPF roller..... | 88 |
| RSPF scanning window | 88 |

S

| | |
|---|------------|
| Scan head lamp | 17 |
| Scan head locking switch | 13 |
| Scanner driver | 40 |
| Scanning from the operation panel .. | 61 |
| Scanning from your computer | 62 |
| Selecting a setting for a user program | 69 |
| Selecting the tray..... | 27 |
| Set the IP address..... | 48 |
| Set up the software | 40 |
| Setting the number of copies..... | 27 |
| Setting up button manager | |
| - Windows 98/Me/2000..... | 57 |
| - Windows XP | 55 |
| Sharing the printer | 52 |
| Sharpdesk | 40 |
| Short edge..... | 30, 38 |
| Side cover | 9 |
| Side cover open button | 9 |
| Sort copy | 33 |
| Special papers..... | 19 |
| Specifications | 92 |
| Standard paper..... | 18 |
| [START] key | 11, 17, 25 |
| Stream feeding mode | 26, 65 |
| Supply list | 91 |

T

| | |
|-------------------------------|---------------|
| TD cartridge..... | 9, 14, 85, 89 |
| TD cartridge replacement..... | 85 |
| Thick paper..... | 18 |
| Transfer charger..... | 9, 90 |
| Transparency film..... | 18, 19, 21 |
| Tray location indicator | 10, 71 |
| [TRAY SELECT] key | 10, 22, 27 |
| Troubleshooting..... | 71 |

U

| | |
|------------------------------|-------------------|
| USB | 5, 42, 45, 59, 68 |
| USB connector | 9, 46 |
| User program | 64 |
| Using the printer mode | 60 |
| Using the scanner mode | 61 |

Z

| | |
|-------------------|--------|
| [ZOOM] key | 11, 29 |
| Zoom setting..... | 29 |

INDEX BY PURPOSE

Preparations

| | |
|--|----|
| Installation the machine, preparing | 13 |
| Packed components and accessories, checking | 12 |
| Paper, loading | |
| - Bypass tray..... | 22 |
| - Paper tray..... | 19 |
| Power, turn off | 17 |
| Power, turn on | 16 |
| Scan head locking switch, releasing | 13 |
| TD cartridge, Installing | 14 |
| Tray's paper size, setting..... | 23 |
| User program, setting..... | 69 |

Making copies

| | |
|-----------------------------------|----|
| Copying | |
| - Document glass..... | 24 |
| - RSPF..... | 25 |
| Enlarging/reducing copies | 29 |
| Exposure, adjusting..... | 28 |
| Exposure, selecting | 28 |
| Setting the number of copies..... | 27 |
| Stream feeding mode, using | 26 |
| Tray, selecting | 27 |

Using convenient copy functions

| | |
|-----------------------------|----|
| 2 IN 1 copying, using | |
| - Document glass..... | 35 |
| - RSPF..... | 37 |
| Automatic two-sided copying | |
| - Document glass..... | 31 |
| - RSPF..... | 32 |
| Margin shift, using | 38 |
| Sort copying, using | |
| - Document glass..... | 33 |
| - RSPF..... | 34 |

Connecting the computer

| | |
|---|----|
| Acrobat Reader, installing | 63 |
| Basic procedure for printing | 60 |
| Button Manager, setting up | |
| - Windows 98/Me/2000..... | 57 |
| - Windows XP | 55 |
| Installing the software-Network connection | 47 |
| Installing the software..... | 42 |
| Online manual, using..... | 63 |
| Print job, canceling | 60 |
| Printer mode, using | 60 |
| Scanner mode, using | 61 |
| Scanning from your computer | 62 |
| Scanning using the keys on the machine..... | 61 |

Troubleshooting and maintenance

| | |
|---|----|
| Checking the total count and drum cartridge life | 87 |
| Cleaning the machine | |
| - Cabinet..... | 88 |
| - Document glass..... | 88 |
| - Drum cartridge..... | 89 |
| - RSPF..... | 88 |
| - TD cartridge..... | 89 |
| - Transfer charger..... | 90 |
| Drum cartridge, replacing | 86 |
| Misfeeds, removing | |
| - Fusing area | 81 |
| - RSPF..... | 83 |
| - Paper feed area..... | 81 |
| - transport area | 82 |
| TD cartridge, replacing | 85 |

MEMO



MEMO

Required in IEC-950 (EN 60 950) - Europe

- The equipment should be installed near an accessible socket outlet for easy disconnection.

Required in Appendix ZB of BS 7002 (En 60 950) — United Kingdom

MAINS PLUG WIRING INSTRUCTIONS

The mains lead of this equipment is already fitted with a mains plug which is either a non-rewireable (moulded) or a rewireable type. Should the fuse need to be replaced, a BSI or ASTA approved fuse to BS1362 marked  or  and of the same rating as the one removed from the plug must be used.

Always refit the fuse cover after replacing the fuse on the moulded plug. Never use the plug without the fuse cover fitted.

In the unlikely event of the socket outlet in your home not being compatible with the plug supplied either cut-off the moulded plug (if this type is fitted) or remove by undoing the screws if a rewireable plug is fitted and fit an appropriate type observing the wiring code below.

DANGER: The fuse should be removed from the cut-off plug and the plug destroyed immediately and disposed of in a safe manner. Under no circumstances should the cut-off plug be inserted elsewhere into a 13A socket outlet as a serious electric shock may occur.

To fit an appropriate plug to the mains lead, follow the instructions below:

IMPORTANT: The wires in this mains lead are coloured in accordance with the following code:

| | |
|--------------------------|----------------|
| GREEN-AND-YELLOW: | Earth |
| BLUE: | Neutral |
| BROWN: | Live |

As the colours of the wires in this mains lead may not correspond with coloured markings identifying the terminals in your plug, proceed as follows:

The wire which is coloured **GREEN-AND YELLOW** must be connected to the terminal in the plug which is marked with the letter **E**, or by the safety earth symbol  , or coloured green or green-and-yellow.

The wire which is coloured **BLUE** must be connected to the terminal which is marked with the letter **N** or coloured black.

The wire which is coloured **BROWN** must be connected to the terminal which is marked with the letter **L** or coloured red.

If you have any doubt, consult a qualified electrician.

WARNING: THIS APPARATUS MUST BE EARTHED.

VAROITUS!
 LAITTEEN KÄYTTÄMINEN
 MUULLA KUIN TÄSSÄ
 KÄYTTÖOHJEESSA MAINITULLA
 TAVALLA SAATTA AALTISTAA
 KÄYTTÄJÄN
 TURVALLISUUSLUOKAN 1
 YLITTÄVÄLLE
 NÄKYMÄTTÖMÄLLE
 LASERSÄTEILYLLE.

WARNING
 OM APPARATEN ANVÄNDS PÅ
 ANNAT SÄTT ÄN I DENNA
 BRUKSANVISNING
 SPECIFICERATS, KAN
 ANVÄNDAREN UTSÄTTAS FÖR
 OSYNLIG LASERSTRÅLNING,
 SOM ÖVERSKRIDER GRÄNSEN
 FÖR LASERKLASS 1.

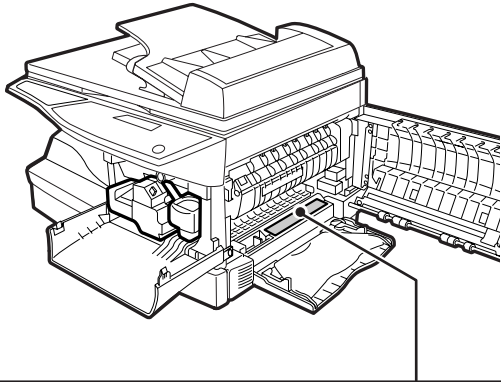

Laserstrahl

CAUTION INVISIBLE LASER RADIATION WHEN OPEN AND INTERLOCKS DEFEATED. AVOID EXPOSURE TO BEAM.
VORSICHT UNSICHTBARE LASERSTRÄHLUNG, WENN ABDECKUNG GEÖFFNET UND SICHERHEITSVORRICHTUNG ÜBERBRÜCKT. NICHT DEM STRAHL AUSSETZEN.
ADVARSEL USYNLIG LASERSTRÅLNING VED ÅBNING, NÅR SIKKERHEDSAFBRYDERE ER UDE AF FUNKTION. UNDGÅ UDSÆTTELSE FOR STRÅLING.

ADVERSEL USYNLIG LASERSTRÅLNING NÅR DEKSEL ÅPNES OG SIKKERHEDSLÅS BRYTES. UNNGÅ EKSPONERING FOR STRÅLEN.
VARNING OSYNLIG LASERSTRÅLNING NÅR DENNA DEL ÄR ÖPPNAD OCH SPÄRRAR ÄR UTKOPPLADE. STRÅLEN ÄR FARLIG. BETRÄKTA EJ STRÅLEN.
VARO! AVATTAESSA JA SUOJALLUKITUS OHITETTAESSA OLET ALTIINNA NÄKYMÄTÖNTÄ LASERSÄTEILYLLE. ÄLÄ KÄTSÖ SÄTEESEEN.

LUOKAN 1 LASERLAITE

KLASS 1 LASERAPPARAT

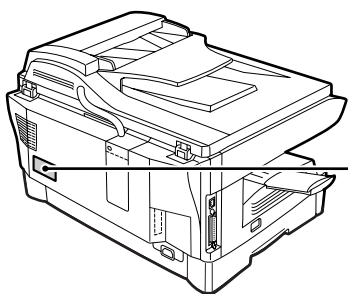

**CLASS 1
 LASER PRODUCT
 LASER KLASSE 1**

SHARP®

PRINTED IN FRANCE
TINSE1232TSZZ

Free Manuals Download Website

<http://myh66.com>

<http://usermanuals.us>

<http://www.somanuals.com>

<http://www.4manuals.cc>

<http://www.manual-lib.com>

<http://www.404manual.com>

<http://www.luxmanual.com>

<http://aubethermostatmanual.com>

Golf course search by state

<http://golfingnear.com>

Email search by domain

<http://emailbydomain.com>

Auto manuals search

<http://auto.somanuals.com>

TV manuals search

<http://tv.somanuals.com>