

# SHARP®

MODEL

## LC-65RX1X

LCD COLOUR TELEVISION

OPERATION MANUAL

# AQUOS



Fine Motion Advanced

Digital Video Broadcasting

Download from [www.Somanuals.com](http://www.Somanuals.com). All Manuals Search And Download.



# OPERATION MANUAL

## Dear SHARP customer

Thank you for your purchase of the SHARP LCD colour TV product. To ensure safety and many years of trouble-free operation of your product, please read the Important Safety Precautions carefully before using this product.

## Contents

### Introduction

Dear SHARP customer .....	1
Contents .....	1
Important Safety Precautions .....	4
Supplied accessories .....	5
Trademarks .....	5

### Preparation

Part names .....	6
TV (Front/Side) .....	6
TV (Rear).....	7
Remote control unit.....	8
Before turning on the power.....	9
Supplying electric power to the antenna .....	10
Initial auto installation .....	11
Checking signal strength and channel strength.....	11
Connecting external devices .....	12
Connecting a VCR, game console or camcorder .....	12
Connecting a DVD player.....	12
Connecting a STB (Satellite, Cable, etc.).....	13
Connecting a PC.....	13
Using Digital Audio Output.....	13
Protecting against overturning.....	14
Inserting the batteries .....	15
Using the remote control unit.....	15
Cautions regarding the remote control unit .....	15
Turning the TV on/off.....	16
Turning on the power .....	16
Turning off the power .....	16
About Menu operations.....	17
What is Menu? .....	17
Basic Menu operations .....	17
About the Guide Display .....	17
TV/AV input mode menu items .....	18
PC input mode menu items .....	19

### Watching TV

Setting channels automatically .....	20
Selecting programmes .....	21
Adjusting the volume .....	21
Menu language settings.....	21
Setting channels to your preference.....	22
Digital settings.....	22
Manual setting for each channel (Analogue) .....	23
Sorting programmes .....	25
Erasing programmes.....	25
Useful viewing functions .....	26
Returning to the previously selected channel (Flashback).....	26
Freezing the image.....	26

**Watching TV (Continued)**

Muting the audio temporarily .....	26
Outputting only audio.....	26
Switching the analogue audio format .....	27
Switching the digital audio format .....	27
Password setting for the child lock (for TV input mode) .....	28
Parental Rate.....	29
Programme Title Display .....	29
<b>Energy conservation settings.....</b>	<b>30</b>
Auto power-off at a designated time .....	30
Auto power-off after the end of broadcast .....	30
Auto power-off when there are no operations performed .....	30
Ecology .....	30
Reducing the start-up time .....	30
<b>Picture size settings .....</b>	<b>31</b>
Selecting the Wide Screen Signalling (WSS) picture size automatically.....	31
Selecting the Wide Screen Signalling (WSS) picture size manually.....	31
Selecting the picture size manually.....	32
<b>Selecting a preset AV MODE .....</b>	<b>33</b>
<b>Manual picture settings.....</b>	<b>34</b>
Picture adjustment .....	34
Advanced picture settings .....	35
<b>Other picture settings.....</b>	<b>36</b>
DNR (Digital Noise Reduction) .....	36
Adjusting the image position.....	36
Game Play Time.....	36
Indicating time on the screen.....	37
<b>Audio adjustment.....</b>	<b>38</b>
Output Volume Select .....	38
Automatic Volume Adjustment.....	39
Clear Voice .....	39
Digital Audio Output.....	39
Programme Guide.....	40
INFO .....	40
<b>Favourite channel setting.....</b>	<b>41</b>
<b>ATV (Analogue)/DTV/RADIO buttons .....</b>	<b>42</b>
<b>EPG .....</b>	<b>43</b>
EPG display settings .....	43
Time Zone .....	43
<b>Selecting a programme using EPG .....</b>	<b>44</b>
Basic Operation.....	44
Selecting a programme.....	44
<b>Timer recording using EPG.....</b>	<b>46</b>
<b>Cancelling the timer recording .....</b>	<b>46</b>

**Settings when using external devices**

<b>Settings when using HDMI output devices .....</b>	<b>47</b>
<b>Selecting the input source and signal type .....</b>	<b>49</b>
Selecting input source .....	49
Selecting input signal type.....	49
Selecting the size of the picture for recording .....	49
<b>Labelling input sources.....</b>	<b>50</b>
<b>Skipping HDMI/RGB input .....</b>	<b>50</b>
<b>Colour system settings .....</b>	<b>50</b>

**AQUOS LINK**

<b>Controlling HDMI devices using AQUOS LINK .....</b>	<b>51</b>
<b>AQUOS LINK connection .....</b>	<b>52</b>
Connecting an AQUOS BD Player via the AQUOS LINK-compatible audio system ...	52



**AQUOS LINK (Continued)**

Connecting an AQUOS BD Player only.....	52
<b>AQUOS LINK Setup .....</b>	<b>52</b>
AQUOS LINK Auto power on .....	52
Selecting recorder.....	53
Using Genre Info. ....	53
<b>Operating an AQUOS LINK device .....</b>	<b>53</b>
Listening with the AQUOS LINK-compatible audio system.....	53
Listening with the AQUOS TV speaker system.....	54
Manually changing the AQUOS LINK-compatible audio system's sound mode ...	54
Calling up the menu of an external device connected with the TV via HDMI .....	54
Playback of titles using AQUOS LINK.....	54
Selecting media type for CEC-compatible recorder .....	55
One Touch Recording .....	55
HDMI device selection .....	55
Recording via the CEC-compatible recorder's EPG (only for recorders).....	55

**Connecting a PC**

<b>HDMI Connection.....</b>	<b>56</b>
<b>Analogue Connection .....</b>	<b>56</b>
<b>Displaying a PC image on the screen .....</b>	<b>57</b>
Selecting the picture size .....	57
Adjusting the PC image automatically .....	58
Adjusting the PC image manually .....	58
<b>Input resolution settings .....</b>	<b>59</b>
Selecting the input resolution.....	59
<b>PC Control of the TV.....</b>	<b>60</b>
<b>PC compatibility chart.....</b>	<b>61</b>
<b>RS-232C commands list.....</b>	<b>61</b>

**Teletext function**

<b>About Teletext.....</b>	<b>62</b>
<b>Teletext language setting.....</b>	<b>63</b>
<b>Displaying Subpages .....</b>	<b>63</b>
<b>Time display .....</b>	<b>63</b>

**DVB Subtitle**

<b>Displaying Subtitles .....</b>	<b>64</b>
<b>Switching subtitle languages (DVB Subtitle).....</b>	<b>64</b>

**Appendix**

<b>Troubleshooting.....</b>	<b>65</b>
<b>Troubleshooting-Digital broadcasting.....</b>	<b>65</b>
<b>Error messages about recording using AQUOS LINK .....</b>	<b>66</b>
<b>Reset .....</b>	<b>67</b>
<b>Information .....</b>	<b>67</b>
Message List .....	67
Receiver Report .....	67
<b>Identification .....</b>	<b>67</b>
<b>Specifications.....</b>	<b>68</b>
<b>Optional accessory.....</b>	<b>68</b>
<b>Dimensional drawings.....</b>	<b>69</b>
<b>Mounting the TV on the wall .....</b>	<b>70</b>
Removing the stand .....	70
Handling and precautions with the wall-mounted TV .....	71
Wall mounting .....	72
<b>CLEARING THE PASSWORD .....</b>	<b>73</b>
<b>Information on the software license for this product.....</b>	<b>74</b>

# Important Safety Precautions

- **Cleaning** — Unplug the AC cord from the AC outlet before cleaning the product. Use a damp cloth to clean the product. Do not use liquid cleaners or aerosol cleaners.



- **Water and moisture** — Do not use the product near water, such as bathtub, washbasin, kitchen sink, laundry tub, swimming pool and in a wet basement.

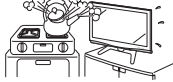

- Do not place vases or any other water-filled containers on this product. The water may spill onto the product causing fire or electric shock.



- **Stand** — Do not place the product on an unstable cart, stand, tripod or table. Doing so can cause the product to fall, resulting in serious personal injuries as well as damage to the product. Use only a cart, stand, tripod, bracket or table recommended by the manufacturer or sold with the product. When mounting the product on a wall, be sure to follow the manufacturer's instructions. Use only the mounting hardware recommended by the manufacturer.



- When relocating the product placed on a cart, it must be moved with utmost care. Sudden stops, excessive force and uneven floor surface can cause the product to fall from the cart.



- **Ventilation** — The vents and other openings in the cabinet are designed for ventilation. Do not cover or block these vents and openings since insufficient ventilation can cause overheating and/or shorten the life of the product. Do not place the product on a bed, sofa, rug or other similar surface, since they can block ventilation openings. This product is not designed for built-in installation; do not place the product in an enclosed place such as a bookcase or rack, unless proper ventilation is provided or the manufacturer's instructions are followed.



- The LCD panel used in this product is made of glass. Therefore, it can break when the product is struck forcefully or with a sharp object. If the LCD panel is broken, be careful not to be injured by broken glass.



- **Heat sources** — Keep the product away from heat sources such as radiators, heaters, stoves and other heat-generating products (including amplifiers).



- To prevent fire, never place any type of candle or naked flames on the top or near the TV set.



- To prevent fire or shock hazard, do not place the AC power cord under the TV set or other heavy items.



- Do not place heavy objects on this product or stand on it. Doing so could cause injury if the product overturns. Take special care near children and pets.

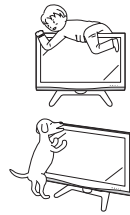

The LCD panel is a very high technology product with 2,073,600 pixels, giving you fine picture details. Due to the very large number of pixels, occasionally a few non-active pixels may appear on the screen as a fixed point of blue, green or red. This is within product specifications and does not constitute a fault.

## Precautions when transporting the TV

- When transporting the TV, never carry it by holding or otherwise putting pressure onto the display. Be sure to always carry the TV by two people holding it with two hands — one hand on each side of the TV.

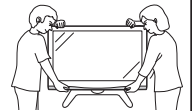





- Do not display a still picture for a long time, as this could cause an afterimage to remain.

- Install the product on the place where the AC cord can be unplugged easily from the AC outlet, or from the AC INPUT terminal on the rear of the product.

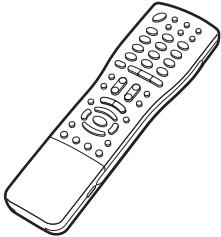
# Supplied accessories

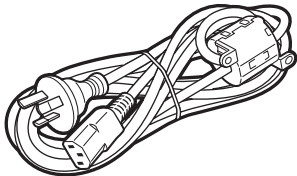
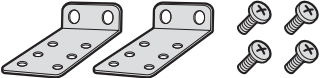
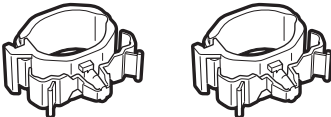
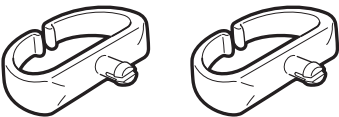
Make sure the following accessories are provided with the product.

<p>Remote control unit</p>	<p>"AAA" size battery (×2)</p>	<p>AC cord</p>
 <p>Used with batteries inserted. Page 8</p>	 <p>Page 15</p>	 <p>Always use the AC cord supplied with the TV. Page 9</p>
<p>Safety restraints</p>	<p>Cable clamp (×2)</p>	<p>Cable clamp (×2)</p>
 <p>Restraints brackets      Screws for brackets</p> <p>Page 14</p>	 <p>For bundling cables. Page 9</p>	 <p>For bundling cables. Page 9</p>
<p>Operation manual</p>		
		

## Trademarks

- TruSurround XT, SRS and (●●)® symbol are trademarks of SRS Labs, Inc. TruSurround XT technology is incorporated under license from SRS Labs, Inc.
- Manufactured under license from Dolby Laboratories. Dolby and the double-D symbol are trademarks of Dolby Laboratories.
- "HDMI, the HDMI logo and High-Definition Multimedia Interface are trademarks or registered trademarks of HDMI Licensing LLC."
- "x.v.Colour" and **x.v.Colour** are trademarks of Sony Corporation.

# Preparation

## Part names

### TV (Front/Side)

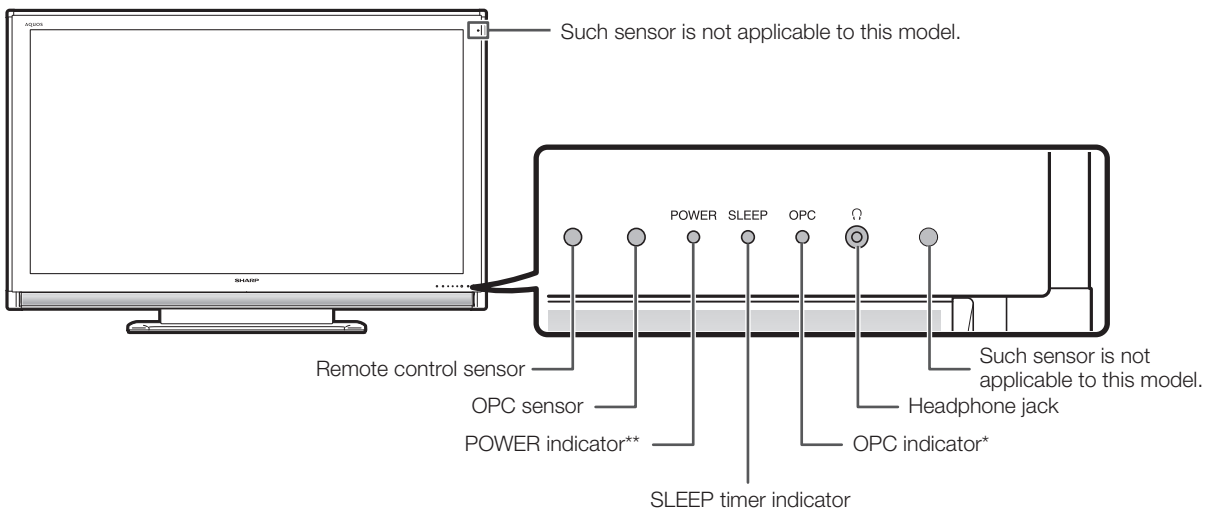
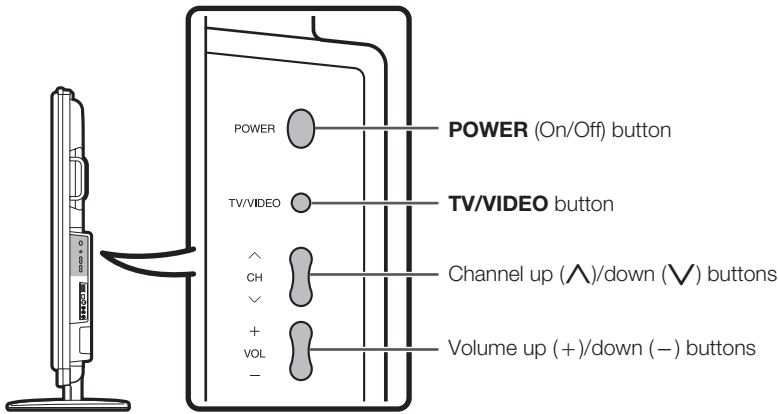

### Regarding the headphone jack

- Use headphones with a stereo mini plug (Ø 3.5 mm).
- Be sure to unplug headphones from the jack when they are not in use.
- The speakers do not output volume when headphones are plugged in.
- The "Audio" menu cannot be operated when headphones are plugged in.
- You can set the volume to different levels for each input source.

### Volume display when headphones are plugged in



\*OPC: Optical Picture Control (See page 34.)

\*\* See page 16 for the TV status indicator.

• The illustrations in this operation manual are for explanation purposes and may vary slightly from the actual operations.

# Preparation

## TV (Rear)

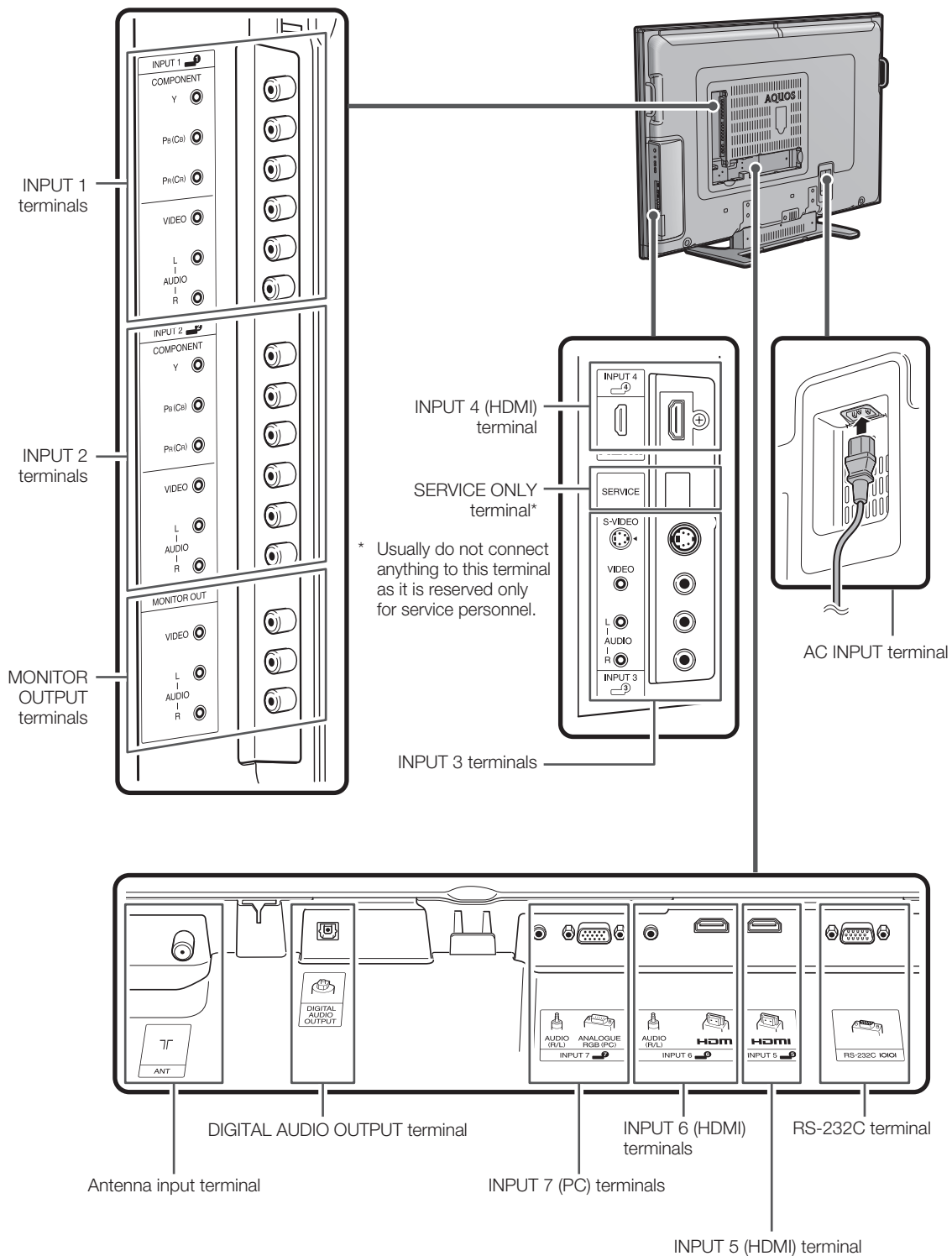

Remote control unit

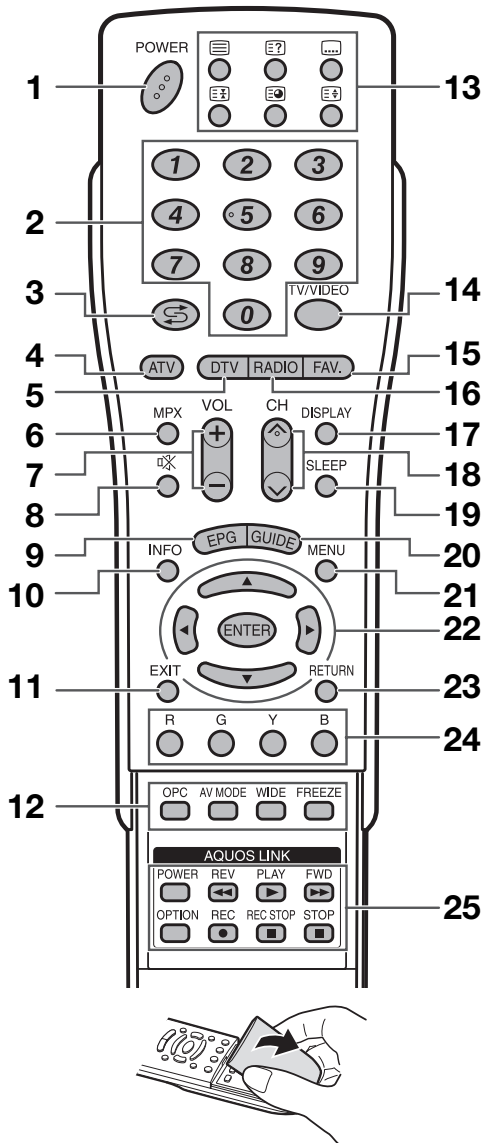

- 1 POWER (STANDBY/ON)**  
To switch the power on and off. (See page 16.)
- 2 0 - 9**  
Set the channel. (See page 21.)  
TELETEXT mode: Set the page. (See pages 62 and 63.)
- 3 ↶ (Flashback)**  
Press to return to the previous selected channel or external input mode. (See page 26.)
- 4 ATV**  
Press to access ANALOGUE mode. (See page 42.)
- 5 DTV**  
Press to access DTV mode. (See page 42.)
- 6 MPX**  
Select the sound multiplex mode. (See page 27.)
- 7 VOL + /VOL -**  
Set the volume. (See page 21.)
- 8 🚫 (Mute)**  
Mute the sound. (See page 26.)

- 9 EPG**  
DTV only: To display EPG (Electronic Programme Guide) screen. (See pages 43 to 46.)
- 10 INFO**  
DTV only: Display the programme information. (See page 40.)
- 11 EXIT**  
Turn off the On-Screen Display.
- 12 OPC**  
To switch the Optical Picture Control on and off. (See page 34.)
- AV MODE**  
Select a video setting. (See page 33.)
- WIDE**  
Change the wide image mode. (See pages 32 and 57.)
- FREEZE**  
Freeze a motion picture on the screen. (See page 26.)
- 13 [TT] (TELETEXT)**  
Select the TELETEXT mode. (all TV image, all TEXT image, TV/TEXT image) (See pages 62 and 63.)
- [RH] (Reveal hidden for TELETEXT)**  
TELETEXT mode: Display hidden characters. (See page 62.)
- [ST] (SUBTITLE for TELETEXT)**  
To turn the subtitles on and off. (See page 64.)
- [H] (Hold)**  
TELETEXT mode: Stop updating Teletext pages automatically. Press [RH] again to release the hold mode. (See pages 62.)
- [SP] (Subpage)**  
Display the Teletext subpage directly. (See page 63.)
- [TF] (Top/Bottom/Full)**  
TELETEXT mode: Set the area of magnification. (See page 62.)
- 14 TV/VIDEO (INPUT SOURCE)**  
Select an input source. (TV, INPUT 1, INPUT 2, INPUT 3, INPUT 4, INPUT 5, INPUT6, INPUT7 (PC)) (See pages 12, 13, 47, 50 and 56.)
- 15 FAV.**  
DTV only: Display the favourite channel setting. (See page 41.)
- 16 RADIO**  
DTV only: Press to access RADIO mode. (See page 42.)
- 17 DISPLAY**  
Displays the channel or input information.  
Displays the time information included in the Teletext broadcast. (See page 63.)
- 18 CH ^ / CH v**  
TV input mode: Select the channel. (See page 21.)  
TELETEXT mode: Select the page. (See pages 62 and 63.)
- 19 SLEEP**  
Set the Sleep timer. (See page 30.)
- 20 GUIDE**  
DTV only: Display the programme list. (See page 40.)
- 21 MENU**  
Display the menu screen. (See page 17.)
- 22 ▲ / ▼ / ◀ / ▶ (Cursor)**  
Select a desired item on the setting screen.
- ENTER**  
Execute a command.
- 23 RETURN**  
MENU mode: Return to the previous menu screen. (See page 17.)
- 24 Colour (Red/Green/Yellow/Blue)**  
Select four preset favourite channels in four different categories. (See page 41 for details.)  
While watching, you can toggle the selected channels by pressing **R, G, Y** and **B**.  
TELETEXT mode: Select the page. (See pages 62 and 63.)
- 25 AQUOS LINK buttons**  
If external equipment such as a AQUOS BD Player is connected via HDMI-certified cables and is AQUOS LINK compatible, you can use these AQUOS LINK buttons. (See pages 51 to 55 for details.)

## Preparation

### Before turning on the power

#### Notes on installing the TV

- Avoid direct sunlight and place the TV in a well-ventilated location.
- Place the TV in a level location.
- Do not turn on the power of the TV before connecting the AC cord.

#### 1 Connecting the antenna cable

To enjoy a clearer picture, use an outdoor antenna. The following is a brief explanation of the types of connections that are used for coaxial cable.

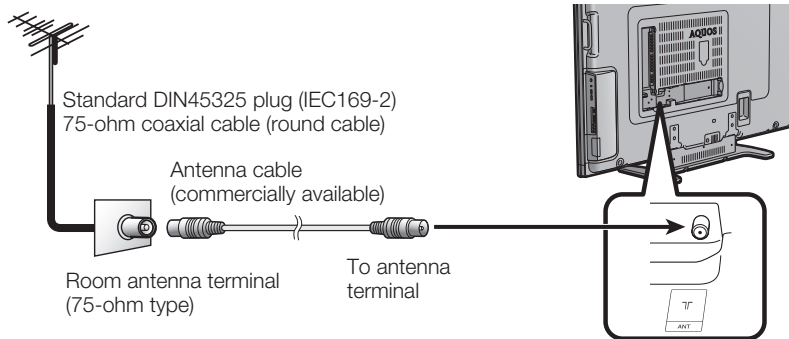

#### 2 Connecting external devices

See pages 12 and 13 for connecting external equipment, such as a VCR and DVD player.

#### 3 Connecting the AC cord

##### CAUTION

- Do not use a power cord other than the one supplied with the TV.



##### Be sure to use a power outlet of AC 110-240 V, 50/60 Hz.

Using power supply other than the one specified may cause fire.

- Place the TV close to the AC outlet, and keep the power plug within reach.
- This product must only be connected to an AC 110-240 V, 50/60 Hz, grounded (3-prong) outlet. Connecting it to any other kind of outlet will damage the product and invalidate the warranty.
- Disconnect the AC cord from the AC outlet if the TV will not be used for a long period of time.

- 1 Plug the power cord (supplied) into the AC input terminal.

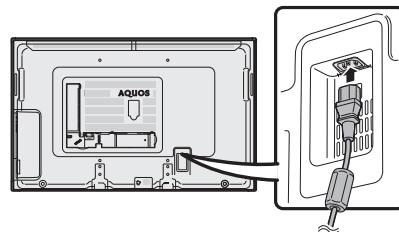

- 2 Plug the power cord (supplied) into the AC power outlet.

#### 4 Bundling the cables

Insert the cable clamp in the hole on the TV as shown.

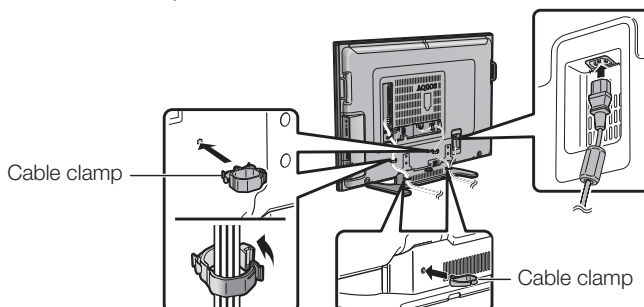

##### CAUTION

- **TO PREVENT RISK OF ELECTRIC SHOCK, DO NOT TOUCH UN-INSULATED PARTS OF ANY CABLES WITH THE AC CORD CONNECTED.**

### Supplying electric power to the antenna

When you set-up the DTV antenna for the first time, or connect the antenna to a community antenna, you need to proceed to set the antenna by following this manual.

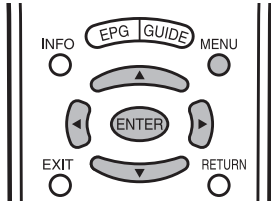

- 1 Press **MENU** and the MENU screen displays.
- 2 Press **◀/▶** to select "Setup".
- 3 Press **▲/▼** to select "Antenna Setup-DIGITAL" and then press **ENTER**.
- 4 Press **▲/▼** to select "Supply Voltage" and then press **ENTER**.
- 5 Press **◀/▶** to select "On" and then press **ENTER**.

Selected item	Description
<b>On</b>	Select "On" when your antenna is set-up and connected independently.
<b>Off</b>	Select "Off" when you do not need to supply voltage to your antenna, i.e. when your antenna is connected to a community antenna. (The factory default setting of this function is "Off".)



## Preparation

### Initial auto installation

When the TV powers on for the first time after purchase, the initial auto installation wizard appears. Follow the menus and make the necessary settings one after another.

#### Confirm the following before turning on the power

- Is the antenna cable connected?
- Is the AC cord plugged in?

- 1 Press **POWER** on the TV.
  - The initial auto installation wizard appears.

- 2 Setting the on-screen display language.



- 3 Press **▲/▼** to select the desired language, and then press **ENTER**.

- 4 Press **ENTER**.

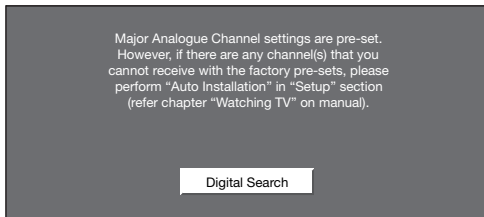

- Major Analogue Channel settings are pre-set. However, if there are any channel(s) that you cannot receive with the factory pre-sets, please perform "Auto Installation" in "Setup" section (See page 20).

- 5 The TV searches for, sorts and stores all the receivable TV stations according to their settings and the connected antenna.

- To abort the initial auto installation in progress, press **ENTER**.

#### NOTE

- If you turn off the power on the TV after performing step 4, the initial auto installation wizard does not appear. The auto installation function allows you to execute the installation again from the Setup menu. (Page 20)
- The initial auto installation wizard will go off if you leave the TV unattended for 30 minutes before searching for channels in step 5.

### Checking signal strength and channel strength

If you install a DVB-T antenna for the first time or relocate it, you should adjust the alignment of the antenna to receive a good reception while checking the antenna setup screen.

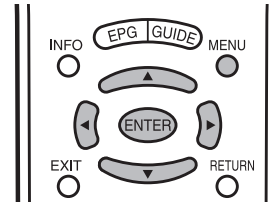

- 1 Press **MENU** and the MENU screen displays.

- 2 Press **◀/▶** to select "Setup".

- 3 Press **▲/▼** to select "Antenna Setup-DIGITAL", and then press **ENTER**.

#### Checking signal strength

Press **▲/▼** to select "Signal Strength".

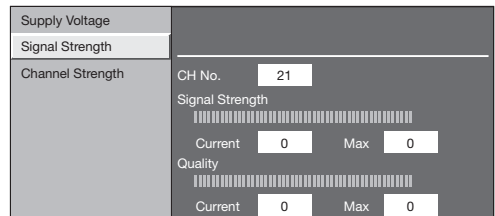

#### Checking channel strength

Press **▲/▼** to select "Channel strength", and then press **ENTER**.

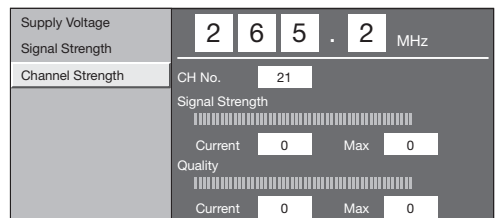

- 4 Position and align the antenna so that the maximum possible values for "Signal Strength" and "Quality" are obtained.

#### NOTE

- The values of "Signal Strength" and "Quality" indicate when to check the appropriate alignment of the antenna.

## Preparation

### Connecting external devices

You can connect many types of external equipment to your TV, like a VCR, game console, camcorder, DVD player, STB (Satellite, Cable, etc.) and PC. To view external source images, select the input source from **TV/VIDEO** on the remote control unit or **TV/VIDEO** on the TV.

#### CAUTION

- To protect all equipment, always turn off the TV before connecting to a VCR, game console, camcorder, DVD player, STB (Satellite, Cable, etc.), PC or other external equipment.
- Refer to the relevant operation manual (VCR, DVD player, etc.) carefully before making connections.

### Connecting a VCR, game console or camcorder

A VCR, game console, camcorder and some other audiovisual equipment can be conveniently connected using the INPUT 1/INPUT 2 (component) or INPUT 3 terminals.

#### When using component cable (commercially available)

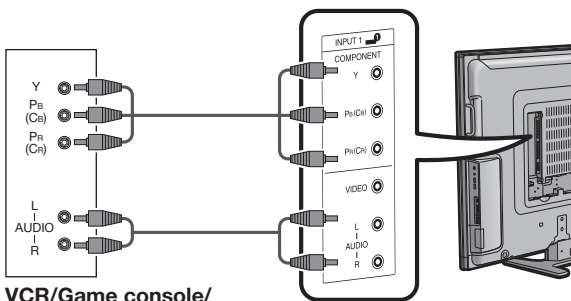

VCR/Game console/  
Camcorder

#### When using composite cable or S-VIDEO cable (commercially available)

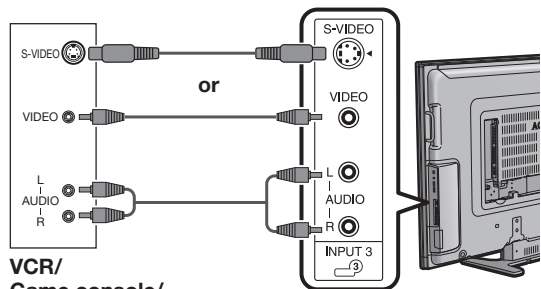

VCR/  
Game console/  
Camcorder

### Connecting a DVD player

You can use the INPUT 1/INPUT 2 (component) or INPUT 4/INPUT 5/INPUT 6 (HDMI) terminals when connecting to a DVD player and other audiovisual equipment.

#### NOTE

- When using a DVI-HDMI conversion adaptor, input the Audio Signal from the AUDIO terminal of INPUT 6. (See page 47.)

#### When using HDMI cable (commercially available)

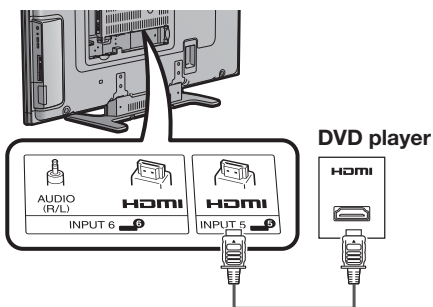

#### When using component cable (commercially available)

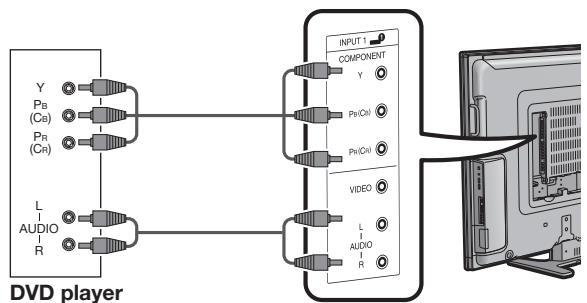

DVD player

## Preparation

### Connecting a STB (Satellite, Cable, etc.)

You can use the INPUT 1/INPUT 2 (component) or INPUT 4/INPUT 5/INPUT 6 (HDMI) terminals when connecting to a STB (Satellite, Cable, etc.) and other audiovisual equipment.

#### NOTE

- When using a DVI-HDMI conversion adaptor, input the Audio Signal from the AUDIO terminal of INPUT 6. (See page 47.)

#### When using HDMI cable (commercially available)

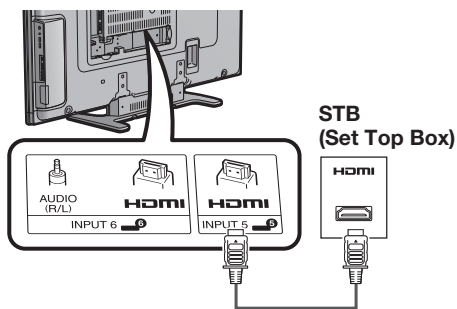

#### When using component cable (commercially available)

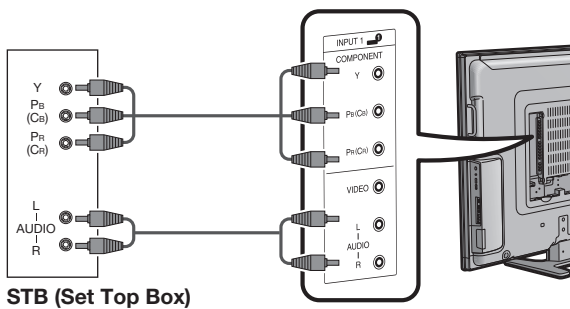

### Connecting a PC

You can use the INPUT 7 (PC) terminals when connecting to a PC. (See page 56.)

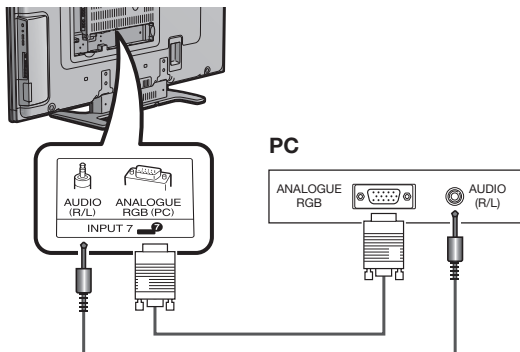

### Using Digital Audio Output

It is possible to output audio through the DIGITAL AUDIO OUTPUT terminal. PCM audio outputs from the terminal.

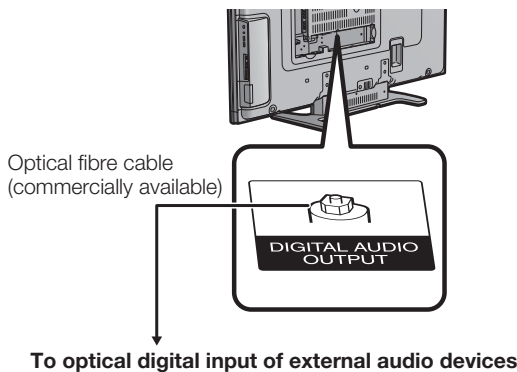

#### NOTE

- The DIGITAL AUDIO OUTPUT terminal usually outputs the same audio from the speakers. (The audio of the content you are viewing is output from the terminal.)
- The DIGITAL AUDIO OUTPUT terminal does not output some signals, depending on devices and software.

## Preparation

### Protecting against overturning

There is a danger of the product overturning in the case of a disaster or sudden collision. Carry out the following tip-resistant measurement for your safety.

#### Anchoring the TV to the wall or a pillar

Affix the 2 clamps (supplied) to the product using the screws (supplied).

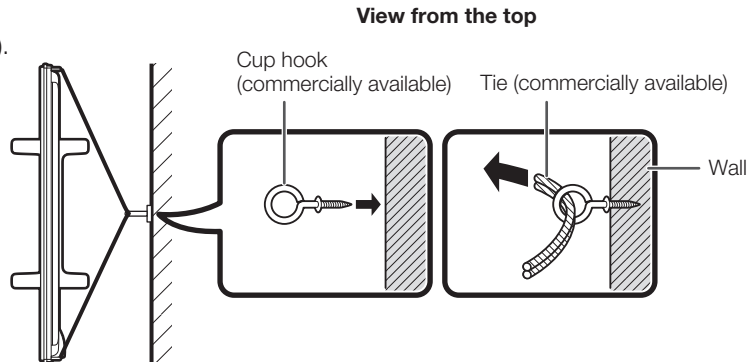

#### Fixing the TV to the table

- 1 Place the TV on the table.
- 2 Attach the two supplied restraining brackets to the stand with two supplied screws.
- 3 Insert commercially available screws in the holes of the restraining brackets from the top and tighten the screws to secure the TV to the table.
  - Use commercially available screws of the proper size to firmly secure the TV.

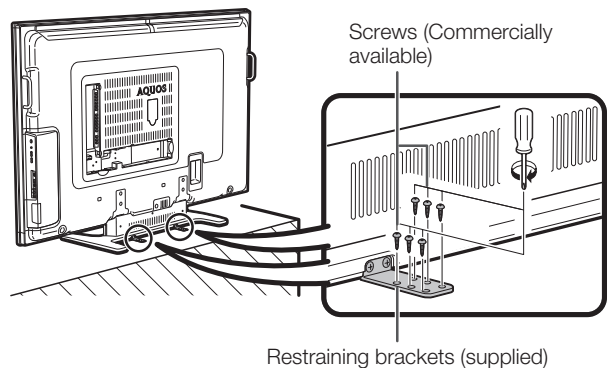
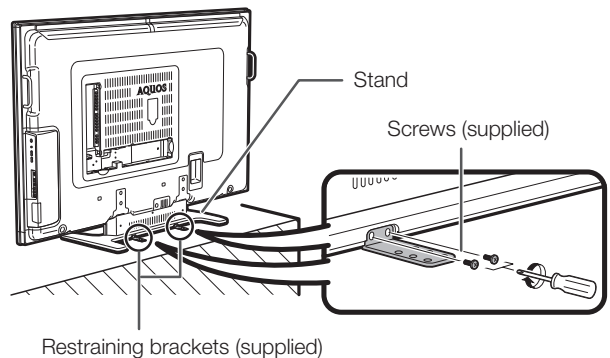

#### CAUTION

- As this product is heavy, use a table that is wide enough to support the product and capable of withstanding the product's weight. The table should be set where it will not be overturned.
- Be sure to use at least two people when moving the TV.

## Preparation

### Inserting the batteries

Before using the TV for the first time, insert two “AAA” size batteries (supplied). When the batteries become depleted and the remote control fails to operate, replace the batteries with new “AAA” size batteries.

1 Open the battery cover.

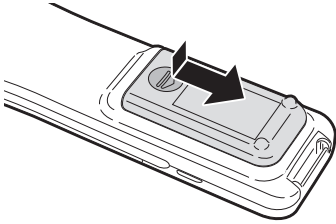

2 Insert the two supplied “AAA” size batteries.

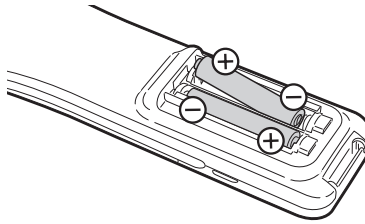

3 Close the battery cover.

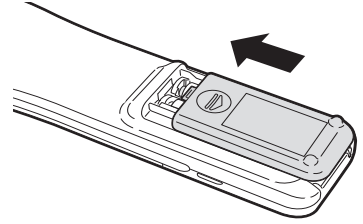

- Place batteries with their terminals corresponding to the (+) and (-) indications in the battery compartment.

### CAUTION

Improper use of batteries can result in chemical leakage or explosion. Be sure to follow the instructions below.

- Do not mix batteries of different types. Different types of batteries have different characteristics.
- Do not mix old and new batteries. Mixing old and new batteries can shorten the life of new batteries or cause chemical leakage in old batteries.
- Remove batteries as soon as they have worn out. Chemicals that leak from batteries can cause a rash. If you find any chemical leakage, wipe thoroughly with a cloth.
- The batteries supplied with this product may have a shorter life expectancy due to storage conditions.
- If you will not be using the remote control unit for an extended period of time, remove the batteries from it.

### Using the remote control unit

Use the remote control unit by pointing it towards the remote sensor window.

Objects between the remote control unit and sensor window may prevent proper operation.

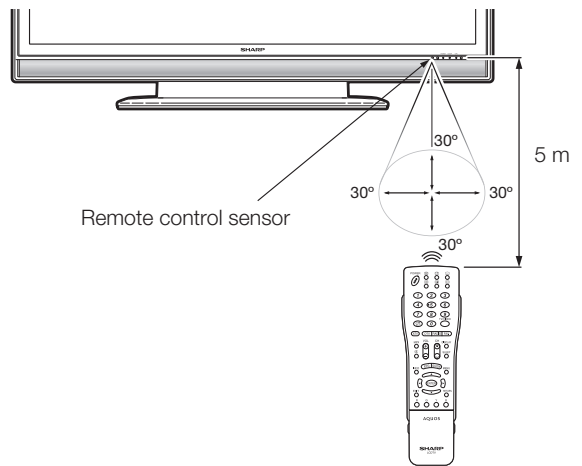

### Cautions regarding the remote control unit

- Do not subject the remote control unit to shock. In addition, do not soak the remote control unit with liquids or place it in an area with high humidity.
- Do not install or place the remote control unit under direct sunlight. The heat may cause deformation of the unit.
- The remote control unit may not work properly if the remote sensor window of the TV is under direct sunlight or strong lighting. In such cases, change the angle of the lighting or TV, or operate the remote control unit closer to the remote sensor window.

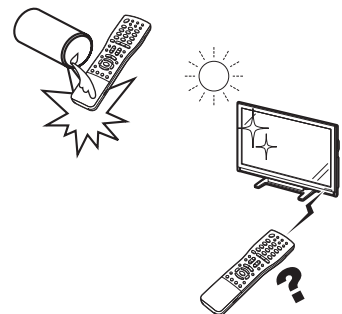

## Preparation

### Turning the TV on/off

#### Turning on the power

Press **POWER** on the TV.

- POWER indicator (Green): The TV is on. (After a few seconds, an image appears with sound.)
- After turning the power "ON" by pressing **POWER** on the TV, you can turn the power ON/OFF by pressing **POWER** on the remote control.

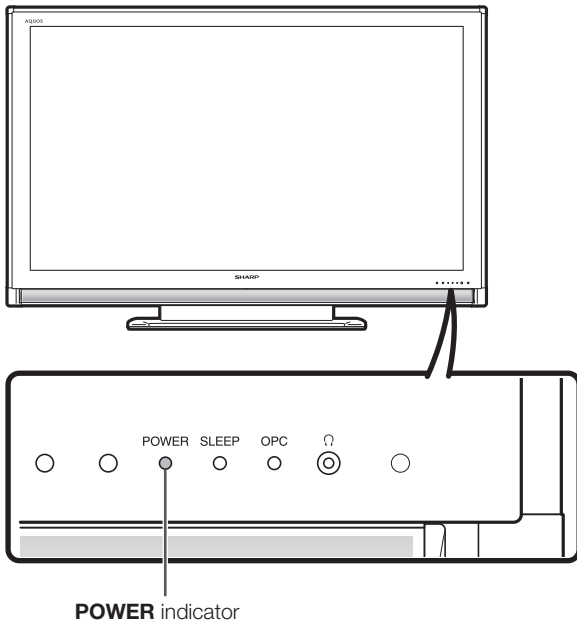
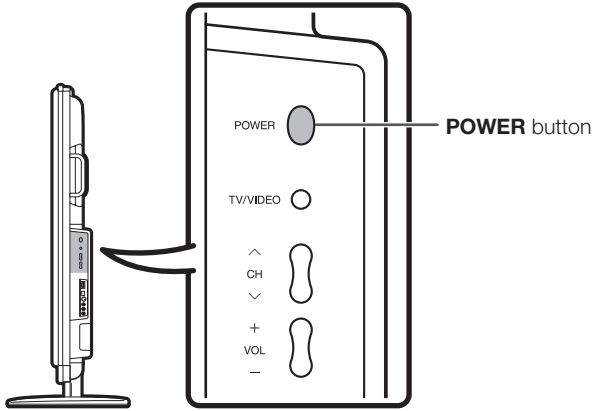

#### Turning off the power

**POWER** button

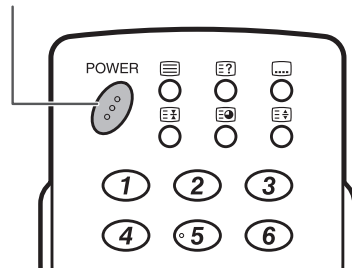

Press **POWER** on the remote control.

- The TV enters standby mode and the image on the screen disappears.
- The POWER indicator on the TV changes from green to red.

Press **POWER** on the TV.

- The POWER indicator on the TV turns off.
- When the TV is turned off by **POWER** on the TV, you cannot turn on the power by pressing **POWER** on the remote control.

#### POWER indicator

Light off	Power off
Lighted (Red)	The TV is in standby mode.
Lighted (Green)	The TV is on.

#### NOTE

- If you are not going to use this TV for a long period of time, be sure to remove the AC cord from the AC outlet.
- Minor power is consumed when the unit is in standby mode.

# Preparation

## About Menu operations

### What is Menu?

- You need to bring up the On-Screen Display to perform settings for the TV. The On-Screen Display for the settings is called "Menu".
- The Menu enables various settings and adjustments. (See pages 18 and 19.)
- The Menu can be operated with the remote control unit.

### Basic Menu operations

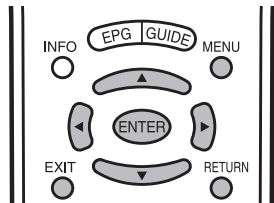

1 Press **MENU** and the MENU screen displays.

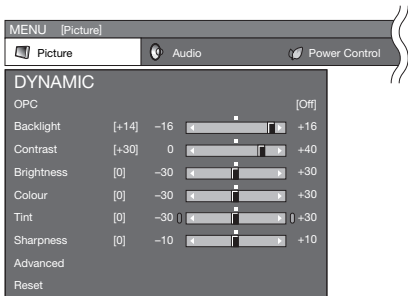

2 Press **◀▶** to select the desired menu, and then press **ENTER**.

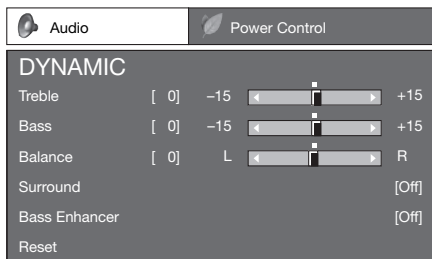

3 Press **▲▼** to select the desired menu item. Press **ENTER** to proceed if necessary.

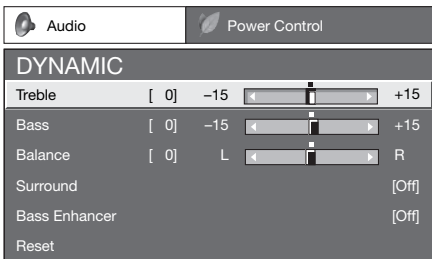

4 Press **▲▼** or **◀▶** to select the desired item or adjust the item to the desired level. Press **ENTER** if necessary.

5 Press **EXIT** or **MENU** to exit the MENU. Press **RETURN** as necessary to return to the previous MENUS.

### NOTE

- The screens in the operation manual are for explanation purposes (some are enlarged, others cropped) and may vary slightly from the actual screens.

### About the Guide Display

The Guide Display at the bottom of the screen shows operations with an On-Screen Display.

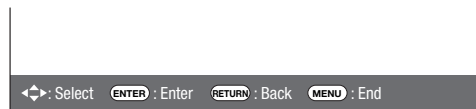

The bar above is an operational guide for the remote control. The bar will change in accordance with each menu setting screen.

## Preparation

### TV/AV input mode menu items

List of menu items to help you with operations

#### Picture

OPC.....	Page 34
Backlight .....	Page 34
Contrast.....	Page 34
Brightness .....	Page 34
Colour .....	Page 34
Tint.....	Page 34
Sharpness .....	Page 34
Advanced	
Colour Temp.....	Page 35
Fine Motion Advanced.....	Page 35
Film Mode.....	Page 35
Active Contrast .....	Page 35
3D-Y/C.....	Page 35
Monochrome.....	Page 35
Range of OPC.....	Page 35
Reset.....	Page 34

#### Option

AQUOS LINK Setup .....	Pages 51 - 55
DNR.....	Page 36
HDMI Audio Select .....	Page 48
Input Select .....	Page 49
Output Volume Select .....	Page 38
Auto Volume.....	Page 39
Clear Voice.....	Page 39
Digital Audio Output.....	Page 39
Audio Only.....	Page 26
Programme Title Display .....	Page 29
Time Display.....	Page 37
Game Play Time.....	Page 36
Colour System .....	Page 50

#### Audio

Treble.....	Page 38
Bass.....	Page 38
Balance.....	Page 38
Surround.....	Page 38
Bass Enhancer.....	Page 38
Reset.....	Page 38

#### Digital Setup

REC Picture Size.....	Page 49
EPG Setup .....	Page 43
Subtitle .....	Page 64
Time Zone .....	Page 43

#### Power Control

No Signal Off.....	Page 30
No Operation Off .....	Page 30
Ecology.....	Page 30

#### Information

Message List.....	Page 67
Receiver Report.....	Page 67

#### Setup

Auto Installation.....	Page 20
Programme Setup .....	Pages 22 - 25
Child Lock .....	Page 28
Antenna Setup-DIGITAL.....	Page 10
Input Skip .....	Page 50
Input Label .....	Page 50
Position.....	Page 36
HDMI Auto View.....	Page 47
WSS .....	Page 31
4:3 Mode.....	Page 31
Standby Mode.....	Page 30
Language.....	Page 21
Text Language .....	Page 63
Identification .....	Page 67
Reset.....	Page 67

#### NOTE

- Some menu items may not be displayed depending on the selected input source.



## Preparation

### PC input mode menu items

List of menu items to help you with operations

#### Picture

OPC.....	Page 34
Backlight .....	Page 34
Contrast.....	Page 34
Brightness .....	Page 34
Colour .....	Page 34
Tint.....	Page 34
Sharpness .....	Page 34
Advanced	
Colour Temp.....	Page 35
Fine Motion Advanced.....	Page 35
Film Mode.....	Page 35
Active Contrast .....	Page 35
Monochrome .....	Page 35
Range of OPC.....	Page 35
Reset.....	Page 34

#### Audio

Treble.....	Page 38
Bass .....	Page 38
Balance.....	Page 38
Surround.....	Page 38
Bass Enhancer .....	Page 38
Reset.....	Page 38

#### Power Control

No Signal Off.....	Page 30
No Operation Off .....	Page 30
Ecology.....	Page 30

#### Setup

Input Skip .....	Page 50
Input Signal .....	Page 59
Auto Sync .....	Page 58
Input Label .....	Page 50
Position.....	Page 36
Fine Sync.....	Page 58
HDMI Auto View.....	Page 47
Standby Mode.....	Page 30
Language.....	Page 21
Reset.....	Page 67

#### Option

AQUOS LINK Setup .....	Pages 51 - 55
DNR.....	Page 36
HDMI Audio Select .....	Page 48
Output Volume Select .....	Page 38
Auto Volume.....	Page 39
Clear Voice.....	Page 39
Audio Only .....	Page 26
Time Display.....	Page 37
Game Play Time.....	Page 36

#### Information

Message List.....	Page 67
Receiver Report.....	Page 67

#### NOTE

- Some menu items may not be displayed depending on the selected input source.

# Watching TV

## Setting channels automatically

You can run auto installation again, even after setting up the preset channels.

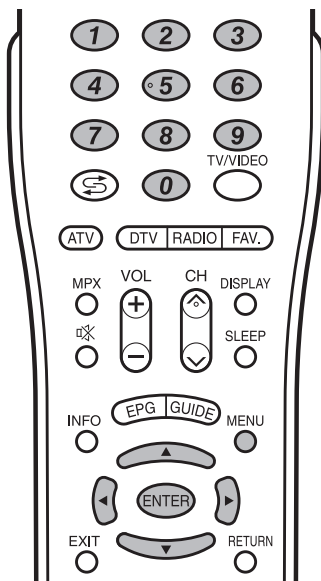

**1** Press **MENU** and the MENU screen displays.

**2** Press **◀/▶** to select “Setup”.

**3** Press **▲/▼** to select “Auto Installation”, and then press **ENTER**.

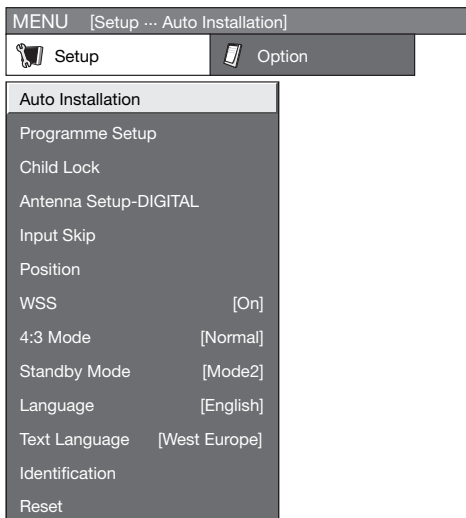

**4** If you have already set the password, enter it here.

- See page 28 for setting a password.



**5** Press **◀/▶** to select “Yes”, and then press **ENTER**.

**6** Press **▲/▼** to select the desired language listed on the screen, and then press **ENTER**. You do not need to do anything during the auto search. Press **MENU** to exit.

## Watching TV

### Selecting programmes

You can change channels in several ways.

#### Using CH $\wedge$ / $\vee$ on the remote control unit

- Press **CH $\wedge$**  to increase the channel number.
- Press **CH $\vee$**  to decrease the channel number.

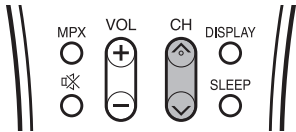

#### NOTE

- **CH $\wedge$ / $\vee$**  on the TV operates the same as **CH $\wedge$ / $\vee$**  on the remote control unit.

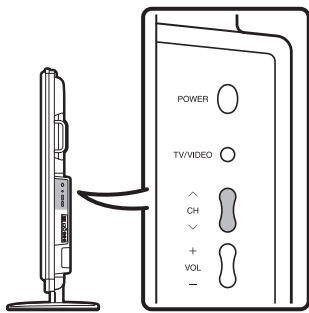

#### Using 0 - 9 on the remote control unit

Select the channels directly by pressing buttons **0** to **9**.

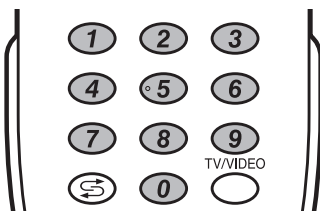

#### EXAMPLE

- To select a 1-digit channel (e.g. channel 2):
- Press **0**, followed by **2**.
- To select a 2-digit channel (e.g. channel 12):
- Press **1**, followed by **2**.

#### When viewing Teletext information

View a page directly which is 3-digit page number from 100 to 899 by pressing buttons **0** to **9**.

### Adjusting the volume

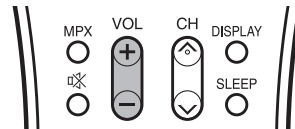
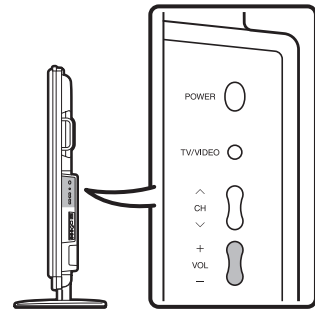

#### Changing the volume

You can change the volume on the TV or on the remote control unit.

- To increase the volume, press **VOL +**.
- To decrease the volume, press **VOL -**.



#### NOTE

- "TV", "INPUT1", "INPUT2", "INPUT3", "INPUT4", "INPUT5", "INPUT6" and "INPUT7" (PC) modes can store volume adjustment values separately.

### Menu language settings

You can also select a language from setup menu. Select from among 4 languages: English, Simplified Chinese, Traditional Chinese and Arabic.

- 1 Press **MENU** and the MENU screen displays.
- 2 Press  $\blacktriangleleft/\blacktriangleright$  to select "Setup".
- 3 Press  $\blacktriangle/\blacktriangledown$  to select "Language", and then press **ENTER**.
- 4 Press  $\blacktriangle/\blacktriangledown$  to select the desired language listed on the screen, and then press **ENTER**.

## Setting channels to your preference

You can run the auto search procedure again at any time by accessing the Setup menu and Programme Setup. Channels can be tuned automatically or manually.

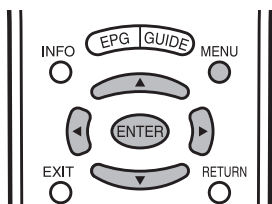

### Digital settings

You can reconfigure DTV services settings automatically or manually.

- 1 Press **MENU** and the MENU screen displays.
- 2 Press **◀/▶** to select "Setup"
- 3 Press **▲/▼** to select "Programme Setup", and then press **ENTER**.
- 4 Press **▲/▼** to select "Digital Setting", and then press **ENTER**.
- 5 Press **▲/▼** to select the desired menu item, and then press **ENTER**.
- 6 Press **◀/▶** to select "Yes", and then press **ENTER**.

### Additional Search

Use this menu to add new services automatically after auto installation has been completed.

### Manual Search

Add new services within a specified frequency band.

- Enter the frequency using **0 - 9** numeric buttons.

### Manual Adjust

Configure various settings for each service using the Colour (**R**, **G**, **Y**, **B**) buttons.

Service No.	Service Name	Lock	CH Skip	EPG Skip	Old LCN
DTV 993	SIT 3				
DTV 994	SIT 2	✓		✓	
DTV 995	SIT 1		✓		
DTV 996	Monosco 576-2				
DTV 997	Monosco 576-1				
DTV 998	Color Bar 576i				
DTV 999	HD Monosco				

**R** : Lock    **G** : CH Skip    **Y** : EPG Skip    **B** : Sort

- 1 Press **▲/▼** to select the desired service.
- 2 Press the colour button on the remote control corresponding with the item you want to reconfigure.
  - The **✓** mark indicates the operation is set to on. Each time the colour button is pressed, you can switch the corresponding operation on/off.

### Buttons for Manual Adjust operation

Menu items	Remote control buttons	Description
<b>Lock</b>	<b>R</b>	When the service is locked, you must enter your password whenever you tune to the service.
<b>CH Skip</b>	<b>G</b>	Services with a <b>✓</b> mark are passed over when pressing <b>P ▲/▼</b> in the TV/remote control unit.
<b>EPG Skip</b>	<b>Y</b>	Services with a <b>✓</b> mark are passed over in the Electronic Programme Guide (EPG).
<b>Sort*</b>	<b>B</b>	The item position of services can be sorted.

### \* The item position of services can be sorted.

- ① Press **▲/▼** to select the service whose item position you want to move, and then press **B**.
 

DTV 994	SIT 2	✓	✓
DTV 995	SIT 1		✓
- ② Press **▲/▼** to move it to the desired position, and then press **ENTER**.
 

DTV 994	SIT 1		✓
DTV 995	SIT 2	✓	✓
- ③ Repeat steps ① and ② until all desired service items are sorted.

## Watching TV

### Manual setting for each channel (Analogue)

You can set some channel items manually. They are Search, Fine (TV frequency), Colour sys., Sound sys., Label (Network name), Skip and Lock (Child Lock).

- 1 Press **MENU** and the MENU screen displays.
- 2 Press **◀/▶** to select "Setup".
- 3 Press **▲/▼** to select "Programme Setup", and then press **ENTER**. If you have already set the password, enter it here.
  - See page 28 for setting a password.
- 4 Press **▲/▼** to select "Manual Adjust", and then press **ENTER**.
- 5 Press **◀/▶** to select "Yes", and then press **ENTER**.

#### Programme Setup "Manual Adjust" menu

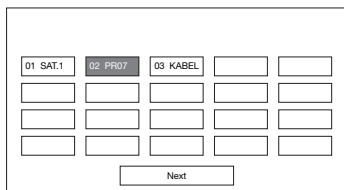

You can select one of the following settings.

- ① **Search** (See page 23.)
- ② **Fine** (See page 23.)
- ③ **Colour sys.** (See page 23.)
- ④ **Sound sys.** (See page 24.)
- ⑤ **Label** (See page 24.)
- ⑥ **Skip** (See page 24.)
- ⑦ **Lock** (See page 24)

#### Search tuning

- 1 Press **▲/▼/◀/▶** to select the channel you want to edit, and then press **ENTER**.
  - The selected channel information displays.
- 2 Press **▲/▼** to select "Search", and then press **ENTER**.

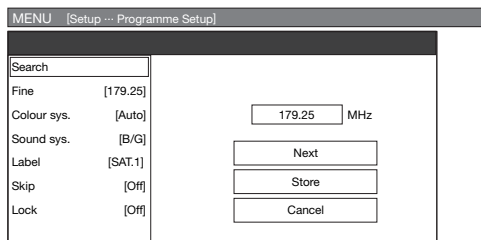

- 3 Press **▲/▼** to select item and press **ENTER**.
  - **Next:** Search the next channel.
  - **Store:** Memorise the current display channel.
  - **Cancel:** Return to the previous screen. (The search result will not be stored.)

#### Fine tuning

- 1 Press **▲/▼/◀/▶** to select the channel you want to edit, and then press **ENTER**.
  - The selected channel information displays.
- 2 Press **▲/▼** to select "Fine", and then press **ENTER**.
- 3 Press **◀/▶** to adjust the frequency, and then press **ENTER**.
  - Adjust while checking the background picture as a reference.

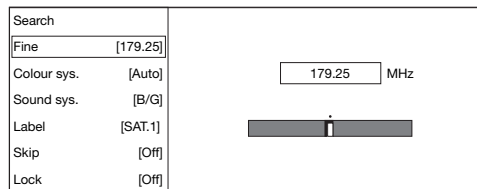

- Instead of the method above, you can also set by directly entering the frequency number of the channel with **0 - 9**.
- When setting a frequency on the "Fine" screen, the last figure of the frequency needs to be "0" or "5".

#### EXAMPLE

- 179.25 MHz: Press **1** → **7** → **9** → **2** → **5**.
- 49.25 MHz: Press **4** → **9** → **2** → **5** → **ENTER**.

#### Colour system

- 1 Press **▲/▼/◀/▶** to select the channel you want to edit, and then press **ENTER**.
  - The selected channel information displays.
- 2 Press **▲/▼** to select "Colour sys.", and then press **ENTER**.
  - Receivable colour systems are listed.

#### Colour system menu

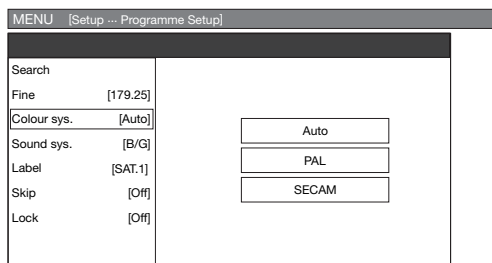

- 3 Press **▲/▼** to select the optimum colour system, and then press **ENTER**.

Manual setting for each channel (continued)

Sound system (Broadcasting system)

- 1 Press **▲/▼/◀/▶** to select the channel you want to edit, and then press **ENTER**.
  - The selected channel information displays.
- 2 Press **▲/▼** to select "Sound sys.", and then press **ENTER**.
  - Receivable sound systems (Broadcasting systems) are listed.

Sound system menu

Search		
Fine	[179.25]	
Colour sys.	[Auto]	B/G
Sound sys.	[B/G]	D/K
Label	[SAT.1]	I
Skip	[Off]	
Lock	[Off]	

- 3 Press **▲/▼** to select the optimum sound system, and then press **ENTER**.

NOTE

- Check the sound system if the sound output were not correct.

Labelling channels

When a TV channel sends its Network Name, the auto installation detects the information and assigns a name to it. However, you can change individual channel names.

- 1 Press **▲/▼/◀/▶** to select the channel you want to edit, and then press **ENTER**.
  - The selected channel information displays.
- 2 Press **▲/▼** to select "Label", and then press **ENTER**.
  - The alphabet and numbers are listed.

Labelling menu

Search		
Fine	[179.25]	
Colour sys.	[Auto]	A B C D E F G H I J CLEAR
Sound sys.	[B/G]	K L M N O P Q R S T BACK
Label	[SAT.1]	U V W X Y Z + - . _
Skip	[Off]	0 1 2 3 4 5 6 7 8 9 END
Lock	[Off]	

- 3 Press **▲/▼/◀/▶** to select each character of the new name for the channel, and then press **ENTER**.

- 4 Repeat until the name is fully spelt out.
  - The name can be 5 characters or less.
  - When you want to set a channel name of less than 5 characters, select "END".

Skipping channels

Channels with "Skip" set to "On" are passed over when using **CH▲/▼** even if selected while watching the image from the TV.

- 1 Press **▲/▼/◀/▶** to select the channel you want to edit, and then press **ENTER**.
  - The selected channel information will be displayed.
- 2 Press **▲/▼** to select "Skip", and then press **ENTER**.
  - Skip menu displays.

Skip menu

MENU [Setup ... Programme Setup]	
Search	
Fine	[179.25]
Colour sys.	[Auto] Off
Sound sys.	[B/G]
Label	[SAT.1] On
Skip	[Off]
Lock	[Off]

- 3 Press **▲/▼** to set "Skip" to "On", and then press **ENTER**.

Setting the child lock

You can block the viewing of any channel.

- 1 Press **▲/▼/◀/▶** to select the channel you want to edit, and then press **ENTER**.
  - The selected channel information will be displayed.
- 2 Press **▲/▼** to select "Lock", and then press **ENTER**.
  - Child lock menu will be displayed

Lock menu

Search	
Fine	[179.25]
Colour sys.	[Auto] Off
Sound sys.	[B/G]
Label	[SAT.1] On
Skip	[Off]
Lock	[Off]

- 3 Press **▲/▼** to set "Lock" to "On", and then press **ENTER**.

NOTE

- See page 28 for setting a password.
- If "Lock" is set to "On" for a channel, "Child lock has been activated" is displayed when you select the channel, and the image and sound of the channel is blocked.
- When pressing **RETURN** while "Child lock has been activated" is displayed, password input menu will be displayed. Inputting the correct password lifts the child lock temporarily until the power is turned off.

## Watching TV

### Sorting programmes

Channel positions can be sorted freely.

- 1 Press **MENU** and the MENU screen displays.
- 2 Press **◀/▶** to select "Setup".
- 3 Press **▲/▼** to select "Programme Setup", and then press **ENTER**.  
If you have already set the password, enter it here.
  - See page 28 for setting a password.
- 4 Press **▲/▼** to select "Analogue Setting", and then press **ENTER**.
- 5 Press **▲/▼** to select "Sort", and then press **ENTER**.
- 6 Press **◀/▶** to select "Yes", and then press **ENTER**.
- 7 Press **▲/▼/◀/▶** to select the channel you want to move, and then press **ENTER**.
- 8 Move it to the desired position by pressing **▲/▼/◀/▶**, and then press **ENTER**.
- 9 Repeat the steps 6 and 7 until all desired channels are sorted.

#### Sort menus

01 SAT.1 ↔				
01 SAT.1	02 KABEL	03	04	05
06				
Next				



01 SAT.1 ↔ 02 KABEL				
01 SAT.1	02 KABEL			
Next				



01 KABEL ↔				
01 KABEL	02 SAT.1			
Next				

### Erasing programmes

The individual programme can be erased.

- 1 Press **MENU** and the MENU screen displays.
- 2 Press **◀/▶** to select "Setup".
- 3 Press **▲/▼** to select "Programme Setup", and then press **ENTER**.  
If you have already set the password, enter it here.
  - See page 28 for setting a password.
- 4 Press **▲/▼** to select "Analogue Setting", and then press **ENTER**.
- 5 Press **▲/▼** to select "Erase Programme", and then press **ENTER**.
- 6 Press **◀/▶** to select "Yes", and then press **ENTER**.
- 7 Press **▲/▼/◀/▶** to select the channel you want to erase, and then press **ENTER**.
  - A message screen pops up.
- 8 Press **◀/▶** to select "Yes", and then press **ENTER** to erase the selected programme. All the subsequent programmes move up.
- 9 Repeat the steps 6 and 7 until all desired channels are erased.

#### Erase programme menus

01 SAT.1				
01 SAT.1	02 Pro7	03 KABEL	04	05
06	07	08	09	10
11	12	13	14	15
16	17	18	19	20
Next				



02 Pro7				
01 SAT.1	02 Pro7	03 KABEL	04	05
06	07	08	09	10
11	12	13	14	15
16	17	18	19	20
Next				



02 KABEL				
01 SAT.1	02 KABEL	03	04	05
06	07	08	09	10
11	12	13	14	15
16	17	18	19	20
Next				

## Useful viewing functions

### Returning to the previously selected channel (Flashback)

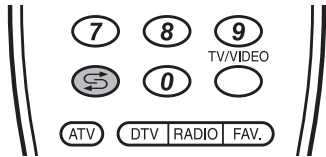

Press **5** to switch the currently tuned channel to the previously tuned channel.  
 Press **5** again to switch back to the currently tuned channel.

Press **5** to toggle between the currently selected input source and the previously selected one.

Press **5** to return to the previous page in TELETEXT mode.

### Freezing the image

Allows you to capture and freeze one frame from a moving image that you are watching.

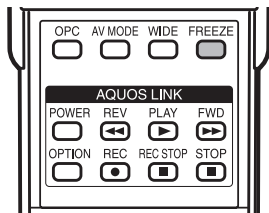

- 1** Press **FREEZE**.
  - Captures one frame from a moving image.
- 2** Press **FREEZE** again to cancel the function.

**NOTE**

- The still image automatically goes out after 30 minutes.

### Muting the audio temporarily

#### Using Mute (Mute icon) on the remote control unit

Mute icon mutes the current sound output.

- 1** Press Mute icon.
  - The sound is silenced.
  - "Mute" is displayed while the mute function is on.

- 2** Press Mute icon again within 30 minutes to cancel the mute.
  - Before 30 minutes, the volume level returns to the previous setting.

**NOTE**

- **Mute will be cancelled after 30 minutes. However, the TV will not suddenly output loud sound as the volume level will be set to 0 automatically. Increase the volume level by pressing VOL +.**

### Outputting only audio

When listening to music from a music programme, you can set the display off and enjoy audio only.

- 1** Press **MENU** and the MENU screen displays.
- 2** Press **Left/Right** to select "Option".
- 3** Press **Up/Down** to select "Audio Only", and then press **ENTER**.
- 4** Press **Left/Right** to select "On", and then press **ENTER**.

Selected item	Description
<b>On</b>	Audio is output without screen image.
<b>Off</b>	Both screen images and audio are output.

**NOTE**

- When you make operations that change the picture on the TV such as by changing the input source, the Audio Only function is set to "Off".



## Watching TV

### Switching the analogue audio format

You can switch between multiple audio modes when watching a multiple audio or stereo broadcast programme.

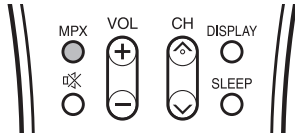

#### In the NICAM TV broadcasts

##### When receiving a stereo signal

Each time you press **MPX**, the mode switches between NICAM STEREO and MONO.

##### Stereo mode

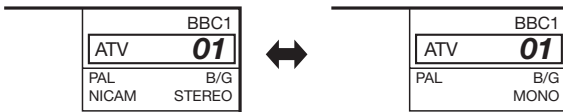

##### When receiving a bilingual signal

Each time you press **MPX**, the mode switches among NICAM CH A, NICAM CH B, NICAM CH AB and MONO.

##### Bilingual mode

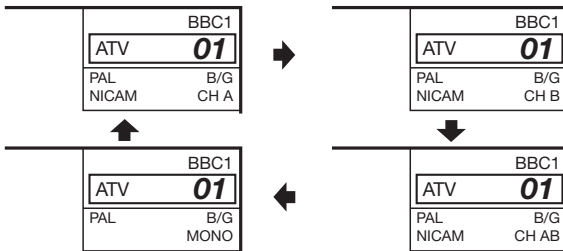

##### When receiving a monaural signal

Each time you press **MPX**, the mode switches between NICAM MONO and MONO.

##### Monaural mode

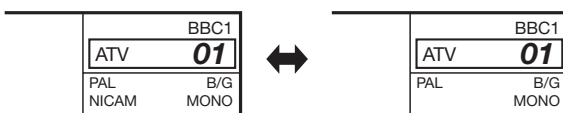

#### In the TV mode of A2 TV broadcasts

##### When receiving a stereo signal

Each time you press **MPX**, the mode switches between STEREO and MONO.

##### Stereo mode

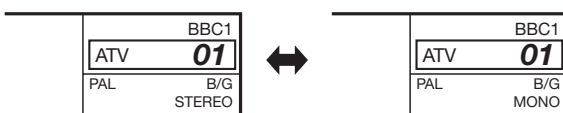

#### When receiving a bilingual signal

Each time you press **MPX**, the mode switches among CH A, CH B and CH AB.

##### Bilingual mode

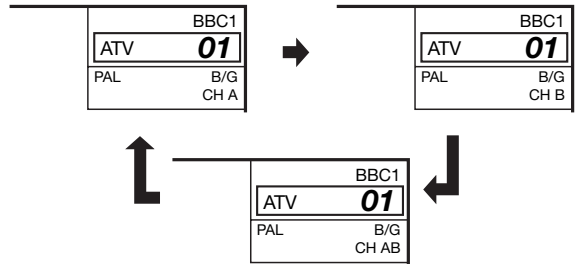

#### When receiving a monaural signal

When you press **MPX**, "MONO" displays.

##### Monaural mode

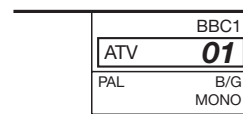

#### NOTE

- "BBC1", "99" and "PAL" are tentative network name, channel and colour system.

### Switching the digital audio format

- If multi sound modes are received, each time you press **MPX** the mode switches as follows.

#### (Example)

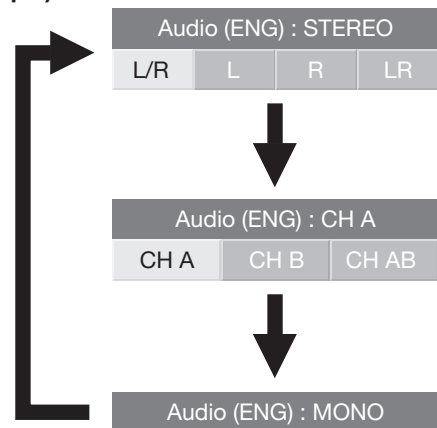

- Press **◀/▶** to select L or R sound when the STEREO or DUAL MONO screen is displayed.



#### NOTE

- The sound mode screen disappears in 6 seconds.
- Selectable items vary depending on the received broadcasts.

## Watching TV

### Password setting for the child lock (for TV input mode)

Allows you to use a password to protect certain settings from being accidentally changed.

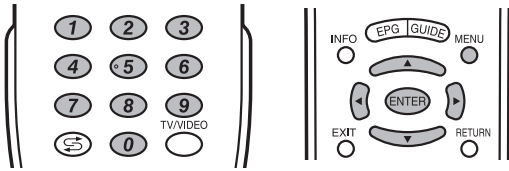

#### Setting a password

Register a 4-digit password number to use the Child Lock function.

**1** Press **MENU** and the MENU screen displays.

**2** Press **◀/▶** to select “Setup”.

**3** Press **▲/▼** to select “Child Lock”, and then press **ENTER**.

**4** If you have already set the password, enter it here.



**5** Press **▲/▼** to select “Change password”, and then press **ENTER**.

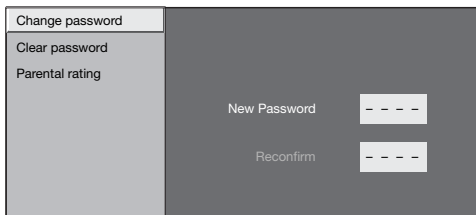

**6** Enter the 4-digit number as a password using **0 – 9**.

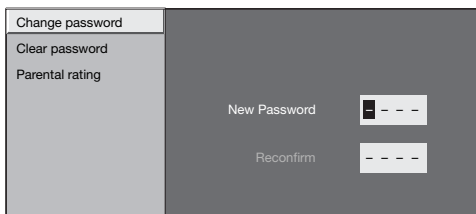

**7** Enter the same 4-digit number as in step 6 to confirm.

- “The new password was registered” displays.

#### NOTE

- To view a locked channel (Lock setting in Programme Setup “Manual Adjust” is set to “On”), you must enter a password. (See page 24.) When you select a locked channel, a password prompt message pops up. Press **RETURN** to display the password input window.

#### Clearing the password

Allows you to clear your password.

**1** Repeat steps 1 to 3 in **Setting a password**.

**2** Enter the password.



**3** Press **▲/▼** to select “Clear password”, and then press **ENTER**.

**4** Press **◀/▶** to select “Yes”, and then press **ENTER**.

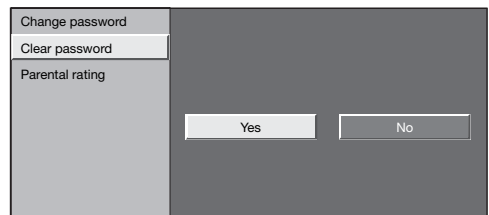

#### NOTE

- **As a precautionary measure, make a note of your password and keep it in a familiar place. If you lose or forget your password, initialise the TV to return all settings except for the TV channel settings to factory preset values. (See page 73.)**
- This function is only available for TV input mode.
- To relock a channel which has been temporarily unlocked by inputting the correct password, turn power off and then on again.

## Watching TV

### Parental Rate

This function allows TV channels to be restricted. It prevents children from watching violent or sexual scenes that may be considered inappropriate.

**1** Repeat steps 1 to 3 in **Setting a password**.

**2** Press ▲/▼ to select “Parental rating”, and then press **ENTER**.

**3** Press ▲/▼ to select your desired rating, and then press **ENTER**.

Selected item	Description
<b>General and above (G)</b>	Content is not offensive to most viewers.
<b>Parental Guidance and above (PG)</b>	Content is such that parents may not want their children to view the programme.
<b>Mature and above (M)</b>	Mature Audience only. This programme is specifically designed to be viewed by adults and therefore may be unsuitable for children under 15.
<b>Mature Adult and above (MA)</b>	Mature Adult only. This programme is specifically designed to be viewed by adults and therefore may be unsuitable for children under 15.
<b>Adult Violence and above (AV)</b>	Not for children under age 15. Strong elements of sex and/or violence.
<b>Restricted and above (R)</b>	Not for children under age 18. Strong elements of sex and/or violence.
<b>No Block (-)</b>	Cancel the blocking.

### Programme Title Display

This function allows you to display programme information on the screen including the title and airtime by tuning a channel.

**1** Press **MENU** and the MENU screen displays.

**2** Press ◀/▶ to select “Option”.

**3** Press ▲/▼ to select “Programme Title Display”, and then press **ENTER**.

**4** Press ◀/▶ to select “Yes”, and then press **ENTER**.

#### NOTE

- The Programme Title Display function is only available for the DTV mode.



**Picture size settings**

**Selecting the Wide Screen Signalling (WSS) picture size automatically**

WSS allows a television to switch automatically among the different screen formats.

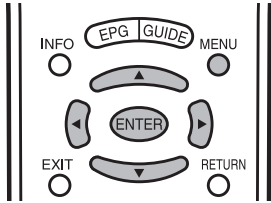

- 1** Press **MENU** and the MENU screen displays.
- 2** Press **◀/▶** to select "Setup".
- 3** Press **▲/▼** to select "WSS", and then press **ENTER**.
- 4** Press **◀/▶** to select "On" or "Off", and then press **ENTER**.

**NOTE**

- Try to set WIDE mode if an image does not switch to the correct screen format. When the broadcast signal contains no WSS information, the function will not work even if enabled.

**Selecting the Wide Screen Signalling (WSS) picture size manually**

The WSS signal has 4:3 auto-switching that allows you to select between Panorama and Normal.

- 1** Press **MENU** and the MENU screen displays.
- 2** Press **◀/▶** to select "Setup".
- 3** Press **▲/▼** to select "4:3 Mode", and then press **ENTER**.
- 4** Press **◀/▶** to select "Panorama" or "Normal", and then press **ENTER**.

**WSS signal 4:3 screen**

**4:3 mode "Panorama"**



**4:3 mode "Normal"**



Selected item	Description
<b>Panorama</b>	Wide image without side bars
<b>Normal</b>	Normal range keeping 4:3 or 16:9 aspect ratio

Selecting the picture size manually

Manual Selection

You can select different picture sizes that account for the kind of each picture.

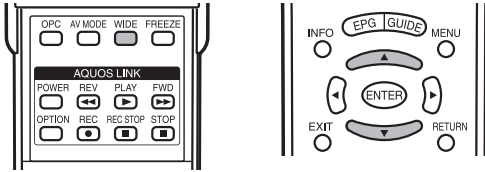

1

Press **WIDE**.

- The WIDE MODE menu displays.
- The menu lists the wide mode options selectable for the type of video signal currently received.

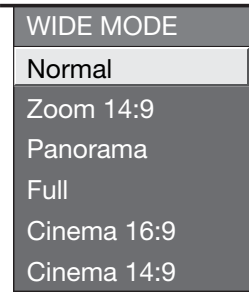

2

Press **WIDE** or **▲/▼** while the WIDE MODE menu displays on the screen.

- As you toggle down the options, each mode is immediately reflected on the TV.

Auto Selection

If you set "WSS" and "4:3 Mode" in the Setup menu on page 31, the optimum WIDE mode is automatically chosen for every broadcast containing the WSS information.

"WSS" menu

To enable Auto Selection, set "WSS" in the Setup menu to "On". (See page 31.)

"4:3 Mode" menu

To set the type of the wide screen, select "Panorama" or "Normal" in the 4:3 Mode menu. (See page 31.)

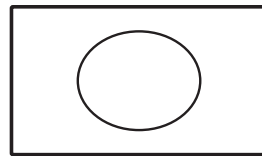

4:3 Mode set to "Panorama"

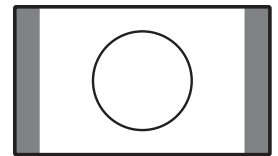

4:3 Mode set to "Normal"

NOTE

- If the broadcast signal contains no WSS information, Auto Selection will not function even when the WSS option is enabled.

Selected item	Description
<b>Normal</b>	For 4:3 "standard" pictures. A side bar appears on each side.
<b>Zoom 14:9</b>	For 14:9 letterbox pictures. A thin side bar appears on each side, and you may also see bars on the top and bottom with some programmes.
<b>Panorama</b>	In this mode the picture is progressively stretched toward each side of the screen.
<b>Full</b>	For 16:9 squeeze pictures.
<b>Cinema 16:9</b>	For 16:9 letterbox pictures. Bars may appear on the top and bottom with some programmes.
<b>Cinema 14:9</b>	For 14:9 letterbox pictures. Bars may appear on the top and bottom with some programmes.
<b>Dot by Dot</b>	Displays an image with the same number of pixels on the screen (only when receiving a 1080i/1080p signal via component or HDMI terminals).
<b>Underscan</b>	Display with an Underscan image only when receiving a 720p signal. Display with the High-Definition image adjusted optimally. Noise may appear on the edge of the screen with some programmes.

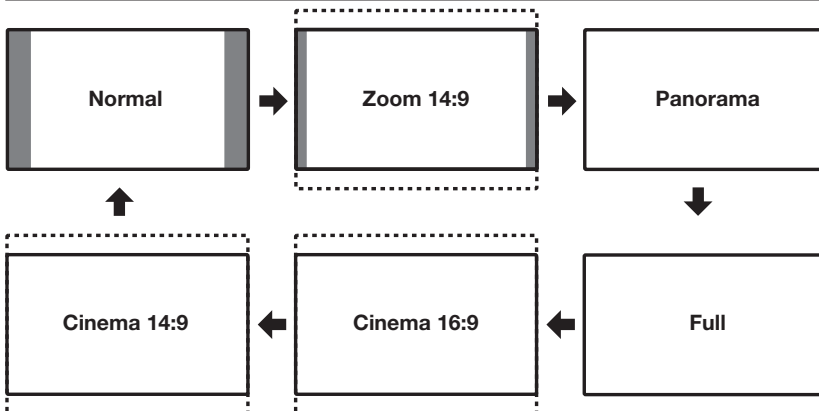

NOTE

- Some picture sizes may not be displayable depending on the input signal.

## Selecting a preset AV MODE

The AV MODE function enables you to select appropriate settings for audio and video to account for the system environment which can vary due to factors like room brightness, type of programme watched or the type of image input from external equipment.

### Using AV MODE on the remote control unit

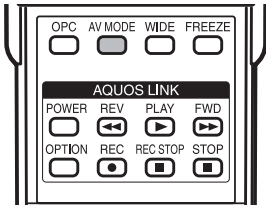

- 1 Press **AV MODE**.
  - Present AV MODE displays.
- 2 Press **AV MODE** again before the mode displayed on the screen disappears.
  - The mode changes as shown below.

#### When the input source is TV, INPUT1, 2 or 3 terminal (Example)

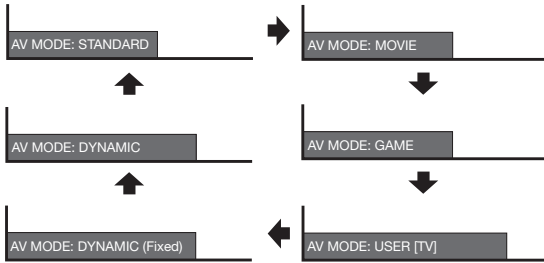

#### When the input source is INPUT4, 5, 6 or 7 terminal (Example)

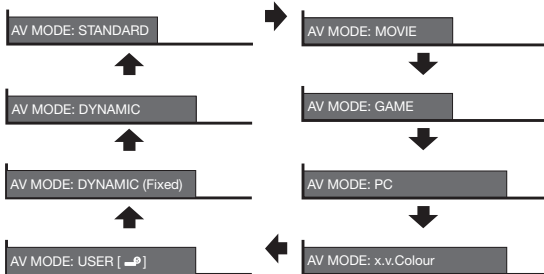

Selected item	Description
<b>STANDARD</b>	For a highly defined image in a normally bright room
<b>MOVIE</b>	For a movie
<b>GAME</b>	Lowers image brightness for easier viewing.
<b>PC*</b>	For PC. (Available only when inputting an HDMI or RGB signal.)
<b>x.v.Colour**</b>	Produce realistic colour on the TV screen unlike any other signal.
<b>USER</b>	Allows the user to customise settings as desired. You can set the mode for each input source.
<b>DYNAMIC (Fixed)</b>	Changes the image and sound settings to the factory preset values. No adjustments are allowed.
<b>DYNAMIC</b>	For a clear-cut image emphasising high contrast for sports viewing

#### NOTE

- The item marked with \* is available only when selecting "INPUT4", "INPUT5", "INPUT6" or "INPUT7" from the INPUT SOURCE menu.
- The item marked with \*\* is available only when accepting an x.v.Colour signal through an HDMI terminal.
- You can select a different AV MODE item for each input mode. (For example, select "STANDARD" for TV input and "DYNAMIC" for VIDEO input.)

## Manual picture settings

### Picture adjustment

You can adjust the picture to your preference. Follow the steps to adjust the picture.

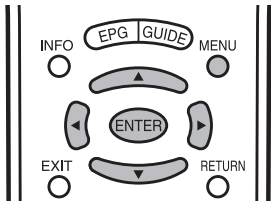

**1** Press **MENU** and the MENU screen displays.

**2** Press **◀/▶** to select "Picture".

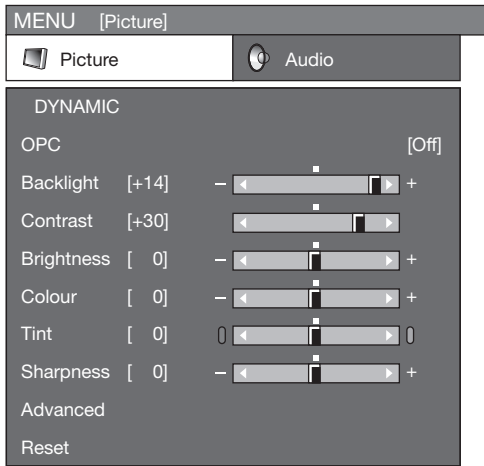

**3** Press **▲/▼** to select the desired menu item. Press **ENTER** to proceed if necessary.

**4** Press **▲/▼** or **◀/▶** to select the desired item or adjust the item to the desired level. Press **ENTER** if necessary.

#### NOTE

- For resetting all adjustment items to factory preset values, press **▲/▼** to select "Reset", press **ENTER**, press **◀/▶** to select "Yes", and then press **ENTER**.
- Select "Advanced" and then press **ENTER** to set "Colour Temp.", "Fine Motion Advanced", "Film Mode", "Active Contrast", "3D-Y/C", "Monochrome" or "Range of OPC". See page 35.
- When adjusting the backlight, the OPC will be turned off automatically.

Selected item	◀ button	▶ button
<b>OPC</b>	Sets whether or not the screen brightness is automatically adjusted according to the lighting condition in the room. (OPC setting: See this page.)	
<b>Backlight</b>	The screen dims	The screen brightens
<b>Contrast</b>	For less contrast	For more contrast
<b>Brightness</b>	For less brightness	For more brightness
<b>Colour</b>	For less colour intensity	For more colour intensity
<b>Tint</b>	Skin tones become purplish	Skin tones become greenish
<b>Sharpness</b>	For less sharpness	For more sharpness
<b>Advanced</b>	For finer picture adjustments. (See page 35).	
<b>Reset</b>	Resets all picture adjustment items to the factory preset values.	

### OPC (Optical Picture Control) setting

You can set the TV to automatically adjust the screen to suitable backlight brightness according to the lighting conditions.

#### Using OPC on the remote control unit

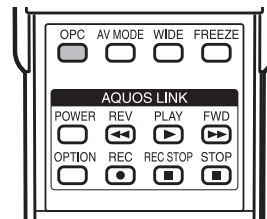

Press **OPC** to switch the OPC function on and off.

#### Using OPC on the menu screen

Selected item	Description
<b>Off</b>	The brightness is fixed at the value set in "Backlight" (See this page).
<b>On</b>	Automatically adjusts
<b>On (Display)</b>	Displays the OPC effect on the screen while adjusting the brightness of the screen.

#### OPC indicator

Light off	"Off" is selected in the OPC setting.
Lighted (Green)	"On" or "On (Display)" is selected in the OPC setting.

#### NOTE

- Make sure no object obstructs the OPC sensor, which could affect its ability to sense surrounding light.



## Watching TV

### Advanced picture settings

The advanced settings enable you to set the picture adjustment in more detail. There are seven options you can choose from.

**1** Press **MENU** and the MENU screen displays.

**2** Press **◀/▶** to select "Picture".

**3** Press **▲/▼** to select "Advanced", and then press **ENTER**.

**4** Press **▲/▼** to select the desired menu, and then press **ENTER**.

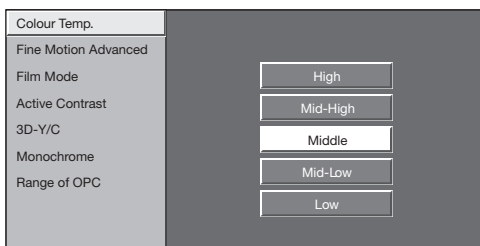

**5** Press **▲/▼** or **◀/▶** to select the desired level, and then press **ENTER**.

### ■ Colour Temp. (Colour temperature)

Adjusts the colour temperature to give the best white image.

Selected item	Description
<b>High</b>	White with bluish tone ↑↓ White with reddish tone
<b>Mid-High</b>	
<b>Middle</b>	
<b>Mid-Low</b>	
<b>Low</b>	

### ■ Fine Motion Advanced

The "Fine Motion Advanced" provides a picture with 100/120 frames per second (double the conventional 50/60 frames per second) by supplementing the picture from the preceding and following scenes using Sharp's unique algorithm. Users are able to view fast moving images more clearly.

Selected item	Description
<b>On</b>	For obtaining a clear image
<b>Off</b>	No adjustment

#### NOTE

- Fine Motion Advanced may cause image noise. If this occurs, turn the function "Off".

### ■ Film Mode

Automatically detects a film-based source (originally encoded at 24/25 frames/second, depending on the vertical frequency), analyzes it then recreates each still film frame for high-definition picture quality.

Selected item	Description
<b>Advanced</b>	Changes the image from frame advance to a smooth moving image.
<b>Standard</b>	Normal adjustment
<b>Off</b>	No detecting

#### NOTE

- Film Mode is not selectable depending on the input signal type.

### ■ Active Contrast

Automatically adjusts the contrast of an image according to the scene if set to "On".

### ■ 3D-Y/C

Provides high quality images with minimal dot crawl and cross colour noise.

Selected item	Description
<b>Standard</b>	Normal adjustment
<b>Fast</b>	Set the optimum image quality for fast-moving images.
<b>Slow</b>	Set the optimum image quality for slow-moving images.
<b>Off</b>	No detecting

#### NOTE

- 3D-Y/C is not selectable depending on the input signal type.
- 3D-Y/C may not operate depending on the input signal type or noisy input signal.

### ■ Monochrome

Images are displayed in monochrome if set to "On".

### ■ Range of OPC

The brightness level range of the OPC sensor's automatic adjustments can be set according to your preferences. The adjustment range of the OPC sensor can be set to a maximum of +16 and a minimum of -16.

Selected item	Description
<b>Max.</b>	-16 through +16
<b>Min.</b>	-16 through +16

#### NOTE

- This function is available only when the OPC setting is set to "On" or "On (Display)".
- The maximum setting cannot be set to a smaller number than the minimum setting.
- The minimum setting cannot be set to a bigger number than the maximum setting.
- The maximum and minimum settings cannot be set to the same number.
- Depending on the brightness of the surrounding light, the OPC sensor might not operate if the adjustment range is small.

### Other picture settings

#### DNR (Digital Noise Reduction)

Reduces noise on the screen and provides a clearer video image.

**1** Press **MENU** and the MENU screen displays.

**2** Press ◀/▶ to select "Option".

**3** Press ▲/▼ to select "DNR", and then press **ENTER**.

**4** Press ▲/▼ to select the desired level, and then press **ENTER**.



#### Adjusting the image position

For adjusting a picture's horizontal and vertical position.

**1** Press **MENU** and the MENU screen displays.

**2** Press ◀/▶ to select "Setup".

**3** Press ▲/▼ to select "Position", and then press **ENTER**.

**4** Press ▲/▼ to select "H-Pos." or "V-Pos.".



Selected item	Description
<b>H-Pos.</b>	Centres the image by moving it to the left or right.
<b>V-Pos.</b>	Centres the image by moving it up or down.

**5** Press ◀/▶ to adjust the item to your desired position.

#### NOTE

- For resetting all adjustment items to the factory preset values, press ▲/▼ to select "Reset", and then press **ENTER**.
- **Adjustments are stored separately according to input source.**
- Images may not be displayed properly depending on the settings and/or signals.

#### Game Play Time

This function displays the elapsed game time so you do not lose track of the time.

To display the elapsed time, select "GAME" under "AV MODE" for the input mode of the terminal connected to the game console before starting the game.

**1** Press **MENU** and the MENU screen displays.

**2** Press ◀/▶ to select "Option".

**3** Press ▲/▼ to select "Game Play Time", and then press **ENTER**.

**4** Press ◀/▶ to select "On", and then press **ENTER**.

Selected item	Description
<b>On</b>	The elapsed time is displayed every 30 minutes when you switch to GAME mode in external input mode.
<b>Off</b>	No adjustment

### Indicating time on the screen

#### ■ Time Display

This function allows you to display the clock time on the lower right screen.

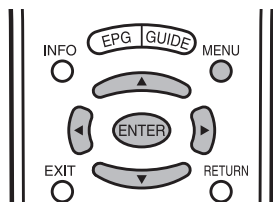

**1** Press **MENU** and the MENU screen displays.

**2** Press **◀/▶** to select “Option”.

**3** Press **▲/▼** to select “Time Display” and then press **ENTER**.

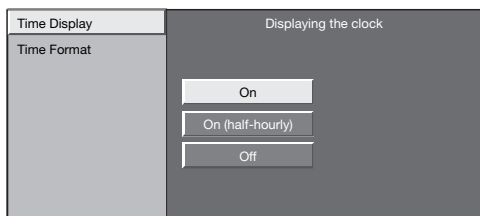

**4** Press **▲/▼** to select “Time Display” and then press **ENTER**.

**5** Press **▲/▼** to select “On” or “On (half-hourly)” and then press **ENTER**.

Selected item	Description
<b>On</b>	Display the clock time.
<b>On (half-hourly)</b>	Display the clock time in 30 minutes increments.
<b>Off</b>	Hide the clock time.

#### ■ Time Format

You can select the time format (either 24HR or AM/PM) for the clock time.

**1** Press **MENU** and the MENU screen displays.

**2** Press **◀/▶** to select “Option”.

**3** Press **▲/▼** to select “Time Display” and then press **ENTER**.

**4** Press **▲/▼** to select “Time Format” and then press **ENTER**.

**5** Press **◀/▶** to select the desired time format, and then press **ENTER**.

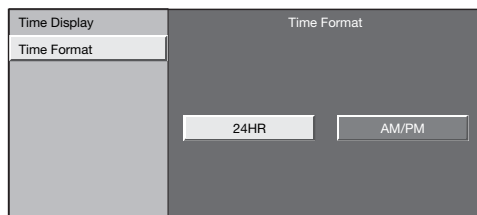

## Audio adjustment

You can adjust the audio of the selected AV mode.

- 1 Press **MENU** and the MENU screen displays.
  - 2 Press **◀/▶** to select "Audio".
- 
- 3 Press **▲/▼** to select the desired menu item. Press **ENTER** to proceed if necessary.
  - 4 Press **▲/▼** or **◀/▶** to select the desired item or adjust the item to the desired level. Press **ENTER** if necessary.

Selected item	◀button	▶button
<b>Treble</b>	For weaker treble	For stronger treble
<b>Bass</b>	For weaker bass	For stronger bass
<b>Balance</b>	Decrease audio from the right speaker	Decrease audio from the left speaker

### NOTE

- For resetting all adjustment items to the factory preset values, press **▲/▼** to select "Reset", press **ENTER**, press **◀/▶** to select "Yes", and then press **ENTER**.

## Surround

You can enjoy SRS TruSurround XT sound, the same as if you were in a movie theatre.

- 1 Repeat steps 1 to 2 in **Audio adjustment**.
- 2 Press **▲/▼** to select "Surround", and then press **ENTER**.
- 3 Press **◀/▶** to select "On".

Selected item	Description
<b>On</b>	SRS TruSurround XT creates a high quality surround sound experience, when watching DVD movies and TV programmes broadcast in surround sound.
<b>Off</b>	Outputs the normal sound.

## Bass Enhancer

This function allows you to enjoy bass-enhanced sound.

- 1 Press **MENU** and the MENU screen displays.
- 2 Press **◀/▶** to select "Audio".
- 3 Press **▲/▼** to select "Bass Enhancer", and then press **ENTER**.
- 4 Press **◀/▶** to select "On" or "Off", and then press **ENTER**.

### NOTE

- The "Audio" menu is grayed out when Output Volume Select is set to "Variable".

## Output Volume Select

Allows you to select what controls the audio output.

- 1 Press **MENU** and the MENU screen displays.
- 2 Press **◀/▶** to select "Option".
- 3 Press **▲/▼** to select "Output Volume Select", and then press **ENTER**.
- 4 Press **◀/▶** to select "Fixed" or "Variable", and then press **ENTER**.

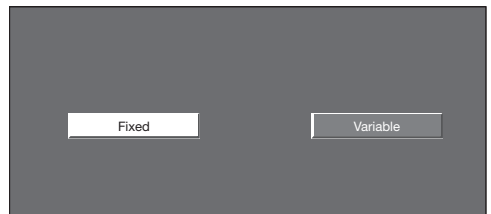

Selected item	Description
<b>Fixed</b>	<ul style="list-style-type: none"> <li>Sound via speakers/headphone is adjusted with <b>VOL +/-</b> on the remote control unit or the TV.</li> <li>Sound via the MONITOR OUTPUT terminal is not adjustable and constantly outputs.</li> </ul>
<b>Variable</b>	<ul style="list-style-type: none"> <li>Sound via the MONITOR OUTPUT terminal is adjusted with <b>VOL +/-</b> on the remote control unit or the TV.</li> <li>Sound via speakers is muted.</li> </ul>

### NOTE

- The "Audio" menu cannot be operated when headphones are plugged in.

## Watching TV

### Automatic Volume Adjustment

Different sound sources sometimes do not have the same volume level, such as a programme and its commercial breaks. The Automatic Volume Control (Auto Volume) reduces this problem by equalizing levels.

- 1 Press **MENU** and the MENU screen displays.
- 2 Press **◀/▶** to select "Option".
- 3 Press **▲/▼** to select "Auto Volume", and then press **ENTER**.
- 4 Press **◀/▶** to select "On", and then press **ENTER**.

### Clear Voice

This function emphasises speech against background noise for greater intelligibility. It is not recommended for music sources.

- 1 Press **MENU** and the MENU screen displays.
- 2 Press **◀/▶** to select "Option".
- 3 Press **▲/▼** to select "Clear Voice", and then press **ENTER**.
- 4 Press **◀/▶** to select "On", and then press **ENTER**.

### Digital Audio Output

This function allows you to select your favourite audio output system.

- 1 Press **MENU** and the MENU screen displays.
- 2 Press **◀/▶** to select "Option", and then press **ENTER**.
- 3 Press **▲/▼** to select "Digital Audio Output", and then press **ENTER**.

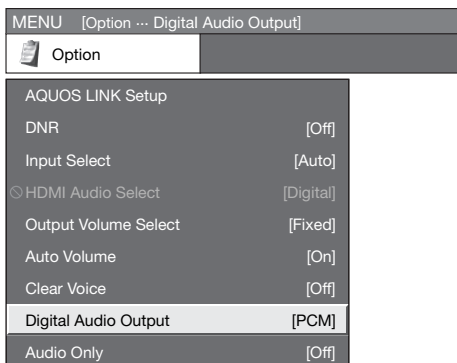

- 4 Press **▲/▼** to select your desired output system, and then press **ENTER**.

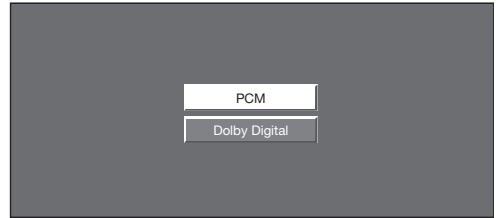

Selected item	Description
PCM	The optical output format is normally in PCM.
Dolby Digital	Dolby Digital audio will be output when there is a Dolby Digital audio signal. The output will be in PCM when there is no Dolby Digital audio signal.

## Watching TV

### Programme Guide

You can check the current schedule of DTV events and view detailed information about current events.

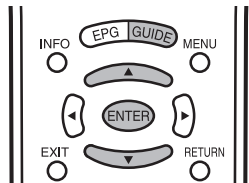

- 1 Press **GUIDE** to display the programme guide list.

- 2 Press **▲/▼** to display your desired programme, and then press **ENTER**.

- When you press **ENTER**, the TV jumps to the channel.

CH LIST	[DTV -TV]	[Mon] 19/6 9:29
002	ABC TV Sydney Global Grover	9:23 - 9:29
▲ 002	ABC TV Sydney Global Grover	
003	SBS	
004	FTV Guide	
009	NINE DIGITAL	
010	TEN DIGITAL	
011	TEN Guide	
012	TEN HD	
020	ABC HDTV Global Grover	
021	ABC 2 ABC Asia Pacific News	
022	ABC TV Global Grover	
030	SBS HD	
▼ 031	SBS 2	

### INFO

While watching DTV you can check the extended programme information on the screen using **INFO** on the remote control.

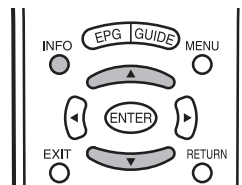

- If there is more information, pressing **▲/▼** allows you to go to the next page or return to the previous page.

### Favourite channel setting

This function allows you to program 4 favourite channels, in 4 different categories. By setting the favourite channels in advance, you can select your favourite channels easily.

#### Using FAVOURITE CH on the remote control unit

- 1 Select the channel you want to register as a favourite channel.
- 2 Press **FAV**.
- 3 Press **▲/▼** to select "Register", and then press **ENTER**.
- 4 Press **▲/▼/◀/▶** to select the position in the category, and then press **ENTER** to register.

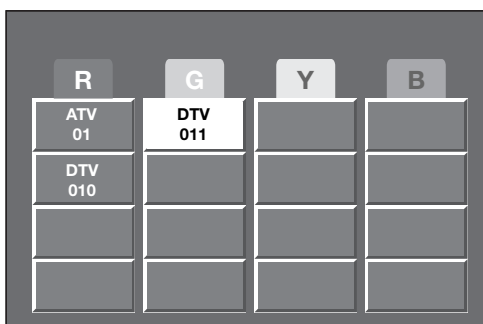

#### Deleting a favourite channel

- 1 Press **FAV** and the favourite channel screen displays.
- 2 Press **▲/▼** to select "1 Data Clear", and then press **ENTER**.
  - To delete all the favourite channels, select "All Data Clear", and then skip to step 4.
- 3 Press **▲/▼/◀/▶** to select the position in the category, and then press **ENTER** to register.

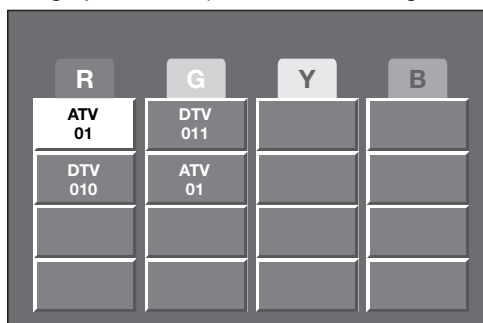

- 4 Press **◀/▶** to select "Yes", and then press **ENTER**.

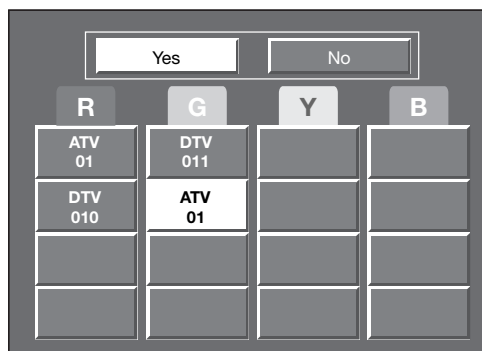

### ATV (Analogue)/DTV/RADIO buttons

Use the following buttons on the remote control to operate the menu.

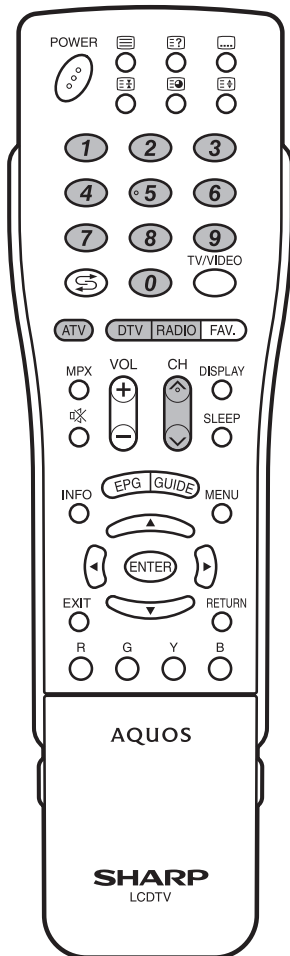

**ATV:** Press to switch to analogue mode. After switching from DTV, radio or external input mode to analogue mode, the TV jumps to the most recently viewed analogue channel.

**DTV:** Press to switch to DTV mode. After switching from analogue, radio or external input mode to DTV mode, the TV jumps to the most recently viewed DTV channel.

**RADIO:** Press to switch to radio mode. After switching from DTV to radio mode, the TV jumps to the most recently tuned radio channel.

### When you watch the TV for the first time

When the TV powers on for the first time after purchase, perform the auto installation.

#### ATV (Analogue TV)

You can run the auto installation to set channels automatically.

- 1 To watch the analogue TV, select "Auto Installation" from Setup menu. (See page 20.)
- 2 After setting the channels, you can select a channel using **CH**  $\wedge/\vee$  or **0-9** on the remote control unit. (See page 21.)

#### DTV (Digital TV)

When the TV accesses to DTV mode for the first time, you need to run the auto search. To scan all available services in your area, follow the procedures below.

- 1 To watch DTV broadcasts, select "Digital Search" from auto installation menu. (See page 11.)
- 2 After setting the channels, you can select a channel using **CH**  $\wedge/\vee$  or **0-9** on the remote control unit. (See page 21.)



## Watching TV

### EPG

#### What is an EPG?

An “EPG (Electronic Programme Guide)” is a programme schedule, which is displayed on the TV screen. The EPG is broadcasted together with DTV. The TV screen shows the EPG when the viewer presses **EPG** on the remote control, provided that the TV is receiving the digital broadcasting signal. The EPG enables you to search for a programme, do timer recording or view the programme schedule in detail.

#### EPG display settings

EPG (Electronic Programme Guide) is a programme list that is displayed on the screen. With the EPG, you can check the schedule of DTV/RADIO/DATA, view detailed information about them, tune to an event currently on-air and set a timer for future events.

**1** Press **MENU** and the MENU screen displays.

**2** Press **◀/▶** to select “Digital Setup”.

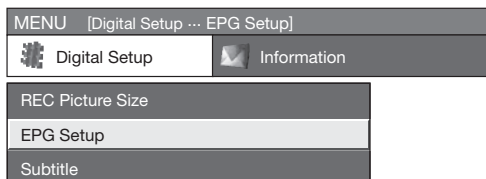

**3** Press **▲/▼** to select “EPG Setup”, and then press **ENTER**.

**4** Press **▲/▼** or **◀/▶** to select the desired item or adjust the item to the desired level. Press **ENTER** if necessary.

#### EPG Setup (setting for receiving EPG data)

EPG Setup must be selected to “YES” to enable automatic capturing of data for all available channels while the TV set is in standby mode. If EPG Setup is set to “NO”, only EPG data for the current channel will be updated.

Selecting EPG Setup to “YES” will result in higher power consumption\*.

Selecting EPG Setup to “NO” will save power consumption.

#### NOTE

\* Approximately 45W for 15-30 minutes (depending on number of channels tuned) after power off from remote control.

- EPG data will not update if the TV is turned off from the mains power switch.

#### Display Range Setup

The Display range setup allows you to select three types of time spans for display on the screen.

Selected item	Description
<b>Mode1 (Wide Angle)</b>	Display six hours of programme information.
<b>Mode2 (Zoom)</b>	Display three hours of programme information.
<b>Mode3 (Vertical Angle)</b>	Change to the EPG display format with a vertical time span.

#### Genre Icon Setup

You can grey out or place a mark on desired genres and smoothly search for programmes you frequently watch.

#### Genre Icon List

Icon	Genre	Icon	Genre
	Movie		Arts/Culture
	News		Current Affairs
	Entertainment		Education/Information
	Sport		Information
	Children's		Comedy
	Music		Drama

#### NOTE

- You can easily distinguish the Genre Icons by darkening or lightening the icon's shade.

#### Time Zone

This function enables you to select your local time zone.

**1** Press **MENU** and the MENU screen displays.

**2** Press **◀/▶** to select “Digital Setup”.

**3** Press **▲/▼** to select “Time Zone”, and then press **ENTER**.

**4** Press **▲/▼** to select the desired time zone and then press **ENTER**.

- This function lets you select the right time zone in case the time displayed in the EPG does not match the local time of your area.

## Watching TV

### Selecting a programme using EPG

#### Basic Operation

#### Display the EPG screen

Press **EPG**.

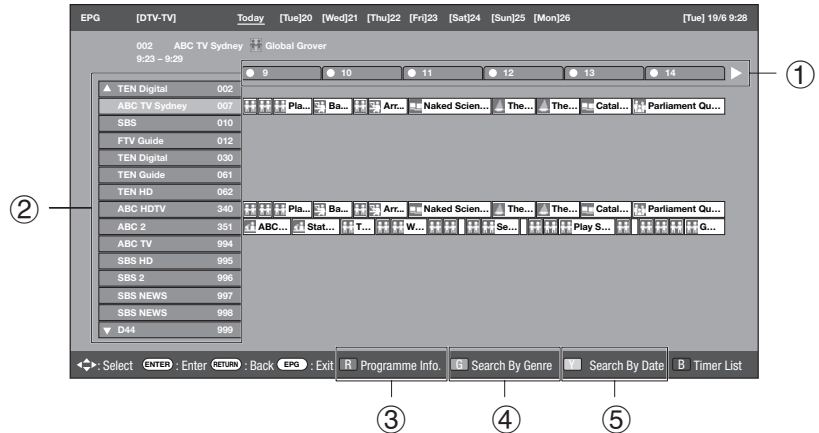
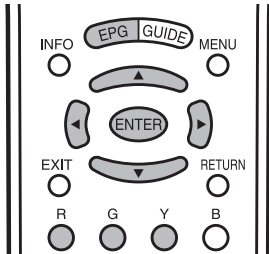

#### Display the EPG screen

##### ① Press **◀/▶** to select the time span you want to search.

- Continue to press **▶** to display programmes in the next time span.

##### ② Press **▲/▼** to select the desired programme.

- If **▲** or **▼** are displayed on the left of the services, continue to press **▲/▼** to display next or previous screen.

#### Close the EPG screen

Press **EPG** again.

### Selecting a programme

##### ③ Check programme information

**1** Press **▲/▼/◀/▶** to select the programme you want to check.

**2** Press **R**.

#### Programme Information

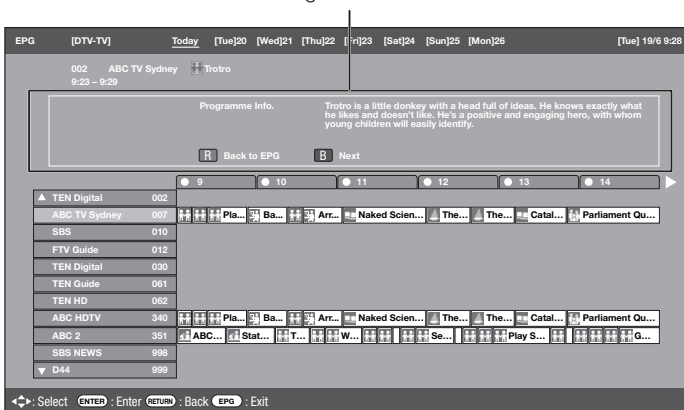

**3** Press **ENTER** to tune to the selected programme.

## Watching TV

### ④ Search a programme in a category

- 1 Press **G**.
- 2 Press **▲/▼** to select the desired genre, and then press **ENTER**.
- 3 Press **▲/▼** to select a programme you want to watch, and then press **ENTER**.

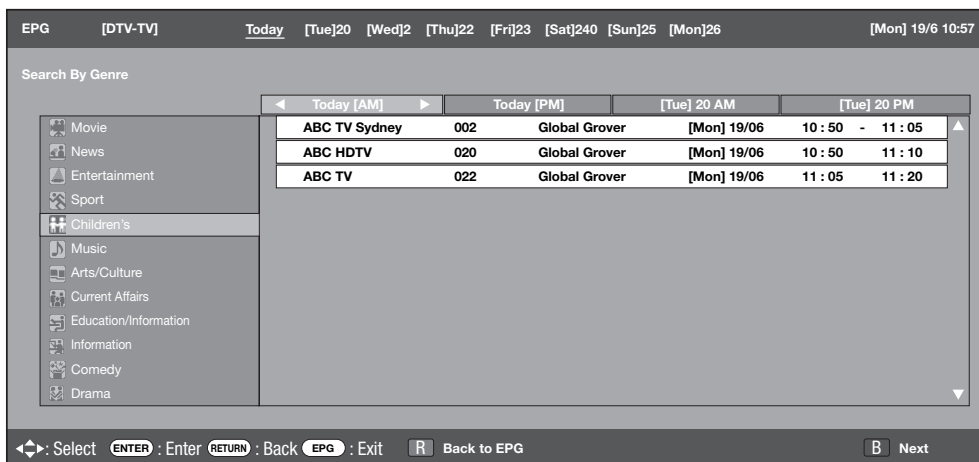

### ⑤ Search for a programme by date/time

- 1 Press **Y**.
- 2 Press **◀/▶** to select the desired time span and then press **ENTER**.

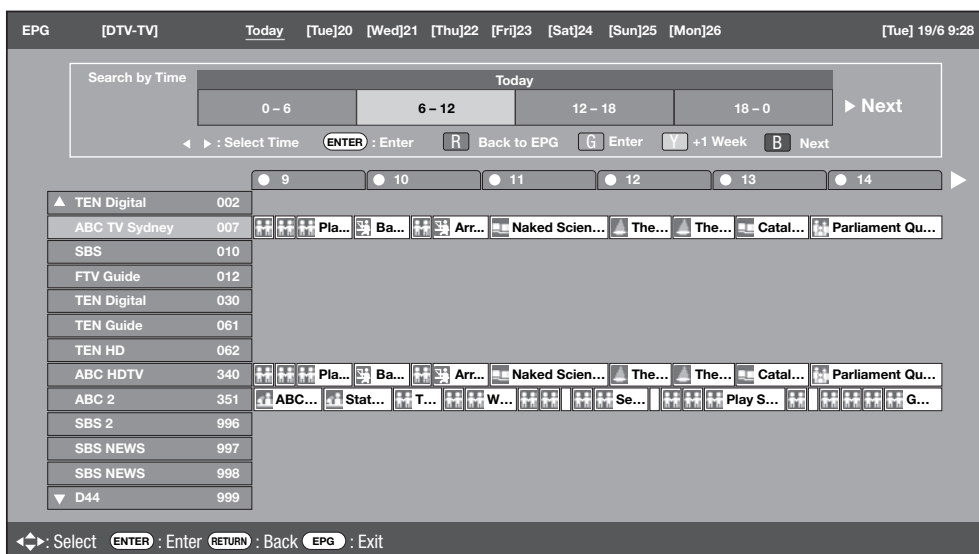

- 3 Press **▲/▼** to select the desired programme, and then press **ENTER**.

#### NOTE

- When you select a programme outside of the current time span, the timer setting screen displays. (Page 46)

### Timer recording using EPG

You can record TV programmes using data from the EPG.

- 1 Press **EPG**.
- 2 Press **▲/▼/◀/▶** to select the programme you want to record, and then press **ENTER**.
- 3 Press **◀/▶** to select the preferred timer setting, and then press **ENTER**.

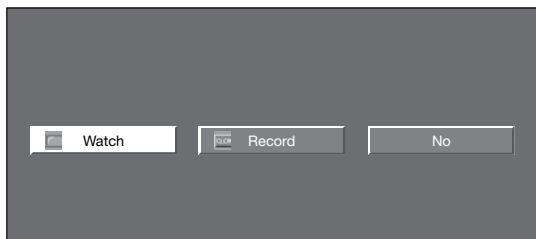

- If you select “No”, the TV returns to the EPG screen.

#### ■ Selecting “Watch” in the timer setup screen

This setting allows you to switch to a programme at a set time.

- ① Press **◀/▶** to select “Watch”, and then press **ENTER**.
- ② Press **◀/▶** to select “Yes”, and then press **ENTER**.
  - The selected TV programme is marked with an icon.

#### ■ Selecting “Record” in the timer setup screen

This setting allows you to record a programme at a set time.

- ① Press **◀/▶** to select “Record”, and then press **ENTER**.
- ② Press **◀/▶** to select the preferred timer recording type, and then press **ENTER**.

Selected item	Description
<b>AQUOS LINK</b>	Record a programme at a set time when a device compatible with AQUOS LINK is connected.
<b>VHS tape</b>	Record a programme at a set time when a device compatible with VHS tape is connected.

#### 📎 NOTE

- Refer to pages 12 and 13 for connecting external devices.
- The selected TV programme is marked with an icon.

### Cancelling the timer recording

- 1 Press **EPG**.
- 2 Press **▲/▼/◀/▶** to select the programme on timer setup, and then press **ENTER**.
- 3 Press **◀/▶** to select “Cancel”, and then press **ENTER**.

#### ■ Cancelling using B button on the remote control

- 1 Press **EPG**.
- 2 Press **B** to display the timer recording screen.
- 3 Press **▲/▼** to select a programme with a set timer recording you want to change, and then press **ENTER**.
- 4 Press **◀/▶** to select “Cancel” and then press **ENTER**.

# Settings when using external devices

## Settings when using HDMI output devices

HDMI terminals can carry audio and visual signals to the TV with an HDMI certified cable. When you want to output the audio and picture from an HDMI output device on the TV, select "INPUT4", "INPUT5" or "INPUT6" by switching the input source.

### Connecting an HDMI output device

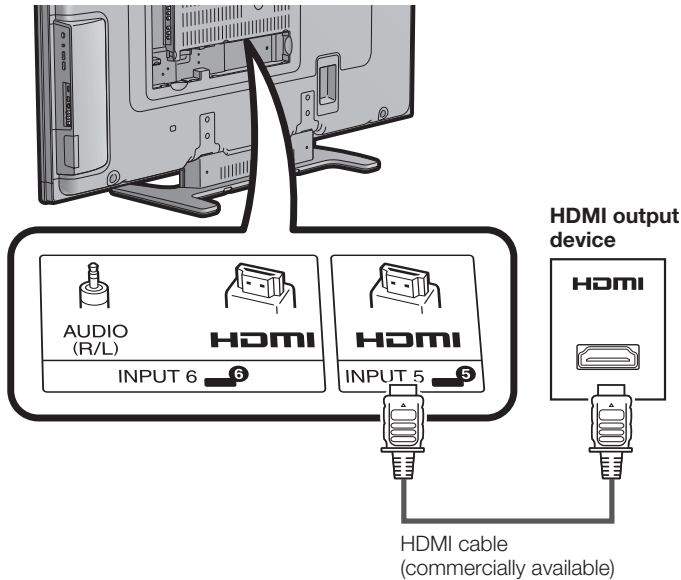

### HDMI (High-Definition Multimedia Interface) Auto View

- 1 To watch an HDMI equipment image, select "INPUT4", "INPUT5" or "INPUT6" using **TV/VIDEO** on the remote control unit or on the TV.
- 2 Press **MENU** and the MENU screen displays.
- 3 Press **◀/▶** to select "Setup".

- 4 Press **▲/▼** to select "HDMI Auto View", and then press **ENTER**.

- The HDMI Setup can be selected only when "INPUT4", "INPUT5" or "INPUT6" is selected.

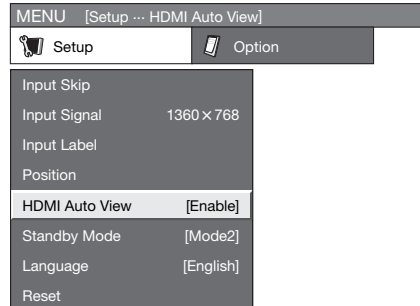

- 5 Press **◀/▶** to select the desired item, and then press **ENTER**.

Selectable items	Description
Enable/Disable	Set whether or not to use WIDE MODE based on signal recognition, including an HDMI signal.

## Settings when using external devices

### HDMI Audio Select

The HDMI Audio Select can be selected only when "INPUT6" is selected.

**1** Press **MENU** and the MENU screen displays.

**2** Press **◀/▶** to select "Option".

**3** Press **▲/▼** to select "HDMI Audio Select", and then press **ENTER**.

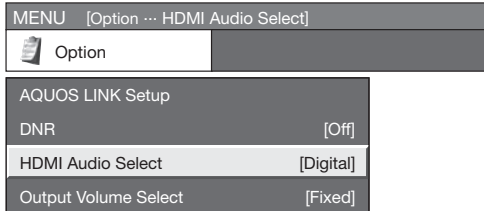

**4** Press **◀/▶** to select the desired setting, and then press **ENTER**.

Selectable items	Description
Digital	Audio signal via the HDMI terminal.
Analogue	Audio signal via the AUDIO jack.

#### NOTE

- "HDMI Audio Select" is only available for INPUT6.
- Refer to your external equipment operation manual for above settings.
- When connecting a DVI-HDMI conversion adaptor/cable to the HDMI terminal, the image may not come in clearly.

## Settings when using external devices

### Selecting the input source and signal type

#### Selecting input source

Can use for selecting the input source.

**Using TV/VIDEO on the remote control unit or on the TV.**

**TV/VIDEO** allows you to choose from the available input sources.

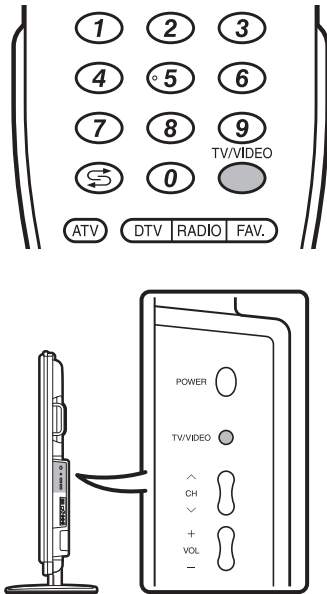

**1** Press **TV/VIDEO** on the remote control unit or on the TV.

**2** Press **TV/VIDEO** on the remote control unit or on the TV to select the input source.

- The image and sound from the selected source are output on the TV.

#### NOTE

- The display for INPUT SOURCE selecting is only displayed when you toggle the input by using **TV/VIDEO** on the remote control. Meanwhile, you can also select the input source by pressing **▲/▼**.

#### Selecting input signal type

For setting the signal type of external equipment.

**1** Press **MENU** and the MENU screen displays.

**2** Press **◀/▶** to select "Option".

**3** Press **▲/▼** to select "Input Select", and then press **ENTER**.

**4** Press **▲/▼** to select a signal type you want to set, and then press **ENTER**.

Input source	Selectable item
<b>INPUT 1</b>	Auto, COMPONENT, VIDEO
<b>INPUT 2</b>	Auto, COMPONENT, VIDEO
<b>INPUT 3</b>	Auto, S-VIDEO, VIDEO

#### NOTE

- If no colour image displays, try changing the other signal type.
- Check the operation manual of the external equipment for the signal type.
- When the signal type is set to "Auto", the input terminal where a cable is connected is automatically selected.
- When the signal type is set to "Auto" and multiple video signal cables are connected, the signal type is selected in the following prioritised order:  
INPUT 1/INPUT 2: COMPONENT→VIDEO  
INPUT 3: S-VIDEO→VIDEO

#### Selecting the size of the picture for recording

You can use this function to set the appropriate picture size for recording a 16:9 format TV programme broadcast via DTV.

**1** Press **MENU** and the MENU screen displays.

**2** Press **◀/▶** to select "Digital Setup".

**3** Press **▲/▼** to select "REC Picture Size", and then press **ENTER**.

**4** Press **◀/▶** to select the desired picture size, and then press **ENTER**.

Selected item	Description
<b>16:9 TV</b>	The TV displays the 16:9 format picture with black bands at the top and bottom of the screen.
<b>4:3 TV</b>	The picture gets compressed in the horizontal direction.

## Settings when using external devices

### Labelling input sources

You can assign each input source a label as you prefer.

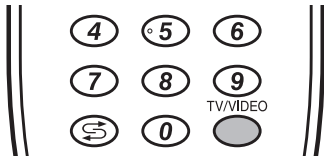

- 1 Press **TV/VIDEO** to select the desired input source.
- 2 Press **MENU** and the MENU screen displays.
- 3 Press **◀/▶** to select "Setup".
- 4 Press **▲/▼** to select "Input Label", and then press **ENTER**.
- 5 Press **▲/▼/◀/▶** to select each character of the new name for the input source, and press **ENTER**.

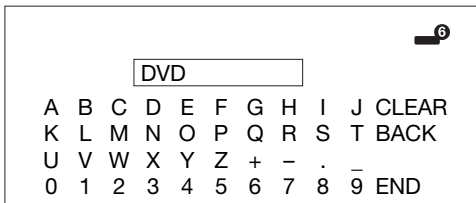

(Example)

- When you want to change the input label that you have already assigned to the default name, press **◀/▶** to move to "CLEAR" on the "Input Label" screen, and then press **ENTER**.

- 6 Repeat until the name is fully spelt out.
  - The name can be 6 characters or less.
  - When you want to set an input source name of less than 6 characters, select "END", then press **ENTER** to exit from the labelling menu.



(Example)

#### NOTE

- You cannot change labels if the input source is TV.
- The display for INPUT SOURCE selecting is only displayed when you toggle the input by using TV/VIDEO on the remote control.

### Skipping HDMI/RGB input

This setting allows you to skip the HDMI or PC input on the input source Selection operation.

- 1 Press **MENU** and the MENU screen displays.
- 2 Press **◀/▶** to select "Setup".
- 3 Press **▲/▼** to select "Input Skip", and then press **ENTER**.
- 4 Press **▲/▼** to select the Input (INPUT4 to INPUT7) you wish to skip, and then press **ENTER**.

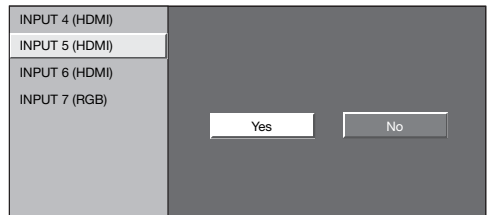

- 5 Press **◀/▶** to select "Yes", and then press **ENTER**.
- 6 Press **MENU** to exit.

### Colour system settings

You can change the colour system to one that is compatible with the image on the screen.

- 1 Press **MENU** and the MENU screen displays.
- 2 Press **◀/▶** to select "Option".
- 3 Press **▲/▼** to select "Colour System", and then press **ENTER**.
- 4 Press **▲/▼** to select a compatible video signal system of your equipment, and then press **ENTER**.

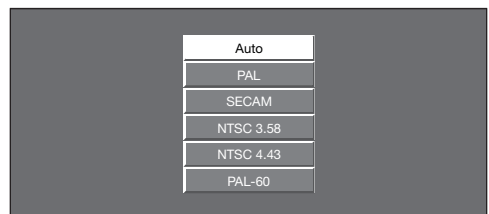

#### NOTE

- Factory preset value is "Auto".
- If "Auto" is selected, colour system for input signal is automatically set. If an image does not display clearly, select another colour system (e.g. PAL, NTSC 4.43).
- "Colour System" is selectable only when inputting an S-VIDEO or composite signal.



# AQUOS LINK

## Controlling HDMI devices using AQUOS LINK

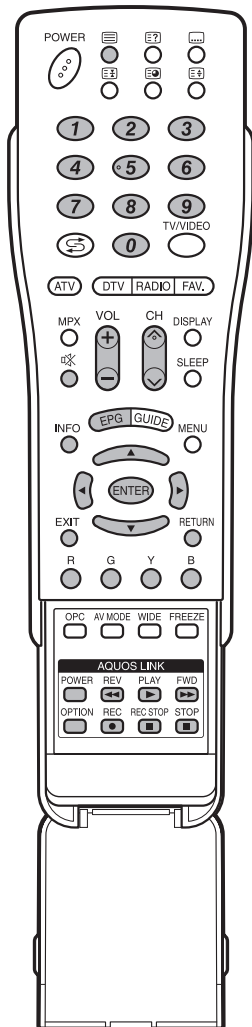

### What is AQUOS LINK?

Using the HDMI CEC (Consumer Electronics Control) protocol, with AQUOS LINK you can interactively operate compatible system devices (AV amplifier, DVD, Blu-ray Disc device) using a single remote control.

By connecting AQUOS LINK-compatible devices with HDMI-certified cables to the TV, you can control a recorder or AV amplifier using the remote control of the TV.

AQUOS LINK allows you to operate the HDMI-connected equipment with one remote control.

#### NOTE

- Please check the availability of AQUOS LINK-compatible AQUOS BD Player and AQUOS LINK-compatible audio system via the sole agent in your country.

### What you can do with AQUOS LINK

#### ✓ One Touch Play

While the TV is in standby mode, it automatically turns on and plays back the image from the HDMI source.

#### ✓ Single remote control operation

The AQUOS LINK automatically recognises the connected HDMI device and you can control the TV and the devices as if using a universal remote control.

#### ✓ Operating Title list of external devices

You can also call up the external player's Top menu or AQUOS BD Player's Title list provided that the devices support AQUOS LINK.

#### ✓ Multiple control of HDMI devices

You can select which HDMI device to operate using **OPTION**.

#### ✓ Controlling the AQUOS LINK-compatible audio system

You can adjust the volume and select the sound mode of the AQUOS LINK-compatible audio system.

#### NOTE

- Point the remote control toward the TV, not to the connected HDMI device.
- Video noise may occur depending on the type of HDMI-certified cable used. Make sure to use a HDMI-certified cable.
- Up to 3 pieces of HDMI recording equipment and one AV amplifier can be connected using this system.
- These operations affect the HDMI device selected as the current input source. If the device does not operate, turn on the device and select the appropriate input source using **TV/VIDEO**.
- When you insert/remove HDMI-certified cables or change connections, turn on all connected HDMI devices before turning on the TV. Confirm that picture and audio are correctly output by selecting "INPUT4", "INPUT5" or "INPUT6" from the INPUT SOURCE menu.

**AQUOS LINK connection**

First connect the AQUOS LINK-compatible audio system or an AQUOS BD Player that supports the HDMI CEC protocol.

**NOTE**

- Refer to the operation manual of the device to be connected for further details.
- After unplugging connection cables or changing the connection pattern, first turn on the power of the TV with all relevant device's power turned on. Change the external input source by pressing **TV/VIDEO**, select the appropriate input source and verify the audiovisual output.
- The cables illustrated in the following explanation are commercially available items.

**Connecting an AQUOS BD Player via the AQUOS LINK-compatible audio system**

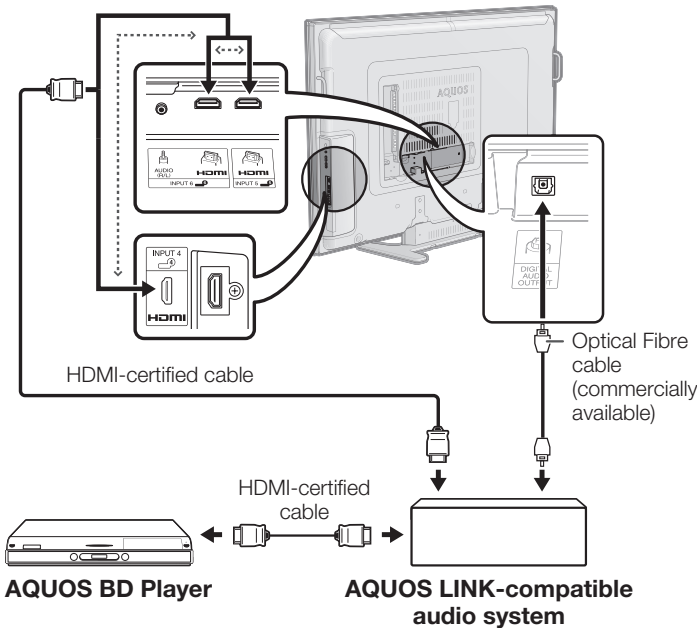

**Connecting an AQUOS BD Player only**

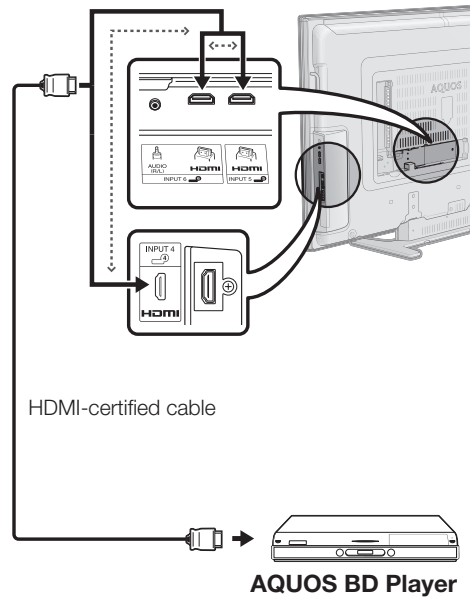

**AQUOS LINK Setup**

**AQUOS LINK Auto power on**

If this is activated, the One Touch Play function is enabled. While the TV is in standby mode, it automatically turns on and plays back the image from the HDMI source.

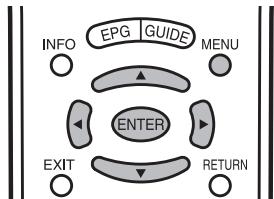

- 1 Press **MENU** and the MENU screen displays.
- 2 Press **◀/▶** to select "Option".
- 3 Press **▲/▼** to select "AQUOS LINK Setup", and then press **ENTER**.

- 4 Press **▲/▼** to select "Auto Power On", and then press **ENTER**.

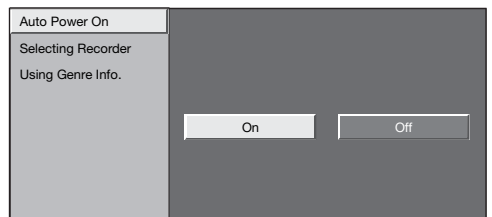

- 5 Press **◀/▶** to select "On", and then press **ENTER**.
- 6 Press **MENU** to exit.

**NOTE**

- The factory default for this item is "Off".

## AQUOS LINK

### Selecting recorder

You can select a recorder for the recording from several connected recorders.

1 Repeat steps 1 to 3 in **AQUOS LINK Auto power on**.

2 Press **▲/▼** to select "Selecting Recorder", and then press **ENTER**.

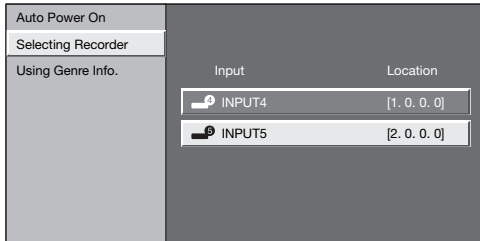

3 Select the recorder, and then press **ENTER**.

4 Press **MENU** to exit.

#### NOTE

- If you have connected the AQUOS LINK-compatible audio system between the TV and an CEC-compatible recorder, the input source's indication changes from "INPUT4" to "INPUT4 (Sub)" as it is shown below.

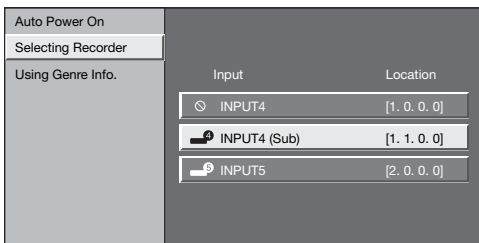

### Using Genre Info.

This function allows you to automatically switch to the appropriate sound mode depending on the genre information included in the digital broadcast.

1 Repeat steps 1 to 3 in **AQUOS LINK Auto power on**.

2 Press **▲/▼** to select "Using Genre Info.", and then press **ENTER**.

3 Press **◀/▶** to select "On", and then press **ENTER**.

### Operating an AQUOS LINK device

AQUOS LINK allows you to operate the HDMI-connected device with one remote control.

**Use the following procedure to start playback.**

1 Press **PLAY ▶** to start playback of a title.

- See page 54, section "**Playback of titles using AQUOS LINK**" if you want to start playback using the list of the titles of the AQUOS BD Player.

2 Press **FWD ▶▶** to fast forward.

Press **REV ◀◀** to reverse.

Press **STOP ■** to stop.

Press **POWER** to turn the HDMI-connected device on/off.

**Use the following procedure to start recording.**

Check the following items before recording.

- Make sure the antenna cable is connected properly.
- Check if the recording media (HDD, DVD, etc.) has enough capacity for recording a programme.
- Select the equipment for recording in Selecting Recorder.

1 After you selected recording media (HDD, DVD, etc.) in the menu, please make sure the recording menu in the ready condition.

2 Press **REC ●** to record a programme.

3 Press **REC STOP ■** to stop recording.

### Listening with the AQUOS LINK-compatible audio system

You can opt to listen to the TV sound only from the AQUOS LINK-compatible audio system.

1 Open the remote control unit's flip cover, press **OPTION** and the AQUOS LINK menu screen displays.

2 Press **▲/▼** to select "By AQUOS AUDIO SP", and then press **ENTER**.

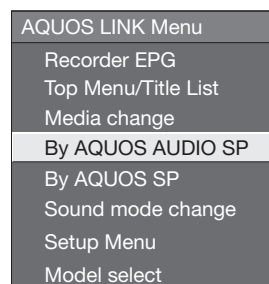

- The sound from the TV speaker and headphone terminal is silenced and only the sound from the AQUOS LINK-compatible audio system is audible.
- You can use **VOL +/-** and **MUTE (⊗)**.

## AQUOS LINK

### Listening with the AQUOS TV speaker system

You can opt to listen to the TV sound only from the AQUOS TV speaker system.

- 1 Open the remote control unit's flip cover, press **OPTION** and the AQUOS LINK menu screen displays.
- 2 Press **▲/▼** to select "By AQUOS SP", and then press **ENTER**.

### Manually changing the AQUOS LINK-compatible audio system's sound mode

- 1 Open the remote control unit's flip cover, press **OPTION** and the AQUOS LINK menu screen displays.
- 2 Press **▲/▼** to select "Sound mode change".

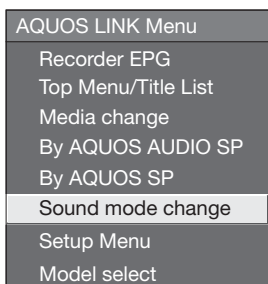

- 3 The sound mode changes every time you press **ENTER**.
  - Refer to the operation manual of the AQUOS LINK-compatible audio system for details.

### Calling up the menu of an external device connected with the TV via HDMI

You can call up the menu of an HDMI CEC-compatible external device (player, recorder, decoder, etc.) using the "Setup Menu" function.

- 1 Open the remote control unit's flip cover, and then press **OPTION**.
- 2 Press **▲/▼** to select "Setup Menu", and then press **ENTER**.

#### NOTE

- If a connected device does not have this function or the device is in a status where the menu cannot be displayed (recording, entering standby, etc.), this function may not be available.

### Playback of titles using AQUOS LINK

This section explains how to play back a title in the AQUOS BD Player.

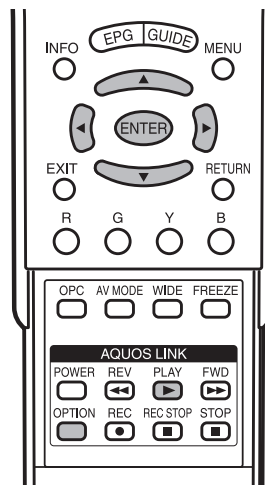

- 1 Power on the AQUOS BD player, and select the appropriate external input.
- 2 Open the remote control unit's flip cover, press **OPTION** and the AQUOS LINK menu screen displays.
- 3 Press **▲/▼** to select "Top Menu/Title List", and then press **ENTER**.

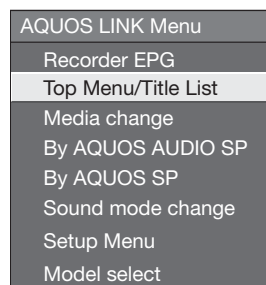

- The linked recorder now powers on and the TV automatically selects the appropriate external input source.
- The title list data from the connected AQUOS BD Player displays.

- 4 Select the title with **▲/▼/◀/▶**, and then press **PLAY ▶** to start playback.

## AQUOS LINK

### Selecting media type for CEC-compatible recorder

If your recorder has multiple storage media, select the media type here.

**1** Open the remote control unit's flip cover, press **OPTION** and the AQUOS LINK menu screen displays.

**2** Press **▲/▼** to select "Media change", and then press **ENTER**.

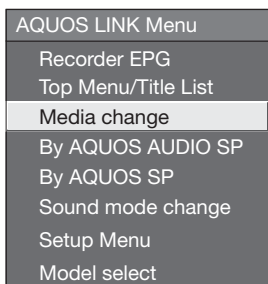

**3** Select the desired medium, such as DVD or HDD. The media type changes every time you press **ENTER**.

### One Touch Recording

With this function, you can easily record a programme you are watching on the TV onto AQUOS LINK-compatible equipment by simply pressing **REC**.

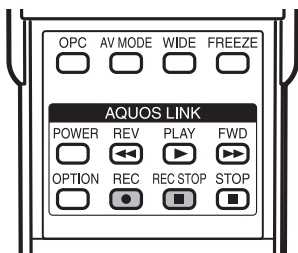

### Check the following items before recording.

- Make sure the antenna cable is connected properly.
- Check if the recording media (HDD, DVD, etc.) has enough capacity for recording a programme.
- Select the equipment for recording in "Model select".

**1** Press **REC** to record a programme.

- The selected AQUOS LINK-compatible device automatically detects the programme you are watching on the TV and starts recording.

**2** Press **REC STOP** to stop recording.

### NOTE

- One Touch Recording cannot be performed unless the device you select in "Model select" is AQUOS LINK compatible.

### HDMI device selection

If multiple HDMI devices are connected in a daisy chain, you can specify which device to control here.

**1** Open the remote control unit's flip cover, press **OPTION** and the AQUOS LINK menu screen displays.

**2** Press **▲/▼** to select "Model select", and then press **ENTER**. The HDMI device changes every time you press **ENTER**.

### Recording via the CEC-compatible recorder's EPG (only for recorders)

You can call up the CEC-compatible recorder's EPG and preset timer recordings using the TV's remote control.

**1** Open the remote control unit's flip cover, press **OPTION** and the AQUOS LINK menu screen displays.

**2** Press **▲/▼** to select "Recorder EPG", and then press **ENTER**.

- The external input source switches and the recorder's EPG is displayed.

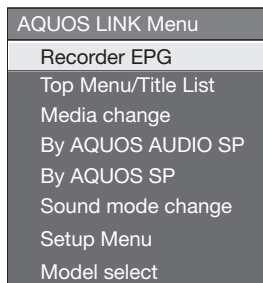

**3** Select the programme to record.

- You can use **▲/▼/◀/▶**, **RETURN**, **EXIT** and the coloured buttons.

### NOTE

- Refer to the operation manual of the recorder for details.

# Connecting a PC

Use the PC terminals to connect a PC.

## HDMI Connection

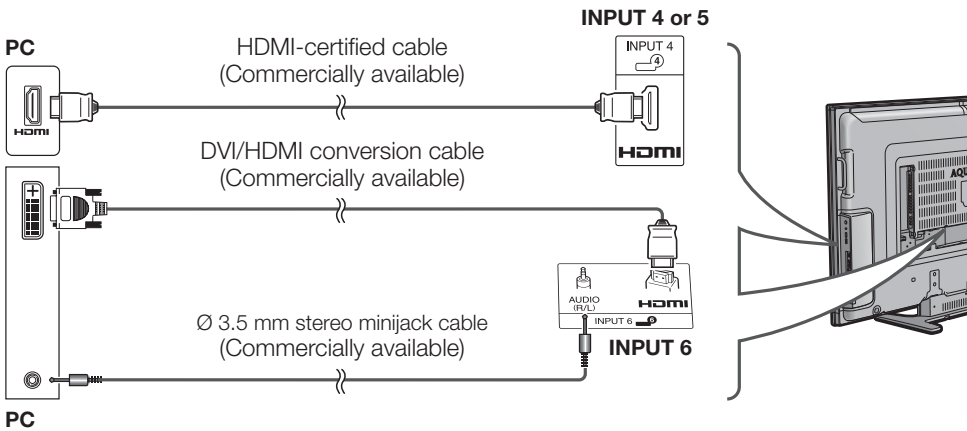

### NOTE

- The PC INPUT terminals are DDC1/2B-compatible.
- Refer to page 61 for a list of PC signals compatible with the TV.

## Analogue Connection

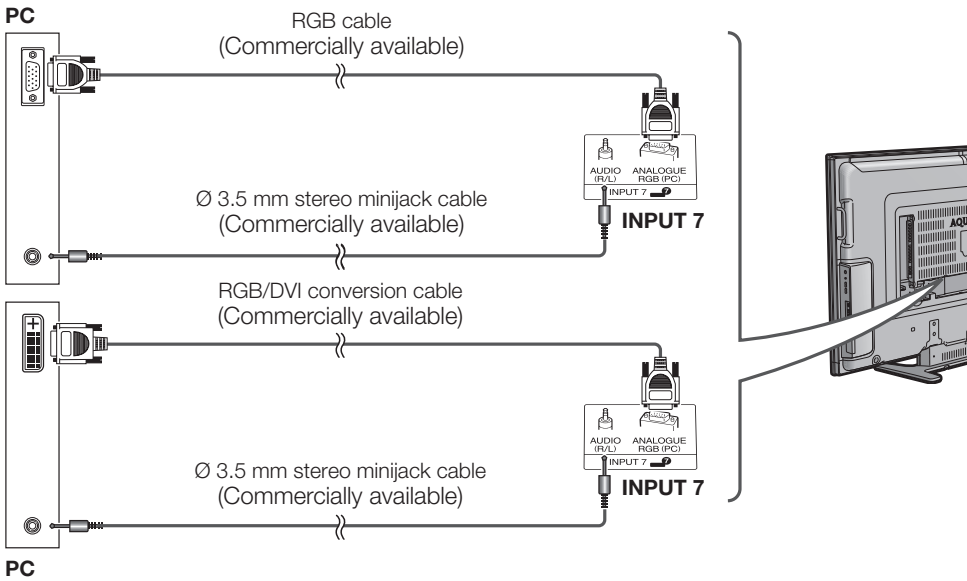

### Signal names for 15-pin mini D-sub connector

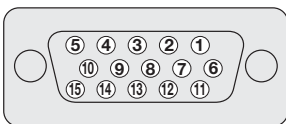

Pin No.	Signal name	Pin No.	Signal name	Pin No.	Signal name
①	R	⑥	GND (Ground)	⑪	Not connected
②	G	⑦	GND (Ground)	⑫	SDA
③	B	⑧	GND (Ground)	⑬	HD
④	Not connected	⑨	+5V	⑭	VD
⑤	CSYNC	⑩	GND (Ground)	⑮	SCL

### NOTE

- Macintosh adaptor may be required for use for some Macintosh computers.
- Pin No. ⑤ is not used for inputting the signal.

## Connecting a PC

### Displaying a PC image on the screen

#### Selecting the picture size

You can select the picture size as illustrated below.

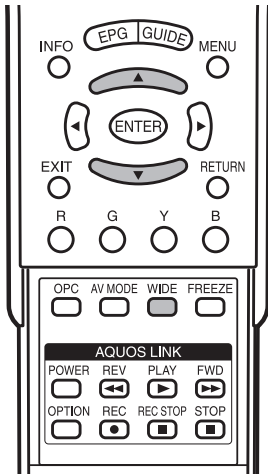

- 1 Press **WIDE**.
  - The WIDE MODE menu displays.

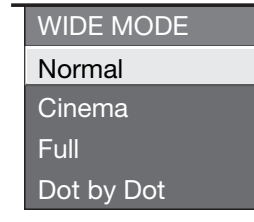

(Example)

- 2 Press **WIDE** or **▲/▼** to select a desired item on the menu.

#### NOTE

- Connect the PC before making adjustments.
- Selectable screen size may vary with input signal type.

#### EXAMPLE

Screen size images.

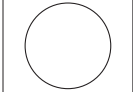
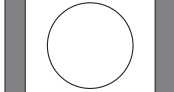
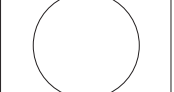
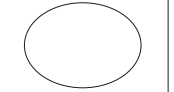
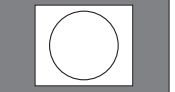
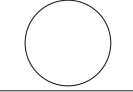
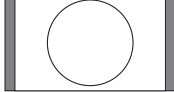
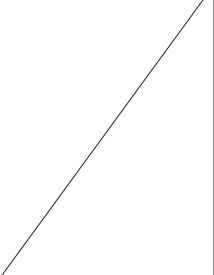
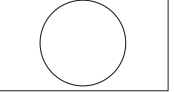
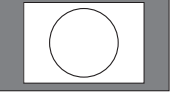
<p><b>Input Signal</b></p>  <p>1024 × 768</p>	➔	<p><b>Normal</b></p>  <p>Keeps the original aspect ratio in a full screen display.</p>	<p><b>Cinema</b></p>  <p>For viewing wide screen programs. The top and bottom of the image is slightly cropped.</p>	<p><b>Full</b></p>  <p>An image fully fills the screen.</p>	<p><b>Dot by Dot</b></p>  <p>Detects the resolution of the signal and displays an image with the same number of pixels on the screen.</p>
<p><b>Input Signal</b></p>  <p>1360 × 768</p>	➔	<p><b>Normal</b></p>  <p>Keeps the original aspect ratio in a full screen display.</p>		<p><b>Full</b></p>  <p>An image fully fills the screen.</p>	<p><b>Dot by Dot</b></p>  <p>Detects the resolution of the signal and displays an image with the same number of pixels on the screen.</p>

## Connecting a PC

### Adjusting the PC image automatically

This function enables the screen to be automatically adjusted to its best possible condition when the analogue terminals of the TV and PC are connected with a commercially available DVI/D-sub conversion cable, etc.

**1** Press **MENU** and the MENU screen displays.

**2** Press **◀/▶** to select “Setup”.

**3** Press **▲/▼** to select “Auto Sync.”, and then press **ENTER**.

**4** Press **◀/▶** to select “Yes”, and then press **ENTER**.

- Auto Sync. starts and “Adjusting the image” displays.

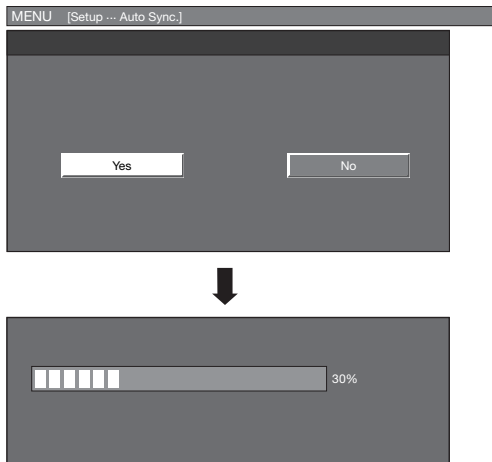

**5** Press **MENU** to exit.

#### NOTE

- When Auto Sync. is successful, “Auto Sync completed successfully” displays. If not, Auto Sync. failed.
- Auto Sync. may fail even if “Auto Sync completed successfully” displays.
- Auto Sync. may fail if the computer image has low resolution, has unclear (black) edges, or is moved while executing Auto Sync.
- Be sure to connect the PC to the TV and switch it on before starting Auto Sync.
- Auto Sync. can be executed only when inputting analogue signals.

### Adjusting the PC image manually

Ordinarily you can easily adjust the picture as necessary to change image position using Auto Sync. In some cases, however, manual adjustment is needed to optimise the image.

**1** Press **MENU** and the MENU screen displays.

**2** Press **◀/▶** to select “Setup”.

**3** Press **▲/▼** to select “Fine Sync.”, and then press **ENTER**.

**4** Press **▲/▼** to select the specific adjustment item.

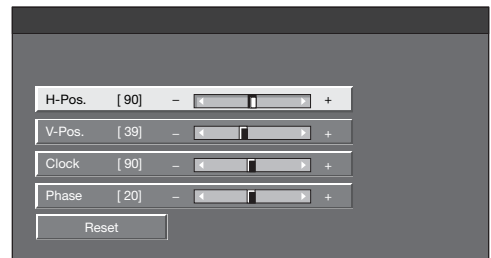

Selected item	Description
<b>H-Pos.</b>	Centres the image by moving it to the left or right.
<b>V-Pos.</b>	Centres the image by moving it up or down.
<b>Clock</b>	Adjusts when the image flickers with vertical stripes.
<b>Phase</b>	Adjusts when characters have low contrast or when the image flickers.

**5** Press **◀/▶** to adjust the item to your desired position.

**6** Press **MENU** to exit.

#### NOTE

- For resetting all adjustment items to the factory preset values, press **▲/▼** to select “Reset”, and then press **ENTER**.
- “Clock” and “Phase” in the “Fine Sync.” menu can be adjusted only when inputting analogue signals.
- Images may not be displayed properly depending on the settings and/or input signals.



## Connecting a PC

### Input resolution settings

#### Selecting the input resolution

- Some input signals may have to be registered manually to display properly.
- The pairs of input signals (resolutions) in the list below are not distinguishable when received. In such case, you have to set the correct signal manually. After setting once, it will display when the same signal (resolution) is input again.

1024 x 768	1360 x 768
------------	------------

- 1 Press **MENU** and the MENU screen displays.
- 2 Press **◀/▶** to select “Setup”.
- 3 Press **▲/▼** to select “Input Signal” and then press **ENTER**.
- 4 Press **▲/▼** to select the desired input signal on the display.

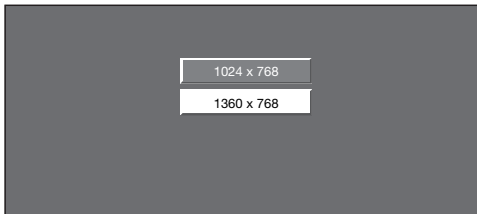

(Example)

#### NOTE

- You can only select the “Input Signal” on the Setup menu when receiving one of the 2 input signals listed above.

## Connecting a PC

### PC Control of the TV

- When a programme is set, the TV can be controlled from the PC using the RS-232C terminal.  
The input signal (PC/video) can be selected, the volume can be adjusted and various other adjustments and settings can be made, enabling automatic programmed playing.
- Attach an RS-232C cable cross-type (commercially available) to the Din/D-sub RS-232C for the connections.

#### NOTE

- This operation system should be used by a person who is accustomed to using PCs.

#### Communication conditions

Set the RS-232C communications settings on the PC to match the communications conditions of the TV. The communications settings of the TV are as follows:

<b>Baud rate:</b>	9,600 bps
<b>Data length:</b>	8 bits
<b>Parity bit:</b>	None
<b>Stop bit:</b>	1 bit
<b>Flow control:</b>	None

#### Communication procedure

Send the control commands from the PC via the RS-232C connector.

The TV operates according to the received command and sends a response message to the PC.

Do not send multiple commands at the same time. Wait until the PC receives the OK response before sending the next command.

#### Command format

Eight ASCII codes + CR

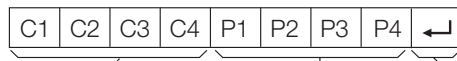

Command 4-digits      Parameter 4-digits      Return code

Command 4-digits: Command. The text of four characters.  
Parameter 4-digits: Parameter 0 — 9, space, ?

#### Parameter

Input the parameter values, aligning left, and fill with space(s) for the remainder. (Be sure that four values are input for the parameter.)

When the input parameter is not correct, "ERR" returns. (Refer to "Response code format".)

0			
0	0	0	9
-	3	0	
1	0	0	
0	0	5	5

When "?" is input for some commands, the present setting value responds.

?			
?	?	?	?

#### Response code format

Normal response

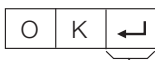

Return code (ODH)

Problem response (communication error or incorrect command)



Return code (ODH)

PC compatibility chart

Resolution		Horizontal Frequency	Vertical Frequency	Analogue (D-Sub)	Digital (HDMI)	VESA Standard
VGA	640 × 480	31.5 kHz	60 Hz	✓	✓	✓
SVGA	800 × 600	37.9 kHz	60 Hz	✓	✓	✓
XGA	1024 × 768	48.4 kHz	60 Hz	✓	✓	✓
WXGA	1360 × 768	47.7 kHz	60 Hz	✓	✓	✓
SXGA	1280 × 1024	64.0 kHz	60 Hz	✓	✓	✓
SXGA+	1400 × 1050	65.3 kHz	60 Hz		✓	✓

**NOTE**

- This TV has only limited PC compatibility, correct operation can only be guaranteed if the video card conforms exactly to the VESA 60Hz standard. Any variations from this standard will result in picture distortions.

DDC is a registered trademark of Video Electronics Standards Association. Power Management is a registered trademark of Sun Microsystems, Inc. VGA and XGA are registered trademarks of international Business Machines Corp.

RS-232C commands list

Commands

- Commands not indicated here are not guaranteed to operate.

CONTROL ITEM	COMMAND	PARAMETER	CONTROL CONTENTS
POWER SETTING	P O W R 0	_ _ _ _	POWER OFF (STANDBY)
INPUT SELECTION A	I T V D	_ _ _ _	INPUT SWITCHING (TOGGLE)
	I T V D	_ _ _ _	TV (CHANNEL FIXED)
	I D T V	_ _ _ _	DTV (CHANNEL FIXED)
	I A V D *	_ _ _ _	INPUT1-7 (1-7)
CHANNEL	D C C H *	* _ _ _	TV DIRECT CHANNEL (1-99)
	C H U P	_ _ _ _	CHANNEL UP
	C H D W	_ _ _ _	CHANNEL DOWN
	D T V D *	* * _ _	DTV DIRECT CHANNEL (1-999)
	D T U P	_ _ _ _	DTV CHANNEL UP
	D T D W	_ _ _ _	DTV CHANNEL DOWN
INPUT SELECTION B	I N P 1 0	_ _ _ _	INPUT1 (AUTO)
	I N P 1 1	_ _ _ _	INPUT1 (COMPONENT)
	I N P 1 3	_ _ _ _	INPUT1 (VIDEO)
	I N P 2 0	_ _ _ _	INPUT2 (AUTO)
	I N P 2 1	_ _ _ _	INPUT2 (COMPONENT)
	I N P 2 3	_ _ _ _	INPUT2 (VIDEO)
	I N P 3 0	_ _ _ _	INPUT3 (AUTO)
	I N P 3 2	_ _ _ _	INPUT3 (S-VIDEO)
	I N P 3 3	_ _ _ _	INPUT3 (VIDEO)
AV MODE SELECTION	A V M D 0	_ _ _ _	TOGGLE
	A V M D 1	_ _ _ _	STANDARD
	A V M D 2	_ _ _ _	MOVIE
	A V M D 3	_ _ _ _	GAME
	A V M D 4	_ _ _ _	USER
	A V M D 5	_ _ _ _	DYNAMIC (Fixed)
	A V M D 6	_ _ _ _	DYNAMIC
	A V M D 7	_ _ _ _	PC
	A V M D 8	_ _ _ _	x.v.Colour

**NOTE**

- If an underbar ( \_ ) appears in the parameter column, enter a space.
- If an asterisk ( \* ) appears, enter a value in the range indicated in brackets under CONTROL CONTENTS.

CONTROL ITEM	COMMAND	PARAMETER	CONTROL CONTENTS
VOLUME	V O L M *	* _ _ _	VOLUME (0-60)
POSITION	H P O S *	* * _ _	H-POSITION (AV) (-nn - nn)
	H P O S *	* * _ _	H-POSITION (PC) (-nn - nn)
	V P O S *	* * _ _	V-POSITION (AV) (-nn - nn)
	V P O S *	* * _ _	V-POSITION (PC) (-nn - nn)
	C L C K *	* * _ _	CLOCK (0-180)
WIDE MODE	P H S E *	* * _ _	PHASE (0-40)
	W I D E 0	_ _ _ _	TOGGLE (AV)
	W I D E 1	_ _ _ _	NORMAL (AV)
	W I D E 2	_ _ _ _	ZOOM 14:9 (AV)
	W I D E 3	_ _ _ _	PANORAMA (AV)
	W I D E 4	_ _ _ _	FULL (AV)
	W I D E 5	_ _ _ _	CINEMA 16:9 (AV)
	W I D E 6	_ _ _ _	CINEMA 14:9 (AV)
	W I D E 7	_ _ _ _	NORMAL (PC)
	W I D E 8	_ _ _ _	CINEMA (PC)
	W I D E 9	_ _ _ _	FULL (PC)
	W I D E 1 0	_ _ _ _	DOT BY DOT (AV/PC)
	W I D E 1 1	_ _ _ _	UNDERSCAN (AV)
MUTE	M U T E 0	_ _ _ _	TOGGLE
	M U T E 1	_ _ _ _	MUTE ON
	M U T E 2	_ _ _ _	MUTE OFF
SURROUND	A C S U 0	_ _ _ _	SURROUND TOGGLE
	A C S U 1	_ _ _ _	SURROUND ON
	A C S U 2	_ _ _ _	SURROUND OFF
AUDIO CHANGE	A C H A	_ _ _ _	TOGGLE
SLEEP TIMER	O F T M 0	_ _ _ _	OFF
	O F T M 1	_ _ _ _	SLEEP TIMER 30 MIN
	O F T M 2	_ _ _ _	SLEEP TIMER 1 HOUR
	O F T M 3	_ _ _ _	SLEEP TIMER 1 HOUR 30 MIN
	O F T M 4	_ _ _ _	SLEEP TIMER 2 HOUR
	O F T M 5	_ _ _ _	SLEEP TIMER 2 HOUR 30 MIN
TEXT	T E X T 0	_ _ _ _	TEXT OFF
	T E X T 1	_ _ _ _	TEXT ON (TOGGLE)
	D C P G *	* * _ _	DIRECT PAGE JUMP (100-899)

# Teletext function

## About Teletext

### What is Teletext?



Teletext broadcasts pages of information and entertainment to specially equipped television sets. Your TV receives Teletext signals broadcast by a TV network, and decodes them into graphical format for viewing. News, weather reports, sports information, stock exchange prices and programme previews are among the many services available.

### Teletext mode

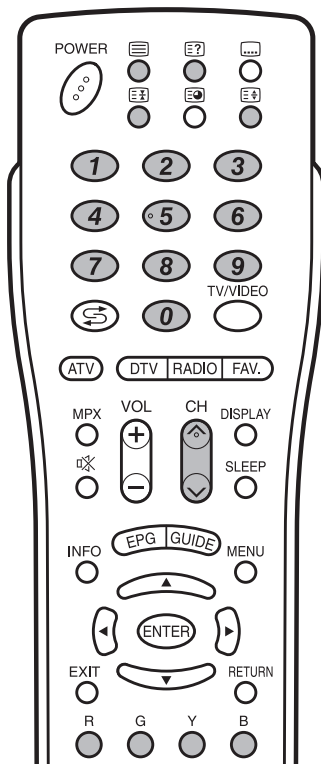
Teletext is turned on/off with  on the remote control unit. You can operate your TV in Teletext mode directly by inputting commands with the remote control unit.



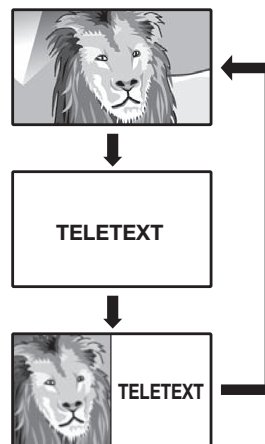

### Turning on and off Teletext

- 1** Select a TV channel or external input source providing the Teletext programme.
- 2** Press  to display the Teletext.
- 3** Press  again to display the Teletext on the right screen and normal image on the left screen.
  - Each time you press , the screen switches as shown to the upper right.
  - If you select a programme with no Teletext signal, "No Teletext available" is displayed.
  - The same message displays during other modes if no Teletext signal is available.



### When viewing the Teletext information

- Press **CH**  to increase the page number.
- Press **CH**  to decrease the page number.

### Button functions

#### Colour (Red/Green/Yellow/Blue):

You can select a group or block of pages displayed in the coloured brackets at the bottom of the screen by pressing the corresponding **Colour (Red/Green/Yellow/Blue)** on the remote control unit.

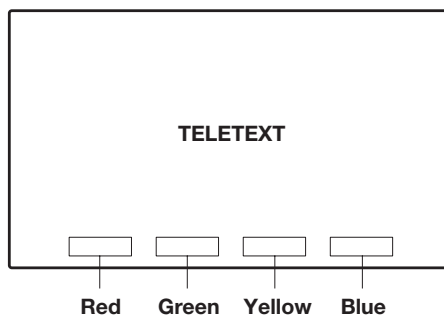

### 0 - 9:

Directly select any page from 100 to 899 by using **0 - 9**.

#### (Top/Bottom/Full):

Each time you press , the TELETEXT image switches as shown below.

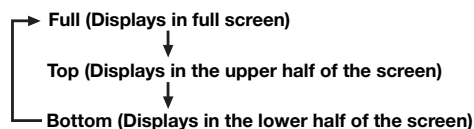

#### (Reveal hidden for TELETEXT):

To reveal hidden information such as an answer to a quiz, press .

- Press  again to hide the information.

#### (Hold):

To stop updating Teletext pages automatically, press

#### .

- Press  again to release the hold mode.

## Teletext function

### Teletext language setting

If Teletext information does not display correctly, perform the procedure below. Select from among 4 kinds of language tables: West Europe, East Europe, Greek/Turkish, Cyrillic. Each table is compatible with the Teletext languages listed below.

1 Press **MENU** and the MENU screen displays.

2 Press **◀/▶** to select "Setup".

3 Press **▲/▼** to select "Text Language", and then press **ENTER**.

4 Press **▲/▼** to select receivable teletext broadcasting language in your country.

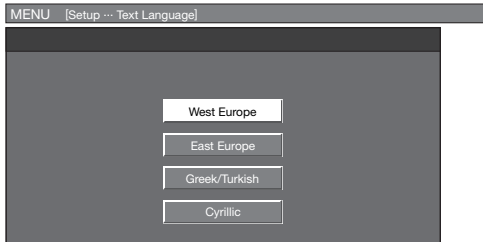

- West Europe — English, French, Scandinavian, Czech, German, Spanish, Italian
- East Europe — Polish, French, Scandinavian, Czech, German, Slovenian/Croatian, Italian, Rumanian
- Greek/Turkish — English, French, Scandinavian, Turkish, German, Spanish, Italian, Greek
- Cyrillic — English, Russian, Estonian, Czech, German, Spanish, Ukrainian, Lettish

#### NOTE

- Teletext can display only when it is sent by a network. Not used to convert between languages.

### Displaying Subpages

You can display subpages as they are transmitted.

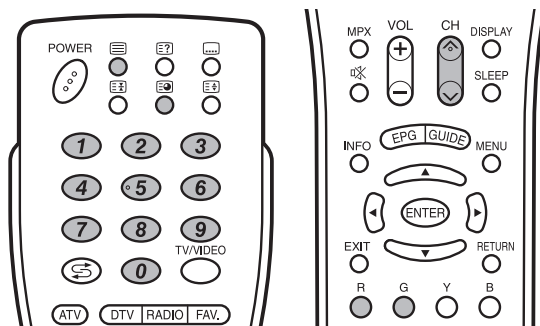

1 Press **☰** to display Teletext.

2 Press **☰** to display the subpage as shown below.



3 Select the desired subpage by using **CH▲/CH▼**, **Red** or **Green**.

- **0 - 9** directly selects the desired subpage.

4 Press **☰** to exit the subpage screen.

### Time display

You can display the time information included in the DTV and Teletext broadcast.

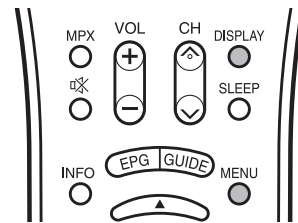

#### NOTE

- Skip step 1 if receiving DTV broadcasts.

1 Select a TV channel providing Teletext information.

(The time information is automatically captured.)

2 Press **DISPLAY**. The channel display will appear on the display.

3 Press **DISPLAY** again within the three-seconds interval the channel display is on the screen. Time information will display on the lower of the screen for about three seconds.

4 Even when you change the TV channel, you can display the time information with steps 2 to 3 above.

#### NOTE

- The time display cannot be stored once the power is turned off. When you turn on the power, perform steps 1 to 4 again.
- If acquired successfully the time information will appear in the upper-right corner of the screen by pressing **MENU**.

# DVB Subtitle

## Displaying Subtitles

You can display subtitles as they are transmitted.

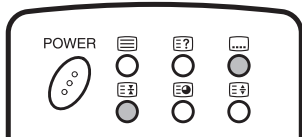

- 1 Press to display the subtitle.
  - Subtitle is updated by information sent by the broadcasting station.

- 2 Press to exit the subtitle screen.

### NOTE

- Subtitle will not be displayed when the service does not contain subtitle information.

## Switching subtitle languages (DVB Subtitle)

Each time you press on the remote control, the subtitle switches



**“For hearing impaired” to “Yes”**

- Subtitles for the hearing impaired have priority over the above subtitle setting (“1st Language” and “2nd Language”).

### EXAMPLE

**1st Language** → **2nd Language**  
**(For hearing impaired)**

### NOTE

- Subtitle will not be displayed when the service does not contain subtitle information.

## Selecting the Language

- 1 Press **MENU** and the MENU screen displays.
- 2 Press to select “Digital Setup”.
- 3 Press to select “Subtitle”, and then press **ENTER**.
- 4 Press to select “1st Language” or “2nd Language”, and then press **ENTER**.
- 5 Press to select the desired language, and then press **ENTER**.

## Displaying subtitles for the hearing impaired

You can display subtitles for the hearing impaired in the broadcast.

- 1 Press **MENU** and the MENU screen displays.
- 2 Press to select “Digital Setup”.
- 3 Press to select “Subtitle”, and then press **ENTER**.
- 4 Press to select “For hearing impaired”, and then press **ENTER**.
- 5 Press to select “Yes”, and then press **ENTER**.

# Appendix

## Troubleshooting

The problems described below are not always caused by malfunctions. Check the TV again before having the TV serviced.

Problem	Possible Solution
<ul style="list-style-type: none"><li>No power.</li></ul>	<ul style="list-style-type: none"><li>Check if you pressed <b>POWER</b> on the remote control unit. (See page 16.) If the indicator on the TV lights up red, press <b>POWER</b>.</li><li>Is the AC cord disconnected? (See page 9.)</li><li>Has the power been turned on? (See page 16.)</li></ul>
<ul style="list-style-type: none"><li>Unit cannot be operated.</li></ul>	<ul style="list-style-type: none"><li>External influences such as lightning, static electricity, etc., may cause improper operation. In this case, operate the unit after first turning the power off the TV or unplugging the AC cord and re-plugging it in after 1 or 2 minutes.</li></ul>
<ul style="list-style-type: none"><li>Remote control unit does not operate.</li></ul>	<ul style="list-style-type: none"><li>Are batteries inserted with polarity (+, -) aligned? (See page 15.)</li><li>Are batteries worn out? (Replace with new batteries.)</li><li>Are you using it under strong or fluorescent lighting?</li><li>Is a fluorescent light shining on the remote control sensor?</li></ul>
<ul style="list-style-type: none"><li>Picture is cut off.</li></ul>	<ul style="list-style-type: none"><li>Is the image position correct? (See page 36.)</li><li>Are screen mode adjustments such as picture size made correctly? (See pages 31, 32 and 57.)</li></ul>
<ul style="list-style-type: none"><li>Strange colour, light colour, or dark, or colour misalignment.</li></ul>	<ul style="list-style-type: none"><li>Adjust the picture tone. (See pages 34 to 36.)</li><li>Is the room too bright? The picture may look dark in a room that is too bright.</li><li>Check the colour system setting. (See pages 23 and 50.)</li><li>Check the input signal setting. (See page 59.)</li><li>Check the HDMI Auto View setting. (See page 47.)</li></ul>
<ul style="list-style-type: none"><li>Power is suddenly turned off.</li></ul>	<ul style="list-style-type: none"><li>The unit's internal temperature has increased. Remove any objects blocking the vent or clean.</li><li>Check the power control setting. (See page 30.)</li><li>Is the sleep timer set? (See page 30.)</li></ul>
<ul style="list-style-type: none"><li>No picture.</li></ul>	<ul style="list-style-type: none"><li>Is the connection to external equipment correct? (See pages 12 and 13.)</li><li>Has the input signal setup been performed correctly after connection? (See page 59.)</li><li>Is the correct input selected? (See page 50.)</li><li>Is the picture adjustment correct? (See pages 34 to 36.)</li><li>Is the antenna connected properly? (See page 9.)</li><li>Is "On" selected in "Audio Only"? (See page 26.)</li></ul>
<ul style="list-style-type: none"><li>No sound.</li></ul>	<ul style="list-style-type: none"><li>Is the volume too low? (See page 21.)</li><li>Make sure that headphones are not connected. (See page 6.)</li></ul>
<ul style="list-style-type: none"><li>The TV sometimes makes a cracking noise.</li></ul>	<ul style="list-style-type: none"><li>This is not a malfunction. This happens when the cabinet slightly expands and contracts according to changes in temperature. This does not affect the TV's performance.</li></ul>

## Troubleshooting-Digital broadcasting

The error message about reception of broadcast

The example of an error message displayed on a screen	Error code	Possible Solution
<ul style="list-style-type: none"><li>Failed to receive broadcast.</li></ul>	<b>E202</b>	<ul style="list-style-type: none"><li>Check the antenna cable. Check that the antenna is correctly setup.</li></ul>
<ul style="list-style-type: none"><li>No broadcast now.</li></ul>	<b>E203</b>	<ul style="list-style-type: none"><li>Check the broadcast time in the program guide.</li></ul>

### Cautions regarding use in high and low temperature environments

- When the unit is used in a low temperature space (e.g. room, office), the picture may leave trails or appear slightly delayed. This is not a malfunction, and the unit will recover when the temperature returns to normal.
- Do not leave the unit in a hot or cold location. Also, do not leave the unit in a location exposed to direct sunlight or near a heater, as this may cause the cabinet to deform and the LCD panel to malfunction.  
Storage temperature: -20°C to +60°C.

## Error messages about recording using AQUOS LINK

The example of an error message displayed on a screen	Error code	Possible Solution
Failed to record Cannot record the broadcast.	<b>S05</b>	Check the content (broadcast or programme) or the recording medium such as HDD or DVD. Either the content or the recording medium may be incompatible.
Failed to record Cannot record the broadcast.	<b>S06</b>	This network cannot be recorded. Use the recording function of your recording device, not the AQUOS LINK function.
Failed to record Cannot record the broadcast.	<b>S07</b>	
Failed to record	<b>S09</b>	Use the recording function of your recording device, not the AQUOS LINK function.
Failed to record	<b>S10</b>	
Failed to record	<b>S11</b>	
Failed to record	<b>S12</b>	
Failed to record Cannot record the programme.	<b>S13</b>	Check the content (broadcast or programme). It may be incompatible.
Failed to record Cannot record the programme.	<b>S14</b>	
Failed to record No record media available.	<b>S16</b>	Check the recording medium.
Failed to record Cannot record while playback.	<b>S17</b>	Stop playback and set up the recording again.
Failed to record Cannot record while recording other programme.	<b>S18</b>	During recording, another recording is not possible.
Failed to record No record media available.	<b>S19</b>	Check the recording medium. Writing to the medium is prohibited.
Failed to record Cannot record while not receiving broadcast.	<b>S20</b>	Please check if the settings are properly set. Broadcasts are not receivable.
Failed to record No record media available.	<b>S21</b>	Recording to the medium is not possible. Check the recording medium.
Failed to record No recordable memory available.	<b>S22</b>	Check the capacity of the recording medium.
Failed to record Age limitation is set.	<b>S23</b>	Deactivate the child lock and set up the recording again.
Failed to record Cannot record with the recorder.	<b>S31</b>	Check your recording device.



### Reset

If complex adjustments are made and the settings cannot be restored to normal, you can reset the settings to the factory preset values.

**1** Press **MENU** and the MENU screen displays.

**2** Press **◀/▶** to select "Setup".

**3** Press **▲/▼** to select "Reset", and then press **ENTER**.

**4** If you have already set the password, enter it here.

- "Return to factory pre-settings" displays on the screen.

**5** Press **◀/▶** to select "Yes", and then press **ENTER**.

- "Now, TV will restart automatically. OK?" displays on the screen.

**6** Press **◀/▶** to select "Yes", and then press **ENTER**.

- "Now initialising..." displays on the screen and blinks.
- After the reset has completed, the power shuts off and then comes back on. The screen will have returned to its original settings.

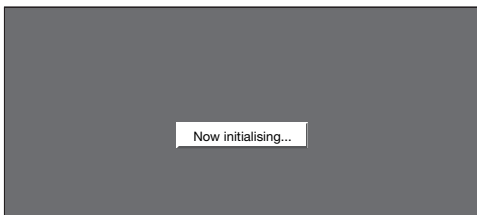

#### NOTE

- If you execute "Reset", all the settings such as Picture, Audio, Programme and Language will be reset to the factory preset values.

### Information

#### Message List

When a new broadcast station is detected, the message is updated in the "Message List" of the "Information" menu.

#### Receiver Report

Display reports regarding failures and changes for timer settings.

#### Identification

You can check the current version of the software on the screen.

## Specifications

Item		Model	LC-65RX1X
LCD panel		65" (1639 mm) Advanced Super View & BLACK TFT LCD	
Resolution		2,073,600 pixels (1920×1080)	
Video Colour System		PAL/SECAM/NTSC 3.58/NTSC 4.43/PAL 60	
TV Function	TV-Standard	Analogue	PAL: B/G, D/K, I SECAM: B/G, D/K, K/K <sup>1</sup>
		Digital	DVB-T
	Receiving Channel	VHF/UHF	44.25—863.25 MHz
		CATV	S1—S41ch (including Hyperband)
	TV-Tuning System	Auto Preset 99 ch	
STEREO/BILINGUAL		NICAM: B/G, I, D/K A2 stereo: B/G	
Brightness		450 cd/m <sup>2</sup>	
Backlight life		60,000 hours (at Backlight Standard position)	
Viewing angles		H : 176° V : 176°	
Audio amplifier		7.5W × 2 + 15W	
Speakers		10 × 4cm 2pcs, Ø2cm 2pcs, Ø5.5cm 1pc	
Terminals	Rear	Antenna input	UHF/VHF 75 Ω DIN type
		INPUT 1	VIDEO in, AUDIO in, COMPONENT in (480I, 576I, 480P, 576P, 720P/50Hz, 720P/60Hz, 1080I/50Hz, 1080I/60Hz)
		INPUT 2	VIDEO in, AUDIO in, COMPONENT in (480I, 576I, 480P, 576P, 720P/50Hz, 720P/60Hz, 1080I/50Hz, 1080I/60Hz)
	Side	INPUT 3	S-VIDEO in, VIDEO in, AUDIO in
		INPUT 4	HDMI (HDMI input) (480I, 576I, 480P, 576P, 720P/50Hz, 720P/60Hz, 1080I/50Hz, 1080I/60Hz, 1080P/50Hz, 1080P/60Hz, 1080P/24Hz)
	Rear	INPUT 5	HDMI (HDMI input) (480I, 576I, 480P, 576P, 720P/50Hz, 720P/60Hz, 1080I/50Hz, 1080I/60Hz, 1080P/50Hz, 1080P/60Hz, 1080P/24Hz)
		INPUT 6	HDMI (HDMI input) (480I, 576I, 480P, 576P, 720P/50Hz, 720P/60Hz, 1080I/50Hz, 1080I/60Hz, 1080P/50Hz, 1080P/60Hz, 1080P/24Hz), AUDIO in (Ø 3.5 mm jack)
		INPUT 7 (PC input)	15 pin mini D-sub, AUDIO in (Ø 3.5 mm jack)
		MONITOR OUT	VIDEO out, AUDIO out
		RS-232C	9 pin D-sub male connector
		DIGITAL AUDIO OUTPUT	Optical Digital Audio output
	Front	Headphone	
	OSD language		English/Simplified Chinese/Traditional Chinese/Arabic
Power Requirement		AC 110-240 V, 50/60 Hz	
Power Consumption		481 W (0.5 W Standby)*	
Weight	without stand	62.0 kg	
	with stand	66.0 kg	
Operating Temperature		0°C - 40°C	

• As a part of policy of continuous improvement, SHARP reserves the right to make design and specification changes for product improvement without prior notice. The performance specification figures indicated are nominal values of production units. There may be some deviations from these values in individual units.

\* Standby power consumption is approx. 45W for 15-30 minutes after the TV is turned off by the remote control. This is required for automatically capturing EPG data for all tuned digital channels.

### Optional accessory

The listed optional accessory is available for the LCD colour TV. Please purchase it at your nearest shop.

• Additional optional accessories may be available in the near future. When purchasing, please read the newest catalogue for compatibility and check the availability.

Part name	Model number
Wall mount bracket (for LC-65RX1X)	AN-65AG1

Dimensional drawings

Unit: mm

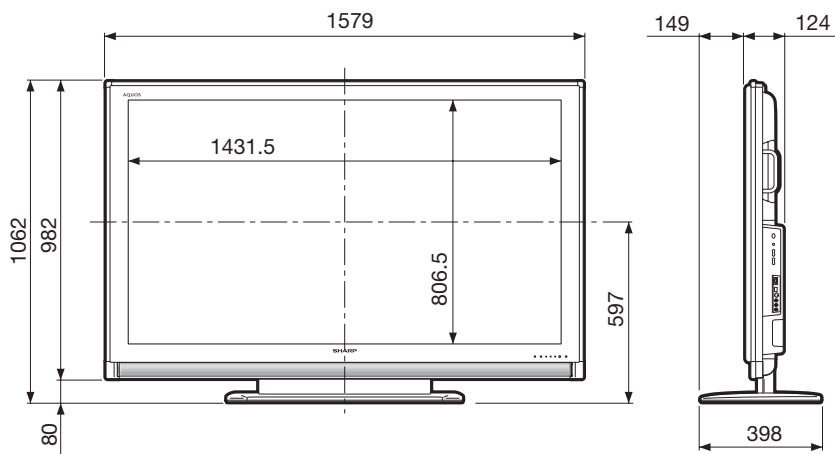

When using wall mount bracket AN-65AG1

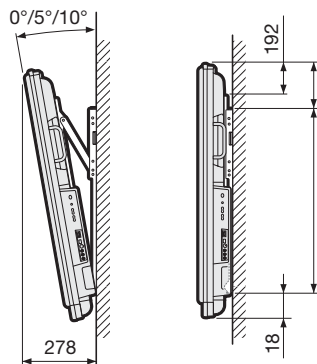
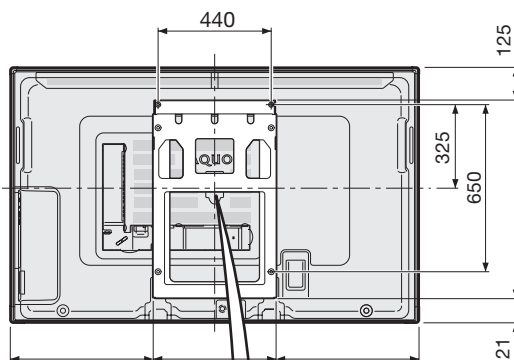
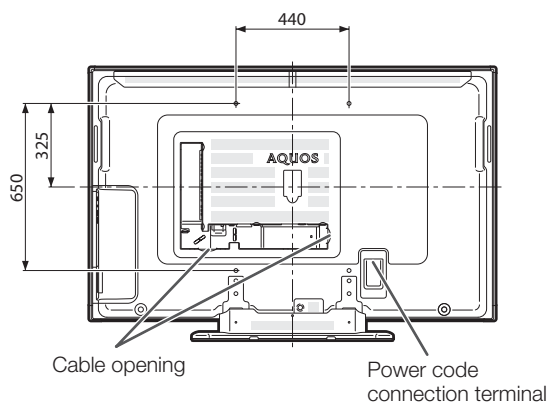

On the wall bracket of AN-65AG1, there is a letter 'A' indicating the centre point of the TV monitor.

The diagram shows two views of the wall bracket. The first view shows the bracket with a callout pointing to a specific location. The second view shows the bracket with a callout pointing to a specific location. The callouts are labeled 'A' and 'B'.

## Mounting the TV on the wall

### Removing the stand

For wall mounting with the optional bracket (AN-65AG1), remove the stand.

#### Before detaching/attaching the stand

- Before detaching (or attaching) the stand, unplug the AC cord from the AC outlet.
- Remove all terminal covers and connected cables.
- Lay the TV down on cushioning (such as a blanket) over a table.
- Make sure two or more people perform the operation.

#### CAUTION

- Do not remove the stand from the TV unless using an optional bracket to mount it.

1

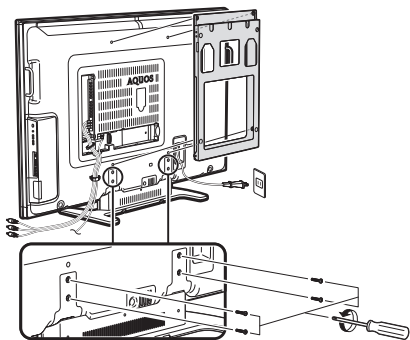

- ① Unfasten the four screws used to secure the stand in place.
- ② Attach the wall mount brackets.

2

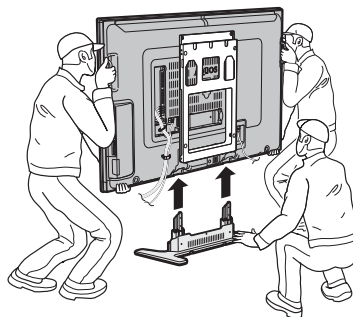

- ① Detach the stand from the TV. (Hold the stand so it will not drop from the edge of the base area.)
- ② Make sure to detach the TV with it tilted slightly backwards and supporting the knobs on the rear of the TV while holding the stand.
- ③ Don't push hard on the speaker cover portion of the TV.

3

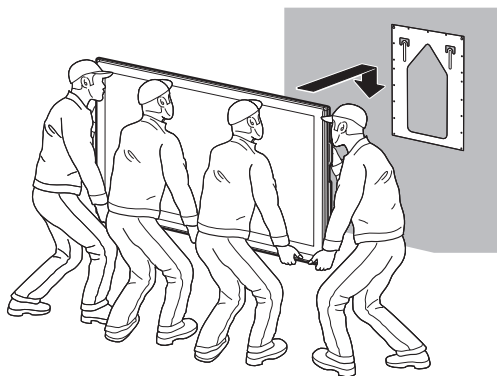

Set the TV on the wall.  
As the TV is very heavy, be careful not to drop it on a hard floor or on your foot.

#### NOTE

- To attach the stand, perform the above steps in reverse order.

### Handling and precautions with the wall-mounted TV

- You can mount the TV on the wall using the optional AN-65AG1 bracket.
- For details, refer to the instructions supplied with the optional bracket.

#### CAUTION

- **This TV should be mounted on the wall only with the AN-65AG1 (SHARP) wall mount bracket. The use of other wall mount brackets may result in an unstable installation and may cause serious injuries.**
- **Installing the Liquid Crystal Television requires special skill that should only be performed by qualified service personnel. Customers should not attempt to do the work themselves. SHARP bears no responsibility for improper mounting or mounting that results in accident or injury.**

### Using an optional bracket to mount the TV

- You can ask a qualified service personnel about using an optional AN-65AG1 bracket to mount the TV to the wall.
- Carefully read the instructions that come with the bracket before beginning work.

#### Hanging on the wall

AN-65AG1 wall mount bracket.  
(See the bracket instructions for details.)

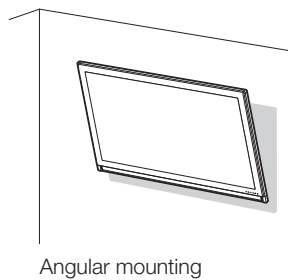
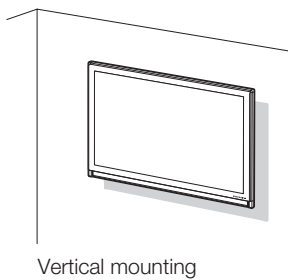

#### About setting the TV angle



#### NOTE

- Detach the cable clamps on the rear of the TV when using the optional mount bracket.

### Wall mounting

- 1 Mark the monitor's outline by placing tape at four points on the wall where the LCD-TV's four corners' will lie when it is installed.**
  - When you mark the monitor's outline on the wall, make sure that the vertical and horizontal lines are made accurate to the TV's dimension.
  - Use adhesive tape that will not leave permanent marks.
- 2 Make diagonal lines from the four corners and mark their intersecting point.**
  - Diagonally stretch string and mark the intersecting point in a way that no permanent marks will be left on the wall.
- 3 Mount the bracket on the wall by positioning the bracket's mark that indicates the display's centre onto the intersecting point.**
  - The following measurement figures are rough estimates. The figures differ according to the location where you attach the TV.
- 4**
  - ① **Remove the screws from the stand.**
  - ② **Attach the bracket to the LCD-TV.**
  - ③ **When adjusting the bracket's angle, adjust it before installing the TV on the wall.**
    - The adjusting angles of AN-65AG1 are 0°, 5°, 10°.
  - ④ **Lift the TV, remove it from the stand and attach it to the bracket.**
    - Attach the TV by aligning the monitor's four corners with the wall markings.
    - When you adjust the TV's angle, make sure to remove the monitor from the wall.
- 5 Remove the tape and the string from the wall.**

#### NOTE

- The above description is for reference. Please mount the TV in a way which properly suits the location.

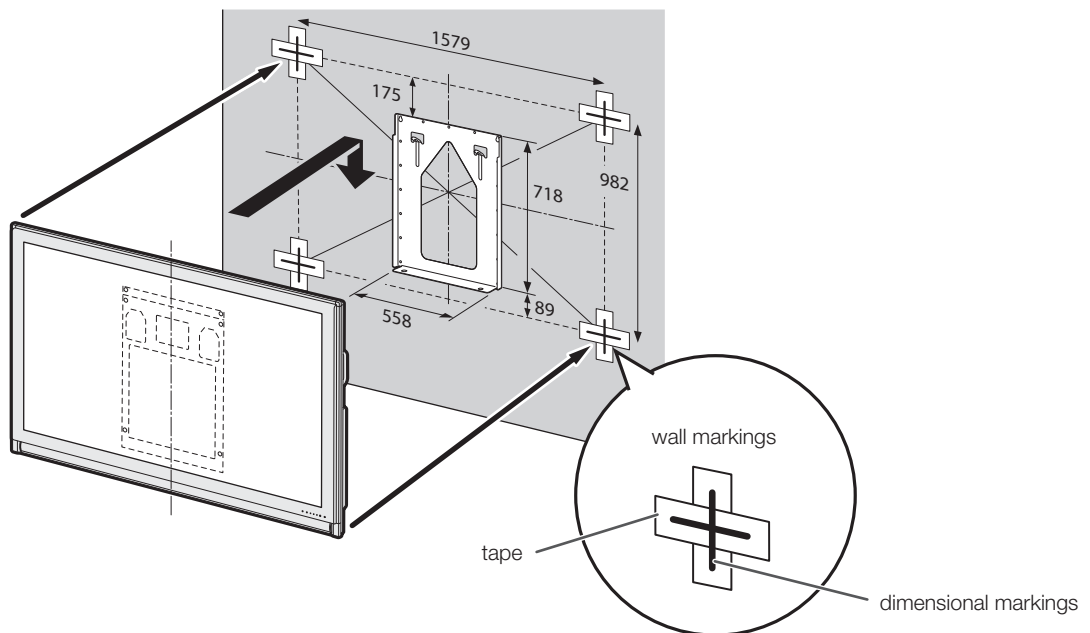

## CLEARING THE PASSWORD

If you forget the password, clear the password using the following procedure.

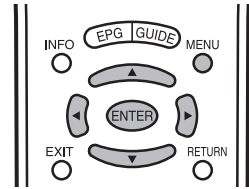

**1** Press **MENU** to display the MENU screen, and then press ◀▶ to select "Setup".

**2** Press ▲/▼ to select "Auto Installation", "Programme Setup", "Child Lock", "Reset", and the password input screen displays.

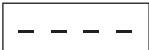

**3** Press and hold both **CH▲** and **VOL+** on the TV simultaneously until the message appears on the screen.

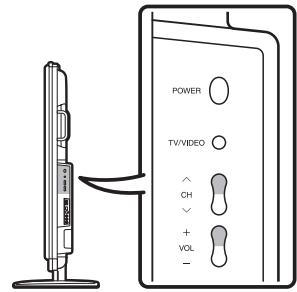

The Password is

--	--	--	--

**NOTE**

- As a precautionary measure, make a note of your password above, remove it from this manual, and keep it in a familiar place.

### Information on the software license for this product

#### Software composition

The software included in this product is comprised of various software components whose individual copyrights are held by SHARP or by third parties.

#### Software developed by SHARP and open source software

The copyrights for the software components and various relevant documents included with this product that were developed or written by SHARP are owned by SHARP and are protected by the Copyright Act, international treaties, and other relevant laws. This product also makes use of freely distributed software and software components whose copyrights are held by third parties. These include software components covered by a GNU General Public License (hereafter GPL), a GNU Lesser General Public License (hereafter LGPL) or other license agreement.

#### Obtaining source code

Some of the open source software licensors require the distributor to provide the source code with the executable software components. GPL and LGPL include similar requirements. For information on obtaining the source code for the open source software and for obtaining the GPL, LGPL, and other license agreement information, visit the following website:

<http://www.sharp.net.au/>

We are unable to answer any questions about the source code for the open source software. The source code for the software components whose copyrights are held by SHARP is not distributed.

#### Acknowledgements

The following open source software components are included in this product:

- linux kernel
- modutils
- glibc
- zlib
- libpng



# Memo

---

# Memo

---

# SHARP

FOR LOCATION ENQUIRIES WITHIN

## AUSTRALIA

REGARDING YOUR LOCAL

**SHARP APPROVED SERVICE CENTRE**

VISIT OUR WEBSITE AT

**[www.sharp.net.au](http://www.sharp.net.au)**

OR CALL SHARP CUSTOMER CARE

**1300 135 022**

(LOCAL CALL COST APPLY WITHIN AUSTRALIA)

SHARP CORPORATION OF AUSTRALIA PTY LTD

# SHARP

FOR LOCATION ENQUIRIES WITHIN

## NEW ZEALAND

REGARDING YOUR LOCAL

**SHARP APPROVED SERVICE CENTRE**

VISIT OUR WEBSITE AT

**[www.sharp.net.nz](http://www.sharp.net.nz)**

CONTACT YOUR SELLING DEALER/RETAILER

OR CALL

**SHARP CUSTOMER SERVICES**

TELEPHONE: 09 573 0111

FACSIMILE: 09 573 0113

SHARP CORPORATION OF NEW ZEALAND LIMITED

# SHARP

## WARRANTY

### *Consumer Electronic Products*

#### Congratulations on Your Purchase!

This Sharp product is warranted against faults in materials and manufacture for a period of twelve (12) months from the date of original purchase.

If service is required during the warranty period, please contact your nearest Sharp Approved Service Centre. These repairs would be carried out at no charge to the owner, subject to the conditions specified herein.

The owner is responsible for any transportation and insurance costs if the product has to be returned for repair.

This warranty does not extend to accessories or defects or injuries caused by or resulting from causes not attributable to faulty parts or the manufacture of the product, including but not limited to, defect or injury caused by or resulting from misuse, abuse, neglect, accidental damage, improper voltage, liquid spillage, vermin infestation, software, or any alterations made to the product which are not authorised by Sharp.

Please retain your sales documentation, as this should be produced to validate a warranty claim.

This warranty is in addition to and in no way limits, varies or excludes any express and implied rights and remedies under any relevant legislation in the country of sale.

#### IMPORTANT

#### DO NOT RETURN THIS DOCUMENT TO SHARP

For your reference, please enter the particulars of your purchase below and retain, with your purchase documentation.

Model No. \_\_\_\_\_

Serial No. \_\_\_\_\_

Date of Purchase \_\_\_\_\_

Retailer \_\_\_\_\_

**SHARP**  
SHARP CORPORATION OF AUSTRALIA PTY. LIMITED  
ABN 40 003 039 405  
1 Hummingwood Drive  
Huntingwood NSW2148  
SHARP CORPORATION OF NEW ZEALAND LIMITED  
59 Hugo Johnston Drive  
Penrose, Auckland  
SPform030 (JUNE 2004)

IMPORTANT NOTICE: This warranty applies only to products sold in Australia & New Zealand

# SHARP®

## SHARP CORPORATION

Printed in Malaysia  
TINS-D749WJZZ  
08P07-MA-NG

## Free Manuals Download Website

<http://myh66.com>

<http://usermanuals.us>

<http://www.somanuals.com>

<http://www.4manuals.cc>

<http://www.manual-lib.com>

<http://www.404manual.com>

<http://www.luxmanual.com>

<http://aubethermostatmanual.com>

Golf course search by state

<http://golfingnear.com>

Email search by domain

<http://emailbydomain.com>

Auto manuals search

<http://auto.somanuals.com>

TV manuals search

<http://tv.somanuals.com>