

SHARP®

QS-1760H

QS-2760H

QS-2770H

**ELECTRONIC PRINTING CALCULATOR
CALCULADORA IMPRESORA ELECTRÓNICA**

**OPERATION MANUAL
MANUAL DE MANEJO**

ENGLISH	Page	2
CALCULATION EXAMPLES	Page	28
ESPAÑOL	Página	15
EJEMPLOS DE CÁLCULOS	Página	28

This device complies with Part 15 of the FCC Rules. Operation is subject to the following two conditions: (1) This device may not cause harmful interference, and (2) this device must accept any interference received, including interference that may cause undesired operation.

WARNING - FCC Regulations state that any unauthorized changes or modifications to this equipment not expressly approved by the manufacturer could void the user's authority to operate this equipment.

Note: This equipment has been tested and found to comply with the limits for a Class B digital device, pursuant to Part 15 of the FCC Rules.

These limits are designed to provide reasonable protection against harmful interference in a residential installation. This equipment generates, uses, and can radiate radio frequency energy and, if not installed and used in accordance with the instructions, may cause harmful interference to radio communications. However, there is no guarantee that interference will not occur in a particular installation. If this equipment does cause harmful interference to radio or television reception, which can be determined by turning the equipment off and on, the user is encouraged to try to correct the interference by one or more of the following measures:

- Reorient or relocate the receiving antenna.
- Increase the separation between the equipment and receiver.
- Connect the equipment into an outlet on a circuit different from that to which the receiver is connected.
- Consult the dealer or an experienced radio/TV technician for help.

Caution!

The socket outlet shall be installed near the equipment and shall be easily accessible.

Aviso!

El tomacorriente debe estar instalado cerca del equipo y debe quedar bien accesible.

QS-2770H

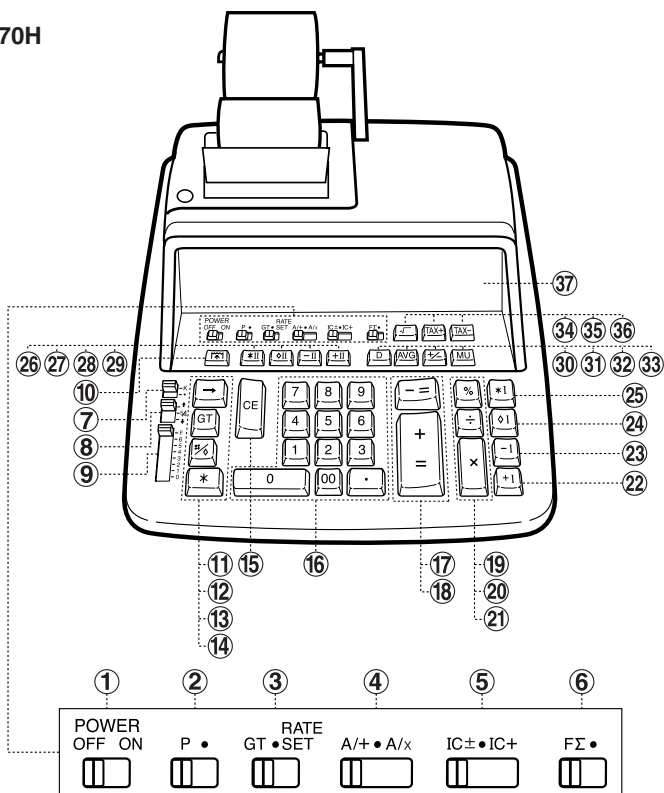

⑥, ⑩ : QS-2770H only
 Sólo en la QS-2770H

QS-1760H
 QS-2760H



INTRODUCTION

Thank you for your purchase of the SHARP electronic calculator, model QS-1760H/2760H/2770H. Your SHARP calculator is specially designed to save work and increase efficiency in all business applications and general office calculations. Careful reading of this manual will enable you to use your new SHARP to its fullest capability.

OPERATIONAL NOTES

To insure trouble-free operation of your SHARP calculator, we recommend the following:

1. The calculator should be kept in areas free from extreme temperature changes, moisture, and dust.
2. A soft, dry cloth should be used to clean the calculator. Do not use solvents or a wet cloth.
3. Turn off the power switch prior to connecting or disconnecting the AC cord.
4. Since this product is not waterproof, do not use it or store it where fluids, for example water, can splash onto it. Raindrops, water spray, juice, coffee, steam, perspiration, etc. will also cause malfunction.
5. If you pull out the power cord to cut electricity completely, the presently stored tax rate will be cleared.
6. If service should be required on this equipment, use only a SHARP servicing dealer, a SHARP approved service facility or SHARP repair service where available.
7. Do not wind the AC cord around the body or otherwise forcibly bend or twist it.

Note: Unless otherwise specified, the text material applies to all three models.

SHARP will not be liable nor responsible for any incidental or consequential economic or property damage caused by misuse and/or malfunctions of this product and its peripherals, unless such liability is acknowledged by law.













WARNING

THE VOLTAGE USED MUST BE THE SAME AS SPECIFIED ON THIS CALCULATOR. USING THIS CALCULATOR WITH A VOLTAGE HIGHER THAN THAT SPECIFIED IS DANGEROUS AND MAY RESULT IN A FIRE OR OTHER TYPE OF ACCIDENT CAUSING DAMAGE. SHARP WILL NOT BE HELD RESPONSIBLE FOR ANY DAMAGE RESULTING FROM USE OF THIS CALCULATOR WITH OTHER THAN THE SPECIFIED VOLTAGE.

CONTENTS

	Page
• OPERATING CONTROLS	3
• INK RIBBON REPLACEMENT	11
• PAPER ROLL REPLACEMENT	12
• ERRORS	13
• DECIMAL SYSTEM	13
• SPECIFICATIONS	14
• CALCULATION EXAMPLES	28
• TAX RATE CALCULATIONS	45
• SAMPLE APPLICATIONS	47

OPERATING CONTROLS

- ①  **POWER SWITCH:**
When the power switch is turned on, the calculator is ready for operation.
- ②  **PRINT MODE SELECTOR:**
“P” position: The calculator functions as a print/display calculator. (Print mode)
“•” position: The calculator functions as a display calculator. (Non-print mode)
- Mode change print:**
When changing the print mode selector, the following print will appear.
“••• ••• -P” (red print): When changing the selector from P to •.
“••• ••• +P” (red print): When changing the selector from • to P.
- ③  **GRAND TOTAL / RATE SETTING MODE SELECTOR:**
“GT” position: This selector will accumulate the following:
(The symbol “*+” will be printed.)
1. Addition and subtraction totals obtained with the  or  key.
2. Product and quotient totals obtained with the  or  key.
3. Answers obtained with the  or  key.
“•” position: Neutral, GT OFF
“RATE SET” position: • Enter the adding tax rate, then press .
• To store a discount rate, press  before pressing .

- A maximum of 4 digits can be stored (decimal point is not counted as a digit).

- Note:
- Be sure to set this selector to the “•” position after storing an each rate.
 - Only one rate can be stored. If you enter a new rate, the previous rate will be cleared.

④ $\frac{A/+}{\bullet} \bullet \frac{A/x}{\bullet}$

ADD MODE SELECTOR:

“A/+” position – **Effective only in addition and subtraction:**

Use of the A/+ mode permits addition and subtraction of numbers without an entry of the decimal point. When the A/+ mode is activated, the decimal point is automatically positioned according to the decimal selector setting.

EXAMPLES: Set $\frac{A/+}{\bullet} \bullet \frac{-A/x}{\bullet}$ to A/+

A. Set decimal to 2

Enter 123456 $\left[\frac{\pm}{\pm} \right]$ Tape prints 1·234·56 +

B. Set decimal to 3

Enter 123456 $\left[\frac{\pm}{\pm} \right]$ Tape prints 123·456 +

Use of the $\left[\frac{\square}{\square} \right]$, $\left[\times \right]$, and $\left[\div \right]$ keys will automatically override the Add mode and decimally correct answers will be printed at the preset decimal position.

EXAMPLES: Set $\frac{A/+}{\bullet} \bullet \frac{-A/x}{\bullet}$ to A/+, 5/4

A. Set decimal to 2

Enter .1234 $\left[\times \right]$ Tape prints 0·1234 ×
 100 $\left[\frac{\pm}{\pm} \right]$ 100· =
 12·34 *

B. Set decimal to 3

Enter 2 $\left[\div \right]$ Tape prints 2· ÷
 3 $\left[\frac{\pm}{\pm} \right]$ 3· =
 0·667 *

C. Set decimal to 2

Enter 123 $\left[\frac{\pm}{\pm} \right]$ Tape prints 1·23 +
 10 $\left[\frac{\pm}{\pm} \right]$ 10·00 +
 \uparrow $\left[* \right]$ 11·23 *

Note that decimal point was entered.

“A/x” position – **Multiplication and division:**

When the A/x mode is activated, the number entered before $\left[\times \right]$ or $\left[\div \right]$ key will override the add mode. But the

number entered following $\boxed{\times}$ or $\boxed{\div}$ key and before $\boxed{\pm}$ (or $\boxed{-=}$, $\boxed{+I}$, $\boxed{-I}$, $\boxed{-II}$, $\boxed{+II}$) key will obey the decimal setting. This is useful for invoicing.

EXAMPLE: Set $A/+ \bullet -A/x$ to A/x

Set decimal to 2

Enter	7	$\boxed{\times}$	Tape prints	7 · ×
	3	$\boxed{\pm}$		0.03 =
				0.21 *

Note: Use of the $\boxed{\bullet}$ key will automatically override the A/x mode.

Addition and subtraction:

The A/x mode functions same as the $A/+$ mode.

“•” position: Neutral

⑤ $\boxed{IC\pm \bullet IC+}$

ITEM COUNT MODE SELECTOR:

“ $IC\pm$ ” position: 1) The counter will count the number of times that the $\boxed{\pm}$ key has been pressed in addition.

Note: • Each time the $\boxed{-=}$ key is used in subtraction, 1 will be subtracted from the count.

- The count is printed when the calculated result is obtained.
- Pressing of the $\boxed{[*]}$, $\boxed{\times}$, $\boxed{\div}$, \boxed{AVG} or \boxed{MU} key clears the counter.

2) When the grand total mode selector is in the ON position (GT), the counter will count the number of times that the calculation results have been stored in the grand total memory. To print and clear the count, press the \boxed{GT} key.

3) The memory item counter will count the number of times that the $\boxed{+I}$ key has been pressed in the addition.

Note: • Each time the $\boxed{-I}$ key is used in the subtraction, 1 will be subtracted from the count.

- The count is printed when the memory is recalled.
- Pressing of the $\boxed{[*]}$ key clears the counter.

“ $IC+$ ” position: 1) The counter will count the number of times that the $\boxed{\pm}$ or $\boxed{-=}$ has been pressed in addition and subtraction.

Note: • The count is printed when the calculated result is obtained.

- Pressing of the $\boxed{*}$, $\boxed{\times}$, $\boxed{\div}$, \boxed{AVG} or \boxed{MU} key clears the counter.

2) When the grand total mode selector is in the ON position (GT), the counter will count the number of times that the calculation results have been stored in the grand total memory. To print and clear the count, press the \boxed{GT} key.

3) The memory item counter will count the number of times that the $\boxed{+1}$ or $\boxed{-1}$ key has been pressed in addition and subtraction.

Note: • The count is printed when the memory is recalled.

- Pressing of the $\boxed{*1}$ key clears the counter.

“•” position: Neutral, counter is turned off.

Note: The counter has a maximum capacity of 3 digits (up to ± 999). If the count exceeds the maximum, the counter will recount from zero.



FIRST FACTOR ACCUMULATION SELECTOR: (Only QS-2770H)

“FΣ” position: The first factor is automatically added to or subtracted from the memory. A first factor means the first number in multiplication and division and each number is printed with “×I” and “÷I” respectively.

Ex. $2 \times 3 \times 5 \div 6 =$

$\underline{12} \div 7 \times 9 =$

$\underline{-56} \times 4 \times 0.5 =$

“•” position: Neutral



CONSTANT MODE SELECTOR:

“K” position: The following constant functions will be performed:

Multiplication: The calculator will automatically remember the first number entered (the multiplicand) and the $\boxed{\times}$ instruction.

Division: The calculator will automatically remember the second number entered (the divisor) and the $\boxed{\div}$ instruction.

Add-on/Discount/Mark up:

The calculator will automatically remember the first entered number and key functions for Add-on/Discount/Mark up calculation.

“•” position: Neutral



ROUNDING SELECTOR:

“↑” position: An answer is rounded up.

“5/4” position: An answer is rounded off.

“↓” position: An answer is rounded down.

EXAMPLE: $10.005 \div 5 = 2.001$

Set decimal to 2, ↑







$10.005 \div 5 \left[\frac{\pm}{\pm} \right] \rightarrow 2.01 *$

Set decimal to 2, 5/4

$10.005 \div 5 \left[\frac{\pm}{\pm} \right] \rightarrow 2.00 *$

Note: The decimal point floats during successive calculation by the use of $\left[\times \right]$ or $\left[\div \right]$ key.

In floating decimal point system, an answer is rounded down.

- ⑨  **DECIMAL SELECTOR:**
Presets the number of decimal places in the answer.
In the “F” position, the answer is displayed in the floating decimal system.
- ⑩  **PAPER FEED KEY:**
When pressed, advances the paper roll.
Note: You can also pull the paper manually.
- ⑪  **RIGHT SHIFT KEY:**
Operation of this key in entered numbers or calculated results shifts the number one digit to the right together with the decimal point. Used for one digit correction.
- ⑫  **GRAND TOTAL KEY:**
Prints and clears the “GT” memory contents.
- ⑬  **NON-ADD/SUBTOTAL KEY:**
Non-add – When this key is pressed right after an entry of a number in the Print mode, the entry is printed on the left-hand side with the symbol “#”.
This key is used to print out numbers not subjects to calculation such as code, date, etc.
Subtotal – Used to get subtotal(s) of additions and/or subtractions. When pressed following the $\left[\frac{\pm}{\pm} \right]$ or $\left[= \right]$ key, the subtotal is printed with the symbol “◇” and the calculation may be continued.
By pressing this key even in the Non-print mode, the displayed number is printed with the symbol “P”.
- ⑭  **TOTAL KEY:**
Prints the total of addition and subtraction with the symbol “*”. This key also serves as a clear key for the calculation register and resets an error condition.

- 15 **CE** **CLEAR ENTRY KEY:**
 Clears number entered prior to use of a function key.
 Also used to clear an overflow error caused by an entry.
 Ex. $123 \times 455 \rightarrow 123 \times 456 =$
 Press 123 **x** 455 **CE** 456 **=**
- 16 **0** ~ **9** **.** **00** **NUMERAL KEYS**
- 17 **--** **MINUS EQUALS KEY:**
 Prints the entered number with a “–” symbol and subtracts the number from the contents of the calculation register. This key is also used to obtain the product/quotient in negative multiplication and division and prints it with the symbol “*”.
- 18 **±** **PLUS EQUALS KEY:**
 Prints the entered number with a “+” symbol and adds the number to the contents of the calculation register. This key is also used to obtain the results in multiplication and division and prints the product/quotient with the symbol “*”.
- 19 **%** **PERCENT KEY**
- 20 **÷** **DIVISION KEY**
- 21 **x** **MULTIPLICATION KEY**
- 22 **+I** **FIRST MEMORY PLUS KEY**
- 23 **-I** **FIRST MEMORY MINUS KEY**
- 24 **◇I** **FIRST RECALL MEMORY KEY**
- 25 ***I** **FIRST RECALL AND CLEAR MEMORY KEY**
- 26 ***II** **SECOND RECALL AND CLEAR MEMORY KEY**
- 27 **◇II** **SECOND RECALL MEMORY KEY**
- 28 **-II** **SECOND MEMORY MINUS KEY**
- 29 **+II** **SECOND MEMORY PLUS KEY**
- 30 **D** **DATE KEY: (only QS-2770H)**
 Can be used to store and display/print or recall the date or any other factor for repeated use in an application.
- 31 **AVG** **AVERAGE KEY:**
 Used to calculate the average.

32 

CHANGE SIGN KEY:

Changes the algebraic sign of a number (i.e., positive to negative or negative to positive).

33 

MULTIPLE USE KEY:

Used to perform mark-ups, percent change and automatic add-on/discount.

34 

SQUARE ROOT KEY:

To obtain a square root of a negative number, this calculator will first obtain a square root of an absolute number of the given number; the calculation result will then be converted to a negative value.

35 

TAX-INCLUDING KEY

36 

PRE-TAX KEY

37 **DISPLAY**

Display format:

(QS-1760H)

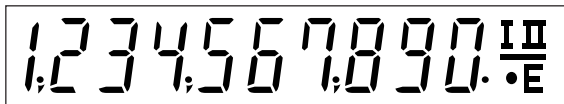

(QS-2760H)

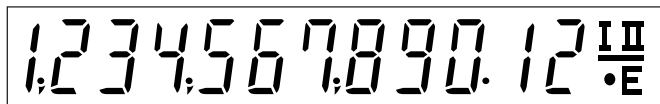

(QS-2770H)

Calculation display (main):

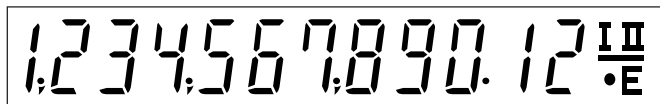

Item counter display (sub):

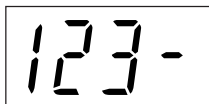

Symbols:

I : First memory symbol

Appears when a number has been stored in First memory.

II : Second memory symbol

Appears when a number has been stored in Second memory.

- : Minus symbol

Appears when a number is negative.

E : Error symbol

Appears when an overflow or other error is detected.

• : Grand total memory symbol

Appears when a number is in the grand total memory.

INK RIBBON REPLACEMENT

1. Remove the paper roll from the calculator. (Tear the paper and remove it from the print mechanism by using )
2. **Set the power switch at OFF position.**
Make sure that the print wheel has stopped.
3. Remove the printer cover by sliding it towards the back of the calculator. (Fig. 1)
4. Remove the used ribbon.
5. Install the new ribbon.
6. With the black side of the ribbon facing upwards, place one of the reels on the reel shaft on the right. Make sure that the reel is securely in place.
7. Thread the ribbon around the outside of the metal guides. (Fig. 2)
8. Insert the right reel securely.
9. Take up any slack by manually turning one of the reels.
10. Replace the printer cover.
11. Replace the paper roll.

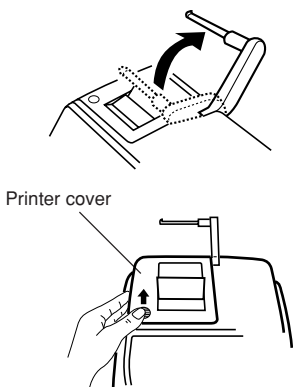

Fig. 1

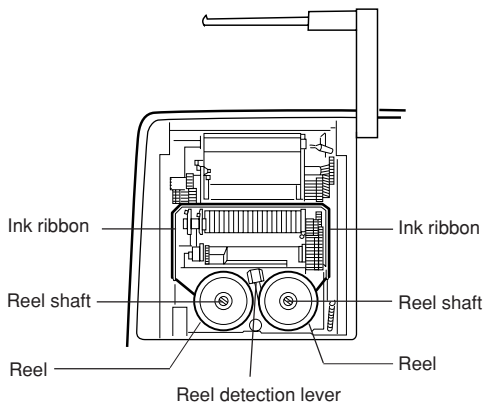
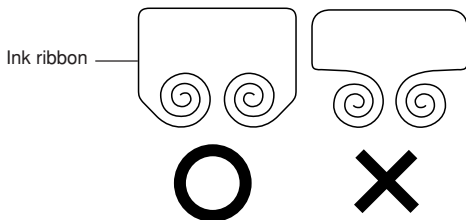

Fig. 2



PAPER ROLL REPLACEMENT

1. Lift the paper holder up. (Fig. 1)
2. Fold the leading edge of the paper roll 3 to 5 cm. (Do not fold it slantwise.) (Fig. 2)
3. Insert the paper roll from the left side of the paper holder and make sure the paper roll is set in the proper direction (with the paper feeding from the bottom). (Fig. 3)
4. Insert the leading edge of the paper into the opening directly behind the print mechanism. (Fig. 4)
5. Press the paper feed key and feed the paper under the edge of the paper cutter. (Fig. 5)

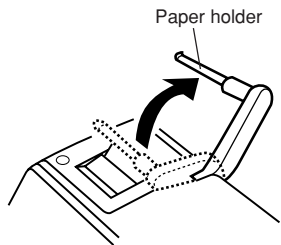

Fig. 1

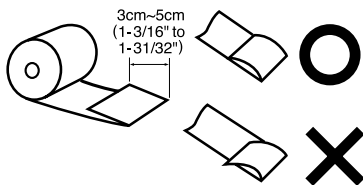

Fig. 2

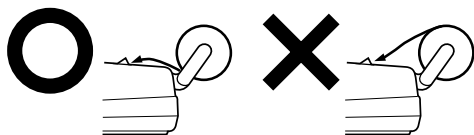

Fig. 3

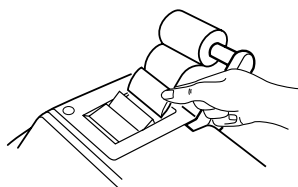

Fig. 4

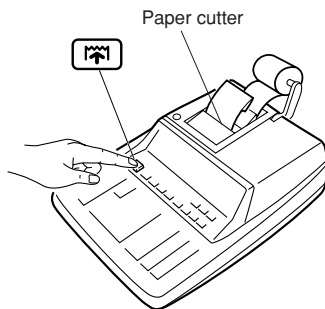

Fig. 5

DO NOT PULL THE PAPER BACKWARDS AS THIS MAY DAMAGE THE PRINTER MECHANISM.

ERRORS

There are several situations which will cause an overflow or an error condition. When this occurs, the error symbol "E" will be displayed and all keys will electronically lock. The contents of the memory at the time of the error are retained.

If an "0-E" is printed on the tape at the time of the error, the $\boxed{*}$ key must be used to clear the calculator. If an "E" with any numerals except zero is printed on the tape or if an "E" is not printed on the tape, the error may be cleared with the \boxed{CE} or $\boxed{\rightarrow}$ key and the calculation can still be continued.

Error conditions:

1. Entry of more than 10 digits or 9 decimals. (QS-1760H)
Entry of more than 12 digits or 11 decimals. (QS-2760H/2770H)
This error can be cleared with the \boxed{CE} or $\boxed{\rightarrow}$ key.
2. When the integer portion of an answer exceeds 10 digits. (QS-1760H)
When the integer portion of an answer exceeds 12 digits. (QS-2760H/2770H)
3. When the integer portion of the contents of the memory exceeds 10 digits. (QS-1760H) (Ex. $\boxed{*I}$ 9999999999 $\boxed{+I}$ 1 $\boxed{+I}$)
When the integer portion of the contents of the memory exceeds 12 digits. (QS-2760H/2770H) (Ex. $\boxed{*I}$ 999999999999 $\boxed{+I}$ 1 $\boxed{+I}$)
4. When any number is divided by zero. (Ex. $5 \boxed{\div} 0 \boxed{\frac{\pm}{\pm}}$)

DECIMAL SYSTEM

Input override decimal feature

The calculator operates on a principle of floating decimal entries with preset decimal answers.

1. An entry may contain up to 9 decimal places, regardless of the decimal selector setting. (QS-1760H)
An entry may contain up to 11 decimal places, regardless of the decimal selector setting. (QS-2760H/2770H)
2. Answers will be printed to the preset decimal position except when an underflow condition prevails.

SPECIFICATIONS

Type:	Electronic print/display calculator
Power source:	AC: 120V, 60Hz
Display:	Fluorescent display
Operating capacity:	10 digits (QS-1760H) 12 digits (QS-2760H/2770H)
Display/Print capacity:	With symbol and 3-digit punctuations 11 digits (display), 16 digits (printing) (QS-1760H) 13 digits (display), 18 digits (printing) (QS-2760H) 13 digits (main display) + 4 digits (sub display), 18 digits (printing) (QS-2770H)
Decimal point:	Automatic decimal point positioning by preset decimal selector (0–1–2–3–4–5–6–F) with Add mode (A/+, A/x)
Calculations:	Four arithmetic calculations, constant multiplication and division, power calculation, add-on/discount calculation, repeat addition and subtraction, square root calculation, reciprocal calculation, grand total calculation, item count calculation, markup calculation, average calculation, memory calculation, first factor accumulation calculation (only QS-2770H), etc.
Components:	LSI, etc.

PRINTING SECTION

Printer:	Mechanical printer
Printing speed:	Approx. 4.8 lines/sec.
Paper feed speed:	Approx. 14.4 lines/sec.
Printing paper:	57 mm (2-1/4") ~ 58 mm (2-9/32") wide 80 mm (3-5/32") in diameter (max.)
Operating temperature:	0°C ~ 40°C (32°F ~ 104°F)
Power consumption:	195 mA
Dimensions:	254 (W) × 338 (D) × 75.5 (H) mm 10-1/32" (W) × 13-5/16" (D) × 2-31/32" (H)
Weight:	Approx. 2.2 kg (4.85 lb.)
Accessories:	1 paper roll, 1 ink ribbon and operation manual

In case of abnormal conditions

When this unit is exposed to strong RF noise and/or extreme physical shock during the operation, or when the power cord is plugged into the AC outlet, the unit may start functioning abnormally which, in some rare occasions, all keys – including the power key and the **[CE]** key – cease to respond.

If such abnormal conditions are observed, unplug the AC cord from the socket. Keep the unit unplugged for about 5 seconds, reconnect the AC plug, then turn on the power.

INTRODUCCIÓN

Muchísimas gracias por haber adquirido la calculadora electrónica de SHARP modelo QS-1760H/2760H/2770H. La presente calculadora ha sido expresamente concebida con el fin de ahorrarle trabajo y lograr una mayor eficacia en todas sus aplicaciones de negocios y cálculos generales de oficina. Una atenta lectura del presente manual le permitirá usar su nueva calculadora SHARP al máximo de su capacidad.

NOTAS AL MANEJARLA

A fin de que su calculadora SHARP funcione sin averías, le recomendamos lo siguiente:

1. Evite dejar la calculadora en ambientes en que haya cambios de temperatura, humedad y polvo bastante notables.
2. Al limpiar la calculadora, utilice un paño suave y seco. No use disolventes ni tampoco un paño húmedo.
3. Antes de enchufar o desenchufar el cable de alimentación de corriente alterna, apague el interruptor de corriente.
4. Debido a que este producto no es a prueba de agua, no deberá ser utilizado o guardado en lugares donde pudiera ser salpicado por líquidos, por ejemplo agua. Gotas de lluvia, salpicaduras de agua, jugos o zumos, café, vapor, transpiración, etc. también perjudican el funcionamiento del producto.
5. Si desconecta el cable de alimentación para desconectar completamente la electricidad, la tasa de impuesto almacenada actualmente se borrará.
6. Si se requiere algún servicio técnico o reparación en este equipo, diríjase sólo a un distribuidor SHARP de reparaciones, a un centro de servicio autorizado por SHARP o a un centro de reparaciones SHARP cercano a su localidad.
7. No bobine el cable de CA alrededor de la calculadora, y no lo doble o retuerza a la fuerza.

Nota: A no ser que se especifique lo contrario las instrucciones se aplican a todos los tres modelos.

SHARP no será responsable de ningún daño imprevisto o resultante, en lo económico o en propiedades, debido al mal uso de este producto y sus periféricos, a menos que tal responsabilidad sea reconocida por la ley.

AVISO

EL VOLTAJE USADO DEBE SER EL MISMO QUE EL ESPECIFICADO EN ESTA CALCULADORA. USAR ESTA CALCULADORA CON UN VOLTAJE SUPERIOR AL ESPECIFICADO RESULTA PELIGROSO Y PUEDE CAUSAR UN INCENDIO U OTRO TIPO DE ACCIDENTE. SHARP NO SE HACE RESPONSABLE DE NINGÚN DAÑO DEBIDO AL USO DE ESTA CALCULADORA CON UN VOLTAJE DIFERENTE DEL ESPECIFICADO.

	Página
• CONTROLES DE FUNCIONAMIENTO	16
• CAMBIO DE LA CINTA ENTINTADA	24
• CAMBIO DEL ROLLO DEL PAPEL	25
• ERRORES	26
• SISTEMA DECIMAL	26
• ESPECIFICACIONES TÉCNICAS	27
• EJEMPLOS DE CÁLCULOS	28
• CÁLCULOS CON EL TIPO DE IMPUESTO	45
• EJEMPLOS DE APLICACIONES	50

CONTROLES DE FUNCIONAMIENTO

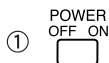

INTERRUPTOR DE CORRIENTE:

Al poner el interruptor de corriente en la posición "ON", la calculadora queda dispuesta para empezar a funcionar.



SELECTOR DEL MODO DE IMPRESIÓN:

Posición "P": La calculadora funciona como una calculadora con exhibición/impresión. (Modo de impresión)

Posición "•": La calculadora funciona como una calculadora con exhibición. (Modo de no impresión)

Impresión al cambiar el modo:

Al cambiar el selector del modo de impresión, aparecerá la siguiente impresión:





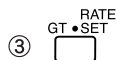

"••• ••• -P" (impresión en rojo): Cuando se cambia el selector de la posición "P" a la "•".

"••• ••• +P" (impresión en rojo): Cuando se cambia el selector de la posición "•" a la "P".



SELECTOR DEL MODO DE TOTAL GLOBAL / FIJACIÓN DE TIPOS:

Posición "GT": Este selector hará que se acumule lo siguiente:
(Se imprimirá "*+").

1. Totales de suma y resta obtenidos con la tecla  o .
2. Totales de productos y cocientes obtenidos con la tecla  o .
3. Resultados obtenidos con la tecla  o .

Posición "•": Posición neutra, total global desactivado.

- Posición " $\frac{\text{RATE}}{\text{SET}}$ ":
- Introduzca el tipo de impuesto de suma, y luego pulse $\boxed{\text{TAX+}}$.
 - Para almacenar un tipo de descuento, pulse $\boxed{+/-}$ antes de pulsar $\boxed{\text{TAX+}}$.
 - Se puede almacenar un máximo de 4 dígitos (la coma decimal no cuenta como un dígito).

- Notas:
- Asegúrese de poner este selector en la posición "•" después de almacenar cada tipo.
 - Sólo puede almacenar un tipo. Si introduce un nuevo tipo, borrará el anterior.

④ $\frac{A/+}{\square} \bullet \frac{A/x}{\square}$

SELECTOR DEL MODO DE SUMA:

Posición "A/+": **Eficaz solamente en la suma y resta:**

Utilizando el modo de suma se pueden sumar y restar números sin registrar el punto decimal. Cuando se activa el modo de suma, el punto decimal se coloca automáticamente de acuerdo con el ajuste del selector decimal.

EJEMPLOS: Colocar $\frac{A/+}{\square} \bullet \frac{-A/x}{\square}$ en A/+

A. Colocar el decimal en 2

Registrar	La cinta imprime
123456 $\boxed{\pm}$	1·234·56 +

B. Colocar el decimal en 3

Registrar	La cinta imprime
123456 $\boxed{\pm}$	123·456 +

El uso de las teclas $\boxed{\cdot}$, $\boxed{\times}$, y $\boxed{\div}$ desactivará automáticamente el modo de suma y las respuestas decimalmente correctas se imprimirán en la posición decimal prefijada.

EJEMPLOS: Colocar $\frac{A/+}{\square} \bullet \frac{-A/x}{\square}$ en A/+, 5/4

A. Colocar el decimal en 2

Registrar	La cinta imprime
.1234 $\boxed{\times}$	0·1234 ×
100 $\boxed{\pm}$	100· =
	12·34 *

B. Colocar el decimal en 3

Registrar	La cinta imprime
2 $\boxed{\div}$	2· ÷
3 $\boxed{\pm}$	3· =
	0·667 *

C. Colocar el decimal en 2

Registrar

123 $\boxed{\pm}$
10 $\boxed{\cdot}$ $\boxed{\pm}$
↑ $\boxed{*}$

La cinta imprime

1·23 +
10·00 +
11·23 *

Se introdujo el punto decimal.

Posición "A/x": **Multiplicación y división**

Cuando se activa el modo A/x, el número registrado antes de que se pulse la tecla $\boxed{\times}$ o $\boxed{\div}$ hará que sea ineficaz el modo de suma. Pero el número registrado después de haber pulsado la tecla $\boxed{\times}$ o $\boxed{\div}$ y antes de pulsar la tecla $\boxed{\pm}$ (o $\boxed{=}$, $\boxed{+I}$, $\boxed{-I}$, $\boxed{-II}$, $\boxed{+II}$) obedecerá la posición decimal colocada. Esto resulta muy práctico en facturaciones.

EJEMPLO: Colocar A/+· -A/x en A/x

Colocar el decimal en 2

Registrar

7 $\boxed{\times}$
3 $\boxed{\pm}$

La cinta imprime

7· ×
0·03 =
0·21 *

Nota: El uso de la tecla $\boxed{\cdot}$ hará que el modo A/x sea ineficaz.

Suma y resta

El modo A/x funciona de la misma manera que el modo A/+.

Posición "•": Posición neutra

⑤ $\boxed{IC\pm \bullet IC+}$

SELECTOR DE MODO PARA CONTAR ARTÍCULOS:

Posición "IC±": 1) El contador contará las veces que se ha apretado la tecla $\boxed{\pm}$ en la suma.

Nota: • Cada vez que se use la tecla $\boxed{=}$ en la resta, se restará 1 de la cuenta.

• La cuenta queda impresa cuando se obtiene el resultado calculado.

• Al apretar la tecla $\boxed{*}$, $\boxed{\times}$, $\boxed{\div}$, \boxed{AVG} o \boxed{MU} se borra el contenido del contador.

2) Cuando está activado el selector del modo del total global (posición GT), el contador contará el número de veces que se han almacenado los resultados de cálculo en la memoria del total global. Para imprimir y borrar la cuenta, apretar la tecla \boxed{GT} .

3) El contador de artículos en memoria contará el número de veces que la tecla $\boxed{+1}$ ha sido apretada en la suma.

- Notas:
- Cada vez que se use la tecla $\boxed{-1}$ en la resta, 1 será restado de la cuenta.
 - La cuenta queda impresa al llamarse la memoria.
 - Apretando la tecla $\boxed{*1}$ se borra el contador.

Posición "IC+": 1) El contador contará el número de veces que se haya pulsado la tecla $\boxed{\pm}$ o $\boxed{=}$ en la suma y la resta.

- Nota:
- La cuenta queda impresa cuando se obtiene el resultado calculado.
 - Al apretar la tecla $\boxed{*}$, $\boxed{\times}$, $\boxed{\div}$, \boxed{AVG} o \boxed{MU} se borra el contenido del contador.

2) Cuando está activado el selector del modo de total global (posición GT), el contador contará el número de veces que se han almacenado los resultados de cálculo en la memoria del total global. Para imprimir y borrar la cuenta, apretar la tecla \boxed{GT} .

3) El contador de artículos en memoria contará el número de veces que la tecla $\boxed{+1}$ o $\boxed{-1}$ ha sido apretada en la suma y resta.

- Notas:
- La cuenta queda impresa al llamarse la memoria.
 - Apretando la tecla $\boxed{*1}$ se borra el contenido del contador.

Posición "•": Posición neutra. El contador está desconectado.

Nota: El contador tiene una capacidad de un máximo de 3 cifras (hasta ± 999). Si la cuenta excede el máximo, el contador vuelve a contar partiendo de cero.

⑥ $\boxed{F\Sigma \bullet}$

SELECTOR DEL MODO DE ACUMULACIÓN DEL PRIMER FACTOR: (sólo en la QS-2770H)

Posición "FΣ": Acumulación del primer factor

El primer factor se suma o resta automáticamente a la memoria. El primer factor quiere decir el primer número en una multiplicación y división, y cada número se imprime con "×I" y "÷I" respectivamente.

EJEMPLO: $2 \times 3 \times 5 \div 6 =$
 $12 \div 7 \times 9 =$
 $-56 \times 4 \times 0,5 =$

Posición "•": Posición neutra.

**SELECTOR DEL MODO DE CONSTANTE:**

Posición "K": Se podrán realizar las siguientes funciones de constantes:

Multiplicación: La calculadora retendrá automáticamente el primer factor registrado (el multiplicando) y la instrucción $\boxed{\times}$.

División: La calculadora retendrá automáticamente el segundo factor registrado (el divisor) y la instrucción $\boxed{\div}$.

Recargo/Descuento/Aumento:

La calculadora recordará automáticamente el primer número registrado y las funciones de las teclas de cálculos de recargo/descuento/aumento.

Posición "•": Posición neutra.

**SELECTOR DE REDONDEO:**

Posición "↑": Se redondean por exceso las respuestas.

Posición "5/4": Se redondean por descarte las respuestas.

Posición "↓": Se redondean por defecto las respuestas.

EJEMPLO: $10,005 \div 5 = 2,001$

Colocar el decimal en 2, ↑

$10.005 \boxed{\div} 5 \boxed{\uparrow} \rightarrow 2.01 *$

Colocar el decimal en 2, 5/4

$10.005 \boxed{\div} 5 \boxed{\frac{5}{4}} \rightarrow 2.00 *$

Nota: El punto (= coma) decimal flota mientras se hacen cálculos sucesivos usando la tecla $\boxed{\times}$ o $\boxed{\div}$.

En el sistema de punto decimal flotante, las respuestas se redondean por defecto.

**SELECTOR DECIMAL:**

Prefija el número de lugares decimales de la respuesta.

En la posición "F", la respuesta aparecerá en la exhibición en el sistema decimal flotante.

**TECLA DE AVANCE DEL PAPEL:**

Cuando se aprieta esta tecla, el papel avanza.

Nota: También se puede tirar del papel a mano.







**TECLA DE DESPLAZAMIENTO A LA DERECHA:**

















Apretando esta tecla al registrar los números o el resultado calculado, se desplazará el número una cifra hacia la derecha junto con el punto decimal.

Se utiliza para la corrección de una cifra.

**TECLA DE TOTAL GLOBAL:**

Imprime y borra el contenido de la memoria de total global "GT".

- 13  **TECLA DE NO SUMA/TOTAL PARCIAL:**
- No-suma** – Cuando se aprieta esta tecla inmediatamente después de haber ingresado un número en el modo de impresión, el número registrado se imprime a la izquierda, junto con el símbolo “#”.
- Esta tecla se usa para imprimir números que no están sujetos a cálculos como, por ejemplo, códigos, fechas, etc.
- Total parcial** – Se usa para obtener uno o varios totales parciales de sumas y/o restas.
- Cuando se aprieta a continuación de la tecla $\frac{\pm}{=}$ o $\frac{-}{=}$, se imprimirá el total parcial junto con el símbolo “◇”, pudiéndose seguir con los cálculos.
- Al apretar esta tecla, incluso en el modo de no impresión, se imprimirá el número que aparece en la exhibición con el símbolo “P”.**
- 14  **TECLA DE TOTAL:**
- Imprime el total de la suma y resta con el símbolo “*”. Esta tecla también sirve de tecla de borrado para los registros de cálculos, y anula un estado de error.
- 15  **TECLA DE BORRADO DE ENTRADAS:**
- Sirve para cancelar un número introducido antes de utilizar una tecla de función.
- Se usa también para cancelar un error por exceso de capacidad causado por una entrada.
- Ej. $123 \times 455 \rightarrow 123 \times 456 =$
- Apretar 123 \times 455 $\frac{CE}{=}$ 456 $\frac{\pm}{=}$
- 16  **TECLAS DE LOS NÚMEROS**
- 17  **TECLA DE RESULTADO DE RESTA:**
- Imprime el número introducido con el signo “-” y resta el número a los contenidos del registro de cálculo. Esta tecla sirve también para obtener el producto/cociente en las multiplicaciones y divisiones negativas, imprimiéndolo con el símbolo “*”.
- 18  **TECLA DE RESULTADO DE SUMA:**
- Imprime el número introducido con el signo “+” y suma el número a los contenidos del registro de cálculo. Esta tecla sirve también para obtener los resultados de multiplicaciones y divisiones, imprimiendo el producto/cociente con el símbolo “*”.
- 19  **TECLA DE PORCENTAJE**

- 20  **TECLA DE DIVISIÓN**
- 21  **TECLA DE MULTIPLICACIÓN**
- 22  **TECLAS DE MENOS DE LA PRIMERA MEMORIA**
- 23  **TECLAS DE MÁS DE LA PRIMERA MEMORIA**
- 24  **TECLA DE RECUPERACIÓN DE LA PRIMERA MEMORIA**
- 25  **TECLA DE RECUPERACIÓN Y BORRADO DE LA PRIMERA MEMORIA**
- 26  **TECLA DE RECUPERACIÓN Y BORRADO DE LA SEGUNDA MEMORIA**
- 27  **TECLA DE RECUPERACIÓN DE LA SEGUNDA MEMORIA**
- 28  **TECLAS DE MÁS DE LA SEGUNDA MEMORIA**
- 29  **TECLAS DE MENOS DE LA SEGUNDA MEMORIA**
- 30  **TECLA DE FECHA: (sólo en la QS-2770H)**
Se puede usar para almacenar y exhibir/imprimir o llamar la fecha o cualquier otro factor que se utilice en forma repetida en una aplicación.
- 31  **TECLA DE PROMEDIO:**
Se usa para calcular el promedio.
- 32  **TECLA DE CAMBIO DE SIGNO:**
Cambia el signo algebraico de un número (es decir, de positivo a negativo o de negativo a positivo).
- 33  **TECLA DE USO MÚLTIPLE:**
Se usa para llevar a cabo aumentos, cambios de porcentaje y recargos/ descuentos automáticos.
- 34  **TECLA DE RAÍZ CUADRADA:**
Para obtener una raíz cuadrada de un número negativo, esta calculadora obtendrá primero una raíz cuadrada de un número absoluto del número dado; el resultado del cálculo será luego convertido a una valor negativo.
- 35  **TECLA DE INCLUSIÓN DE IMPUESTOS**
- 36  **TECLA DE ANTES DE IMPUESTOS**

37 EXHIBICIÓN

Formato de la exhibición:

(QS-1760H)

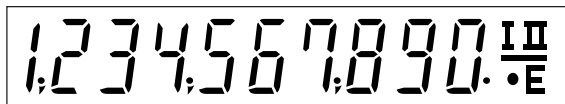

(QS-2760H)

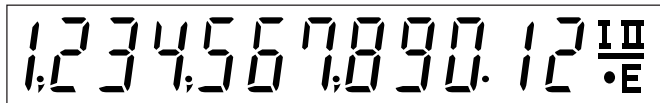

(QS-2770H)

Exhibición de los cálculos (principal):

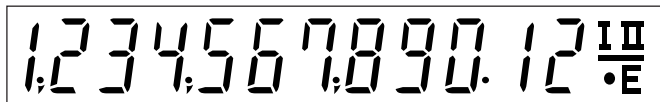

Exhibición del contador de artículos (secundaria):

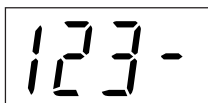

Símbolos:

- I** : **Símbolo de la primera memoria**
Aparece cuando se ha almacenado un número en la primera memoria.
- II** : **Símbolo de la segunda memoria**
Aparece cuando se ha almacenado un número en la segunda memoria.
- : **Símbolo menos**
Aparece cuando el número es negativo.
- E** : **Símbolo de error**
Aparece cuando se supera la capacidad o se detecta otro error.
- : **Símbolo del total global de la memoria**
Aparece cuando un número está en la memoria de total global.

CAMBIO DE LA CINTA ENTINTADA

1. Quitar el rollo de papel de la calculadora. (Cortar el papel y sacarlo del mecanismo impresor usando )
2. Colocar el interruptor de corriente en la posición marcada OFF.
Asegurarse de que la rueda de impresión se haya detenido.
3. Quitar la tapa de la impresora deslizando hacia la parte trasera de la calculadora. (Fig. 1)
4. Sacar la cinta usada.
5. Colocar la nueva cinta.
6. Con el lado negro de la cinta mirando para arriba, colocar uno de los carretes en el eje del carrete de la derecha. Asegurarse de que el carrete esté firmemente colocado en su lugar.
7. Pasar la cinta por la parte exterior de las guías metálicas. (Fig. 2)
8. Insertar bien el carrete de la derecha.
9. Estirar cualquier parte de cinta floja girando con la mano uno de los carretes.
10. Volver a poner la tapa de la impresora.
11. Volver a poner el rollo de papel.



Fig. 1

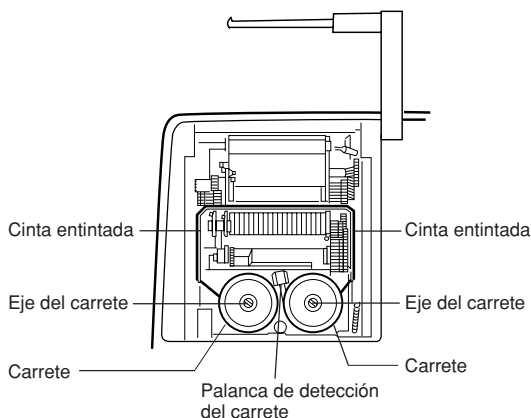
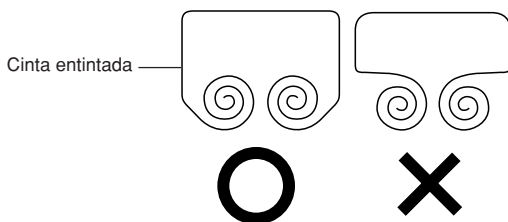

Fig. 2



CAMBIO DEL ROLLO DEL PAPEL

1. Levantar el sujetador del papel. (Fig. 1)
2. Doblar la punta del rollo de papel de 3 a 5 cm (no la doble nunca de forma oblicua). (Fig. 2)
3. Introducir el rollo de papel desde el lado izquierdo del sujetador del papel y asegurarse de que el rollo de papel esté puesto en la dirección correcta (con el avance del papel desde el fondo) tal como muestra la figura. (Fig. 3)
4. Introducir la punta doblada en la abertura directamente por detrás del mecanismo de impresión. (Fig. 4)
5. Apretar la tecla de avance del papel haciendo avanzar el papel por debajo del borde del cortapapel. (Fig. 5)

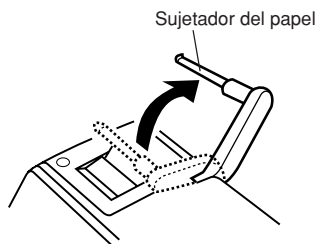

Fig. 1

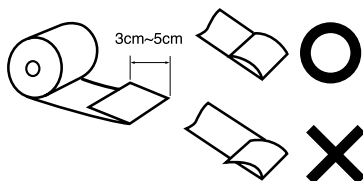

Fig. 2

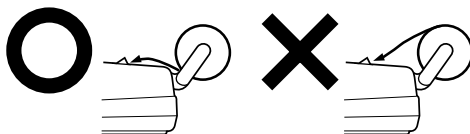

Fig. 3

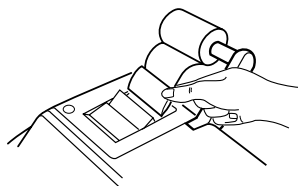

Fig. 4

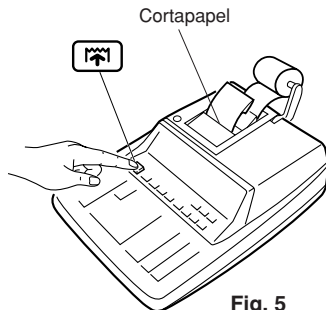

Fig. 5

NO TIRE DEL PAPEL HACIA ATRÁS PORQUE SE PUEDE ESTROPEAR EL MECANISMO IMPRESOR.

ERRORES

Existen diversos casos en los que ocurre un exceso de capacidad o una condición de error. Al producirse esto, aparecerá el símbolo de error "E" quedando electrónicamente bloqueadas todas las teclas. Los contenidos de la memoria, en el momento del error, quedan retenidos.

Si, al ocurrir el error, se imprime en la cinta el símbolo "0-E", se deberá usar la tecla $\boxed{*}$ para borrar la calculadora. Si se imprime en la cinta el símbolo "E" con cualquier número (excepto el cero) o si no se imprime en la cinta el símbolo "E", se puede borrar el error con la tecla \boxed{CE} o $\boxed{\rightarrow}$ pudiéndose continuar el cálculo.

Condiciones de error:

1. Entrada de más de 10 cifras o de 9 decimales. (QS-1760H)
Entrada de más de 12 cifras o de 11 decimales. (QS-2760H/2770H)
Este error puede borrarse con la tecla \boxed{CE} o $\boxed{\rightarrow}$.
2. Cuando la parte entera de un resultado excede las 10 cifras. (QS-1760H)
Cuando la parte entera de un resultado excede las 12 cifras. (QS-2760H/2770H)
3. Cuando la parte entera de los contenidos de la memoria supera los 10 dígitos. (QS-1760H)
(Ej. $\boxed{*1}$ 999999999 $\boxed{+1}$ 1 $\boxed{+1}$)
Cuando la parte entera de los contenidos de la memoria supera los 12 dígitos. (QS-2760H/2770H)
(Ej. $\boxed{*1}$ 999999999999 $\boxed{+1}$ 1 $\boxed{+1}$)
4. Cuando se divide un número cualquiera por un divisor de cero. (Ej. $5 \boxed{\div} 0 \boxed{\pm}$)

SISTEMA DECIMAL

Puesta de decimales suplementaria de la entrada

La calculadora funciona sobre la base de entradas con punto decimal flotante y respuestas con el punto decimal prefijado.

1. Una entrada puede tener hasta 9 lugares decimales, independientemente de la posición del selector decimal. (QS-1760H)
Una entrada puede tener hasta 11 lugares decimales, independientemente de la posición del selector decimal. (QS-2760H/2770H)
2. Las respuestas quedarán impresas hasta la posición decimal prefijada excepto cuando prevalezca una condición de exceso por debajo de la capacidad.

ESPECIFICACIONES TÉCNICAS

Tipo:	Calculadora electrónica con impresora/exhibición
Fuente de alimentación:	CA: 120V, 60Hz
Exhibición:	Exhibición fluorescente
Capacidad de cálculo:	10 cifras (QS-1760H) 12 cifras (QS-2760H/2770H)
Capacidad de exhibición/ impresión:	11 cifras (exhibición), 16 cifras (impresión) (QS-1760H) 13 cifras (exhibición), 18 cifras (impresión) (QS-2760H) 13 cifras (exhibición principal) + 4 cifras (exhibición secundaria), 18 cifras (impresión) (QS-2770H) con símbolo y puntuaciones cada 3 cifras
Punto (= coma) decimal:	Colocación del punto (= coma) decimal automática por selector decimal prefijado (0–1–2–3–4–5–6–F) con modo de suma (A/+, A/x)
Cálculos:	Las cuatro operaciones aritméticas, multiplicaciones y divisiones por constante, cálculos de potencia, cálculos de recargos/descuentos, repetición de sumas y restas, cálculos de raíz cuadrada, cálculos recíprocos, cálculos de total global, cálculos de cuenta de artículos, cálculos de aumento, cálculos de promedio, cálculos de memoria, cálculos acumulación del primer factor (sólo en la QS- 2770H), etc.
Componentes:	LSI, etc.

SECCIÓN DE LA IMPRESORA

Impresora:	Impresora mecánica
Velocidad de impresión:	Aprox. 4,8 líneas/seg.
Velocidad de avance del papel:	Aprox. 14,4 líneas/seg.
Papel de impresión:	57 mm ~ 58 mm de ancho, 80 mm de diámetro (máx.)
Temperatura de funcionamiento:	0°C ~ 40°C
Consumo de corriente:	195 mA
Dimensiones:	254 (An.) × 338 (Pr.) × 75,5 (Al.) mm
Peso:	Aprox. 2,2 kg
Accesorios:	1 rollo de papel, 1 cinta entintada y manual de manejo

En caso de condiciones anormales

Si expone esta unidad a ruido de RF intenso y/o a golpes fuertes durante la operación, o cuando enchufe el cable de alimentación en un tomacorriente de CA, la unidad puede comenzar a funcionar de forma anormal, por lo que, en algunos casos raros, todas las teclas – incluyendo la de alimentación y la tecla \boxed{CE} – pueden no ofrecer respuesta.

Si experimenta estas condiciones anormales, desenchufe el cable de alimentación de CA del tomacorriente. Deje la unidad desenchufada durante unos 5 segundos, vuelva a enchufar el cable de alimentación de CA, y después conecte la alimentación.

CALCULATION EXAMPLES EJEMPLOS DE CÁLCULOS

1. Set the decimal selector as specified in each example.
The rounding selector should be in the "5/4" position unless otherwise specified.
2. The grand total / rate setting mode selector, constant mode, add mode, item count mode and first factor accumulation selectors (QS-2770H only) should be in the "•" position (off position) unless otherwise specified.
3. Print mode selector should be in the "P" position unless otherwise specified.
4. If an error is made while entering a number, press the \boxed{CE} or $\boxed{\rightarrow}$ key and enter the correct number.
5. Negative values are printed with "-" symbol in red.

1. Colocar el selector decimal según se especifica en cada ejemplo.
El selector de redondeo debe estar en la posición "5/4" salvo que se especifique lo contrario.
2. Los selectores de modo de total global / fijación de tipos, modo de constante, modo de suma, modo para contar artículos, y modo de acumulación del primer factor (sólo en la QS-2770H) deben estar en la posición "•" (posición de desconexión) salvo que se especifique lo contrario.
3. El selector del modo de impresión debe estar en la posición "P" salvo que se especifique lo contrario.
4. Si se hace un error al ingresar un número, apretar la tecla \boxed{CE} o $\boxed{\rightarrow}$ e ingresar el número correcto.
5. Los valores negativos se imprimen con el símbolo "-" en rojo.

Note: All totals and sub-totals may be used for further calculations. **RE-ENTER** the number into the calculator by using a **FUNCTION** key and continue the problem.

Nota: Se pueden usar todos los totales y los totales parciales para cálculos posteriores. **VOLVER A INGRESAR** el número en la calculadora usando una tecla de **FUNCIÓN** y continuar efectuando la operación.

EXAMPLE: EJEMPLO:

$$(123 + 456) \times 2 =$$

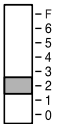
Selector Selector	Operation Operación	Print Impresión	Note Nota
	123 $\boxed{\pm}$	123.00 +	
	456 $\boxed{\pm}$	456.00 +	
	$\boxed{*}$	579.00 *	
	$\boxed{\times}$	* 579.00 ×	* { Re-entry of total Reingreso del total
	2 $\boxed{\pm}$	2. =	
		1,158.00 *	

DATE MEMORY (QS-2770H only) /**MEMORIA PARA LA FECHA (sólo en la QS-2770H)**

This machine, provided with date memory, allows date, numbers etc. to be stored once and then recalled and printed as necessary.

Note: The date memory can also be used as a constant memory.

Esta calculadora, provista de una memoria de fecha, permite almacenar en la memoria la fecha, el número, etc. una vez y luego llamarlos e imprimirlos cuando sea necesario.

Nota: La memoria de la fecha se puede utilizar también como memoria constante.

EXAMPLE: Print the date of April 5, 2003.

EJEMPLO: Imprimir el 5 de abril de 2003.

Selector Selector (1)	Operation Operación (2)	Display Exhibición (3)	Print Impresión (4)
	4.05.2003 [D]	4.05-2003	4-05-2003 (red) (rojo)
	[*]		0. *
	20 [±]	20.00	20-00 +
	30 [±]	50.00	30-00 +
	[*]		50-00 *
	[D]		4.05-2003

EXAMPLE: $2 \times 12.34 =$

EJEMPLO: $4 \div 12.34 =$

(1)	(2)	(3)	(4)
	12.34 [D]	12.34	12-34 (red) (rojo)
	2 [x]	2.	2. ×
	[D]	12.34	12-34 (red) (rojo)
	[±]		12-34 =
		24.68	24-68 *
	4 [÷]	4.	4. ÷
	[D]	12.34	12-34 (red) (rojo)
	[±]		12-34 =
		0.32	0-32 *

ADDITION / SUMA

$$12.45 + 36.62 - 93.20 =$$

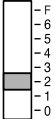
(1)	(2)	(3)	(4)
	12.45 $\boxed{\pm}$	12.45	12.45 +
	36.62 $\boxed{\pm}$	49.07	36.62 +
	93.20 $\boxed{-=}$	44.13-	93.20 -
	$\boxed{*}$		- 44.13 *
		44.13-	

REPEAT ADDITION AND SUBTRACTION / REPETICIÓN DE SUMAS Y RESTAS

$$123 + 123 + 123 + 456 - 100 - 100 =$$

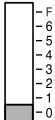
(1)	(2)	(3)	(4)
	123 $\boxed{\pm}$	123.	123. +
	$\boxed{\pm}$	246.	123. +
	$\boxed{\pm}$	369.	123. +
	456 $\boxed{\pm}$	825.	456. +
	100 $\boxed{-=}$	725.	100. -
	$\boxed{-=}$	625.	100. -
	$\boxed{*}$		625. *
		625.	

ADDITION AND SUBTRACTION WITH ADD MODE / SUMA Y RESTA CON MODO DE SUMA

$$12.45 + 16.24 + 19.35 - 5.21 =$$

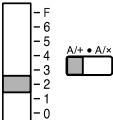
(1)	(2)*1	(3)	(4)
	1245 $\boxed{\pm}$	12.45	12.45 +
	1624 $\boxed{\pm}$	28.69	16.24 +
	1935 $\boxed{\pm}$	48.04	19.35 +
	521 $\boxed{-=}$	42.83	5.21 -
	$\boxed{*}$		42.83 *
		42.83	

*1 : The $\boxed{\pm}$ key was not used in the entries.

*1 : La tecla $\boxed{\pm}$ no ha sido usada en los registros.

MULTIPLICATION / MULTIPLICACIÓN

$$12.36 \times 3.33 \times 53.21 =$$

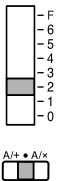
(1)	(2)	(3)	(4)
	12.36 \times 3.33 \times 53.21 \pm	12.36 41.1588 2,190.06	12.36 \times 3.33 \times 53.21 = 2.190.06 *

DIVISION / DIVISIÓN

$$256 \div 12 \div 0.56 =$$

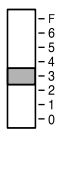
(1)	(2)	(3)	(4)
	256 \div 12 \div .56 \pm	256. 21.3333333333 (21.33333333: QS-1760H) 38.095	256. \div 12. \div 0.56 = 38.095 *

MIXED CALCULATIONS / CÁLCULOS MIXTOS

A. $(10 + 2) \times 5 =$

(1)	(2)	(3)	(4)
	10 \pm 2 \pm \times 5 \pm	10. 12. 12. 60.	10. + 2. + 12. \diamond 12. \times 5. = 60. *

B. $5 \times 2 + 12 =$

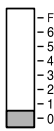
(1)	(2)	(3)	(4)
	$5 \times$ $2 \pm$ $12 \pm$ \pm $*$	5. 10. 10. 22. 22.	$5 \cdot \times$ $2 \cdot =$ $10 \cdot *$ $10 \cdot +$ $12 \cdot +$ $22 \cdot *$

C. $\frac{(5 + 12) \times 3.2 \times 6.7}{2} =$

(1)	(2)	(3)	(4)
	$5 \pm$ $12 \pm$ \times $3.2 \times$ $6.7 \div$ $2 \pm$	5.00 17.00 17.00 54.4 364.48 182.24	$5 \cdot 00 +$ $12 \cdot 00 +$ $17 \cdot 00 \diamond$ $17 \cdot 00 \times$ $3 \cdot 2 \times$ $6 \cdot 7 \div$ $2 \cdot =$ $182 \cdot 24 *$



CONSTANT CALCULATIONS / CÁLCULOS CON CONSTANTES

A. MULTIPLICATION / MULTIPLICACIÓN

1. $62.35 \times 11.11 = \textcircled{1}$

2. $62.35 \times 22.22 = \textcircled{2}$

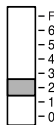
3. $62.35 \times 33.33 = \textcircled{3}$

(1)	(2)	(3)	(4)
 	$62.35 \times$ $11.11 \pm$ $22.22 \pm$ $33.33 \pm$	62.35 692.71 1,385.42 2,078.13	$62 \cdot 35 \times$ $11 \cdot 11 = K$ $692 \cdot 71 * \textcircled{1}$ $22 \cdot 22 = K$ $1 \cdot 385 \cdot 42 * \textcircled{2}$ $33 \cdot 33 = K$ $2 \cdot 078 \cdot 13 * \textcircled{3}$

B. DIVISION / DIVISIÓN

1. $11.11 \div 77.77 = \textcircled{1}$

2. $22.22 \div 77.77 = \textcircled{2}$

3. $33.33 \div 77.77 = \textcircled{3}$

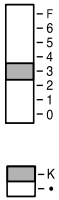
(1)	(2)	(3)	(4)
	$11.11 \div$ $77.77 =$ $22.22 =$ $33.33 =$	11.11 0.143 0.286 0.429	$11 \cdot 11 \div$ $77 \cdot 77 = K$ $0 \cdot 143 * \textcircled{1}$ $22 \cdot 22 = K$ $0 \cdot 286 * \textcircled{2}$ $33 \cdot 33 = K$ $0 \cdot 429 * \textcircled{3}$

POWER CALCULATIONS / CÁLCULOS DE POTENCIA

A. SQUARING / CUADRADOS

$5.25^2 = 5.25 \times 5.25 =$

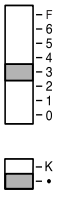
(1)	(2)	(3)	(4)
	$5.25 \times$ $5.25 =$	5.25 27.563	$5 \cdot 25 \times$ $5 \cdot 25 =$ $27 \cdot 563 *$

B. CUBING / CUBOS

$$5^3 = 5 \times 5 \times 5 =$$

(1)	(2)	(3)	(4)
	$5 \times$ \pm \pm	5. 25. 125.	$5 \cdot \times$ $5 \cdot =K$ $25 \cdot *$ $25 \cdot =K$ $125 \cdot *$
	$5 \times$ \times \pm	5. 25. 125.	$5 \cdot \times$ $5 \cdot \times$ $5 \cdot =$ $125 \cdot *$

CORRECTION OF ERRORS / CORRECCIÓN DE ERRORES

A. $123 + \underline{556} \rightarrow 123 + \underline{456}$

(1)	(2)	(3)	(4)
	$123 \pm$ 556CE $456 \pm$ $*$	123. 0. 579. 579.	$123 \cdot +$ $456 \cdot +$ $579 \cdot *$

B. $123456\underline{7} \rightarrow 12345\underline{7}8$

(1)	(2)	(3)
	1234567 \rightarrow \rightarrow 78	1,234,567. 123,456. 12,345. 1,234,578.

RECIPROCAL CALCULATIONS / CÁLCULOS RECÍPROCOS

$$\frac{1}{7} = \textcircled{1} \quad \frac{1}{73} = \textcircled{2}$$

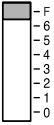
(1)	(2)	(3)	(4)
	$\boxed{*} 7 \boxed{\div}$ $\boxed{\div}$ $\boxed{\pm}$	7. 1. 0.14285714285 (0.142857142: QS-1760H)	$7 \cdot \div$ $7 \cdot \div$ $7 \cdot =$ 0.14285714285 * $\textcircled{1}$ (0.142857142 * : QS-1760H)
	$7 \boxed{\div}$ $\boxed{\div}$ $\boxed{\div}$ $\boxed{\div}$ $\boxed{\pm}$	7. 1. 0.14285714285 (0.142857142: QS-1760H) 0.02040816326 (0.020408163: QS-1760H) 0.00291545189 (0.002915451: QS-1760H)	$7 \cdot \div$ $7 \cdot \div$ $7 \cdot \div$ $7 \cdot \div$ $7 \cdot =$ 0.00291545189 * $\textcircled{2}$ (0.002915451 * : QS-1760H)

PERCENT MULTIPLICATION – DIVISION / MULTIPLICACIÓN – DIVISIÓN DE PORCENTAJES

A. $100 \times 25\% =$

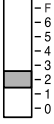
(1)	(2)	(3)	(4)
	$100 \boxed{\times}$ $25 \boxed{\%}$	100. 25.00	$100 \cdot \times$ $25 \cdot \%$ $25 \cdot 00 \cdot *$

B. $123 \div 1368 = (\%)$

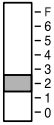
(1)	(2)	(3)	(4)
	$123 \boxed{\div}$ $1368 \boxed{\%}$	123. 8.99	$123 \cdot \div$ $1 \cdot 368 \cdot \%$ $8 \cdot 99 \cdot *$

SQUARE ROOT / CÁLCULO DE RAÍZ CUADRADA

$$\sqrt{123,456} =$$

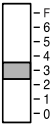
(1)	(2)	(3)	(4)
	123456 \div \pm	123,456.	123·456 \div 123·456 $\sqrt{\quad}$ 351·363 *
	123456 $\sqrt{\quad}$	351.363	351·363 *
		351.363	123·456 $\sqrt{\quad}$ 351·363



ADD-ON AND DISCOUNT / RECARGOS Y DESCUENTOS

EXAMPLE: 1 A 5% add-on to 100.

EJEMPLO: 1 Un 5% de recargo sobre 100.

EXAMPLE: 2 A 10% discount on 100.

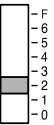
EJEMPLO: 2 Un 10% de descuento sobre 100.

(1)	(2)	(3)	(4)
	100 \times 5 MU	100.	100 \cdot \times 5 \cdot % 5·00 { Increased Incremento
		105.00	105·00 * { New amount Nueva cantidad
	100 \times 10 \div MU	100.	100 \cdot \times - 10 \cdot % - 10·00 { Discount Descuento
		90.00	90·00 * { Net amount Cantidad neta

Markup and Profit Margin are both ways of calculating percent profit.

The difference is:

- Profit margin is percent profit vs. selling price.
- Markup is percent profit vs. cost.

Tanto la función del incremento porcentual como la del margen de beneficio son formas de calcular el beneficio porcentual.

La diferencia consiste en que:

- El margen de beneficio es el beneficio porcentual con respecto al precio de venta.
- El incremento porcentual es el beneficio porcentual con respecto al coste.

Note: In some cases, negative percentages will be shown for margin or markup.

This is a normal function of the calculation logic.

Nota: En algunos casos, se verán porcentajes negativos para el margen o el incremento porcentual. Esta es una función normal de la lógica de cálculo.

MARGIN / MARGEN

EXAMPLE: Calculate the profit margin of a \$65.00 item being sold at \$89.00.

EJEMPLO: Calcular el margen de beneficio correspondiente a un artículo de \$65,00 que se vende a \$89,00.

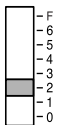
(1)	(2)	(3)	(4)
	65	65.00	65.00
	$\frac{-}{=}$	24.00	89.00
	$\frac{+}{=}$		24.00
	$\frac{MU}{=}$	26.97	26.97 %C

SELLING PRICE (USING MARGIN) / PRECIO DE VENTA (UTILIZANDO MARGEN)

EXAMPLE: Calculate the selling price (a) and the gross profit (b) from a cost of \$8,160 on the basis of a 15% profit on the selling price.

EJEMPLO: Calcular el precio de venta (a) y el beneficio bruto (b) a partir de un coste de \$8.160 y una base del 15% de beneficio sobre el precio de venta.

(1)	(2)	(3)	(4)
	8160	8,160.	8.160
	$\frac{\div}{=}$		\div
	15		15 %M
	$\frac{MU}{=}$	1,440.00	9.600.00 * (a) 1.440.00 GP (b)

COST (USING MARGIN) / COSTE (UTILIZANDO MARGEN)

EXAMPLE: Calculate the cost (a) and the gross profit (b) from a selling price of \$500 on the basis of a 35% profit on the selling price.

EJEMPLO: Calcular el coste (a) y el beneficio bruto (b) a partir de un precio de venta de \$500 y una base del 35% de beneficio sobre el precio de venta.

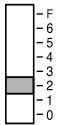
(1)	(2)	(3)	(4)
	500	500.	500
	$\frac{\times}{=}$		\times
	35		35 %
	$\frac{MU}{=}$	325.00	175.00 (b) 325.00 * (a)

MARKUP / INCREMENTO PORCENTUAL

EXAMPLE: Calculate the markup of a \$150.00 item being sold at \$200.00.

EJEMPLO: Calcular el incremento porcentual correspondiente a un artículo de \$150,00 que se vende a \$200,00.

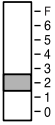
(1)	(2)	(3)	(4)
	200 \pm	200.00	200.00 +
	150 $=$	50.00	150.00 -
	\square MU		50.00 *
		33.33	33.33 %C

SELLING PRICE (USING MARKUP) / PRECIO DE VENTA (UTILIZANDO INCREMENTO PORCENTUAL)

EXAMPLE: Calculate the selling price (a) and gross profit (b) from a cost of \$6,950 on the basis of a 25% profit on the cost.

EJEMPLO: Calcular el precio de venta (a) y el beneficio bruto (b) a partir de un coste de \$6.950 y una base del 25% de beneficio sobre el coste.

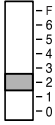
(1)	(2)	(3)	(4)
	6950 \times	6,950.	6.950. \times
	25 \square MU		25. %
			1.737.50 (b)
		8,687.50	8.687.50 * (a)

COST (USING MARKUP) / COSTE (UTILIZANDO INCREMENTO PORCENTUAL)

EXAMPLE: Calculate the cost (a) and the gross profit (b) from a selling price of \$9,780 on the basis of a 20% profit on the cost.

EJEMPLO: Calcular el coste (a) y el beneficio bruto (b) a partir de un precio de venta de \$9.780 y una base del 20% de beneficio sobre el coste.

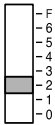
(1)	(2)	(3)	(4)
	9780 \div	9,780.	9.780. \div
	20 \square MU		- 20. %M
			8.150.00 * (a)
		1,630.00	1.630.00 GP (b)

PERCENT CHANGE / CAMBIO PORCENTUAL

EXAMPLE: Calculate the dollar difference (a) and the percent change (b) between two yearly sales figures \$1,500 in one year and \$1,300 in the previous year.

EJEMPLO: Calcular la diferencia en dólares (a) y el cambio porcentual (b) entre dos cifras de ventas anuales, \$1.500 en un año y \$1.300 en el año anterior.

(1)	(2)	(3)	(4)
	1500 $\boxed{\pm}$	1,500.00	1.500-00 +
	1300 $\boxed{-}$	200.00	1.300-00 -
	\boxed{MU}		200-00 * (a)
			15-38 %C (b)
		15.38	

PERCENT PRORATION / DISTRIBUCIÓN PROPORCIONAL DE PORCENTAJE

EXAMPLE: Calculate the percentage of each of the parts is to the whole.

EJEMPLO: Calcular el porcentaje de cada artículo.

Expenses Gastos	%
\$ 123	(a)
456	(b)
789	(c)
(D)	(d)

(1)	(2)	(3)	(4)
	$\boxed{*1}^{*2}$		
	123 $\boxed{\pm}$	123.00	123-00 +
	456 $\boxed{\pm}$	579.00	456-00 +
	789 $\boxed{\pm}$	1,368.00	789-00 +
	123 \boxed{MU}		1.368-00 * (D)
			123- F
			8-99 %P (a)
		8.99	
	$\boxed{+1}$	8.99 ^I	8-99 + I
	456 \boxed{MU}		456- F
			33-33 %P (b)
	$\boxed{+1}$	33.33 ^I	33-33 + I
789 \boxed{MU}	33.33 ^I	789- F	
		57-68 %P (c)	
	57.68 ^I		
$\boxed{+1}$	57.68 ^I	57-68 + I	
$\boxed{\diamond 1}$		100-00 \diamond I (d)	
	100.00 ^I		
$\boxed{*1}$		100-00 * I	
	100.00		

*2 : Press the $\boxed{*1}$ key to clear the memory before starting a memory calculation.

*2 : Apretar la tecla $\boxed{*1}$ para cancelar la memoria antes de empezar a efectuar un cálculo con memoria.

ITEM COUNT CALCULATION / CÁLCULO DE CUENTA DE ARTÍCULOS

Bill No. N° de factura	Number of bills Cantidad de facturas	Amount Importe
1	1	\$100.55
2	1	\$200.00
3	1	\$200.00
4	1	\$400.55
5	1	\$500.65
Total Total	(a)	(b)

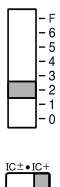
(1)	(2)	(3)		(4)
		(3-1)*	(3-2)*	
	$\boxed{*}$			
	100.55 $\boxed{\pm}$	100.55	001	100.55 +
	200 $\boxed{\pm}$	300.55	002	200.00 +
	400.55 $\boxed{\pm}$	500.55	003	200.00 +
	500.65 $\boxed{\pm}$	901.10	004	400.55 +
	$\boxed{*}$	1,401.75	005	500.65 +
				005 (a)
				1.401.75 * (b)
		1,401.75	005	

(3-1)*: Main/Principal

(3-2)*: Sub/Secundario

QS-2770H only/Sólo en la QS-2770H



GRAND TOTAL CALCULATION / CÁLCULO DE TOTAL GLOBAL

EXAMPLE: 100 + 200 + 300 = ①

EJEMPLO: +) 300 + 400 + 500 = ②

+) 500 - 600 + 700 = ③

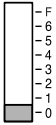
Grand total / Total global ④

(1)	(2)	(3)	(4)
	<input type="checkbox"/> GT <input type="checkbox"/> *		
	100 <input type="checkbox"/>	100.	100. +
	200 <input type="checkbox"/>	300.	200. +
	300 <input type="checkbox"/>	600.	300. +
	<input type="checkbox"/> *		600. ** ①
		600.	
	300 <input type="checkbox"/>	300.	300. +
	400 <input type="checkbox"/>	700.	400. +
	500 <input type="checkbox"/>	1,200.	500. +
	<input type="checkbox"/> *		1,200. ** ②
		1,200.	
	500 <input type="checkbox"/>	500.	500. +
	600 <input type="checkbox"/>	100.	600. -
	700 <input type="checkbox"/>	600.	700. +
	<input type="checkbox"/> *		600. ** ③
		600.	
	<input type="checkbox"/> GT		2,400. *G ④
		2,400.	

MEMORY CALCULATIONS / CÁLCULOS CON MEMORIA

EXAMPLE (1): $46 \times 78 = \textcircled{1}$

EJEMPLO (1): $+) 125 \div 5 = \textcircled{2}$

$-) 72 \times 8 = \textcircled{3}$

Total Total $\textcircled{4}$

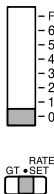
(1)	(2)	(3)	(4)
	$\boxed{[*1]} *3$		
	46 $\boxed{[x]}$	46.	46. \times
	78 $\boxed{[+]}$		78. =
		3,588. ^I	3,588. $+I$ $\textcircled{1}$
	125 $\boxed{[\div]}$	125. ^I	125. \div
	5 $\boxed{[+]}$		5. =
		25. ^I	25. $+I$ $\textcircled{2}$
	72 $\boxed{[x]}$	72. ^I	72. \times
	8 $\boxed{[-]}$		8. =
		576. ^I	576. $-I$ $\textcircled{3}$
	$\boxed{[\diamond 1]}$		3,037. $\diamond I$ $\textcircled{4}$
	3,037. ^I		

EXAMPLE (2): EJEMPLO (2): $(123 + 45) \times (456 - 89) =$

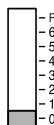
(1)	(2)	(3)	(4)
	$\boxed{[*1]} *3$		
	123 $\boxed{[+]}$	123. ^I	123. $+I$
	45 $\boxed{[+]}$	45. ^I	45. $+I$
	456 $\boxed{[\pm]}$	456. ^I	456. $+$
	89 $\boxed{[-]}$	367. ^I	89. $-$
			367. \diamond
		367. ^I	367. \times
	$\boxed{[\diamond 1]}$		168. $\diamond I$
		168. ^I	168. =
	$\boxed{[\pm]}$		61,656. $*$
	61,656. ^I		

*3 : Press the $\boxed{[*1]}$ key to clear the memory before starting a memory calculation.

*3 : Apretar la tecla $\boxed{[*1]}$ para cancelar la memoria antes de empezar a efectuar un cálculo con memoria.

EXAMPLE (3): EJEMPLO (3):
$$\frac{(874 + 557) \times (7 + 8)}{(1,746 + 876) \div (12 + 23)} =$$

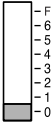
(1)	(2)	(3)	(4)
	$\boxed{*I}$ $\boxed{*II}$ *4		
	12 $\boxed{+I}$	12. ^I	12· +I
	23 $\boxed{+I}$	23. ^I	23· +I
	1746 $\boxed{\pm}$	1,746. ^I	1:746· +
	876 $\boxed{\pm}$	2,622. ^I	876· +
	$\boxed{\div}$		2:622· \diamond
		2,622. ^I	2:622· \div
	$\boxed{*I}$		35· *I
		35.	
	$\boxed{+I}$		35· =
		75. ^I	75· +I
	874 $\boxed{+II}$	874. ^{I II}	874· +II
	557 $\boxed{+II}$	557. ^{I II}	557· +II
	7 $\boxed{\pm}$	7. ^{I II}	7· +
	8 $\boxed{\pm}$	15. ^{I II}	8· +
	$\boxed{\times}$		15· \diamond
		15. ^{I II}	15· \times
	$\boxed{\diamond II}$		1:431· $\diamond II$
		1,431. ^{I II}	
	$\boxed{\div}$	21,465. ^{I II}	1:431· \div
	$\boxed{\diamond I}$		75· $\diamond I$
		75. ^{I II}	
	$\boxed{\pm}$		75· =
		286. ^{I II}	286· *
	$\boxed{*I}$		75· *I
		75. ^{II}	
	$\boxed{*II}$		1:431· *II
		1,431.	

*4: Press $\boxed{*I}$ then $\boxed{*II}$ to clear the contents of the First and Second memories before starting the operation.



*4: Antes de iniciar la operación, apriete $\boxed{*I}$ y luego $\boxed{*II}$ para borrar el contenido de la primera y de la segunda memoria.

FΣ AND GT CALCULATION (QS-2770H only) / CÁLCULO DE FΣ Y DE TOTAL GENERAL (sólo en la QS-2770H)

EXAMPLE: Calculation of closing inventory (sales ledger, etc.)

EJEMPLO: Cálculo para el inventario final (libro mayor de ventas, etc.)

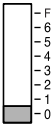



Article Artículo	Amount of remainders Suma de los remanentes	Unit price (\$) Precio unitario	Sum (\$) Suma
A	350	25	(a)
B	136	62	(b)
C	48	120	(c)
D	122	30	(d)
Total	(E)		(e)

(1)	(2)	(3)	(4)
  	<div style="display: flex; justify-content: space-between; align-items: center;"> GT *I </div> <div style="display: flex; justify-content: space-between; align-items: center;"> 350 x </div> <div style="display: flex; justify-content: space-between; align-items: center;"> 25 ± </div> <div style="display: flex; justify-content: space-between; align-items: center;"> 136 x </div> <div style="display: flex; justify-content: space-between; align-items: center;"> 62 ± </div> <div style="display: flex; justify-content: space-between; align-items: center;"> 48 x </div> <div style="display: flex; justify-content: space-between; align-items: center;"> 120 ± </div> <div style="display: flex; justify-content: space-between; align-items: center;"> 122 x </div> <div style="display: flex; justify-content: space-between; align-items: center;"> 30 ± </div> <div style="display: flex; justify-content: space-between; align-items: center;"> GT </div> <div style="display: flex; justify-content: space-between; align-items: center;"> *I </div>	 350. I 8,750. I 136. I 8,432. I 48. I 5,760. I 122. I 3,660. I 26,602. I 656.	 350. × I 25. = 8,750. *+ (a) 136. × I 62. = 8,432. *+ (b) 48. × I 120. = 5,760. *+ (c) 122. × I 30. = 3,660. *+ (d) 26,602. *G (e) 656. * I (E)

TAX RATE CALCULATIONS CÁLCULOS CON EL TIPO DE IMPUESTO

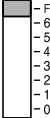
EXAMPLE 1: Set a 5% tax rate. Calculate the total amount for adding a 5% tax to \$800.

EJEMPLO 1: Fijar el tipo de impuesto al 5%. Calcular la cantidad total resultante de añadir el impuesto del 5% a \$800.

(1)	(2)	(3)	(4)
   (QS-2770H only/ Sólo en la QS- 2770H)	* 5 TAX+	5.000	TX 5.000 %
	800 TAX+	840.	800. 40 TX 840.

EXAMPLE 2: Calculate the total amount for adding a 5% tax to the sum of \$500 and \$460.

EJEMPLO 2: Calcular la cantidad total resultante de añadir el impuesto de 5% a la suma de \$500 y \$460.

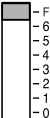
(1)	(2)	(3)	(4)
	500 ± 460 ± TAX+	500. 960. 1,008.	500 + 460 + 960 * 48 TX 1,008.

EXAMPLE 3: Calculate the total amount for the sum of \$500 with tax already included and \$460 with 5% tax to be added.

EJEMPLO 3: Calcular la cantidad total resultante de sumar \$500 con el impuesto ya incluido y \$460 con el impuesto del 5% a añadir.

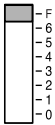
(1)	(2)	(3)	(4)
	500 \pm	500.	500 +
	460 TAX+		460
			23 TX
		483.	483
	\pm *		483 +
		983.	983 *

EXAMPLE 4: Calculate the before-tax value of \$800 in which a 5% tax has been included.

EJEMPLO 4: Calcular el valor antes de impuestos de 800 dólares en el que se ha incluido un impuesto del 5%.

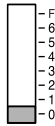
(1)	(2)	(3)	(4)
	800 TAX-		800
			TX
			38 -
		762.	762

SAMPLE APPLICATIONS

1. Set the decimal selector as specified in each example.
The rounding selector should be in the "5/4" position unless otherwise specified.
2. The grand total / rate setting mode selector, constant mode, add mode, item count mode and first factor accumulation selectors (QS-2770H only) should be in the "•" position (off position) unless otherwise specified.
3. Print mode selector should be in the "P" position unless otherwise specified.

AVERAGING

Calculate the average of a series of values.

- SOLUTION:**
1. Add the values to calculate the TOTAL VALUES.
 2. Determine the NUMBER OF VALUES.
 3. Calculate the average.

FORMULA:

$$\text{Average} = \frac{\text{Total of the values}}{\text{Number of values}}$$

EXAMPLE:

	Day	Sales
If	Monday	\$123.15
	Tuesday	118.00
	Wednesday	131.58
	Thursday	125.02
	Friday	158.25
	Total Sales	\$656.00 for 5 days

Then Average Sales = \$131.20

Note: If you are working in dollars and cents, use the "Add Mode." If not, set the decimal as desired.

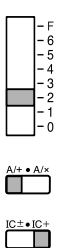
	OPERATION	DISPLAY		PRINT
		Main	Sub*	
	*			
	12315 $\frac{\pm}{\pm}$	123.15	001	123.15 +
	118 • $\frac{\pm}{\pm}$	241.15	002	118.00 +
	13158 $\frac{\pm}{\pm}$	372.73	003	131.58 +
	12502 $\frac{\pm}{\pm}$	497.75	004	125.02 +
	15825 $\frac{\pm}{\pm}$	656.00	005	158.25 +
	$\frac{\text{IC}+}{\text{IC}+}$ $\frac{\text{AVG}}{\text{AVG}}$			005 No. of items
			656.00 * Total sales	
			131.20 AG Average	
		131.20	000	

* QS-2770H only

(QS-1760H):

	OPERATION	DISPLAY	PRINT	
	.05	\div	0.05	0.05 \div Annual int. rate
	4	\pm		4. =
			0.0125	0.0125 * Quarterly int. rate
		\pm	0.0125	0.0125 +
	1	\pm	1.0125	1. +
		\times		1.0125 \diamond (1 + i)
			1.0125	1.0125 \times
				1.0125 =
			1.02515625	1.02515625 * (1 + i) ²
			1.02515625	1.02515625 \times
		\times	1.02515625	1.02515625 =
		\pm		1.050945336 * (1 + i) ⁴
			1.050945336	1.050945336 \times
			1.050945336	1.050945336 =
		\times	1.050945336	1.104486099 * (1 + i) ⁸
		\pm		1.104486099 \times
			1.104486099	1.104486099 =
		\times	1.104486099	1.219889542 * (1 + i) ¹⁶
		\pm		1.219889542 \times
			1.219889542	1.219889542 =
		\times	1.219889542	6.150. = Principal
6150	\pm		7,502.320683	7.502.320683 * New balance

EJEMPLOS DE APLICACIONES

- Colocar el selector decimal según se especifica en cada ejemplo.
El selector de redondeo debe estar en la posición "5/4" salvo que se especifique lo contrario.
- Los selectores de modo de total global / fijación de tipos, modo de constante, modo de suma, modo para contar artículos, y modo de acumulación del primer factor (sólo en la QS-2770H) deben estar en la posición "•" (posición de desconexión) salvo que se especifique lo contrario.
- El selector del modo de impresión debe estar en la posición "P" salvo que se especifique lo contrario.

PROMEDIO

Calcular el promedio de una serie de valores.

- SOLUCIÓN:**
- Sumar los valores para calcular los VALORES TOTALES.
 - Determinar el NUMERO DE VALORES.
 - Calcular el promedio.



FORMULA:
$$\text{Promedio} = \frac{\text{Total de los valores}}{\text{Número de valores}}$$

EJEMPLO:

	Día	Ventas
Si el	Lunes	\$123,15
	Martes	118,00
	Miércoles	131,58
	Jueves	125,02
	Viernes	158,25
	El total de ventas de los 5 días = \$656,00	

Por lo tanto: Promedio de las ventas = \$131,20

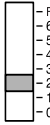
Nota: Al trabajar con dólares y centavos, usar el "Modo de suma". De no hacerlo, colocar el punto decimal como se desee.

	OPERACIÓN	EXHIBICIÓN		IMPRESIÓN
		Principal	Secundario*	
  	<div style="text-align: center;">*</div> <div style="text-align: center;">±</div> <div style="text-align: center;">12315</div> <div style="text-align: center;">118 •</div> <div style="text-align: center;">±</div> <div style="text-align: center;">13158</div> <div style="text-align: center;">±</div> <div style="text-align: center;">12502</div> <div style="text-align: center;">±</div> <div style="text-align: center;">15825</div> <div style="text-align: center;">±</div> <div style="text-align: center;">AVG</div>			<div style="text-align: center;">123.15 +</div> <div style="text-align: center;">001</div> <div style="text-align: center;">241.15 +</div> <div style="text-align: center;">002</div> <div style="text-align: center;">372.73 +</div> <div style="text-align: center;">003</div> <div style="text-align: center;">497.75 +</div> <div style="text-align: center;">004</div> <div style="text-align: center;">125.02 +</div> <div style="text-align: center;">005</div> <div style="text-align: center;">158.25 +</div> <div style="text-align: center;">005</div> <div style="text-align: center;">656.00 *</div> <div style="text-align: center;">131.20 AG</div>
	123.15	001	123.15 +	
	241.15	002	118.00 +	
	372.73	003	131.58 +	
	497.75	004	125.02 +	
	656.00	005	158.25 +	
	656.00 *		Nº de artículos	
	131.20 AG		Ventas totales	
	131.20	000	Promedio	

* Sólo en la QS-2770H

INTERÉS COMPUESTO

Calcular el nuevo balance de un depósito que se compone por trimestres durante 4 años a una tasa dada de interés anual.

SOLUCIÓN: 1. Calcular la tasa de interés trimestral.
2. Calcular el nuevo balance o saldo (capital más interés).

FORMULA: Nuevo balance = $P(1+i)^n$

En donde P = cantidad depositada (capital)
i = tasa de interés por período
n = número de años \times 4



EJEMPLO: Si P = \$6.150
i = 5% anual \div 4 períodos = 0,0125
n = 16 (4 años \times 4)

Por lo que $6.150(1,0125)^{16} \approx \$7.502,32$ (Nuevo balance)

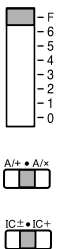
(QS-2760H/2770H):

	OPERACIÓN	EXHIBICIÓN	IMPRESIÓN
	.05	\div	0.05
	4	\pm	0.05
			0.0125
		\pm	0.0125
	1	\pm	1.0125
		\times	1.0125
			1.0125
		\pm	1.0125
			1.02515625
		\times	1.02515625
		\pm	1.02515625
			1.05094533691
		\times	1.05094533691
		\pm	1.05094533691
			1.10448610117
		\times	1.10448610117
	\pm	1.10448610117	
		1.21988954767	
	\times	1.21988954767	
6150	\pm	1.21988954767	
		7,502.32071817	

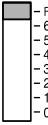
(QS-1760H):

	OPERACIÓN	EXHIBICIÓN	IMPRESIÓN
  	.05 \div	0.05	0.05 \div
	4 \pm		4. =
		0.0125	0.0125 * Tasa de interés trimestral
	\pm	0.0125	0.0125 +
	1 \pm	1.0125	1. +
	\times		1.0125 \diamond (1 + i)
		1.0125	1.0125 \times
	\pm		1.0125 =
		1.02515625	1.02515625 * (1 + i) ²
	\times	1.02515625	1.02515625 \times
\pm		1.02515625 =	
	1.050945336	1.050945336 * (1 + i) ⁴	
\times	1.050945336	1.050945336 \times	
\pm		1.050945336 =	
	1.104486099	1.104486099 * (1 + i) ⁸	
\times	1.104486099	1.104486099 \times	
\pm		1.104486099 =	
	1.219889542	1.219889542 * (1 + i) ¹⁶	
\times	1.219889542	1.219889542 \times	
6150 \pm		6.150. =	
	7,502.320683	7.502.320683 * Nuevo balance	

For your convenience, Genuine Sharp Supplies, Accessories, and additional Sharp Products can be purchased from the Authorized Sharp Reseller where you purchased your product or on-line at:

www.sharpplace.com

SHARP

SHARP ELECTRONICS CORPORATION

Sharp Plaza, Mahwah, New Jersey 07430-1163

www.sharpusa.com

SHARP CORPORATION

PRINTED IN CHINA / IMPRESO EN CHINA

02LT(TINSZ0586EHZZ)

Free Manuals Download Website

<http://myh66.com>

<http://usermanuals.us>

<http://www.somanuals.com>

<http://www.4manuals.cc>

<http://www.manual-lib.com>

<http://www.404manual.com>

<http://www.luxmanual.com>

<http://aubethermostatmanual.com>

Golf course search by state

<http://golfingnear.com>

Email search by domain

<http://emailbydomain.com>

Auto manuals search

<http://auto.somanuals.com>

TV manuals search

<http://tv.somanuals.com>