

SHARP CORPORATION

VL-NZ100S

BEDIENUNGSANLEITUNG MODE D'EMPLOI

SHARP®

**CAMCORDER MIT FLÜSSIGKRISTALL-DISPLAY
CAMÉSCOPE À AFFICHAGE À CRISTAUX LIQUIDES**

VL-NZ100S

DEUTSCH

FRANÇAIS

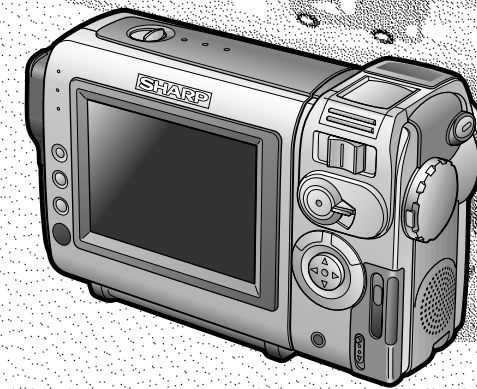

SHARP VIEW•CAM

■ **BEDIENUNGSANLEITUNG** ■
■ **MODE D'EMPLOI** ■

Mini **DV**

- Das "Mini DV" logo ist ein Warenzeichen.
- Le sigle "Mini DV" est une marque déposée.

Gedruckt in Japan
Imprimé au Japon
TINSLA006WJZZ
02P03-JKG
☐



This equipment complies with the requirements of Directives 89/336/EEC and 73/23/EEC as amended by 93/68/EEC.

Dieses Gerät entspricht den Anforderungen der EG-Richtlinien 89/336/EWG und 73/23/EWG mit Änderung 93/68/EWG.

Ce matériel répond aux exigences contenues dans les directives 89/336/CEE et 73/23/CEE modifiées par la directive 93/68/CEE.

Dit apparaat voldoet aan de eisen van de richtlijnen 89/336/EEG en 73/23/EEG, gewijzigd door 93/68/EEG.

Dette udstyr overholder kravene i direktiv nr. 89/336/EEC og 73/23/EEC med tillæg nr. 93/68/EEC.

Quest' apparecchio è conforme ai requisiti delle direttive 89/336/EEC e 73/23/EEC, come emendata dalla direttiva 93/68/EEC.

Η εγκατάσταση αυτή ανταποκρίνεται στις απαιτήσεις των οδηγιών της Ευρωπαϊκής Ένωσης 89/336/EOK και 73/23/EOK, όπως οι κανονισμοί αυτοί συμπληρώθηκαν από την οδηγία 93/68/EOK.

Este equipamento obedece às exigências das directivas 89/336/CEE e 73/23/CEE, na sua versão corrigida pela directiva 93/68/CEE.

Este aparato satisface las exigencias de las Directivas 89/336/CEE y 73/23/CEE, modificadas por medio de la 93/68/CEE.

Denna utrustning uppfyller kraven enligt riktlinjerna 89/336/EEC och 73/23/EEC så som kompletteras av 93/68/EEC.

Dette produktet oppfyller betingelsene i direktivene 89/336/EEC og 73/23/EEC i endringen 93/68/EEC.

Tämä laite täyttää direktiivien 89/336/EEC ja 73/23/EEC vaatimukset, joita on muutettu direktiivillä 93/68/EEC.

WARNING

TO PREVENT SHOCK HAZARD, DO NOT EXPOSE THIS APPLIANCE TO RAIN OR MOISTURE.

This equipment should be used with the recommended AC adapter or battery pack.

CAUTION

To prevent electric shocks and fire hazards, do NOT use any other power source.

Important:

Recording and playback of any material may require consent. Please refer particularly to the provisions of the Copyright Act 1956, the Dramatic and Musical Performers Protection Act 1958, the Performers Protection Acts 1963 and 1972 and to any subsequent statutory enactments and orders.

CAUTION

To prevent shock, do not open the cabinet. No user serviceable parts inside. Refer servicing to a qualified dealer or service centre.



Power supply:

WARNING: THIS AC ADAPTER IS NOT FOR USE WITH TOYS. THIS AC ADAPTER IS FOR USE WITH SHARP CAMCORDER MODEL VL-NZ100H ONLY.

This unit can be operated by connecting it to either the AC adapter or battery pack. The AC adapter incorporates the AUTO VOLTAGE (AC 110–240 V, 50/60 Hz) function.



SPECIAL NOTE FOR USERS IN THE U.K.

The mains lead of this product is fitted with a non-rewireable (moulded) plug incorporating a 3A fuse. Should the fuse need to be replaced, a BSI or ASTA approved BS 1362 fuse marked  or  and of the same rating as above, which is also indicated on the pin face of the plug, must be used.

Always refit the fuse cover after replacing the fuse. Never use the plug without the fuse cover fitted.

In the unlikely event of the socket outlet in your home not being compatible with the plug supplied, cut-off the mains plug and fit an appropriate type.

DANGER: The fuse from the cut-off plug should be removed and the cut-off plug destroyed immediately and disposed of in a safe manner.

Under no circumstances should the cut-off plug be inserted elsewhere into a 13A socket outlet, as a serious electric shock may occur.

To fit an appropriate plug to the mains lead, follow the instructions below:

IMPORTANT: The wires in the mains lead are coloured in accordance with the following code:

Blue: Neutral
Brown: Live

As the colours of the wires in the mains lead of this product may not correspond with the coloured markings identifying the terminals in your plug, proceed as follows:

- The wire which is coloured blue must be connected to the plug terminal which is marked N or coloured black.
- The wire which is coloured brown must be connected to the plug terminal which is marked L or coloured red.

Ensure that neither the brown nor the blue wire is connected to the earth terminal in your three-pin plug.

Before replacing the plug cover make sure that:

- If the new fitted plug contains a fuse, its value is the same as that removed from the cut-off plug.
- The cord grip is clamped over the sheath of the mains lead and not simply over the lead wires.

IF YOU HAVE ANY DOUBT, CONSULT A QUALIFIED ELECTRICIAN.

NOTE:

The LCD panel of this camcorder is a very high technology product with more than 120,000 thin-film transistors*, giving you fine picture detail. Occasionally, a pixel may appear on the screen as a fixed point of blue, green, red, or black. Please note that this does not affect the performance of your camcorder.







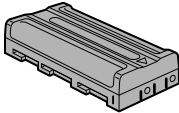
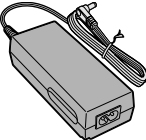

*Specifications are subject to change without notice.

Trademarks

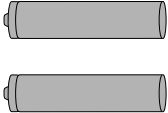
- Microsoft and Windows are either registered trademarks or trademarks of Microsoft Corporation in the United States and/or other countries.
- DPOF is a trademark of CANON INC., Eastman Kodak Company, Fuji Photo Film Co., Ltd. and Matsushita Electric Industrial Co., Ltd.
- All other brand or product names are registered trademarks or trademarks of their respective holders.

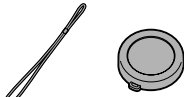
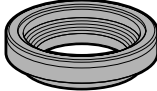
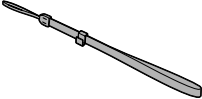

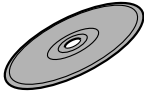
Supplied Accessories

 <p>Battery pack BT-L225</p>	 <p>AC adapter</p>	 <p>Power cord</p>	 <p>Remote control</p>
 <p>AA battery × 2</p>	 <p>CR2025 type lithium battery</p>	 <p>Audio/video cable</p>	 <p>Lens cap</p>
 <p>Lens hood</p>	 <p>Wrist strap</p>	 <p>Tripod adapter</p>	 <p>SD Memory Card (8 MB)</p>
 <p>USB driver</p>	 <p>USB cable</p>		



Optional Accessories

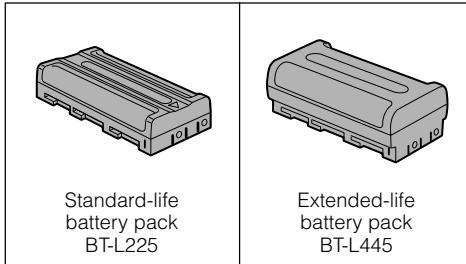



Precautions

- **When the camcorder is not in use, remember to remove the cassette tape, turn off the power, and disconnect the camcorder from the power source.**

- **Do not aim the lens at the sun.**
Do not allow direct sunlight to strike the camcorder lens or LCD monitor screen, whether or not recording is in progress, as it may damage the CCD sensor or LCD screen surface. Be particularly careful when recording outside.

- When shooting in dark places, avoid sudden brightly lit objects or light sources, such as the sun. Otherwise, the image may white out. Should this happen, point the lens in a different direction until the picture returns to normal.

- **Avoid magnetic sources.**
Using the camcorder near strong fluorescent lights, motors, televisions, or other magnetic sources may adversely affect recorded images.

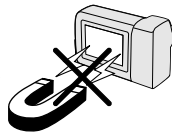

- **Using the camcorder near a broadcasting station or other powerful transmission source may cause buzzing or picture deterioration.**

- **Avoid shocks and dropping.**
Do not drop or otherwise subject the camcorder to hard shocks or strong vibrations. Bumping or striking the unit during recording will generate noise in the recorded image.

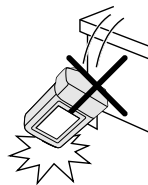

- **Avoid placing the camcorder in close proximity to lighting equipment.**
The heat from incandescent lights may deform the camcorder, or cause it to malfunction.

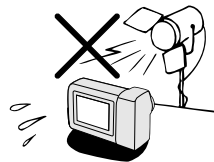

- **Always respect prohibitions or restrictions on the use of electronic equipment on commercial flights or in other sensitive areas.**

- **Be aware of the temperature and humidity.**
You can use your camcorder at 0°C to +40°C, and at 30% to 80% relative humidity. Do not store the unit in an unventilated car in the summer, in direct sunlight, or near strong heat sources; this can result in severe damage to the unit casing and circuitry.

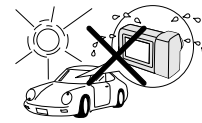

- **Avoid situations where water, sand, dust or other foreign matter could get on or inside the camcorder, and do not use or leave your camcorder in areas with excessive smoke, steam or moisture.**

Such environments can cause malfunctions or cause mildew to form on the lenses. Be sure to keep the unit in a well-ventilated location.

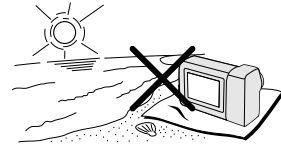

- **Some small, portable tripods may be difficult to attach and may not be sturdy enough to support your camcorder. Be sure to use only a strong, stable tripod.**

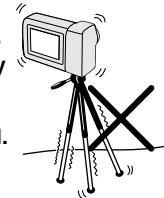

- **When using your camcorder in a cold environment, the LCD monitor screen often appears less bright immediately after the power is turned on. This is not a malfunction. To prevent the camcorder from becoming too cold, wrap it in a thick cloth (a blanket, etc.).**



Dew Formation

• What is “dew formation”?

When cold water is poured into a glass, dew drops form on the glass. This clinging of water drops is called dew formation.

• When dew forms in your camcorder.

Dew will gradually form on the head drum of your camcorder and make the video tape stick to the head. This causes damage both to the head and the tape. When dew forms, recording and playback may not function properly.

Dew is likely to form in the following circumstances:

- When moving the camcorder from a cold place to a warm place.
- When placing the camcorder in a cold room which is then heated rapidly.
- When moving the camcorder outdoors from an air conditioned room or car.
- When placing the camcorder in the direct path of air blowing from an air conditioner.
- When placing the camcorder in a humid room.



• How to prevent trouble.

When using the camcorder in a place where dew is likely to form, allow the camcorder and the video tape to acclimatise to the surroundings for about one hour.

For example, when bringing the camcorder indoors after skiing, place it in a plastic bag.

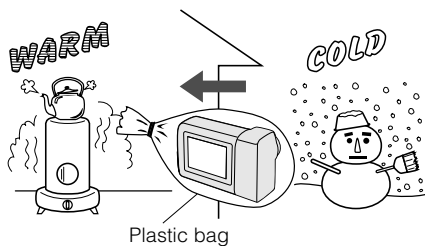

- ① Be sure to tightly seal the plastic bag containing the camcorder.
- ② Remove the bag when the air temperature inside it reaches the temperature of the room.

• “Dew” warning feature

If dew forms, the word “DEW” flashes on the screen, and the power will automatically turn off in approximately 10 seconds.

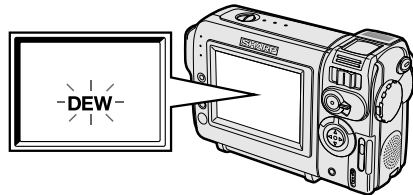

- ① If “DEW” flashes, remove the cassette, leave the cassette compartment open, and wait for a few hours to allow the camcorder to acclimatise to the surrounding temperature.
- ② To use the camcorder again, turn on the power after waiting for a few hours. Be sure that “DEW” has disappeared.
- ③ Do not insert a cassette while “DEW” is flashing; this may result in damage to the tape.
- ④ Since dew forms gradually, it may take 10 to 15 minutes before the dew warning feature engages.



Precautions

Dirty Video Heads

When the video heads have become clogged with dirt (dust and tape coating particles),

Striped noise



Mosaic noise



- mosaic-like noise appears on the playback picture. (see above illustration)
- playback pictures do not move.
- during playback, the whole screen becomes blue.

Causes of video head clogging

- High-temperature and high-humidity environment
- A lot of dust in the air
- Damaged tape
- Worn tape
- Long-time use
- Dew formation

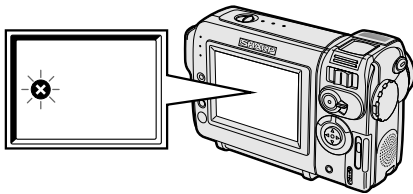

If the video heads become clogged, the  indicator appears on the screen. Contact your SHARP dealer for further advice or refer to page 78 "Before Requesting Service".

Using a Cleaning Tape (Commercially Available)

Available mode:
TAPE-VCR

You can clean the video head with a commercially available cleaning tape.

Notes:

- **Excessive use of the cleaning tape may cause damage to the video heads. Please read the instructions accompanying the cleaning tape carefully before using it.**
- The fast forward and rewind functions cannot be used when the cleaning tape is in the camcorder.
- If the video heads again become clogged with dirt soon after cleaning, this might be caused by a damaged tape. In this case, stop using that cassette immediately.

- 1 Insert a cleaning tape into the camcorder.
- 2 Set the camcorder to TAPE-VCR mode.
 - The video head cleaning screen appears.
- 3 Press the SET button to begin video head cleaning.
 - "NOW CLEANING" flashes during cleaning.



- After about 20 seconds, video head cleaning automatically finishes, and "EJECT THE CASSETTE." displays.

- 4 Remove the cleaning tape.

To cancel cleaning, press the SET button.

v



Contents

<u>Operation References</u>	Part Names	1
	On-screen Display Index	4
	Warning Indicators	7
<u>Preparation</u>	Attaching and Removing the Battery Pack	9
	Charging the Battery Pack	10
	Powering the Camcorder from an AC Outlet	11
	Inserting and Removing a Cassette	12
	Inserting and Removing a Card	13
	Installing the Lithium Battery	14
	Setting the Date and Time	15
	Attaching the Lens Hood	16
	Attaching the Wrist Strap	16
	Using the Lens Cap	17
	Tips on Recording Positions	18
<u>Basic Operations</u>	Camera Recording	
	Selecting the Camcorder Mode	19
	Easy Camera Recording on Tape in Full Auto Mode	20
	Zooming	21
	Auto Focus	21
	Macro Shots	21
	Remaining Recording Time Display	22
	Remaining Battery Power Display	22
	Playback	
	Tape Playback	23
	Using Earphones (Commercially Available)	23
	Volume Control	24
	Still	24
	Video Search	24
	Watching Playback on a TV	25
<u>Useful Features</u>	Using the Menu Screens	26
	Camera Recording	
	Displaying the Recording Guide	27
	Setting the Digital Zoom	28
	Gamma Brightness Compensation	29
	Gain-up	30
	Fade In and Fade Out	31
	Quick Return	32
	Edit Search	32

Operation References
Preparation
Basic Operations
Useful Features
Advanced Features
Digital Still Camera Features
Appendix





Contents

Useful Features

Still Recording on Tape	33
Attaching the Supplied Tripod Adapter	33
Wide Screen (16:9)	34
Digital Image Stabilization (DIS)	34
Self Recording	35
Recording in LP (Long Play Recording) Mode	36
Selecting the 16-bit Audio Recording Mode	37

Playback

Using the Remote Control	38
Displaying the Date and Time of Recording	39
Slow	39
Gamma Playback	40
Copying an Image from Tape to Card	40
Picture Effect Playback	41

Advanced Features

Camera Recording

Manual Focus	42
Manual Exposure	43
White Balance Lock	44
Setting the Camcorder to Full Auto Mode	44
Digital Picture Effects	45
Scene Menu (Program AE)	46

Playback

Using the Time Code	47
Editing	48
Recording from an External Source	49
Using the Camcorder as a Converter	50
Editing with the DV Terminal (IEEE1394)	51
Selecting the Audio Playback Mode	52
Audio Dubbing Feature	53



Digital Still Camera Features

Camera Recording

Card Recording	55
Selecting the Picture Quality	56
Recording with the Self-timer	57
Formatting a Card	58

Playback

Card Playback	59
Delete Protection	60
Deleting Stored Images	61
Print Order	63
Transferring Data on Card to Computer	65
Installing the USB driver	65
Slide Show Playback	67

Appendix

Picture/Backlight Adjustments	68
Turning off the Confirmation Sound	69
Useful Information	70
Demonstration Mode	77
Before Requesting Service	78
Specifications	80

Operation References

Preparation

Basic Operations

Useful Features

Advanced Features

Digital Still Camera Features

Appendix

Operation References

Part Names

For details on the use of each part, refer to the page number indicated in brackets.

Front view

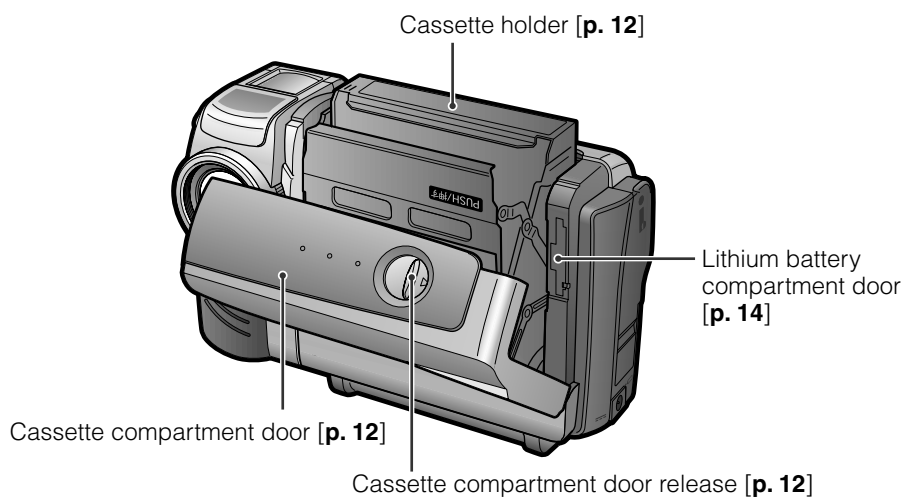

1

VL-NZ100H-001-008

1

02.2.14, 9:58 AM

 GK Associates, Inc.



Rear view

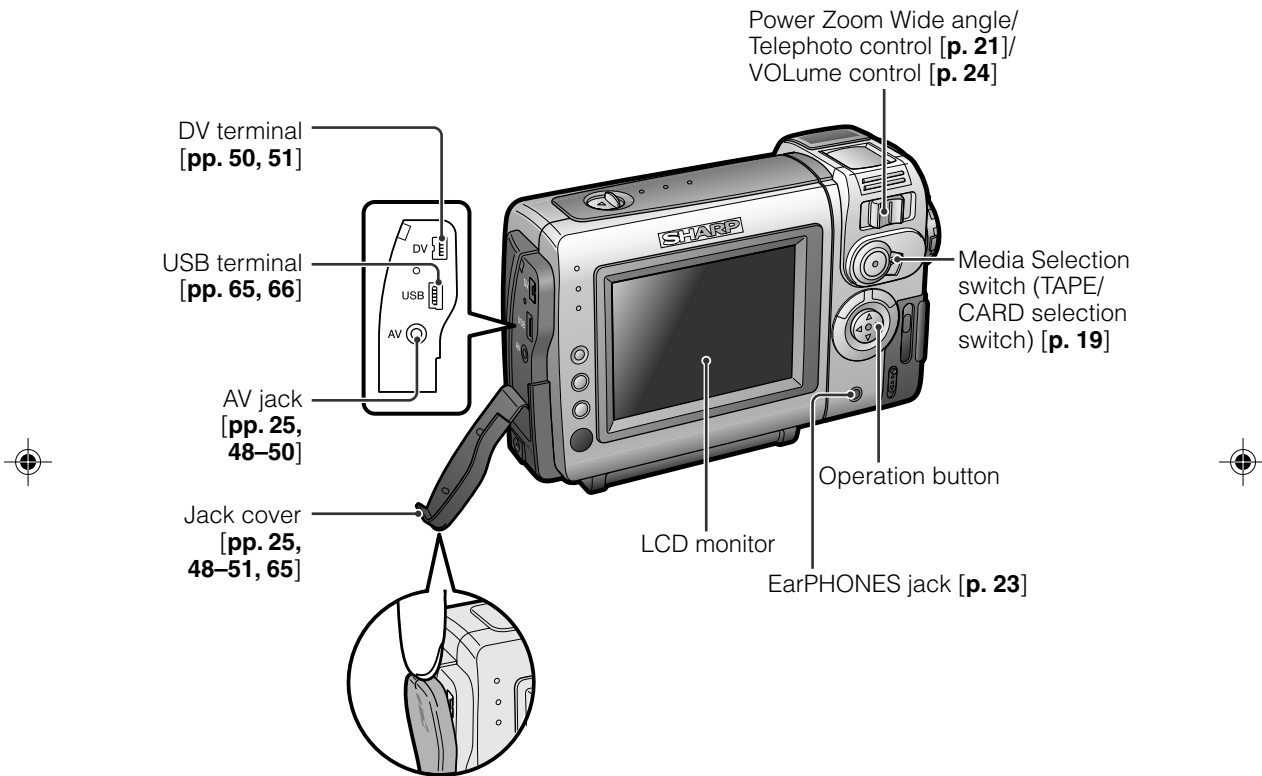



Operation References

Rear view

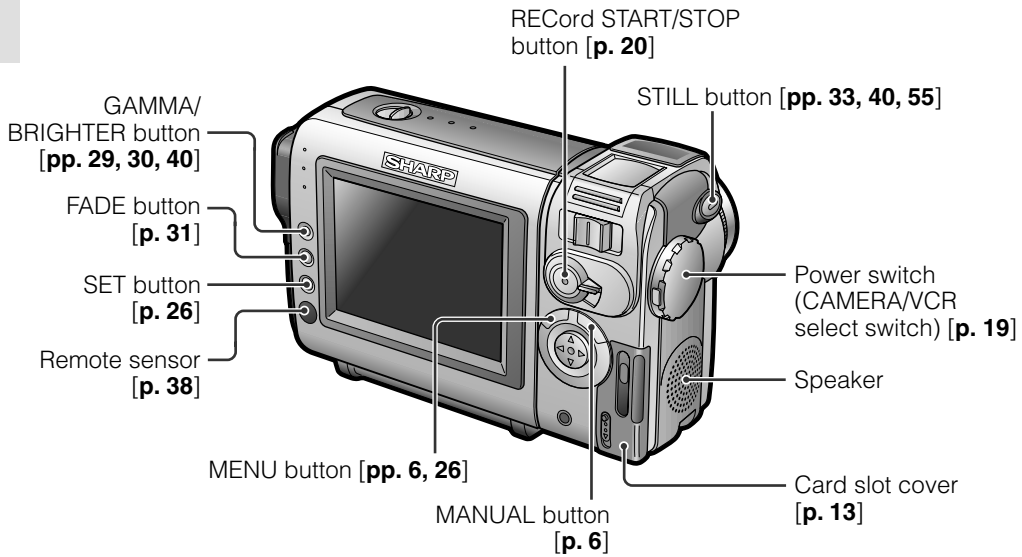

Bottom view

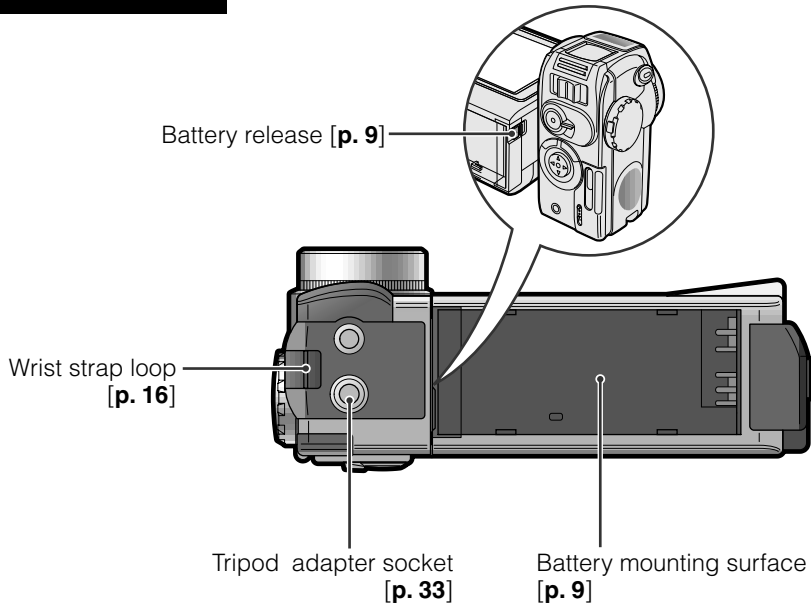



On-screen Display Index

For details on the use of each function, refer to the page number indicated.

TAPE-CAMERA mode

SETTING 1

- PIC. EFFECT p. 45
- SCENE MENU p. 46
- QK. RETURN p. 32
- GUIDE p. 27
- RETURN p. 27

SETTING 2

- DCTL ZOOM p. 28
- TAPE SPEED p. 36
- DIS p. 34
- 16:9 p. 34
- AUDIO MODE p. 34
- RETURN p. 37

OTHERS

- BEEP p. 69
- TIME CODE p. 47
- TC OUT p. 47
- DEMO MODE p. 77
- RETURN p. 77

LCD SET

- BACKLIGHT
- LCD BRIGHT
- LCD COLOUR
- RETURN p. 68

CLOCK SET

- DISPLAY p. 39
- SETTING p. 15
- 12H/24H p. 16
- RETURN p. 16

TAPE-VCR mode

PLAYBACK SET

- PIC. EFFECT p. 41
- AUDIO DUB p. 54
- AUDIO p. 52
- ANLG-DGTL p. 50
- RETURN p. 50

OTHERS

- REMOTE p. 38
- BEEP p. 69
- TIME CODE p. 47
- TC OUT p. 47
- RETURN p. 47

LCD SET

- BACKLIGHT
- LCD BRIGHT
- LCD COLOUR
- RETURN p. 68

CLOCK SET

- DISPLAY p. 39
- RETURN p. 39



Operation References

CARD-CAMERA mode

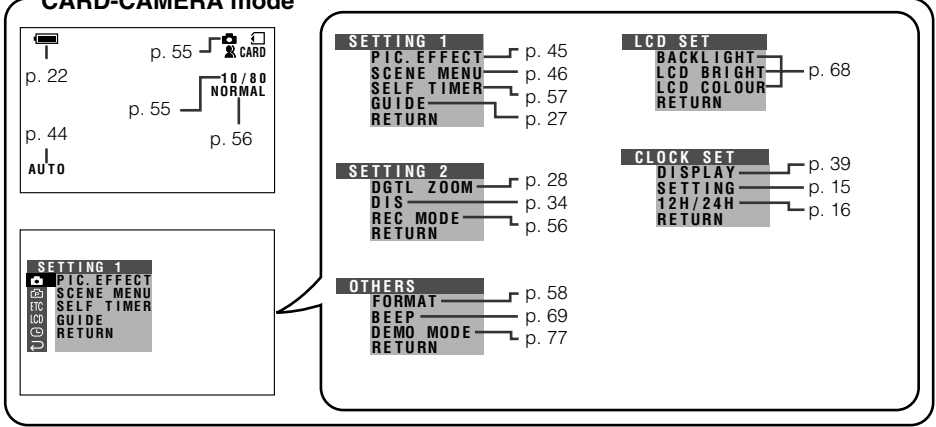

CARD-VCR mode

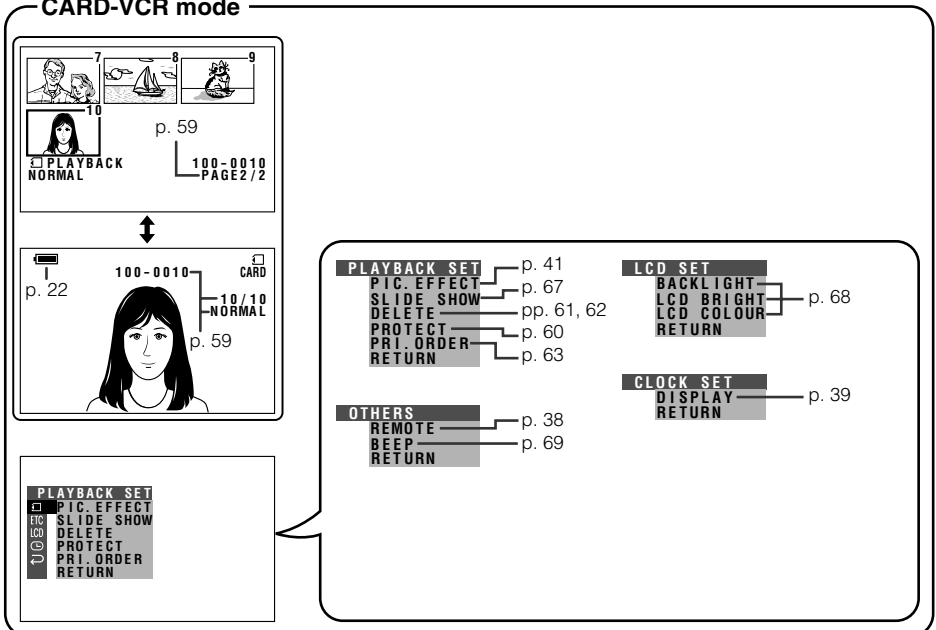

Note:

- See page 26 for procedures on how to display the desired screen.



Manual screens

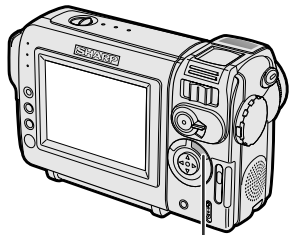

MANUAL button

Each time you press the MANUAL button, the screen changes as shown below.

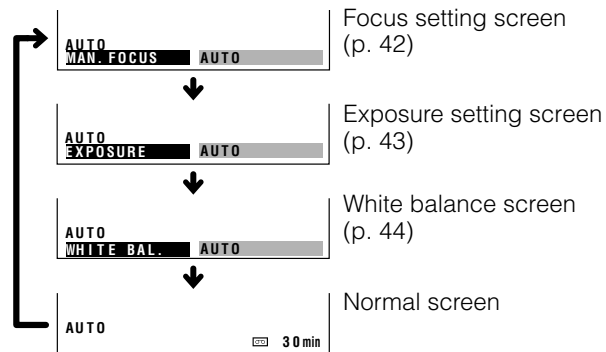

On-screen indicators on/off

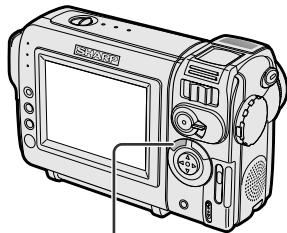

MENU button

Each time you press the MENU button, the screen changes as shown below.

- The example screens shown are for TAPE-CAMERA mode.

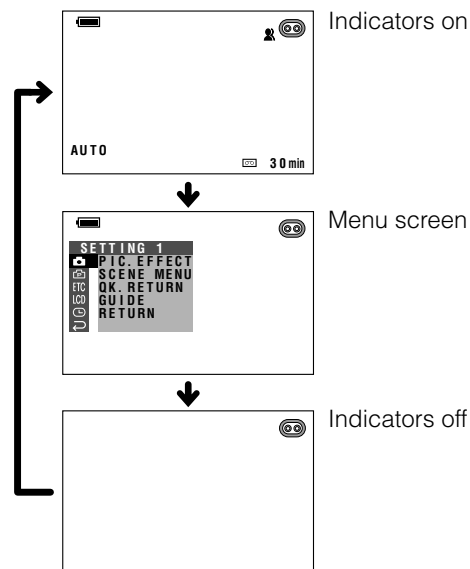

Operation References

Warning Indicators

If a warning indicator appears on the screen, follow the specified instructions.

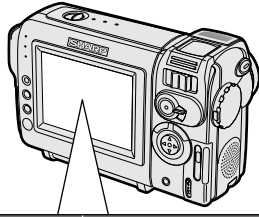

Displayed for the first 3 seconds	Displayed after 3 seconds	Description of warning
INSERT A CASSETTE.		There is no video cassette in the camcorder. Insert a cassette (see page 12).
EJECT THE CASSETTE.	EJECT THE CASSETTE.	The video cassette is defective and should be removed (see page 12).
CASSETTE NOT RECORDABLE.	PROTECT. TAB	The erasure protect tab on the video cassette has been slid to the record-protect position, preventing recording (see page 72).
THE TAPE ENDS SOON.	TAPE END	The tape is about to end. Prepare a new cassette (see page 12).
CHANGE THE CASSETTE.	TAPE END	The tape has reached the end. Replace it with a new cassette (see page 12).
BATTERY IS TOO LOW.		The battery is almost depleted. Replace it with a fully charged battery pack (see page 9).
DEW	DEW	Dew has formed inside the camcorder. Wait a few hours for the dew to dry away (see page iv). About 10 seconds after this warning appears, the camcorder automatically turns off.
		The video heads are clogged and should be cleaned (see page v).
LAMP	LAMP	The fluorescent lamp behind the LCD monitor is close to the end of its service life. Call your local authorized Sharp dealer to have it replaced.
USB	USB	The battery is almost depleted when the camcorder transfers data through the USB cable. Use the AC adapter or fully charged battery pack as the power source (see pages 9–11, 66).



Displayed for 5 seconds	Description of warning
NO MEMORY CARD	The card is not inserted or is inserted improperly. Check that it is properly inserted (see page 13).
MEMORY CARD FULL	The capacity of the card is full and cannot store any more images. Delete unnecessary images (see page 61) or replace the card with a new one (see page 13).
NO DATA ON MEMORY CARD	The card has no images recorded in the format the camcorder can recognize.
MEMORY CARD ERROR	The images in the card are corrupted or recorded in a format which is not compatible with this camcorder. Format the card to use it with this camcorder (see page 58).
FORMAT MEMORY CARD	The card has not been formatted with this camcorder. Format the card (see page 58).
MEMORY CARD PROTECTED	The card is write-protected (see pages 13, 74).
DATA PROTECTED	You are trying to delete a protected image. Cancel the protection setting (see page 60).
MEMORY CARD READ ERROR	The selected image cannot be read by this camcorder. Format the card to use it with this camcorder (see page 58).
CANNOT STORE DATA	The card cannot record any data due to a problem with the card or data on the card. Replace the card (see page 13).

Note:

-  indicates a flashing display.





Preparation

Preparation

Attaching and Removing the Battery Pack

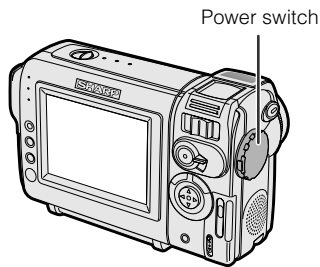
Attaching



- 1 Make sure that the Power switch is set to OFF.
- 2 Align the  mark on the side of the battery pack with the  mark on the camcorder (1), and slide the battery pack in the direction of the arrow completely until it locks into place (2).

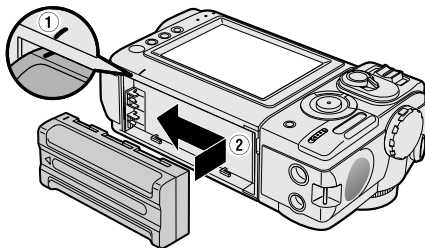

Removing

- 1 Make sure that the Power switch is set to OFF.
- 2 Rotate the monitor section of the camcorder (1), then press the battery release (2). Slide the battery pack in the direction of the arrow and take it out (3).

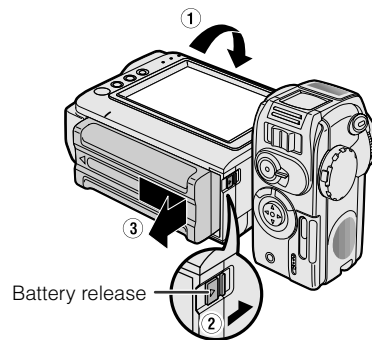

Cautions:

- **BEFORE REMOVING THE BATTERY PACK, ALWAYS STOP RECORDING OR PLAYBACK AND TURN THE POWER OFF.** Removing the battery pack while shooting or during playback may damage the tape by causing it to wrap around the video head drum or destroy the card, rendering it unreadable and unwritable.
- Remove the battery pack from the camcorder if you will not use the camcorder for a long period of time.
- Make sure that the battery pack is firmly attached during operation. If it is not, the battery pack may come off or camcorder operation may fall because of the poor contact pressure.
- To prevent damage to the battery pack when removing, be sure to firmly hold the battery pack while pressing the release.
- Use only SHARP model BT-L225 or BT-L445 battery packs with this camcorder. Use of other batteries may create a risk of fire or explosion.



Charging the Battery Pack

- 1 Attach the battery pack on the camcorder, and make sure that the Power switch is set to OFF.
- 2 Connect the supplied power cord to the AC power socket on the AC adapter, and insert the AC plug into a power outlet.

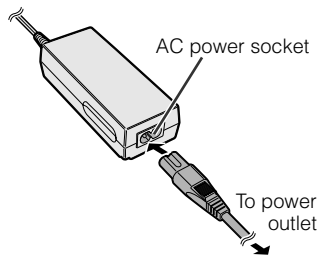

- 3 Insert the DC plug into the DC input jack.
 - The charge indicator lights up.

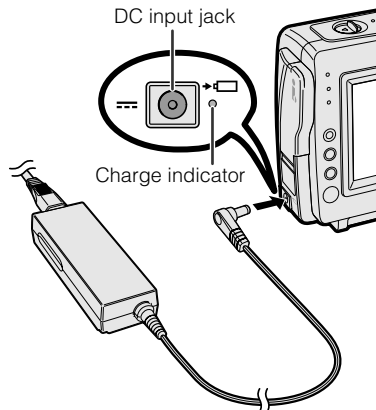

- The charge indicator turns off when the battery is charged.
- 4 Remove the DC plug from the DC input jack, then remove the AC plug from the power outlet.

Charging time and maximum continuous recording and playback times in TAPE modes

Battery pack	Charging time	Max. continuous recording time	Max. continuous playback time
BT-L225	approx. 2hr.	approx. 1hr. 30min.	approx. 1hr. 30min.
BT-L445	approx. 3hr. 30min.	approx. 3hr.	approx. 3hr.

Preparation

Notes:

- Charge the battery pack between 10°C and 30°C. The battery pack may not charge properly at temperatures too low or too high.
- The battery pack and charger become warm during charging. This is not a malfunction.
- Using the zoom (see page 21) and other functions or turning the power on and off frequently will increase power consumption. This may result in a decrease in the actual recording time compared to the maximum continuous recording time listed above.
- The charging time and recording time may vary depending on the ambient temperature and the condition of the battery pack.
- See page 75 for more information on using the battery pack.

Caution:

- Charge only SHARP model BT-L225 or BT-L445 battery packs. Other types of battery packs may burst, causing personal injury and damage.

Extending battery pack life

Even when the battery pack is not used, the capacity of the battery pack will naturally deteriorate over time. To limit the deterioration of the capacity, it is recommended to perform the following procedure at least once every six months:

- ① Fully charge the battery pack.
- ② Attach the battery pack to the camcorder, and set the Power switch to CAMERA without inserting a cassette. Allow the battery power to fully discharge by leaving it on the camcorder until the camcorder power automatically turns off.
- ③ Remove the battery pack and store it between 10°C and 20°C.



Preparation

Powering the Camcorder from an AC Outlet

You can also power the camcorder from a power outlet by using the supplied AC adapter.

Caution:

- The supplied AC adapter is specially designed for use with this camcorder, and should not be used as a power supply for other camcorders.

- 1 Make sure that the Power switch is set to OFF.
- 2 Connect the supplied power cord to the AC power socket on the AC adapter, and insert the AC plug into a power outlet.

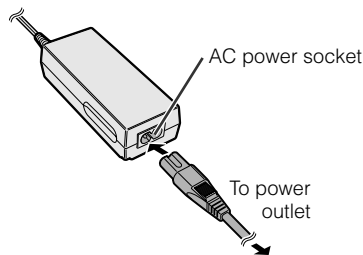

- 3 Insert the DC plug into the DC input jack.

- The camcorder is supplied power.

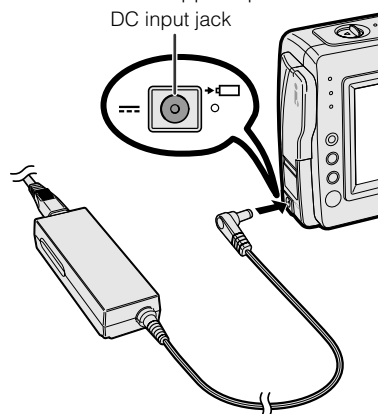

- 4 Hold down the Lock button and set the Power switch to CAMERA or VCR.

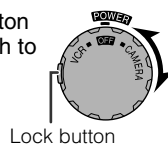



Inserting and Removing a Cassette

Inserting

- 1 Attach the power source to the camcorder, then slide the cassette compartment door release and open the cassette compartment door.
 - After confirmation sound, the cassette holder extends and opens automatically.

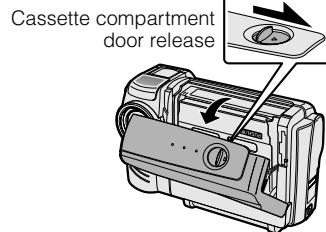

- 2 Insert a commercially available cassette fully with the window facing outwards, and with the erasure protect tab facing upwards.

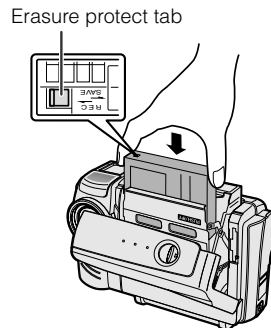

- 3 Press the **PUSH/押す** mark gently until the cassette holder clicks into place.
 - After confirmation sound, the cassette holder retracts automatically.

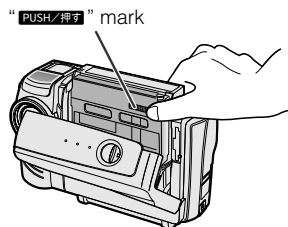

- 4 Wait for the cassette holder to fully retract. Close the compartment door by pressing the centre until it clicks into place.

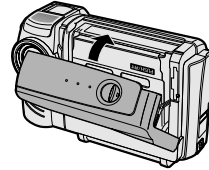

Removing

Perform step 1 above, then take out the cassette.

Cautions:

- Do not try to close the cassette compartment door while the cassette holder is extending or retracting.
- Be careful not to get your fingers caught in the cassette holder.
- Do not apply force to the cassette holder except when pressing the **PUSH/押す** mark to close it.
- Do not tilt the camcorder or hold it upside down when you are inserting or removing a cassette. It may damage the tape.
- Remove the cassette if you will not use the camcorder for a long period of time.
- If you do not correctly close the cassette holder in step 3, the cassette protection mechanism of the camcorder might eject the cassette. If this happens, repeat the insertion procedure.
- Do not attempt to pick up the camcorder by the cassette compartment door.

Notes:

- If the battery power is too low, you may not be able to eject the cassette. Replace the battery pack with a fully charged one.
- See page 72 for more information on the video cassette tapes intended for use with this camcorder.



Preparation

Inserting and Removing a Card

You can use an SD Memory Card or a MultiMediaCard for storing still images.

Inserting

- 1 Make sure that the Power switch is set to OFF.
- 2 Slide the card slot cover release and open the card slot cover in the direction of the arrow.

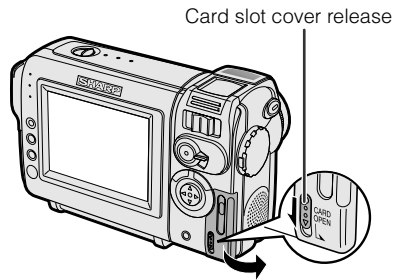

- 3 Insert a card into the slot as shown below, and push it in as far as it will go.

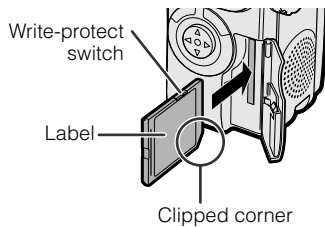

- 4 Close the card slot cover.

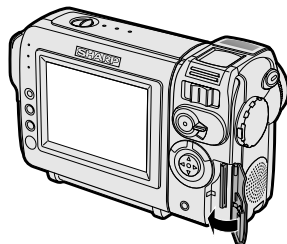

Removing

Perform steps 1 and 2 above, push the card (①) and pull the card straight out (②) as shown below.

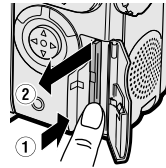

Notes:

- You can use only the SD Memory Card or the MultiMediaCard (see page 71).
- The supplied card is preformatted for immediate use.
- See pages 73 and 74 for more information on the cards intended for use with this camcorder.

Caution:

- Do not remove the card from the camcorder while recording data on the card (⏏ indicator flashes during recording). This may delete the recorded image or damage the card.

About the write-protect switch

SD Memory Card has a write-protect switch. When the switch is set to the locked position, you cannot record/delete data or format the card. Set it to the unlocked position to record/delete data or format the card.

Back view

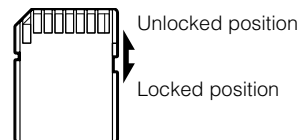



Installing the Lithium Battery

Installing

The supplied lithium battery is used to store the memory of the date and time settings.

- 1 Slide the cassette compartment door release and open the cassette compartment door.

Note:

- The cassette holder will extend and open when the camcorder is connected to a power source. Be sure to close the cassette holder before proceeding to the next step (see page 12).

- 2 Pull out the lithium battery holder using a pointed object such as the tip of a ballpoint pen.

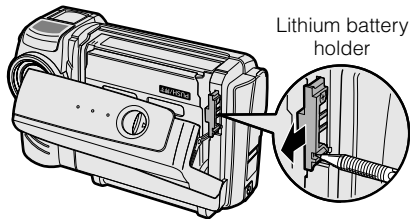

- 3 Insert the lithium battery into the battery holder with the + side of the battery facing the ⊕ side of the holder.

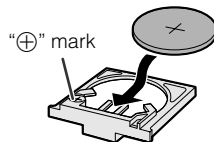

- 4 Push the battery holder back into position. Press the **PUSH/押し** mark gently, then close the cassette compartment door by pressing the centre until it clicks into place.

Removing

Perform steps 1 and 2 above, then lift out the battery from the battery holder.

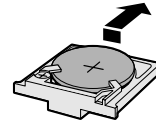

Notes on the Use of the Lithium battery

CAUTION: Danger of explosion if battery is incorrectly replaced. Replace only with the same or equivalent type CR2025 recommended by the equipment manufacturer.

WARNING: KEEP THIS BATTERY AWAY FROM CHILDREN. IF SWALLOWED, CONSULT A PHYSICIAN IMMEDIATELY FOR EMERGENCY TREATMENT.

CAUTION: BATTERY MAY EXPLODE IF MIS-USED OR INSTALLED WITH POLARITY REVERSED. DO NOT RECHARGE, DISASSEMBLE OR DISPOSE OF IN FIRE.

- Do not short-circuit, recharge, disassemble, or heat the lithium battery.
- Should the lithium battery leak, wipe the battery compartment clean, and then insert a new battery.
- The lithium battery will last about one year under normal usage.



Preparation

Setting the Date and Time

Available modes:
TAPE-CAMERA, CARD-CAMERA

Example: Setting the date to 2 June 2003 (2. 6. 2003) and the time to 10:30 am (10:30).

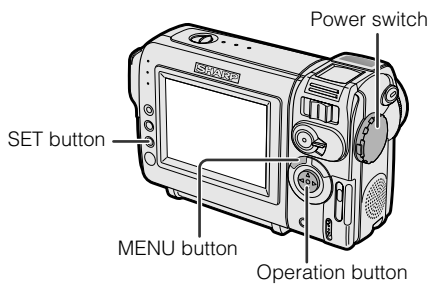

Note:

- Before performing the steps below, make sure that the lithium battery has been installed (see page 14).

- 1 Hold down the Lock button and set the Power switch to CAMERA.

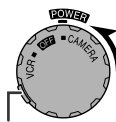

Lock button

- 2 Press the MENU button until the menu screen appears.

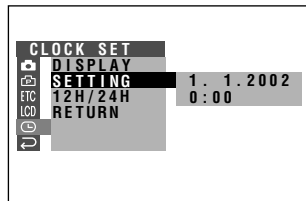

- 3 Press the SET button.



- 4 Press ∇ or Δ to select "2" (day), then press the SET button.



- 5 Press ∇ or Δ to select "6" (month), then press the SET button.



- 6 Press ∇ or Δ to select "2003" (year), then press the SET button.



- 7 Press ∇ or Δ to select "10" (hour), then press the SET button.



- 8 Press ∇ or Δ to select "30" (minute), then press the SET button.
 - The internal clock now starts operating.



- 9 Press the MENU button to turn off the menu screen.

Note:

- If the date and time have been set, the SETTING 1 screen (📷) appears in step 2. Select "SETTING" in the CLOCK SET screen (📷) using the Operation button and SET button.



Changing to the 12-hour Time Mode

- 1 After performing step 8 above, press ∇ or Δ to select "12H/24H", then press the SET button.

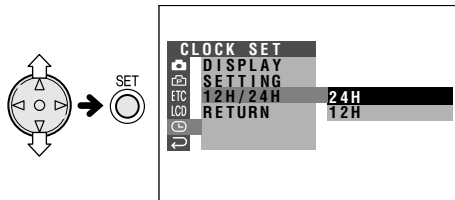

- 2 Press ∇ or Δ to select "12H", then press the SET button.

12H/24H 12H

- 3 Press the MENU button to turn off the menu screen.

Notes:

- The date and time, once set, are internally recorded even when not displayed on the screen.
- The menu screen automatically turns off if no settings are made within five minutes.

Attaching the Lens Hood

When recording outdoors on a sunny day or in a location with bright lighting, attach the supplied lens hood to the camcorder. Turn the lens hood in the direction of the arrow to attach it.

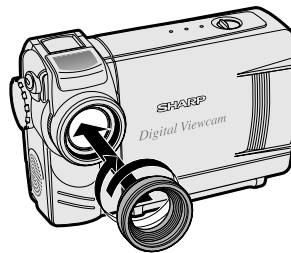

To remove it, turn it in the opposite direction.

Notes:

- The lens cap can still be attached on top of the lens hood.
- Filters and other accessories cannot be attached on the top of the lens hood.

Attaching the Wrist Strap

Attach the wrist strap to the wrist strap loop as shown below.

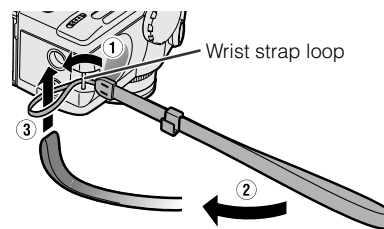

Caution:

- Do not swing the camcorder by the strap.

Preparation



Preparation

Using the Lens Cap

Preparation

Attach the strap to the lens cap as shown below.

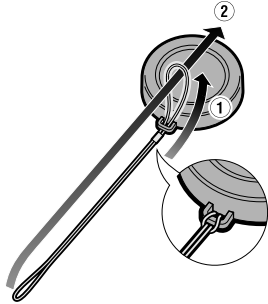

Always attach the lens cap over the lens when not using the camcorder.

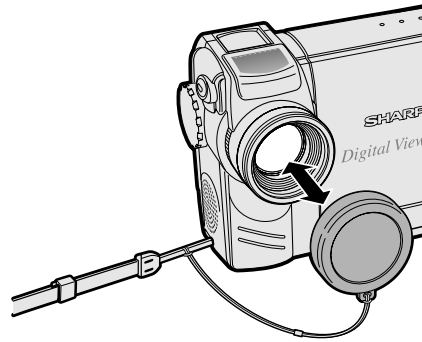

Attach the strap of the lens cap to the wrist strap as shown below.

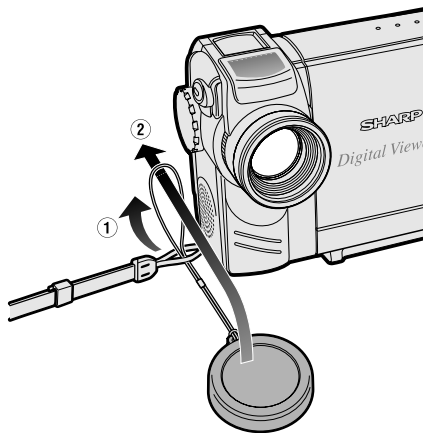

When recording, hang the lens cap on the wrist strap to keep the cap out of the way.

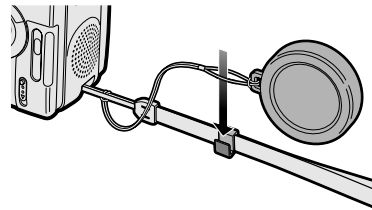



Tips on Recording Positions

To create images that are easy to watch during playback, try to record with an upright posture and steady hand to prevent a shaky image.

Holding the camcorder

Place your right thumb close to the REC START/STOP button and Power Zoom control. Place your left thumb on the thumb rest on the left side of the screen.

Preparation

Basic posture

Shooting from a high angle

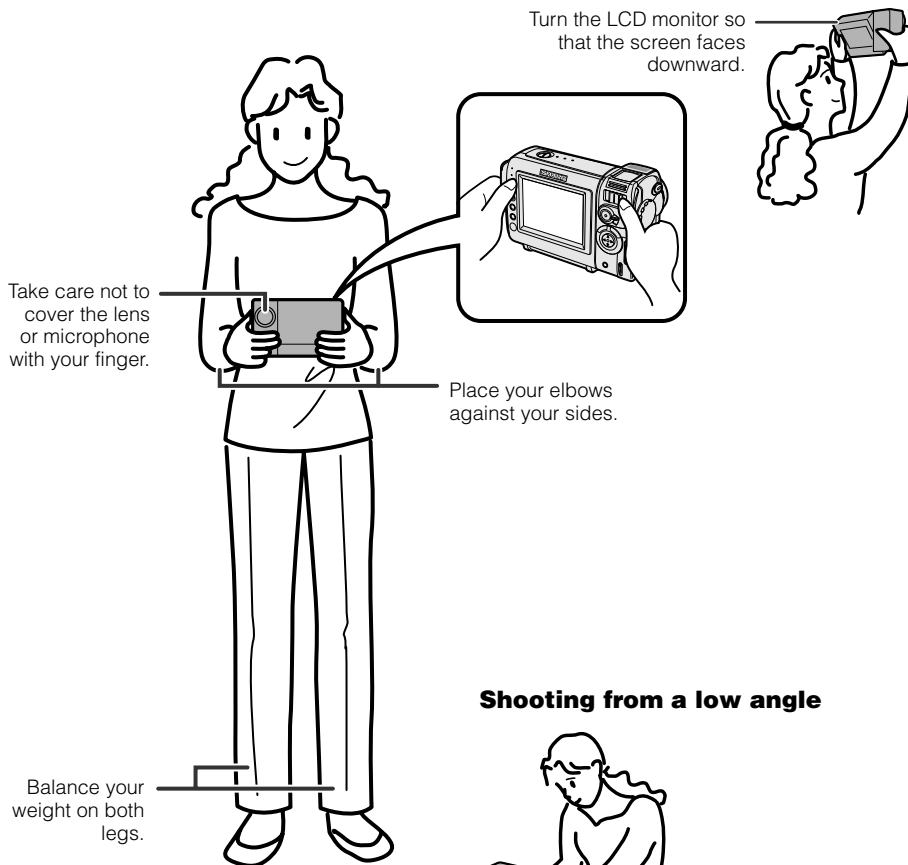

Shooting from a low angle

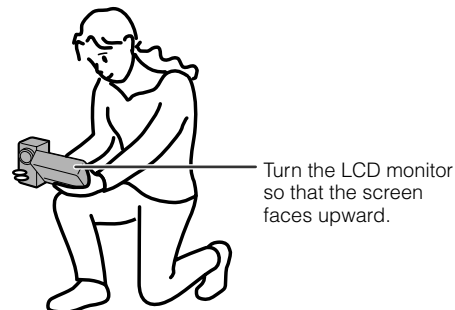



Basic Operations

Camera Recording

Selecting the Camcorder Mode

This camcorder includes functions for use as both a video camera for recording and playing back images on tapes and as a digital still camera for recording and playing back still images on cards. One of the following camcorder modes needs to be set before starting any operation.

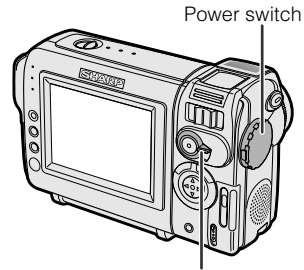

Power switch

Media Selection switch

Basic Operations

Camcorder modes

TAPE-CAMERA mode

For recording motion and still images on a tape.

- 1 Set the Media Selection switch to TAPE.

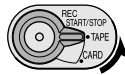

- 2 Hold down the Lock button and set the Power switch to CAMERA.

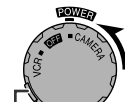

Lock button

TAPE-VCR mode

For playing back or editing motion and still images recorded on a tape.

- 1 Set the Media Selection switch to TAPE.

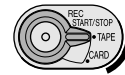

- 2 Hold down the Lock button and set the Power switch to VCR.

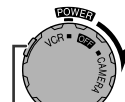

Lock button

CARD-CAMERA mode

For recording still images on a card.

- 1 Set the Media Selection switch to CARD.



- 2 Hold down the Lock button and set the Power switch to CAMERA.

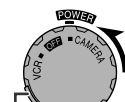

Lock button

CARD-VCR mode

For playing back still images recorded on a card.

- 1 Set the Media Selection switch to CARD.



- 2 Hold down the Lock button and set the Power switch to VCR.

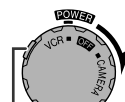

Lock button

Note:

- To turn the power off, set the Power switch to OFF without pressing the Lock button.

Caution:

- Do not change the camcorder mode by operating the Media Selection switch during recording or playback, as this may cause damage to the tape or card.







Easy Camera Recording on Tape in Full Auto Mode

Available mode:
TAPE-CAMERA

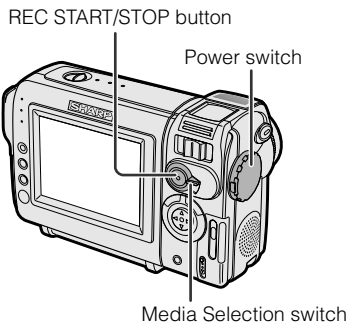
- Before you start recording, perform the operations described on pages 9 through 18 to prepare your camcorder for recording.



- 1 Remove the lens cap.
- 2 Set the Media Selection switch to TAPE. 
- 3 Hold down the Lock button and set the Power switch to CAMERA.
 - The picture from the lens now displays.
 - The camcorder is now ready to record (Recording Standby mode).

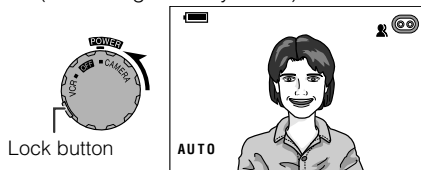

Note:

- If "AUTO" is not displayed at this time, set the camcorder to Full Auto mode (see page 44).

- 4 Press the REC START/STOP button to begin recording.

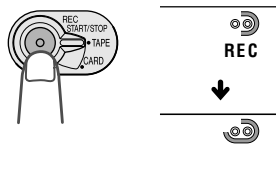

To pause recording

Press the REC START/STOP button again. Recording pauses, and the camcorder enters Recording Standby mode.

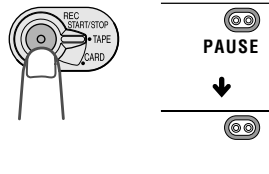

To turn the power off

Set the Power switch to OFF without pressing the Lock button.

Notes:

- Battery power is consumed in Recording Standby mode. Turn off the power if you will not be recording again soon.
- If the camcorder remains in Recording Standby mode for more than 5 minutes in TAPE-CAMERA mode, the power will automatically turn off to save battery power and to protect the tape from being damaged. To resume recording, set the Power switch to OFF and then back to CAMERA. (The camcorder will make a confirmation sound when it is left in Recording Standby mode for about 4 minutes.)

Maximum continuous recording and actual recording times in TAPE-CAMERA mode

Battery pack	Max. continuous recording time	Actual recording time
BT-L225	approx. 1hr. 30min.	approx. 50min.
BT-L445	approx. 3hr.	approx. 1hr. 40min.

Note:

- **Using the zoom (see page 21) and other functions or turning the power on and off frequently will increase power consumption. This may result in a decrease in the actual recording time compared to the maximum continuous recording time listed above.**



Basic Operations Camera Recording

Zooming

Available modes:

TAPE-CAMERA, CARD-CAMERA

Zooming allows you to move visually closer to or farther from a subject without physically changing your position.

When using the optical zoom, you can enlarge the subject up to 10x.

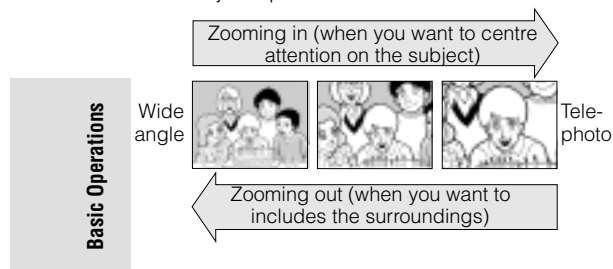

Basic Operations

Zooming in

Push the Power Zoom control to the T (tele-photo) side to get a close-up view (1).

Zooming out

Push the Power Zoom control to the W (wide angle) side to get a wide field of view (2).

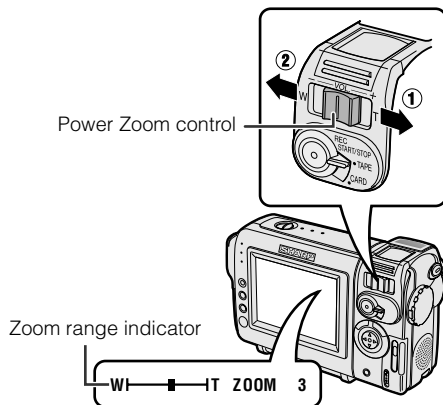

- The zoom range indicator shows you the current zoom setting.
- The zoom speed depends on how far you push the Power Zoom control.

Notes:

- The camcorder is unable to focus when zooming in on subjects within 1.5 m. The camcorder will automatically zoom out until it is able to focus on the subject.
- See page 28 for how to use the digital zoom.

Auto Focus

Available modes:

TAPE-CAMERA, CARD-CAMERA

The camcorder is preset to Auto Focus mode, which is designed to focus on most types of subjects. In Auto Focus mode, the camcorder automatically focuses on the subject in the centre of the scene. Always keep the subject in the centre of the scene.

Notes:

- If no subject is in the centre of the scene, the focus area will expand and the subject nearest the centre will be focused on.
- If no subject is displayed, the camcorder will automatically zoom out until a subject comes into the frame.
- Auto Focus may not work in the situations described on page 42. In these situations, use the manual focus function.

Macro Shots

Available modes:

TAPE-CAMERA, CARD-CAMERA

This camcorder lets you shoot close-up images of small objects such as flowers and insects, or make title frames for your videos. When you want to record a magnified image of a subject which is within approximately 1.5 m of the camcorder, do not zoom in on it. Instead, zoom out all the way by pushing the Power Zoom control to the W side, and then move the camcorder closer to the subject until you obtain the desired angle of view. The camcorder will automatically focus on the subject when the lens is set for the widest angle.

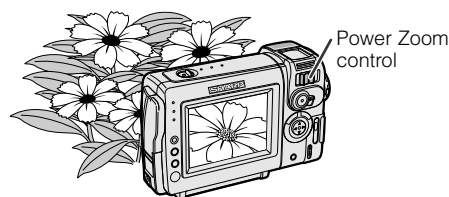

Note:

- When you are recording a macro shot, be sure that the subject receives sufficient illumination.



Remaining Recording Time Display

Available mode:
TAPE-CAMERA

When the camcorder is recording in TAPE-CAMERA mode, an on-screen indicator displays the approximate remaining tape time in minutes.

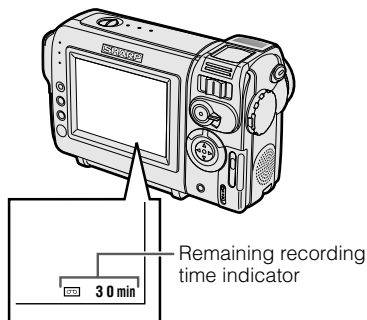

Notes:

- The remaining recording time indicator appears when the on-screen indicators are turned on.
- The remaining recording time indicator appears 10 seconds after pressing the REC START/STOP button to begin recording.
- The remaining recording time indicator only shows the approximate time left. Also, it varies slightly depending on the length of tape used. (This function is based on the DVM60 tape standard.)

When the remaining recording time reaches 1 minute, a warning indicator will appear. Prepare a new cassette.

Warning indicator	Approx. remaining time
<p>THE TAPE ENDS SOON.</p> <p>↓</p> <p>TAPE END</p>	Less than 1 min.
<p>CHANGE THE CASSETTE.</p> <p>↓</p> <p>TAPE END</p>	The tape has reached the end.

Remaining Battery Power Display

Available modes:
All modes

When using the camcorder with the battery pack as the power source, the remaining battery power indicator is displayed. If the battery power becomes very low, a warning indicator appears. Replace the battery pack.

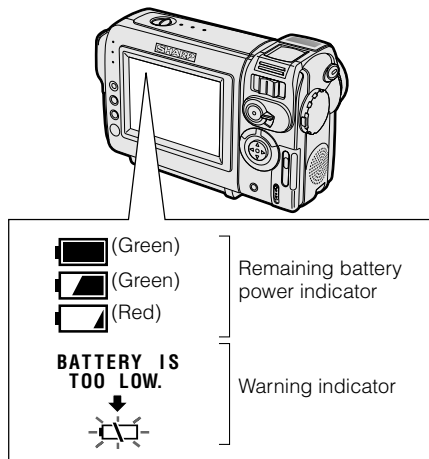

Notes:

- The remaining battery power indicator appears when the on-screen indicators are turned on.
- Use the remaining battery power indicator only as an approximate indication.
- The remaining battery power indicator may change to either a higher or lower level if you set the Power switch to OFF and then back to CAMERA or VCR.
- In cold environments, the red remaining battery power indicator may appear sooner.
- Use of the zoom functions when the warning indicator is displayed may cause the camcorder to suddenly lose power.



Basic Operations

Playback

Basic Operations



Tape Playback

Available mode:
TAPE-VCR

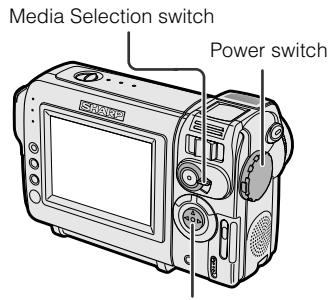
The LCD monitor screen functions as a handy playback monitor. Nothing needs to be connected, allowing instant on-screen playback with the sound through the built-in speaker.

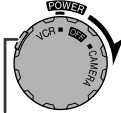

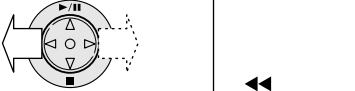
- 1 Set the Media Selection switch to TAPE. 
- 2 Hold down the Lock button and set the Power switch to VCR. 

- 3 Press ◀ (or ▶) on the Operation button to rewind (or fast forward) the tape to the desired point. 
- 4 Press ▲ to begin playback. 

Note:

- If you press the REC START/STOP button in TAPE-VCR mode, the "Ⓜ" mark appears and the camcorder enters Recording Standby mode. If you do not intend to record, press ▼ to turn the "Ⓜ" mark off, then press ▲ to begin playback. This will ensure your previous recording is not erased (see pages 49, 51).

To stop playback

Press ▼.

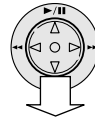

To turn the power off

Set the Power switch to OFF without pressing the Lock button.

Note:

- The tape is automatically rewound when playback reaches the end of the tape.

Using Earphones (Commercially Available)

Available modes:
TAPE-VCR, TAPE-CAMERA

You can monitor the sound via stereo earphones (commercially available) during playback or recording. Stereo earphones with a 3.5 mm diameter plug can be used with this camcorder.

Connect the plug of stereo earphones to the PHONES jack on the camcorder as shown below.

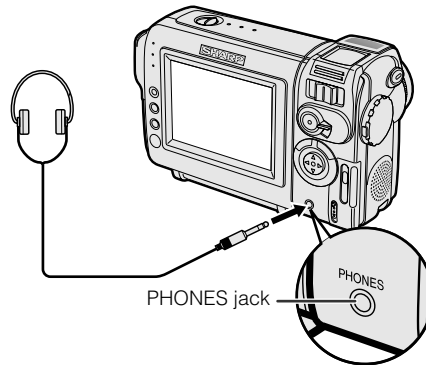

Notes:

- Before connecting stereo earphones, turn the camcorder volume down to the lowest setting.
- The built-in speaker automatically turns off when stereo earphones are connected to the PHONES jack.



Volume Control

Available mode:
TAPE-VCR

When the camcorder is in TAPE-VCR mode, push the Volume control to the + or - side to increase (①) or decrease (②) the volume.

The volume level indicator will appear on the LCD screen during adjustment only. Once the Volume control is released, the volume level indicator will disappear shortly afterwards.

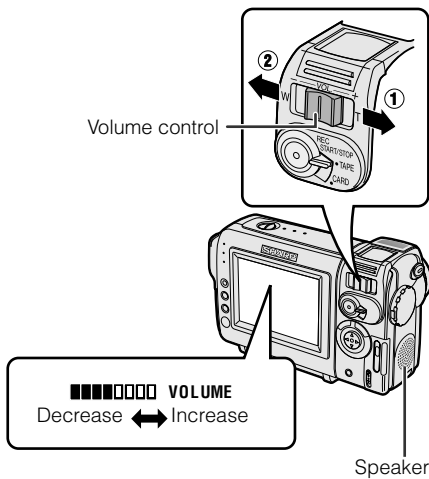

Still

Available mode:
TAPE-VCR

The still function allows you to pause playback in TAPE-VCR mode.

During playback in TAPE-VCR mode, press Δ on the Operation button.

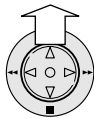

To return to normal playback, press Δ again.

Notes:

- The sound is off in Still mode.
- To protect the tape, the camcorder automatically returns to normal playback if it is left in Still mode for more than 5 minutes.

Video Search

Available mode:
TAPE-VCR

The video search function makes it easy to search for a desired scene on the tape.

Searching for a Scene Near the Current Tape Position

- 1 During playback in TAPE-VCR mode, press \triangleright (or \triangleleft) on the Operation button.
 - The playback picture fast forwards (or reverses).

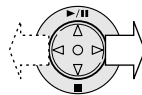

- 2 When you find the scene, press Δ to return to normal playback.

Searching for a Scene Far from the Current Tape Position

- 1 During fast forward (or rewind) in TAPE-VCR mode, press and hold \triangleright (or \triangleleft) on the Operation button.
 - The fast forward (or rewind) picture displays.
- 2 If the scene is still rather far from the current tape position, release the Operation button to normal fast forward (or rewind).
- 3 Repeat steps 1 and 2 above until you find the scene.
- 4 Press Δ to begin normal playback.

Notes:

- The sound is off during search.
- You may experience picture noise during search. This is not a malfunction.



Basic Operations Playback

Watching Playback on a TV

Available modes:
TAPE-VCR, CARD-VCR

You can connect the camcorder to a TV to allow a larger audience to enjoy playback.

- 1 Open the jack cover on the camcorder (see page 2).

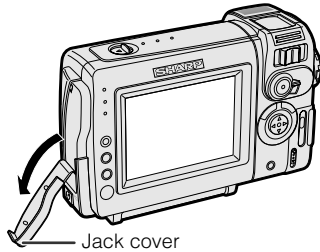

- 2 Connect the camcorder to your TV (or VCR) with the supplied audio/video cable, as shown.

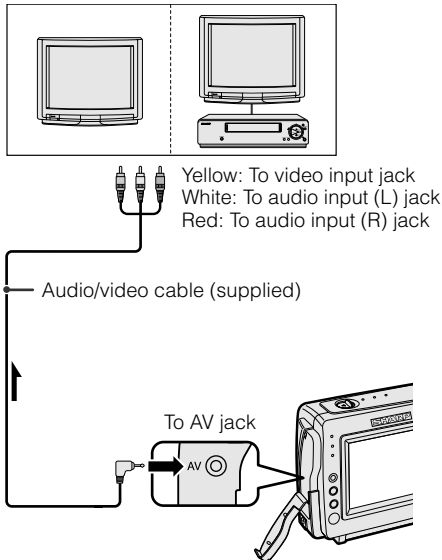

←: The arrow shows the signal flow.

Caution:

- Check that the camcorder, TV, VCR and other equipment to be used are turned off before making any connections. Picture noise or malfunction may occur if any of the above is left on while making a connection.

- 3 Turn on the TV and set it to the "AV" or "VIDEO" channel. (See the operation manual of your TV.)
 - When connecting to a TV via a VCR, turn on the VCR and set it to the "AV" or "LINE" input channel. Operate the TV as you normally do to view the signal from the VCR. (See the operation manuals of your TV and VCR.)
- 4 Set the Power switch on the camcorder to VCR, and begin playback (see page 23).

Notes:

- If your TV or VCR has a 21-pin Euro-SCART connector, use the RCA/21-pin Euro-SCART conversion connector (QSOCZ0033TAZZ) available from our main parts distributor detailed on page 78.



- If your TV or VCR has only one audio input jack, use the white plug for the audio connection on the TV or VCR.
- Close the jack cover after use.

Useful Features

Using the Menu Screens

Use the menu screens to adjust the various camcorder settings.

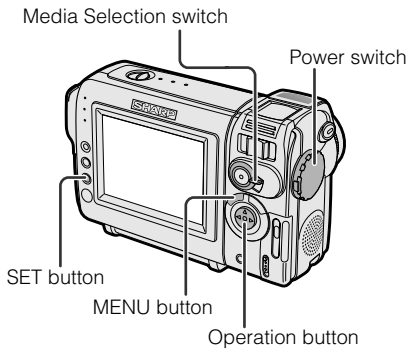

- 1 Set to the desired camcorder mode (see page 19).

- See pages 4 and 5 for the menu items you can select in each camcorder mode.

- Steps 2 to 5 show how to change the DGTL ZOOM menu setting in TAPE-CAMERA mode.

- 2 Press the MENU button until the menu screen appears.

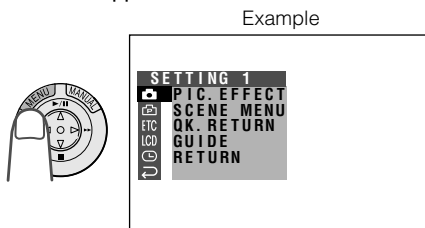

Note:

- The menu screen does not appear during recording.

- 3 Press ∇ or Δ on the Operation button to select the desired menu screen (▶), then press the SET button.

Example

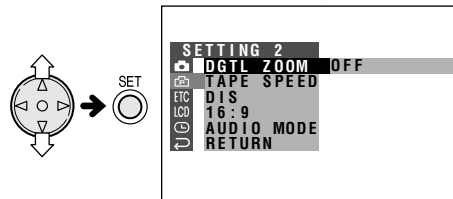

- You can press \triangleright , instead of the SET button.

- 4 Press ∇ or Δ to select the desired menu item (DGTL ZOOM), then press the SET button.

Example

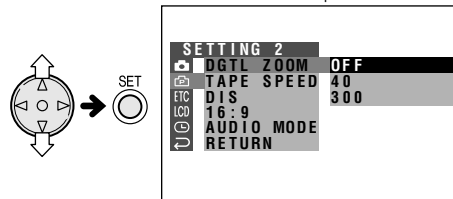

- You can press \triangleright , instead of the SET button.

- 5 Press ∇ or Δ to select the desired menu setting, then press the SET button.

DGTL ZOOM 40

- You can press \triangleright , instead of the SET button.
- To adjust another menu item, press ∇ or Δ to select "RETURN" and press the SET button, then perform steps 3 to 5.

To turn off the menu screen

Press the MENU button.

Notes:

- Certain menu items are common to all camcorder modes. If the BEEP menu item, for example, is set to "OFF" in TAPE-CAMERA mode, it will be automatically set to "OFF" in other modes.
- The menu screen automatically turns off if no settings are made within five minutes.
- Items that are not selectable are greyed out.



Useful Features

Camera Recording

Displaying the Recording Guide

Available modes:

TAPE-CAMERA, CARD-CAMERA

This function helps you decide on the size of the subject occupying the screen. Select one of five recording guides.

Types



Cross: A cross mark at the centre of the screen for placing the subject at the centre.



Focus: Focus brackets for guiding you to the focus area.

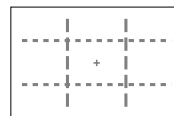

Landscape: Grid lines dividing the screen into 9 areas to help you with the horizontal and vertical composition.

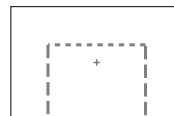

Snapshot: For capturing a small group of friends in a frame with surrounding background.

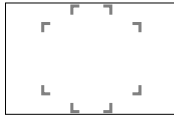

Portrait: Green frame fitting a full-body view and yellow frame fitting an upper-body view.

Turning on the recording guide

• The example screens shown are for TAPE-CAMERA mode.

- 1 In TAPE-CAMERA or CARD-CAMERA mode, press the MENU button until the menu screen appears.
- 2 Press ∇ or Δ on the operation button to select , then press the SET button.
- 3 Press ∇ or Δ to select "GUIDE", then press the SET button.

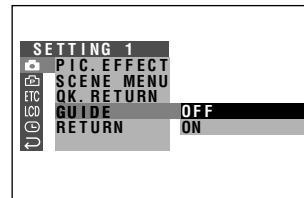
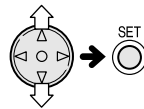

- 4 Press ∇ or Δ to select "ON", then press the SET button.

GUIDE ON

- 5 Press the MENU button to turn off the menu screen.

Selecting the recording guide

Press ∇ or Δ on the Operation button.

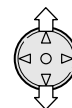

To turn off the recording guide

Select "OFF" in step 4 above, then press the SET button.

Note:

• When using manual focus, you cannot change the recording guide.



Setting the Digital Zoom

Available modes:

TAPE-CAMERA, CARD-CAMERA

You can select three different zoom ranges: 1–10× (optical zoom), 10–40× (digital zoom) or 10–300× (digital zoom). The digital zoom allows you to record powerful close-up pictures with the same operation as normal zooming.

Notes:

- The digital zoom is in addition to the optical zoom giving a combined maximum zoom range of 1–300×.
- **As the image is enlarged digitally, the picture quality decreases when higher digital zoom settings are used.**

- 1 In TAPE-CAMERA or CARD-CAMERA mode, press the MENU button until the menu screen appears.
- 2 Press ∇ or Δ on the operation button to select \square , then press the SET button.
- 3 Press ∇ or Δ to select "DGTL ZOOM", then press the SET button.

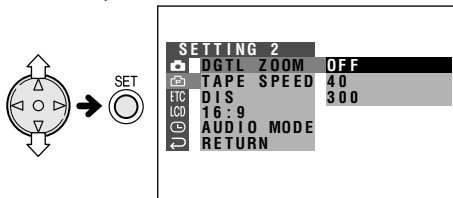

- 4 Press ∇ or Δ to select "40" or "300", then press the SET button.

DGTL ZOOM 40

- 5 Press the MENU button to turn off the menu screen.

The "D" digital zoom indicator is displayed during digital zooming.

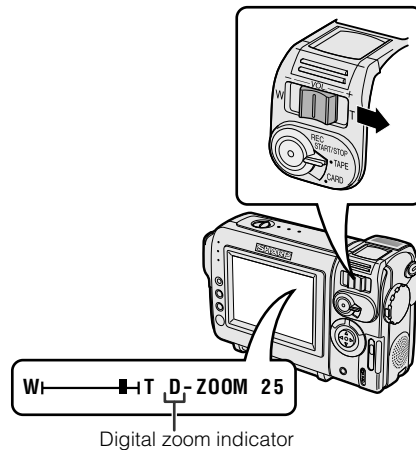

To use optical zoom only

Select "OFF" in step 4 above.



Useful features Camera Recording

Gamma Brightness Compensation

Available modes:

TAPE-CAMERA, CARD-CAMERA

When the subject is backlit, the image will appear dark if it is recorded normally. The gamma brightness compensation function improves the picture by increasing the brightness of the subject while leaving the brighter portion of the image unaffected.

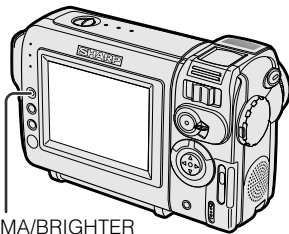

GAMMA/BRIGHTER button

Useful Features

In TAPE-CAMERA or CARD-CAMERA mode, press the GAMMA/BRIGHTER button once.

- "GAMMA" appears, indicating that Gamma Brightness Compensation is now working.



To obtain a brighter picture

Press the GAMMA/BRIGHTER button again.

- The  indicator appears.



Note:

- When the  indicator is displayed, the background will become slightly brighter.

To cancel Gamma Brightness Compensation

Press the GAMMA/BRIGHTER button until "GAMMA" disappears.



Gain-up

Available modes:

TAPE-CAMERA, CARD-CAMERA

When you are recording in a dark or poorly illuminated location, "LIGHT" is displayed on the screen. Use the gain-up function to record a brighter picture.

Note:

- At locations where lighting is adequate, "LIGHT" will not appear. The gain-up function cannot be used in this case.

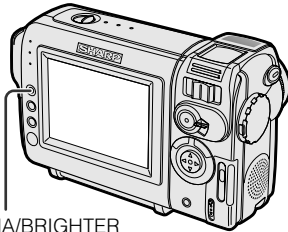

GAMMA/BRIGHTER button

In TAPE-CAMERA or CARD-CAMERA mode, press the GAMMA/BRIGHTER button once.

- "GAMMA" appears, indicating that the gain-up function is now working.

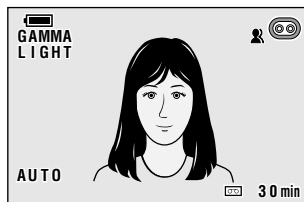
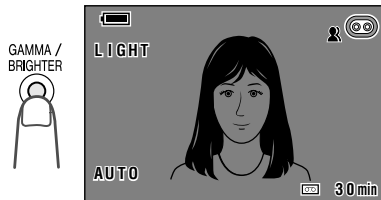

To obtain a brighter picture

Press the GAMMA/BRIGHTER button again.

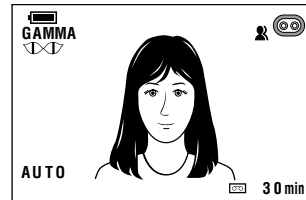

- The  indicator appears.



To cancel the gain-up function

Press the GAMMA/BRIGHTER button until "GAMMA" disappears.

Notes:

- You may experience some picture noise in Gain-up mode, which increases when the  displays.
- When the  indicator displays, you may get a shadow image behind a subject that is moving around a lot.
- Fine brightness adjustments are possible when using manual exposure (see page 43).
- Gain-up will cancel if you aim the camcorder in a bright location.



Useful Features Camera Recording

Fade In and Fade Out

Available mode:
TAPE-CAMERA

The fade function allows you to gradually bring the image and sound in or out at the beginning or end of a scene for creating scene transitions. This is especially effective in creating a dramatic change in scenery.

REC START/STOP button

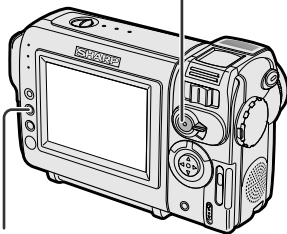

FADE button

Useful Features

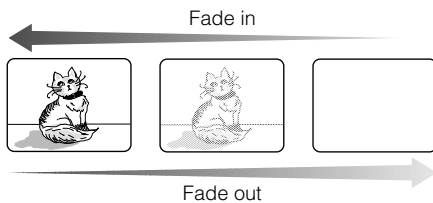

- Press the REC START/STOP button to begin recording.
 - The picture turns white, and the image and sound fade in.



- Press the REC START/STOP button at the point where you wish to stop recording.
 - The image and sound fade out as the picture gradually turns white. The camcorder then returns to Recording Standby mode.

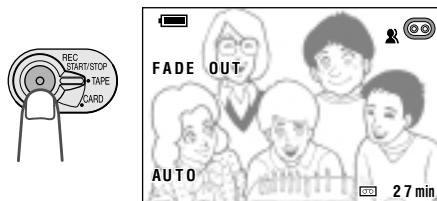

To cancel Fade mode

Press the FADE button again in Recording Standby mode.

To use Fade Out only

- During camera recording in TAPE-CAMERA mode, press the FADE button to display "FADE".
- Press the REC START/STOP button at the point where you wish to stop recording.

Note:

- Fade mode automatically cancels after Fade Out.

Using

- In TAPE-CAMERA mode, press the FADE button.
 - "FADE" appears.





Quick Return

Available mode:
TAPE-CAMERA

If while playing back your tape you want to quickly return to the last recorded scene and start recording again, use the quick return function.

- 1 Set the camcorder to TAPE-CAMERA mode.
- 2 In Recording Standby mode, press the MENU button until the menu screen appears.
- 3 Press ∇ or Δ on the operation button to select , then press the SET button.
- 4 Press ∇ or Δ to select "QK. RETURN", then press the SET button.

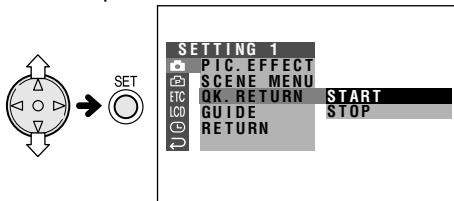

- 5 Press ∇ or Δ to select "START", then press the SET button.
 - "SEARCH" flashes, and the tape begins fast forwarding or rewinding to the end of the last recorded scene.



- When the tape reaches the end of the last recorded scene, "FINISHED" is displayed, and the camcorder enters Recording Standby mode.

- 6 Press the MENU button to turn off the menu screen.

Notes:

- To cancel the quick return function while "SEARCH" is flashing, press the SET button twice.
- Quick return will not work if you remove the cassette and reload it after recording or if nothing has been recorded since loading.

Edit Search

Available mode:
TAPE-CAMERA

The edit search function lets you search, without switching from TAPE-CAMERA mode to TAPE-VCR mode, for the point on the tape where you wish to start recording next.

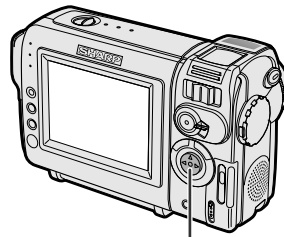

Operation button

- 1 Set the camcorder to TAPE-CAMERA mode.
- 2 In Recording Standby mode, press and hold down \triangleleft (reverse edit search) or \triangleright (forward edit search) on the Operation button.

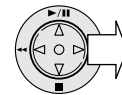
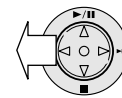

- 3 When you find the point where you want to begin recording, release the button.

Notes:

- The sound is off during search.
- Forward edit search is performed at the same speed as normal playback, and reverse edit search at 6.5 times the normal playback.
- You may experience picture noise during reverse edit search.

Useful Features



Useful Features Camera Recording

Still Recording on Tape

Available mode:
TAPE-CAMERA

You can record continuous still images of subjects.

- 1** Set the camcorder to TAPE-CAMERA mode.
- 2** In Recording Standby mode, press the STILL button fully.
 - A still image of the subject is displayed.
- 3** Press the REC START/STOP button.
 - The still image of the subject will be recorded.



Useful Features

To pause recording

Press the REC START/STOP button.

To cancel the still image

Press the STILL button fully.

Notes:

- Still Recording can also be used during recording by pressing the STILL button fully.
- The picture quality in Still Recording function will be slightly lower than normal pictures.

Attaching the Supplied Tripod Adapter

Attach the supplied tripod adapter when using a tripod with the camcorder.

- 1** Align the tripod adapter with the tripod adapter socket on the bottom of the camcorder, then rotate as shown below.

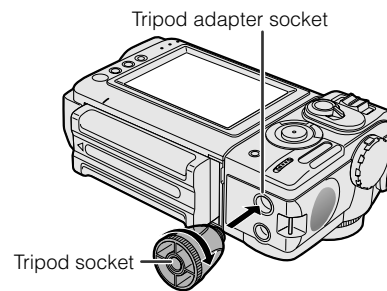

- 2** Attach tripod to tripod socket.



Note:

- You cannot use the supplied tripod adapter, if the alignment pin is not retractable.



Wide Screen (16:9)

Available mode:
TAPE-CAMERA

The wide screen function lets you record scenes with the wide-screen feel of a movie shown in a theatre. The top and bottom of the picture are masked with black bands to produce an effective screen aspect ratio of 16:9.

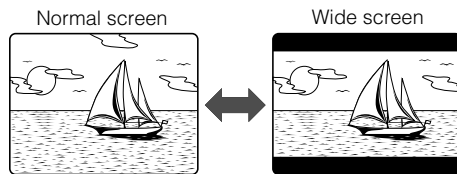

- 1 In TAPE-CAMERA mode, press the MENU button until the menu screen appears.
- 2 Press ∇ or Δ on the operation button to select \square , then press the SET button.
- 3 Press ∇ or Δ to select "16:9", then press the SET button.

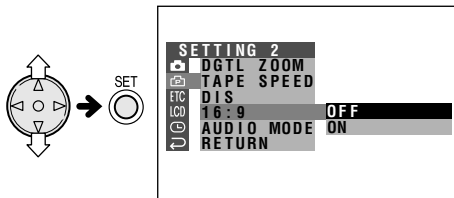

- 4 Press ∇ or Δ to select "ON", then press the SET button.
 - The picture is displayed with the top and bottom portions masked.

16:9 ON

- 5 Press the MENU button to turn off the menu screen.

To return to normal screen

Select "OFF" in step 4 above.

Digital Image Stabilization (DIS)

Available modes:
TAPE-CAMERA, CARD-CAMERA

The digital image stabilization (DIS) function allows you to stabilize the image by electronically compensating for relatively minor image shaking that is often annoying in close-up shots.

- 1 In TAPE-CAMERA or CARD-CAMERA mode, press the MENU button until the menu screen appears.
- 2 Press ∇ or Δ on the operation button to select \square , then press the SET button.
- 3 Press ∇ or Δ to select "DIS", then press the SET button.

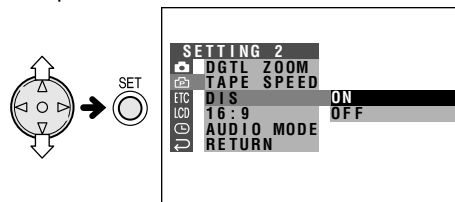

- 4 Press ∇ or Δ to select "ON", then press the SET button.

DIS ON

- 5 Press the MENU button to turn off the menu screen.
 - The DIS indicator only appears when the on-screen indicators are turned on.



To cancel DIS function

Select "OFF" in step 4 above. The  indicator will disappear.

Notes:

- The DIS function cannot compensate for excessive image shaking.
- When image shaking does not occur (e.g. when using the camcorder on a tripod), turn off the DIS function. The picture will appear more natural when the DIS function is off.



Useful Features Camera Recording

Self Recording

Available modes:

TAPE-CAMERA, CARD-CAMERA

Rotate the LCD monitor 180° vertically so that the screen faces the other way and the subject can monitor the shot while you are recording.

If the camcorder is steadied, you can record yourself in the scene by watching yourself on the LCD monitor. The remote control is useful for such occasions.



Useful Features

Cautions:

- Do not rotate the monitor section to the self recording position during recording or playback.
- **For recording in Self Recording mode, be sure to rotate the monitor section, NOT the lens section. If you hold the camcorder upside down with the lens at the bottom, the subject will be recorded upside down.**

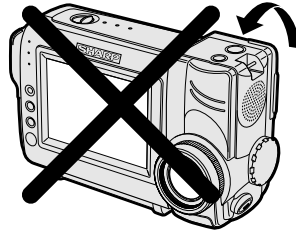

More Information on Self Recording

- Use the remote control to begin/stop recording on tape.
- The screen image automatically inverts when the monitor rotation is between 135° and 200°. When the monitor section is turned back to the normal position, the image returns to normal.
- You can play back images while the monitor is in the self recording position. Set the camcorder to TAPE-VCR mode. The Operation button still retains its function as during normal playback, for example, Δ on the Operation button works as the Play button.

- 1 Set the Media Selection switch to TAPE or CARD.
- 2 Set the Power switch to CAMERA.
- 3 Rotate the monitor section 180° vertically.
 - A mirror image of the subject displays on the LCD monitor.

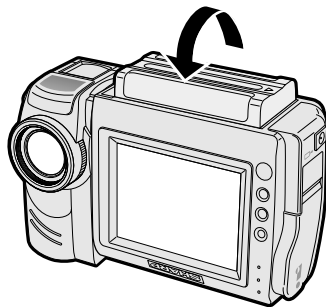

- 4 Begin recording.

35



Recording in LP (Long Play Recording) Mode

Available mode:
TAPE-CAMERA

This camcorder allows you to record in LP (Long Play Recording) mode for approximately 50% more recording time with the same picture quality as that in SP (Standard Play Recording) mode.

- 1 In TAPE-CAMERA mode, press the MENU button until the menu screen appears.
- 2 Press ∇ or Δ on the operation button to select , then press the SET button.
- 3 Press ∇ or Δ to select "TAPE SPEED", then press the SET button.

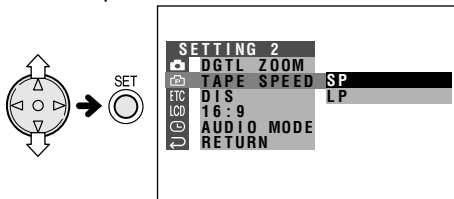

- 4 Press ∇ or Δ to select "LP", then press the SET button.

TAPE SPEED LP

- 5 Press the MENU button to turn off the menu screen.
 - The long play recording mode indicator only appears when the on-screen indicators are turned on.



Long play recording mode indicator

To return to SP mode

Select "SP" in step 4 above.

Notes on the use of LP mode

- To record in LP mode, be sure to use a Mini DV cassette labelled for use with LP mode.
- Frozen images, mosaic-pattern picture noise, audio interruptions or audio loss may occur in the following cases:
 - When using a tape which is not designated for use with LP mode.
 - When a tape recorded in LP mode under high temperature conditions is played back.
 - When a tape recorded in LP mode with the camcorder is played back on a Mini DV player or camcorder from another manufacturer.
 - When a tape recorded in LP mode is played back on a Mini DV player or camcorder without an LP function.
- Audio dubbing is not possible with LP mode recording.

Useful Features



Useful Features

Camera Recording

Selecting the 16-bit Audio Recording Mode

Available mode:
TAPE-CAMERA

The camcorder normally records audio in the 12-bit audio recording mode. For higher-quality audio recording, select the 16-bit audio recording mode.

- 1 In TAPE-CAMERA mode, press the MENU button until the menu screen appears.
- 2 Press ∇ or Δ on the operation button to select , then press the SET button.
- 3 Press ∇ or Δ to select "AUDIO MODE", then press the SET button.

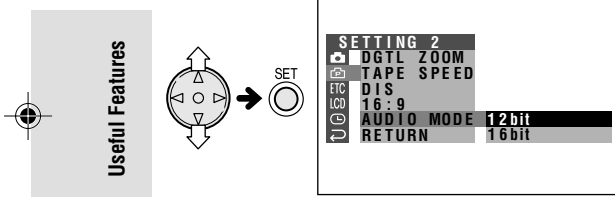

- 4 Press ∇ or Δ to select "16bit", then press the SET button.

AUDIO MODE 16bit

- 5 Press the MENU button to turn off the menu screen.
 - The 16-bit audio recording mode indicator only appears when the on-screen indicators are turned on.

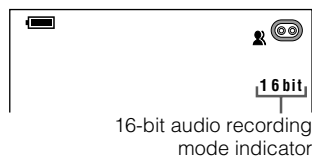

To return to 12-bit audio recording mode

Select "12bit" in step 4 above.

Note:

- When using Audio Dubbing with 16-bit audio recordings, both the dubbed and original sounds will be recorded in mono (see page 53).





Useful Features

Playback

Using the Remote Control

Available modes:
TAPE-CAMERA, TAPE-VCR

Use the remote control to operate the camcorder from a distance, such as when you want to record yourself in a scene, or when the camcorder is connected to a TV for use as a VCR.

Installing the Batteries

- 1 Open the battery compartment cover.
- 2 Insert the two supplied AA (R6 or UM/SUM-3) batteries with the battery poles positioned as indicated.

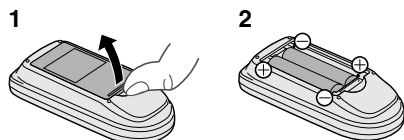

- 3 Place the cover.

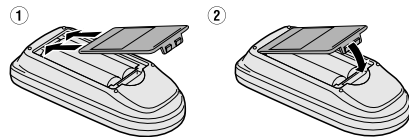

Activating

- 1 In TAPE-VCR (or CARD-VCR) mode, press the MENU button until the menu screen appears.
- 2 Press ∇ or Δ on the operation button to select ETC, then press the SET button.
- 3 Press ∇ or Δ to select "REMOTE", then press the SET button.

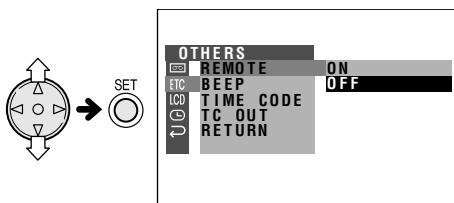

- 4 Press ∇ or Δ to select "ON", then press the SET button.

REMOTE ON

- 5 Press the MENU button to turn off the menu screen.

Operating

Aim the remote control at the remote sensor of the camcorder, and press the control buttons to operate.

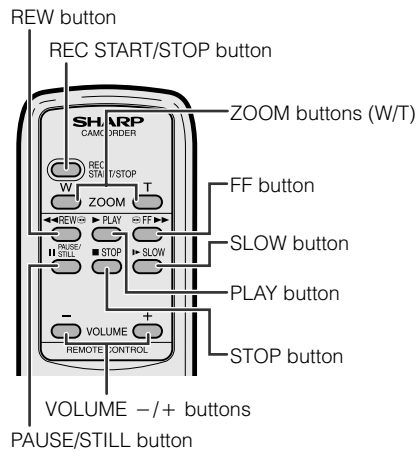
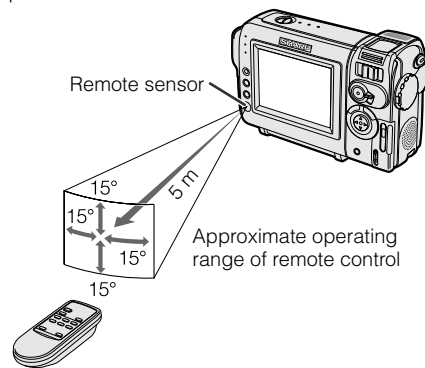

Notes:

- Do not use old and new batteries together or batteries of different brands together.
- Be careful not to expose the remote sensor to direct sunlight or strong interior lighting, as this may prevent the remote control from operating properly.
- Be sure that there are no obstacles between the remote control and the remote sensor.



Useful Features Playback

Displaying the Date and Time of Recording

Available modes:

All modes

Follow the procedure below to display the date, or both the date and time, of recording on the screen. You can display the date and time during both recording and playback.

- The example screens shown are for TAPE-CAMERA mode.

- Hold down the Lock button and set the Power switch to CAMERA or VCR.
- Press the MENU button until the menu screen appears.
- Press ∇ or Δ on the operation button to select CLOCK , then press the SET button.
- Press ∇ or Δ to select "DISPLAY", then press the SET button.

Useful Features

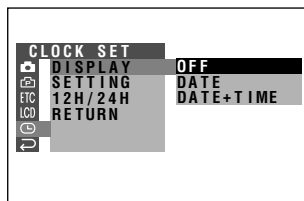
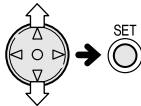

- Press ∇ or Δ to select "DATE" or "DATE + TIME", then press the SET button.

DISPLAY **DATE+TIME**

- Press the MENU button until the date (or date and time) displays.

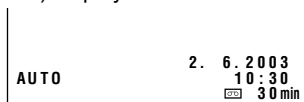

Notes:

- The date (or date and time) appears when the on-screen indicators are turned on.
- Before recording, make sure that the date and time have been correctly set. If they have not been set, the display will be left blank when playing back the recording. (The display will also be left blank for unrecorded or damaged portions of the tape.)
- In TAPE-VCR or CARD-VCR mode, the current date and time are displayed when the tape or card is not being played back.

Slow

Available mode:

TAPE-VCR

This function allows you to play back images in slow motion.

During playback in TAPE-VCR mode, press SLOW button (\blacktriangleright) on the remote control.

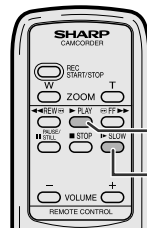

PLAY button

SLOW button

To return to normal playback, press PLAY button (\blacktriangleright).

Notes:

- The sound is off in Slow mode.
- To protect the tape, the camcorder automatically returns to normal playback if it is left in Slow mode for more than 10 minutes.



Gamma Playback

Available mode:
TAPE-VCR

The gamma playback function improves the playback picture in TAPE-VCR mode by increasing the brightness of the subject while leaving the brighter portions of the image unaffected.

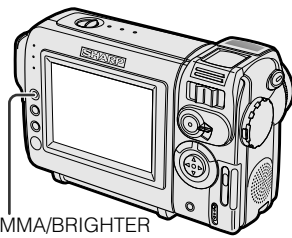

GAMMA/BRIGHTER button

During playback in TAPE-VCR mode, press the GAMMA/BRIGHTER button once.

- "GAMMA1" appears, and the picture becomes brighter.

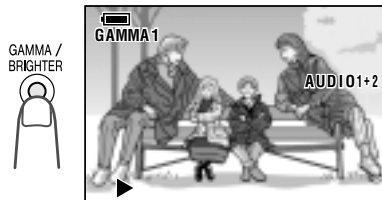

To obtain a brighter picture, press the GAMMA/BRIGHTER button again.

- "GAMMA2" appears.



To cancel Gamma Playback

Press the GAMMA/BRIGHTER button until "GAMMA1" and "GAMMA2" disappear.

Note:

- Gamma Playback has no effect during still playback.

Copying an Image from Tape to Card

Available mode:
TAPE-VCR

You can capture your favourite image frame from a video tape recording and save it on card.

- 1 Insert the recorded Mini DV cassette and a card in the camcorder.
- 2 Set the camcorder to TAPE-VCR mode, then begin tape playback.
- 3 Press Δ on the Operation button at the point where the desired image appears.
 - A still picture of the image is displayed.



Note:

- To cancel the still picture, press Δ again.

- 4 Press the STILL button to copy the image to the card.
 - The  indicator flashes red while the image is copied.

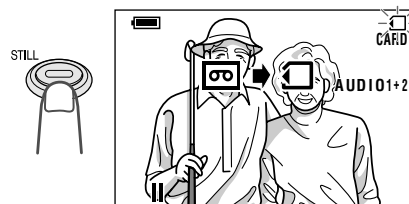



Useful Features Playback

Picture Effect Playback

Available modes:
TAPE-VCR, CARD-VCR

These picture effects let you play back images with a more dramatic effect.

Types

B/W: The picture is displayed in black-and-white.



SEPIA: The picture is displayed in sepia colour similar to that of an old photograph.

SOLARI: The contrast of the subject is enhanced, creating a unique artistic image.

NEGA: The blacks and whites of the image are reversed and colours of the image are inverted.

BLUE: The picture is displayed with the effect of playback through a blue filter.

- The example screens shown are for TAPE-VCR mode.

- During playback in TAPE-VCR (or CARD-VCR) mode, press the MENU button until the menu screen appears.
- Press ∇ or Δ on the operation button to select  (or ) , then press the SET button.
- Press ∇ or Δ to select "PIC. EFFECT", then press the SET button.

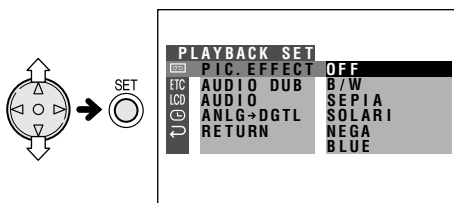

- Press ∇ or Δ to select the desired picture effect, then press the SET button.

PIC. EFFECT B/W

- Press the MENU button to turn off the menu screen.

To cancel Picture Effect Playback

Select "OFF" in step 4 above.

Notes:

- Images in Picture Effect Playback mode cannot be transferred via DV cable to a personal computer.
- You cannot use Picture Effect Playback with Slide Show Playback.



Advanced Features









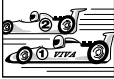

Camera Recording

Manual Focus

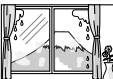
Available modes:

TAPE-CAMERA, CARD-CAMERA

Auto Focus may not be able to focus on the subject in the situations shown below. In such situations, set the camcorder to Manual Focus mode and focus manually.

 Subject is too dark.	 Lack of contrast, e.g. snow scene.
 Fast-moving subject.	 Background is too bright.
 Subject has horizontal stripes.	 Subject is being shot through a dirty or wet window.
 Light reflects off the subject.	 Two subjects at different distances overlap in the same scene.
 Subject has fine, repeated patterns.	 Subjects at different distances appear in the centre of the scene at the same time.
 Fast-speed shutter being used under fluorescent lighting.	

- In TAPE-CAMERA or CARD-CAMERA mode, press the MANUAL button until the focus setting screen appears.



AUTO
MAN. FOCUS AUTO

- Adjust the Power Zoom control to frame the subject as you desire.

- Press Δ or ∇ to focus on the subject.
 Δ : To focus on a more distant subject
 ∇ : To focus on a closer subject

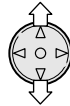

MF
MAN. FOCUS MANUAL

- Press the MANUAL button until the normal screen appears.
 - "MF" appears.

MF 3 0 min

Manual focus indicator

To return to Auto Focus mode

Press the SET button while the focus setting screen is displayed.

Notes:

- The camcorder may not be able to focus correctly if the subject is closer than approximately 1.5 m. Set the zoom control to wide angle, and try refocusing again.
- If the lens is dirty or fogged, the camcorder may not be able to focus correctly.
- When "MF" is displayed, you can manually adjust the focus by pressing ∇ or Δ , even if the focus setting screen is not displayed.



Advanced Features Camera Recording

Manual Exposure

Available modes:

TAPE-CAMERA, CARD-CAMERA

The camcorder is preset to Auto Exposure mode, which automatically selects the optimal aperture. However, when there is too much contrast in brightness between the subject and background, you may not be able to record a clear image. In this case, use the manual exposure function to correct the exposure level.

Background is too bright and subject too dark (backlit subject).

- Increase the exposure level to allow more light through the lens.

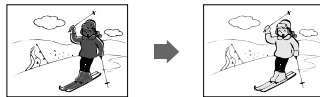

Subject is too bright against background.

- Decrease the exposure level to allow less light through the lens.



To return to Auto Exposure mode

Press the SET button while the exposure setting screen is displayed.

Note:

- **Manual Exposure mode will cancel if a scene setting is selected thereafter.**

- 1 In TAPE-CAMERA or CARD-CAMERA mode, press the MANUAL button until the exposure setting screen appears.



- 2 Press ∇ or Δ to select the desired exposure level.
 - The number shown is the selected exposure level. The adjustment range is from -5 (least light) to $+5$ (most light).

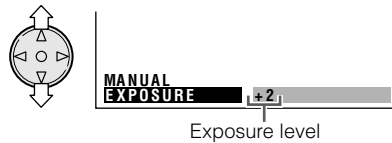

- 3 Press the MANUAL button until the normal screen appears.



White Balance Lock

Available modes:

TAPE-CAMERA, CARD-CAMERA

The colour of the subject on the screen looks different depending on lighting conditions. Lock the White Balance if the Auto White Balance does not work properly.

- 1 In TAPE-CAMERA or CARD-CAMERA mode, press the MANUAL button until the white balance setting screen appears.

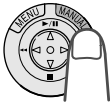

AUTO
WHITE BAL. AUTO

- 2 Aim the lens at a white object.
 - Adjust the distance of the object so that the entire screen is white.

White paper or white cloth

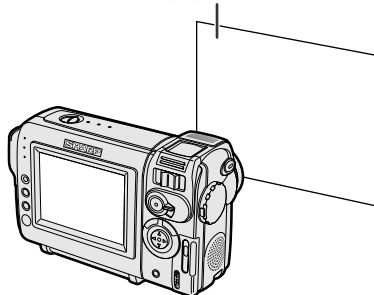

- 3 Press the SET button to set the white balance lock.
 - "LOCK" flashes during the locking procedure.



MANUAL
WHITE BAL. LOCK

Note:

- If you move the camcorder while "LOCK" is flashing, "LOCK" may not stop flashing. If this occurs, press the SET button to cancel the procedure, and then repeat step 3.

- 4 Press the MANUAL button until the normal screen appears.

To return to Auto White Balance mode

Press the SET button while the white balance setting screen is displayed.

Note:

- White Balance setting will cancel if a scene setting is selected thereafter.

Setting the Camcorder to Full Auto mode

To easily record good-quality images, perform camera shooting in Full Auto mode. If "AUTO" is not displayed on the screen, the camcorder is in Manual mode. Perform the procedure below to cancel all manual settings and set the camcorder to Full Auto mode.

In TAPE-CAMERA or CARD-CAMERA mode, press and hold down the MANUAL button for 2 second.

- "FULL AUTO" flashes, then stop flashing when the camcorder is set to Full Auto mode.

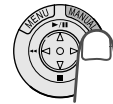



Advanced Features Camera Recording

Digital Picture Effects

Available modes:

TAPE-CAMERA, CARD-CAMERA

These digital picture effects let you record the subject with a more dramatic effect.

Types

B/W: To record in black-and-white.

SEPIA: To record in sepia colour similar to that of an old photograph.

SOLARI: To record with enhanced contrast, creating a unique artistic image.

NEGA: To record a picture whose blacks and whites of the image are reversed and colours of the image are inverted.

BLUE: To record with the effect of recording through a blue filter.

- 1 In TAPE-CAMERA or CARD-CAMERA mode, press the MENU button until the menu screen appears.
- 2 Press ∇ or Δ on the operation button to select , then press the SET button.
- 3 Press ∇ or Δ to select "PIC. EFFECT", then press the SET button.

Advanced Features

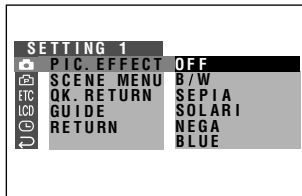
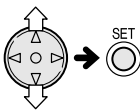

- 4 Press ∇ or Δ to select the desired digital picture effect, then press the SET button.

- The selected digital picture effect displays on the menu screen.

PIC. EFFECT B/W

- 5 Press the MENU button to turn off the menu screen.

To cancel the digital picture effect

Select "OFF" in step 4 above.

Note:

- Digital picture effects cannot be used when a still image is displayed.



Scene Menu (Program AE)

Available modes:

TAPE-CAMERA, CARD-CAMERA

You can set the camcorder to the shooting mode that will create the best results for a specific situation. Just select one of four scene settings shown below. The camcorder will automatically set the exposure, white balance, and shutter speed to produce the optimum picture quality for the selected situation.

Types

SPORT: When you want to record a fast-moving subject.

SUNLIGHT: When the background is very bright.

DUSK: When you want to faithfully record the red of the setting sun, and the surrounding twilight.

PARTY: When the illumination is from a spotlight or candle.

- Press ∇ or Δ to select the scene setting that best fits the recording situation, then press the SET button.
 - The selected scene setting displays on the menu screen.

SCENE MENU SPORT

- Press the MENU button to turn off the menu screen.
 - The selected scene setting indicator displays when the on-screen indicators are turned on.



Scene setting indicator

To cancel the scene setting

Select "OFF" in step 4 above.

Note:

- Scene settings cannot be used when displaying a still image.

- In TAPE-CAMERA or CARD-CAMERA mode, press the MENU button until the menu screen appears.
- Press ∇ or Δ on the operation button to select , then press the SET button.
- Press ∇ or Δ to select "SCENE MENU", then press the SET button.

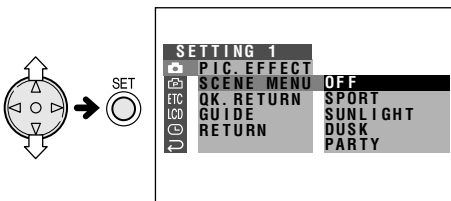

Advanced Features

Playback

Using the Time Code

Available modes:

TAPE-VCR, TAPE-CAMERA

The time code shows the hour, minute and second of recording, and the frame number (1 frame = approx. 1/25 sec.). This is automatically recorded along with the subject when you are recording on the tape. You can display the time code on the screen as an accurate counter in both TAPE-VCR and TAPE-CAMERA modes.

Display format

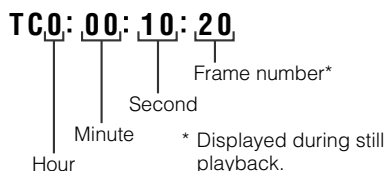

- The example screens shown are for TAPE-VCR mode.

- 1 During playback or camera recording in TAPE modes, press the MENU button until the menu screen appears.
- 2 Press ∇ or Δ on the operation button to select ETC, then press the SET button.
- 3 Press ∇ or Δ to select "TIME CODE", then press the SET button.

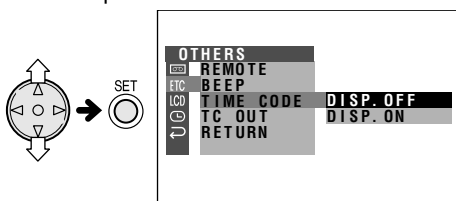

- 4 Press ∇ or Δ to select "DISP. ON", then press the SET button.

TIME CODE DISP. ON

- 5 Press the MENU button to turn off the menu screen.

- The time code appears when the on-screen indicators are turned on.

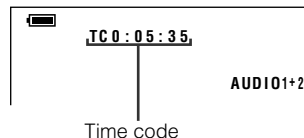

To turn off the time code

Select "DISP. OFF" in step 4 above.

Note:

- When the tape reaches an unrecorded section, the time code returns to zero (TC0:00:00). Once recorded, the time code cannot be changed.

Displaying the time code on a TV during playback

- 1 In TAPE-VCR mode, press the MENU button until the menu screen appears.
- 2 Press ∇ or Δ on the operation button to select ETC, then press the SET button.
- 3 Press ∇ or Δ to select "TC OUT", then press the SET button.

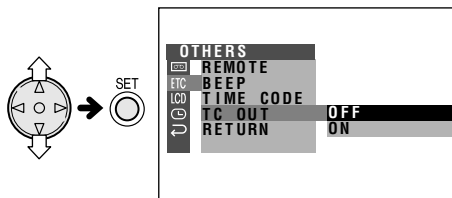

- 4 Press ∇ or Δ to select "ON", then press the SET button.

TC OUT ON

- 5 Press the MENU button to turn off the menu screen.



Editing

Available mode:
TAPE-VCR

Video editing lets you refine your videos by removing unwanted sequences from your tape, or transposing one sequence with another. This camcorder lets you monitor the source program on the built-in LCD monitor without having to connect it to an external TV or video monitor.

Connect the camcorder to a VCR with the supplied audio/video cable, as shown.

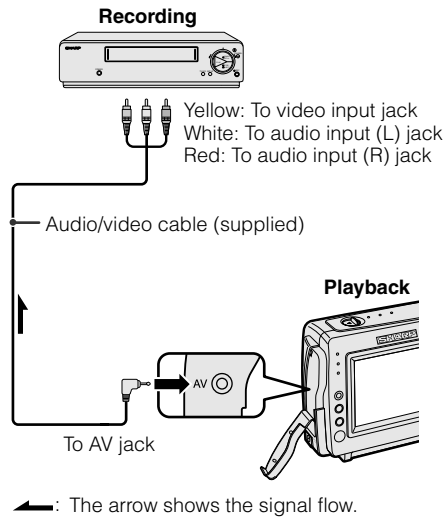

Notes:

- If your VCR has a 21-pin Euro-SCART connector, use the RCA/21-pin Euro-SCART conversion connector (QSOCZ0033TAZZ) available from our main parts distributor detailed on page 78.



- See page 2 for how to open the jack cover.
- If your VCR has only one audio input jack, use the white plug for the audio connection on the VCR.

Cutting Unwanted Sequences

- 1 Play back the tape to be edited on the camcorder, and locate the beginning and end of the sequence you wish to cut. Write down the time code reading at the beginning and end of that sequence (see page 47). Then, rewind the tape to before the beginning of the portion that you wish to keep.
- 2 Load a video cassette into the recording VCR.
- 3 Press Δ on the camcorder to begin playback, then press the Record button on the VCR to begin recording.
- 4 Press the Pause/Still button on the VCR to pause recording when the source tape reaches the beginning of the sequence to be cut.
- 5 Press the Pause/Still (or Record) button on the VCR to resume recording when the source tape reaches the end of the sequence to be cut.

To stop editing

Press ∇ on the camcorder and press the Stop button on the VCR.

Notes:

- Some of the transitions between edited sequences may be slightly off.
- There may be picture noise during video search or still playback. This does not imply a defect in the camcorder.
- The time code display will be recorded along with the edited sequences if the TC OUT menu item is set to "ON". Set to "OFF" before editing (see page 47).



Advanced Features Playback

Recording from an External Source

Available mode:
TAPE-VCR

You can use this camcorder to record or edit videos from another source, such as a VCR, TV, or video disc player.

Connect the camcorder to the source equipment with the supplied audio/video cable, as shown.

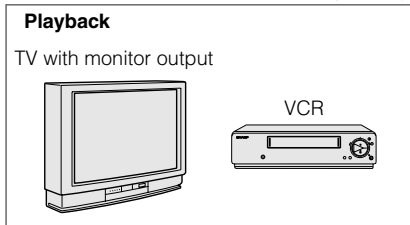
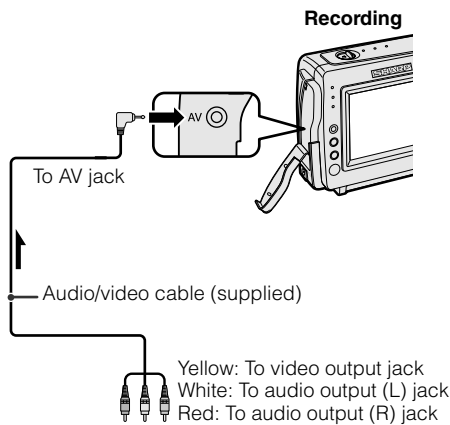

←: The arrow shows the signal flow.

Notes:

- See page 2 for how to open the jack cover.
- If the source equipment has only one audio output jack, use the white plug for the audio connection on the source equipment. (The input audio will only be recorded on the left channel of the tape.)
- If your TV or VCR has a 21-pin Euro-SCART connector, use the RCA/21-pin Euro-SCART conversion connector (QSOCZ0033TAZZ) available from our main parts distributor detailed on page 78.

21-pin Euro-SCART on TV or VCR

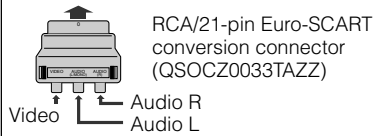

To Record from an External Source

- 1 Set the camcorder to TAPE-VCR mode, and insert a Mini DV cassette.
- 2 Begin playback on the video equipment connected to the camcorder.
 - Check the camcorder screen to see if the picture is properly received.
- 3 Press the REC START/STOP button on the camcorder.
 - The camcorder enters Recording Standby mode.
- 4 Press Δ on the Operation button to begin recording.

Notes:

- To pause recording, press Δ . Press Δ again to resume recording.
- To operate by remote control, perform steps 1 and 2 above, and press the REC START/STOP button, then press the PAUSE/STILL button (II).
- If "NO SIGNAL" is displayed on the camcorder screen, check that the audio/video cable is properly connected.

To stop recording

Press ∇ on the Operation button.

Cutting Unwanted Sequences

- 1 Press Δ to pause recording when the source tape reaches the beginning of the sequence to be cut.
- 2 Press Δ to resume recording when the source tape reaches the end of the sequence to be cut.



Using the Camcorder as a Converter

Available mode:
TAPE-VCR

You can use this camcorder to convert from analog signal (e.g. video recorded on 8 mm or Hi8 tapes) to digital signal.

Connect the audio/video cable and DV cable as shown below.

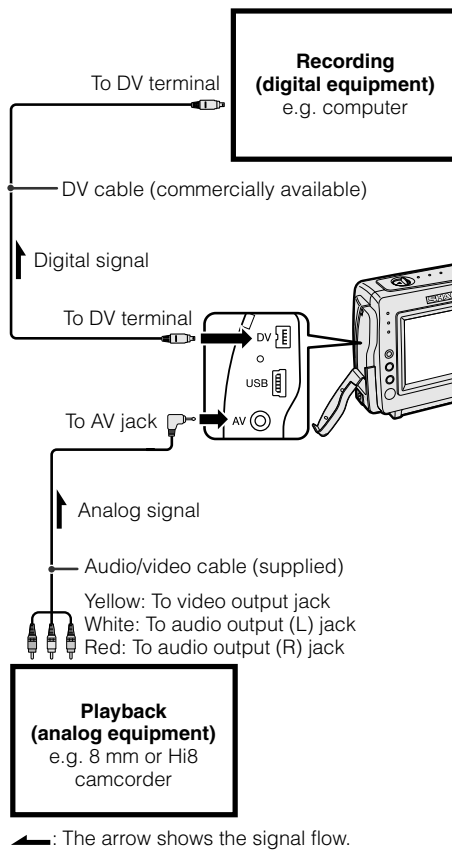

Note:

- See page 2 for how to open the jack cover.

- 1 Set the camcorder to TAPE-VCR mode, and make sure that playback stops.
- 2 Press the MENU button to display the menu screen.
- 3 Press ∇ or Δ on the operation button to select , then press the SET button.
- 4 Press ∇ or Δ to select "ANLG→DGTL", then press the SET button.

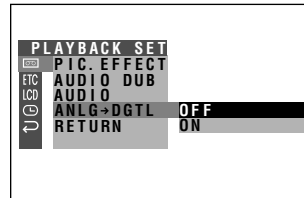
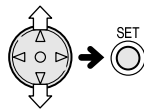

- 5 Press ∇ or Δ to select "ON", then press the SET button.
- 
- 6 Press the MENU button to turn off the menu screen.
 - 7 Press the Play button on the analog equipment
 - Check the monitor on the digital equipment to see if the picture is being properly received.
 - 8 Press the Record button on the digital equipment.

Notes:

- The camcorder is not guaranteed to work with all digital/analog equipment. Contact the manufacturer of your equipment for advice.
- If the camcorder outputs a video recording with a copyright signal, the digital equipment cannot record or save it.
- The camcorder may not convert some input video recordings properly (e.g. discolouration, picture noise, muted sound), depending on the input condition.





Advanced Features Playback

Editing with the DV Terminal (IEEE1394)

Available mode:
TAPE-VCR

This camcorder enables you to perform digital video editing. Connect the camcorder to video equipment with a DV terminal using a commercially available DV cable. A DV cable is able to transfer all dubbing signals including video and audio.

To Record to Video Equipment

See "Cutting Unwanted Sequences" on page 48, using the video equipment as the recording source.

Note:

- Make sure that the video equipment to which you are recording can input dubbing signals via the DV terminal.

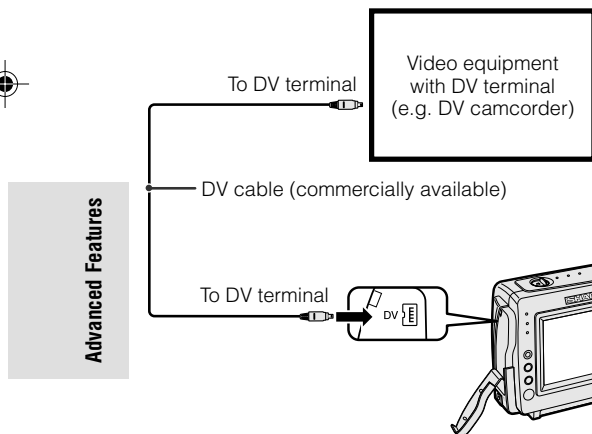

To Record from Video Equipment

- 1 Set the camcorder to TAPE-VCR mode, and insert a Mini DV cassette.
- 2 Begin playback on the video equipment connected to the camcorder.
 - Check the camcorder screen to see if the picture is properly received.
- 3 Press the REC START/STOP button on the camcorder.
 - The camcorder enters Recording Standby mode.
- 4 Press Δ on the Operation button to begin recording.

To stop recording

Press ∇ on the Operation button.

Cutting Unwanted Sequences

- 1 Press Δ to pause recording when the source tape reaches the beginning of the sequence to be cut.
- 2 Press Δ to resume recording when the source tape reaches the end of the sequence to be cut.

Notes:

- Make sure that the video equipment from which you are recording can output dubbing signals via the DV terminal.
- If the video equipment is not set to playback mode or the DV cable is not properly connected, "NO SIGNAL" is displayed on the camcorder screen.
- If no picture or sound is input to the camcorder even if the DV cable is properly connected and you are playing back the source media from the video equipment, set the Power switch on the camcorder to OFF and then back to VCR, or disconnect the DV cable and connect it again.
- If a digital video recording with a copyright protection signal is used as the playback source, "COPYRIGHT PROTECTED." appears on the camcorder monitor and the recording function is disabled (see page 72).
- When displaying the playback picture on the recording equipment, you may find black bands around the image. This is caused by the differences of the image display sizes.
- You cannot output the picture playing back from the DV terminal to an external monitor.



Selecting the Audio Playback Mode

Available mode:
TAPE-VCR

You can select any of the following audio playback modes.

Audio 1+2

- 12-bit recording in stereo (Audio 1 and Audio 2 channels)
- 16-bit recording in stereo (left and right channels)

Audio 1

- 12-bit recording in stereo (Audio 1 channel only)
- 16-bit recording in mono (left channel only)

Audio 2

- 12-bit recording in stereo (Audio 2 channel only)
- 16-bit recording in mono (right channel only)

- 1 Play back a Mini DV cassette with dubbed audio.
- 2 Press the MENU button until the menu screen appears.

- 3 Press ∇ or Δ on the operation button to select , then press the SET button.

- 4 Press ∇ or Δ to select "AUDIO", then press the SET button.

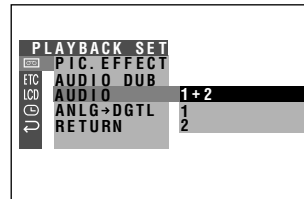
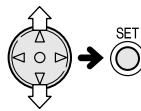

- 5 Press ∇ or Δ to select the desired audio playback mode, then press the SET button.

AUDIO 1+2

- 6 Press the MENU button to turn off the menu screen.

- The selected audio playback mode indicator only appears when the on-screen indicators are turned on.

Audio playback mode indicator



Note:

- The audio playback mode indicator, "AUDIO", displays in different colours depending on the recording mode (12- or 16-bit) used for the recording being played back. A white display indicates 12-bit recording mode, while a green indicates 16-bit.

Advanced Features





Advanced Features Playback

Audio Dubbing Feature

Available mode:
TAPE-VCR

You can add narration to recordings made with this camcorder, while preserving the original audio and video recordings.

Microphone for Audio Dubbing

You can use the built-in stereo microphone to record narration.

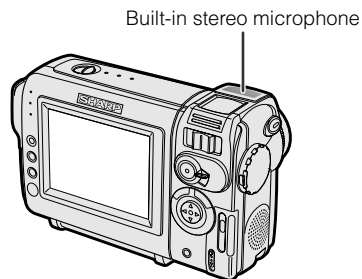

Notes:

- Audio dubbing does not function through the DV terminal.
- You cannot use audio dubbing with recordings made in LP mode.
- You cannot use the built-in stereo microphone for audio dubbing when the audio/video cable is connected.

Audio Recording

In normal recording mode

12-bit audio recording

The audio is recorded in stereo on Audio 1.

Audio 1: Stereo (left and right) sound

Audio 2: No audio

16-bit audio recording

The audio is recorded in stereo with the left and right sound on two separate channels.

Audio 1: Left sound

Audio 2: Right sound

In Audio Dubbing mode

12-bit audio recording

The dubbed audio is recorded on Audio 2.

Audio 1: Original stereo (left and right) sound

Audio 2: Dubbed stereo (left and right) sound

16-bit audio recording

The dubbed audio is recorded on Audio 2 over the original right sound. Both dubbed and original sounds are mono.

Audio 1: Original left sound

Audio 2: Dubbed sound

Note:

- You can select the 12-bit or 16-bit audio recording mode by performing the procedure on page 37.



Audio Dubbing

- 1 Play back the recorded Mini DV cassette and locate the tape position where you wish to start audio dubbing.
- 2 Press Δ to pause playback.
- 3 Press the MENU button until the menu screen appears.
- 4 Press ∇ or Δ on the operation button to select \square , then press the SET button.
- 5 Press ∇ or Δ to select "AUDIO DUB", then press the SET button.
 - The audio dubbing screen appears.

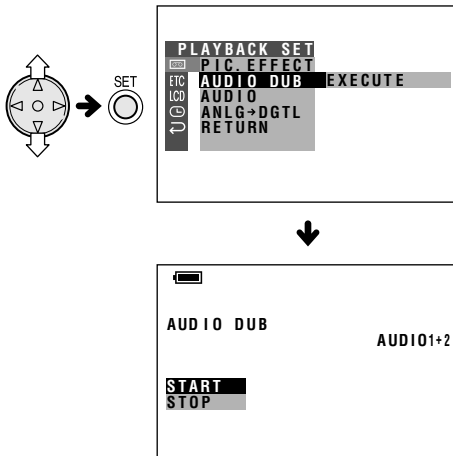

- 6 Press the SET button to begin audio dubbing. Record your narration.

To pause audio dubbing

Press the SET button. To resume audio dubbing, press the SET button again.

To cancel audio dubbing

Press the MENU button. The audio dubbing screen disappears.

If you wish to change the dubbed audio or dub additional scenes

- 1 Press the MENU button to turn off the audio dubbing screen.
- 2 Repeat steps 1 to 6 above.

Notes:

- It is recommended that you use Audio Dubbing only with recordings made with this camcorder. Use of recordings made with other digital video equipment may result in poor audio quality.
- Audio dubbing will automatically pause if the original audio changes from 12-bit mode to 16-bit mode or vice versa. Press the SET button to resume operation.
- Audio dubbing will automatically stop if a portion recorded in LP mode or an unrecorded portion of the tape is encountered.
- You can play back the dubbed audio and the original audio together or separately (see page 52).



Digital Still Camera Features

Camera Recording

Card Recording

Available mode:
CARD-CAMERA

You can take a still picture in the same way as you do with a standard camera and record that image on the card.

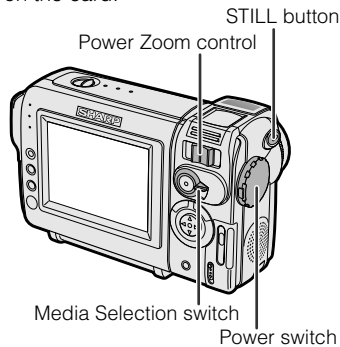

- 1 Insert a card into the camcorder (see page 13).
- 2 Remove the lens cap.
- 3 Set the Media Selection switch to CARD. 
- 4 Hold down the Lock button and set the Power switch to CAMERA.
 - The picture from the lens now displays.

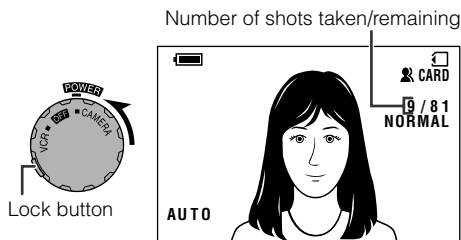

- 5 Adjust the Power Zoom control to frame the subject as you desire.
- 6 Press the STILL button half-way down to focus on the subject.
 - The camcorder automatically focuses on the subject. When it is set, you will hear a sound and see  mark, then the camcorder locks the focus.



- 7 Press the STILL button fully to begin recording.
 - The  indicator flashes red while data is being recorded on the card, and returns to white when recording completes.
 - To record another image, release the STILL button and make sure the picture is not frozen in the monitor, then perform steps 6 and 7.

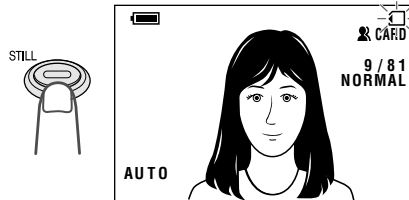

Notes:

- Recording under insufficient lighting may result in blurred images. It is recommended that you use a tripod to record insufficiently illuminated subjects.
- Recording under the light of a fluorescent, mercury, or sodium lamp may cause flickering in the image and, depending on the timing of the shot, may result in changes to colour hue in the image.
- Set the BEEP menu item to "OFF" to turn off the focus locking sound.

Caution:

- Do not turn the power off while the  indicator is flashing in step 7.

Digital Still Camera Features



Selecting the Picture Quality

Available mode:
CARD-CAMERA

The picture quality of still images recorded on the card depends on the picture quality setting. Select the appropriate setting to match your recording objectives.

Types

NORMAL: Records images with standard picture quality.

ECONOMY: Allows you to take more shots than in NORMAL mode but with a lower quality.

FINE: Records images with higher quality than in NORMAL mode but with a lower number of recordable images.

- 1 In CARD-CAMERA mode, press the MENU button until the menu screen appears.
- 2 Press ∇ or Δ on the operation button to select , then press the SET button.
- 3 Press ∇ or Δ to select "REC MODE", then press the SET button.

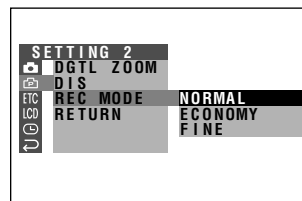
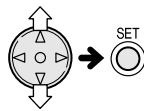

- 4 Press ∇ or Δ to select the desired setting, then press the SET button.

REC MODE **ECONOMY**

- 5 Press the MENU button to turn off the menu screen.
 - The selected picture quality indicator only appears when the on-screen indicators are turned on.



Picture quality indicator

Approximate number of recordable images with the supplied card

Picture quality setting	Approx. number of images
NORMAL	90
ECONOMY	160
FINE	50

Note:

- The number of recordable images differs depending on the combination of picture quality settings used and the images shot.

Note:

- The picture quality indicator is also displayed in CARD-VCR mode. The picture quality indicator displayed during playback is based on the amount of data for that recorded image. Since the amount of data differs depending on factors such as image detail, sometimes the picture quality indicator displayed during playback may not match the picture quality setting used during recording.



Digital Still Camera Features

Card Recording

Recording with the Self-timer

Available mode:
CARD-CAMERA

The self-timer function allows you to record images after a time-lag of 10 seconds. This is convenient when you want to record an image of you and your friends together.

- 1 In CARD-CAMERA mode, press the MENU button until the menu screen appears.
- 2 Press ∇ or Δ on the operation button to select , then press the SET button.
- 3 Press ∇ or Δ to select "SELF TIMER", then press the SET button.

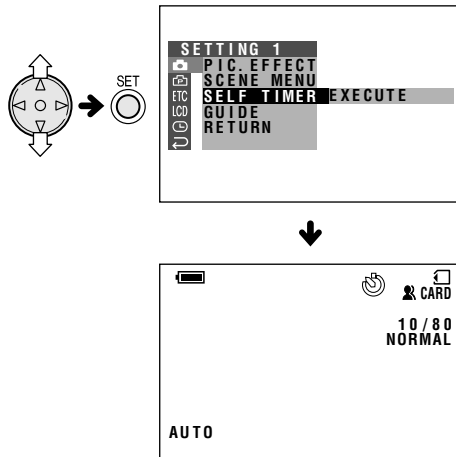

- 4 Press the STILL button fully to set the timer.
 - The self-timer operating indicator flashes while the timer counts down.

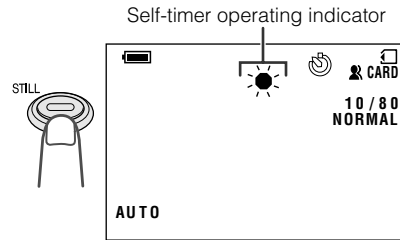

- The shutter automatically releases after 10 seconds, and a still image of the subject is recorded.

Notes:

- When recording with the self-timer, stabilize the camcorder in the horizontal plane by attaching it to a tripod, etc.
- To cancel the self-timer, press the STILL button fully again in step 4 above.
- Self-timer mode cancels after recording one image. Repeat steps 1 to 4 to record another image with the self-timer.

Caution:

- Do not turn the power off or remove the card once the self-timer operating indicator begins flashing.



Formatting a Card

Available mode:
CARD-CAMERA

Before using a commercially available card with this camcorder, you must first have it formatted. Also, if any of the following warning indicators displays, you will need to format your card.

- "FORMAT MEMORY CARD"
- "MEMORY CARD ERROR"
- "MEMORY CARD READ ERROR"
- "CANNOT STORE DATA"

Cautions:

- Formatting a card erases all stored images, including delete-protected images. Be sure to backup important data on your computer or other media before formatting the card (see pages 65, 66).
- Do not remove the power source during formatting, as this may cause damage to the camcorder or card. It is recommended that you use the AC outlet for the power supply.

- 1 Insert a card to be formatted into the camcorder.
- 2 In CARD-CAMERA mode, press the MENU button until the menu screen appears.
- 3 Press ∇ or Δ on the operation button to select [ETC], then press the SET button.

- 4 Press ∇ or Δ to select "FORMAT", then press the SET button.

- To cancel formatting, press ∇ or Δ to select "NO", then press the SET button.

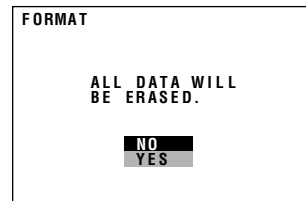
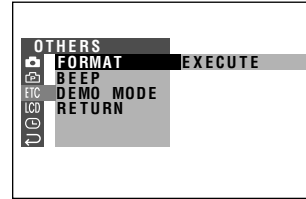
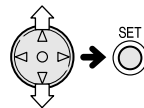

- 5 Press ∇ or Δ to select "YES", then press the SET button to begin formatting.

- The menu screen displays when formatting finishes.

- 6 Press the MENU button to turn off the menu screen.

Notes:

- The supplied card is preformatted for immediate use.
- **Use this camcorder to format a card. The camcorder may not recognize the images on a card formatted by a computer or other equipment.**



Digital Still Camera Features

Playback

Card Playback

Available mode:
CARD-VCR

You can play back and view still images recorded on a card on the LCD monitor.

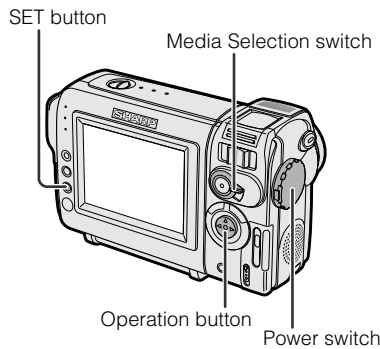

- 1 Set the Media Selection switch to CARD.
- 2 Hold down the Lock button and set the Power switch to VCR.

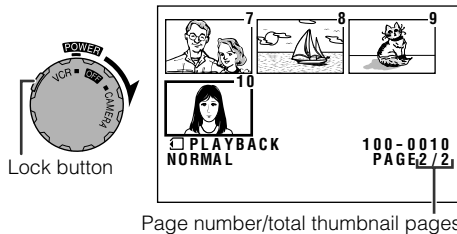

- 3 Press \leftarrow , \rightarrow , ∇ or \triangle on the Operation button to move the selection frame to the desired image.
 - Each time you press \leftarrow , \rightarrow , ∇ or \triangle , the selection frame moves as shown below.

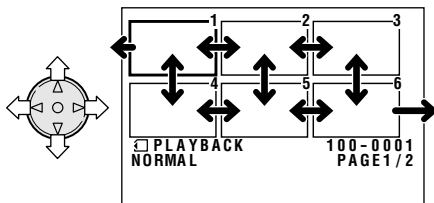

- Note:**
- Holding down \leftarrow or \rightarrow increases the speed of motion of the selection frame.

- 4 Press the SET button.
 - The selected image displays in full-screen.

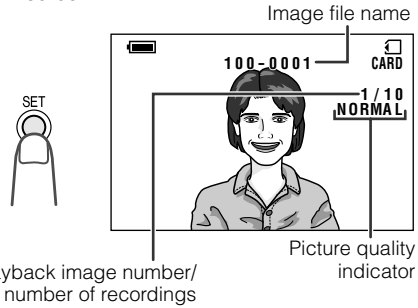

Available Operations during Full-screen Display

- You can display the full-screen picture of the previous or next image by pressing \leftarrow or \rightarrow .
- When holding down \leftarrow or \rightarrow , you can search through the images on the card. The search can be very fast, so it is recommended that the on-screen indicators turn on to display the image number.
- To return to a thumbnail of the images, press the SET button again.

Notes:

- Depending on the amount of data for the recorded image, the picture quality indicator displayed during playback may not match the picture quality setting used during recording.
- The images bigger than 640 × 480, e.g. images recorded on other equipment, display as thumbnails, not full screen.
- Do not play back any card storing a defective image (with noise and distortion) created on other equipment. If you mistakenly play back data on such a card, set the Power switch to OFF, remove, and never use it with this camcorder.



Delete Protection

Available mode:
CARD-VCR

You can prevent your important images recorded on the card from accidental erasure.

- 1 In CARD-VCR mode, press the MENU button until the menu screen appears.
- 2 Press ∇ or Δ on the operation button to select \square , then press the SET button.
- 3 Press ∇ or Δ to select "PROTECT", then press the SET button.
 - The PROTECT indicator appears.

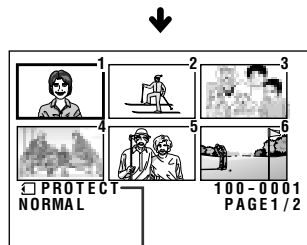
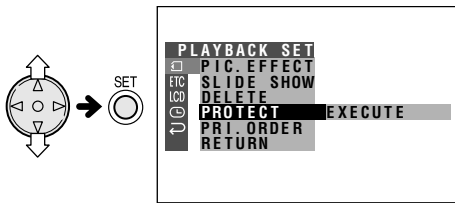

PROTECT indicator

- 4 Press \triangleleft , \triangleright , ∇ or Δ to select the image for delete protection.

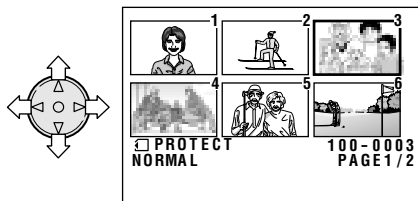

- 5 Press the SET button to set delete protection.
 - The \square indicator appears.

Delete protection indicator

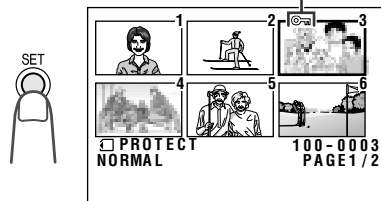

- If you want to protect another image, repeat steps 4 and 5.

- 6 Press the MENU button to finish the setting.

To cancel the protection setting

- 1 Select the image for delete protection cancellation in step 4 above.
- 2 Press the SET button to cancel the protection.
 - The \square indicator disappears.

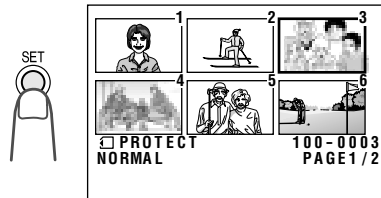

- 3 Press the MENU button to finish the setting.

Note:

- Formatting a card erases all stored images, including delete-protected images.



Digital Still Camera Features Playback

Deleting Stored Images

Available mode:
CARD-VCR

Deleting One Stored Image

You can delete unwanted images to free up memory of a card for new images.

Note:

- Deleted images cannot be restored. Check whether or not you want the images before performing the procedure below.

- In CARD-VCR mode, press the MENU button until the menu screen appears.
- Press ∇ or Δ on the operation button to select \square , then press the SET button.
- Press ∇ or Δ to select "DELETE", then press the SET button.

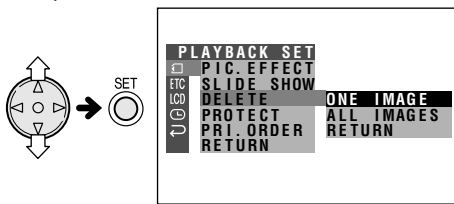

- Press ∇ or Δ to select "ONE IMAGE", then press the SET button.
 - The DELETE indicator appears.

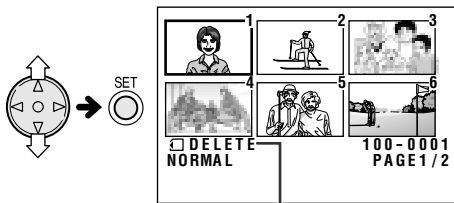

- Press \leftarrow , \rightarrow , ∇ or Δ to select the image to be deleted.

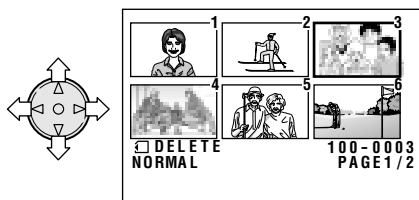

- Press the SET button to set the image.
 - To cancel deletion, press ∇ or Δ to select "NO", then press the SET button.

- Press ∇ or Δ to select "YES", then press the SET button to delete the image.

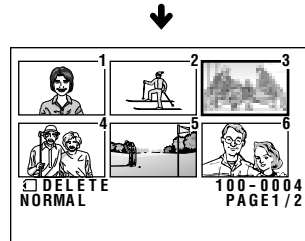
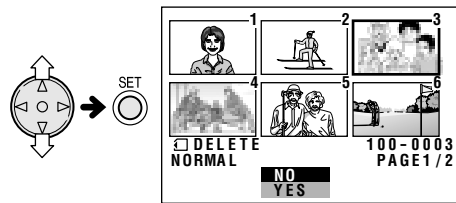

- If you want to delete another image, repeat steps 5 to 7.

- Press the MENU button to finish the setting.

Note:

- The protected images cannot be deleted. Cancel the protection setting to delete the image (see page 60).

Caution:

- Do not turn the power off while deleting an image.



Deleting All Stored Images

You can delete all stored images on a card in one operation.

Notes:

- Deleted images cannot be restored. Check whether or not you want the images before performing the procedure below.
- If you want to keep some images on the card, first delete-protect them (see page 60), and then perform the procedure below.

- In CARD-VCR mode, press the MENU button until the menu screen appears.
- Press ∇ or Δ on the operation button to select \square , then press the SET button.
- Press ∇ or Δ to select "DELETE", then press the SET button.

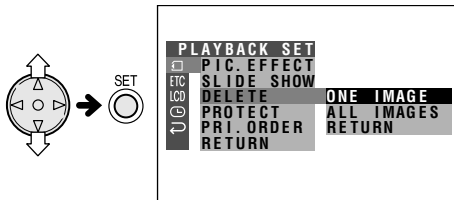

- Press ∇ or Δ to select "ALL IMAGES", then press the SET button.
 - The DELETE ALL indicator appears.

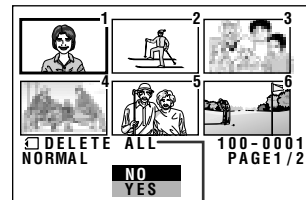
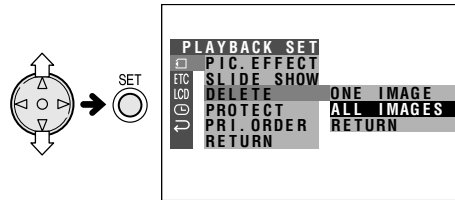

DELETE ALL indicator

- Press ∇ or Δ to select "YES", then press the SET button to delete all the images.
 - To cancel deletion, press ∇ or Δ to select "NO", then press the SET button.
- Press the MENU button to finish the setting.

Notes:

- The protected images cannot be deleted. Cancel the protection setting to delete the image (see page 60).
- If a print order is assigned to delete-protected images and you perform the procedure above, the print order will cancel (the protection setting will not cancel).
- It may take several seconds to delete all images from the card.

Caution:

- Do not turn the power off while deleting images.



Digital Still Camera Features Playback

Print Order

Available mode:
CARD-VCR

The print order function allows you to add print information called DPOF to still images recorded on a card.

About DPOF

DPOF (Digital Printing Order Format) defines the print information for the specific images and number of each image on memory cards. In the near future you will be able to easily make prints on a DPOF-compatible printer or order copies at your local print shop.

Note:

- You can print an image even if no print order has been assigned.

Assigning Print Order to an Image

- In CARD-VCR mode, press the MENU button until the menu screen appears.
- Press ∇ or Δ on the operation button to select \square , then press the SET button.
- Press ∇ or Δ to select "PRI. ORDER", then press the SET button.

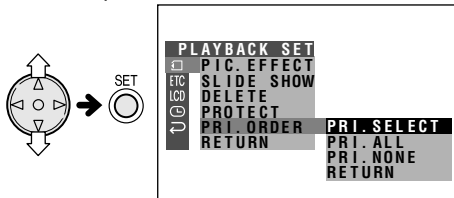

- Press ∇ or Δ to select "PRI. SELECT", then press the SET button.
 - The PRINT indicator appears.

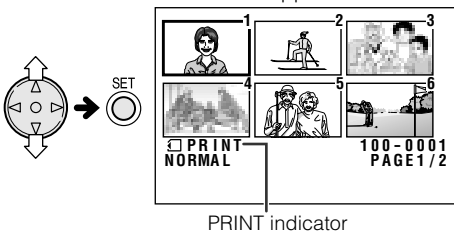

- Press \triangleleft , \triangleright , ∇ or Δ to select the image to which you want to assign a print order.

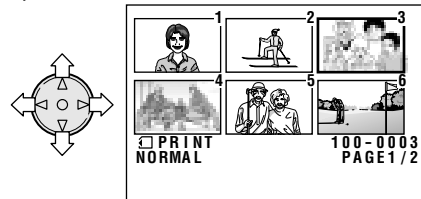

- Press the SET button, then press ∇ or Δ to select the number of printouts.
 - 1 through 99 can be set for the number of printouts.

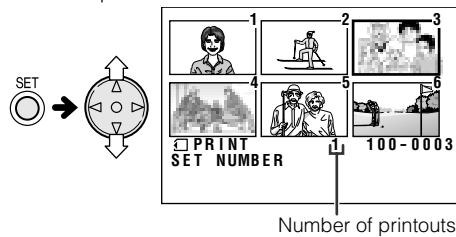

- Press the SET button to set the print order.
 - The ■ indicator appears.

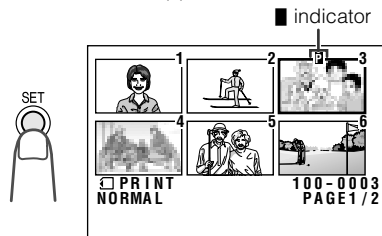

- If you want to assign another print order, repeat steps 5 to 7.

- Press the MENU button to finish the setting.



To cancel the print order for an image

- 1 Select the image for cancelling out of print order in step 5 above, then press the SET button.
- 2 Press ∇ to select "0", then press the SET button.
 - The ■ indicator disappears.

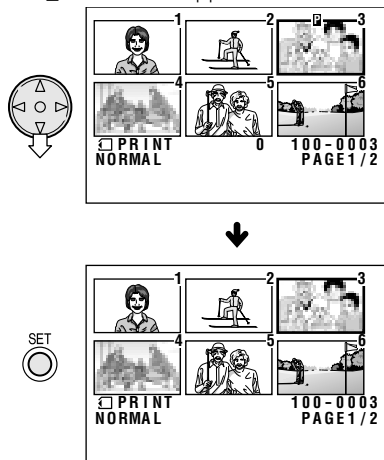

Assigning Print Order to All Images

- 1 Perform steps 1 to 3 in "Assigning Print Order to an Image".
- 2 Press ∇ or Δ to select "PRI. ALL", then press the SET button.

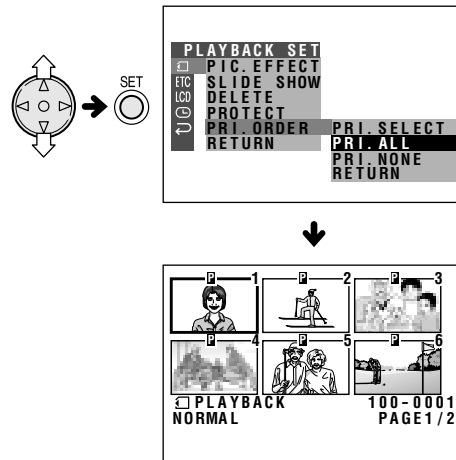

- 3 Press the MENU button to finish the setting.

To cancel the print order for all images

- 1 Perform steps 1 to 3 in "Assigning Print Order to an Image".
- 2 Press ∇ or Δ to select "PRI. NONE", then press the SET button to cancel the print order for all images.
 - The ■ indicators are turned off.

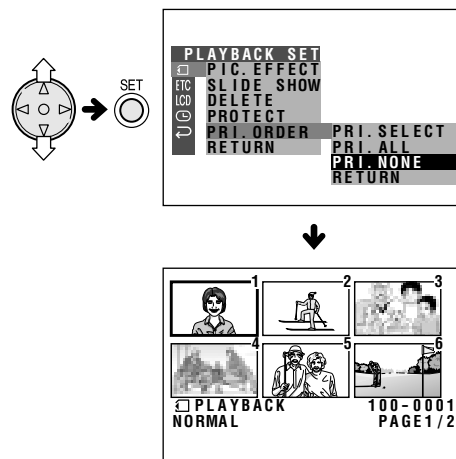

Digital Still Camera
Features



Digital Still Camera Features Playback

Transferring Data on Card to Computer

Using the supplied USB cable, you can transfer still images to a computer.

System Requirements

- Microsoft Windows® 98, Windows® 98 Second Edition, Windows® 2000 Professional, Windows® Me or Windows® XP operating system
- USB terminal
- CD-ROM drive (for driver installation)
- Mouse or other pointing device

Preparation

- 1 Turn on the PC.
- 2 Connect the camcorder to the PC with the supplied USB cable as shown below.

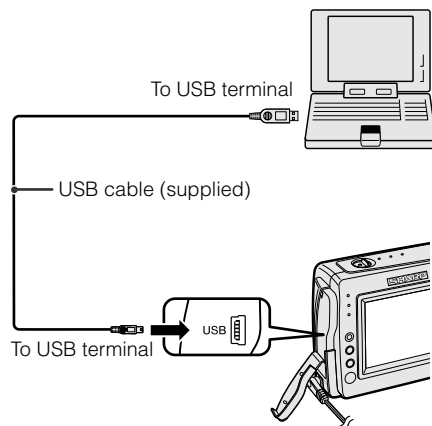

- 3 Set the Media Selection switch to CARD.
- 4 Hold down the Lock button and set the Power switch to VCR.

Note:

- When you connect the USB cable for the first time, you need to install the USB driver. The installation procedure varies depending on your PC operating system. Find your operating system and follow the steps in "Installing the USB driver".

Installing the USB driver

- In the examples below the CD-ROM drive letter is taken as "R:". Select the correct drive letter according to your operating environment.

Windows 98/98 SE

- 1 "Add New Hardware Wizard" appears after performing "Preparation".
- 2 Insert the CD-ROM containing the USB driver into the CD-ROM drive, then click "Next".
- 3 Select "Search for the best driver for your device.", then click "Next".
- 4 Select "Specify a location:", and specify "R:\WIN98", then click "Next".
- 5 Check the message, then click "Next" to begin installation.
- 6 Click "Finish" to complete the installation.

Windows 2000

For installing the USB driver, you need to log in as the system administrator.

- 1 "Found New Hardware Wizard" appears after performing "Preparation", then click "Next".
- 2 Select "Search for a suitable driver for my device", then click "Next".
- 3 Select "Specify a location", insert the CD-ROM containing the USB driver into the CD-ROM drive, then click "Next".
- 4 Specify "R:\WIN2KXP", then click "OK".
- 5 Check the message, then click "Next" to begin installation.
- 6 Click "Finish" to complete the installation.



Windows ME

- 1 "Add New Hardware Wizard" appears after performing "Preparation".
- 2 Select "Automatic search for a better driver".
- 3 Insert the CD-ROM containing the USB driver into the CD-ROM drive, then click "Next".
- 4 Select "SHARP DVC USB Ver. 1.0" located in the "WINME" folder of the CD-ROM drive, then click "OK" to begin installation.
- 5 Click "Finish" to complete the installation.

Windows XP

For installing the USB driver, you need to log in as the system administrator.

- 1 "Found New Hardware Wizard" appears after performing "Preparation".
- 2 Select "Install from a list or specific location".
- 3 Insert the CD-ROM containing the USB driver into the CD-ROM drive, then click "Next".
- 4 Select "Search for the best driver in these locations." and "Include this location in the search:".
- 5 Specify "R:\WIN2KXP", then click "Next".
- 6 A warning window for hardware installation appears. However, click "Continue Anyway" to continue installation.
- 7 Click "Finish" to complete the installation.

Image Folders and File Names

Still images recorded using the camcorder are stored on a card as shown below.

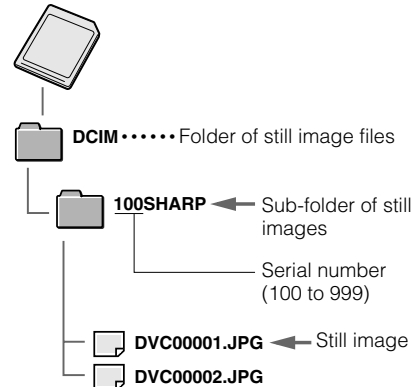

Caution on transferring data

While transferring data, the transfer indicator moves. Do not execute the operations below.

- Disconnecting the USB cable
- Switching the power on/off
- Turning off the PC or setting it to Standby
- Opening the card slot cover

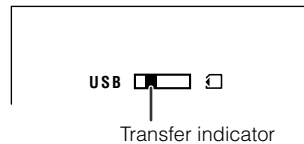

Note:

- In case of data transfer error, disconnect the USB cable, then connect it again, or set the Power switch to OFF, then set it to VCR again.

Disconnecting the USB cable

Refer to the operation manual and help files of your PC for unplugging, and make sure that the PC permits to unplug, then disconnect the USB cable.

Notes:

- If you copy any data incompatible with this camcorder to the card, the camcorder will not be able to recognize it.
- It is recommended to use the AC adapter as a power source for extended periods of use.



Digital Still Camera Features Playback

Slide Show Playback

Available mode:
CARD-VCR

You can automatically play back consecutive still images recorded on a card at intervals of 5 seconds. This is useful when confirming the data recorded on a card.

- 1 Set the camcorder to CARD-VCR mode.
- 2 Press \triangleleft , \triangleright , ∇ or \triangle to select the image from which you want to begin slide show playback.

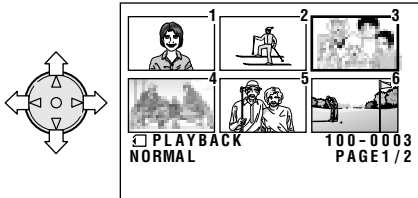

- 3 Press the MENU button until the menu screen appears.
- 4 Press ∇ or \triangle to select \square , then press the SET button.

- 5 Press ∇ or \triangle to select "SLIDE SHOW", then press the SET button.
 - Beginning from the image selected in step 2, the recorded images will display in full-screen one after another in order of recording.

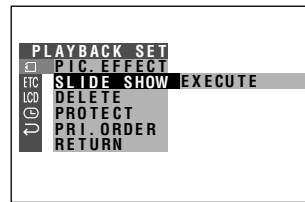
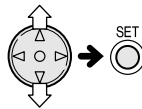

- After playing back all the images on the card once, Slide Show Playback automatically stops.
- 6 Press the MENU button to turn off the menu screen, then press the SET button to display a thumbnail of images.

To stop Slide Show Playback

During slide show playback, press the MENU button twice, then press the SET button to display a thumbnail of images.

Appendix

Picture/Backlight Adjustments

Available modes:

All modes

If the picture is difficult to see due to ambient light or other factors, adjust the monitor picture settings.

- The example screens shown are for TAPE-CAMERA mode.

Adjusting the Picture

- Press the MENU button until the menu screen appears.
- Press ∇ or Δ on the operation button to select LCD, then press the SET button.

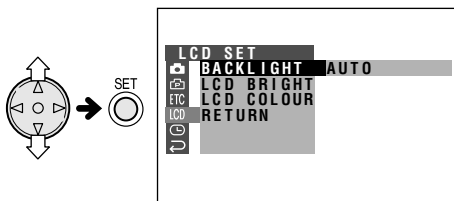

- Press ∇ or Δ to select "LCD BRIGHT" or "LCD COLOUR", then press the SET button.
- Press ∇ or Δ to adjust the item to the desired setting.

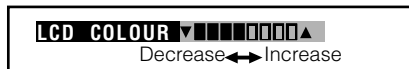
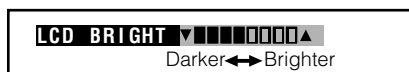

- Press the SET button, then press the MENU button to turn off the menu screen.

Note:

- When adjusting the colour, the picture on the LCD monitor may differ from the picture actually recorded. Do not change the colour setting unless necessary. (This adjustment only affects the monitor picture, not the recorded image.)

Adjusting the Backlight

- Press the MENU button until the menu screen appears.
- Press ∇ or Δ on the operation button to select LCD, then press the SET button.
- Press ∇ or Δ to select "BACKLIGHT", then press the SET button.

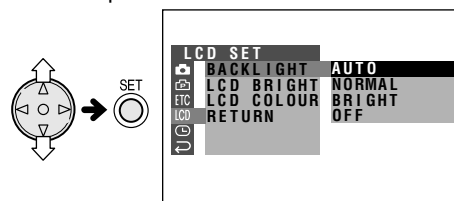

- Press ∇ or Δ to select "AUTO", "NORMAL", "BRIGHT" or "OFF", then press the SET button.

BACK LIGHT BRIGHT

AUTO: The camcorder automatically switches between "NORMAL" and "BRIGHT" depending on the ambient light. This mode is only available in TAPE-CAMERA or CARD-CAMERA mode.

NORMAL: For use indoors or under moderate lighting conditions.

BRIGHT: For use outdoors under strong lighting conditions, such as bright daylight.

OFF: The backlight turns off. To turn it on again, press the MENU button.

- Press the MENU button to turn off the menu screen.



Appendix

Turning off the Confirmation Sound

Available modes:

All modes

A confirmation sound is made when you turn on or off the Power switch, press the REC START/STOP button, or perform other designated operations. Use the procedure below to turn off the confirmation sounds.

- 1 Press the MENU button until the menu screen appears.
- 2 Press ∇ or Δ on the operation button to select ETC, then press the SET button.
- 3 Press ∇ or Δ to select "BEEP", then press the SET button.

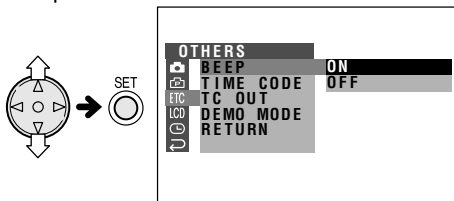

- 4 Press ∇ or Δ to select "OFF", then press the SET button.
- | | |
|------|-----|
| BEEP | OFF |
|------|-----|
- 5 Press the MENU button to turn off the menu screen.

Note:

- If you select "OFF", the focus confirmation sound in CARD-CAMERA mode will turn off.



Useful Information

Hints for Better Shooting

- Position the subject in the centre of the scene. When using auto focus, whatever is in the centre of the scene is kept in focus.



Position the subject in the centre.



Focus manually when you need to position the subject off centre (see page 42).

- Avoid backlit subjects. For the best picture, shoot with the light source behind you.

When the background is brighter than the subject, the subject often becomes too dark. If you have to record in this lighting, use Gamma Brightness Compensation or correct the exposure level to improve the picture (see pages 29 and 43).

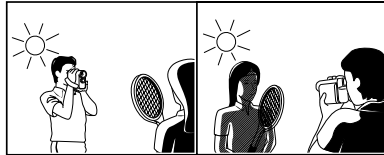

Light from behind

Backlighting

- Before zooming, think about how to best frame the shot. Frequent zooming produces unattractive pictures. It also runs down the battery more quickly.
- When image shaking is noticeable during zoomed-in telephoto shooting, use a tripod or push the Power Zoom control to the W side to zoom out.
- Horizontal panning (lateral movement) and tilting (vertical movement) should be done slowly to emphasize the wide expanse of a scene or the height of a building, and to make scenes easy to watch during playback.
- Use a wide-angle setting for fast-moving subjects.

Note:

- It may take longer to focus when zooming and panning are used frequently.

Lighting

For clear, good-quality recording, 500 to 100,000 lux is needed. Recording is possible with less light, but the picture quality may suffer. Adequate lighting is also essential for correct white balance.

Brightness (Lux)	Situation (Lux)
100,000	Blue sky Clear day at noon (100,000)
10,000	Clear day at 10 am (65,000) Clear day at 3 pm (35,000) Cloudy day at noon (32,000) Cloudy day at 10 am (25,000)
1,000	Cloudy day, one hour after sunrise (2,000) Clear day, one hour before sunset (1,000) Fluorescent light near window (1,000)
100	Factory floor (700–800) Sales counter in department store (500–700) Bowling alley (500) Library (400–500) Office with fluorescent lighting (400–500) Fluorescent desk lamp (400) Flashlight at 1 m (250) Shop stairway (100)
10	During intermission at movie theatre (15–35) Cigarette lighter at 30 cm (15–20) Candles on birthday cake at 20 cm (10–15) Candlelight

Optimal lighting range

Note:

- The figures in the chart are approximations.

Tips on good lighting

In most outdoor, daytime scenes, natural lighting is adequate for home videos. Indoors, however, artificial lighting is usually required. Video lights with halogen lamps provide the most natural artificial light over a long operating life.



Appendix

DV Technology

Digital video (DV) is a revolutionary technology that enables recording and playback of high quality images with the use of special digital features previously unavailable with conventional analog formats.

DV and conventional video cassette tapes

There are two kinds of DV-format video cassette tapes: the Mini DV cassette and the larger DV cassette used for extended playback and recording. This camcorder only operates with Mini DV cassettes. DV cassettes cannot be used. Be sure to use Mini DV cassettes with the ^{Mini}DV mark.

Mini DV cassette



DV cassette

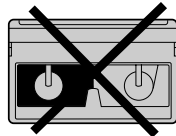

8 mm, VHS, and Beta cassettes cannot be used for playback or recording with this camcorder.

8 mm cassette



VHS cassette



Beta cassette



Note:

- This camcorder reproduces the highest picture quality when used with an ME tape. It is recommended you use an ME tape for high-quality recording and playback.

This product incorporates copyright protection technology that is protected by method claims of certain U.S. patents and other intellectual property rights owned by Macrovision Corporation and other rights owners. Use of this copyright protection technology must be authorized by Macrovision Corporation, and is intended for home and other limited viewing uses only unless otherwise authorized by Macrovision Corporation. Reverse engineering or disassembly is prohibited.

SD Memory Card and MultiMediaCard

SD Memory card and MultiMediaCard are compact recording media just 32 mm long and 24 mm wide which support the needs of the digital network society where music, images, games and various other provider services are offered.

- You can use an SD Memory Card and a MultiMediaCard for storing still images with this camcorder, not a SmartMedia™ card or Memory Stick™ media.

SD Memory Card

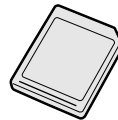

MultiMediaCard

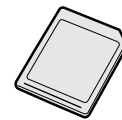

SmartMedia™ card



Memory Stick™ media

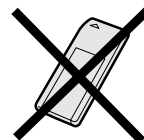

- An SD Memory Card is superior to a MultiMediaCard in terms of copyright protection functions and high speed transfer.
- The SD Memory Card is compatible with MultiMediaCard, and data stored on MultiMediaCard can be used with the SD Memory Card.

Note:

- This camcorder is verified to work with the following card types and capacities.
 - SD Memory Card: 128 MB or less
 - MultiMediaCard: 64 MB or less



Mini DV Cassette

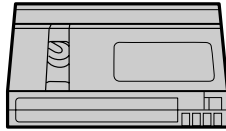

Precautions when using a Mini DV cassette

- Be sure to use only Mini DV cassettes with the **Mini DV** mark.
- This camcorder can record and play back using Mini DV cassettes with cassette memory, but it cannot record or play back this memory.
- To record in LP mode, use a Mini DV cassette labelled for use with LP mode.
- Do not insert anything into the holes on the bottom of the Mini DV cassette or block them in any way.
- Avoid placing the Mini DV cassette in an area conducive to dust or mold.
- Do not place the Mini DV cassette near magnetic sources such as electric clocks or magnetic devices as this may adversely affect recorded material.
- When a previously recorded Mini DV cassette is used again for recording, the previously recorded material will be automatically erased.
- The Mini DV cassette will not operate if inserted in the wrong direction.
- Do not repeatedly insert and eject the Mini DV cassette without running the tape as this may cause uneven tape winding and damage the tape.
- Do not place the Mini DV cassette in direct sunlight, near strong heat sources, or in areas with excessive steam.
- Store the Mini DV cassette in its case and stand it in an upright position.
- If the tape is not properly wound, rewind the tape.
- Do not drop the Mini DV cassette or subject it to excessive shocks.

To protect recordings against accidental erasure

Slide the protect tab on the rear of the Mini DV cassette to the "SAVE" position.

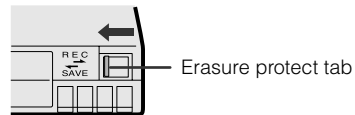

To record over a previously recorded tape, slide the protect tab to the "REC" position.



Copyright Protection

The digital VCR has far superior recording and playback ability than the traditional analog VCR, and in order to protect digital video software copyrights, a system for managing copyrights has been established. Some digital video recording with pre-recorded copyright protection signals can still be played back on this camcorder. If you play a digital video recording that has a copyright protection signal on video equipment with a DV terminal and attempt to record a copy of that software on this camcorder, "COPYRIGHT PROTECTED." appears on the screen and the recording is disabled.

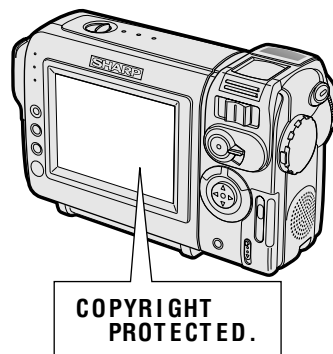



Appendix

MultiMediaCard

Improper handling of the MultiMediaCard may cause damage to the card or images on the card. Follow the instructions below for correct use.

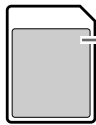

Label

- Do not peel off the label or paste any paper, tape, or other material over it.

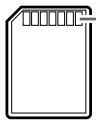

Contacts

- This is the part of the card that makes contact with other equipment. Do not touch with your fingers, scratch, smudge or damage in any way.

Precautions on handling MultiMediaCards

- Be sure to insert the card in the correct direction. Do not try to force the card in.
- The card is a precision component. Do not disassemble or modify it in any way. Take care not to bend it, subject it to severe shock, drop it, or allow it to get wet.
- Do not put the card in your pocket or other unprotected location as it may break due to pressure applied when you sit.
- Do not expose the card to excessive heat or fire.

Do not use or store the MultiMediaCard in the following kinds of environment:

- Locations subject to electrical noise or powerful magnetic fields. Data on the card may be destroyed (erased).
- Locations exposed to direct sunlight.
- Locations subject to high temperature or high humidity.
- Locations where dust gathers in large amounts or blows through the air.
- Corrosive environments.
- Sunlit or enclosed spaces and other such locations subject to high temperature.

Watch out for static electricity

- Do not let dirt or other foreign matter accumulate on the card contacts, or touch them with your fingers, or rub or scrape them. Static electricity may damage (erase) data on the card. Clean the card by wiping it gently with a soft, dry cloth.
- Carry and store the card in its original plastic case to protect it from dirt, grime and static electricity. (The polyethylene case is anti-static.)

Watch out for condensation

- Moisture (condensation) may form inside and outside the card if it is carried into an area subject to sudden, large changes in temperature. Watch out for condensation, because it can cause malfunctions.
- When moisture condenses on the card, leave it at the prevailing temperature until the water evaporates naturally.

Your image data

- It is best to copy your valuable image data from the card onto some other medium (personal computer, floppy disk, MO disk, etc.) and make a backup.
Malfunction, repair, and so on can cause the recorded images to disappear from the card.
- Make absolutely sure not to remove the card or turn the camcorder power off while the card is recording data, erasing data, or formatting (initializing). This can cause loss of data and damage the card.
- Initializing the card will erase the data on it. Make sure no important image data is recorded on the card before you initialize it.
- Please be aware that Sharp Corporation will not be liable for any damages resulting from loss of data caused by incorrect handling of the card by you or a third party, or caused by exposure to static electricity or electrical noise or by malfunction.



SD Memory Card

Precautions on handling SD Memory Cards

- After removing the card from the camcorder, be sure to immediately store it in the card case.
- Do not disassemble or modify the card.
- Do not strike, bend, drop, or allow the card to become wet.
- Do not touch the metal terminals with your hands or metallic objects.
- Do not peel off the label from the card.
- Do not attach other labels or stickers to the card.
- Do not use or store the card in locations directly exposed to sunlight, heat vents, heating appliances, or other locations with extremely high temperatures such as inside a closed vehicle in the summer.
- Do not use or store the card in humid or dusty locations.
- Do not use or store the card in locations exposed to corrosive gases.

Protecting your data

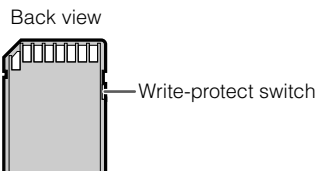

- Set the write-protect switch to "LOCK". Set the switch to the unlocked side when you want to record or edit the card again.
- Do not remove the card or turn off the power of the camcorder and peripheral equipment while data is being read or written. Also do not remove the power source from the camcorder. These actions can cause data to be destroyed. (Please be aware that Sharp Corporation cannot be held liable for any data loss or other loss directly or indirectly caused by data loss.)
- Make backup copies of your data wherever possible.

AC Adapter

- The AC adapter may interfere with reception if used near a radio.
- Prevent flammables, liquids, and metal objects from entering the adapter.
- The adapter is a sealed unit. Do not attempt to open or modify it.
- Do not damage, drop, or subject the adapter to vibration.
- Do not leave the adapter in direct sunlight.
- Avoid using the adapter in humid or extremely hot places.

Replacing the Fluorescent Lamp

This camcorder uses a fluorescent lamp to backlight the LCD monitor. If the monitor becomes dark or difficult to view, the fluorescent lamp may need to be replaced. Contact the nearest SHARP service centre or your dealer for further advice.



Appendix

Battery Pack

This camcorder uses a lithium-ion type battery pack.

Charging

- Charge the battery pack immediately (or a day) before use. The battery pack gradually self-discharges even if stored in a fully charged state.
- Charge the battery pack between 10°C and 30°C.
- Fully charge the battery pack. Use of an insufficiently charged battery pack will shorten actual time of use.
- Refresh (discharging before charging) is unnecessary.

Use

- To conserve battery power, be sure to turn off the camcorder power when not in use.
- Battery consumption may vary depending on the condition of use. Recording with many starts and stops, frequent zooming, and recording in low temperatures will shorten actual recording times.
- Use of a weak battery pack may cause loss of power while operating the camcorder. Use a fully charged battery pack to protect both the battery pack and the unit.
- It is recommended that you have enough battery packs on hand to handle two or three times your estimated recording time. See page 20 for the approximate times of actual recording for the battery packs.

Battery power is consumed even when the camcorder power is turned off. If you are not going to use your camcorder immediately, remove the battery pack (see page 9).

Note:

- Use only SHARP BT-L225 or BT-L445 battery packs. These are designed specifically for use with this camcorder.

Storage

- Store the battery pack in a fully discharged state.
- Store the battery pack in a dry, cool place.
- When storing a fully charged battery pack, put the cover on it so that the "CHARGE" mark printed on the label is seen through the window, as shown.

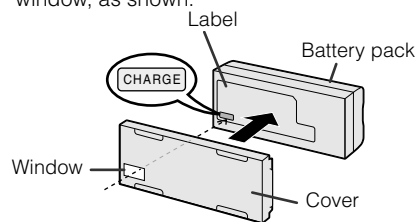

When storing a battery pack that is not fully charged, put the cover upside down so that only the battery pack casing can be seen through the window.

Cautions:

- Improper handling of the battery pack may present a risk of fire or explosion. Pay close attention to the following:
 - Do not allow metallic objects to come in contact with the terminals. This can cause a short circuit.
 - Do not disassemble or repair the battery pack by yourself.
 - Do not use any battery charging equipment other than that designed for use with these battery packs.
 - Do not place the battery pack under direct sunlight or in excessively hot places (over 60°C) such as the dashboard of cars.
 - Do not expose the battery pack to moisture or water.
 - Do not drop the battery pack or subject it to strong force.
 - Keep the battery pack out of reach of children.
 - Dispose of used battery packs promptly. Do not dispose of them in fire.
- To protect the terminals, put the cover on the battery pack when it is not in use.

Notes:

- The battery pack will become warm during charging and use. This is not a malfunction.
- The battery pack has a limited service life. If the period of use becomes noticeably shorter with a normal charge, the battery pack is at the end of its service life. Replace it with a new battery pack.
- If the terminals of the battery pack are dirty, wipe the terminals with a soft, dry cloth.



Cleaning

- Many plastic parts are used in the camcorder casing. Do not use thinner, benzene or other strong chemical cleaners. These may cause discoloration and damage to the casing.
- Clean the casing with a soft, dry cloth. If the casing is particularly dirty, wipe the casing with a tightly wrung cloth dampened with a diluted, neutral detergent. Then wipe it again with a soft, dry cloth.
- Use a soft cloth to wipe finger marks and other smudges off the LCD screen.
- Use a soft cloth, or compressed air and lens paper designed for photographic lenses to clean the lens.

Using Your Camcorder Abroad

Television signal standards and electrical voltages and frequencies vary substantially from country to country. When you are abroad, check the sections below before using the AC adapter or connecting the camcorder to a TV.

AC Adapter (Supplied Accessory)

The supplied AC adapter is compatible with 50 Hz and 60 Hz electrical systems in the range of 110 V to 240 V AC.

Television Signal Standards

In any country, you can always watch the video picture by using the LCD monitor screen. However, if you want to watch the picture on a TV screen, the TV must be PAL system compatible. PAL is used in the following areas: Germany, Great Britain, Sweden, Denmark, Austria, Belgium, Switzerland, Italy, Spain, Holland, Finland, Portugal, Norway, Hong Kong, Thailand, Australia, New Zealand, Singapore, Kuwait, China, etc.



Appendix

Demonstration Mode

Available modes:

TAPE-CAMERA, CARD-CAMERA

You can watch a brief demonstration of the special camcorder features in Demo mode. If the demonstration appears on the screen when you turn on the camcorder for the first time, cancel the Demo mode to use your camcorder.

Watching the Demonstration

- 1 Remove the Mini DV cassette from the camcorder (see page 12).
- 2 In TAPE-CAMERA or CARD-CAMERA mode, press the MENU button until the menu screen appears.
- 3 Press ∇ or Δ on the operation button to select ETC, then press the SET button.
- 4 Press ∇ or Δ to select "DEMO MODE", then press the SET button.

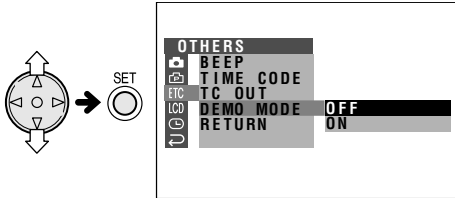

- 5 Press ∇ or Δ to select "ON", then press the SET button.

DEMO MODE ON

- 6 Set the Power switch to OFF, then hold down the Lock button and set the Power switch to CAMERA.
 - The demonstration begins.

Cancelling Demo Mode

- 1 During the demonstration, press the MENU button to pause the demonstration.
- 2 Press ∇ or Δ on the operation button to select ETC, then press the SET button.
- 3 Press ∇ or Δ to select "DEMO MODE", then press the SET button.

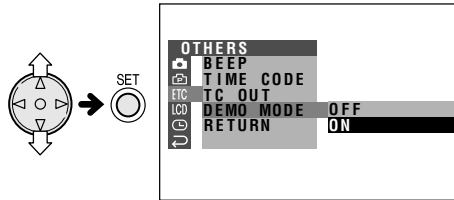

- 4 Press ∇ or Δ to select "OFF", then press the SET button.

DEMO MODE OFF

- 5 Press the MENU button to turn off the menu screen.

Note:

- The demonstration will pause if you press the MENU button. If you leave it for 60 seconds, or turn the power off temporarily and then set the Power switch to CAMERA, the demonstration will begin again.



Before Requesting Service

The following conditions do not always denote trouble. Therefore, perform the checks described below before calling for service. If the problem cannot be corrected by the use of this guide, remove the mains plugs from the wall socket, and contact the dealer or supplier from whom the unit was purchased in order to obtain service. Where this is not possible, please visit our web-site www.sharp.co.uk/support. Customers without Internet access may telephone **08705 274277** during office hours (or **(01)676 0648** if telephoning from Ireland).

Certain replacement parts and accessories may be obtained from our main parts distributor, who can be contacted on the following numbers:

WILLOW VALE ELECTRONICS LTD.: **0121 766 5414**

In the unlikely event of this equipment requiring repair during the guarantee period, you will need to provide proof of the date of purchase to the repairing company. Please keep your invoice or receipt, which is supplied at the time of purchase.

	Symptom	Possible cause	Suggested solution
Power	No power.	Power source is not properly connected.	Connect power source properly (pp. 9, 11).
		Battery pack is not charged.	Charge battery pack sufficiently (p. 10).
		Dew in camcorder.	Wait until dew dries (p. iv).
		Safety function is in effect.	Set Power switch to OFF and remove battery pack. Wait for 2 seconds, then reinstall battery pack and turn on power (p. 9).
CAMERA mode	REC START/STOP button does not work.	Erasure-protect tab on video cassette is open.	Close tab or use a new cassette (p. 72).
	Power suddenly turns off.	Camcorder left in Recording Standby mode for 5 minutes in TAPE-CAMERA mode.	Set Power switch to OFF and then back to CAMERA.
	Auto focus does not work.	Manual Focus mode is engaged.	Set to Auto Focus mode (p. 42).
		Zoom used on close subject.	Zoom out from subject (p. 21).
		Subject has little contrast in brightness, or is full of horizontal or vertical stripes.	Focus manually (p. 42).
	Bright subject produces wide vertical lines.	Occurs when shooting subject with strong contrast to the background. Does not indicate a malfunction.	—
	Automatically zooms out without operating Zoom control.	Camcorder is unable to focus when zooming in on subject within 1.5 m, and automatically zooms out until it focuses on subject.	—
No subject in the field of view.		Direct lens to some subject, or set zoom to widest angle before shooting (p. 21).	
Display automatically changes in TAPE-CAMERA mode.	Camcorder is in Demo mode.	Set DEMO MODE menu item to "OFF" (p. 77).	
VCR mode	No image appears on connected TV screen.	Video input channel on TV or TV channel is not selected properly.	Select video input channel or TV channel properly (p. 25).
		Audio/video cable is not properly connected.	Connect audio/video cable properly (p. 25).
	No image from an external source appears on the camcorder screen.	DV cable or audio/video cable is not properly connected.	Connect DV cable or audio/video cable properly (pp. 49-51)





Appendix

	Symptom	Possible cause	Suggested solution
VCR mode	Cannot rewind or fast forward tape.	Position at beginning or end of tape.	Rewind or fast forward tape to desired point (p. 23).
	Video noise in image.	Dirty video heads.	Call for service (p. 78) or use a commercially available cleaning tape (p. V).
		Old or worn tape.	Use a new cassette.
CARD mode	Cannot delete image on card.	Image is delete-protected.	Cancel the protection setting (p. 60).
	Cannot format card.	—	Contact your dealer for advise.
General	Cassette will not eject.	Power source is not properly connected.	Connect power source properly (pp. 9, 11).
		Battery pack is not charged.	Charge battery pack sufficiently (p. 10).
		Camcorder is recording.	Stop tape and try again (p. 20).
	No image on monitor.	Backlight has been turned off.	Turn on backlight (p. 68).
		Fluorescent lamp has burned out.	Call for service (p. 78).
	Monitor picture is hard to see.	Inappropriate picture adjustments.	Adjust picture (p. 68).
	Charge indicator flashes in red when charging battery pack.	AC adapter or battery pack may have malfunctioned.	Call for service (p. 78).
	Cannot edit to connected VCR.	Audio/video cable is not properly connected.	Connect audio/video cable properly (p. 48).
	Remote control does not function.	REMOTE menu item is set to "OFF".	Set REMOTE menu item to "ON" (p. 38).
		Remote control battery has run down.	Replace remote control battery with new one (p. 38).
		Remote control used beyond operating range.	Use remote control within operating range (p. 38).
		Intense daylight falling on camcorder remote sensor.	Protect remote sensor from exposure to intense daylight (p. 38).
Obstacle between remote control and camcorder remote sensor.		Remove obstacle or use remote control from different angle (p. 38).	

Notes:

- This unit is equipped with a microprocessor. Its performance could be adversely affected by external electrical noise or interference. If this should happen, turn off the power and disconnect the unit from any power sources, including the lithium battery, etc. Then reconnect the power sources to resume operation.
- If the characters displayed on the monitor screen appear to malfunction, disconnect the power source and remove the lithium battery, then reconnect the power source, insert the lithium battery, and turn the power on again. The characters on the monitor should be normal. Set the date and time, then resume operation.



Specifications

Camcorder

Signal System:	PAL standard
Recording System:	2 rotary heads, helical scanning system
Cassette:	Digital VCR Mini DV video cassette
Recording/Playback Time:	90 minutes (DVM60, LP mode)
Tape Speed:	SP mode: 18.831 mm/second LP mode: 12.568 mm/second
Pickup Device:	1/4" (6.4 mm, effective size: 4.5 mm) CCD image sensor (with approx. 800,000 pixels including optical black)
Lens:	10× optical/300× digital power zoom lens (F1.8, f=3.6–36.0 mm), full-range auto focus
Lens Filter Diameter:	27 mm
Monitor:	3" (7.5 cm) full-colour LCD screen (TFT active matrix)
Microphone:	Electret stereo microphone
Colour Temperature Compensation:	Auto white balance with white balance lock
Minimum Illumination:	1 lux* (with gain-up, F1.8)
Still Image Compression System:	JPEG base line conformance
Still Image Recording Format:	JPEG (Exif2.1)
Still Image Recording Medium:	SD Memory Card, MultiMediaCard
Power Requirement:	DC 7.4 V
Power Consumption:	4.3 W (during camera recording in Full Auto mode with zoom motor off and backlight in normal mode)
Operating Temperature:	0°C to +40°C
Operating Humidity:	30% to 80%
Storage Temperature:	–20°C to +60°C
Dimensions (approx.):	141.1 mm (W) × 85.1 mm (H) × 58.5 mm (D)
Weight (approx.):	465 g (without battery pack, lithium battery, video cassette, lens cap, lens hood, wrist strap and card)

AC Adapter (UADP-0342TAZZ)

Power Requirement:	AC 110–240 V, 50/60 Hz
DC Output:	10 V
Dimensions (approx.):	46.0 mm (W) × 29.0 mm (H) × 111.0 mm (D)
Weight (approx.):	145 g

SD Memory Card

Memory Capacity:	8 MB
Power Requirement:	3 V
Operating Temperature:	0°C to +40°C
Storage Temperature:	–20°C to +65°C

Specifications are subject to change without notice.

*Minimum illumination: Since there is no widely accepted testing procedure for determining minimum illumination capability, lux ratings are comparable only between models from the same manufacturer.

Free Manuals Download Website

<http://myh66.com>

<http://usermanuals.us>

<http://www.somanuals.com>

<http://www.4manuals.cc>

<http://www.manual-lib.com>

<http://www.404manual.com>

<http://www.luxmanual.com>

<http://aubethermostatmanual.com>

Golf course search by state

<http://golfingnear.com>

Email search by domain

<http://emailbydomain.com>

Auto manuals search

<http://auto.somanuals.com>

TV manuals search

<http://tv.somanuals.com>