

# SHARP®

VIDEOKAMERA MED FLYTANDE KRISTALLSKÄRM  
LIQUID CRYSTAL DISPLAY CAMCORDER

**VL-NZ8S  
VL-NZ10S**

SVENSKA

ENGLISH

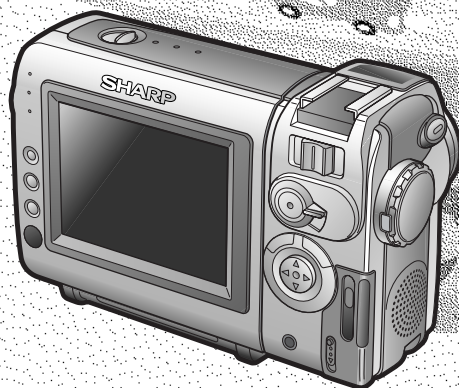

**SHARP**  
**VIEW•CAM**

■ BRUKSANVISNING ■  
■ OPERATION MANUAL ■

Mini **DV**

- Logotypen **Mini DV** är ett varumärke.
- The **Mini DV** logo is a trademark.

This equipment complies with the requirements of Directives 89/336/EEC and 73/23/EEC as amended by 93/68/EEC.

Dieses Gerät entspricht den Anforderungen der EG-Richtlinien 89/336/EWG und 73/23/EWG mit Änderung 93/68/EWG.

Ce matériel répond aux exigences contenues dans les directives 89/336/CEE et 73/23/CEE modifiées par la directive 93/68/CEE.

Dit apparaat voldoet aan de eisen van de richtlijnen 89/336/EEG en 73/23/EEG, gewijzigd door 93/68/EEG.

Dette udstyr overholder kravene i direktiv nr. 89/336/EEC og 73/23/EEC med tillæg nr. 93/68/EEC.

Quest' apparecchio è conforme ai requisiti delle direttive 89/336/EEC e 73/23/EEC, come emendata dalla direttiva 93/68/EEC.

Η εγκατάσταση αυτή ανταποκρίνεται στις απαιτήσεις των οδηγιών της Ευρωπαϊκής Ένωσης 89/336/ΕΟΚ και 73/23/ΕΟΚ, όπως οι κανονισμοί αυτοί συμπληρώθηκαν από την οδηγία 93/68/ΕΟΚ.

Este equipamento obedece às exigências das directivas 89/336/CEE e 73/23/CEE, na sua versão corrigida pela directiva 93/68/CEE.

Este aparato satisface las exigencias de las Directivas 89/336/CEE y 73/23/CEE, modificadas por medio de la 93/68/CEE.

Denna utrustning uppfyller kraven enligt riktlinjerna 89/336/EEC och 73/23/EEC så som kompletteras av 93/68/EEC.

Dette produktet oppfyller betingelsene i direktivene 89/336/EEC og 73/23/EEC i endringen 93/68/EEC.

Tämä laite täyttää direktiivien 89/336/EEC ja 73/23/EEC vaatimukset, joita on muutettu direktiivillä 93/68/EEC.

**POZOR! PŘED SEJMUTÍM KRYTU NUTNO VYJMOUT SÍŤOVOU VIDLICI ZE SÍŤOVÉ ZÁSUVKY.  
UPOZORNĚNÍ: OPRAVU SMÍ PROVÁDĚT POUZE ODBORNÝ SERVIS.**

Before using the camcorder, please read this operation manual carefully, especially page vii.

# OPERATION MANUAL

ENGLISH

**WARNING**  
**TO PREVENT SHOCK HAZARD, DO NOT EXPOSE THIS APPLIANCE TO RAIN OR MOISTURE.**

This equipment should be used with the recommended AC adapter/battery charger or battery pack.

**CAUTION**  
To prevent electric shocks and fire hazards, do NOT use any other power source.

**Important:**  
Audio-visual material may consist of copyrighted works which must not be recorded without the authority of the owner of the copyright. Please refer to relevant laws in your country.

**CAUTION**  
To prevent shock, do not open the cabinet. No user serviceable parts inside. Refer servicing to qualified dealer or service centre.

**Power supply:**  
This unit can be operated by connecting it to either the AC adapter/battery charger or battery pack. The AC adapter/battery charger incorporates the AUTO VOLTAGE (AC 110–240 V, 50/60 Hz) function.

**NOTE**  
The LCD panel of this camcorder is a very high technology product with more than 120,000 thin-film transistors\*, giving you fine picture detail. Occasionally, a pixel may appear on the screen as a fixed point of blue, green, red, or black. Please note that this does not affect the performance of your camcorder.

\*Specifications are subject to change without notice.

**Trademarks**

- Microsoft and Windows are either registered trademarks or trademarks of Microsoft Corporation in the United States and/or other countries.
- Adobe Acrobat Reader is a trademark of Adobe Systems Incorporated.
- DPOF is a trademark of CANON INC., Eastman Kodak Company, Fuji Photo Film Co., Ltd. and Matsushita Electric Industrial Co., Ltd.
- All other brand or product names are registered trademarks or trademarks of their respective holders.

ENGLISH

# Quick Operation Guide

Please consult this operation manual further for details on these and other functions of your camcorder.

## Charging the Battery Pack

- 1 Connect the supplied power cord to the AC power socket on the AC adapter/battery charger, and insert the AC plug into a power outlet.

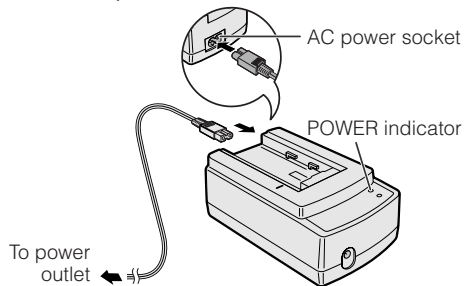

- The POWER indicator lights up.

- 2 Align the mark on the battery pack with the mark on the charger (1) and guide the battery into the groove. Pressing the battery (2), slide it in the direction of the arrow (3) until it locks into place.

- The CHARGE indicator lights up.

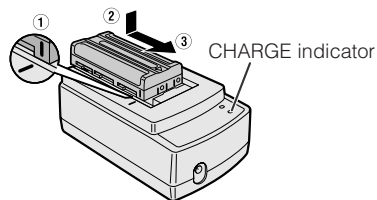

- The CHARGE indicator turns off when the battery is fully charged.

- 3 Slide the battery pack in the direction of the arrow (1), and remove it (2). Then remove the AC plug of the power cord from the power outlet.

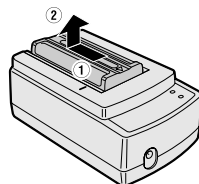

GB i

## Attaching the Battery Pack

- 1 Make sure that the Power switch is set to OFF.
- 2 Align the mark on the side of the battery pack with the mark on the camcorder (1), and slide the battery pack in the direction of the arrow completely until it locks into place (2).

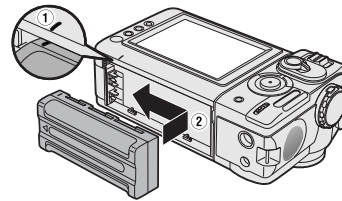

## Inserting a Cassette

- 1 Attach the power source to the camcorder, then slide the cassette compartment door release and open the cassette compartment door.

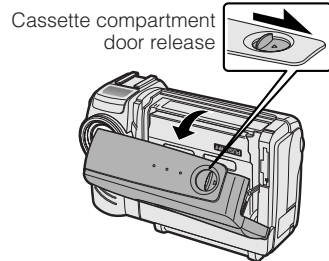

- 2 Insert a commercially available cassette fully with the window facing outwards, and with the erasure protect tab facing upwards.

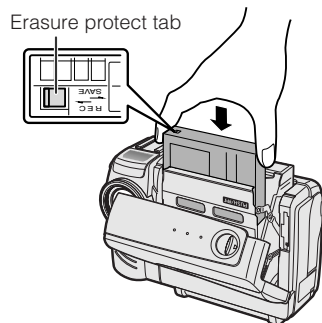

- 3 Press the **PUSH/押し** mark gently until the cassette holder clicks into place.

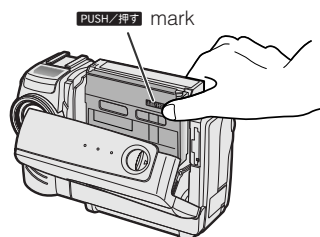

- 4 Wait for the cassette holder to fully retract. Close the compartment door by pressing the centre until it clicks into place.

## Inserting a Card

- 1 Make sure that the Power switch is set to OFF.
- 2 Slide the card slot cover release and open the card slot cover in the direction of the arrow.

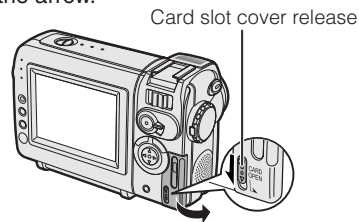

- 3 Insert a card into the slot as shown below, and push it in as far as it will go.

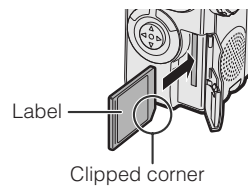

- 4 Close the card slot cover.

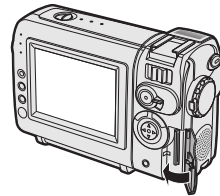

### Note:

- You can use an SD Memory Card (commercially available) and a MultiMediaCard (only supplied with VL-NZ10) for storing still images with this camcorder, not a SmartMedia™ card or Memory Stick™ media. In this operation manual, "card" refers to the SD Memory Card or the MultiMediaCard.

## Quick Operation Guide

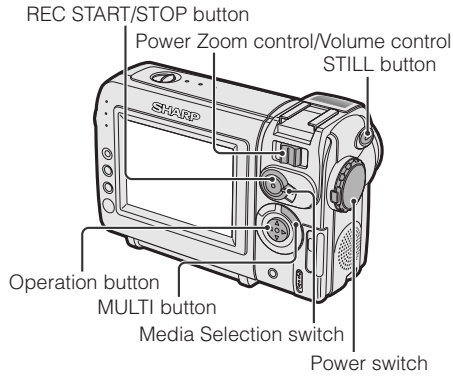

### Easy Camera Recording on Tape

1 Insert a cassette into the camcorder.

2 Set the Media Selection switch to TAPE.

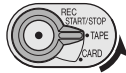

3 Hold down the Lock button and set the Power switch to CAMERA.

- The picture from the lens is now displayed on the screen.

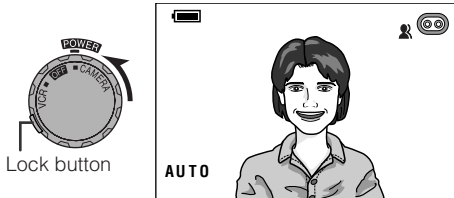

4 Press the REC START/STOP button to begin recording.

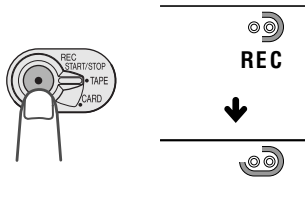

### To pause recording

Press the REC START/STOP button again.

### Zooming

Push the Power Zoom control to T (1) (telephoto) or W (2) (wide angle) side.

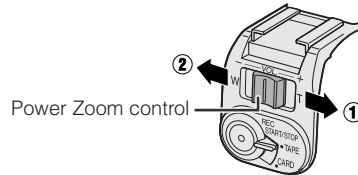

### Tape Playback

1 Set the Media Selection switch to TAPE.

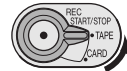

2 Hold down the Lock button and set the Power switch to VCR.

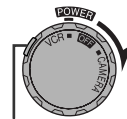

Lock button

3 Press < (or >) on the Operation button to rewind (or fast forward) the tape to the desired point.

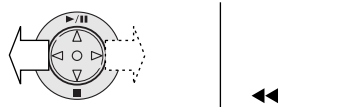

4 Press Δ to begin playback.

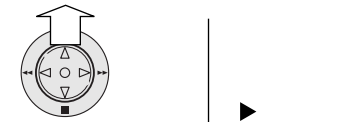

### To stop playback

Press ∇.

### Volume Control

Push the Volume control to the + or - side to increase (1) or decrease (2) the volume.

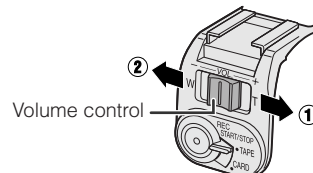

## Card Recording

1 Insert a card into the camcorder.

2 Set the Media Selection switch to CARD.



3 Hold down the Lock button and set the Power switch to CAMERA.

- The picture from the lens is now displayed.

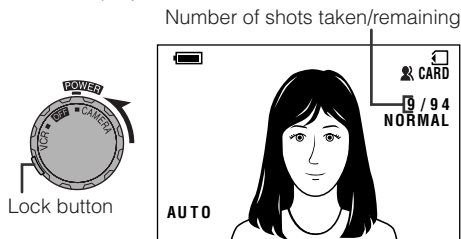

4 Adjust the Power Zoom control to frame the subject as you desire.

5 Press the STILL button half-way down to focus on the subject.

- The camcorder automatically focuses on the subject. When it is set, you will hear a sound and see mark, then the camcorder locks the focus.



6 Press the STILL button fully to begin recording.

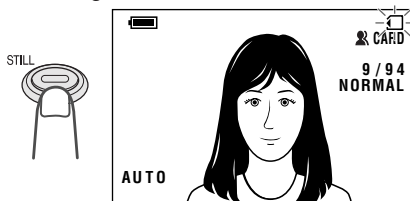

- The indicator flashes red while data is being recorded on the card, and returns to white when recording completes.

## Card Playback

1 Set the Media Selection switch to CARD.



2 Hold down the Lock button and set the Power switch to VCR.

- The images recorded on the card are displayed in a thumbnail format.

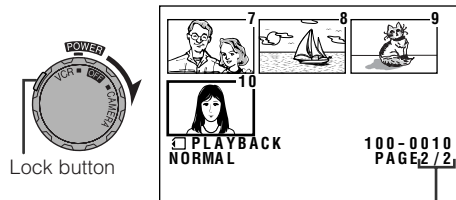

Page number/total thumbnail pages

3 Press , , or on the Operation button to move the selection frame to the desired image.

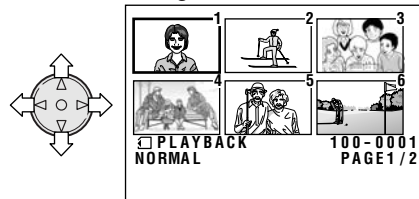





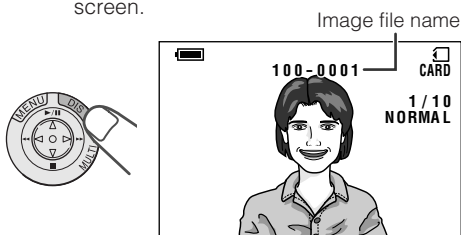



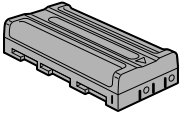
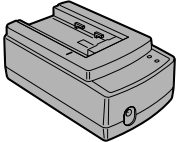

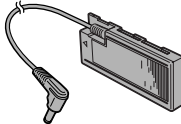

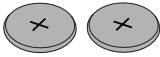
4 Press the MULTI button.

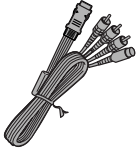
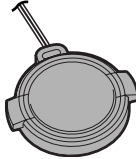
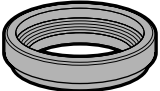
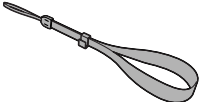
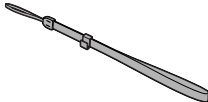
- The selected image is displayed in full-screen.

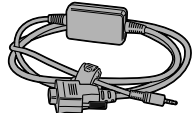
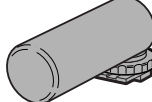
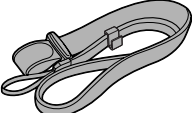
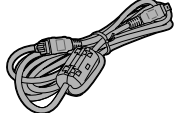
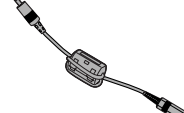

# Supplied Accessories

 <p>Battery pack BT-L225</p>	 <p>AC adapter/ battery charger</p>	 <p>Power cord</p>	 <p>DC cable</p>
<p>*</p>  <p>Remote control RRMCG0104TASA</p>	<p>2 for VL-NZ10</p>  <p>1 for VL-NZ8</p>  <p>CR2025 type lithium battery</p>	 <p>Audio/video/S-video cable</p>	 <p>Lens cap</p>
 <p>Lens hood</p>	<p>For VL-NZ10</p>  <p>Hand strap</p>	<p>For VL-NZ8</p> 	 <p>Tripod adapter</p>
<p>*</p>  <p>8 MB MultiMediaCard CDSKA0063TA01</p>	<p>*</p>  <p>PixLab Video Capture Software (Lite Version) CDSKA0059TA01</p>	<p>*</p>  <p>PC connecting cable QCNW-1914TAZZ</p>	<p>*</p>  <p>Zoom microphone RMICC0107TAZZ</p>
<p>*</p>  <p>Shoulder strap UBNSD0029TAZZ</p>	 <p>DV cable</p>	 <p>Earphones connecting cable</p>	 <p>Grip handle</p>

Parts with "\*" mark is not supplied with VL-NZ8. Contact the nearest SHARP service centre or your dealer for purchasing specified parts.



## Optional Accessories

---

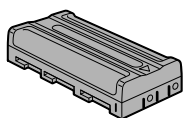

Standard-life  
battery pack  
BT-L225

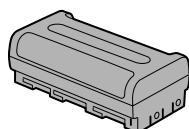

Extended-life  
battery pack  
BT-L445

# Precautions

- **When the camcorder is not in use, remember to remove the cassette tape, turn off the power, and disconnect the camcorder from the power source.**

- **Do not aim the lens at the sun.**  
Do not allow direct sunlight to strike the camcorder lens or LCD monitor screen, whether or not recording is in progress, as it may damage the CCD sensor or LCD screen surface. Be particularly careful when recording outside.

- When shooting in dark places, avoid sudden brightly lit objects or light sources, such as the sun. Otherwise, the image may white out. Should this happen, point the lens in a different direction until the picture returns to normal.

- **Avoid magnetic sources.**

Using the camcorder near strong fluorescent lights, motors, televisions, or other magnetic sources may adversely affect recorded images.



- **Using the camcorder near a broadcasting station or other powerful transmission source may cause buzzing or picture deterioration.**

- **Avoid shocks and dropping.**

Do not drop or otherwise subject the camcorder to hard shocks or strong vibrations. Bumping or striking the unit during recording will generate noise in the recorded image.

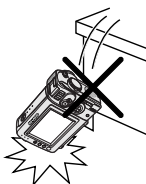

- **Avoid placing the camcorder in close proximity to lighting equipment.**

The heat from incandescent lights may deform the camcorder, or cause it to malfunction.



- **Always respect prohibitions or restrictions on the use of electronic equipment on commercial flights or in other sensitive areas.**

- **Be aware of the temperature and humidity.**

You can use your camcorder at 0°C to +40°C, and at 30% to 80% relative humidity. Do not store the unit in an unventilated car in the summer, in direct sunlight, or near strong heat sources; this can result in severe damage to the unit casing and circuitry.

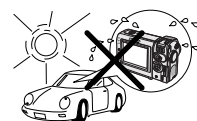

- **Avoid situations where water, sand, dust or other foreign matter could get on or inside the camcorder, and do not use or leave your camcorder in areas with excessive smoke, steam or moisture.**

Such environments can cause malfunctions or cause mildew to form on the lenses. Be sure to keep the unit in a well-ventilated location.

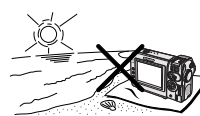

- **Some small, portable tripods may be difficult to attach and may not be sturdy enough to support your camcorder. Be sure to use only a strong, stable tripod.**



- **When using your camcorder in a cold environment, the LCD monitor screen often appears less bright immediately after the power is turned on. This is not a malfunction. To prevent the camcorder from becoming too cold, wrap it in a thick cloth (a blanket, etc.).**

## Dew Formation

### • What is “dew formation”?

When cold water is poured into a glass, dew drops form on the glass. This clinging of water drops is called dew formation.

### • When dew forms in your camcorder.

Dew will gradually form on the head drum of your camcorder and make the video tape stick to the head. This causes damage both to the head and the tape. When dew forms, recording and playback may not function properly.

Dew is likely to form in the following circumstances:

- When moving the camcorder from a cold place to a warm place.
- When placing the camcorder in a cold room which is then heated rapidly.
- When moving the camcorder outdoors from an air conditioned room or car.
- When placing the camcorder in the direct path of air blowing from an air conditioner.
- When placing the camcorder in a humid room.



### • How to prevent trouble.

When using the camcorder in a place where dew is likely to form, allow the camcorder and the video tape to acclimatise to the surroundings for about one hour.

For example, when bringing the camcorder indoors after skiing, place it in a plastic bag.

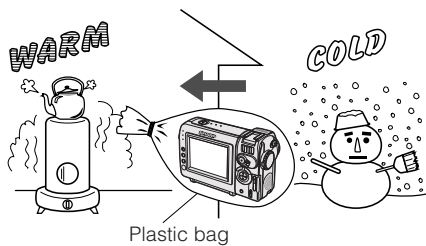

- ① Be sure to tightly seal the plastic bag containing the camcorder.
- ② Remove the bag when the air temperature inside it reaches the temperature of the room.

### • “Dew” warning feature

If dew forms, the word “DEW” flashes on the screen, and the power will automatically turn off in approximately 10 seconds.

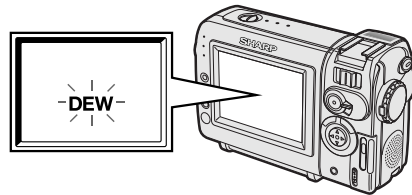

- ① If “DEW” flashes, remove the cassette, leave the cassette compartment open, and wait for a few hours to allow the camcorder to acclimatise to the surrounding temperature.
- ② To use the camcorder again, turn on the power after waiting for a few hours. Be sure that “DEW” has disappeared.
- ③ Do not insert a cassette while “DEW” is flashing; this may result in damage to the tape.
- ④ Since dew forms gradually, it may take 10 to 15 minutes before the dew warning feature engages.

## Precautions

### Dirty Video Heads

When the video heads have become clogged with dirt (dust and tape coating particles),

Striped noise



Mosaic noise



- mosaic-like noise appears on the playback picture. (see above illustration)
- playback pictures do not move.
- during playback, the whole screen becomes blue.

### Causes of video head clogging

- High-temperature and high-humidity environment
- A lot of dust in the air
- Damaged tape
- Worn tape
- Long-time use
- Dew formation

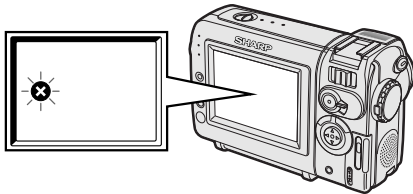

If the video heads become clogged, the  indicator appears on the screen. Contact the nearest SHARP service centre or your dealer for further advice.

### Using a Cleaning Tape (Commercially Available)

**Available mode:** TAPE-VCR

You can clean the video head with a commercially available cleaning tape.

#### Notes:

- **Excessive use of the cleaning tape may cause damage to the video heads. Please read the instructions accompanying the cleaning tape carefully before using it.**
- The fast forward and rewind functions cannot be used when the cleaning tape is in the camcorder.
- If the video heads again become clogged with dirt soon after cleaning, this might be caused by a damaged tape. In this case, stop using that cassette immediately.

- 1 Insert a cleaning tape into the camcorder.
- 2 Set the camcorder to TAPE-VCR mode.
  - The video head cleaning screen appears.
- 3 Press the SET button to begin video head cleaning.
  - "NOW CLEANING" flashes during cleaning.

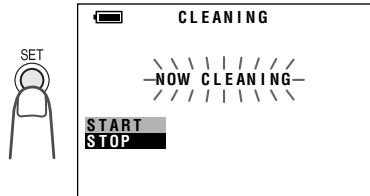

- After about 20 seconds, video head cleaning automatically finishes, and "EJECT THE CASSETTE." displays.

- 4 Remove the cleaning tape.

To cancel cleaning, press the SET button.

# Contents

<p><b><u>Operation References</u></b></p>	<p>Part Names ..... 1</p> <p>Quick Reference List ..... 4</p> <p>On-screen Display Index ..... 5</p> <p>Warning Indicators ..... 7</p>
<p><b><u>Preparation</u></b></p>	<p>Charging the Battery Pack ..... 9</p> <p>Attaching and Removing the Battery Pack ..... 10</p> <p>Powering the Camcorder from an AC Outlet ..... 11</p> <p>Inserting and Removing a Cassette ..... 12</p> <p>Inserting and Removing a Card ..... 13</p> <p>Installing the Lithium Batteries ..... 14</p> <p>Selecting the Language for the On-screen Display ..... 15</p> <p>Setting the Area, Date and Time ..... 16</p> <p>Attaching the Lens Hood ..... 17</p> <p>Attaching the Straps ..... 17</p> <p>Using the Lens Cap ..... 18</p> <p>Tips on Recording Positions ..... 18</p>
<p><b><u>Basic Operations</u></b></p>	<p><b>Camera Recording</b></p> <p>Selecting the Camcorder Mode ..... 19</p> <p>Easy Camera Recording on Tape in Full Auto Mode ..... 20</p> <p>Zooming ..... 21</p> <p>Auto Focus ..... 21</p> <p>Macro Shots ..... 21</p> <p>Remaining Recording Time Display ..... 22</p> <p>Remaining Battery Power Display ..... 22</p> <p><b>Playback</b></p> <p>Tape Playback ..... 23</p> <p>Using Earphones (Commercially Available) ..... 23</p> <p>Volume Control ..... 24</p> <p>Still ..... 24</p> <p>Video Search ..... 24</p> <p>Watching Playback on a TV ..... 25</p>
<p><b><u>Useful Features</u></b></p>	<p>Using the Menu Screens ..... 26</p> <p><b>Camera Recording</b></p> <p>Displaying the Recording Guide ..... 27</p> <p>Setting the Digital Zoom ..... 28</p> <p>Using the Zoom Microphone (Only supplied with VL-NZ10) ..... 29</p> <p>Windbreak ..... 30</p> <p>Gamma Brightness Compensation ..... 31</p> <p>Gain-up ..... 32</p>

Operation References

Preparation

Basic Operations

Useful Features

Advanced Features

Digital Still Camera  
Features

Appendix

## Contents

---

### **Useful Features**

Quick Return .....	33
Edit Search .....	33
Fade In and Fade Out .....	34
Still Recording .....	35
Recording a Still Life .....	36
Wide Screen (16:9) .....	37
Digital Image Stabilization (DIS) .....	37
Self Recording .....	38
Recording in LP (Long Play Recording) Mode .....	39
Selecting the 16-bit Audio Recording Mode .....	40
Turning off the On-screen Indicators .....	40
Attaching the Supplied Tripod Adapter .....	41
Attaching the Supplied Grip Handle .....	41

### **Playback**

Using the Remote Control (Only supplied with VL-NZ10) .....	42
Tape Playback Functions with the Remote Control (Only supplied with VL-NZ10) .....	43
Playback Zoom with the Remote Control (Only supplied with VL-NZ10) .....	44
Displaying the Date and Time of Recording .....	45
Gamma Playback .....	46
Multiple Strobe Playback .....	47
Copying an Image from Tape to Card .....	48
Playback Effects .....	49
Picture Effect Playback .....	50

### **Advanced Features**

### **Camera Recording**

Digital Picture Effects .....	51
Scene Menu (Program AE) .....	52
Manual Focus .....	53
Setting the Camcorder to Full Auto Mode .....	54
Adjusting White Balance .....	55
Manual Exposure .....	56
Setting the Shutter Speed .....	57

### **Playback**

Using the Time Code .....	59
Editing .....	60
Editing with the DV Terminal (IEEE1394) .....	61
Audio Dubbing Feature .....	62
Selecting the Audio Playback Mode .....	64
Configuring Software for PC Connection .....	65

<b>Digital Still Camera Features</b>	<b>Camera Recording</b>	
	Card Recording .....	67
	Selecting the Picture Quality .....	68
	Recording with the Self-timer .....	69
	Formatting a Card .....	70
	<b>Playback</b>	
	Card Playback .....	71
	Delete Protection .....	72
	Deleting Stored Images .....	73
	Slide Show Playback .....	75
Copying an Image from Card to Tape .....	76	
Print Order .....	77	
Transferring Data on Card to Computer .....	79	
<b>Appendix</b>	Picture/Backlight Adjustments .....	80
	World Clock .....	81
	Selecting Summer Time .....	83
	Setting the Confirmation Sounds .....	83
	Setting the Camcorder to Factory Presettings .....	84
	Useful Information .....	85
	Demonstration Mode .....	92
	Before Requesting Service .....	93
Specifications .....	95	

Operation References
Preparation
Basic Operations
Useful Features
Advanced Features
Digital Still Camera Features
Appendix

# Operation References

## Part Names

For details on the use of each part, refer to the page number indicated in brackets.

### Front view

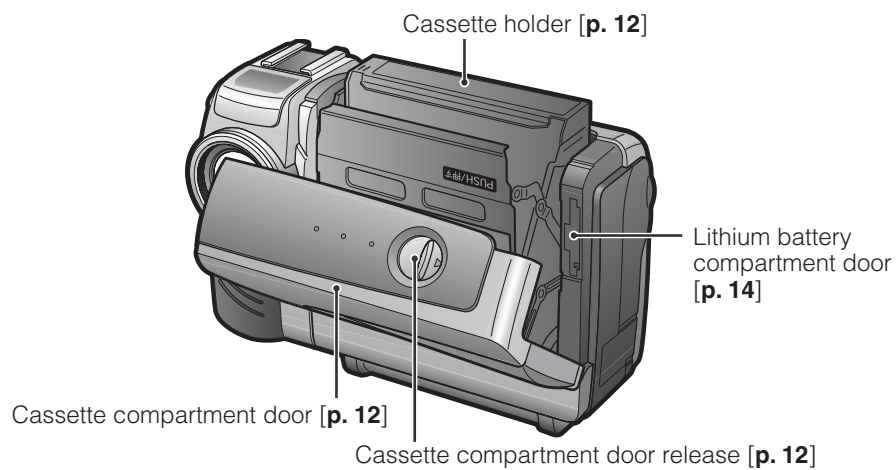
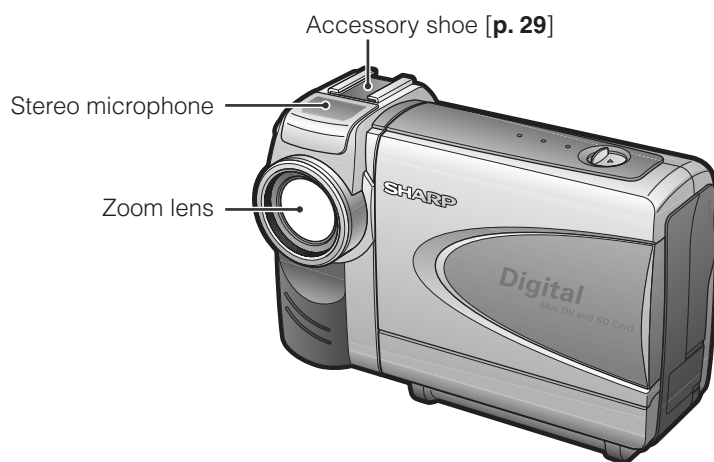



Rear view

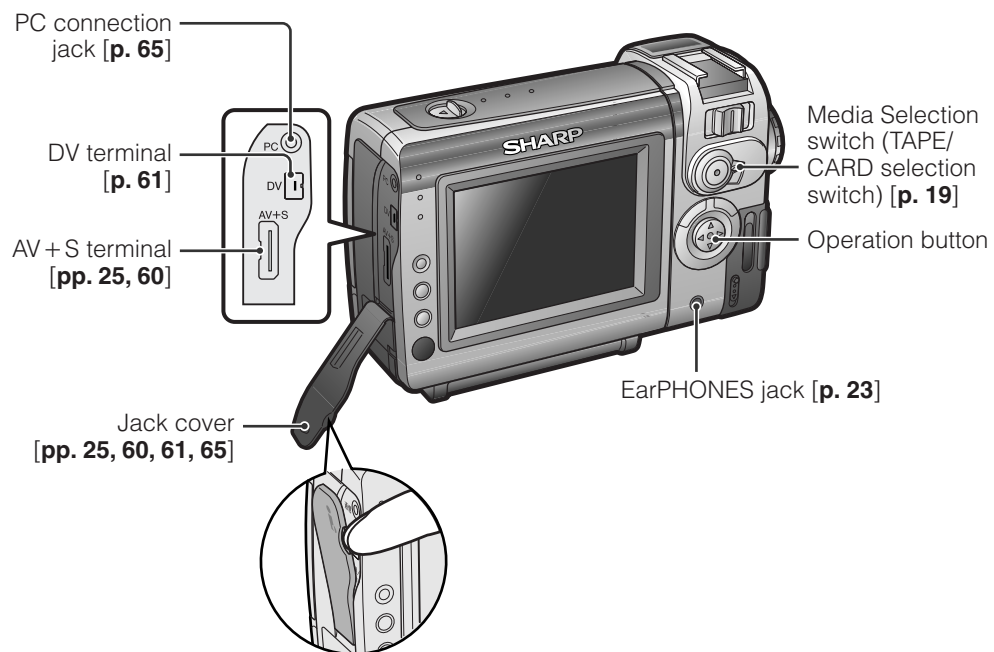

## Operation References

### Rear view

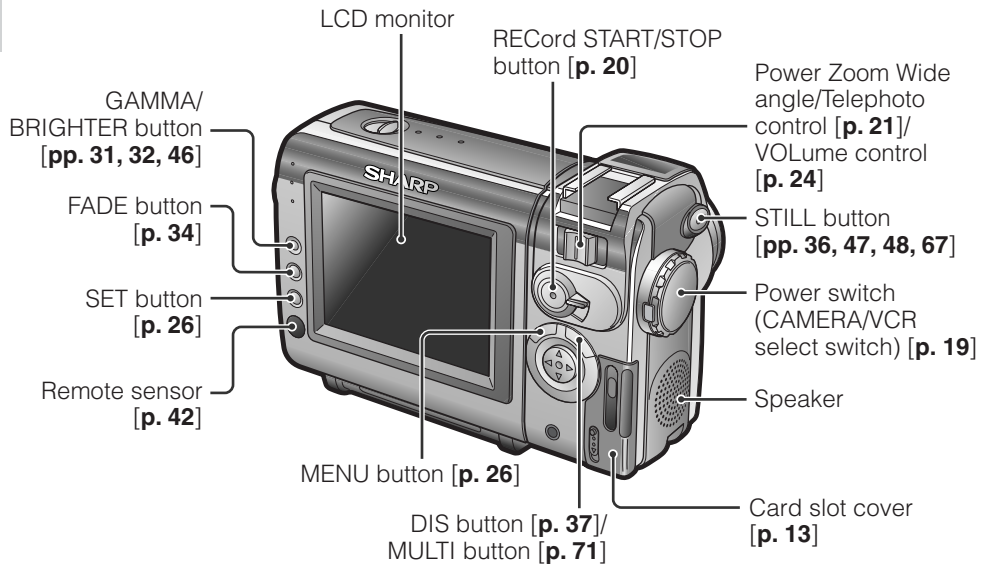

### Bottom view

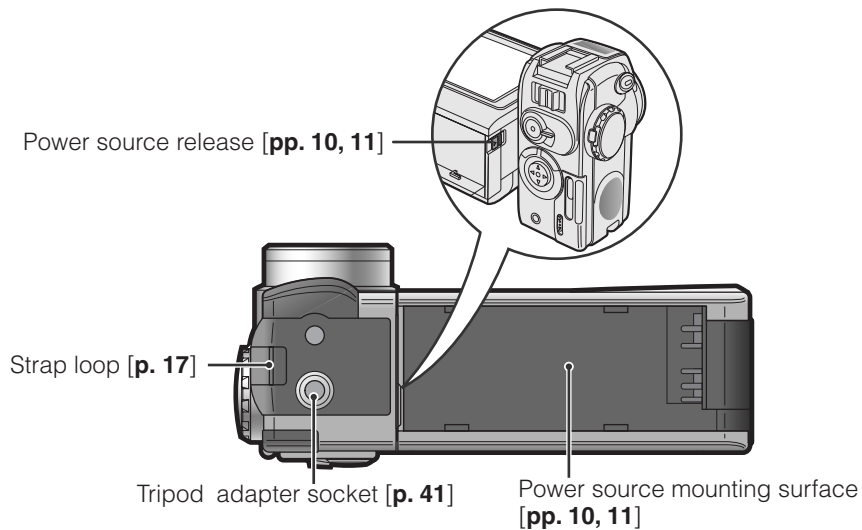

## Quick Reference List

Below are some examples of camcorder's features.

- To record powerful close-up images.  
—See **page 28** (Setting the Digital Zoom)
- To record a backlit subject.  
—See **page 31** (Gamma Brightness Compensation) or **page 56** (Manual Exposure)
- To quickly return the tape to the end of the last recorded scene after playback.  
—See **page 33** (Quick Return)
- To record yourself in the scene while monitoring the shot.  
—See **page 38** (Self Recording)
- To record the subject with higher-quality audio.  
—See **page 40** (Selecting the 16-bit Audio Recording Mode)
- To enlarge any part of the picture during playback.  
—See **page 44** (Playback Zoom with the Remote Control)
- To brighten the dark portion of the playback images without changing the bright portion.  
—See **page 46** (Gamma Playback)
- To focus on an off-centred subject.  
—See **page 53** (Manual Focus)
- To record still images on a card so that the images may be easily read into a computer.  
—See **page 67** (Card Recording)
- To turn off the confirmation sounds which are made when you operate the camcorder.  
—See **page 83** (Setting the Confirmation Sounds)

## Operation References

### On-screen Display Index

For details on the use of each function, refer to the page number indicated.

#### TAPE-CAMERA mode

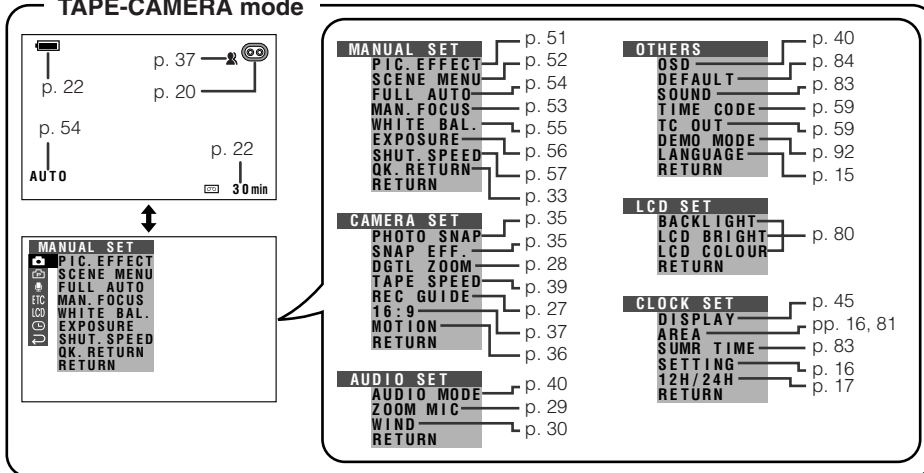

#### TAPE-VCR mode

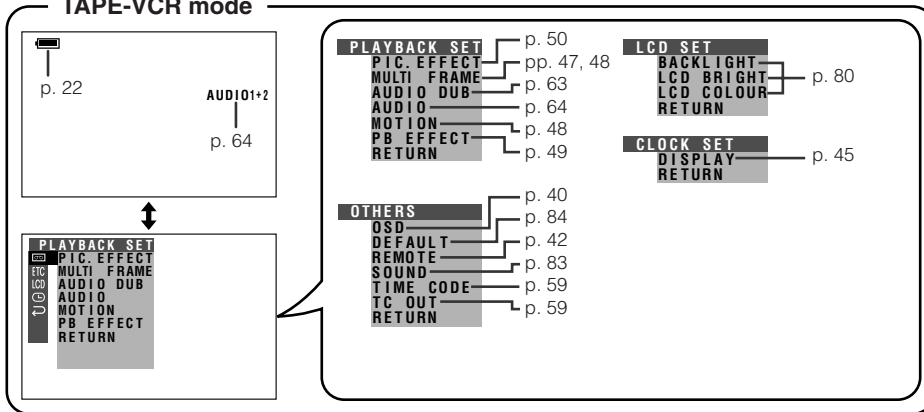

### CARD-CAMERA mode

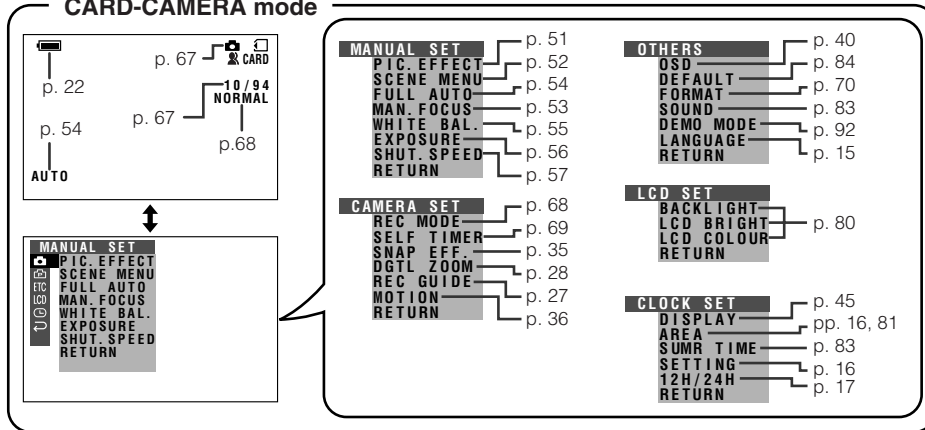

### CARD-VCR mode

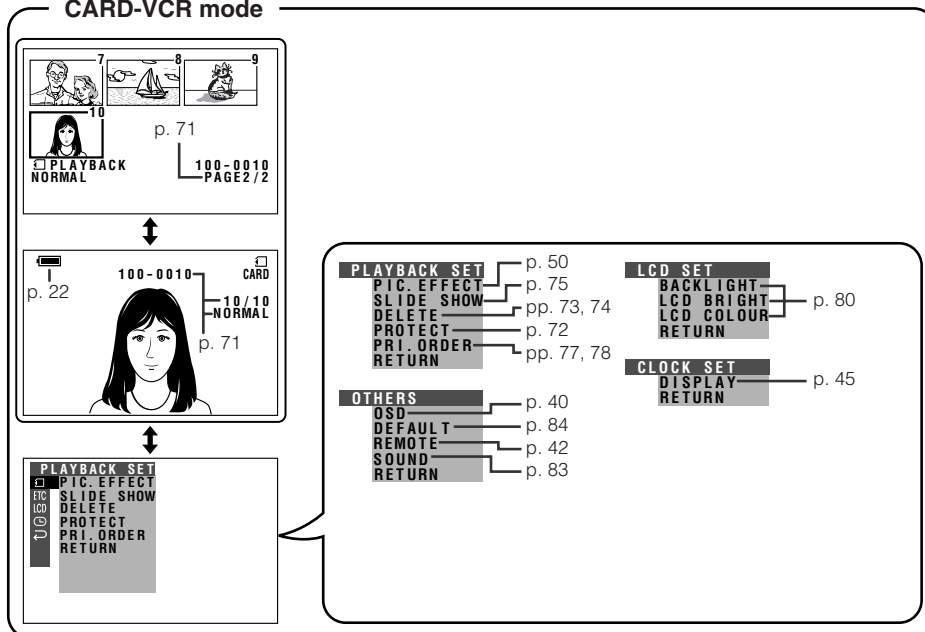

**Note:**

- See page 26 for procedures on how to display the desired screen.

## Operation References

### Warning Indicators

If a warning indicator appears on the screen, follow the specified instructions.

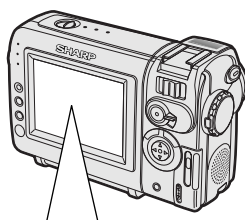

Displayed for the first 3 seconds	Displayed after 3 seconds	Description of warning
<b>INSERT A CASSETTE.</b>		There is no video cassette in the camcorder. Insert a cassette (see <b>page 12</b> ).
<b>EJECT THE CASSETTE.</b>	<b>EJECT THE CASSETTE.</b>	The video cassette is defective and should be removed (see <b>page 12</b> ).
<b>CASSETTE NOT RECORDABLE.</b>		The erasure protect tab on the video cassette has been slid to the record-protect position, preventing recording (see <b>page 87</b> ).
<b>THE TAPE ENDS SOON.</b>		The tape is about to end. Prepare a new cassette (see <b>page 12</b> ).
<b>CHANGE THE CASSETTE.</b>	<b>TAPE END</b>	The tape has reached the end. Replace it with a new cassette (see <b>page 12</b> ).
<b>BATTERY IS TOO LOW.</b>		The battery is almost depleted. Replace it with a fully charged battery pack (see <b>page 10</b> ).
<b>DEW</b>		Dew has formed inside the camcorder. Wait a few hours for the dew to dry away (see <b>page viii</b> ). About 10 seconds after this warning appears, the camcorder automatically turns off.
		The video heads are clogged and should be cleaned (see <b>page ix</b> ).
<b>LAMP</b>	<b>LAMP</b>	The fluorescent lamp behind the LCD monitor is close to the end of its service life. Call your local authorized Sharp dealer to have it replaced.
		When the setting screen of a manual function displays, all warnings will be indicated by  in the centre of the LCD screen. To check the type of warning, complete the manual setting and return to normal screen.

Displayed for 5 seconds	Description of warning
<b>NO MEMORY CARD</b>	The card is not inserted or is inserted improperly. Check that it is properly inserted (see <b>page 13</b> ).
<b>MEMORY CARD FULL</b>	The capacity of the card is full and cannot store any more images. Delete unnecessary images (see <b>page 73</b> ) or replace the card with a new one (see <b>page 13</b> ).
<b>NO DATA ON MEMORY CARD</b>	The card has no images recorded in the format the camcorder can recognize.
<b>MEMORY CARD ERROR</b>	The images in the card are corrupted or recorded in a format which is not compatible with this camcorder. Format the card to use it with this camcorder (see <b>page 70</b> ).
<b>FORMAT MEMORY CARD</b>	The card has not been formatted with this camcorder. Format the card (see <b>page 70</b> ).
<b>MEMORY CARD PROTECTED</b>	The card is write-protected (see <b>page 89</b> ).
<b>DATA PROTECTED</b>	You are trying to delete a protected image. Cancel the protection setting (see <b>page 72</b> ).
<b>MEMORY CARD READ ERROR</b>	The selected image cannot be read by this camcorder. Format the card to use it with this camcorder (see <b>page 70</b> ).
<b>CANNOT STORE DATA</b>	The card cannot record any data due to a problem with the card or data on the card. Replace the card (see <b>page 13</b> ).

**Note:**

-  indicates a flashing display.

# Preparation

## Charging the Battery Pack

Charge the battery pack with the supplied AC adapter/battery charger before use.

Preparation

### Note:

- Remove the DC cable from the AC adapter/battery charger when charging the battery pack.

- Connect the supplied power cord to the AC power socket on the AC adapter/battery charger, and insert the AC plug into a power outlet.
  - The POWER indicator lights up.

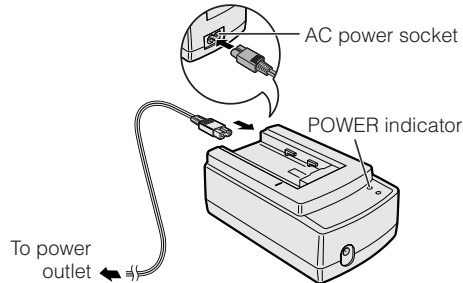

- Align the mark on the battery pack with the mark on the charger (1) and guide the battery into the groove. Pressing the battery (2), slide it in the direction of the arrow (3) until it locks into place.
  - The CHARGE indicator lights up.

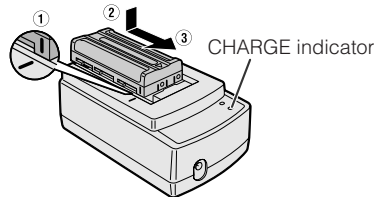

- The CHARGE indicator turns off when the battery is charged.

- Slide the battery pack in the direction of the arrow (1), and remove it (2). Then remove the AC plug of the power cord from the power outlet.

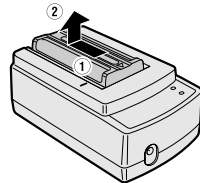

GB 9

## Charging time and maximum continuous recording and playback times in TAPE modes

Battery pack	Charging time	Max. continuous recording time	Max. continuous playback time
BT-L225	approx. 1hr. 20min.	approx. 1hr. 30min.	approx. 1hr. 30min.
BT-L445	approx. 2hr. 20min.	approx. 3hr.	approx. 3hr.

### Notes:

- Charge the battery pack between 10°C and 30°C. The battery pack may not charge properly at temperatures too low or too high.
- The battery pack and charger become warm during charging. This is not a malfunction.
- Using the zoom (see page 21) and other functions or turning the power on and off frequently will increase power consumption. This may result in a decrease in the actual recording time compared to the maximum continuous recording time listed above.
- The charging time and recording time may vary depending on the ambient temperature and the condition of the battery pack.
- The maximum recording and playback time will increase somewhat when you leave the battery on the charger for 1 hour extra after the CHARGE indicator turns off.
- See page 90 for more information on using the battery pack.

### Caution:



- Charge only SHARP model BT-L225 or BT-L445 battery packs. Other types of battery packs may burst, causing personal injury and damage.

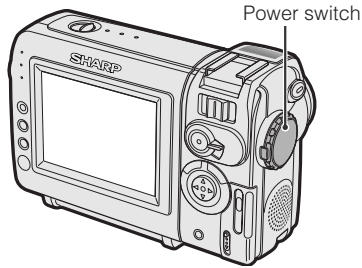

## Attaching and Removing the Battery Pack



### Attaching the Battery Pack

- 1 Make sure that the Power switch is set to OFF.
- 
- The image shows a circular power switch with 'POWER' at the top, 'OFF' in the center, and 'ON' at the bottom. A small arrow points to the 'OFF' position.
- 2 Align the  mark on the side of the battery pack with the  mark on the camcorder (1), and slide the battery pack in the direction of the arrow completely until it locks into place (2).

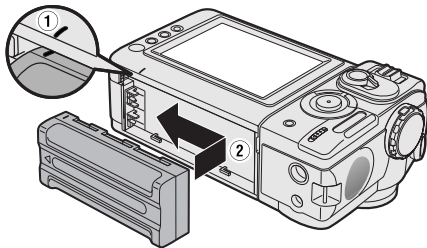

### Removing the Battery Pack

- 1 Make sure that the Power switch is set to OFF.
- 2 Rotate the monitor section of the camcorder (1), then press the power source release (2). Slide the battery pack in the direction of the arrow and take it out (3).

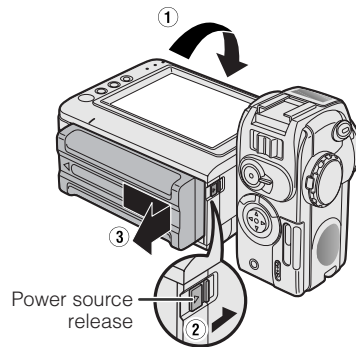

#### Cautions:

- **BEFORE REMOVING THE BATTERY PACK, ALWAYS STOP RECORDING OR PLAYBACK AND TURN THE POWER OFF.** Removing the battery pack while shooting or during playback may damage the tape by causing it to wrap around the video head drum or destroy the card, rendering it unreadable and unwritable.
- Remove the battery pack from the camcorder if you will not use the camcorder for a long period of time.
- Make sure that the battery pack is firmly attached during operation. If it is not, the battery pack may come off or camcorder operation may fall because of the poor contact pressure.
- To prevent damage to the battery pack when removing, be sure to firmly hold the battery pack while pressing the release.
- Use only SHARP model BT-L225 or BT-L445 battery packs with this camcorder. Use of other batteries may create a risk of fire or explosion.

## Preparation

### Powering the Camcorder from an AC Outlet

You can also power the camcorder from a power outlet by using the supplied AC adapter/battery charger and DC cable.

#### Caution:

- The supplied AC adapter/battery charger is specially designed for use with this camcorder, and should not be used as a power supply for other camcorders.

- 1 Make sure that the Power switch is set to OFF.
- 2 Align the notch on the side of the DC cable connecting plate with the  mark on the camcorder (①), and slide the connecting plate in the direction of the arrow completely until it locks into place (②).

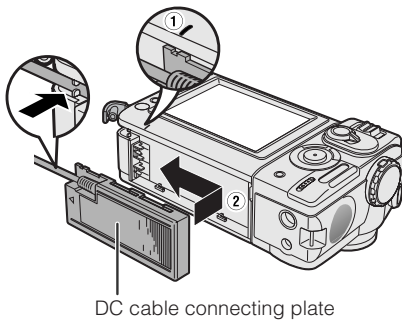

- 3 Insert the DC cable plug into the DC OUT jack on the AC adapter. Connect the supplied power cord to the AC adapter, and insert the AC plug into a power outlet.
  - The POWER indicator on the AC adapter lights up, and the camcorder is supplied power.

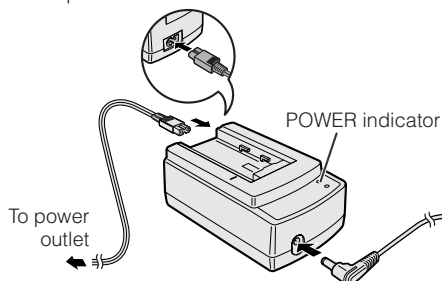

#### Note:

- When using the AC adapter/battery charger to power the camcorder, it cannot be used to charge the battery pack.

### Removing the DC cable from the camcorder

Make sure that the Power switch is set to OFF. Rotate the monitor section of the camcorder (①), then press the power source release (②). Slide the battery pack in the direction of the arrow and take it out (③).

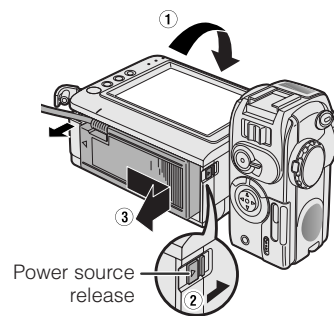

#### Cautions:

- **BEFORE REMOVING THE DC CABLE, ALWAYS STOP RECORDING OR PLAYBACK AND TURN THE POWER OFF.** Removing the DC cable while shooting or during playback may damage the tape by causing it to wrap around the video head drum or destroy the card, rendering it unreadable and unwritable.
- Disconnect the camcorder from the AC adapter if you will not use the camcorder for a long period of time.
- The supplied DC cable is designed for use only with the supplied AC adapter/battery charger. Do not use it with the other equipment, as this may damage the cable or the equipment.

## Inserting and Removing a Cassette

### Inserting a Cassette

- 1 Attach the power source to the camcorder, then slide the cassette compartment door release and open the cassette compartment door.
  - After confirmation sound, the cassette holder extends and opens automatically.

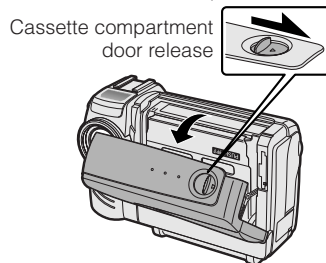

- 2 Insert a commercially available cassette fully with the window facing outwards, and with the erasure protect tab facing upwards.

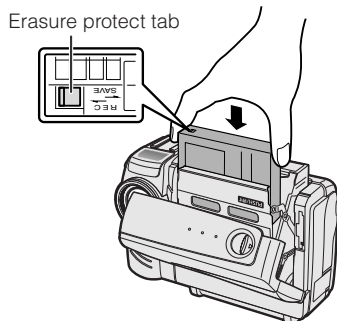

- 3 Press the **PUSH/押し** mark gently until the cassette holder clicks into place.
  - After confirmation sound, the cassette holder retracts automatically.

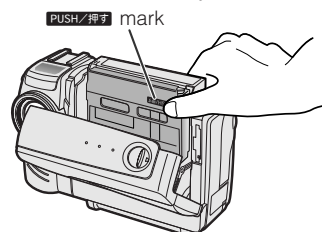

- 4 Wait for the cassette holder to fully retract. Close the compartment door by pressing the centre until it clicks into place.

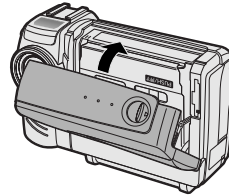

### Removing a Cassette

Perform step 1 above, then take out the cassette.

#### Cautions:

- Do not try to close the cassette compartment door while the cassette holder is extending or retracting.
- Be careful not to get your fingers caught in the cassette holder.
- Do not apply force to the cassette holder except when pressing the **PUSH/押し** mark to close it.
- Do not tilt the camcorder or hold it upside down when you are inserting or removing a cassette. It may damage the tape.
- Remove the cassette if you will not use the camcorder for a long period of time.
- If you do not correctly close the cassette holder in step 3, the cassette protection mechanism of the camcorder might eject the cassette. If this happens, repeat the insertion procedure.
- Do not attempt to pick up the camcorder by the cassette compartment door.

#### Notes:

- If the battery power is too low, you may not be able to eject the cassette. Replace the battery pack with a fully charged one.
- See page 87 for more information on the video cassette tapes intended for use with this camcorder.

## Preparation

### Inserting and Removing a Card

You can use an SD Memory Card (commercially available) or a MultiMediaCard (only supplied with VL-NZ10) for storing still images.

Preparation

#### Inserting a Card

- 1 Make sure that the Power switch is set to OFF.

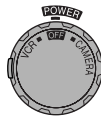

- 2 Slide the card slot cover release and open the card slot cover in the direction of the arrow.

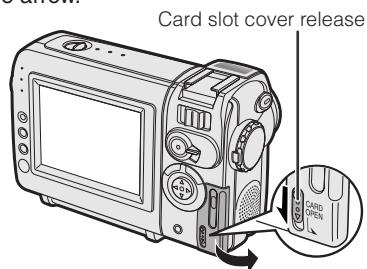

- 3 Insert a card into the slot as shown below, and push it in as far as it will go.

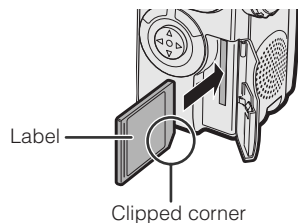

- 4 Close the card slot cover.

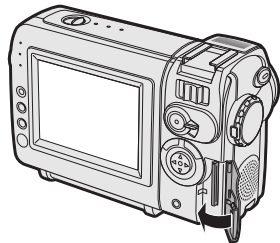

#### Removing a Card

Perform steps 1 and 2 above, push the card (①) and pull the card straight out (②) as shown below.

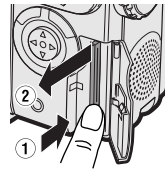

#### Notes:

- You can use only the SD Memory Card or the MultiMediaCard (see page 86).
- The MultiMediaCard supplied with VL-NZ10 is preformatted for immediate use.
- See pages 88 and 89 for more information on the cards intended for use with this camcorder.

#### Caution:

- Do not remove the card from the camcorder while recording data on the card (⏏ indicator flashes during recording). This may delete the recorded image or damage the card.

## Installing the Lithium Batteries

### Installing the Memory Battery

A lithium battery is used to store the memory of the date and time settings.

- 1 Slide the cassette compartment door release and open the cassette compartment door.

**Note:**

- The cassette holder will extend and open when the camcorder is connected to a power source. Be sure to close the cassette holder before proceeding to the next step (see page 12).

- 2 Pull out the lithium battery holder using a pointed object such as the tip of a ballpoint pen.

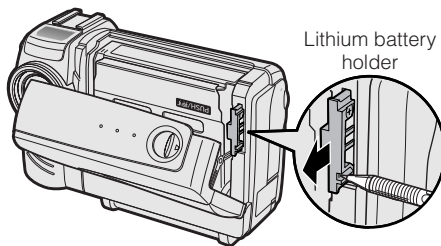

- 3 Insert the lithium battery into the battery holder with the + side of the battery facing the ⊕ side of the holder.

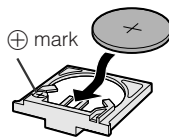

- 4 Push the battery holder back into position. Press the **PUSH/押す** mark gently, then close the cassette compartment door by pressing the centre until it clicks into place.

### Removing the lithium battery

Perform steps 1 and 2 above, then lift out the battery from the battery holder.

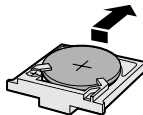

### Installing the Battery to Remote Control (Only supplied with VL-NZ10)

A lithium battery is used to power the remote control unit.

- 1 Hold the remote control facing down, and pull out the battery holder while pressing the tab toward the centre.



- 2 Insert the lithium battery into the battery holder with the + side of the battery facing the ⊕ side of the holder.

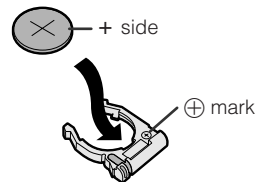

- 3 Insert the battery holder back into position.

### Notes on the Use of the Lithium battery

**CAUTION:** Danger of explosion if battery is incorrectly replaced. Replace only with the same or equivalent type CR2025 recommended by the equipment manufacturer.  
**WARNING:** KEEP THIS BATTERY AWAY FROM CHILDREN. IF SWALLOWED, CONSULT A PHYSICIAN IMMEDIATELY FOR EMERGENCY TREATMENT.  
**CAUTION:** BATTERY MAY EXPLODE IF MIS-USED OR INSTALLED WITH POLARITY REVERSED. DO NOT RECHARGE, DISASSEMBLE OR DISPOSE OF IN FIRE.

- Do not short-circuit, recharge, disassemble, or heat the lithium battery.
- Should the lithium battery leak, wipe the battery compartment clean, and then insert a new battery.
- The lithium battery will last about one year under normal usage.

Preparation

## Preparation

### Selecting the Language for the On-screen Display

#### Available modes:

TAPE-CAMERA, CARD-CAMERA

Preparation

This camcorder allows you to choose English, German or French as the on-screen display language.

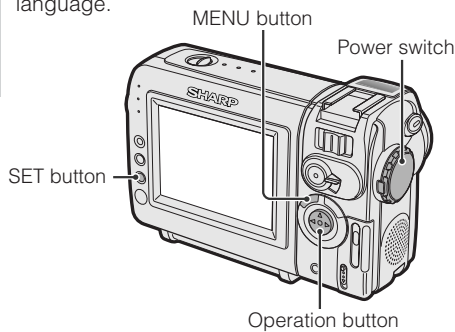

#### Setting the Language

When using the camcorder for the first time, select your on-screen display language by following the steps below.

- 1 Hold down the Lock button and set the Power switch to CAMERA.

- The language selection screen appears.

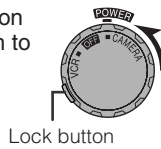

Lock button

- 2 Press  $\nabla$  or  $\Delta$  on the operation button to select the desired language, then press the SET button.

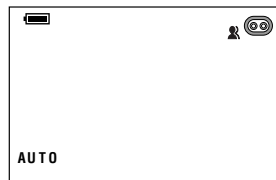

### Changing the Language

- 1 In TAPE-CAMERA or CARD-CAMERA mode, press the MENU button until the menu screen appears.
- 2 Press  $\nabla$  or  $\Delta$  on the operation button to select ETC, then press the SET button.
- 3 Press  $\nabla$  or  $\Delta$  to select "LANGUAGE" ("SPRACHE" or "LANGUE"), then press the SET button.
  - The language selection screen appears.

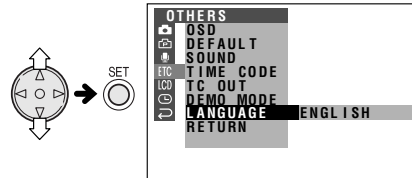

- 4 Press  $\nabla$  or  $\Delta$  to select the desired language, then press the SET button.
  - The menu screen displays in the language selected.

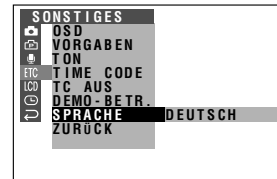
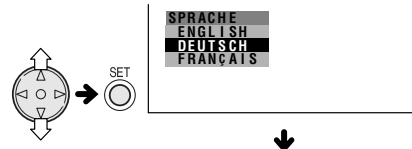

- 5 Press the MENU button to turn off the menu screen.

#### Note:

- The English, German and French portions of this operation manual are based on the use of on-screen displays in their respective languages. The portions of this manual in other languages, however, are based on the use of English on-screen displays.

## Setting the Area, Date and Time

### Available modes:

TAPE-CAMERA, CARD-CAMERA

**Example:** Setting the date to 2 June 2002 (2. 6. 2002) and the time to 10:30 am (10:30) in Paris.

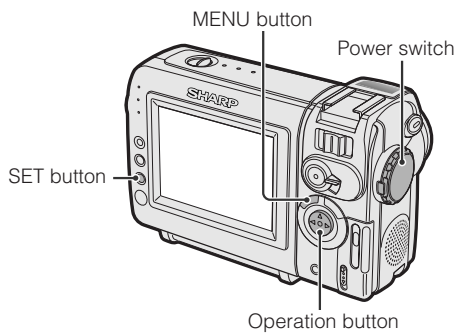

### Notes:

- Before performing the steps below, make sure that the lithium battery has been installed (see page 14).
- If you are in an area that observes summer time, set the time to the standard time. You can then correct it for summer time by performing the steps on page 83.

- 1** Hold down the Lock button and set the Power switch to CAMERA.

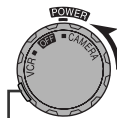

Lock button

- 2** Press the MENU button until the menu screen appears.

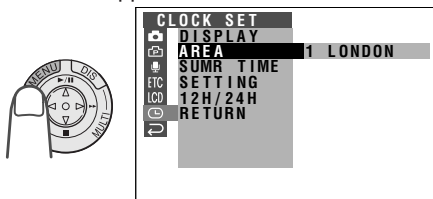

- 3** Press the SET button.



- 4** Press  $\nabla$  or  $\Delta$  until "2 PARIS" appears, then press the SET button.

AREA 2 PARIS

### Note:

- See "Time Zone Chart" and "Area Table" on pages 81 and 82 for the area number and name of the representative city for your time zone.

- 5** Press  $\nabla$  or  $\Delta$  to select "SETTING", then press the SET button.

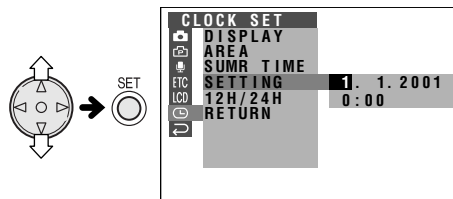

- 6** Press  $\nabla$  or  $\Delta$  to select "2" (day), then press the SET button.

SETTING 2. 1. 2001  
0:00

- 7** Press  $\nabla$  or  $\Delta$  to select "6" (month), then press the SET button.

SETTING 2. 6. 2001  
0:00

- 8** Press  $\nabla$  or  $\Delta$  to select "2002" (year), then press the SET button.

SETTING 2. 6. 2002  
0:00

- 9** Press  $\nabla$  or  $\Delta$  to select "10" (hour), then press the SET button.

SETTING 2. 6. 2002  
10:00

- 10** Press  $\nabla$  or  $\Delta$  to select "30" (minute), then press the SET button.

SETTING 2. 6. 2002  
10:30

- 11** Press the MENU button to turn off the menu screen.

### Note:

- If the date and time have been set, the MANUAL SET screen (CAMERA) appears in step 2. Select "AREA" in the CLOCK SET screen (CAMERA) using the Operation button and SET button.

## Preparation

### Changing to the 12-hour Time Mode

- 1 After performing step 10 above, press  $\nabla$  or  $\Delta$  to select "12H/24H", then press the SET button.

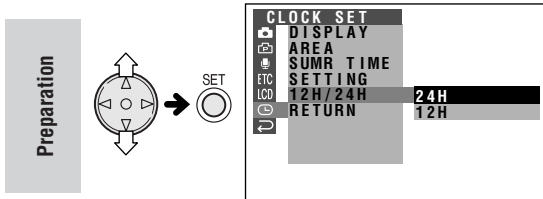

- 2 Press  $\nabla$  or  $\Delta$  to select "12H", then press the SET button.  
**12H/24H 12H**
- 3 Press the MENU button to turn off the menu screen.

#### Notes:

- The date and time, once set, are internally recorded even when not displayed on the screen.
- The menu screen automatically turns off if no settings are made within five minutes.

### Attaching the Lens Hood

When recording outdoors on a sunny day or in a location with bright lighting, attach the supplied lens hood to the camcorder. Turn the lens hood in the direction of the arrow to attach it.

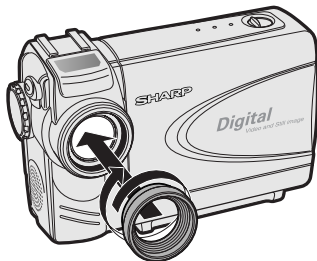

To remove it, turn it in the opposite direction.

#### Notes:

- The lens cap can still be attached on top of the lens hood.
- Filters and other accessories cannot be attached on the top of the lens hood.

### Attaching the Straps

Attach the hand strap or the shoulder strap to the strap loop as shown below.

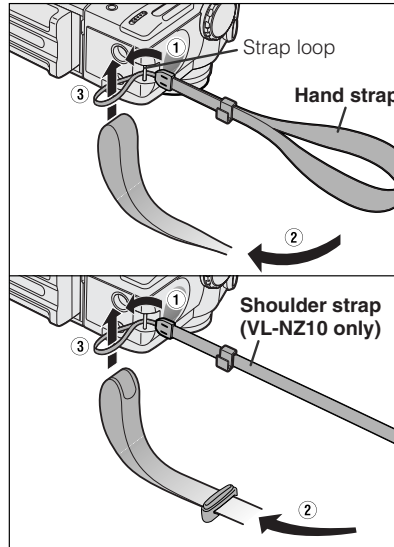

### When using the shoulder strap (Only supplied with VL-NZ10)

Adjust the length of its loop as shown below, to fit it on your shoulder.

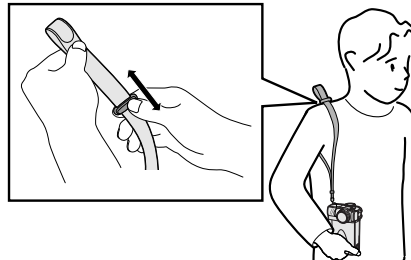

#### Cautions:

- Do not swing the camcorder by the strap.
- To avoid accident, make sure the shoulder strap does not get caught in other objects or wrapped around the neck. And pay close attention to the following:
  - Do not use the shoulder strap when riding on bicycle or motor cycle.
  - Do not allow children to be mischievous with the shoulder strap.
  - Keep a firm hold of the camcorder to prevent it from swinging and hitting others.



## Using the Lens Cap

Attach the strap of the lens cap to the hand strap or shoulder strap as shown below.

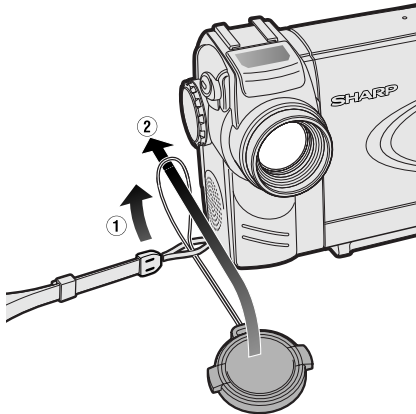

When attaching or removing the lens cap, press both tabs on the top and bottom of the cap.

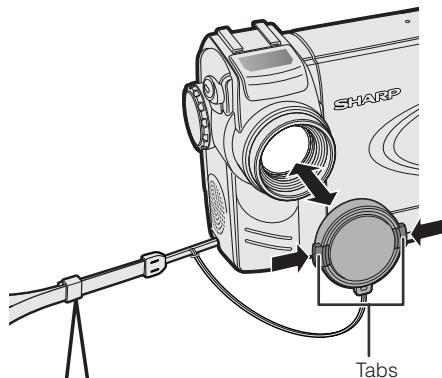

When recording, hang the hook of the lens cap on the hand strap or shoulder strap to keep the cap out of the way.

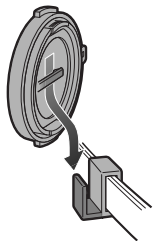

### Note:

- Always attach the lens cap over the lens when not using the camcorder.

## Tips on Recording Positions

To create images that are easy to watch during playback, try to record with an upright posture and steady hand to prevent a shaky image.

### Holding the camcorder

Place your right thumb close to the REC START/STOP button and Power Zoom control. Place your left thumb on the thumb rest on the left side of the screen.

### Basic posture

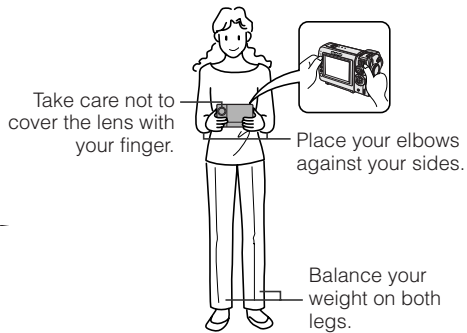

### Shooting from a high angle

Turn the LCD monitor so that the screen faces downward.



### Shooting from a low angle



Turn the LCD monitor so that the screen faces upward.

### Note:

- Take care not to touch the microphone with your fingers during recording. It will cause noise on the audio track.

# Basic Operations

## Camera Recording

### Selecting the Camcorder Mode

This camcorder includes functions for use as both a video camera for recording and playing back images on tapes and as a digital still camera for recording and playing back still images on cards. One of the following camcorder modes needs to be set before starting any operation.

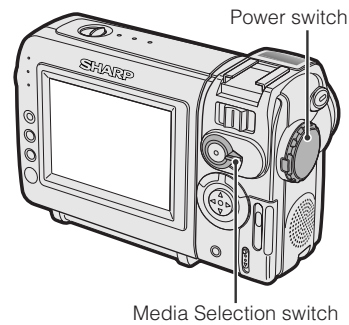

Basic Operations

### Camcorder modes

#### TAPE-CAMERA mode

For recording motion and still images on tapes.

- 1 Set the Media Selection switch to TAPE.

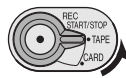

- 2 Hold down the Lock button and set the Power switch to CAMERA.

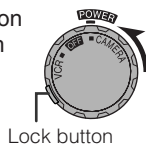

#### TAPE-VCR mode

For playing back or editing motion and still images recorded on tapes.

- 1 Set the Media Selection switch to TAPE.

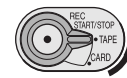

- 2 Hold down the Lock button and set the Power switch to VCR.

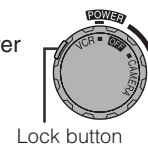

#### CARD-CAMERA mode

For recording still images on cards.

- 1 Set the Media Selection switch to CARD.



- 2 Hold down the Lock button and set the Power switch to CAMERA.

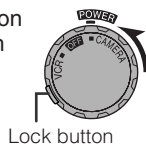

#### CARD-VCR mode

For playing back still images recorded on cards.

- 1 Set the Media Selection switch to CARD.



- 2 Hold down the Lock button and set the Power switch to VCR.

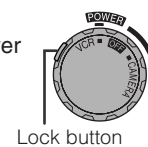

#### Note:

- To turn the power off, set the Power switch to OFF without pressing the Lock button.

#### Caution:

- Do not change the camcorder mode by operating the Media Selection switch during recording or playback, as this may cause damage to the tape or card.

## Easy Camera Recording on Tape in Full Auto Mode

**Available mode:**  
TAPE-CAMERA

- Before you start recording, perform the operations described on pages 9 through 18 to prepare your camcorder for recording.

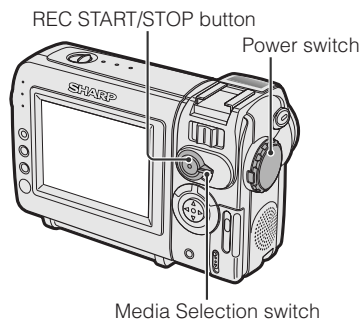

- 1 Remove the lens cap.
- 2 Set the Media Selection switch to TAPE.
- 3 Hold down the Lock button and set the Power switch to CAMERA.
  - The picture from the lens is now displayed on the screen.
  - The camcorder is now ready to record (Recording Standby mode).

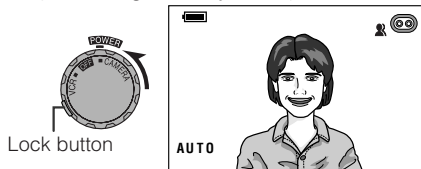

- Note:**
- If "AUTO" is not displayed at this time, set the camcorder to Full Auto mode (see page 54).

- 4 Press the REC START/STOP button to begin recording.

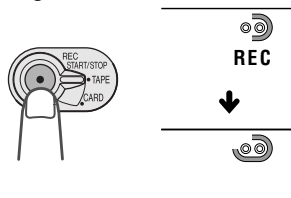

## To pause recording

Press the REC START/STOP button again. Recording pauses, and the camcorder enters Recording Standby mode.

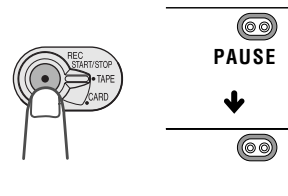

## To turn the power off

Set the Power switch to OFF without pressing the Lock button.

### Notes:

- Battery power is consumed in Recording Standby mode. Turn off the power if you will not be recording again soon.
- If the camcorder remains in Recording Standby mode for more than 5 minutes in TAPE-CAMERA mode, the power will automatically turn off to save battery power and to protect the tape from being damaged. To resume recording, set the Power switch to OFF and then back to CAMERA. (The camcorder will make a confirmation sound when it is left in Recording Standby mode for about 4 minutes.)

## Maximum continuous recording and actual recording times in TAPE-CAMERA mode

Battery pack	Max. continuous recording time	Actual recording time
BT-L225	approx. 1hr. 30min.	approx. 50min.
BT-L445	approx. 3hr.	approx. 1hr. 40min.

### Note:

- Using the zoom (see page 21) and other functions or turning the power on and off frequently will increase power consumption. This may result in a decrease in the actual recording time compared to the maximum continuous recording time listed above.

## Basic Operations Camera Recording

### Zooming

#### Available modes:

TAPE-CAMERA, CARD-CAMERA

Zooming allows you to move visually closer to or farther from a subject without physically changing your position.

When using the optical zoom, you can enlarge the subject up to 10×.

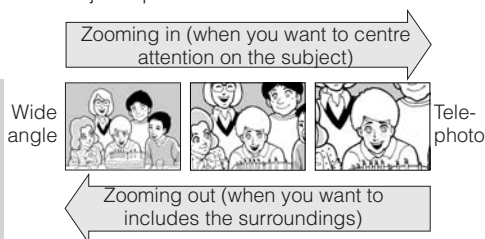

Basic Operations

#### Zooming in

Push the Power Zoom control to the T (tele-photo) side to get a close-up view (①).

#### Zooming out

Push the Power Zoom control to the W (wide angle) side to get a wide field of view (②).

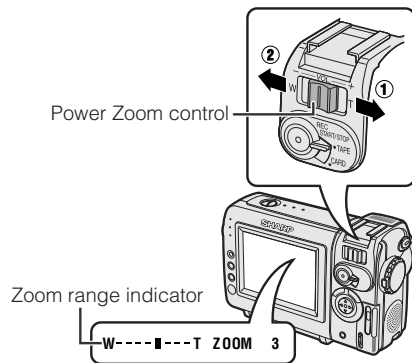

- The zoom range indicator shows you the current zoom setting.
- The zoom speed depends on how far you push the Power Zoom control.

#### Notes:

- The camcorder is unable to focus when zooming in on subjects within 1.5 m. The camcorder will automatically zoom out until it is able to focus on the subject.
- See page 28 for how to use the digital zoom.

### Auto Focus

#### Available modes:

TAPE-CAMERA, CARD-CAMERA

The camcorder is preset to Auto Focus mode, which is designed to focus on most types of subjects. In Auto Focus mode, the camcorder automatically focuses on the subject in the centre of the scene. Always keep the subject in the centre of the scene.

#### Notes:

- If no subject is in the centre of the scene, the focus area will expand and the subject nearest the centre will be focused on.
- If no subject is displayed, the camcorder will automatically zoom out until a subject comes into the frame.
- Auto Focus may not work in the situations described on page 53. In these situations, use the manual focus function.

### Macro Shots

#### Available modes:

TAPE-CAMERA, CARD-CAMERA

This camcorder lets you shoot close-up images of small objects such as flowers and insects, or make title frames for your videos. When you want to record a magnified image of a subject which is within approximately 1.5 m of the camcorder, do not zoom in on it. Instead, zoom out all the way by pushing the Power Zoom control to the W side, and then move the camcorder closer to the subject until you obtain the desired angle of view. The camcorder will automatically focus on the subject when the lens is set for the widest angle.

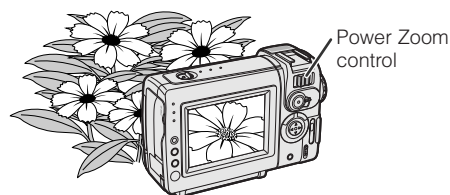

#### Notes:

- When you are recording a macro shot, be sure that the subject receives sufficient illumination.
- It is recommended that you use a tripod for recording macro shots, to prevent image shaking. (See page 41 to use the camcorder with a tripod.)

## Remaining Recording Time Display

**Available mode:**  
TAPE-CAMERA

When the camcorder is recording in TAPE-CAMERA mode, an on-screen indicator displays the approximate remaining tape time in minutes.

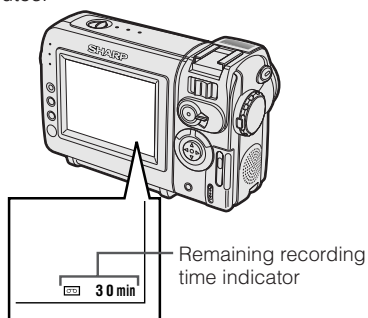

**Notes:**

- The remaining recording time indicator appears when the OSD menu item is set to "ON".
- The remaining recording time indicator appears 10 seconds after pressing the REC START/STOP button to begin recording.
- The remaining recording time indicator only shows the approximate time left. Also, it varies slightly depending on the length of tape used. (This function is based on the DVM60 tape standard.)

When the remaining recording time reaches 1 minute, a warning indicator will appear. Prepare a new cassette.

Warning indicator	Approx. remaining time
<p>THE TAPE ENDS SOON.</p> <p>↓</p> <p>-TAPE END-</p>	Less than 1 min.
<p>CHANGE THE CASSETTE.</p> <p>↓</p> <p>TAPE END</p>	The tape has reached the end.

## Remaining Battery Power Display

**Available modes:**  
All modes

When using the camcorder with the battery pack as the power source, the remaining battery power indicator is displayed. If the battery power becomes very low, a warning indicator appears. Replace the battery pack.

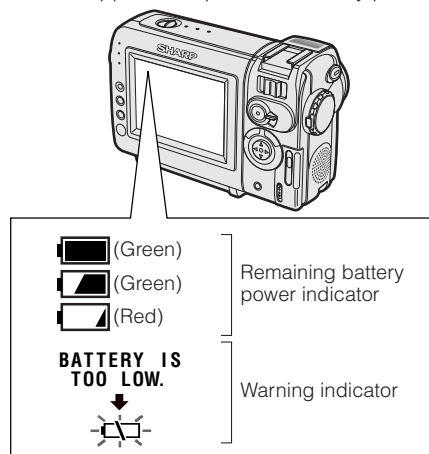

**Notes:**

- The remaining battery power indicator appears when the OSD menu item is set to "ON".
- Use the remaining battery power indicator only as an approximate indication.
- The remaining battery power indicator may change to either a higher or lower level if you set the Power switch to OFF and then back to CAMERA or VCR.
- In cold environments, the red remaining battery power indicator may appear sooner. The battery pack, however, can be used until the warning indicator appears.
- Use of the zoom functions when the warning indicator is displayed may cause the camcorder to suddenly lose power.

# Basic Operations

## Playback

### Tape Playback

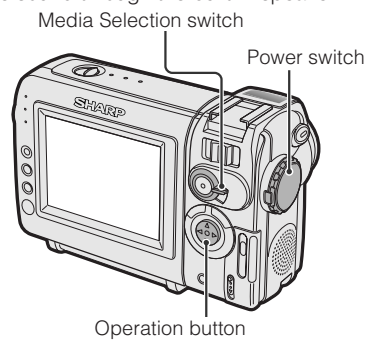

**Available mode:**  
TAPE-VCR

The LCD monitor screen functions as a handy playback monitor. Nothing needs to be connected, allowing instant on-screen playback with the sound through the built-in speaker.

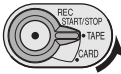
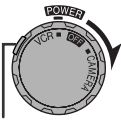
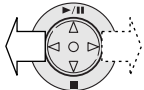
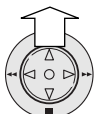

- 1 Set the Media Selection switch to TAPE. 
- 2 Hold down the Lock button and set the Power switch to VCR.   
Lock button
- 3 Press ◀ (or ▶) on the Operation button to rewind (or fast forward) the tape to the desired point. 
- 4 Press ▲ to begin playback. 

**Note:**

- If you press the REC START/STOP button in TAPE-VCR mode, the  mark appears and the camcorder enters Recording Standby mode. If you do not intend to record, press ▼ to turn the  mark off, then press ▲ to begin playback. This will ensure your previous recording is not erased (VL-NZ10 only, see page 61).

### To stop playback

Press ▼.

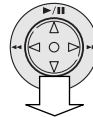

### To turn the power off

Set the Power switch to OFF without pressing the Lock button.

**Note:**

- The tape is automatically rewound when playback reaches the end of the tape.

### Using Earphones (Commercially available)

**Available modes:**  
TAPE-VCR, TAPE-CAMERA

You can monitor the sound via stereo earphones (commercially available) during playback or recording. Stereo earphones with a 3.5 mm diameter plug can be used with this camcorder by using the supplied earphones connecting cable.

Connect the plug of stereo earphones to the PHONES jack on the camcorder as shown below.

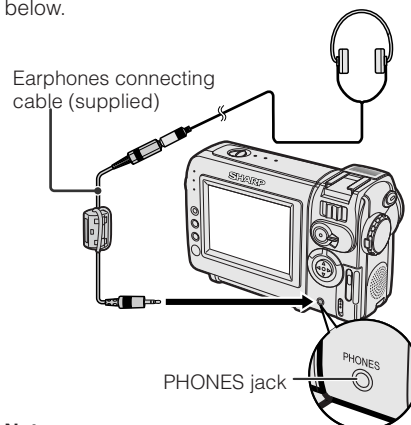

**Notes:**

- Before connecting stereo earphones, turn the camcorder volume down to the lowest setting.
- The built-in speaker automatically turns off when stereo earphones are connected to the PHONES jack.

## Volume Control

**Available mode:**  
TAPE-VCR

When the camcorder is in TAPE-VCR mode, push the Volume control to the + or - side to increase (①) or decrease (②) the volume.

The volume level indicator will appear on the LCD screen during adjustment only. Once the Volume control is released, the volume level indicator will disappear shortly afterwards.

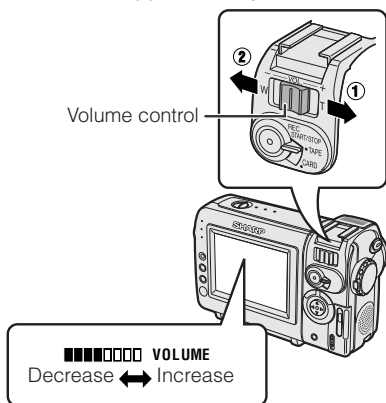

## Still

**Available mode:**  
TAPE-VCR

The still function allows you to pause playback in TAPE-VCR mode.

During playback in TAPE-VCR mode, press  $\Delta$  on the Operation button.

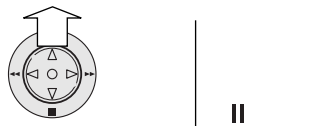

To return to normal playback, press  $\Delta$  again.

### Notes:

- The sound is off in Still mode.
- To protect the tape, the camcorder automatically returns to normal playback if it is left in Still mode for more than 5 minutes.

## Video Search

**Available mode:**  
TAPE-VCR

The video search function makes it easy to search for a desired scene on the tape.

### Searching for a Scene Near the Current Tape Position

- 1 During playback in TAPE-VCR mode, press  $\triangleright$  (or  $\triangleleft$ ) on the Operation button.
  - The playback picture fast forwards (or reverses).

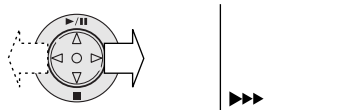

- 2 When you find the scene, press  $\Delta$  to return to normal playback.

### Searching for a Scene Far from the Current Tape Position

- 1 During fast forward (or rewind) in TAPE-VCR mode, press and hold  $\triangleright$  (or  $\triangleleft$ ) on the Operation button.
  - The fast forward (or rewind) picture displays.
- 2 If the scene is still rather far from the current tape position, release the Operation button to normal fast forward (or rewind).
- 3 Repeat steps 1 and 2 above until you find the scene.
- 4 Press  $\Delta$  to begin normal playback.

### Notes:

- The sound is off during search.
- You may experience picture noise during search. This is not a malfunction.

## Basic Operations Playback

### Watching Playback on a TV

#### Available modes:

TAPE-VCR, CARD-VCR

You can connect the camcorder to a TV to allow a larger audience to enjoy playback.

- 1 Open the jack cover on the camcorder (see page 2).

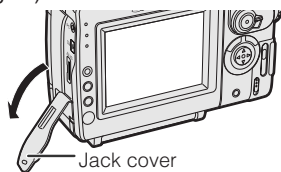

- 2 Connect the camcorder to your TV (or VCR) with the supplied audio/video/S-video cable, as shown.

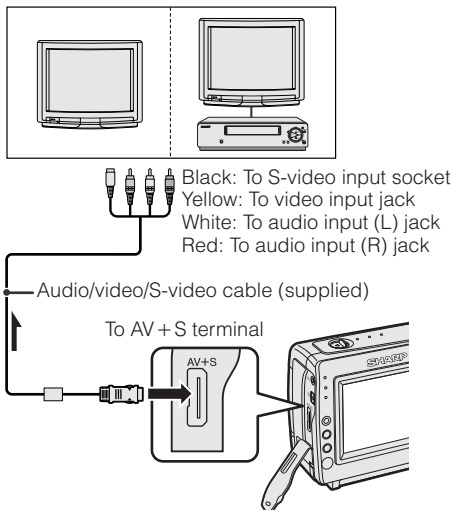

←: The arrow shows the signal flow.

#### Caution:

- Check that the camcorder, TV, VCR and other equipment to be used are turned off before making any connections. Picture noise or malfunction may occur if any of the above is left on while making a connection.

#### About the S-video socket

S-video sockets are used to separately pass the chroma (colour) and luminance (brightness) components of video signals. They serve to improve the picture quality in both recording and playback.

- 3 Turn on the TV and set it to the "AV" or "VIDEO" channel. (See the operation manual of your TV.)
  - When connecting to a TV via a VCR, turn on the VCR and set it to the "AV" or "LINE" input channel. Operate the TV as you normally do to view the signal from the VCR. (See the operation manuals of your TV and VCR.)
- 4 Set the Power switch on the camcorder to VCR, and begin playback (see page 23).

#### Notes:

- If your TV or VCR has a 21-pin Euro-SCART connector, use the RCA/21-pin Euro-SCART conversion connector (QSOCZ0033TAZZ).

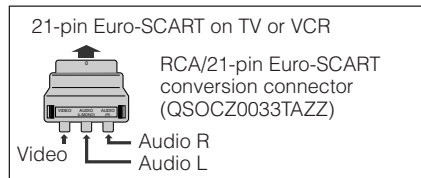

- If your TV or VCR has only one audio input jack, use the white plug for the audio connection on the TV or VCR.
- If your TV or VCR has an S-video input socket, you do not need to connect the yellow video plug.
- When the camcorder is connected to a TV for playback, the picture on the TV screen may flicker if the volume on the camcorder is set to maximum. Should this occur, turn the volume down (see page 24).
- Close the jack cover after use.

#### Removing the audio/video/S-video cable from the camcorder

Press the release tabs on the sides of the connector, then remove the plug from the terminal.

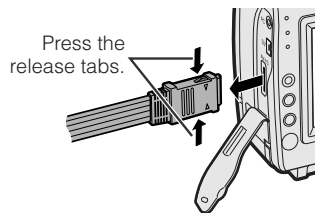

#### Caution:

- Do not forcibly remove the connector without pressing the release tabs. This may damage the cable or the camcorder.



# Useful Features

## Using the Menu Screens

Use the menu screens to adjust the various camcorder settings.

**Example:** Changing the DGTL ZOOM menu setting in TAPE-CAMERA mode.

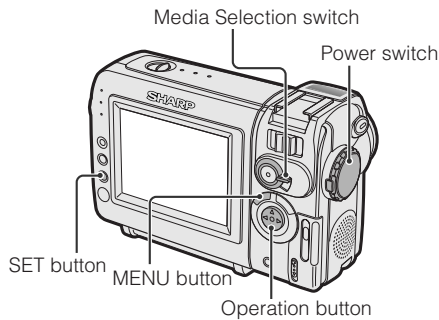

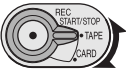
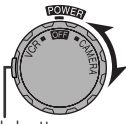
- 1 Set the Media Selection switch to TAPE or CARD. 
- 2 Hold down the Lock button and set the Power switch to CAMERA or VCR. 
- 3 Press the MENU button until the menu screen appears.

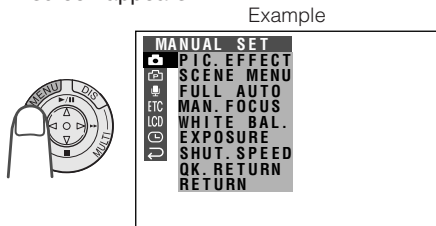

- 4 Press  $\nabla$  or  $\Delta$  on the Operation button to select the desired menu screen (CAMERA SET), then press the SET button.

Example

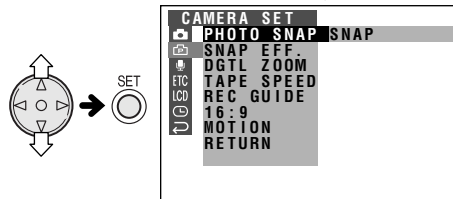

- You can press  $\triangleright$ , instead of the SET button.

- 5 Press  $\nabla$  or  $\Delta$  to select the desired menu item (DGTL ZOOM), then press the SET button.

Example

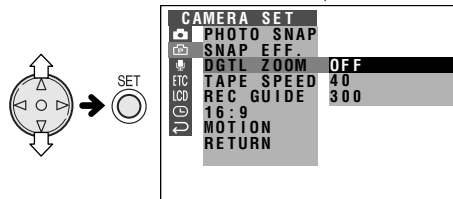

- You can press  $\triangleright$ , instead of the SET button.

- 6 Press  $\nabla$  or  $\Delta$  to select the desired menu setting, then press the SET button.

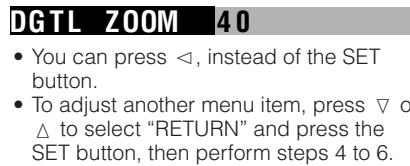

### To turn off the menu screen

Press the MENU button.

#### Notes:

- Certain menu items are common to all camcorder modes. If the SOUND menu item, for example, is set to "OFF" in TAPE-CAMERA mode, it will be automatically set to "OFF" in other modes.
- The menu screen automatically turns off if no settings are made within five minutes.
- Items that are not selectable are greyed out.

Useful Features

# Useful Features

## Camera Recording

### Displaying the Recording Guide

#### Available modes:

TAPE-CAMERA, CARD-CAMERA

This function helps you decide on the size of the subject occupying the screen. Select one of five recording guides.

#### Types of Recording Guides

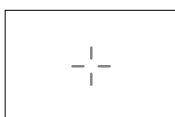

**Cross:** A cross mark at the centre of the screen for placing the subject at the centre.



**Focus:** Focus brackets for guiding you to the focus area.

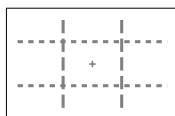

**Landscape:** Grid lines dividing the screen into 9 areas to help you with the horizontal and vertical composition.

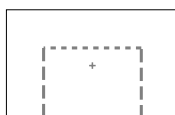

**Snapshot:** For capturing a small group of friends in a frame with surrounding background.

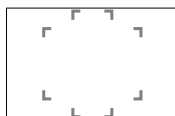

**Portrait:** Yellow frame fitting a full-body view and blue frame fitting an upper-body view.

### Turning on the recording guide

• The example screens shown are for TAPE-CAMERA mode.

- 1 In TAPE-CAMERA or CARD-CAMERA mode, press the MENU button until the menu screen appears.
- 2 Press  $\nabla$  or  $\Delta$  on the operation button to select , then press the SET button.
- 3 Press  $\nabla$  or  $\Delta$  to select "REC GUIDE", then press the SET button.

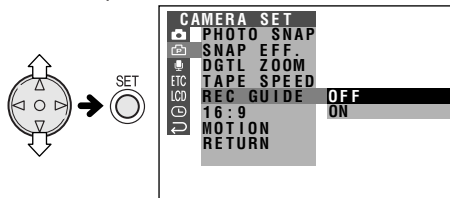

- 4 Press  $\nabla$  or  $\Delta$  to select "ON", then press the SET button.

**REC GUIDE ON**

- 5 Press the MENU button to turn off the menu screen.

### Selecting the recording guide

Press  $\nabla$  or  $\Delta$  on the Operation button.

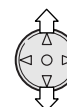

### To turn off the recording guide

Select "OFF" in step 4 above, then press the SET button.

#### Notes:

- When using manual focus, you cannot change the recording guide.
- The recording guide appears when the OSD menu item is set to "ON".

## Setting the Digital Zoom

### Available modes:

TAPE-CAMERA, CARD-CAMERA

You can select three different zoom ranges: 1–10× (optical zoom), 10–40× (digital zoom) or 10–300× (digital zoom). The digital zoom allows you to record powerful close-up pictures with the same operation as normal zooming.

### Notes:

- The digital zoom is in addition to the optical zoom giving a combined maximum zoom range of 1–300×.
- **As the image is enlarged digitally, the picture quality decreases when higher digital zoom settings are used.**

- 1 In TAPE-CAMERA or CARD-CAMERA mode, press the MENU button until the menu screen appears.
- 2 Press  $\nabla$  or  $\Delta$  on the operation button to select  $\square$ , then press the SET button.
- 3 Press  $\nabla$  or  $\Delta$  to select "DGTL ZOOM", then press the SET button.

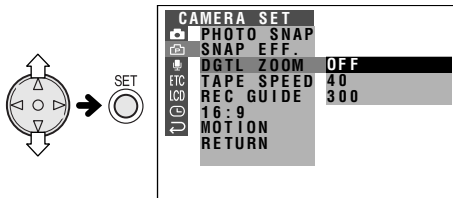

- 4 Press  $\nabla$  or  $\Delta$  to select "40" or "300", then press the SET button.

**DGTL ZOOM 40**

- 5 Press the MENU button to turn off the menu screen.

The "D" digital zoom indicator is displayed during digital zooming.

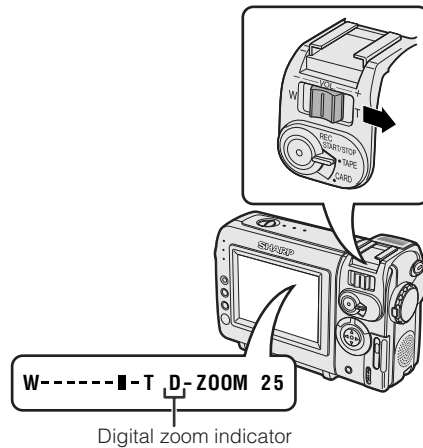

### To use optical zoom only

Select "OFF" in step 4 above.

## Useful features Camera Recording

### Using the Zoom Microphone (Only supplied with VL-NZ10)

**Available mode:**  
TAPE-CAMERA

With the zoom microphone, you can record audio according to the magnification of the zoom lens for producing the optimum sound. You can also set the zoom microphone to record only sounds at a distance.

#### Mounting the Zoom Microphone

- 1 Align the zoom microphone with the accessory shoe on the camcorder, and slide it in the direction of the arrow until it locks into place.

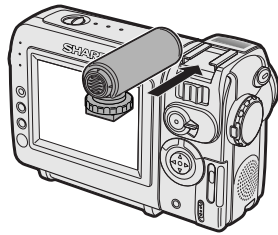

- 2 Turn the screw in the direction of the arrow to secure the microphone.

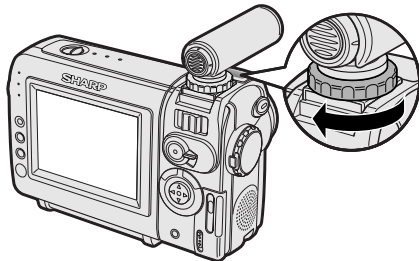

#### Removing the zoom microphone

Turn the screw in the opposite direction than when mounting, then pull off the zoom microphone.

#### Cautions:

- Do not pick up the camcorder by the zoom microphone, as this may damage the equipment.
- The accessory shoe on the camcorder is designed only for use with the zoom microphone supplied with VL-NZ10.

#### Selecting Zoom Microphone Mode

Select a Zoom Microphone mode when the zoom microphone is mounted.

##### Types of Zoom Microphone modes

**AUTO:** The camcorder automatically selects the optimum sound according to the magnification of the zoom lens. When the zoom lens is at a wide-angle setting, the built-in microphone is used to record sounds. As the zoom magnification increases, the sounds from the zoom microphone and built-in microphone are mixed according to the zoom setting.

**TELE:** The zoom microphone is fixed to record sounds at a distance. (The built-in microphone is turned off.)

**OFF:** The zoom microphone is turned off. (The built-in microphone is on.)

- 1 Mount the zoom microphone to the camcorder.
- 2 In TAPE-CAMERA mode, press the MENU button until the menu screen appears.
- 3 Press  $\nabla$  or  $\Delta$  on the operation button to select  $\text{MIC}$ , then press the SET button.
- 4 Press  $\nabla$  or  $\Delta$  to select "ZOOM MIC", then press the SET button.

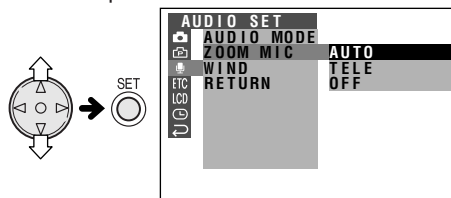

- 5 Press  $\nabla$  or  $\Delta$  to select the desired zoom microphone mode, then press the SET button.
  - The selected zoom microphone mode is displayed on the menu screen.

**ZOOM MIC**    **AUTO**

- 6 Press the MENU button to turn off the menu screen.

When the zoom microphone is active, the zoom range indicator changes as shown below.

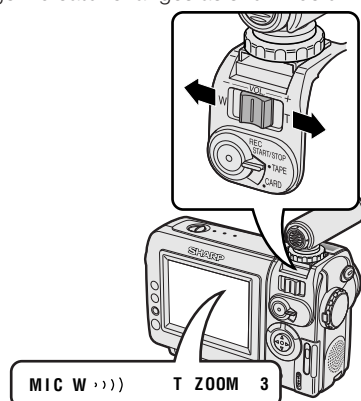

**Note:**

- When you set the ZOOM MIC menu item to "TELE", the zoom indicator always stays at the maximum point. Refer to the number to the right of "ZOOM" for the current magnification.

## Windbreak

**Available mode:**  
TAPE-CAMERA

The windbreak function allows you to reduce annoying noise from strong winds when recording.

- 1 In TAPE-CAMERA mode, press the MENU button until the menu screen appears.
- 2 Press  $\nabla$  or  $\Delta$  on the operation button to select  $\text{WIND}$ , then press the SET button.
- 3 Press  $\nabla$  or  $\Delta$  to select "WIND", then press the SET button.

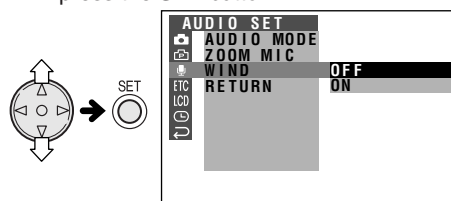

- 4 Press  $\nabla$  or  $\Delta$  to select "ON", then press the SET button.

**WIND**    **ON**

- 5 Press the MENU button to turn off the menu screen.

**To cancel Windbreak**

Select "OFF" in step 4 above.

**Note:**

- Keep the windbreak function off during normal recording. If left on, the recorded audio may sound somewhat muffled when played back.

## Useful features

### Camera Recording

#### Gamma Brightness Compensation

##### Available modes:

TAPE-CAMERA, CARD-CAMERA

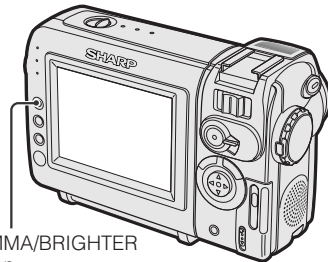

GAMMA/BRIGHTER button

When the subject is backlit, the image will appear dark if it is recorded normally. The gamma brightness compensation function improves the picture by increasing the brightness of the subject while leaving the brighter portion of the image unaffected.

In TAPE-CAMERA or CARD-CAMERA mode, press the GAMMA/BRIGHTER button once.

- "GAMMA" appears, indicating that Gamma Brightness Compensation is now working.

GAMMA / BRIGHTER

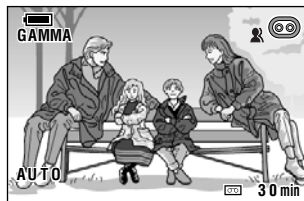

#### To obtain a brighter picture

Press the GAMMA/BRIGHTER button again.

- The  indicator appears.

GAMMA / BRIGHTER

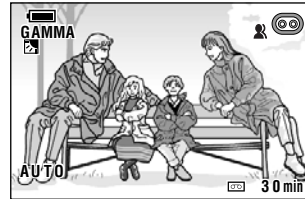

#### Note:

- When the  indicator is displayed, the background will become slightly brighter.

#### To cancel Gamma Brightness Compensation

Press the GAMMA/BRIGHTER button until "GAMMA" disappears.

## Gain-up

### Available modes:

TAPE-CAMERA, CARD-CAMERA

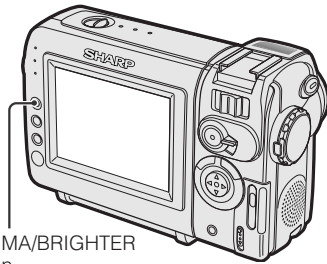

When you are recording in a dark or poorly illuminated location, "LIGHT" is displayed on the screen. Use the gain-up function to record a brighter picture.

### Note:

- At locations where lighting is adequate, "LIGHT" will not appear. The gain-up function cannot be used in this case.

In TAPE-CAMERA or CARD-CAMERA mode, press the GAMMA/BRIGHTER button once.

- "GAMMA" appears, indicating that the gain-up function is now working.

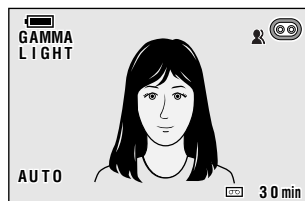
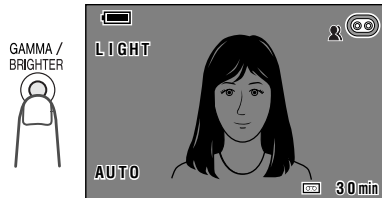

## To obtain a brighter picture

Press the GAMMA/BRIGHTER button again.

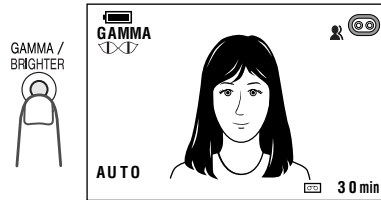

- The  indicator appears.



## To cancel the gain-up function

Press the GAMMA/BRIGHTER button until "GAMMA" disappears.

### Notes:

- You may experience some picture noise in Gain-up mode, which increases when the  displays.
- When the  indicator displays, you may get a shadow image behind a subject that is moving around a lot.
- Fine brightness adjustments are possible when using manual exposure (see page 56).
- Gain-up will cancel if you aim the camcorder in a bright location.

## Useful features Camera Recording

### Quick Return

**Available mode:**  
TAPE-CAMERA

If while playing back your tape you want to quickly return to the last recorded scene and start recording again, use the quick return function.

- 1 Set the camcorder to TAPE-CAMERA mode.
- 2 In Recording Standby mode, press the MENU button until the menu screen appears.
- 3 Press  $\nabla$  or  $\Delta$  on the operation button to select , then press the SET button.
- 4 Press  $\nabla$  or  $\Delta$  to select "QK. RETURN", then press the SET button.

Useful Features

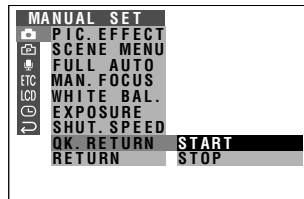
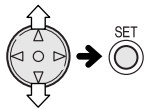

- 5 Press  $\nabla$  or  $\Delta$  to select "START", then press the SET button.
  - "SEARCH" flashes, and the tape begins fast forwarding or rewinding to the end of the last recorded scene.

**QK. RETURN SEARCH**

- When the tape reaches the end of the last recorded scene, "FINISHED" is displayed, and the camcorder enters Recording Standby mode.

- 6 Press the MENU button to turn off the menu screen.

**Notes:**

- To cancel the quick return function while "SEARCH" is flashing, press the SET button twice.
- Quick return will not work if you remove the cassette and reload it after recording or if nothing has been recorded since loading.

### Edit Search

**Available mode:**  
TAPE-CAMERA

The edit search function lets you search, without switching from TAPE-CAMERA mode to TAPE-VCR mode, for the point on the tape where you wish to start recording next.

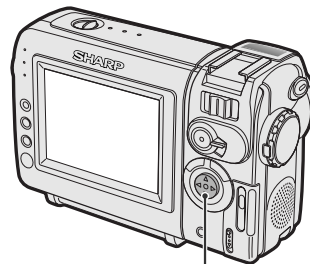

Operation button

- 1 Set the camcorder to TAPE-CAMERA mode.
- 2 In Recording Standby mode, press and hold down  $\triangleleft$  (reverse edit search) or  $\triangleright$  (forward edit search) on the Operation button.

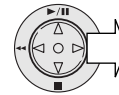
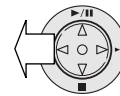

- 3 When you find the point where you want to begin recording, release the button.

**Notes:**

- The sound is off during search.
- Forward edit search is performed at the same speed as normal playback, and reverse edit search at six times the normal playback.
- You may experience picture noise during reverse edit search.



## Fade In and Fade Out

**Available mode:**  
TAPE-CAMERA

The fade function allows you to gradually bring the image and sound in or out at the beginning or end of a scene for creating scene transitions. This is especially effective in creating a dramatic change in scenery.

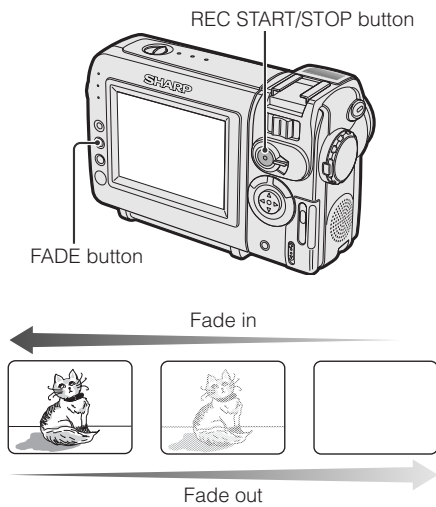

### Using Fade Mode

- In TAPE-CAMERA mode, press the FADE button.
  - "FADE" is displayed.

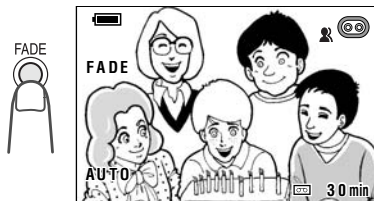

- Press the REC START/STOP button to begin recording.
  - The picture turns white, and the image and sound fade in.

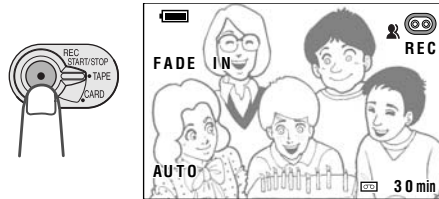

- Press the REC START/STOP button at the point where you wish to stop recording.
  - The image and sound fade out as the picture gradually turns white. The camcorder then returns to Recording Standby mode.

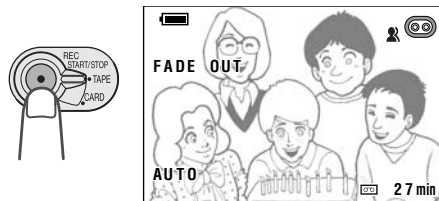

### To cancel Fade mode

Press the FADE button again in Recording Standby mode.

### To use Fade Out only

- During camera recording in TAPE-CAMERA mode, press the FADE button to display "FADE".
- Press the REC START/STOP button at the point where you wish to stop recording.

**Note:**

- Fade mode automatically cancels after Fade Out.

## Useful Features Camera Recording

### Still Recording

#### Still Recording Mode

**Available mode:**  
TAPE-CAMERA

You can record still images of subjects with normal sound on a tape by selecting one of two still recording modes.

##### Types of Still Recording modes

- SNAP:** A still picture is recorded for 6 seconds.
- STILL:** A continuous still image is recorded.

#### Selecting Still Recording mode

- 1 In TAPE-CAMERA mode, press the MENU button until the menu screen appears.
- 2 Press  $\nabla$  or  $\Delta$  on the operation button to select  $\square$ , then press the SET button.
- 3 Press  $\nabla$  or  $\Delta$  to select "PHOTO SNAP", then press the SET button.

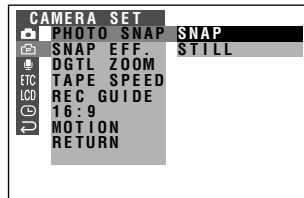
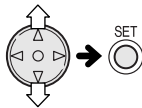

- 4 Press  $\nabla$  or  $\Delta$  to select the desired still recording mode, then press the SET button.

**PHOTO SNAP STILL**

- 5 Press the MENU button to turn off the menu screen

#### Still Recording Effects

**Available modes:**  
TAPE-CAMERA, CARD-CAMERA

You can select one of these still recording effects to record the still images with an effect.

##### Types of Still Recording Effects

- OFF:** A still image recorded without any effect.
- PHOTO SHOT:** A still picture is recorded with the sound and visual effects of a camera shutter closing.
- 9 FRAMES:** A still picture is recorded at intervals of 1/8 of a second using a 9-frame picture.
- 16 FRAMES:** A still picture is recorded at intervals of 1/8 of a second using a 16-frame picture.

#### Selecting a still recording effect

- 1 In TAPE-CAMERA or CARD-CAMERA mode, press the MENU button until the menu screen appears.
- 2 Press  $\nabla$  or  $\Delta$  on the operation button to select  $\square$ , then press the SET button.
- 3 Press  $\nabla$  or  $\Delta$  to select "SNAP EFF.", then press the SET button.

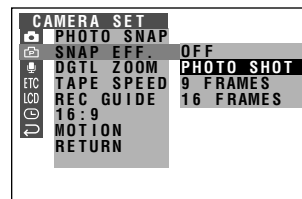
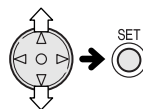

- 4 Press  $\nabla$  or  $\Delta$  to select the desired still recording effect, then press the SET button.

**SNAP EFF. 9 FRAMES**

- 5 Press the MENU button to turn off the menu screen.

## Using Still Recording

### TAPE-CAMERA mode

- 1 Set the camcorder to TAPE-CAMERA mode.
- 2 Select the still recording mode and effect.
- 3 In Recording Standby mode, press the STILL button fully.
  - A still image of the subject is displayed.
- 4 Press the REC START/STOP button.
  - The still image of the subject will be recorded.
  - In SNAP mode, the camcorder returns to Recording Standby mode after recording a still image for 6 seconds.



### To pause recording

Press the REC START/STOP button.

### To cancel the still image

In **SNAP mode**, press the STILL button fully while the camcorder is in Recording Standby mode.

In **STILL mode**, press the STILL button fully.

### CARD-CAMERA mode

See page 67.

#### Notes:

- Still Recording can also be used during recording by pressing the STILL button fully.
- The picture quality in Still Recording function will be slightly lower than normal pictures.
- You can use PHOTO SHOT without the sound effect of a camera shutter closing by setting the SOUND menu item to "OFF" (see page 83).

## Recording a Still Life

#### Available modes:

TAPE-CAMERA, CARD-CAMERA

You can record a clearer still life image with this camcorder.

- The example screens shown are for TAPE-CAMERA mode.

- 1 In TAPE-CAMERA or CARD-CAMERA mode, press the MENU button until the menu screen appears.
- 2 Press  $\nabla$  or  $\Delta$  on the operation button to select , then press the SET button.
- 3 Press  $\nabla$  or  $\Delta$  to select "MOTION", then press the SET button.

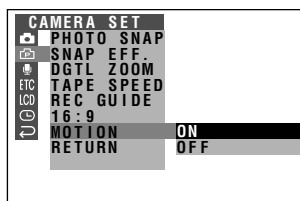
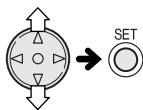

- 4 Press  $\nabla$  or  $\Delta$  to select "OFF", then press the SET button.

**MOTION OFF**

- 5 Press the MENU button to turn off the menu screen.
- 6 Follow the steps in "Still Recording" (beginning on the previous page) to record still images.

#### Notes:

- Set MOTION menu item to "ON" after recording still life images. If left "OFF" and you record a still image of a moving subject, the image will blur.
- When you set the MOTION menu item to "OFF" to record a still life image, it is recommended to attach the camcorder to a tripod to prevent image shakes.

## Useful Features Camera Recording

### Wide Screen (16:9)

**Available mode:**  
TAPE-CAMERA

The wide screen function lets you record scenes with the wide-screen feel of a movie shown in a theatre. The top and bottom of the picture are masked with black bands to produce an effective screen aspect ratio of 16:9.

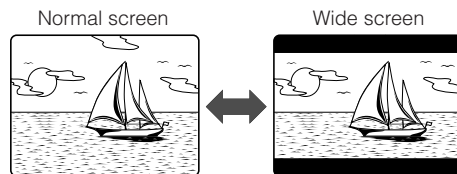

- 1 In TAPE-CAMERA mode, press the MENU button until the menu screen appears.
- 2 Press  $\nabla$  or  $\Delta$  on the operation button to select  $\square$ , then press the SET button.
- 3 Press  $\nabla$  or  $\Delta$  to select "16:9", then press the SET button.

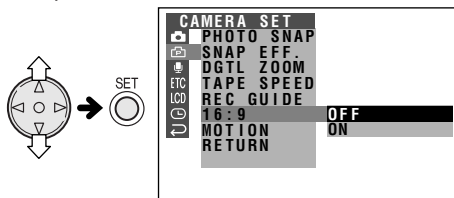

- 4 Press  $\nabla$  or  $\Delta$  to select "ON", then press the SET button.

**16:9 ON**

- 5 Press the MENU button to turn off the menu screen.
  - The picture is displayed with the top and bottom portions masked.

### To return to normal screen

Select "OFF" in step 4 above.

#### Note:

- When still recording with "9 FRAMES" or "16 FRAMES" effect, each frame will display in normal (not wide) screen.

GB 37

### Digital Image Stabilization (DIS)

**Available modes:**  
TAPE-CAMERA, CARD-CAMERA

The digital image stabilization (DIS) function allows you to stabilize the image by electronically compensating for relatively minor image shaking that is often annoying in close-up shots.

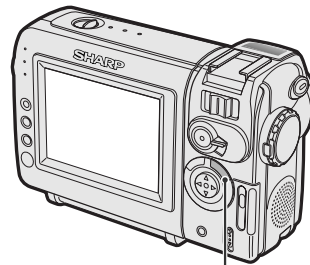

DIS button

Press the DIS button. The  $\text{DIS}$  indicator appears, and the camcorder enters DIS mode.

To return to normal recording mode, press the DIS button again. The  $\text{DIS}$  indicator will disappear.



DIS indicator

#### Notes:

- The DIS function cannot compensate for excessive image shaking.
- When image shaking does not occur (e.g. when using the camcorder on a tripod), turn off the DIS function. The picture will appear more natural when the DIS function is off.

## Self Recording

### Available modes:

TAPE-CAMERA, CARD-CAMERA

Rotate the LCD monitor 180° vertically so that the screen faces the other way and the subject can monitor the shot while you are recording.

If the camcorder is steadied, you can record yourself in the scene by watching yourself on the LCD monitor. The remote control (only supplied with VL-NZ10) is useful for such occasions.



- 1 Set the Media Selection switch to TAPE or CARD.
- 2 Set the Power switch to CAMERA.
- 3 Rotate the monitor section 180° vertically.
  - A mirror image of the subject displays on the LCD monitor.

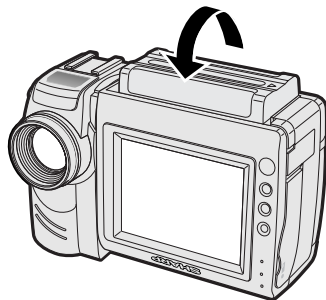

- 4 Begin recording.

### Cautions:

- Do not rotate the monitor section to the self recording position during recording or playback.
- For recording in Self Recording mode, be sure to rotate the monitor section, NOT the lens section. If you hold the camcorder upside down with the lens at the bottom, the subject will be recorded upside down.

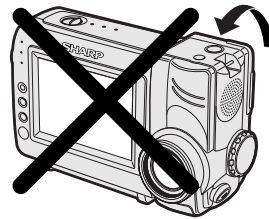

### More Information on Self Recording

- Use the remote control (only supplied with VL-NZ10) to begin/stop recording.
- The screen image automatically inverts when the monitor rotation is between 135° and 200°. When the monitor section is turned back to the normal position, the image returns to normal.
- You can play back images while the monitor is in the self recording position. Set the camcorder to TAPE-VCR mode. The Operation button still retains its function as during normal playback, for example,  $\Delta$  on the Operation button works as the Play button.

## Useful Features Camera Recording

### Recording in LP (Long Play Recording) Mode

**Available mode:**  
TAPE-CAMERA

This camcorder allows you to record in LP (Long Play Recording) mode for approximately 50% more recording time with the same picture quality as that in SP (Standard Play Recording) mode.

- 1 In TAPE-CAMERA mode, press the MENU button until the menu screen appears.
- 2 Press  $\nabla$  or  $\Delta$  on the operation button to select , then press the SET button.
- 3 Press  $\nabla$  or  $\Delta$  to select "TAPE SPEED", then press the SET button.

Useful Features

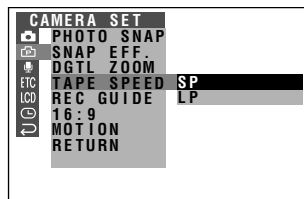
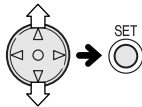

- 4 Press  $\nabla$  or  $\Delta$  to select "LP", then press the SET button.

#### TAPE SPEED LP

- 5 Press the MENU button to turn off the menu screen.
  - The long play recording mode indicator appears.



Long play recording mode indicator

#### To return to SP mode

Select "SP" in step 4 above.

#### Notes on the use of LP mode

- To record in LP mode, be sure to use a Mini DV cassette labelled for use with LP mode.
- Frozen images, mosaic-pattern picture noise, audio interruptions or audio loss may occur in the following cases:
  - When using a tape which is not designated for use with LP mode.
  - When a tape recorded in LP mode under high temperature conditions is played back.
  - When a tape recorded in LP mode with the camcorder is played back on a Mini DV player or camcorder from another manufacturer.
  - When a tape recorded in LP mode is played back on a Mini DV player or camcorder without an LP function.
- Audio dubbing is not possible with LP mode recording.

## Selecting the 16-bit Audio Recording Mode

**Available mode:**  
TAPE-CAMERA

This camcorder allows you to select between 12-bit and 16-bit audio recording modes. The camcorder normally records audio in the 12-bit audio recording mode. For higher-quality audio recording, select the 16-bit audio recording mode.

- 1 In TAPE-CAMERA mode, press the MENU button until the menu screen appears.
- 2 Press  $\nabla$  or  $\Delta$  on the operation button to select  $\text{MENU}$ , then press the SET button.
- 3 Press  $\nabla$  or  $\Delta$  to select "AUDIO MODE", then press the SET button.

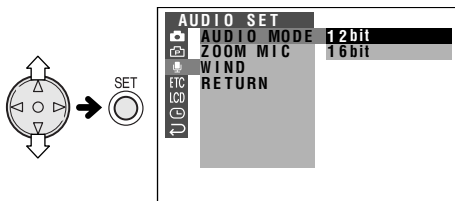

- 4 Press  $\nabla$  or  $\Delta$  to select "16bit", then press the SET button.

**AUDIO MODE 16 bit**

- 5 Press the MENU button to turn off the menu screen.
  - The 16-bit audio recording mode indicator appears.

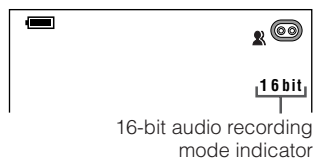

### To return to 12-bit audio recording mode

Select "12bit" in step 4 above.

**Note:**

- When using Audio Dubbing with 16-bit audio recordings, both the dubbed and original sounds will be recorded in mono (see page 62).

## Turning off the On-screen Indicators

**Available modes:**  
All modes

You can turn the on-screen indicators on and off as you like.

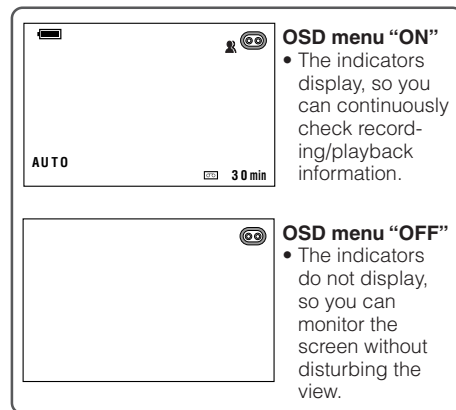

- 1 Press the MENU button until the menu screen appears.
- 2 Press  $\nabla$  or  $\Delta$  on the operation button to select ETC, then press the SET button.
- 3 Press  $\nabla$  or  $\Delta$  to select "OSD", then press the SET button.

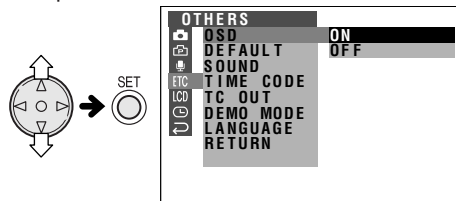

- 4 Press  $\nabla$  or  $\Delta$  to select "OFF", then press the SET button.

**OSD OFF**

- 5 Press the MENU button to turn off the menu screen.

**Note:**

- When you press the GAMMA/BRIGHTER button or FADE button after setting the OSD menu item to "OFF", it automatically returns to "ON". Perform the steps above to turn off the indicators again.

## Useful Features Camera Recording

### Attaching the Supplied Tripod Adapter

Attach the supplied tripod adapter when using a tripod with the camcorder.

- 1 Align the tripod adapter with the tripod adapter socket on the bottom of the camcorder, then rotate as shown below.

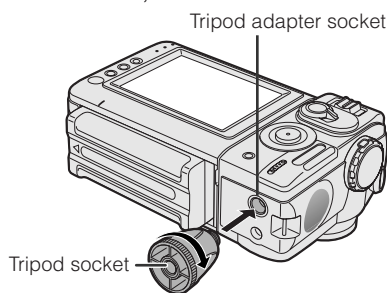

- 2 Attach tripod to tripod socket.



#### Note:

- You cannot use the supplied tripod adapter, if the alignment pin is not retractable.

### Attaching the Supplied Grip Handle

Attach the supplied grip handle when you want to steady the camcorder with your right hand during recording.

Align the grip handle with the tripod adapter socket on the bottom of the camcorder, then rotate as shown below.

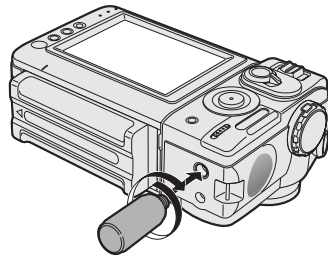

#### Caution:

- Do not pick up the camcorder by the grip handle, as this may damage the equipment.



# Useful Features

## Playback

### Using the Remote Control (Only supplied with VL-NZ10)

**Available modes:**  
All modes

Use the remote control to operate the camcorder from a distance, such as when you want to record yourself in a scene, or when the camcorder is connected to a TV for use as a VCR.

### Turning on the Remote Control Mode

**Available modes:**  
TAPE-VCR, CARD-VCR

- 1 In TAPE-VCR or CARD-VCR mode, press the MENU button until the menu screen appears.
- 2 Press  $\nabla$  or  $\Delta$  on the operation button to select ETC, then press the SET button.
- 3 Press  $\nabla$  or  $\Delta$  to select "REMOTE", then press the SET button.

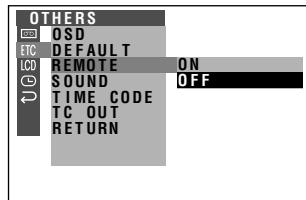
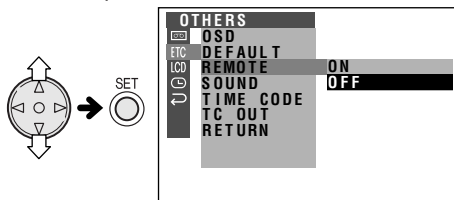

- 4 Press  $\nabla$  or  $\Delta$  to select "ON", then press the SET button.

**REMOTE ON**

- 5 Press the MENU button to turn off the menu screen.

### Operating the Remote Control

Aim the remote control at the remote sensor of the camcorder, and press the control buttons to operate.

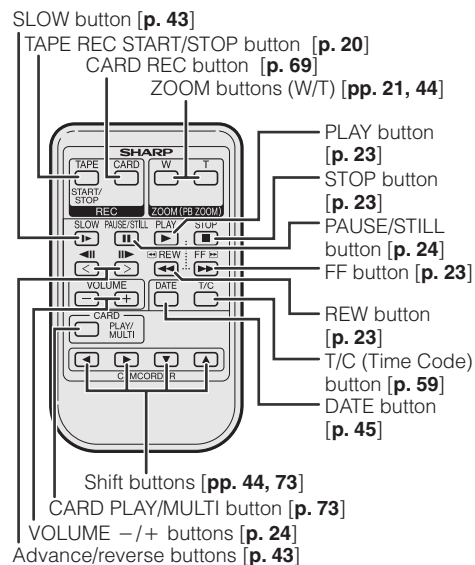
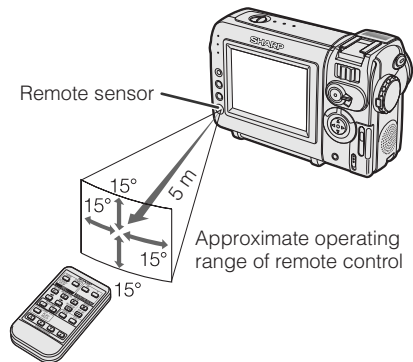

Useful Features

#### Notes:

- Be careful not to expose the remote sensor to direct sunlight or strong interior lighting, as this may prevent the remote control from operating properly.
- Be sure that there are no obstacles between the remote control and the remote sensor.

## Useful Features Playback

### Tape Playback Functions with the Remote Control (Only supplied with VL-NZ10)

**Available mode:**  
TAPE-VCR

You can use the following playback functions with the remote control. (See page 42 for use of the remote control.)

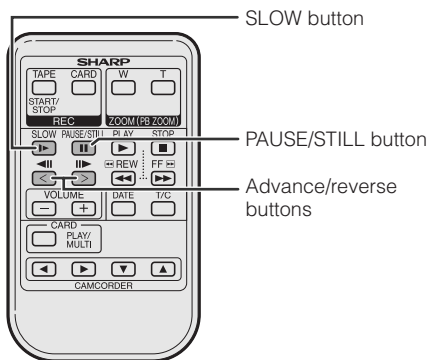

### Frame Advance

The frame advance function allows you to play back still images frame by frame.

- 1 During playback in TAPE-VCR mode, press the PAUSE/STILL button (||) to pause playback.



- 2 Press the ||> (or <||) button.
  - Each time you press the button, the picture advances one frame forward (or backward).

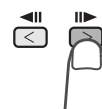

To return to normal playback, press the PLAY button (▶).

#### Notes:

- The sound is off during reverse, slow, and frame advance playback.
- If you use the slow or frame advance function with the tape recorded in LP mode, the picture may advance several frames at a time.
- You can take clearer still images by recording with a fast shutter speed (see page 57).

### Reverse Playback

The reverse playback function allows you to play back video in reverse.

During playback in TAPE-VCR mode, press the <|| button.

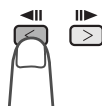

To return to normal playback, press the PLAY button (▶).

### Slow

The slow function allows you to play back images in slow motion.

During playback in TAPE-VCR mode, press the SLOW button (▶).  
To view slow playback in reverse, press the <|| button.



To return to normal playback, press the PLAY button (▶).

#### Note:

- To protect the tape, the camcorder automatically returns to normal playback if it is left in Slow mode for more than 10 minutes.

## Playback Zoom with the Remote Control (Only supplied with VL-NZ10)

### Available modes:

TAPE-VCR, CARD-VCR

The playback zoom function allows you to magnify the playback picture up to 10 times its original size and shift the magnified picture by using the remote control. (See page 42 for use of the remote control.)

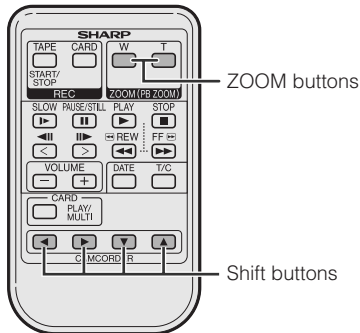

- The example screens shown are for TAPE-VCR mode.

- 1 During playback in TAPE-VCR or CARD-VCR mode, press the ZOOM T button to zoom in.

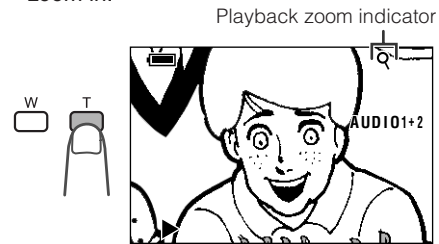

- 2 Press the Shift <left>, <right>, <up>, or <down> button to shift the displayed image.

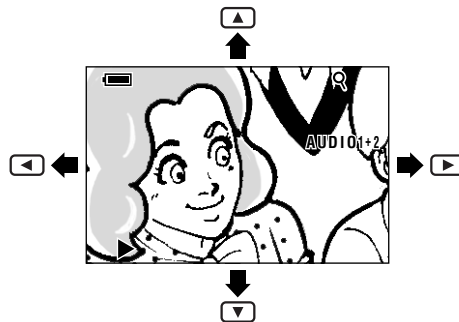

Useful Features

### To cancel Playback Zoom

Press the ZOOM W button, which zooms out to the widest angle.

### Notes:

- Use of Playback Zoom may cause a reduction in picture quality for still images.
- Images in Playback Zoom mode cannot be transferred via DV or PC connecting cable to a personal computer.

## Useful Features Playback

### Displaying the Date and Time of Recording

#### Available modes:

All modes

Follow the procedure below to display the date, or both the date and time, of recording on the screen. You can display the date and time during both recording and playback.

- The example screens for this feature are for TAPE-CAMERA mode.

- Hold down the Lock button and set the Power switch to CAMERA or VCR.
- Press the MENU button until the menu screen appears.
- Press  $\nabla$  or  $\Delta$  on the operation button to select  $\text{CLOCK}$ , then press the SET button.
- Press  $\nabla$  or  $\Delta$  to select "DISPLAY", then press the SET button.

Useful Features

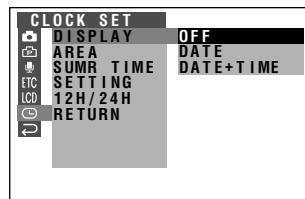
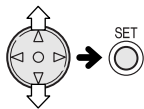

- Press  $\nabla$  or  $\Delta$  to select "DATE" or "DATE + TIME", then press the SET button.

**DISPLAY**      **DATE+TIME**

- Press the MENU button to turn off the menu screen.

- The date (or the date and time) is displayed.

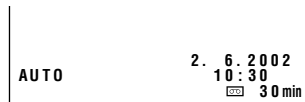

#### Notes:

- The date (or date and time) appears when the OSD menu item is set to "ON".
- Before recording, make sure that the date and time have been correctly set. If they have not been set, the display will be left blank when playing back the recording. (The display will also be left blank for unrecorded or damaged portions of the tape.)
- In TAPE-VCR or CARD-VCR mode, the current date and time are displayed when the tape or card is not being played back.
- You can also press the DATE button on the remote control (only supplied with VL-NZ10) to display the date (or date and time).

## Gamma Playback

**Available mode:**  
TAPE-VCR

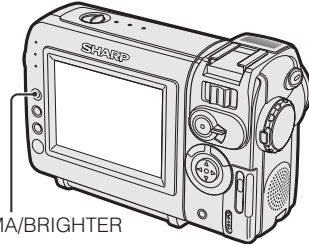

GAMMA/BRIGHTER  
button

The gamma playback function improves the playback picture in TAPE-VCR mode by increasing the brightness of the subject while leaving the brighter portions of the image unaffected.

During playback in TAPE-VCR mode, press the GAMMA/BRIGHTER button once.

- "GAMMA1" appears, and the picture becomes brighter.

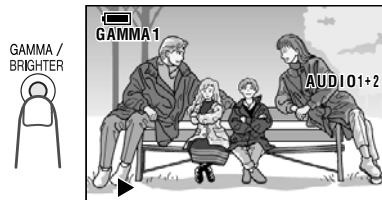

To obtain a brighter picture, press the GAMMA/BRIGHTER button again.

- "GAMMA2" appears.

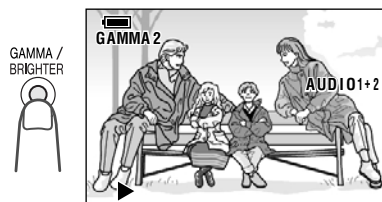

## To cancel Gamma Playback

Press the GAMMA/BRIGHTER button until "GAMMA1" and "GAMMA2" disappear.

### Note:

- Gamma Playback has no effect during still playback.

## Useful Features Playback

### Multiple Strobe Playback

Available mode:  
TAPE-VCR

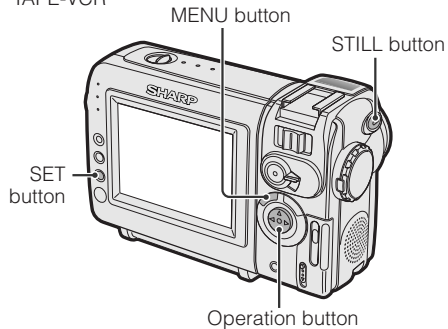

The multiple strobe playback function can be used to capture the action of a fast-moving subject at intervals of 1/8 of a second using a 9- or 16-frame picture. This is useful when you want to check your form in sports such as tennis or golf.

Useful Features

- 1 Remove the card from the camcorder.
- 2 In TAPE-VCR mode, press the MENU button until the menu screen appears.
- 3 Press  $\nabla$  or  $\Delta$  on the operation button to select  $\square$ , then press the SET button.
- 4 Press  $\nabla$  or  $\Delta$  to select "MULTI FRAME", then press the SET button.

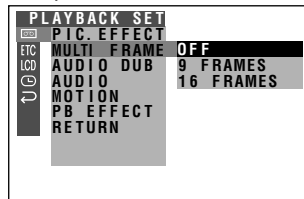
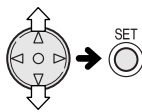

- 5 Press  $\nabla$  or  $\Delta$  to select "9 FRAMES" (9-frame picture) or "16 FRAMES" (16-frame picture), then press the SET button.

**MULTI FRAME 16 FRAMES**

- 6 Press the MENU button to turn off the menu screen, then begin playback.

- 7 Press the STILL button fully at the point where you want to begin the multiple strobe playback.
  - A multi-frame picture of the image is displayed.



### To cancel Multiple Strobe Playback

Press the STILL button fully again.

#### Notes:

- Multiple Strobe Playback cannot be used during video search, still, slow or reverse playback.
- When a card is loaded, the multi-frame picture is recorded on the card (see page 48).

## Copying an Image from Tape to Card

**Available mode:**  
TAPE-VCR

You can capture your favourite image frame from a video tape recording and save it on card.

- 1 Insert the recorded Mini DV cassette and a card in the camcorder.
- 2 Set the camcorder to TAPE-VCR mode, then begin tape playback.
- 3 Select the frame number of the image (see page 47).

### MULTI FRAME OFF

**OFF:** 1-frame picture  
**9 FRAMES:** 9-frame picture  
**16 FRAMES:** 16-frame picture

- 4 Hold the STILL button half-way down at the point where the desired image appears.

- A still picture of the image is displayed.

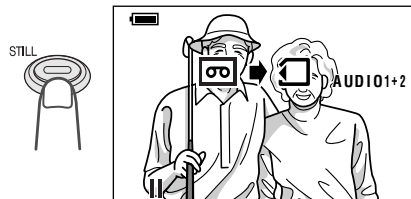

**Note:**

- To cancel the still picture, release the STILL button.

- 5 Press the STILL button fully to copy the image to the card.
  - The  indicator flashes red while the image is copied.



**Note:**

- To capture clearer still images of still life picture, set the MOTION menu item to "OFF".

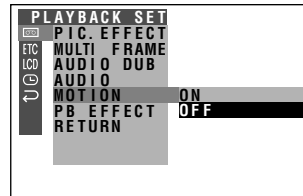

## Useful Features Playback

### Playback Effects

**Available mode:**  
TAPE-VCR

Use Playback effects to create an interesting scene transition between a still image and the following image during playback.

#### Types of Playback Effects

**OVERLAP:** A still image fades out as the next image fades in, replacing the previous image. The two scenes momentarily dissolve.

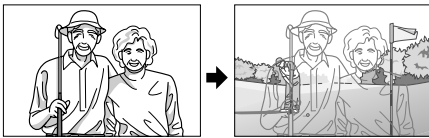

**WIPE:** A still image is replaced with the next image first appearing in the middle of the screen and gradually expanding to fill the screen.

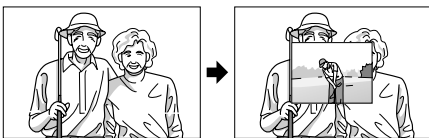

#### Preparation

Plan the scene transition, and record still images with the still recording function in TAPE-CAMERA mode (see pages 35 and 36).

#### Notes:

- You can use playback effects for a transition from a still image to a moving image.
- Record images for 6 seconds or longer. An image recorded for less than 6 seconds may not dissolve properly.

#### Using Playback Effect

- 1 In TAPE-VCR mode, press the MENU button until the menu screen appears.
- 2 Press  $\nabla$  or  $\Delta$  on the operation button to select  $\square$ , then press the SET button.
- 3 Press  $\nabla$  or  $\Delta$  to select "PB EFFECT", then press the SET button.

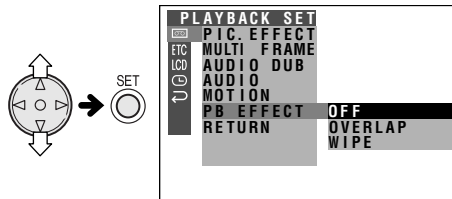

- 4 Press  $\nabla$  or  $\Delta$  to select "OVERLAP" or "WIPE", then press the SET button.

#### PB EFFECT WIPE

- 5 Press the MENU button to turn off the menu screen.
- 6 Rewind or fast forward the tape to just before the position where you want to use the playback effect, and then begin playback.
  - The still image is replaced with the next image with the selected playback effect.

#### To cancel the playback effect

Select "OFF" in step 4 above.

#### Notes:

- Playback effects will cancel if Multiple Strobe Playback is used thereafter.
- Playback effects cannot be used with Playback Zoom or Picture Effect Playback.
- Playback effects will cancel if the power source is interrupted or the Power switch is set to OFF.
- If you record the still images less than six seconds or if you record the still images on the tape from CARD in CARD-VCR mode, the Playback Effect will not work correctly.



## Picture Effect Playback

### Available modes:

TAPE-VCR, CARD-VCR

These picture effects let you play back images with a more dramatic effect.

### Types of Picture Effects

**B/W:** The picture is displayed in black-and-white.

**SEPIA:** The picture is displayed in sepia colour similar to that of an old photograph.

**SOLARI:** The contrast of the subject is enhanced, creating a unique artistic image.

**NEGA:** The blacks and whites of the image are reversed and colours of the image are inverted.

**BLUE:** The picture is displayed with the effect of playback through a blue filter.

• The example screens for this feature are for TAPE-VCR mode.

- 1 During playback in TAPE-VCR (or CARD-VCR) mode, press the MENU button until the menu screen appears.
- 2 Press  $\nabla$  or  $\Delta$  on the operation button to select  $\square$  (or  $\square$ ), then press the SET button.
- 3 Press  $\nabla$  or  $\Delta$  to select "PIC. EFFECT", then press the SET button.

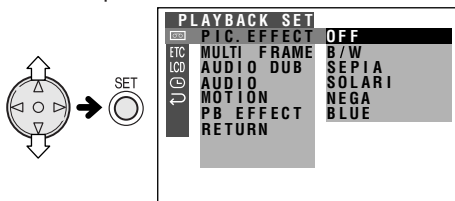

- 4 Press  $\nabla$  or  $\Delta$  to select the desired picture effect, then press the SET button.

**PIC. EFFECT B/W**

- 5 Press the MENU button to turn off the menu screen.

### To cancel Picture Effect Playback

Select "OFF" in step 4 above.

### Notes:

- Images in Picture Effect Playback mode cannot be transferred via DV or PC connecting cable to a personal computer.
- **You cannot use Picture Effect Playback with Multiple Strobe Playback or Slide Show Playback.**

# Advanced Features

## Camera Recording

### Digital Picture Effects

**Available modes:**

TAPE-CAMERA, CARD-CAMERA

These digital picture effects let you record the subject with a more dramatic effect.

#### Types of Digital Picture Effects

**B/W:** To record in black-and-white.

**SEPIA:** To record in sepia colour similar to that of an old photograph.

**SOLARI:** To record with enhanced contrast, creating a unique artistic image.

**NEGA:** To record a picture whose blacks and whites of the image are reversed and colours of the image are inverted.

**BLUE:** To record with the effect of recording through a blue filter.

- 1 In TAPE-CAMERA or CARD-CAMERA mode, press the MENU button until the menu screen appears.
- 2 Press  $\nabla$  or  $\Delta$  on the operation button to select , then press the SET button.
- 3 Press  $\nabla$  or  $\Delta$  to select "PIC. EFFECT", then press the SET button.

Advanced Features

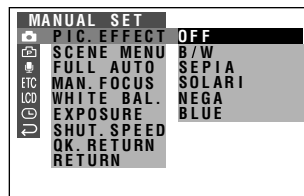
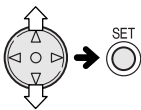

- 4 Press  $\nabla$  or  $\Delta$  to select the desired digital picture effect, then press the SET button.

- The selected digital picture effect is displayed on the menu screen.

**PIC. EFFECT B/W**

- 5 Press the MENU button to turn off the menu screen.

#### To cancel the digital picture effect

Select "OFF" in step 4 above.

**Note:**

- Digital picture effects cannot be used when a still image is displayed.

## Scene Menu (Program AE)

### Available modes:

TAPE-CAMERA, CARD-CAMERA

You can set the camcorder to the shooting mode that will create the best results for a specific situation. Just select one of four scene settings shown below. The camcorder will automatically set the exposure, white balance, and shutter speed to produce the optimum picture quality for the selected situation.

### Types of Scene Settings

**SPORT:** When you want to record a fast-moving subject.

**SUNLIGHT:** When the background is very bright.

**DUSK:** When you want to faithfully record the red of the setting sun, and the surrounding twilight.

**PARTY:** When the illumination is from a spotlight or candle.

- 1 In TAPE-CAMERA or CARD-CAMERA mode, press the MENU button until the menu screen appears.
- 2 Press  $\nabla$  or  $\Delta$  on the operation button to select , then press the SET button.
- 3 Press  $\nabla$  or  $\Delta$  to select "SCENE MENU", then press the SET button.

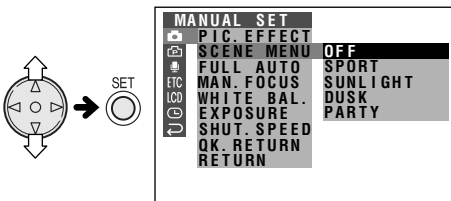

- 4 Press  $\nabla$  or  $\Delta$  to select the scene setting that best fits the recording situation, then press the SET button.
  - The selected scene setting is displayed on the menu screen.

### SCENE MENU SPORT

- 5 Press the MENU button to turn off the menu screen.
  - The selected scene setting indicator displays.



### To cancel the scene setting

Select "OFF" in step 4 above.

### Note:

- Scene settings cannot be used when displaying a still image.









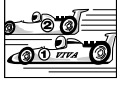

## Advanced Features Camera Recording

### Manual Focus

#### Available modes:

TAPE-CAMERA, CARD-CAMERA

Auto Focus may not be able to focus on the subject in the situations shown below. In such situations, set the camcorder to Manual Focus mode and focus manually.

 Subject is too dark.	 Lack of contrast, e.g. snow scene.
 Fast-moving subject.	 Background is too bright.
 Subject has horizontal stripes.	 Subject is being shot through a dirty or wet window.
 Light reflects off the subject.	 Two subjects at different distances overlap in the same scene.
 Subject has fine, repeated patterns.	 Subjects at different distances appear in the centre of the scene at the same time.
 Fast-speed shutter being used under fluorescent lighting.	

Advanced Features

- 1 In TAPE-CAMERA or CARD-CAMERA mode, press the MENU button until the menu screen appears.
- 2 Press  $\nabla$  or  $\Delta$  on the operation button to select , then press the SET button.
- 3 Press  $\nabla$  or  $\Delta$  to select "MAN. FOCUS", then press the SET button.

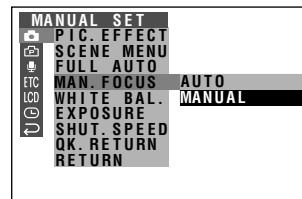
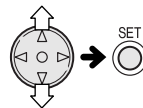

- 4 Press  $\nabla$  or  $\Delta$  to select "MANUAL", then press the SET button to display the focus setting screen.

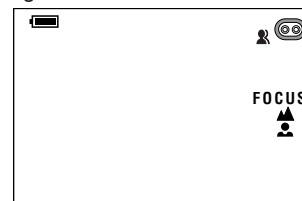
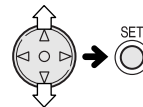

- 5 Adjust the Power Zoom control to frame the subject as you desire.

- 6 Press  $\nabla$  or  $\Delta$  to focus on the subject, then press the SET button.

$\blacktriangle$ : To focus on a more distant subject  
 $\blacktriangledown$ : To focus on a closer subject

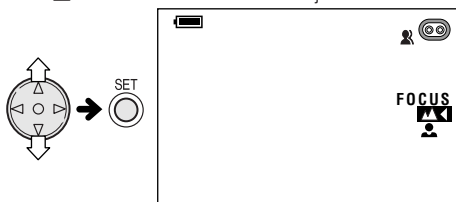

- 7 Press the MENU button to turn off the menu screen.

• "MF" is displayed.



Manual focus indicator

#### To return to Auto Focus mode

After performing step 1 to 3 above, press  $\nabla$  or  $\Delta$  to select "AUTO", then press the SET button.

#### Notes:

- The camcorder may not be able to focus correctly if the subject is closer than approximately 1.5 m. Set the zoom control to wide angle, and try refocusing again.
- If the lens is dirty or fogged, the camcorder may not be able to focus correctly.
- When "MF" is displayed, you can manually adjust the focus by pressing  $\nabla$  or  $\Delta$ , even if the focus setting screen is not displayed.

## Setting the Camcorder to Full Auto Mode

#### Available modes:

TAPE-CAMERA, CARD-CAMERA

You can set all manual settings, including manual focus, white balance, manual exposure and manual shutter speed, to Full Auto mode in one operation.

- 1 In TAPE-CAMERA or CARD-CAMERA mode, press the MENU button until the menu screen appears.
- 2 Press  $\nabla$  or  $\Delta$  on the operation button to select , then press the SET button.
- 3 Press  $\nabla$  or  $\Delta$  to select "FULL AUTO", then press the SET button.

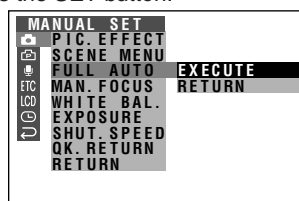
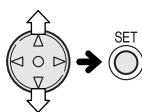

- 4 Press  $\nabla$  or  $\Delta$  to select "EXECUTE", then press the SET button.
- 5 Press the MENU button to turn off the menu screen.

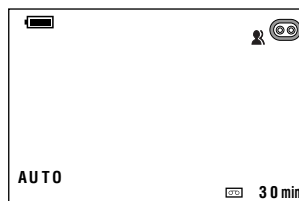

#### Note:

- You cannot select "FULL AUTO" when no manual settings are currently in use.

## Advanced Features Camera Recording

### Adjusting White Balance

#### Available modes:

TAPE-CAMERA, CARD-CAMERA

The colour of the subject on the screen looks different depending on lighting conditions. Select a White Balance setting that matches the lighting conditions.

#### Types of White Balance settings

**AUTO:** Colouring adjusted automatically for the current lighting condition

**LOCK:** Fix the setting to the standard balance (White Balance Lock)

**OUTDOOR:** For recording outdoors on a sunny day

**INDOOR:** For recording indoors with halogen lamps or incandescent lighting

**RETURN:** For maintaining the previous setting

#### Selecting a White Balance setting

- 1 In TAPE-CAMERA or CARD-CAMERA mode, press the MENU button until the menu screen appears.
- 2 Press  $\nabla$  or  $\Delta$  on the operation button to select , then press the SET button.
- 3 Press  $\nabla$  or  $\Delta$  to select "WHITE BAL.", then press the SET button.

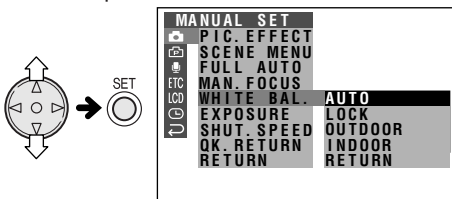

- 4 Press  $\nabla$  or  $\Delta$  to select a white balance setting, then press the SET button.

#### WHITE BAL. OUTDOOR

- When selecting "LOCK", perform the steps "Locking the White Balance".

- 5 Press the MENU button to turn off the menu screen.

#### Locking the White Balance

- 1 Select "LOCK" in step 4 above.
- 2 Aim the lens at a white object.
  - Adjust the distance of the object so that the entire screen is white.

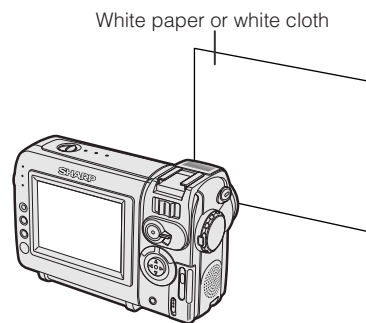

- 3 Press the SET button to set the white balance lock.
  - "LOCK" flashes during the locking procedure.

#### Note:

- If you move the camcorder while "LOCK" is flashing, "LOCK" may not stop flashing. If this occurs, press the SET button to cancel the procedure, and then repeat step 3.

- 4 Press the MENU button to turn off the menu screen.

#### To cancel White Balance setting

After performing step 1 to 3 in "Selecting a White Balance setting", press  $\nabla$  or  $\Delta$  to select "AUTO", then press the SET button.

#### To return to Full Auto mode

Set the camcorder to Full Auto mode (see page 54).

#### Note:

- White Balance setting will cancel if a scene setting is selected thereafter.

## Manual Exposure

### Available modes:

TAPE-CAMERA, CARD-CAMERA

The camcorder is preset to Auto Exposure mode, which automatically selects the optimal aperture. However, when there is too much contrast in brightness between the subject and background, you may not be able to record a clear image. In this case, use the manual exposure function to correct the exposure level.

### Background is too bright and subject too dark (backlit subject).

- Increase the exposure level to allow more light through the lens.

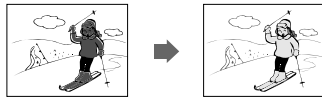

### Subject is too bright against background.

- Decrease the exposure level to allow less light through the lens.



- In TAPE-CAMERA or CARD-CAMERA mode, press the MENU button until the menu screen appears.
- Press  $\nabla$  or  $\Delta$  on the operation button to select , then press the SET button.
- Press  $\nabla$  or  $\Delta$  to select "EXPOSURE", then press the SET button.

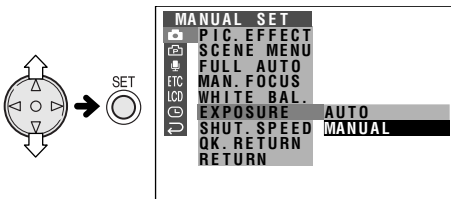

- Press  $\nabla$  or  $\Delta$  to select "MANUAL", then press the SET button to display the exposure setting screen.

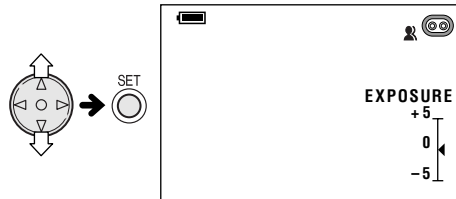

- Press  $\nabla$  or  $\Delta$  to select the desired exposure level.
  - The number shown is the selected exposure level. The adjustment range is from -5 (least light) to +5 (most light).

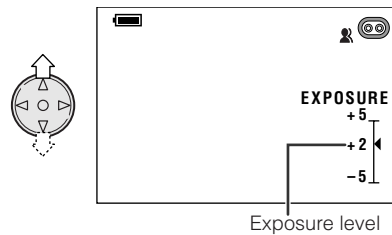

- Press the SET button.
  - The selected exposure level is displayed on the menu screen.

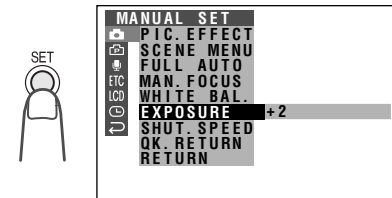

- Press the MENU button to turn off the menu screen.

### To return to Auto Exposure mode

After performing step 1 to 3 above, press  $\nabla$  or  $\Delta$  to select "AUTO", then press the SET button.

### To return to Full Auto mode

Set the camcorder to Full Auto mode (see page 54).

### Note:

- Manual Exposure mode will cancel if a scene setting is selected thereafter.

## Advanced Features Camera Recording

### Setting the Shutter Speed

#### Available modes:

TAPE-CAMERA, CARD-CAMERA

The shutter speed is preset to auto mode, which automatically selects the optimal shutter speed for the ambient light. However, depending on the subject or situation, you may want to set the shutter speed manually to create a high-quality picture.

- 1 In TAPE-CAMERA or CARD-CAMERA mode, press the MENU button until the menu screen appears.
- 2 Press  $\nabla$  or  $\Delta$  on the operation button to select , then press the SET button.
- 3 Press  $\nabla$  or  $\Delta$  to select "SHUT. SPEED", then press the SET button.

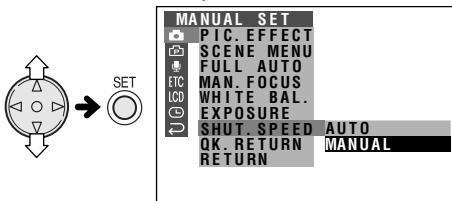

Advanced Features

- 4 Press  $\nabla$  or  $\Delta$  to select "MANUAL", then press the SET button to display the shutter speed setting screen.

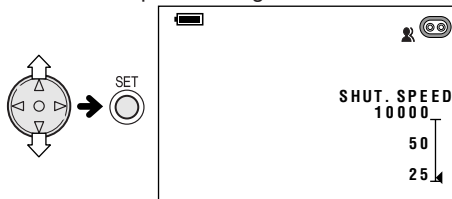

- 5 Press  $\nabla$  or  $\Delta$  to select the desired shutter speed, then press the SET button.
  - You can select 17 speeds from 1/25 sec. ("25") (slowest shutter speed) to 1/10,000 sec. ("10000") (fastest shutter speed).

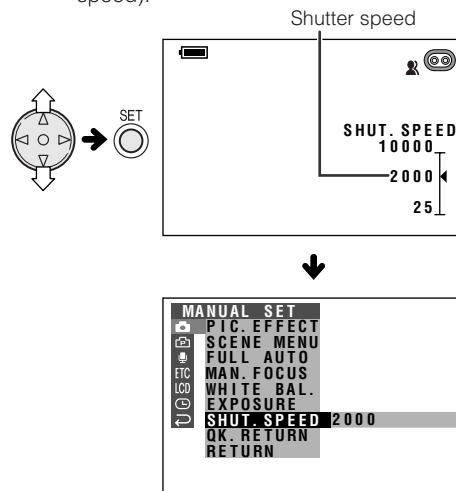

- The selected shutter speed is displayed on the menu screen.

- 6 Press the MENU button to turn off the menu screen.

#### To return to Auto Shutter Speed mode

After performing step 1 to 3 above, press  $\nabla$  or  $\Delta$  to select "AUTO", then press the SET button.

#### To return to Full Auto mode

Set the camcorder to Full Auto mode (see page 54).



## Recommended Shutter Speeds

The faster the shutter speed, the darker the picture becomes. Select the most appropriate shutter speed for the ambient light.

Situation	Recommended shutter speed
<ul style="list-style-type: none"> <li>Recording sports action in bright daylight.</li> <li>Recording in bright daylight at a ski resort.</li> </ul>	1/10,000 sec.   1/1,000 sec.
<ul style="list-style-type: none"> <li>Recording outdoor sports on a partially cloudy day.</li> <li>Recording an outside scene through a car window (when you want to minimize blur caused by the camera shaking).</li> </ul>	1/1,000 sec.   1/250 sec.
<ul style="list-style-type: none"> <li>When you want to reduce the light by half. Use as a substitute for an ND2 filter.</li> </ul>	1/120 sec.
<ul style="list-style-type: none"> <li>Recording in a poorly-illuminated location.</li> <li>When you want to create artistic trailing images of fast-moving subjects.</li> </ul>	1/25 sec.

## Tips on Using the Manual Shutter Speed

- Fast shutter speeds can be used with the still recording functions (see pages 35, 36 and 67) to record higher quality still images of fast-moving subjects.
- If the on-screen picture flickers when recording under fluorescent lighting, you may be able to compensate by setting the shutter speed to 1/120 sec.

### Notes:

- Recording with a shutter speed faster than 1/50 sec. tends to darken the picture. Record in bright locations when you use a fast shutter speed.
- Using a fast shutter speed under fluorescent lighting will cause flickering in the picture and possibly periodic colour shifts.
- When selecting 1/25 sec. shutter speed, you may get a shadow image behind a subject that is moving around a lot.
- The manual shutter speed setting will cancel if a scene setting is selected or gain-up function is used thereafter.**

# Advanced Features

## Playback

### Using the Time Code

#### Available modes:

TAPE-VCR, TAPE-CAMERA

The time code shows the hour, minute and second of recording, and the frame number (1 frame = approx. 1/25 sec.). This is automatically recorded along with the subject when you are recording on the tape. You can display the time code on the screen as an accurate counter in both TAPE-VCR and TAPE-CAMERA modes.

#### Display format

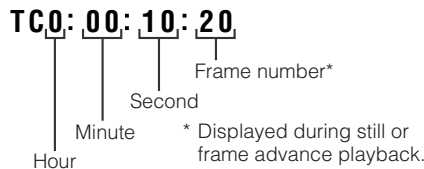

- The example screens shown are for TAPE-VCR mode.

- During playback or camera recording in TAPE modes, press the MENU button until the menu screen appears.
- Press  $\nabla$  or  $\Delta$  on the operation button to select ETC, then press the SET button.
- Press  $\nabla$  or  $\Delta$  to select "TIME CODE", then press the SET button.

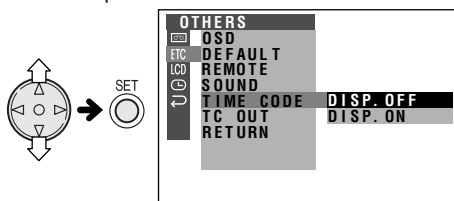

- Press  $\nabla$  or  $\Delta$  to select "DISP. ON", then press the SET button.

**TIME CODE DISP. ON**

- Press the MENU button to turn off the menu screen.
  - The time code appears.

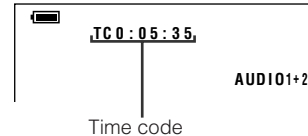

#### To turn off the time code

Select "DISP. OFF" in step 4 above.

#### Notes:

- The time code appears when the OSD menu item is set to "ON".
- When the tape reaches an unrecorded section, the time code returns to zero (TC0:00:00). Once recorded, the time code cannot be changed.
- You can also press the T/C (Time Code) button on the remote control (only supplied with VL-NZ10) to display the time code.

#### Displaying the time code on a TV during playback

- In TAPE-VCR mode, press the MENU button until the menu screen appears.
- Press  $\nabla$  or  $\Delta$  on the operation button to select ETC, then press the SET button.
- Press  $\nabla$  or  $\Delta$  to select "TC OUT", then press the SET button.

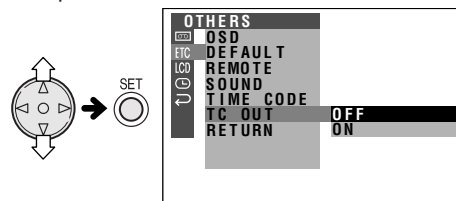

- Press  $\nabla$  or  $\Delta$  to select "ON", then press the SET button.

**TC OUT ON**

- Press the MENU button to turn off the menu screen.

## Editing

**Available mode:**  
TAPE-VCR

Video editing lets you refine your videos by removing unwanted sequences from your tape, or transposing one sequence with another. This camcorder lets you monitor the source program on the built-in LCD monitor without having to connect it to an external TV or video monitor.

Connect the camcorder to a VCR with the supplied audio/video/S-video cable, as shown.

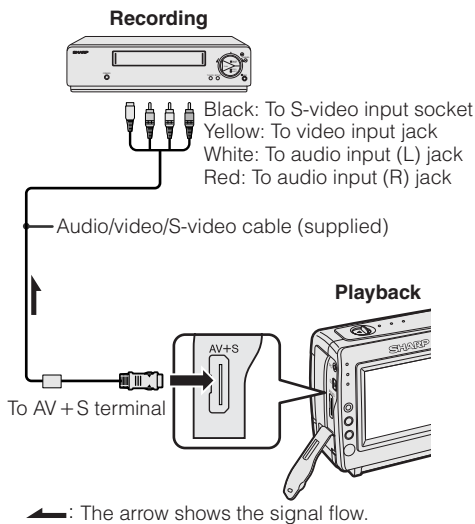

### Notes:

- If your VCR has a 21-pin Euro-SCART connector, use the RCA/21-pin Euro-SCART conversion connector (QSOCZ0033TAZZ).

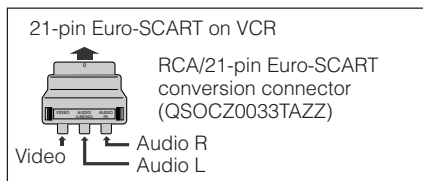

- See page 2 for how to open the jack cover.
- If your VCR has only one audio input jack, use the white plug for the audio connection on the VCR.
- If your VCR has an S-video input socket, you do not need to connect the yellow video plug.

## Cutting Unwanted Sequences

- 1 Play back the tape to be edited on the camcorder, and locate the beginning and end of the sequence you wish to cut. Write down the time code reading at the beginning and end of that sequence (see page 59). Then, rewind the tape to before the beginning of the portion that you wish to keep.
- 2 Load a video cassette into the recording VCR.
- 3 Press  $\Delta$  on the camcorder to begin playback, then press the Record button on the VCR to begin recording.
- 4 Press the Pause/Still button on the VCR to pause recording when the source tape reaches the beginning of the sequence to be cut.
- 5 Press the Pause/Still (or Record) button on the VCR to resume recording when the source tape reaches the end of the sequence to be cut.

### To stop editing

Press  $\nabla$  on the camcorder and press the Stop button on the VCR.

### Notes:

- Some of the transitions between edited sequences may be slightly off.
- There may be picture noise during video search or still playback. This does not imply a defect in the camcorder.
- The time code display will be recorded along with the edited sequences if the TC OUT item is set to "ON". Set to "OFF" before editing (see page 59).

## Advanced Features Playback

### Editing with the DV Terminal (IEEE1394)

**Available mode:**  
TAPE-VCR

This camcorder enables you to perform digital video editing. Connect the camcorder to video equipment with a DV terminal using the supplied DV cable. The DV cable is able to transfer all dubbing signals including video and audio.

### To Record to Video Equipment

See "Cutting Unwanted Sequences" on page 60, using the video equipment as the recording source.

**Note:**

- Make sure that the video equipment to which you are recording can input dubbing signals via the DV terminal.

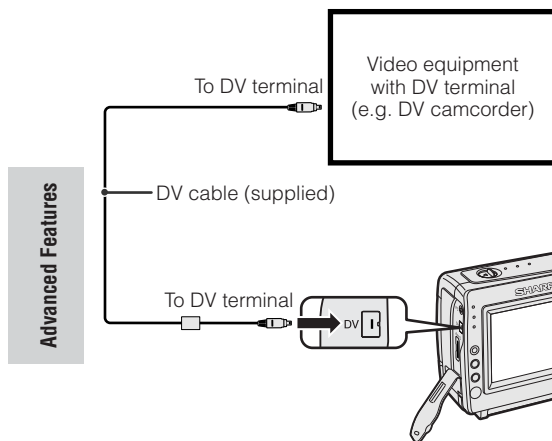

### To Record from Video Equipment (VL-NZ10 only)

- 1 Set the camcorder to TAPE-VCR mode, and insert a Mini DV cassette.
- 2 Begin playback on the video equipment connected to the camcorder.
  - Check the camcorder screen to see if the picture is properly received.
- 3 Press the REC START/STOP button on the camcorder.
  - The camcorder enters Recording Standby mode.
- 4 Press  $\Delta$  on the Operation button to begin recording.

### To stop recording

Press  $\nabla$  on the Operation button.

### Cutting Unwanted Sequences (VL-NZ10 only)

- 1 Press  $\Delta$  to pause recording when the source tape reaches the beginning of the sequence to be cut.
- 2 Press  $\Delta$  to resume recording when the source tape reaches the end of the sequence to be cut.

**Notes:**

- Make sure that the video equipment from which you are recording can output dubbing signals via the DV terminal.
- If the video equipment is not set to playback mode or the DV cable is not properly connected, "NO SIGNAL" is displayed on the camcorder screen.
- If no picture or sound is input to the camcorder even if the DV cable is properly connected and you are playing back the source media from the video equipment, set the Power switch on the camcorder to OFF and then back to VCR, or disconnect the DV cable and connect it again.
- If a digital video recording with a copyright protection signal is used as the playback source, "COPYRIGHT PROTECTED." appears on the camcorder monitor and the recording function is disabled (see page 87).

## Audio Dubbing Feature

**Available mode:**  
TAPE-VCR

You can add narration to recordings made with this camcorder, while preserving the original audio and video recordings.

### Microphone for Audio Dubbing

You can use the built-in stereo microphone to record narration.

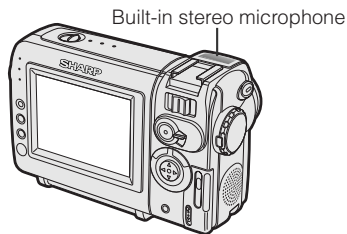

**Notes:**

- Audio dubbing does not function through the DV terminal.
- You cannot use the zoom microphone to record narration.
- You cannot use audio dubbing with recordings made in LP mode.

## Audio Recording

### In normal recording mode

**12-bit audio recording**

The audio is recorded in stereo on Audio 1.

**Audio 1:** Stereo (left and right) sound

**Audio 2:** No audio

**16-bit audio recording**

The audio is recorded in stereo with the left and right sound on two separate channels.

**Audio 1:** Left sound

**Audio 2:** Right sound

### In Audio Dubbing mode

**12-bit audio recording**

The dubbed audio is recorded on Audio 2.

**Audio 1:** Original stereo (left and right) sound

**Audio 2:** Dubbed stereo (left and right) sound

**16-bit audio recording**

The dubbed audio is recorded on Audio 2 over the original right sound. Both dubbed and original sounds are mono.

**Audio 1:** Original left sound

**Audio 2:** Dubbed sound

**Note:**

- You can select the 12-bit or 16-bit audio recording mode by performing the procedure on page 40.

## Advanced Features Playback

### Audio Dubbing

- 1 Play back the recorded Mini DV cassette and locate the tape position where you wish to start audio dubbing.
- 2 Press  $\Delta$  to pause playback.
- 3 Press the MENU button until the menu screen appears.
- 4 Press  $\nabla$  or  $\Delta$  on the operation button to select  $\square$ , then press the SET button.
- 5 Press  $\nabla$  or  $\Delta$  to select "AUDIO DUB", then press the SET button.
  - The audio dubbing screen appears.

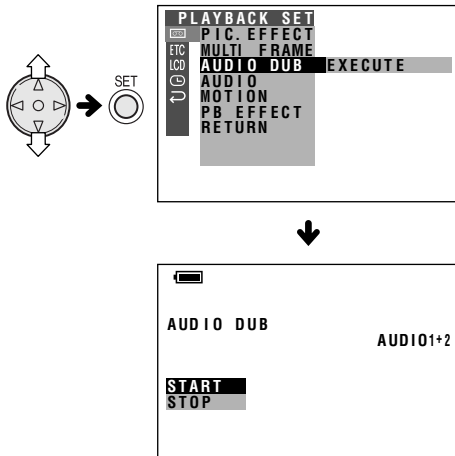

Advanced Features

- 6 Press the SET button to begin audio dubbing. Record your narration.

### To pause audio dubbing

Press the SET button. To resume audio dubbing, press the SET button again.

### To cancel audio dubbing

Press the MENU button. The audio dubbing screen disappears.

### If you wish to change the dubbed audio or dub additional scenes

- 1 Press the MENU button to turn off the audio dubbing screen.
- 2 Repeat steps 1 to 6 above.

#### Notes:

- It is recommended that you use Audio Dubbing only with recordings made with this camcorder. Use of recordings made with other digital video equipment may result in poor audio quality.
- Audio dubbing will automatically pause if the original audio changes from 12-bit mode to 16-bit mode or vice versa. Press the SET button to resume operation.
- Audio dubbing will automatically stop if a portion recorded in LP mode or an unrecorded portion of the tape is encountered.
- You can play back the dubbed audio and the original audio together or separately (see "Selecting the Audio Playback Mode" on next page).

## Selecting the Audio Playback Mode

**Available mode:**  
TAPE-VCR

You can select any of the following audio playback modes.

### Audio 1+2

- 12-bit recording in stereo (Audio 1 and Audio 2 channels)
- 16-bit recording in stereo (left and right channels)

### Audio 1

- 12-bit recording in stereo (Audio 1 channel only)
- 16-bit recording in mono (left channel only)

### Audio 2

- 12-bit recording in stereo (Audio 2 channel only)
- 16-bit recording in mono (right channel only)

- 1 Play back a Mini DV cassette with dubbed audio.
- 2 Press the MENU button until the menu screen appears.

- 3 Press  $\nabla$  or  $\Delta$  on the operation button to select  $\square$ , then press the SET button.

- 4 Press  $\nabla$  or  $\Delta$  to select "AUDIO", then press the SET button.

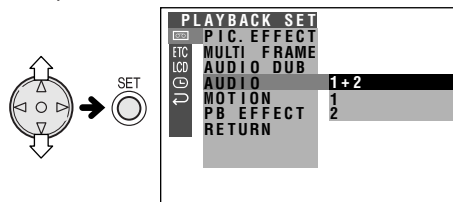

- 5 Press  $\nabla$  or  $\Delta$  to select the desired audio playback mode, then press the SET button.

**AUDIO 1+2**

- 6 Press the MENU button to turn off the menu screen.
  - The selected audio playback mode indicator displays.

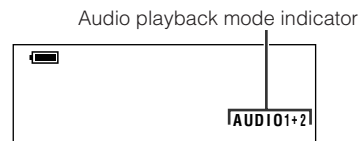

**Note:**

- The audio playback mode indicator, "AUDIO", displays in different colours depending on the recording mode (12- or 16-bit) used for the recording being played back. A white display indicates 12-bit recording mode, while a green indicates 16-bit.

## Advanced Features Playback

### Configuring Software for PC Connection

This camcorder can transfer still playback images in TAPE-VCR mode or still images in TAPE-CAMERA and CARD modes to a personal computer by using the Video Capture Software (only supplied with VL-NZ10).

#### System Requirements

- IBM PC/AT or compatible with Intel® Pentium® 133 MHz or faster processor
- Microsoft Windows® 95B, Windows® 95C, Windows® 98, Windows® 98 Second Edition, Windows® 2000 Professional\*, or Windows® Me operating system
- 32 MB or more of RAM
- 9 MB minimum of available hard-disk space
- SVGA (800 × 600 pixels) colour display monitor with 16-bit colour or higher
- CD-ROM drive (for installation)
- RS-232C serial port
- Mouse or other pointing device

\* In the Windows® 2000 Professional environment, only the system administrator has installation access rights.

#### Installing the Software

- 1 Turn on the PC and start up Windows.
- 2 Insert the CD-ROM of the Video Capture Software into the CD-ROM drive.
- 3 Double click on the "My Computer" icon.
- 4 Double click on the CD-ROM drive icon.
- 5 Double click on the "Setup.exe" file.
- 6 Follow the instructions as they appear on the PC monitor until the installation is complete.
- 7 Restart the PC.

### Connecting the camcorder to a Personal Computer

- 1 Turn off the camcorder and PC.
- 2 Connect the camcorder as shown below.
  - Before connecting the camcorder to the PC, make sure that the PC power is off to insure that images are transferred properly.

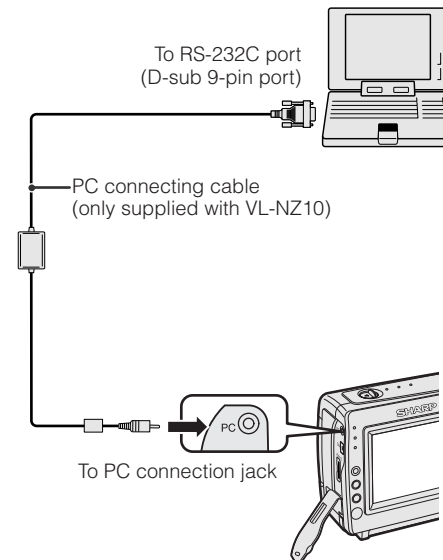

- 3 Turn on the PC, then turn on the camcorder in the desired camcorder mode.

#### Notes:

- It is recommended to use the AC adapter/battery charger as a power source for extended periods of use.
- Images with the following functions cannot be transferred to a personal computer.
  - TAPE-VCR/CARD-VCR mode: Picture Effect Playback
  - TAPE-CAMERA/CARD-CAMERA mode: Digital Picture Effects
- Using a commercially available PC card adapter, it is possible to directly transfer still images on a card to a PC (see page 79).
- To edit still images transferred with the Video Capture Software, use a commercially available image editing software.



## Using the Software

For tips on how to use the Video Capture Software, refer to the operation manual located on the CD-ROM in PDF format. Follow the steps below to open the PDF file containing the manual.

### Note:

- For the latest product information, be sure to read the "Readme" text file located in the "Readme" folder of the Video Capture Software CD-ROM. Select the "Readme" text file you prefer. The letters between "Readme" and ".txt" define the language; for example, "en" in "Readmeen.txt" stands for English, etc.

## Installing Adobe Acrobat Reader

Adobe Acrobat Reader 4.0 or later is required for viewing the PDF manual of the Video Capture Software. If the Adobe Acrobat Reader is not installed on your PC, perform steps below to install one.

- 1 Insert the CD-ROM of the Video Capture Software into the CD-ROM drive.
- 2 Double click on the "My Computer" icon.
- 3 Double click on the CD-ROM drive icon.
- 4 Double click on the "Acroread" folder.
- 5 Double click on the desired language version.

Language	File name
Chinese, Simplified	ar40chs.exe
Chinese, Traditional	ar405cht.exe
Dutch	ar405dut.exe
English	ar405eng.exe
French	ar405fre.exe
German	ar405deu.exe
Italian	ar405ita.exe
Korean	ar405kor.exe
Portuguese	ar405por.exe
Spanish, Castilian	ar405esl.exe
Swedish	ar405swe.exe

- 6 Follow the instructions as they appear on the PC monitor until the installation is complete.
- 7 Restart the PC.

## Opening the PDF Manual

- 1 Insert the CD-ROM of the Video Capture Software into the CD-ROM drive.
- 2 Double click on the "My Computer" icon.
- 3 Double click on the CD-ROM drive icon.
- 4 Double click on the "Manual" folder.
- 5 Double click on the PDF file of the desired language version.
  - Adobe Acrobat Reader launches and the selected PDF manual opens.

### Note:

- If the PDF file does not open, Adobe Acrobat Reader may not be properly installed. Refer to the steps of "Installing Adobe Acrobat Reader" to check the installation procedure.

## Printing the PDF Manual

Print out the PDF manual so that you can consult it whenever necessary.

- 1 Open the PDF manual.
- 2 Select "Print" in the "File" menu.

### Note:

- The menu expressions such as "Print" and "File" may vary according to the language version of Adobe Acrobat Reader installed on the PC.
- 3 Select your print settings, then click "OK".

# Digital Still Camera Features

## Camera Recording

### Card Recording

**Available mode:**  
CARD-CAMERA

You can take a still picture in the same way as you do with a standard camera and record that image on the card.

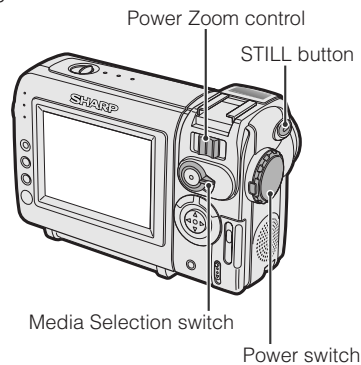

- 1 Insert a card into the camcorder (see page 13).
- 2 Remove the lens cap.
- 3 Set the Media Selection switch to CARD.



- 4 Hold down the Lock button and set the Power switch to CAMERA.
  - The picture from the lens now displays.

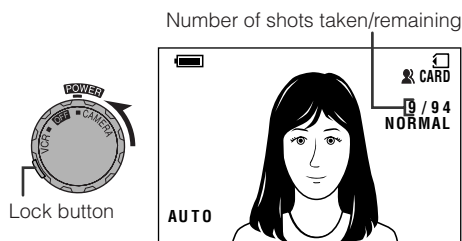

- 5 Perform the steps in "Selecting a still recording effect" to select a still recording effect (see page 35).

- 6 Adjust the Power Zoom control to frame the subject as you desire.

- 7 Press the STILL button half-way down to focus on the subject.
  - The camcorder automatically focuses on the subject. When it is set, you will hear a sound and see  mark, then the camcorder locks the focus.



- If selecting "9 FRAMES" or "16 FRAMES" in step 5 above, the camcorder does not lock the focus.

- 8 Press the STILL button fully to begin recording.

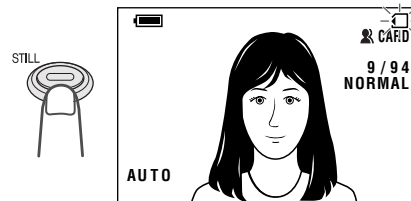

- The  indicator flashes red while data is being recorded on the card, and returns to white when recording completes.
- To record another image, release the STILL button and make sure the picture is not frozen in the monitor, then perform steps 7 and 8.

#### Notes:

- Recording under insufficient lighting may result in blurred images. It is recommended that you use a tripod to record insufficiently illuminated subjects.
- Recording under the light of a fluorescent, mercury, or sodium lamp may cause flickering in the image and, depending on the timing of the shot, may result in changes to colour hue in the image.
- Set the SOUND menu item to "OFF" to turn off the focus locking sound.
- To capture clearer still images of still life picture, set the MOTION menu item to "OFF" (see page 36).

#### Caution:

- Do not turn the power off while the  indicator is flashing in step 8.

## Selecting the Picture Quality

**Available mode:**  
CARD-CAMERA

The picture quality of still images recorded on the card depends on the picture quality setting. Select the appropriate setting to match your recording objectives.

### Types of picture quality settings

**NORMAL:** Records images with standard picture quality.

**ECONOMY:** Allows you to take more shots than in NORMAL mode but with a lower quality.

**FINE:** Records images with higher quality than in NORMAL mode but with a lower number of recordable images.

### Approximate number of recordable images with the card supplied with VL-NZ10

Picture quality setting	Approx. number of images
NORMAL	100
ECONOMY	180
FINE	60

**Note:**

- The number of recordable images differs depending on the combination of picture quality settings used and the images shot.

- In CARD-CAMERA mode, press the MENU button until the menu screen appears.
- Press  $\nabla$  or  $\Delta$  on the operation button to select , then press the SET button.
- Press  $\nabla$  or  $\Delta$  to select "REC MODE", then press the SET button.

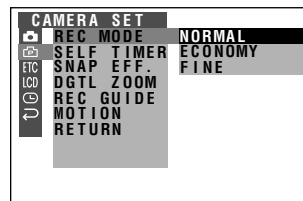
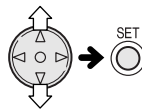

- Press  $\nabla$  or  $\Delta$  to select the desired setting, then press the SET button.

**REC MODE** **ECONOMY**

- Press the MENU button to turn off the menu screen.
  - The selected picture quality indicator displays.

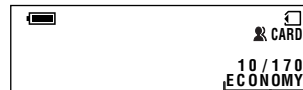

Picture quality indicator

**Note:**

- The picture quality indicator is also displayed in CARD-VCR mode. The picture quality indicator displayed during playback is based on the amount of data for that recorded image. Since the amount of data differs depending on factors such as image detail, sometimes the picture quality indicator displayed during playback may not match the picture quality setting used during recording.

## Digital Still Camera Features Card Recording

### Recording with the Self-timer

**Available mode:**  
CARD-CAMERA

The self-timer function allows you to record images after a time-lag of 10 seconds. This is convenient when you want to record an image of you and your friends together.

- 1 In CARD-CAMERA mode, press the MENU button until the menu screen appears.
- 2 Press  $\nabla$  or  $\Delta$  on the operation button to select  $\boxed{\text{r}}$ , then press the SET button.
- 3 Press  $\nabla$  or  $\Delta$  to select "SELF TIMER", then press the SET button.

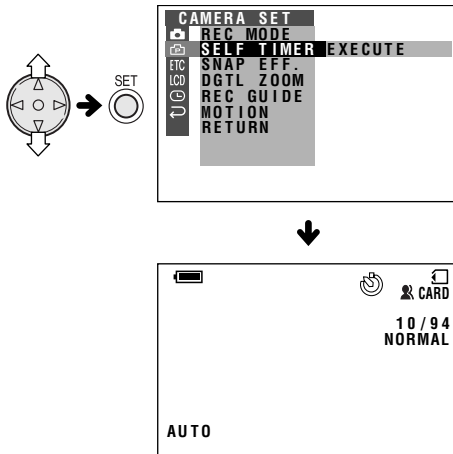

- 4 Press the STILL button fully to set the timer.
  - The self-timer operating indicator flashes while the timer counts down.

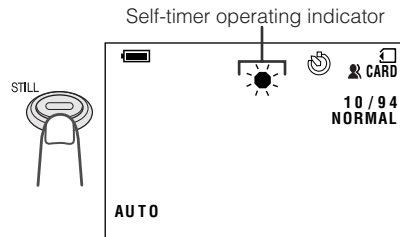

- The shutter automatically releases after 10 seconds, and a still image of the subject is recorded.

#### Notes:

- When recording with the self-timer, stabilize the camcorder in the horizontal plane by attaching it to a tripod, etc.
- To cancel the self-timer, press the STILL button fully again in step 4 above.
- Self-timer mode cancels after recording one image. Repeat steps 1 to 4 to record another image with the self-timer.

#### Caution:

- Do not turn the power off or remove the card once the self-timer operating indicator begins flashing.

## Formatting a Card

**Available mode:**  
CARD-CAMERA

Before using a commercially available card with this camcorder, you must first have it formatted. Also, if any of the following warning indicators displays, you will need to format your card.

- "FORMAT MEMORY CARD"
- "MEMORY CARD ERROR"
- "MEMORY CARD READ ERROR"
- "CANNOT STORE DATA"

**Cautions:**

- **Formatting a card erases all stored images, including delete-protected images.** Be sure to backup important data on your computer or other media before formatting the card (see pages 65, 66 and 79).
- Do not remove the power source during formatting, as this may cause damage to the camcorder or card. It is recommended that you use the AC outlet for the power supply.

- 1 Insert a card to be formatted into the camcorder.
- 2 In CARD-CAMERA mode, press the MENU button until the menu screen appears.
- 3 Press  $\nabla$  or  $\Delta$  on the operation button to select ETC, then press the SET button.

- 4 Press  $\nabla$  or  $\Delta$  to select "FORMAT", then press the SET button.
  - To cancel formatting, press  $\nabla$  or  $\Delta$  to select "NO", then press the SET button.

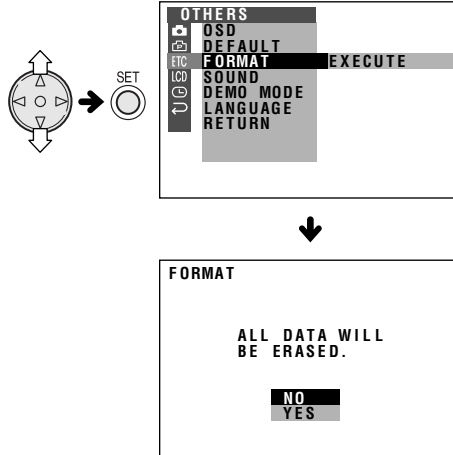

- 5 Press  $\nabla$  or  $\Delta$  to select "YES", then press the SET button to begin formatting.
  - The menu screen displays when formatting finishes.
- 6 Press the MENU button to turn off the menu screen.

**Notes:**

- The card supplied with VL-NZ10 is preformatted for immediate use.
- Use this camcorder to format a card. The camcorder may not recognize the images on a card formatted by a computer or other equipment.

# Digital Still Camera Features

## Playback

### Card Playback

**Available mode:**  
CARD-VCR

You can play back and view still images recorded on a card on the LCD monitor.

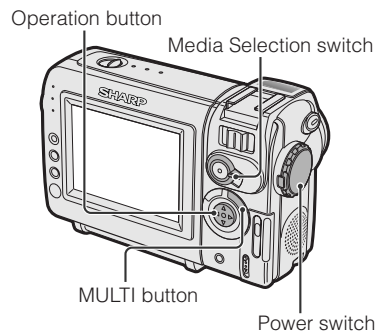

**1** Set the Media Selection switch to CARD.



**2** Hold down the Lock button and set the Power switch to VCR.

- The images recorded on the card are displayed in a thumbnail format.

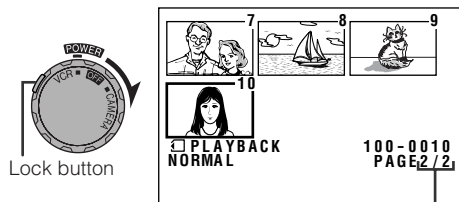

Page number/  
total thumbnail pages

**3** Press  $\leftarrow$ ,  $\rightarrow$ ,  $\nabla$  or  $\triangle$  on the Operation button to move the selection frame to the desired image.

- Each time you press  $\leftarrow$ ,  $\rightarrow$ ,  $\nabla$  or  $\triangle$ , the selection frame moves as shown below.

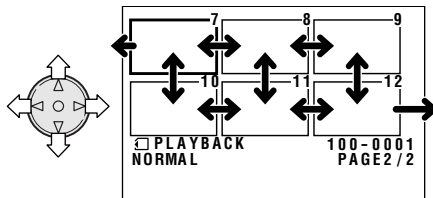

**Note:**

- Holding down  $\leftarrow$  or  $\rightarrow$  increases the speed of motion of the selection frame.

**4** Press the MULTI button.

- The selected image is displayed in full-screen.

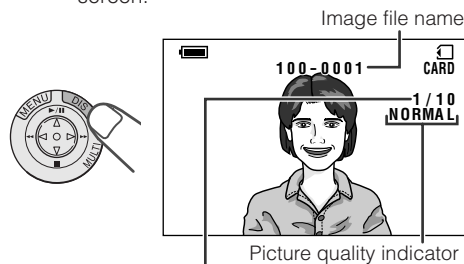

Playback image number/  
number of recordings

- You can also press the SET button to display the image in full-screen.

### Available Operations during Full-screen Display

- You can display the full-screen picture of the previous or next image by pressing  $\leftarrow$  or  $\rightarrow$ .
- When holding down  $\leftarrow$  or  $\rightarrow$ , you can search through the images on the card. The search can be very fast, so it is recommended that you set the OSD menu item to "ON" to display the image number.
- To return to a thumbnail of the images, press the MULTI button again.

**Notes:**

- Depending on the amount of data for the recorded image, the picture quality indicator displayed during playback may not match the picture quality setting used during recording.
- The images bigger than  $640 \times 480$ , e.g. images recorded on other equipment, display as thumbnails, not full screen.
- Do not play back any card storing a defective image (with noise and distortion) created on other equipment. If you mistakenly play back data on such a card, set the Power switch to OFF, remove, and never use it with this camcorder.

## Delete Protection

**Available mode:**  
CARD-VCR

You can prevent your important images recorded on the card from accidental erasure.

- 1 In CARD-VCR mode, press the MENU button until the menu screen appears.
- 2 Press  $\nabla$  or  $\Delta$  on the operation button to select  $\square$ , then press the SET button.
- 3 Press  $\nabla$  or  $\Delta$  to select "PROTECT", then press the SET button.

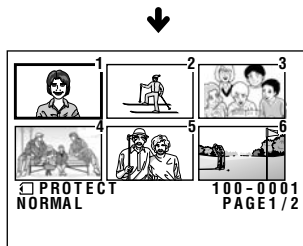
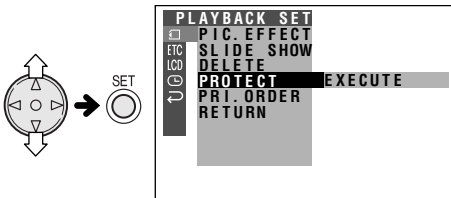

- 4 Press  $\leftarrow$ ,  $\rightarrow$ ,  $\nabla$  or  $\Delta$  to select the image for delete protection.

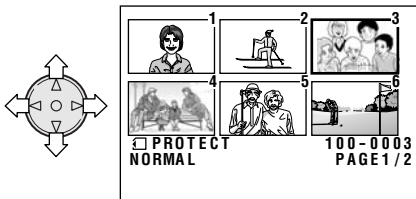

- 5 Press the SET button to set delete protection.

- The  $\square$  indicator appears.

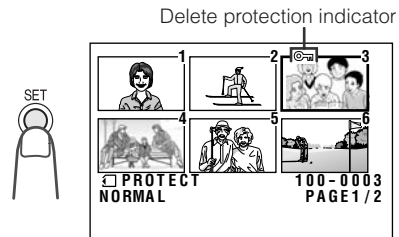

- If you want to protect another image, repeat steps 4 and 5.

- 6 Press the MENU button to display a thumbnail of images.

### To cancel the protection setting

- 1 Select the image for delete protection cancellation in step 4 above.
  - 2 Press the SET button to cancel the protection.
- The  $\square$  indicator disappears.

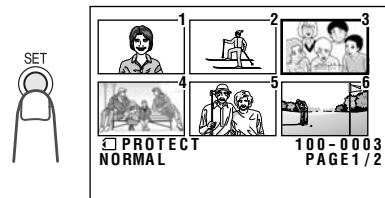

- 3 Press the MENU button to display a thumbnail of images.

### Note:

- Formatting a card erases all stored images, including delete-protected images.

## Digital Still Camera Features Playback

### Deleting Stored Images

**Available mode:**  
CARD-VCR

#### Deleting One Stored Image

You can delete unwanted images to free up memory of a card for new images.

**Note:**

- Deleted images cannot be restored. Check whether or not you want the images before performing the procedure below.

- In CARD-VCR mode, press the MENU button until the menu screen appears.
- Press  $\nabla$  or  $\Delta$  on the operation button to select  $\square$ , then press the SET button.
- Press  $\nabla$  or  $\Delta$  to select "DELETE", then press the SET button.

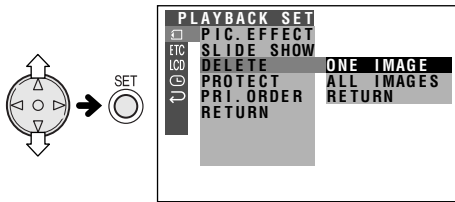

- Press  $\nabla$  or  $\Delta$  to select "ONE IMAGE", then press the SET button.

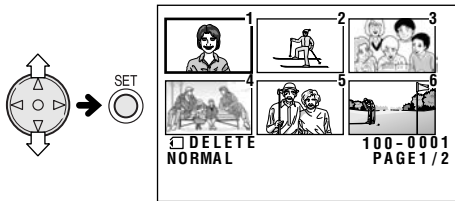

- Press  $\leftarrow$ ,  $\rightarrow$ ,  $\nabla$  or  $\Delta$  to select the image to be deleted.

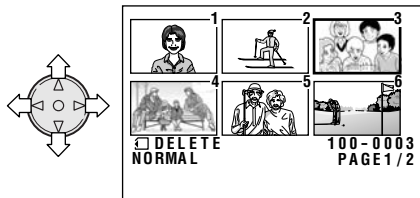

- Press the SET button to set the image.
  - To cancel deletion, press  $\nabla$  or  $\Delta$  to select "NO", then press the SET button.
- Press  $\nabla$  or  $\Delta$  to select "YES", then press the SET button to delete the image.

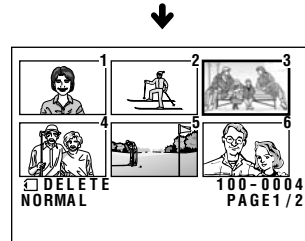
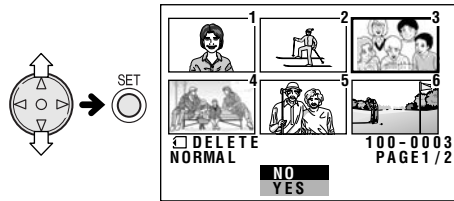

- If you want to delete another image, repeat steps 5 to 7.

- Press the MENU button to display a thumbnail of images.

**Note:**

- The protected images cannot be deleted. Cancel the protection setting to delete the image (see page 72).

**Caution:**

- Do not turn the power off while deleting an image.



## Deleting All Stored Images

You can delete all stored images on a card in one operation.

### Notes:

- Deleted images cannot be restored. Check whether or not you want the images before performing the procedure below.
- If you want to keep some images on the card, first delete-protect them (see page 72), and then perform the procedure below.

- In CARD-VCR mode, press the MENU button until the menu screen appears.
- Press  $\nabla$  or  $\Delta$  on the operation button to select  $\square$ , then press the SET button.
- Press  $\nabla$  or  $\Delta$  to select "DELETE", then press the SET button.

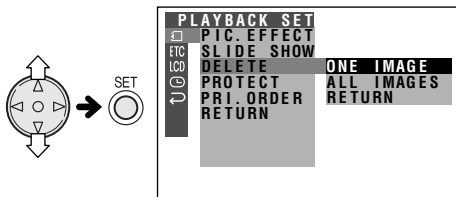

- Press  $\nabla$  or  $\Delta$  to select "ALL IMAGES", then press the SET button.

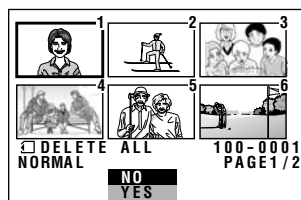
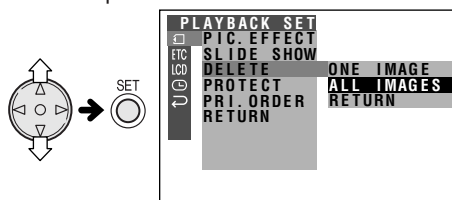

- Press  $\nabla$  or  $\Delta$  to select "YES", then press the SET button to delete all the images.
  - To cancel deletion, press  $\nabla$  or  $\Delta$  to select "NO", then press the SET button.

### Notes:

- The protected images cannot be deleted. Cancel the protection setting to delete the image (see page 72).
- If a print order is assigned to delete-protected images and you perform the procedure above, the print order will cancel (the protection setting will not cancel).
- It may take several seconds to delete all images from the card.

### Caution:

- Do not turn the power off while deleting images.

## Digital Still Camera Features Playback

### Slide Show Playback

**Available mode:**  
CARD-VCR

You can automatically play back consecutive still images recorded on a card at intervals of 5 seconds. This is useful when confirming the data recorded on a card.

- 1 Set the camcorder to CARD-VCR mode.
- 2 Press <◀, ▶, ▽ or ▲ to select the image from which you want to begin slide show playback.

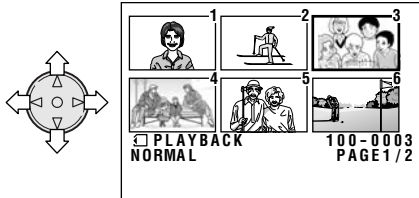

- 3 Press the MENU button until the menu screen appears.
- 4 Press ▽ or ▲ to select , then press the SET button.

- 5 Press ▽ or ▲ to select "SLIDE SHOW", then press the SET button.
  - Beginning from the image selected in step 2, the recorded images will display in full-screen one after another in order of recording.

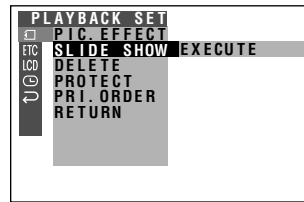
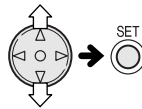

- After playing back all the images on the card once, Slide Show Playback automatically stops.
- 6 Press the MENU button to turn off the menu screen, then press the MULTI button to display a thumbnail of images.

### To stop Slide Show Playback

During slide show playback, press the MENU button twice, then press the MULTI button to display a thumbnail of images.

## Copying an Image from Card to Tape

**Available mode:**  
CARD-VCR

Use the procedure below to select still images recorded on a card and insert them in a tape.

- 1 Insert the recorded card and a Mini DV cassette into the camcorder.
- 2 Set the camcorder to TAPE-VCR mode, then locate where you want to insert an image on the tape.
- 3 Set the camcorder to CARD-VCR mode.
- 4 Press  $\leftarrow$ ,  $\rightarrow$ ,  $\nabla$  or  $\triangle$  to select the desired image, then press the MULTI button.
  - The selected image is displayed in full-screen.

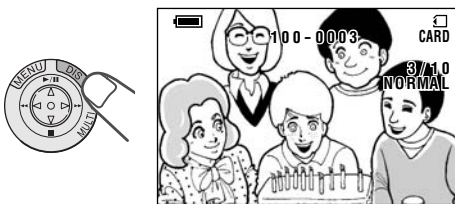
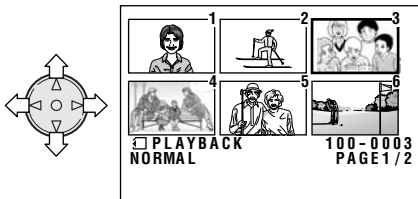

- 5 Press the REC START/STOP button.
  - The camcorder enters Recording Standby mode.

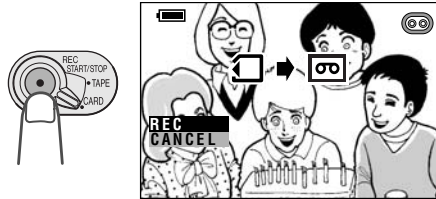

- 6 Press  $\nabla$  or  $\triangle$  to select "REC", then press the SET button to begin copying the image to the tape.
- 7 Press the SET button to stop copying.
- 8 Press  $\nabla$  or  $\triangle$  to select "CANCEL", then press the SET button to cancel Recording Standby mode.

## Digital Still Camera Features Playback

### Print Order

**Available mode:**  
CARD-VCR

The print order function allows you to add print information called DPOF to still images recorded on a card.

#### About DPOF

DPOF (Digital Printing Order Format) defines the print information for the specific images and number of each image on memory cards. In the near future you will be able to easily make prints on a DPOF-compatible printer or order copies at your local print shop.

#### Note:

- You can print an image even if no print order has been assigned.

#### Assigning Print Order to an Image

- In CARD-VCR mode, press the MENU button until the menu screen appears.
- Press  $\nabla$  or  $\Delta$  on the operation button to select  $\square$ , then press the SET button.
- Press  $\nabla$  or  $\Delta$  to select "PRI. ORDER", then press the SET button.

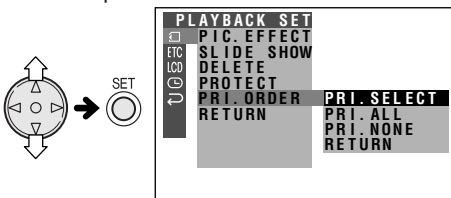

- Press  $\nabla$  or  $\Delta$  to select "PRI. SELECT", then press the SET button to display a thumbnail of the recorded images.

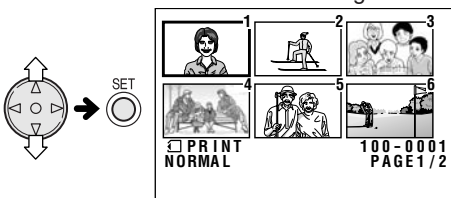

- Press  $\triangleleft$ ,  $\triangleright$ ,  $\nabla$  or  $\Delta$  to select the image to which you want to assign a print order.

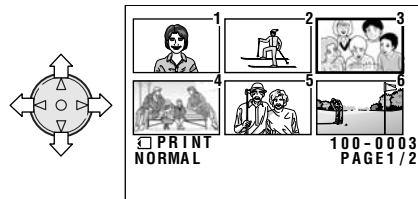

- Press the SET button, then press  $\nabla$  or  $\Delta$  to select the number of printouts.
  - 1 through 99 can be set for the number of printouts.

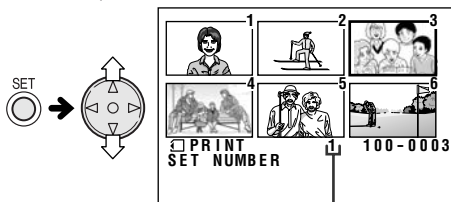

Number of printouts

- Press the SET button to set the print order.
  - The  $\blacksquare$  indicator appears.

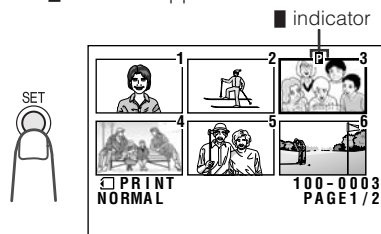

- If you want to assign another print order, repeat steps 5 to 7.

- Press the MENU button to display a thumbnail of images.

### To cancel the print order for an image

- 1 Select the image for cancelling out of print order in step 5 above, then press the SET button.
- 2 Press  $\nabla$  to select "0", then press the SET button.
  - The ■ indicator disappears.

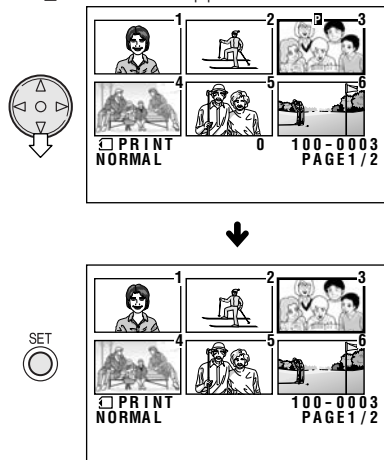

- 3 Press the MENU button to display a thumbnail of images.

### Assigning Print Order to All Images

- 1 Perform steps 1 to 3 in "Assigning Print Order to an Image".
- 2 Press  $\nabla$  or  $\Delta$  to select "PRI. ALL", then press the SET button.

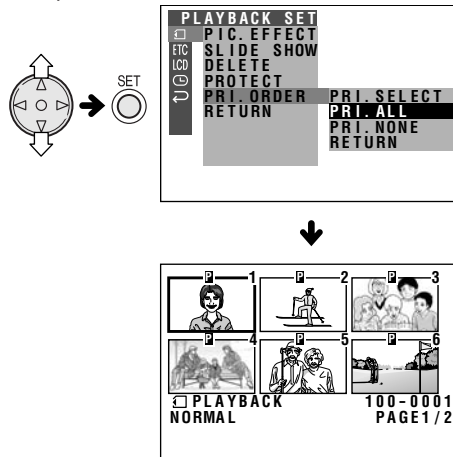

### To cancel the print order for all images

- 1 Perform steps 1 to 3 in "Assigning Print Order to an Image".
- 2 Press  $\nabla$  or  $\Delta$  to select "PRI. NONE", then press the SET button to cancel the print order for all images.
  - The ■ indicators are turned off.

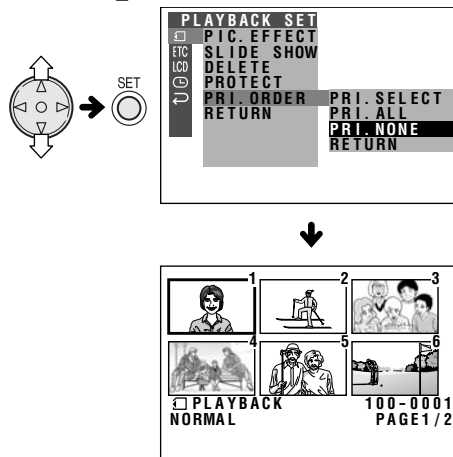

## Digital Still Camera Features Playback

### Transferring Data on Card to Computer

Using a commercially available PC card adapter for each card type, you can transfer still images directly from a card to a computer.

### Image Folders and File Names

Still images recorded using the camcorder are stored on a card as shown below.

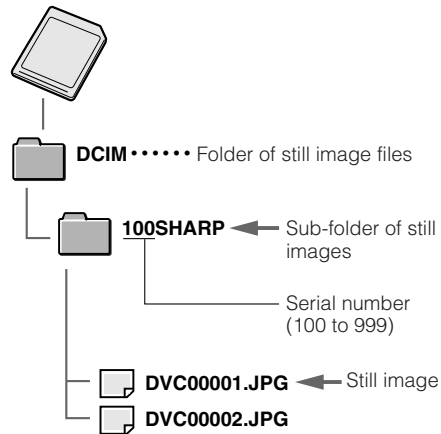

### Using a PC Card Adapter (Commercially Available)

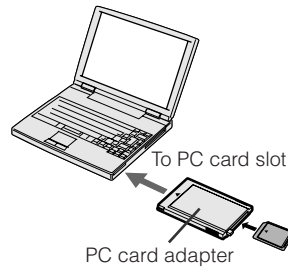

#### Notes:

- For details, see the operation manuals of the computer and PC card adapter.
- If you copy any data incompatible with this camcorder to the card, the camcorder will not be able to recognize it.

# Appendix

## Picture/Backlight Adjustments

**Available modes:**  
All modes

If the picture is difficult to see due to ambient light or other factors, adjust the monitor picture settings.

- The example screens shown are for TAPE-CAMERA mode.

### Adjusting the Picture

- Press the MENU button until the menu screen appears.
- Press  $\nabla$  or  $\Delta$  on the operation button to select LCD, then press the SET button.

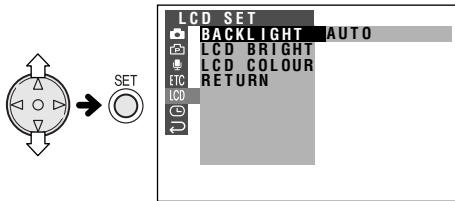

- Press  $\nabla$  or  $\Delta$  to select "LCD BRIGHT" or "LCD COLOUR", then press the SET button.
- Press  $\nabla$  or  $\Delta$  to adjust the item to the desired setting.

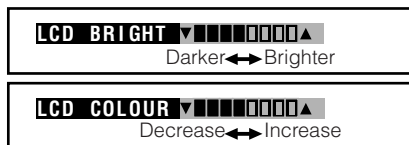

- Press the SET button, then press the MENU button to turn off the menu screen.

**Note:**

- When adjusting the colour, the picture on the LCD monitor may differ from the picture actually recorded. Do not change the colour setting unless necessary. (This adjustment only affects the monitor picture, not the recorded image.)

### Adjusting the Backlight

- Press the MENU button until the menu screen appears.
- Press  $\nabla$  or  $\Delta$  on the operation button to select LCD, then press the SET button.
- Press  $\nabla$  or  $\Delta$  to select "BACKLIGHT", then press the SET button.

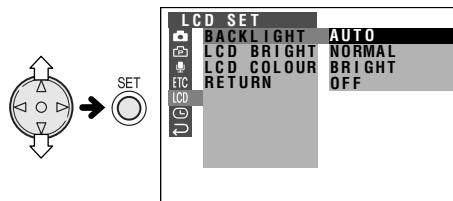

- Press  $\nabla$  or  $\Delta$  to select "AUTO", "NORMAL", "BRIGHT" or "OFF", then press the SET button.

### BACKLIGHT BRIGHT

**AUTO:** The camcorder automatically switches between "NORMAL" and "BRIGHT" depending on the ambient light. This mode is only available in TAPE-CAMERA or CARD-CAMERA mode.

**NORMAL:** For use indoors or under moderate lighting conditions.

**BRIGHT:** For use outdoors under strong lighting conditions, such as bright daylight.

**OFF:** The backlight turns off. To turn it on again, press any button on the camcorder in CAMERA modes, or press any button other than operation button and Volume control in VCR modes.

- Press the MENU button to turn off the menu screen.

## Appendix

### World Clock

#### Available modes:

TAPE-CAMERA, CARD-CAMERA

The world clock function allows you to easily adjust the clock to the local time when you use the camcorder while travelling anywhere around the world.

- Set the area, date and time for your local time zone if not already set (see page 16).

**Example:** Changing the clock from Paris time to London time.

- 1 In TAPE-CAMERA or CARD-CAMERA mode, press the MENU button until the menu screen appears.
- 2 Press  $\nabla$  or  $\Delta$  on the operation button to select  $\square$ , then press the SET button.

- 3 Press  $\nabla$  or  $\Delta$  to select "AREA", then press the SET button.

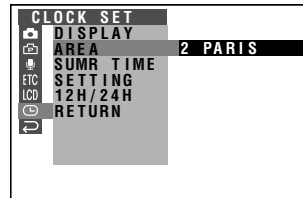
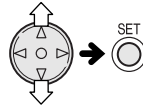

- 4 Press  $\nabla$  or  $\Delta$  to select "1 LONDON", then press the SET button.
  - The camcorder is now set to London time.

**AREA 1 LONDON**

- 5 Press the MENU button to turn off the menu screen.

### Time Zone Chart

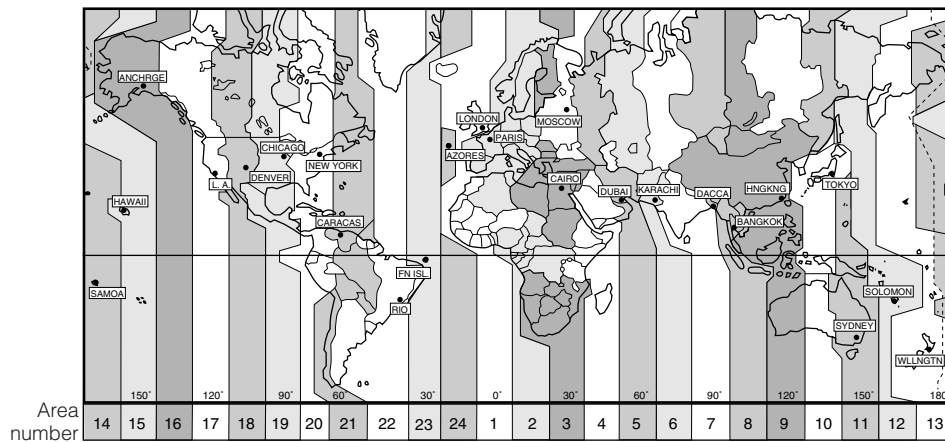



## Area Table

Area number	Area name	Countries or areas*
1	LONDON	England, Morocco, GMT (Greenwich mean time)
2	PARIS	Austria, France, Germany, Italy, Netherlands, Spain, Sweden, Switzerland, Portugal, CST (Continental Standard Time), Tunisia
3	CAIRO	Egypt, Finland, Greece, Turkey
4	MOSCOW	Ethiopia, Iraq, Kenya, Mauritius, Saudi Arabia, Seychelles, Russia (Moscow)
5	DUBAI	United Arab Emirates
6	KARACHI	Maldives, Pakistan
7	DACCA	Bangladesh, India, Myanmar
8	BANGKOK	Cambodia, Indonesia (Jakarta), Thailand, Vietnam
9	HNGKNG	Australia (Perth), China, Hong Kong, Indonesia (Borneo, Bali), Malaysia, Philippines, Singapore, Taiwan
10	TOKYO	Japan, Korea
11	SYDNEY	Australia (Sydney)
12	SOLOMON	New Caledonia
13	WLLNGTN	Fiji, New Zealand
14	SAMOA	Western Samoa
15	HAWAII	U.S.A. (Hawaii), Tahiti, HST (Hawaii Standard Time)
16	ANCHRGE	U.S.A. (Alaska), AST (Alaska Standard Time)
17	L.A.	U.S.A. (Los Angeles, San Francisco), PST (Pacific Standard Time)
18	DENVER	U.S.A. (Denver), MST (Mountain Standard Time)
19	CHICAGO	Mexico (Mexico City), U.S.A. (Chicago), CST (Central Standard Time)
20	NEW YORK	Canada (Montreal), Jamaica, Peru, U.S.A. (New York, Washington D.C.), EST (Eastern Standard Time)
21	CARACAS	Chile, Dominican Republic, Venezuela
22	RIO	Argentina, Brazil, Uruguay
23	FN ISL.	Fernando de Noronha
24	AZORES	Azores Islands

\*These are commonly used names. Official names may vary.

## Appendix

### Selecting Summer Time

#### Available modes:

TAPE-CAMERA, CARD-CAMERA

Perform the procedure below to advance the clock of the camcorder one hour to summer time.

- 1 In TAPE-CAMERA or CARD-CAMERA mode, press the MENU button until the menu screen appears.
- 2 Press  $\nabla$  or  $\Delta$  on the operation button to select  $\text{CLOCK SET}$ , then press the SET button.
- 3 Press  $\nabla$  or  $\Delta$  to select "SUMR TIME", then press the SET button.

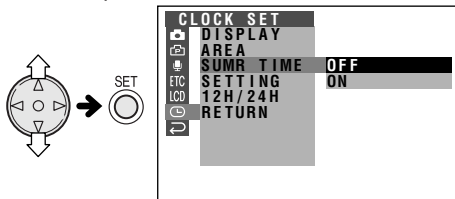

- 4 Press  $\nabla$  or  $\Delta$  to select "ON", then press the SET button.
  - The time automatically changes to summer time.

**SUMR TIME ON**

- 5 Press the MENU button to turn off the menu screen.
  - The  $\odot$  indicator appears when the date/time is displayed.

#### To reset to standard time

Select "OFF" in step 4 above.

### Setting the Confirmation Sounds

#### Available modes:

All modes

A confirmation sound is made when you turn on or off the Power switch, press the REC START/STOP button, or perform other designated operations. Use the procedure below to change the type of sound or to turn off the confirmation sounds altogether.

#### Types of Confirmation Sound Settings

**CHIME:** Chiming sound

**BEEP:** Electronic beeping sound

**OFF:** No confirmation sound

- 1 Press the MENU button until the menu screen appears.
- 2 Press  $\nabla$  or  $\Delta$  on the operation button to select ETC, then press the SET button.
- 3 Press  $\nabla$  or  $\Delta$  to select "SOUND", then press the SET button.

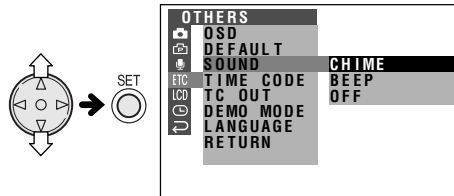

- 4 Press  $\nabla$  or  $\Delta$  to select the desired sound setting, then press the SET button.

**SOUND BEEP**

- 5 Press the MENU button to turn off the menu screen.

#### Note:

- If you select "OFF", the sounds will turn off including:
  - Shutter closing sound in PHOTO SHOT mode and CARD-CAMERA mode
  - Focus confirmation sound in CARD-CAMERA mode

## Setting the Camcorder to Factory Presettings

### Available modes:

All modes

You can set the camcorder to the factory presettings in one operation.

- 1 Press the MENU button until the menu screen appears.
- 2 Press  $\nabla$  or  $\Delta$  on the operation button to select ETC, then press the SET button.
- 3 Press  $\nabla$  or  $\Delta$  to select "DEFAULT", then press the SET button.

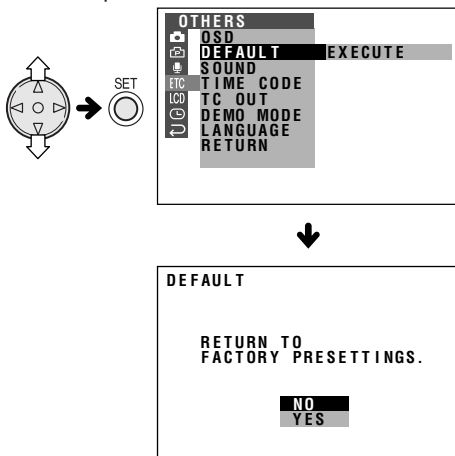

- 4 Press  $\nabla$  or  $\Delta$  to select "YES", then press the SET button.
  - To cancel, press  $\nabla$  or  $\Delta$  to select "NO", then press the SET button.
- 5 Press the MENU button to turn off the menu screen.

### Note:

- Even when you perform the steps above, the on-screen display language setting and clock setting maintain the memory.

**Useful Information**

**Hints for Better Shooting**

- Position the subject in the centre of the scene. When using auto focus, whatever is in the centre of the scene is kept in focus.



Position the subject in the centre.



Focus manually when you need to position the subject off centre (see pages 53 and 54).

- Avoid backlit subjects. For the best picture, shoot with the light source behind you. When the background is brighter than the subject, the subject often becomes too dark. If you have to record in this lighting, use Gamma Brightness Compensation or correct the exposure level to improve the picture (see pages 31 and 56).

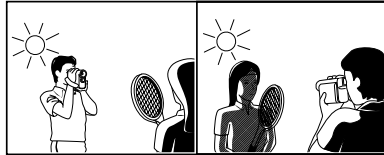

Light from behind

Backlighting

- Before zooming, think about how to best frame the shot. Frequent zooming produces unattractive pictures. It also runs down the battery more quickly.
- When image shaking is noticeable during zoomed-in telephoto shooting, use a tripod or push the Power Zoom control to the W side to zoom out.
- Horizontal panning (lateral movement) and tilting (vertical movement) should be done slowly to emphasize the wide expanse of a scene or the height of a building, and to make scenes easy to watch during playback.
- Use a wide-angle setting for fast-moving subjects.

**Note:**

- It may take longer to focus when zooming and panning are used frequently.

**Lighting**

For clear, good-quality recording, 500 to 100,000 lux is needed. Recording is possible with less light, but the picture quality may suffer. Adequate lighting is also essential for correct white balance.

Brightness (Lux)	Situation (Lux)
100,000	Blue sky Clear day at noon (100,000)
10,000	Clear day at 10 am (65,000) Clear day at 3 pm (35,000) Cloudy day at noon (32,000) Cloudy day at 10 am (25,000)
1,000	Cloudy day, one hour after sunrise (2,000) Clear day, one hour before sunset (1,000) Fluorescent light near window (1,000)
100	Factory floor (700–800) Sales counter in department store (500–700) Bowling alley (500) Library (400–500) Office with fluorescent lighting (400–500) Fluorescent desk lamp (400) Flashlight at 1 m (250) Shop stairway (100)
10	During intermission at movie theatre (15–35) Cigarette lighter at 30 cm (15–20) Candles on birthday cake at 20 cm (10–15) Candlelight

Optimal lighting range

**Note:**

- The figures in the chart are approximations.

**Tips on good lighting**

In most outdoor, daytime scenes, natural lighting is adequate for home videos. Indoors, however, artificial lighting is usually required. Video lights with halogen lamps provide the most natural artificial light over a long operating life.

## DV Technology

Digital video (DV) is a revolutionary technology that enables recording and playback of high quality images with the use of special digital features previously unavailable with conventional analog formats.

### DV and conventional video cassette tapes

There are two kinds of DV-format video cassette tapes: the Mini DV cassette and the larger DV cassette used for extended playback and recording. This camcorder only operates with Mini DV cassettes. DV cassettes cannot be used. Be sure to use Mini DV cassettes with the <sup>Mini</sup>DV mark.

Mini DV cassette

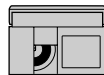

DV cassette

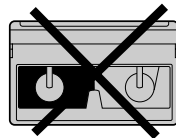

8 mm, VHS, and Beta cassettes cannot be used for playback or recording with this camcorder.

8 mm cassette



VHS cassette



Beta cassette



#### Note:

- This camcorder reproduces the highest picture quality when used with an ME tape. It is recommended you use an ME tape for high-quality recording and playback.

This product incorporates copyright protection technology that is protected by method claims of certain U.S. patents and other intellectual property rights owned by Macrovision Corporation and other rights owners. Use of this copyright protection technology must be authorized by Macrovision Corporation, and is intended for home and other limited viewing uses only unless otherwise authorized by Macrovision Corporation. Reverse engineering or disassembly is prohibited.

## SD Memory Card and MultiMediaCard

SD Memory card and MultiMediaCard are compact recording media just 32 mm long and 24 mm wide which support the needs of the digital network society where music, images, games and various other provider services are offered.

- You can use an SD Memory Card (commercially available) and a MultiMediaCard (only supplied with VL-NZ10) for storing still images with this camcorder, not a SmartMedia™ card or Memory Stick™ media.

SD Memory Card

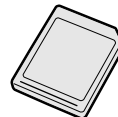

MultiMediaCard



SmartMedia™ card



Memory Stick™ media

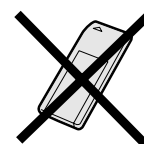

- An SD Memory Card is superior to a MultiMediaCard in terms of copyright protection functions and high speed transfer.
- The SD Memory Card is compatible with MultiMediaCard, and data stored on MultiMediaCard can be used with the SD Memory Card.

#### Note:

- This camcorder is verified to work with the following card types and capacities.
  - SD Memory Card: 128 MB or less
  - MultiMediaCard: 64 MB or less

## Appendix

### Mini DV Cassette

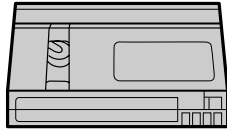

#### Precautions when using a Mini DV cassette

- Be sure to use only Mini DV cassettes with the **Mini DV** mark.
- This camcorder can record and play back using Mini DV cassettes with cassette memory, but it cannot record or play back this memory.
- To record in LP mode, use a Mini DV cassette labelled for use with LP mode.
- Do not insert anything into the holes on the bottom of the Mini DV cassette or block them in any way.
- Avoid placing the Mini DV cassette in an area conducive to dust or mold.
- Do not place the Mini DV cassette near magnetic sources such as electric clocks or magnetic devices as this may adversely affect recorded material.
- When a previously recorded Mini DV cassette is used again for recording, the previously recorded material will be automatically erased.
- The Mini DV cassette will not operate if inserted in the wrong direction.
- Do not repeatedly insert and eject the Mini DV cassette without running the tape as this may cause uneven tape winding and damage the tape.
- Do not place the Mini DV cassette in direct sunlight, near strong heat sources, or in areas with excessive steam.
- Store the Mini DV cassette in its case and stand it in an upright position.
- If the tape is not properly wound, rewind the tape.
- Do not drop the Mini DV cassette or subject it to excessive shocks.

#### To protect recordings against accidental erasure

Slide the protect tab on the rear of the Mini DV cassette to the "SAVE" position.

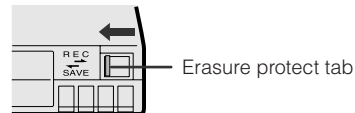

To record over a previously recorded tape, slide the protect tab to the "REC" position.



#### Copyright Protection (VL-NZ10 Only)

The digital VCR has far superior recording and playback ability than the traditional analog VCR, and in order to protect digital video software copyrights, a system for managing copyrights has been established. Some digital video recording with pre-recorded copyright protection signals can still be played back on this camcorder. If you play a digital video recording that has a copyright protection signal on video equipment with a DV terminal and attempt to record a copy of that software on this camcorder, "COPYRIGHT PROTECTED." appears on the screen and the recording is disabled.

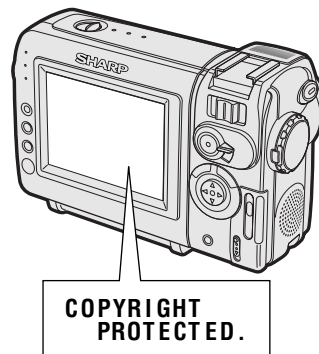

## MultiMediaCard

Improper handling of the MultiMediaCard may cause damage to the card or images on the card. Follow the instructions below for correct use.

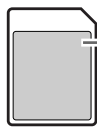

### Label

- Do not peel off the label or paste any paper, tape, or other material over it.

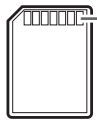

### Contacts

- This is the part of the card that makes contact with other equipment. Do not touch with your fingers, scratch, smudge or damage in any way.

## Precautions on handling MultiMediaCards

- Be sure to insert the card in the correct direction. Do not try to force the card in.
- The card is a precision component. Do not disassemble or modify it in any way. Take care not to bend it, subject it to severe shock, drop it, or allow it to get wet.
- Do not put the card in your pocket or other unprotected location as it may break due to pressure applied when you sit.
- Do not expose the card to excessive heat or fire.

## Do not use or store the MultiMediaCard in the following kinds of environment:

- Locations subject to electrical noise or powerful magnetic fields. Data on the card may be destroyed (erased).
- Locations exposed to direct sunlight.
- Locations subject to high temperature or high humidity.
- Locations where dust gathers in large amounts or blows through the air.
- Corrosive environments.
- Sunlit or enclosed spaces and other such locations subject to high temperature.

## Watch out for static electricity

- Do not let dirt or other foreign matter accumulate on the card contacts, or touch them with your fingers, or rub or scrape them. Static electricity may damage (erase) data on the card. Clean the card by wiping it gently with a soft, dry cloth.
- Carry and store the card in its original plastic case to protect it from dirt, grime and static electricity. (The polyethylene case is anti-static.)

## Watch out for condensation

- Moisture (condensation) may form inside and outside the card if it is carried into an area subject to sudden, large changes in temperature. Watch out for condensation, because it can cause malfunctions.
- When moisture condenses on the card, leave it at the prevailing temperature until the water evaporates naturally.

## Your image data

- It is best to copy your valuable image data from the card onto some other medium (personal computer, floppy disk, MO disk, etc.) and make a backup.  
Malfunction, repair, and so on can cause the recorded images to disappear from the card.
- Make absolutely sure not to remove the card or turn the camcorder power off while the card is recording data, erasing data, or formatting (initializing). This can cause loss of data and damage the card.
- Initializing the card will erase the data on it. Make sure no important image data is recorded on the card before you initialize it.
- Please be aware that Sharp Corporation will not be liable for any damages resulting from loss of data caused by incorrect handling of the card by you or a third party, or caused by exposure to static electricity or electrical noise or by malfunction.

## Appendix

### SD Memory Card

#### Precautions on handling SD Memory Cards

- After removing the card from the camcorder, be sure to immediately store it in the card case.
- Do not disassemble or modify the card.
- Do not strike, bend, drop, or allow the card to become wet.
- Do not touch the metal terminals with your hands or metallic objects.
- Do not peel off the label from the card.
- Do not attach other labels or stickers to the card.
- Do not use or store the card in locations directly exposed to sunlight, heat vents, heating appliances, or other locations with extremely high temperatures such as inside a closed vehicle in the summer.
- Do not use or store the card in humid or dusty locations.
- Do not use or store the card in locations exposed to corrosive gases.

#### Protecting your data

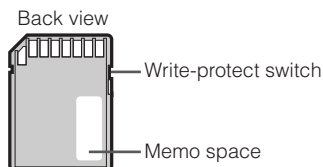

- Set the write-protect switch to "LOCK". Set the switch to the unlocked side when you want to record or edit the card again.
- Use an oil-based felt-tipped pen to write in the memo space. Do not use a pencil or ballpoint pen as these may damage the card or destroy the data on the card.
- Do not remove the card or turn off the power of the camcorder and peripheral equipment while data is being read or written. Also do not remove the power source from the camcorder. These actions can cause data to be destroyed. (Please be aware that Sharp Corporation cannot be held liable for any data loss or other loss directly or indirectly caused by data loss.)
- Make backup copies of your data wherever possible.

### AC Adapter/Battery Charger

- The AC adapter/battery charger may interfere with reception if used near a radio.
- Prevent flammables, liquids, and metal objects from entering the adapter/charger.
- The adapter/charger is a sealed unit. Do not attempt to open or modify it.
- Do not damage, drop, or subject the adapter/charger to vibration.
- Do not leave the adapter/charger in direct sunlight.
- Avoid using the adapter/charger in humid or extremely hot places.

### Replacing the Fluorescent Lamp

This camcorder uses a fluorescent lamp to backlight the LCD monitor. If the monitor becomes dark or difficult to view, the fluorescent lamp may need to be replaced. Contact the nearest SHARP service centre or your dealer for further advice.

### Battery Pack

This camcorder uses a lithium-ion type battery pack.

#### Charging

- Charge the battery pack immediately (or a day) before use. The battery pack gradually self-discharges even if stored in a fully charged state.
- Charge the battery pack between 10°C and 30°C.
- Fully charge the battery pack. Use of an insufficiently charged battery pack will shorten actual time of use.
- Refresh (discharging before charging) is unnecessary.



## Use

- To conserve battery power, be sure to turn off the camcorder power when not in use.
- Battery consumption may vary depending on the condition of use. Recording with many starts and stops, frequent zooming, and recording in low temperatures will shorten actual recording times.
- Use of a weak battery pack may cause loss of power while operating the camcorder. Use a fully charged battery pack to protect both the battery pack and the unit.
- It is recommended that you have enough battery packs on hand to handle two or three times your estimated recording time. See page 20 for the approximate times of actual recording for the battery packs.

Battery power is consumed even when the camcorder power is turned off. If you are not going to use your camcorder immediately, remove the battery pack (see page 10).

### Note:

- Use only SHARP BT-L225 or BT-L445 battery packs. These are designed specifically for use with this camcorder.

## Extending battery pack life

Even when the battery pack is not used, the capacity of the battery pack will naturally deteriorate over time. To limit the deterioration of the capacity, it is recommended to perform the following procedure at least once every six months:

- ① Charge the battery pack until the CHARGE indicator of the charger turns off.
- ② Attach the battery pack to the camcorder, and set the Power switch to CAMERA without inserting a cassette. Allow the battery power to fully discharge by leaving it on the camcorder until the camcorder power automatically turns off.
- ③ Remove the battery pack and store it between 10°C and 20°C.

## Storage

- Store the battery pack in a fully discharged state.
- Store the battery pack in a dry, cool place.
- When storing a fully charged battery pack, put the cover on it so that the "CHARGE" mark printed on the label is seen through the window, as shown.

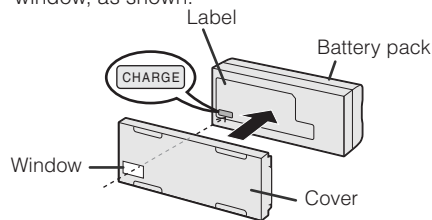

When storing a battery pack that is not fully charged, put the cover upside down so that only the battery pack casing can be seen through the window.

### Cautions:

- Improper handling of the battery pack may present a risk of fire or explosion. Pay close attention to the following:
  - Do not allow metallic objects to come in contact with the terminals. This can cause a short circuit.
  - Do not disassemble or repair the battery pack by yourself.
  - Do not use any battery charging equipment other than that designed for use with these battery packs.
  - Do not place the battery pack under direct sunlight or in excessively hot places (over 60°C) such as the dashboard of cars.
  - Do not expose the battery pack to moisture or water.
  - Do not drop the battery pack or subject it to strong force.
  - Keep the battery pack out of reach of children.
  - Dispose of used battery packs promptly. Do not dispose of them in fire.
- To protect the terminals, put the cover on the battery pack when it is not in use.

### Notes:

- The battery pack will become warm during charging and use. This is not a malfunction.
- The battery pack has a limited service life. If the period of use becomes noticeably shorter with a normal charge, the battery pack is at the end of its service life. Replace it with a new battery pack.
- If the terminals of the battery pack are dirty, wipe the terminals with a soft, dry cloth.

## Appendix

---

### Cleaning

- Many plastic parts are used in the camcorder casing. Do not use thinner, benzene or other strong chemical cleaners. These may cause discolouration and damage to the casing.
- Clean the casing with a soft, dry cloth. If the casing is particularly dirty, wipe the casing with a tightly wrung cloth dampened with a diluted, neutral detergent. Then wipe it again with a soft, dry cloth.
- Use a soft cloth to wipe finger marks and other smudges off the LCD screen.
- Use a soft cloth, or compressed air and lens paper designed for photographic lenses to clean the lens.

### Using Your Camcorder Abroad

Television signal standards and electrical voltages and frequencies vary substantially from country to country. When you are abroad, check the sections below before using the AC adapter/battery charger or connecting the camcorder to a TV.

#### AC Adapter/Battery Charger (Supplied Accessory)

The supplied AC adapter/battery charger is compatible with 50 Hz and 60 Hz electrical systems in the range of 110 V to 240 V AC.

#### Television Signal Standards

In any country, you can always watch the video picture by using the LCD monitor screen. However, if you want to watch the picture on a TV screen, the TV must be PAL system compatible. PAL is used in the following areas: Germany, Great Britain, Sweden, Denmark, Austria, Belgium, Switzerland, Italy, Spain, Holland, Finland, Portugal, Norway, Hong Kong, Thailand, Australia, New Zealand, Singapore, Kuwait, China, etc.

## Demonstration Mode

### Available modes:

TAPE-CAMERA, CARD-CAMERA

You can watch a brief demonstration of the special camcorder features in Demo mode. If the demonstration appears on the screen when you turn on the camcorder for the first time, cancel the Demo mode to use your camcorder.

### Note:

- The demonstration is only displayed in English.

### Watching the Demonstration

- 1 Remove the Mini DV cassette from the camcorder (see page 12).
- 2 In TAPE-CAMERA or CARD-CAMERA mode, press the MENU button until the menu screen appears.
- 3 Press  $\nabla$  or  $\Delta$  on the operation button to select ETC, then press the SET button.
- 4 Press  $\nabla$  or  $\Delta$  to select "DEMO MODE", then press the SET button.

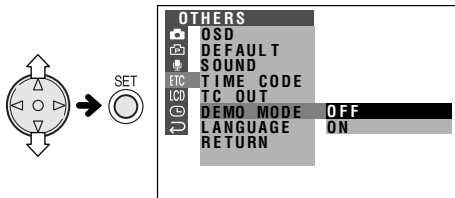

- 5 Press  $\nabla$  or  $\Delta$  to select "ON", then press the SET button.

**DEMO MODE ON**

- 6 Set the Power switch to OFF, then hold down the Lock button and set the Power switch to CAMERA.
  - The demonstration begins.

## Cancelling Demo Mode

- 1 During the demonstration, press the MENU button to pause the demonstration.
- 2 Press  $\nabla$  or  $\Delta$  on the operation button to select ETC, then press the SET button.
- 3 Press  $\nabla$  or  $\Delta$  to select "DEMO MODE", then press the SET button.

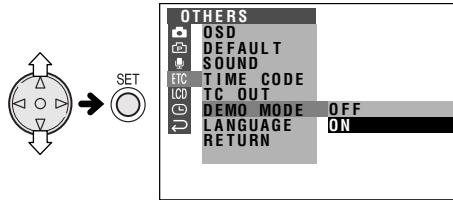

- 4 Press  $\nabla$  or  $\Delta$  to select "OFF", then press the SET button.

**DEMO MODE OFF**

- 5 Press the MENU button to turn off the menu screen.

### Note:

- The demonstration will pause if you press the MENU button. If you leave it for 60 seconds, or turn the power off temporarily and then set the Power switch to CAMERA, the demonstration will begin again.

## Appendix

### Before Requesting Service

Before calling for service, please check the following troubleshooting table.

	Symptom	Possible cause	Suggested solution
Power	No power.	Power source is not properly connected.	Connect power source properly (pp. 10, 11).
		Battery pack is not charged.	Charge battery pack sufficiently (p. 9).
		Dew in camcorder.	Wait until dew dries (p. viii).
		Safety function is in effect.	Set Power switch to OFF and remove battery pack. Wait for 2 seconds, then reinstall battery pack and turn on power (p. 10).
CAMERA mode	REC START/STOP button does not work.	Erasure-protect tab on video cassette is open.	Close tab or use a new cassette (p. 87).
	Power suddenly turns off.	Camcorder left in Recording Standby mode for 5 minutes in TAPE-CAMERA mode.	Set Power switch to OFF and then back to CAMERA.
	Auto focus does not work.	Manual Focus mode is engaged.	Set to Auto Focus mode (p. 53).
		Zoom used on close subject.	Zoom out from subject (p. 21).
		Subject has little contrast in brightness, or is full of horizontal or vertical stripes.	Focus manually (p. 53).
	Bright subject produces wide vertical lines.	Occurs when shooting subject with strong contrast to the background. Does not indicate a malfunction.	—
	Automatically zooms out without operating Zoom control.	Camcorder is unable to focus when zooming in on subject within 1.5 m, and automatically zooms out until it focuses on subject.	—
		No subject in the field of view.	Direct lens to some subject, or set zoom to widest angle before shooting (p. 21).
Display automatically changes in TAPE-CAMERA mode.	Camcorder is in Demo mode.	Set DEMO MODE menu item to "OFF" (p. 92).	
VCR mode	No image appears on connected TV screen.	Video input channel on TV or TV channel is not selected properly.	Select video input channel or TV channel properly (p. 25).
		Audio/video/S-video cable is not properly connected.	Connect audio/video/S-video cable properly (p. 25).
	No image from an external source appears on the camcorder screen. (VL-NZ10 only)	DV cable is not properly connected.	Connect DV cable properly. (p. 61)

	Symptom	Possible cause	Suggested solution
VCR mode	Cannot rewind or fast forward tape.	Position at beginning or end of tape.	Rewind or fast forward tape to desired point (p. 23).
	Video noise in image.	Dirty video heads.	Call for service or use a commercially available cleaning tape (p. ix).
		Old or worn tape.	Use a new cassette.
CARD mode	Cannot delete image on card.	Image is delete-protected.	Cancel the protection setting (p. 72).
	Cannot format card.	—	Contact your dealer for advise.
General	Cassette will not eject.	Power source is not properly connected.	Connect power source properly (pp. 10, 11).
		Battery pack is not charged.	Charge battery pack sufficiently (p. 9).
		Camcorder is recording.	Stop tape and try again (p. 20).
	No image on monitor.	Backlight has been turned off.	Turn on backlight (p. 80).
		Fluorescent lamp has burned out.	Call for service.
	Monitor picture is hard to see.	Inappropriate picture adjustments.	Adjust picture (p. 80).
	CHARGE indicator flashes in red when charging battery pack.	AC adapter or battery pack may have malfunctioned.	Call for service.
	Cannot edit to connected VCR.	Audio/video/S-video cable is not properly connected.	Connect audio/video/S-video cable properly (p. 60).
	Remote control does not function. (VL-NZ10 only)	REMOTE menu item is set to "OFF".	Set REMOTE menu item to "ON" (p. 42).
		Remote control battery has run down.	Replace remote control battery with new one (p. 14).
		Remote control used beyond operating range.	Use remote control within operating range (p. 42).
		Intense daylight falling on camcorder remote sensor.	Protect remote sensor from exposure to intense daylight (p. 42).
Obstacle between remote control and camcorder remote sensor.		Remove obstacle or use remote control from different angle (p. 42).	

**Notes:**

- This unit is equipped with a microprocessor. Its performance could be adversely affected by external electrical noise or interference. If this should happen, turn off the power and disconnect the unit from any power sources, including the lithium battery, etc. Then reconnect the power sources to resume operation.
- If the characters displayed on the monitor screen appear to malfunction, disconnect the power source and remove the lithium battery, then reconnect the power source, insert the lithium battery, and turn the power on again. The characters on the monitor should be normal. Set the date and time, then resume operation.

## Appendix

### Specifications

#### Camcorder

Signal System:	PAL standard
Recording System:	2 rotary heads, helical scanning system
Cassette:	Digital VCR Mini DV video cassette
Recording/Playback Time:	90 minutes (DVM60, LP mode)
Tape Speed:	SP mode: 18.831 mm/second LP mode: 12.568 mm/second
Pickup Device:	1/4" (6.4 mm, effective size: 4.5 mm) CCD image sensor (with approx. 800,000 pixels including optical black)
Lens:	10× optical/300× digital power zoom lens (F1.8, f=3.6–36.0 mm), full-range auto focus
Lens Filter Diameter:	27 mm
Monitor:	3" (7.5 cm) full-colour LCD screen (TFT active matrix)
Microphone:	Electret stereo microphone
Colour Temperature Compensation:	Auto white balance with white balance lock, outdoor or indoor
Minimum Illumination:	1 lux* (with gain-up, F1.8)
Still Image Compression System:	JPEG base line conformance
Still Image Recording Format:	JPEG (Exif2.1)
Still Image Recording Medium:	SD Memory Card, MultiMediaCard
Power Requirement:	DC 7.4 V
Power Consumption:	4.5 W (during camera recording in Full Auto mode with zoom motor off and backlight in normal mode)
Operating Temperature:	0°C to +40°C
Operating Humidity:	30% to 80%
Storage Temperature:	–20°C to +60°C
Dimensions (approx.):	136.1 mm (W) × 86.3 mm (H) × 58.6 mm (D)
Weight (approx.):	455 g (without battery pack, lithium battery, video cassette, lens cap, lens hood, hand strap, shoulder strap and card)

#### AC Adapter/Battery Charger (UADP-0334TAZZ)

Power Requirement:	AC 110–240 V, 50/60 Hz
DC Output:	7.8 V
Power Consumption:	23 W
Dimensions (approx.):	70 mm (W) × 43.5 mm (H) × 113 mm (D)
Weight (approx.):	170 g

#### MultiMediaCard (Only supplied with VL-NZ10)

Memory Capacity:	8 MB
Power Requirement:	3 V
Operating Temperature:	0°C to +40°C
Storage Temperature:	–20°C to +65°C

Specifications are subject to change without notice.

\*Minimum illumination: Since there is no widely accepted testing procedure for determining minimum illumination capability, lux ratings are comparable only between models from the same manufacturer.

# SHARP CORPORATION

Tryckt i Japan  
Printed in Japan  
TINSL0297TAZZ Ⓐ  
01P09-JKG

## Free Manuals Download Website

<http://myh66.com>

<http://usermanuals.us>

<http://www.somanuals.com>

<http://www.4manuals.cc>

<http://www.manual-lib.com>

<http://www.404manual.com>

<http://www.luxmanual.com>

<http://aubethermostatmanual.com>

Golf course search by state

<http://golfingnear.com>

Email search by domain

<http://emailbydomain.com>

Auto manuals search

<http://auto.somanuals.com>

TV manuals search

<http://tv.somanuals.com>