

SHARP®

MODEL

LC-32PD5X

LC-37PD5X

LCD COLOUR TELEVISION

OPERATION MANUAL

AQUOS



DVB
Digital Video
Broadcasting

DOLBY
DIGITAL

HDMI
HIGH-DEFINITION MULTIMEDIA INTERFACE

LC-32PD5X LC-37PD5X

LCD COLOUR TELEVISION

OPERATION MANUAL

Dear SHARP customer

Thank you for your purchase of the SHARP LCD colour TV product. To ensure safety and many years of trouble-free operation of your product, please read the Important Safety Precautions carefully before using this product.

Contents

Dear SHARP customer	1	Basic adjustment settings	17
Contents	1	Menu operation buttons.....	17
Trademarks	2	On-Screen Display.....	17
Important Safety Precautions	3	Menu items (TV/DTV/INPUT1-2)	18
Supplied accessories	4	Menu items (HDMI)	18
Preparation	5	Auto installation	19
Inserting the batteries	5	Programme setup.....	19
Using the remote control unit.....	5	Auto search.....	19
Cautions regarding remote control unit.....	5	Manual setting for each channel.....	20
Attaching the stand.....	6	Search tuning	20
Setting the TV.....	7	Fine tuning.....	20
Basic connection	8	Colour system	21
Connecting to an antenna	8	Sound system (Broadcasting system)	21
Connecting to the AC outlet.....	8	Labelling channels	21
Setting the TV on the wall	9	Skipping channels	22
Removing the stand.....	9	Setting the child lock	22
Password setting for child lock		(for TV/DTV input mode) See page 36.	
Part names	10	Sort.....	22
TV (Front).....	10	Erase Programme	23
TV (Rear).....	11	AV MODE selection	24
Remote control unit	12	OPC (Optical Picture Control) setting	24
Watching TV	13	Picture adjustments	25
Turning on the power.....	13	Advanced	26
Turning off the power.....	13	Colour temperature	26
Simple button operations for changing		Black.....	26
channels.....	13	3D-Y/C	26
Using Flashback (⏮) on the remote		Monochrome	27
control unit	14	Film Mode	27
Using MPX on the remote control unit.....	14	I/P Setting	27
Simple button operation for changing		AV Mode selection.....	27
volume/sound	15	Audio adjustment.....	27
Sleep timer	15	Surround.....	28
Still image.....	15	Power Control	28
ANALOG/DTV/RADIO buttons.....	16		

Contents

Basic adjustment settings (Digital)	29
DTV input mode menu items.....	29
Selecting DTV mode	29
Programme Guide	30
Info	30
Favourite Programme List	30
Programme List	31
Favourite & Lock.....	31
Parental Rate.....	31
Installation	32
Auto Search.....	32
Manual Adjust.....	32
Quick Search.....	33
Reset Data.....	33
Video Setup.....	33
Digital Output.....	34
Multilingual.....	34
Time Setup	34
I-Plate Setup (Information Plate Setup).....	35
Information	35
S/W Update (SERVICE ONLY)	35
Useful adjustment settings	36
Password setting for child lock (for TV/DTV input mode)	36
Input Label.....	37
Image position	37
Wide Screen Signalling (WSS).....	38
Picture aspect ratio.....	38
WIDE mode	39
Audio Only.....	40
DNR (Digital Noise Reduction).....	40
HDMI Setup.....	40
Input Select	41
Colour system setting	41
Useful features	42
Teletext language setting	42
Teletext function	43
Using external equipment	45
Displaying an external equipment image	45
Displaying a DVD image (Example)	45
Connecting a VCR	45
Connecting a DVD player	46
Connecting a game console or camcorder	46
Connecting an HDTV tuner	47
Appendix	48
Troubleshooting.....	48
Troubleshooting (DTV)	48
RS-232C port specifications	49
Specifications	51
Optional accessory	51
Dimensional drawings	52

Trademarks

- Manufactured under license from Dolby Laboratories. “Dolby” and the double-D symbol are trademarks of Dolby Laboratories.

- “HDMI, the HDMI logo and High-Definition Multimedia Interface are trademarks or registered trademarks of HDMI Licensing LLC.”

Important Safety Precautions

- **Cleaning** — Unplug the AC cord from the AC outlet before cleaning the product. Use a damp cloth to clean the product. Do not use liquid cleaners or aerosol cleaners.



- **Water and moisture** — Do not use the product near water, such as bathtub, washbasin, kitchen sink, laundry tub, swimming pool and in a wet basement.



- **Do not place vases or any other water-filled containers on this product.** The water may spill onto the product causing fire or electric shock.



- **Stand** — Do not place the product on an unstable cart, stand, tripod or table. Doing so can cause the product to fall, resulting in serious personal injuries as well as damage to the product. Use only a cart, stand, tripod, bracket or table recommended by the manufacturer or sold with the product. When mounting the product on a wall, be sure to follow the manufacturer's instructions. Use only the mounting hardware recommended by the manufacturer.

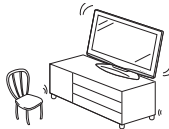

- **When relocating the product placed on a cart, it must be moved with utmost care.** Sudden stops, excessive force and uneven floor surface can cause the product to fall from the cart.



- **Ventilation** — The vents and other openings in the cabinet are designed for ventilation. Do not cover or block these vents and openings since insufficient ventilation can cause overheating and/or shorten the life of the product. Do not place the product on a bed, sofa, rug or other similar surface, since they can block ventilation openings. This product is not designed for built-in installation; do not place the product in an enclosed place such as a bookcase or rack, unless proper ventilation is provided or the manufacturer's instructions are followed.



- The LCD panel used in this product is made of glass. Therefore, it can break when the product is struck forcefully or with a sharp object. If the LCD panel is broken, be careful not to be injured by broken glass.



- **Heat sources** — Keep the product away from heat sources such as radiators, heaters, stoves and other heat-generating products (including amplifiers).



- To prevent fire, never place any type of candle or naked flames on the top or near the TV set.

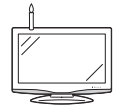

- To prevent fire or shock hazard, do not place the AC power cord under the TV set or other heavy items.



- Do not place heavy objects on this product or stand on it. Doing so could cause injury if the product overturns. Take special care near children and pets.

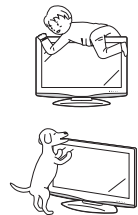

The LCD panel is a very high technology product with 3,147,264 thin film transistors, giving you fine picture details.

Due to the very large number of pixels, occasionally a few non-active pixels may appear on the screen as a fixed point of blue, green or red.

This is within product specifications and does not constitute a fault.

Precautions when transporting the TV

Be sure to always carry the TV by two people holding it with two hands — one hand on each side of the TV.

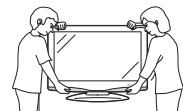





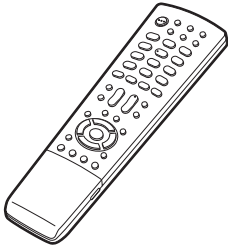

- Do not display a still picture for a long time, as this could cause an afterimage to remain.

- Install the product on the place where the AC cord can be unplugged easily from the AC outlet, or from the AC INPUT terminal on the rear of the product.

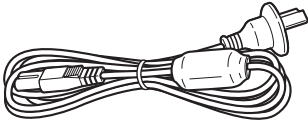
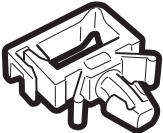
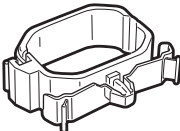
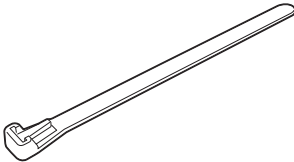
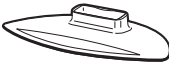
Supplied accessories

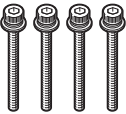
Make sure the following accessories are provided with the product.

Remote control unit	“AAA” size battery (× 2)	AC cord
 <p>Page 12</p>	 <p>Page 5</p>	 <p>Page 7</p>
AC cord clamp	Cable clamp	Cable tie
 <p>Page 7</p>	 <p>Page 7</p>	 <p>Page 7</p>
Stand unit		Operation manual
 <p>Stand base</p>  <p>Stand post</p>  <p>Short screws (× 4)</p>  <p>Long screws (× 4)</p>  <p>Hex key</p> <p>Page 6</p>		

NOTE

- Always use the AC cord supplied with the TV.
- The illustrations and on-screen displays in this operation manual are for explanation purposes and may vary slightly from the actual operations.
- The illustrations used throughout this manual are based on LC-37PD5X.

Preparation

Inserting the batteries

Before using the TV for the first time, insert two “AAA” size batteries (supplied). When the batteries become depleted and the remote control fails to operate, replace the batteries with new “AAA” size batteries.

1 Open the battery cover.

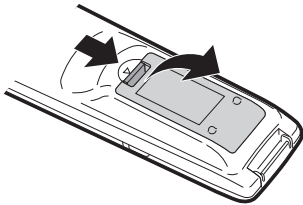

2 Insert two supplied “AAA” size batteries.

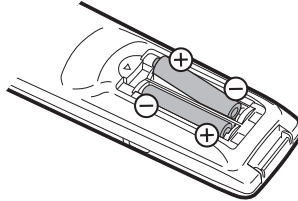

3 Close the battery cover.

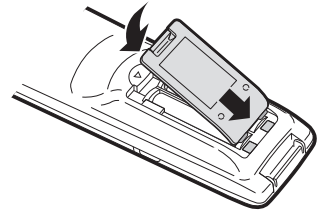

- Place batteries with their terminals corresponding to the (+) and (-) indications in the battery compartment.

CAUTION

Improper use of batteries can result in chemical leakage or explosion. Be sure to follow the instructions below.

- Do not mix batteries of different types. Different types of batteries have different characteristics.
- Do not mix old and new batteries. Mixing old and new batteries can shorten the life of new batteries or cause chemical leakage in old batteries.
- Remove batteries as soon as they have worn out. Chemicals that leak from batteries can cause a rash. If you find any chemical leakage, wipe thoroughly with a cloth.
- The batteries supplied with this product may have a shorter life expectancy due to storage conditions.
- If you will not be using the remote control unit for an extended period of time, remove the batteries from it.

Using the remote control unit

Use the remote control unit by pointing it towards the remote sensor window.

Objects between the remote control unit and sensor window may prevent proper operation.

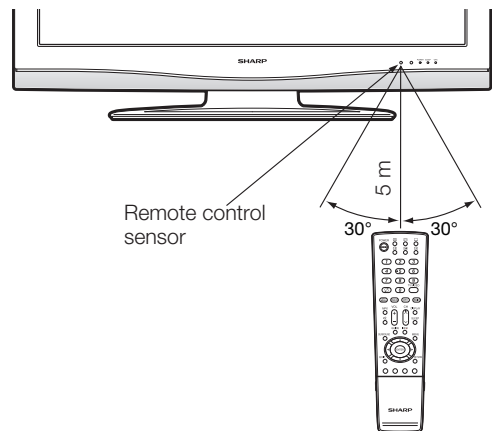

Cautions regarding remote control unit

- Do not subject the remote control unit to shock. In addition, do not soak the remote control unit with liquids, or place it in an area with high humidity.
- Do not install or place the remote control unit under direct sunlight. The heat may cause deformation of the unit.
- The remote control unit may not work properly if the remote sensor window of the TV is under direct sunlight or strong lighting. In such case, change the angle of the lighting or TV, or operate the remote control unit closer to the remote sensor window.

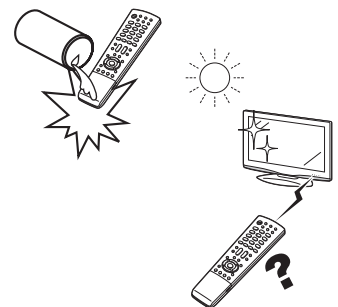

Preparation

Attaching the stand

- Before attaching (or detaching) the stand, unplug the AC cord from the AC INPUT terminal.
- Before performing work spread cushioning over the base area to lay the TV on. This will prevent it from being damaged.

CAUTION

- **Attach the stand in the correct direction.**
- **Be sure to follow the instructions. Incorrect installation of the stand may result in the TV falling over.**

1 Confirm the 8 screws supplied with the TV.

Short screws (×4)
(used in step 2)



Long screws (×4)
(used in step 3)

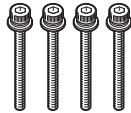

- 2**
- ① Set the post for the stand unit onto the box.
 - ② Attach the base to the post.
 - ③ Insert and tighten the 4 screws into the 4 holes on the bottom of the base.

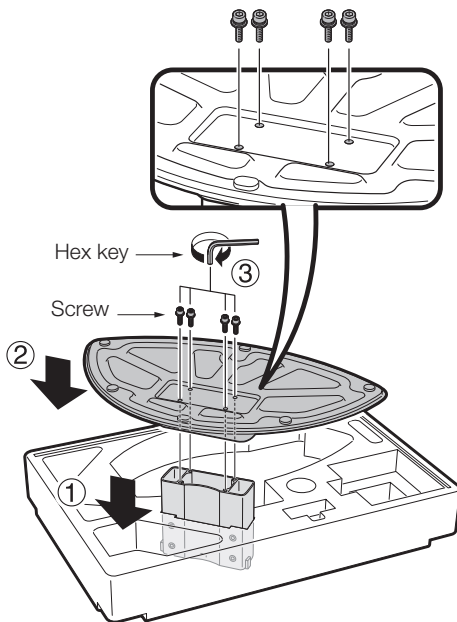

- 3**
- ① Insert the stand into the openings on the bottom of the TV.
 - ② Insert and tighten the 4 screws into the 4 holes on the rear of the TV.

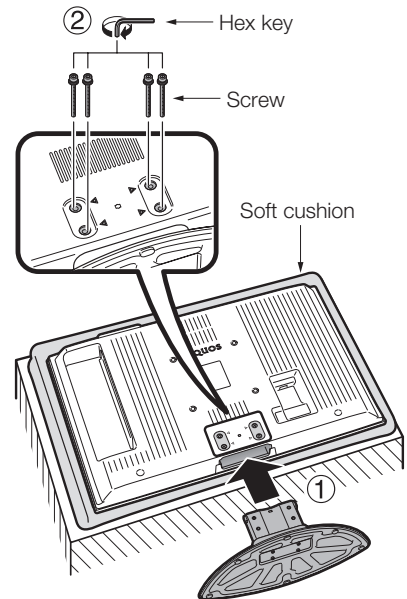

NOTE

- To detach the stand, perform the steps in reverse order.

Preparation

Setting the TV

Notes on installing the TV

- Avoid direct sunlight and place the TV in a well-ventilated location.
- Place the TV in a level location.

1 Connecting the AC cord, antenna, and external equipment to the TV

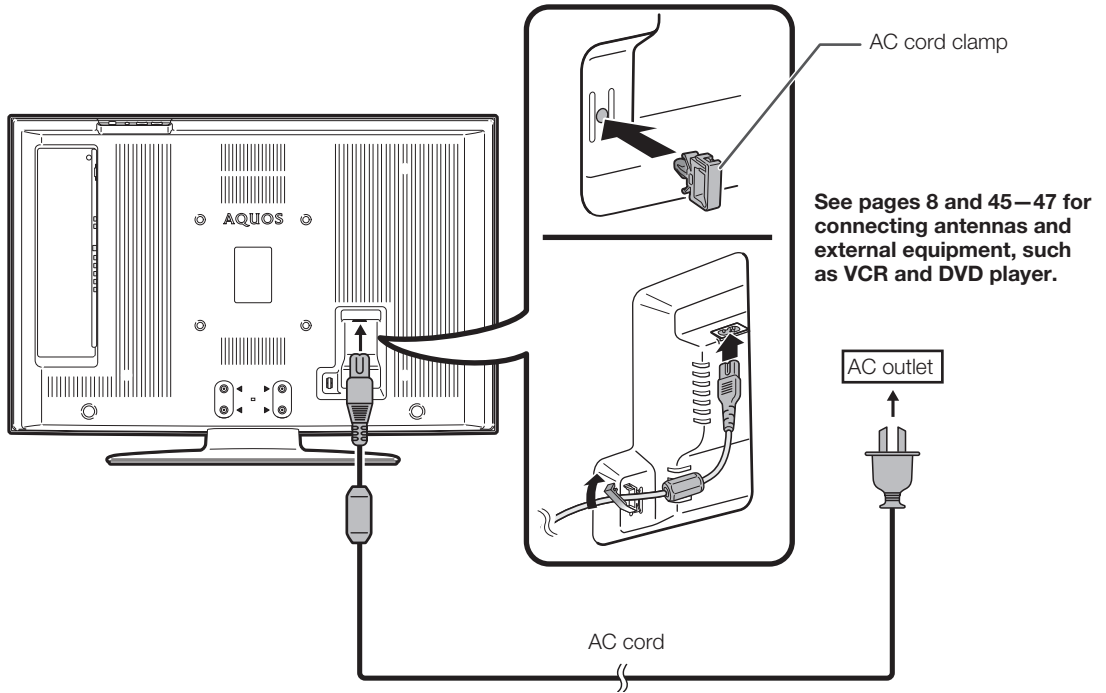

- Place the TV close to the AC outlet, and keep the power plug within reach.

2 Bundling the cables

Insert the cable clamp in the hole on the TV as shown.

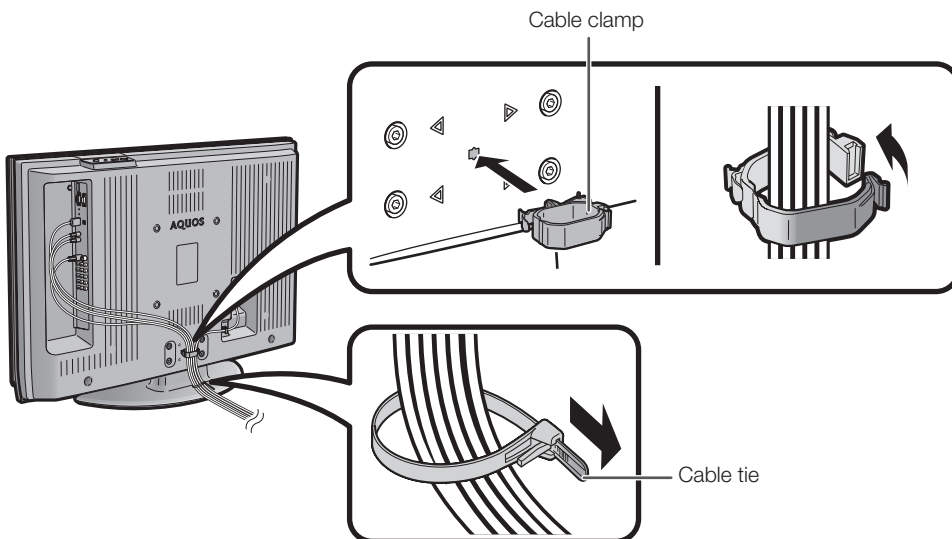

CAUTION

- TO PREVENT RISK OF ELECTRIC SHOCK, DO NOT TOUCH UN-INSULATED PARTS OF ANY CABLES WITH THE AC CORD CONNECTED.

Preparation

Simple operations for watching a TV programme

Basic connection

Connecting to an antenna

To enjoy a clearer picture, use an outdoor antenna. The following is a brief explanation of the types of connections that are used for coaxial cable.

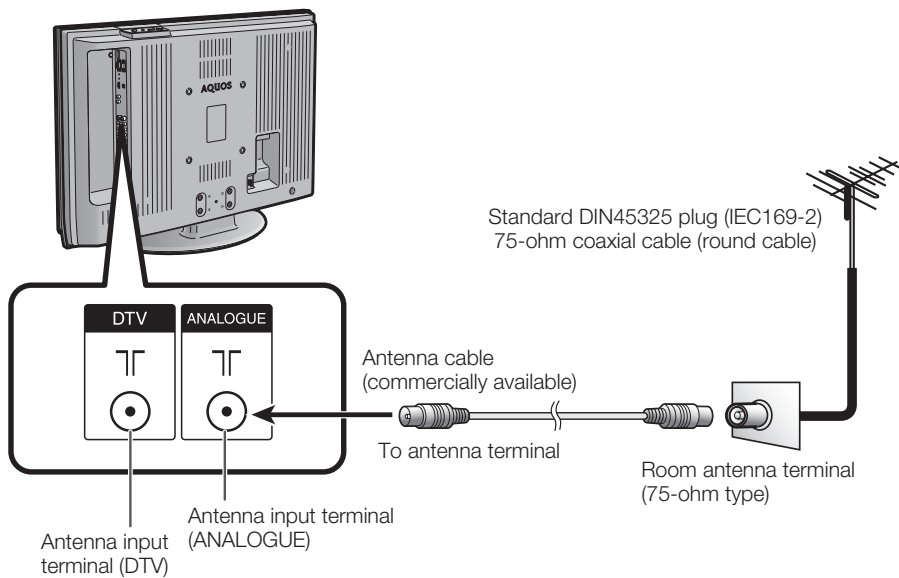

Connecting to the AC outlet

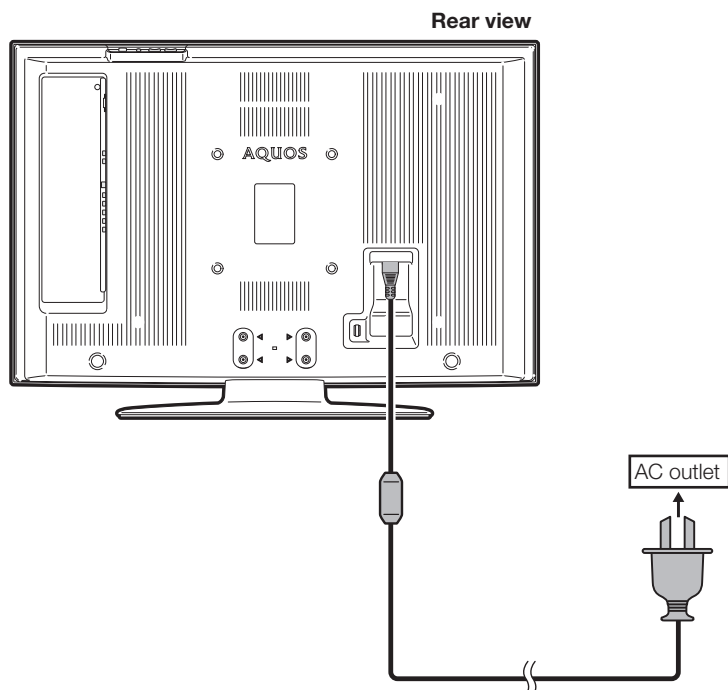

NOTE

- Always turn off the power of the TV when connecting the AC cord.
- Disconnect the AC cord from the AC outlet if the TV will not be used for a long period of time.

Preparation

Setting the TV on the wall

- You can mount the TV on the wall, using the optional AN-37AG2 bracket.
- For details, refer to the instructions supplied with the optional bracket.

CAUTION

- **This TV should be mounted on the wall only with the AN-37AG2 (SHARP) wall mount bracket. The use of other wall mount brackets may result in an unstable installation and may cause serious injuries.**
- **Installing the Liquid Crystal Television requires special skill that should only be performed by qualified service personnel. Customers should not attempt to do the work themselves. SHARP bears no responsibility for improper mounting or mounting that results in accident or injury.**

<Example>

Hanging on the wall

AN-37AG2 wall mount bracket.
(See the bracket instructions for details.)

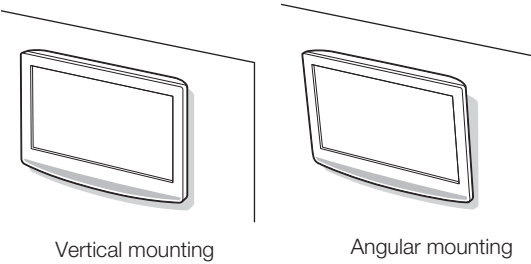

Regarding the angle when mounting the TV on the wall

- The maximum angle to which you can tilt the wall-mounted TV is as follows. Do not tilt it more than the maximum angle.

LC-32PD5X	0°, 5° or 10°
LC-37PD5X	0° or 5°

- Tilt the wall-mounted TV slowly when adjusting its angle.

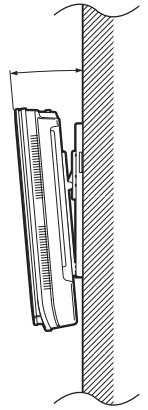

Removing the stand

For wall mounting with the optional bracket, remove the stand.

Before detaching/attaching the stand

- Before detaching (or attaching) the stand, unplug the AC cord from the AC outlet.
- Remove all terminal covers and connected cables.
- Lay the TV down on cushioning (such as a blanket) over a table.
- Make sure two or more people perform the operation.

CAUTION

- **Do not remove the stand from the TV unless using an optional bracket to mount it.**

1

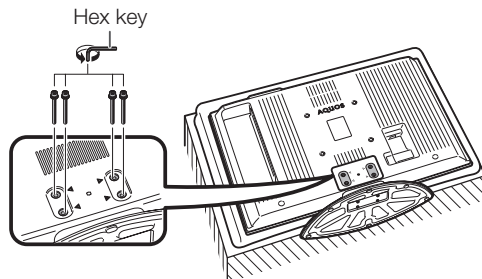

Unfasten the four screws used to secure the stand in place.

2

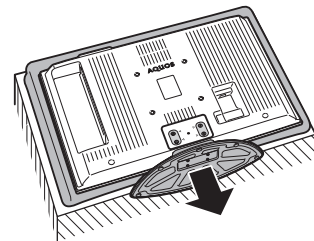

Detach the stand from the TV.
(Hold the stand so it will not drop from the edge of the base area.)

NOTE

- To attach the stand, perform the above steps in reverse order.

Part names

TV (Front)

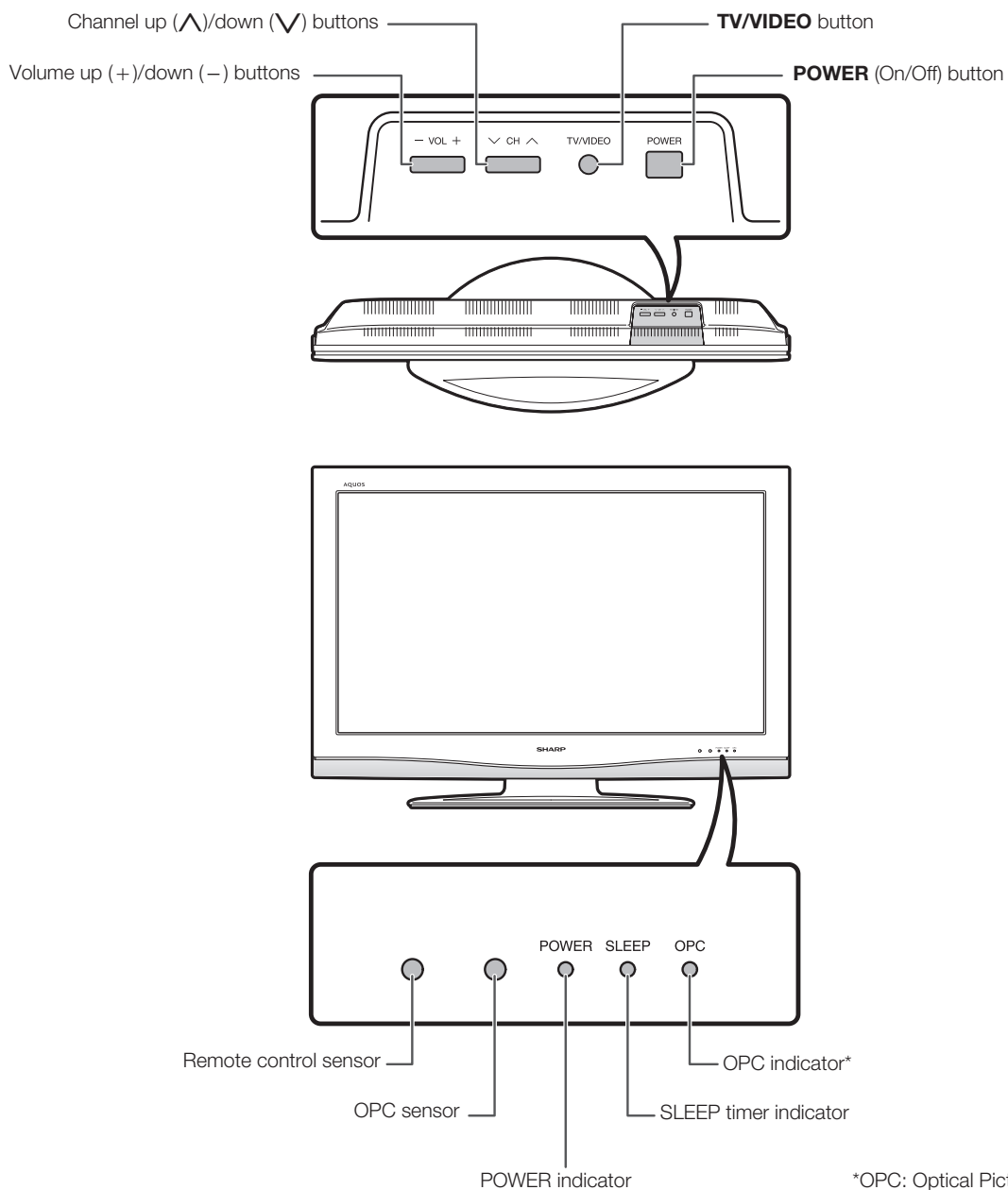

*OPC: Optical Picture Control
(See page 24.)

Part names

TV (Rear)

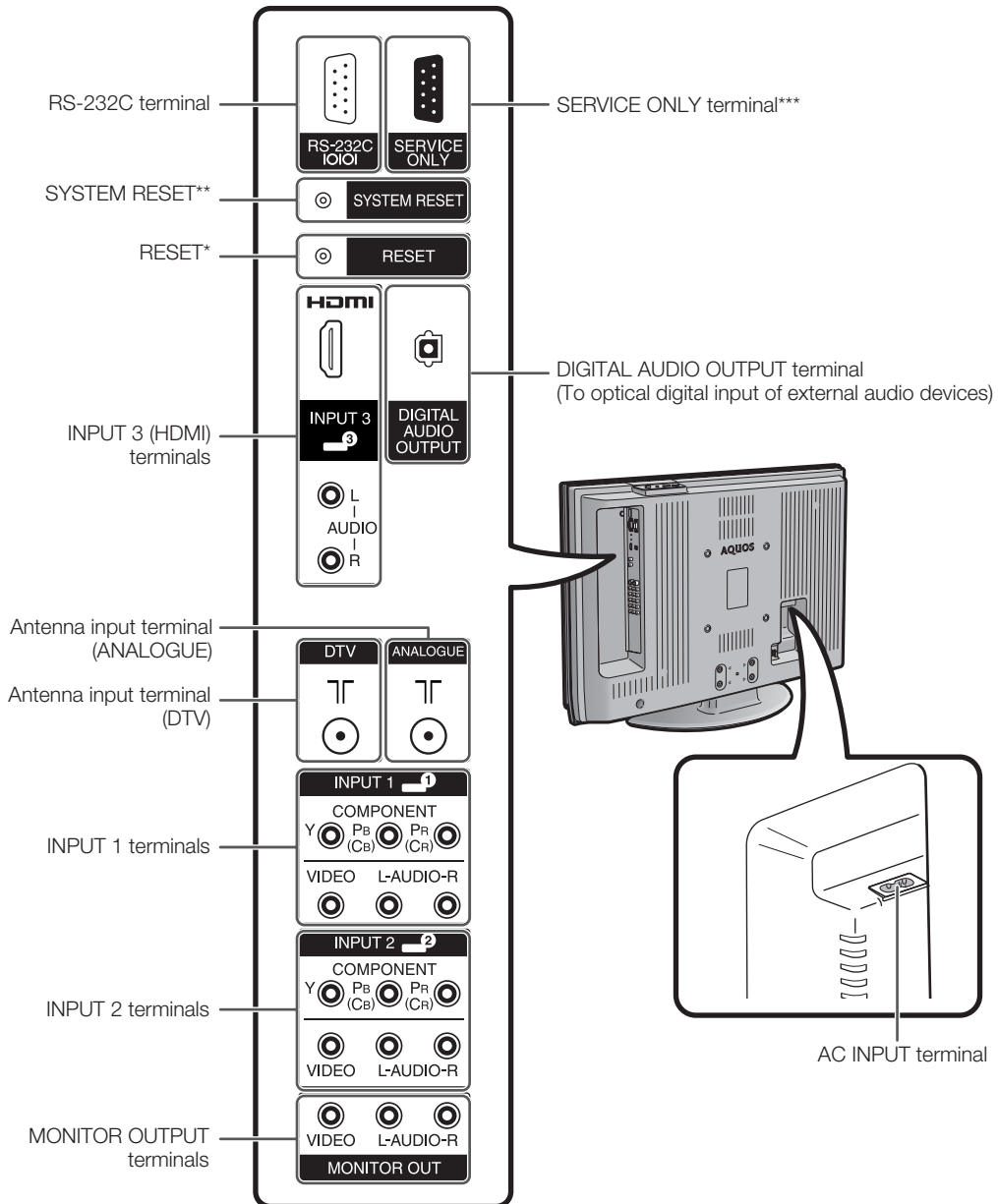

* Press **RESET** if the ANALOGUE TV cannot return to its original state after performing various operations. This will reset the TV as shown below.

- “AV MODE” resets to “USER”.
- TV channel resets to channel 1.
- Sound volume is initialised.
- Image position is initialised.
- Still image mode deactivates.
- Teletext mode resets to normal.
- “Audio Only” setting resets to “Off”.

** Press **SYSTEM RESET** if the TV does not operate after starting up.

*** Usually do not connect anything to this terminal as it is reserved only for service personnel.

NOTE

- Pressing **RESET** will not work if the TV is in standby mode (indicator lights red).
- Pressing **RESET** will not delete channel preset and password. See page 36 for resetting the password. See page 53 for initialising to the factory preset values in case you forget your password.
- Pressing **RESET** will not reset the DTV settings.

Remote control unit

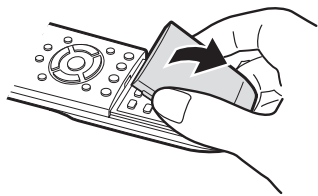
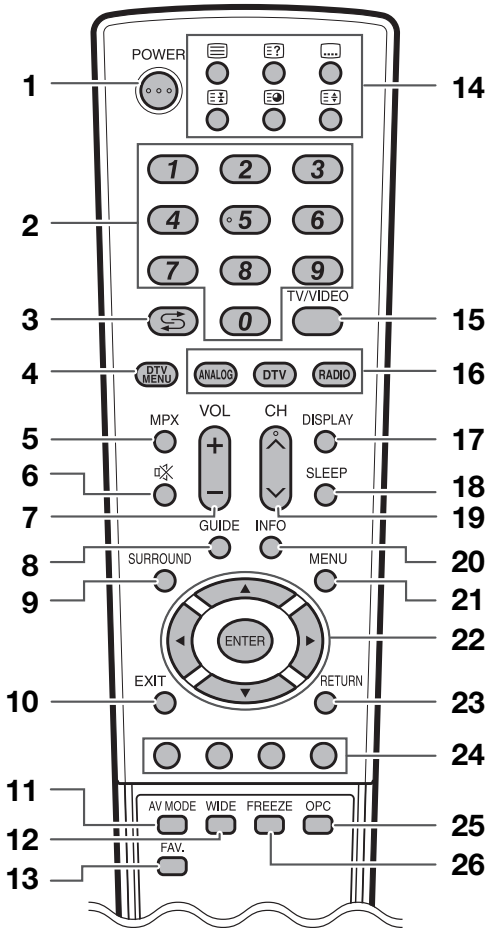

NOTE

• When using the remote control unit, point it at the TV.

- 1 POWER (STANDBY/ON)**
To switch the power on and off. (See page 13.)
- 2 0 - 9**
TV/DTV/External input mode: Set the channel. (See page 13.)
TELETEXT mode: Set the page. (See pages 13, 43 and 44.)
- 3 ⏮ (Flashback)**
Press to return to the previous channel or external input mode. (See page 14.)
- 4 DTV MENU**
DTV mode: Display DTV Menu screen. (See page 29.)
- 5 MPX**
Select the sound multiplex mode. (See page 14.)

- 6 🔇 (Mute)**
Mute the sound. (See page 15.)
- 7 VOL + /VOL -**
Set the volume. (See page 15.)
- 8 GUIDE**
DTV mode: Display the programme list. (See page 30.)
- 9 SURROUND**
Select Surround settings. (See page 28.)
- 10 EXIT**
Turn off the On-Screen Display.
- 11 AV MODE**
Select a video setting. (See page 24.)
- 12 WIDE**
Change the wide image mode. (See page 39.)
- 13 FAV.**
DTV mode: Display the favourite programme list. (See page 30.)
- 14 [Text Icon] (TELETEXT)**
ANALOGUE mode: Select the TELETEXT mode. (all TV image, all TEXT image, TV/TEXT image) (See pages 43 and 44.)
DTV mode: Select the TELETEXT mode. (all TV image, TEXT image)
[Text Icon] (Reveal hidden for TELETEXT)
TELETEXT mode: Display hidden characters. (See page 43.)
[Text Icon] (SUBTITLE for TELETEXT)
TV/INPUT mode: To turn the subtitles on and off. (See page 44.)
[Text Icon] (Hold)
TELETEXT mode: Stop updating Teletext pages automatically. Press [Text Icon] again to release the hold mode. (See pages 43 and 44.)
[Text Icon] (Subpage)
TELETEXT mode: Display the Teletext subpage directly. (See page 44.)
[Text Icon] (Top/Bottom/Full)
TELETEXT mode: Set the area of magnification. (See page 43.)
- 15 TV/VIDEO (INPUT SOURCE)**
Select an input source. (TV, DTV, INPUT 1, INPUT 2, INPUT 3) (See pages 37, 41 and 45.)
- 16 ANALOG**
Press to access ANALOGUE mode. (See page 16.)
DTV
Press to access DTV mode. (See page 16.)
RADIO
Press to access RADIO mode. (See page 16.)
- 17 DISPLAY**
Display the channel or input information.
TELETEXT mode: Display the time information included in the Teletext broadcast. (See page 44.)
- 18 SLEEP**
Set the Sleep timer. (See page 15.)
- 19 CH ^ / CH v**
TV/DTV input mode: Select the channel. (See page 13.)
TELETEXT mode: Select the page. (See pages 43 and 44.)
- 20 INFO**
DTV mode: Display the programme information. (See page 30.)
- 21 MENU**
Display the menu screen. (See page 17.)
- 22 ▲ / ▼ / ◀ / ▶ (Cursor)**
Select a desired item on the setting screen. (See pages 17 and 29.)
ENTER
Execute a command. (See pages 17 and 29.)
- 23 RETURN**
MENU mode: Return to the previous menu screen. (See pages 17 and 29.)
- 24 Colour (Red/Green/Yellow/Blue)**
TELETEXT mode: Select a page. (See page 43.)
- 25 OPC**
To switch the Optical Picture Control on and off. (See page 24.)
- 26 FREEZE**
Freeze a motion picture on the screen. (See page 15.)

Watching TV

Turning on the power

Press **POWER** on the TV.

- **POWER** indicator (Green): The TV is on. (After a few seconds, an image appears with sound.)
- After turning the power "ON" by pressing **POWER** on the TV, you can turn the power ON/OFF by pressing **POWER** on the remote control.

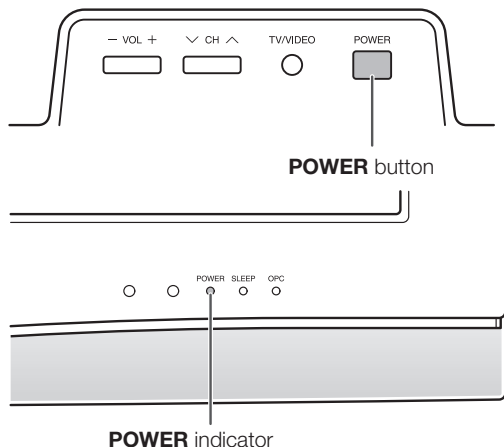

Turning off the power

Press **POWER** on the remote control.

- The TV enters standby mode and the image on the screen disappears.
- The **POWER** indicator on the TV changes from green to red.

Press **POWER** on the TV.

- The **POWER** indicator on the TV turns off.
- When the TV is turned off by **POWER** on the TV, you cannot turn on the power by pressing **POWER** on the remote control.

POWER indicator

Off	Power off
Red	The TV is in standby mode.
Green	The TV is on.

NOTE

- If you are not going to use this TV for a long period of time, be sure to remove the AC cord from the AC outlet.
- Minor power is consumed when the TV is turned off by **POWER** on the TV.

POWER button

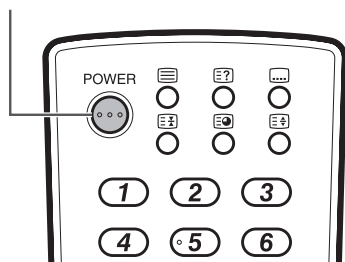

Simple button operations for changing channels

You can change channels in several ways.

Using CH ^ / v on the remote control unit

- Press **CH ^** to increase the channel number.
- Press **CH v** to decrease the channel number.

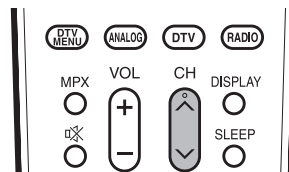

NOTE

- **CH ^ / v** on the TV operates the same as **CH ^ / v** on the remote control unit.

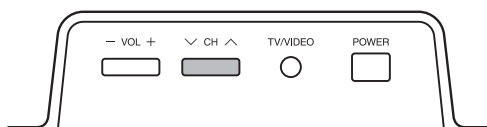

Using 0 – 9 on the remote control unit

Select the channels directly by pressing buttons **0** to **9**.



EXAMPLE

To select a 1-digit channel (e.g. channel 2):

- Press **0**, followed by **2**.

To select a 2-digit channel (e.g. channel 12):

- Press **1**, followed by **2**.

When viewing Teletext information

View a page directly which is 3-digit page number from 100 to 899 by pressing buttons **0** to **9**.

Channel display

Channel display changes approximately after 3 seconds as shown below.

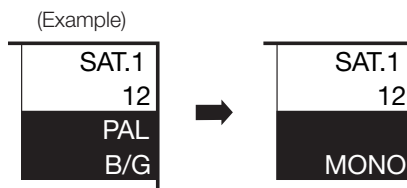

Using Flashback (↶) on the remote control unit

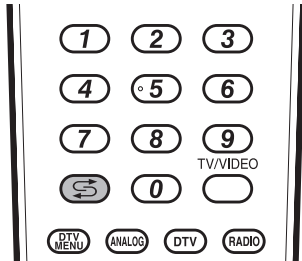

Press ↶ to switch the currently tuned channel to the previously tuned channel.
Press ↶ again to switch back to the currently tuned channel.

Press ↶ to toggle between the currently selected input source and the previously selected one.

Press ↶ to return to the previous page in TELETEXT mode.

Using MPX on the remote control unit

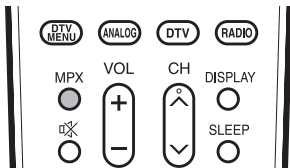

In the NICAM TV broadcasts

When receiving a stereo signal

Each time you press **MPX**, the mode switches between NICAM STEREO and MONO.

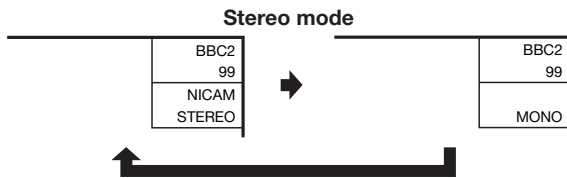

When receiving a bilingual signal

Each time you press **MPX**, the mode switches among NICAM CH A, NICAM CH B, NICAM CH AB and MONO.

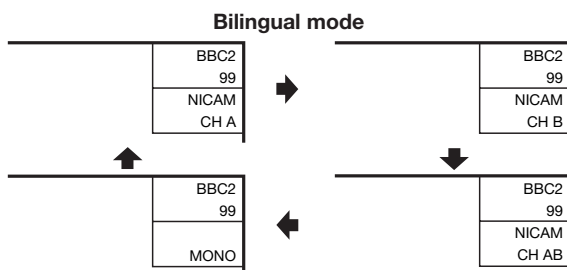

When receiving a monaural signal

Each time you press **MPX**, the mode switches between NICAM MONO and MONO.

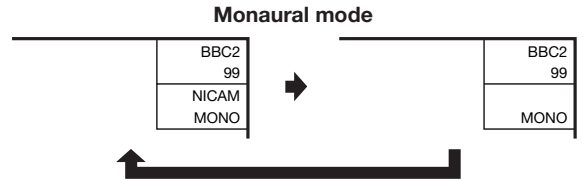

In the TV mode of A2 TV broadcasts

When receiving a stereo signal

Each time you press **MPX**, the mode switches between STEREO and MONO.

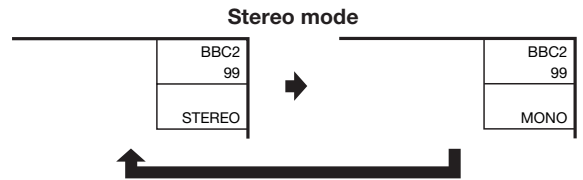

When receiving a bilingual signal

Each time you press **MPX**, the mode switches among CH A, CH B and CH AB.

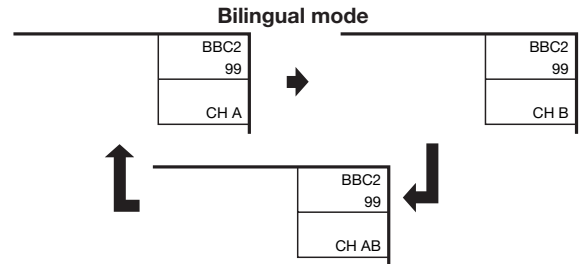

When receiving a monaural signal

When you press **MPX**, "MONO" displays.

Monaural mode

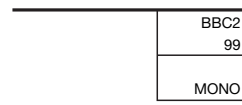

NOTE

- "BBC2" and "99" are tentative network name and channel.

Watching TV

Simple button operation for changing volume/sound

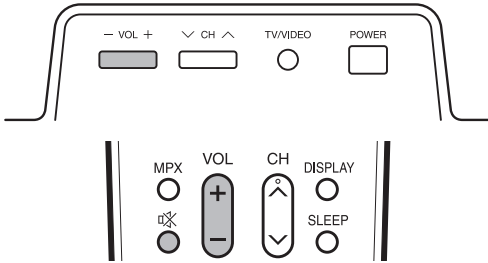

Changing the volume

You can change the volume on the TV or on the remote control unit.

- To increase the volume, press **VOL +**.
- To decrease the volume, press **VOL -**.



NOTE

- "TV", "DTV", "INPUT1", "INPUT2" and "INPUT3" modes can store volume adjustment values separately.

Using Mute (M) on the remote control unit

M mutes the current sound output.

- 1 Press **M**.
 - The sound is silenced.
 - "M" is displayed while the mute function is on.

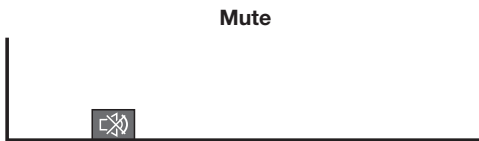

NOTE

- Within 30 minutes after pressing **M**, press one of the buttons below to cancel the mute.
 - **VOL -**/**VOL +**
 - **M**
- **Mute will be cancelled after 30 minutes. However, the TV will not suddenly output loud sound as the volume level will be set to 0 automatically. Increase the volume level by pressing VOL +.**

- 2 Press **M** again within 30 minutes to cancel the mute.

- Before 30 minutes, the volume level returns to the previous setting.

Sleep timer

Allows you to set a time when the TV automatically switches to standby.

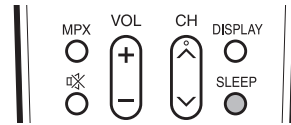

- 1 Press **SLEEP**.
 - Remaining time displays when sleep timer has been set.

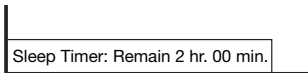

- 2 Each time you press **SLEEP**, the remaining time switches as shown below.

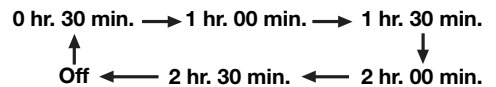

NOTE

- The sleep timer indicator on the TV lights up when the time has been set.
- When the time has been set, countdown automatically starts.
- Five minutes before the preset of time expires, the remaining time displays each minute.
- Select "Off" by pressing **SLEEP** to cancel the sleep timer.

Still image

You can freeze a motion picture on the screen.

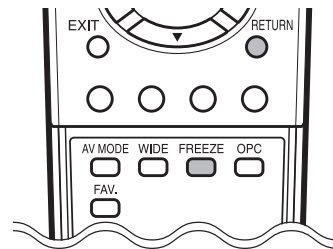

- 1 Press **FREEZE**.
- 2 Press **RETURN** to exit still image.

NOTE

- The still image automatically goes out after 30 minutes.
- When you freeze the picture, an icon is displayed at the lower left corner of the screen.

ANALOG/DTV/RADIO buttons

Use the following buttons on the remote control to operate the menu.

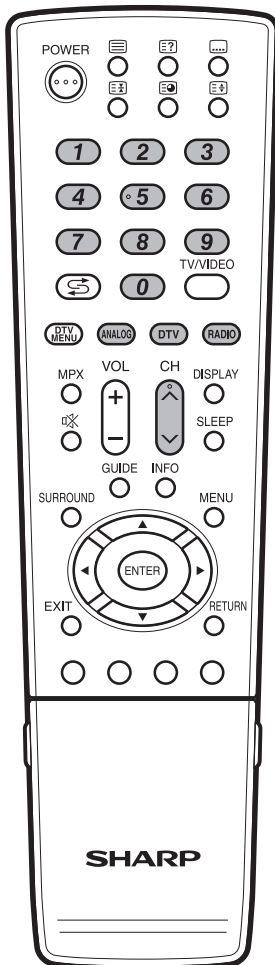

ANALOG: Press to switch to analogue mode. After switching from DTV, radio or external input mode to analogue mode, the TV jumps to the most recently viewed analogue channel.

DTV: Press to switch to DTV mode. After switching from analogue, radio or external input mode to DTV mode, the TV jumps to the most recently viewed DTV channel.

RADIO: Press to switch to radio mode. After switching from analogue, DTV or external input mode to radio mode, the TV jumps to the most recently tuned radio channel.

When you watch the TV for the first time

When the TV powers on for the first time after purchase, perform the auto installation.

Analogue TV

You can run the auto installation to set channels automatically.

1 To watch the analogue TV, select "Auto Installation" from Setup menu. (See page 19.)

2 After setting the channels, you can select a channel using **CH** \wedge/\vee or **0-9** on the remote control unit. (See page 13.)

DTV

When the TV accesses to DTV mode for the first time, you need to run the auto search. To scan all available services in your area, follow the procedures below.

1 To watch DTV broadcasts, select "Auto Search" from Installation menu. (See page 32.)

2 After setting the channels, you can select a channel using **CH** \wedge/\vee or **0-9** on the remote control unit. (See page 13.)

Basic adjustment settings

Menu operation buttons

Use the following buttons on the remote control to operate the menu.

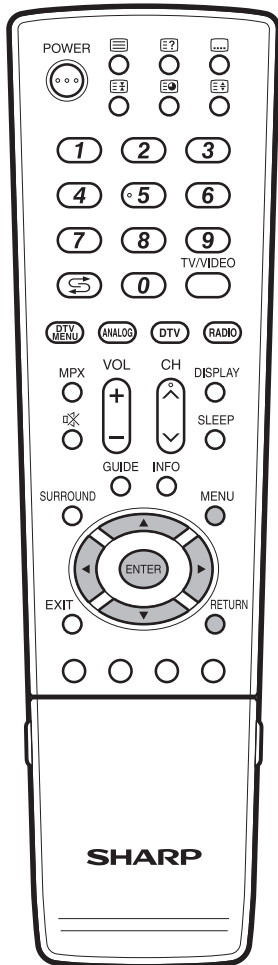

MENU: Press to open or close the menu screen.

▲/▼/◀/▶: Press to select a desired item on the screen or adjust a selected item.

ENTER: Press to go to the next step or complete the setting.

RETURN: Press to return to the previous step.

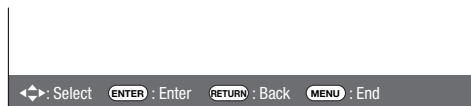

The bar above is an operational guide for the remote control. The bar will change in accordance with each menu setting screen.

On-Screen Display

(Example)

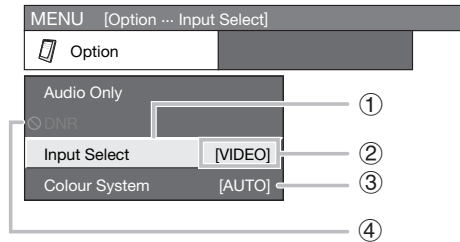

- ① Item displayed in yellow
 - This indicates the item currently selected.
 - Press **ENTER** to go to the adjustment screen for this item.
- ② Item in brackets
 - This indicates the current setting for the item.
- ③ Item displayed in white
 - This indicates an item can be selected.
- ④ Item displayed in grey
 - This indicates that the item cannot be selected.
 - * There are various reasons why items cannot be selected, but the main reasons are as follows:
 1. Nothing is connected to the selected input terminal.
 2. The function is not compatible with the current input signal.

NOTE

- Menu options differ in the selected input modes, but the operating procedures are the same.
- The screens in the operation manual are for explanation purposes (some are enlarged, others cropped) and may vary slightly from the actual screens.

Basic adjustment settings

Menu items (TV/DTV/INPUT1-2)

List of menu items to help you with operations

Picture

AV Mode	Page 24
OPC.....	Page 24
Backlight	Page 25
Contrast.....	Page 25
Brightness	Page 25
Colour	Page 25
Tint	Page 25
Sharpness	Page 25
Advanced	
Colour Temp.....	Page 26
Black	Page 26
3D-Y/C	Page 26
Monochrome	Page 27
Film Mode	Page 27
I/P Setting.....	Page 27
Reset.....	Page 25

Audio

AV Mode	Page 27
Treble.....	Page 27
Bass	Page 27
Balance.....	Page 27
Surround.....	Page 28
Reset.....	Page 27

Power Control

No Signal Off	Page 28
No Operation Off	Page 28

Setup

Auto Installation.....	Page 19
Programme Setup	Pages 19-23
Child Lock	Page 36
Input Label	Page 37
Position.....	Page 37
WSS	Page 38
4:3 Mode.....	Page 38
Text Language	Page 42

Option

Audio Only	Page 40
DNR.....	Page 40
Input Select	Page 41
Colour System	Page 41

Menu items (HDMI)

List of menu items to help you with operations

Picture

AV Mode	Page 24
OPC.....	Page 24
Backlight	Page 25
Contrast.....	Page 25
Brightness	Page 25
Colour	Page 25
Tint	Page 25
Sharpness	Page 25
Advanced	
Colour Temp.....	Page 26
Black	Page 26
3D-Y/C	Page 26
Monochrome	Page 27
Film Mode	Page 27
I/P Setting.....	Page 27
Reset.....	Page 25

Audio

AV Mode	Page 27
Treble.....	Page 27
Bass	Page 27
Balance.....	Page 27
Surround.....	Page 28
Reset.....	Page 27

Power Control

No Signal Off	Page 28
No Operation Off	Page 28

Setup

Input Label	Page 37
Position.....	Page 37

Option

Audio Only	Page 40
DNR.....	Page 40
HDMI Setup	Page 40

NOTE

- Some menu items may not be displayed depending on the selected input source.

Basic adjustment settings (Analogue)

Auto installation

You can run auto installation again, even after setting up the preset channels.

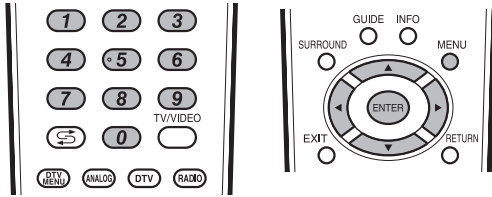

1 Press **MENU** and the MENU screen displays.

2 Press **◀/▶** to select “Setup”.

3 Press **▲/▼** to select “Auto Installation”, and then press **ENTER**.

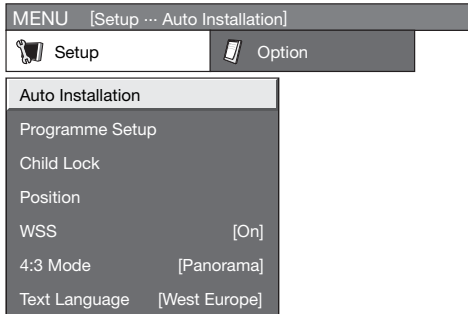

4 If you have already set the password, enter it here. If not, enter the factory preset password “1234”.

- See page 36 for setting a password.

— — — —

5 Press **◀/▶** to select “Yes”, and then press **ENTER**.

- Auto search starts with the following order.
 - ① Programme auto search
 - ② Auto labelling
 - ③ Auto sorting

You do not need to do anything during the auto search.

NOTE

- After performing step 5, the menu screen shown in step 3 will reappear. Do not turn off the TV before then, because the TV is saving the data found.

Programme setup

You can run the auto search procedure again at any time by accessing the Setup menu and Programme Setup. Channels can be tuned automatically or manually.

Auto search

You can also automatically search by performing the procedure below. This is the same function as programme auto search in auto installation.

1 Press **MENU** and the MENU screen displays.

2 Press **◀/▶** to select “Setup”.

3 Press **▲/▼** to select “Programme Setup”, and then press **ENTER**.

If you have already set the password, enter it here. If not, enter the factory preset password “1234”.

- See page 36 for setting a password.

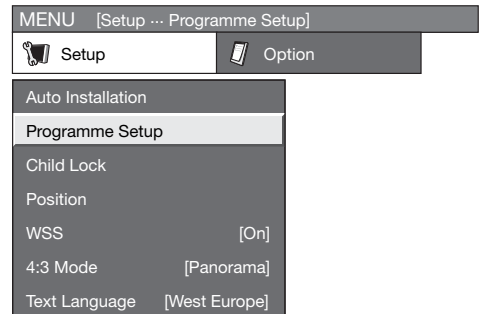

4 Press **▲/▼** to select “Auto Search”, and then press **ENTER**.

5 Press **◀/▶** to select “Yes”, and then press **ENTER**.

- Auto search starts with the following order.
 - ① Programme auto search
 - ② Auto labelling
 - ③ Auto sorting

NOTE

- After performing step 5, the menu screen shown in step 3 will reappear. Do not turn off the TV before then, because the TV is saving the data found.

Basic adjustment settings (Analogue)

Manual setting for each channel

You can set some channel items manually. They are Search, Fine (TV frequency), Colour sys., Sound sys., Label (Network name), Skip and Lock (Child Lock).

1 Press **MENU** and the MENU screen displays.

2 Press **◀/▶** to select "Setup".

3 Press **▲/▼** to select "Programme Setup", and then press **ENTER**.

If you have already set the password, enter it here. If not, enter the factory preset password "1234".

- See page 36 for setting a password.

4 Press **▲/▼** to select "Manual Adjust", and then press **ENTER**.

5 Press **◀/▶** to select "Yes", and then press **ENTER**.

Programme Setup "Manual Adjust" menu

01 SAT.1	02 PR07	03 KABEL		

Next

You can select one of the following settings.

- ① **Search** (See page 20.)
- ② **Fine** (See page 20.)
- ③ **Colour system** (See page 21.)
- ④ **Sound system** (See page 21.)
- ⑤ **Label** (See page 21.)
- ⑥ **Skip** (See page 22.)
- ⑦ **Lock** (See page 22.)

Search tuning

1 Press **▲/▼/◀/▶** to select the channel you want to edit, and then press **ENTER**.

- The selected channel information displays.

2 Press **▲/▼** to select "Search", and then press **ENTER**.

MENU [Setup --- Programme Setup]	
Search	
Fine [179.25]	179.25 MHz
Colour sys. [AUTO]	
Sound sys. [B/G]	NEXT
Label [SAT.1]	STORE
Skip [Off]	CANCEL
Lock [Off]	

3 Press **▲/▼** to select item and press **ENTER**.

- **NEXT**: Search the next channel.
- **STORE**: Memorise the current display channel.
- **CANCEL**: Return to the previous screen. (The search result will not be stored.)

Fine tuning

1 Press **▲/▼/◀/▶** to select the channel you want to edit, and then press **ENTER**.

- The selected channel information displays.

2 Press **▲/▼** to select "Fine", and then press **ENTER**.

3 Press **◀/▶** to adjust the frequency, and then press **ENTER**.

- Adjust while checking the background picture as a reference.

Search	
Fine [179.25]	179.25 MHz
Colour sys. [AUTO]	
Sound sys. [B/G]	
Label [SAT.1]	
Skip [Off]	
Lock [Off]	

- Instead of the method above, you can also set by directly entering the frequency number of the channel with **0 – 9**.
- When setting a frequency on the "Fine" screen, the last figure of the frequency needs to be "0" or "5".

EXAMPLE

- 179.25 MHz: Press **1 → 7 → 9 → 2 → 5**.
- 49.25 MHz: Press **4 → 9 → 2 → 5 → ENTER**.

Basic adjustment settings (Analogue)

Manual setting for each channel (continued)

Colour system

1 Press ▲/▼/◀/▶ to select the channel you want to edit, and then press **ENTER**.

- The selected channel information displays.

2 Press ▲/▼ to select “Colour sys.”, and then press **ENTER**.

- Receivable colour systems are listed.

Colour system menu	
MENU [Setup --- Programme Setup]	
Search	
Fine [179.25]	AUTO
Colour sys. [AUTO]	PAL
Sound sys. [B/G]	SECAM
Label [SAT.1]	NTSC 3.58
Skip [Off]	NTSC 4.43
Lock [Off]	PAL-60

3 Press ▲/▼ to select the optimum colour system, and then press **ENTER**.

Sound system (Broadcasting system)

1 Press ▲/▼/◀/▶ to select the channel you want to edit, and then press **ENTER**.

- The selected channel information displays.

2 Press ▲/▼ to select “Sound sys.”, and then press **ENTER**.

- Receivable sound systems (Broadcasting systems) are listed.

Sound system menu	
Search	
Fine [179.25]	
Colour sys. [AUTO]	B/G
Sound sys. [B/G]	D/K
Label [SAT.1]	I
Skip [Off]	M
Lock [Off]	

3 Press ▲/▼ to select the optimum sound system, and then press **ENTER**.

Labelling channels

When a TV channel sends its Network Name, the auto installation detects the information and assigns a name to it. However, you can change individual channel names.

1 Press ▲/▼/◀/▶ to select the channel you want to edit, and then press **ENTER**.

- The selected channel information displays.

2 Press ▲/▼ to select “Label”, and then press **ENTER**.

- Alphabets and numbers are listed.

Labelling menu	
Search	
Fine [179.25]	
Colour sys. [AUTO]	A B C D E F G H I J CLEAR
Sound sys. [B/G]	K L M N O P Q R S T BACK
Label [SAT.1]	U V W X Y Z + - . _
Skip [Off]	0 1 2 3 4 5 6 7 8 9 END
Lock [Off]	

3 Press ▲/▼/◀/▶ to select each character of the new name for the channel, and then press **ENTER**.

4 Repeat until the name is fully spelt out.

- The name can be 5 characters or less.
- When you want to set a channel name of less than 5 characters, select “END”, then press **ENTER** to exit from the labelling menu.

Basic adjustment settings (Analogue)

Manual setting for each channel (continued)

Skipping channels

Channels with “Skip” set to “On” are passed over when using **CH** \wedge/\vee even if selected while watching the image from the TV.

- 1 Press $\blacktriangle/\blacktriangledown/\blacktriangleleft/\blacktriangleright$ to select the channel you want to edit, and then press **ENTER**.
 - The selected channel information will be displayed.

- 2 Press $\blacktriangle/\blacktriangledown$ to select “Skip”, and then press **ENTER**.
 - Skip menu displays.

Skip menu

MENU [Setup ... Programme Setup]	
Search	
Fine [179.25]	<input type="text" value="Off"/>
Colour sys. [AUTO]	
Sound sys. [B/G]	<input type="text" value="On"/>
Label [SAT.1]	
Skip [Off]	
Lock [Off]	

- 3 Press $\blacktriangle/\blacktriangledown$ to set “Skip” to “On”, and then press **ENTER**.

Setting the child lock

You can block the viewing of any channel.

- 1 Press $\blacktriangle/\blacktriangledown/\blacktriangleleft/\blacktriangleright$ to select the channel you want to edit, and then press **ENTER**.
 - The selected channel information will be displayed.

- 2 Press $\blacktriangle/\blacktriangledown$ to select “Lock”, and then press **ENTER**.
 - Child lock menu will be displayed

Lock menu

Search	
Fine [179.25]	<input type="text" value="Off"/>
Colour sys. [AUTO]	
Sound sys. [B/G]	<input type="text" value="On"/>
Label [SAT.1]	
Skip [Off]	
Lock [Off]	

- 3 Press $\blacktriangle/\blacktriangledown$ to set “Lock” to “On”, and then press **ENTER**.

NOTE

- See page 36 for setting a password.
- If “Lock” is set to “On” for a channel, “Child lock has been activated.” is displayed when you select the channel, and the image and sound of the channel is blocked.
- When pressing **ENTER** while “Child lock has been activated.” is displayed, password input menu will be displayed. Inputting the correct password lifts the child lock temporarily until the power is turned off.

Sort

Channel positions can be sorted freely.

- 1 Press **MENU** and the MENU screen displays.
- 2 Press $\blacktriangleleft/\blacktriangleright$ to select “Setup”.
- 3 Press $\blacktriangle/\blacktriangledown$ to select “Programme Setup”, and then press **ENTER**.
If you already set the password, enter it here.
 - See page 36 for setting a password.
- 4 Press $\blacktriangle/\blacktriangledown$ to select “Sort”, and then press **ENTER**.
- 5 Press $\blacktriangleleft/\blacktriangleright$ to select “Yes”, and then press **ENTER**.
- 6 Press $\blacktriangle/\blacktriangledown/\blacktriangleleft/\blacktriangleright$ to select the channel you want to move, and then press **ENTER**.
- 7 Move it to the desired position by pressing $\blacktriangle/\blacktriangledown/\blacktriangleleft/\blacktriangleright$, and then press **ENTER**.

- 8 Repeat the steps 6 and 7 until all desired channels are sorted.

Sort menus

01 SAT.1 \leftrightarrow				
01 SAT.1	02 KABEL	03	04	05
06				
Next				

Sort menus

01 SAT.1 \leftrightarrow 02 KABEL				
01 SAT.1	02 KABEL			
Next				

Sort menus

01 KABEL \leftrightarrow				
01 KABEL	02 SAT.1			
Next				

Basic adjustment settings (Analogue)

Erase Programme

The individual programme can be erased.

- 1 Press **MENU** and the MENU screen displays.
- 2 Press **◀/▶** to select "Setup".
- 3 Press **▲/▼** to select "Programme Setup", and then press **ENTER**.
If you already set the password, enter it here.
 - See page 36 for setting a password.
- 4 Press **▲/▼** to select "Erase Programme", and then press **ENTER**.
- 5 Press **◀/▶** to select "Yes", and then press **ENTER**.
- 6 Press **▲/▼/◀/▶** to select the channel you want to erase, and then press **ENTER**.
 - A message screen pops up.
- 7 Press **◀/▶** to select "Yes", and then press **ENTER** to erase the selected programme. All the subsequent programmes move up.
- 8 Repeat the steps 6 and 7 until all desired channels are erased.

Erase programme menus

01 SAT.1				
01 SAT.1	02 Pro7	03 KABEL	04	05
06	07	08	09	10
11	12	13	14	15
16	17	18	19	20
Next				



02 Pro7				
01 SAT.1	02 Pro7	03 KABEL	04	05
06	07	08	09	10
11	12	13	14	15
16	17	18	19	20
Next				



02 KABEL				
01 SAT.1	02 KABEL	03	04	05
06	07	08	09	10
11	12	13	14	15
16	17	18	19	20
Next				

Basic adjustment settings (Analogue/Digital)

AV MODE selection

AV MODE gives you six viewing options to choose from to best match the system environment, which can vary due to factors like room-brightness, type of programme watched or the type of image input from external equipment.

Using AV MODE on the remote control unit

- 1 Press **AV MODE**.
 - Present AV MODE displays.
- 2 Press **AV MODE** again before the mode displayed on the screen disappears.
 - The mode changes as shown below.

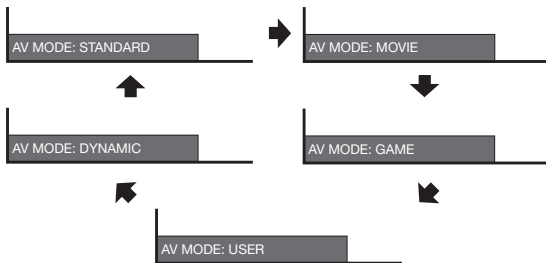

Using AV Mode on the menu screen

- 1 Press **MENU** and the MENU screen displays.
- 2 Press **◀/▶** to select “Picture” or “Audio”.
- 3 Press **▲/▼** to select “AV Mode”, and then press **ENTER**.
- 4 Press **▲/▼/◀/▶** to select the desired item, and then press **ENTER**.

Selected item	Description
STANDARD	For a highly defined image in a normally bright room
MOVIE	For a movie
GAME	Lowers image brightness for easier viewing.
USER	Allows the user to customise settings as desired. You can set the mode for each input source.
DYNAMIC	For a clear-cut image emphasising high contrast for sports viewing

NOTE

- You can select a different AV MODE item for each input mode. (For example, select STANDARD for ANALOGUE TV input and DYNAMIC for INPUT1.)

OPC (Optical Picture Control) setting

You can set the TV to automatically adjust the screen to suitable backlight brightness according to the lighting conditions.

Using OPC on the remote control unit

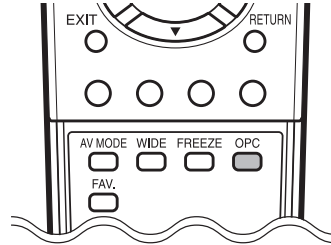

Press **OPC** to switch the OPC function on and off.

Using OPC on the menu screen

- 1 Press **MENU** and the MENU screen displays.
- 2 Press **◀/▶** to select “Picture”.
- 3 Press **▲/▼** to select “OPC”, and then press **ENTER**.
- 4 Press **▲/▼** to select the desired item, and then press **ENTER**.

Selected item	Description
Off	The brightness is fixed at the value set in “Backlight” (See page 25).
On	Automatically adjusts
On (Display)	Displays the OPC effect on the screen while adjusting the brightness of the screen.

NOTE

- Make sure no object obstructs the OPC sensor, which could affect its ability to sense surrounding light.

Basic adjustment settings (Analogue/Digital)

Picture adjustments

You can adjust the picture to your preference.

Follow the steps to adjust the picture.

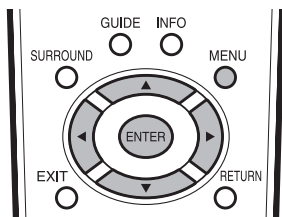

1 Press **MENU** and the MENU screen displays.

2 Press **◀/▶** to select "Picture".

3 Press **▲/▼** to select a specific adjustment item.

4 Press **◀/▶** to adjust the item to your desired position.

NOTE

- For resetting all adjustment items to factory preset values, press **▲/▼** to select "Reset", press **ENTER**, press **◀/▶** to select "Yes", and then press **ENTER**.

Adjustments items

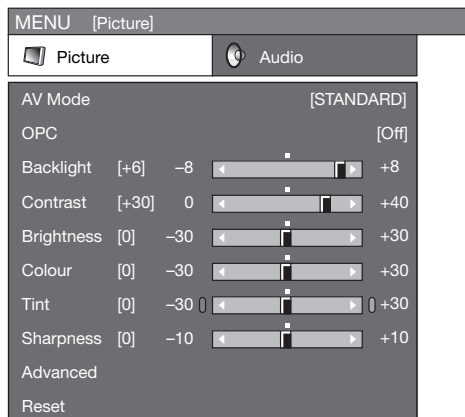

Selected item	◀ button	▶ button
Backlight	The screen dims	The screen brightens
Contrast	For less contrast	For more contrast
Brightness	For less brightness	For more brightness
Colour	For less colour intensity	For more colour intensity
Tint	Skin tones become purplish	Skin tones become greenish
Sharpness	For less sharpness	For more sharpness

NOTE

- Select "Advanced" and then press **ENTER** to set "Colour Temp.", "Black", "3D-Y/C", "Monochrome", "Film Mode" or "I/P Setting". See pages 26 and 27.

Basic adjustment settings (Analogue/Digital)

Advanced

Advanced setting enables you to set the picture adjustment in more detail. There are six options you can choose from.

Colour temperature

Adjusts the colour temperature to give the best white image.

1 Press **MENU** and the MENU screen displays.

2 Press **◀/▶** to select "Picture".

3 Press **▲/▼** to select "Advanced", and then press **ENTER**.

4 Press **▲/▼** to select "Colour Temp.", and then press **ENTER**.

5 Press **▲/▼** to select the desired level, and then press **ENTER**.

Selected item	Description
High	White with bluish tone ↑↓ White with reddish tone
Mid-High	
Middle	
Mid-Low	
Low	

Black

For easier viewing, change the viewing depth by selecting a level for automatically adjusting the dark portion of an image.

1 Repeat steps 1 to 3 in **Colour temperature**.

2 Press **▲/▼** to select "Black", and then press **ENTER**.

3 Press **◀/▶** to select "On", and then press **ENTER**.

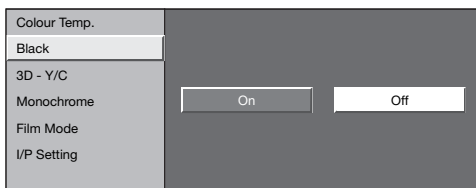

Selected item	Description
On	For high detail in black portions
Off	No adjustment

3D-Y/C

Provides high quality images with minimal dot crawl and cross colour noise.

1 Repeat steps 1 to 3 in **Colour temperature**.

2 Press **▲/▼** to select "3D-Y/C", and then press **ENTER**.



3 Press **▲/▼** to select the desired level, and then press **ENTER**.

Selected item	Description
Off	3D-Y/C off
Standard	Normal adjustment
Fast	For movie image
Slow	For still image

NOTE

- 3D-Y/C is not selectable depending on the input signal type.
- 3D-Y/C may not operate depending on the input signal type or noisy input signal.

Basic adjustment settings (Analogue/Digital)

Monochrome

For viewing images in monochrome.

- 1 Press **MENU** and the MENU screen displays.
- 2 Press **◀/▶** to select "Picture".
- 3 Press **▲/▼** to select "Advanced", and then press **ENTER**.
- 4 Press **▲/▼** to select "Monochrome", and then press **ENTER**.
- 5 Press **◀/▶** to select "On", and then press **ENTER**.

Film Mode

Automatically detects a film-based source (originally encoded at 24/25 frames/second, depending on the vertical frequency), analyses it then recreates each still film frame for high-definition picture quality.

- 1 Repeat steps 1 to 3 in **Monochrome**.
- 2 Press **▲/▼** to select "Film Mode", and then press **ENTER**.
- 3 Press **◀/▶** to select "On", and then press **ENTER**.

I/P Setting

Adjusting the image and input signal can give you a more beautiful picture.

- 1 Repeat steps 1 to 3 in **Monochrome**.
- 2 Press **▲/▼** to select "I/P Setting", and then press **ENTER**.
- 3 Press **◀/▶** to select "Interlace" or "Progressive", and then press **ENTER**.

NOTE

- The picture is progressive scan when Film Mode is "On".

AV Mode selection

This option links to "AV Mode" in the Picture menu. (See page 24.)

Audio adjustment

For each selected AV mode, you can adjust the following three items: Treble, Bass, and Balance; to your preferred setting. After choosing the AV mode you want to adjust, next carry out audio adjustment.

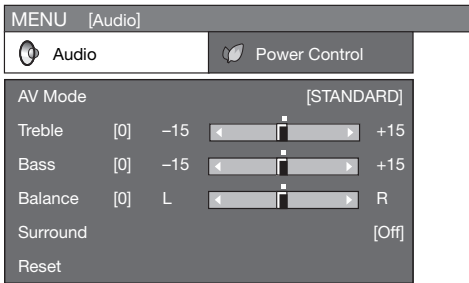
- 1 Press **MENU** and the MENU screen displays.
 - 2 Press **◀/▶** to select "Audio".
- 
- 3 Press **▲/▼** to select a specific adjustment item.
 - 4 Press **◀/▶** to adjust the item to your desired position.

Selected item	◀ button	▶ button
Treble	For weaker treble	For stronger treble
Bass	For weaker bass	For stronger bass
Balance	Decrease audio from the right speaker	Decrease audio from the left speaker

NOTE

- For resetting all adjustment items to factory preset values, press **▲/▼** to select "Reset", press **ENTER**, press **◀/▶** to select "Yes", and then press **ENTER**.

Basic adjustment settings (Analogue/Digital)

Surround

When you set to “On”, you can enjoy surround sound, the same as if you were in a movie theatre.

Using SURROUND on the remote control unit

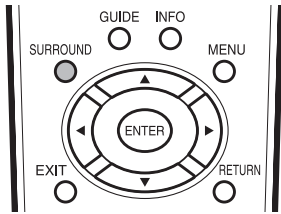

Press **SURROUND** to switch the Surround function on and off.

Selected item	Description
On	Makes it possible to enjoy natural, realistic surround sound.
Off	Outputs the normal sound.

Using Surround on the menu screen

You can produce Surround effects from the “Audio” setting.

1 Press **MENU** and the MENU screen displays.

2 Press **◀/▶** to select “Audio”.

3 Press **▲/▼** to select “Surround”, and then press **ENTER**.

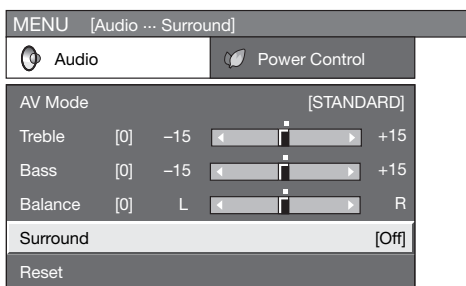

4 Press **◀/▶** to select “On”, and then press **ENTER**.

Power Control

Power Control setting allows you to save energy.

No Signal Off

When set to “Enable”, the power will automatically shut down if no signal inputs for 15 minutes.

1 Press **MENU** and the MENU screen displays.

2 Press **◀/▶** to select “Power Control”.
• Power control menu displays.

3 Press **▲/▼** to select “No Signal Off”, and then press **ENTER**.

4 Press **◀/▶** to select “Enable”, and then press **ENTER**.
• Five minutes before the power shuts down, remaining time displays every minute.

NOTE

- “Disable” is factory preset value.
- When a TV programme finishes, this function may not operate.

No Operation Off

When set to “Enable”, the power will automatically shut down if there is no operation for 3 hours.

1 Press **MENU** and the MENU screen displays.

2 Press **◀/▶** to select “Power Control”.
• Power control menu displays.

3 Press **▲/▼** to select “No Operation Off”, and then press **ENTER**.

4 Press **◀/▶** to select “Enable”, and then press **ENTER**.
• Five minutes before the power shuts down, remaining time displays every minute.

NOTE

- “Disable” is factory preset value.

Basic adjustment settings (Digital)

DTV input mode menu items

List of DTV menu items to help you with operations

Programme	Programme List.....	Page 31
	Edit Channel	
	Favourite & Lock.....	Page 31
	Parental Rate.....	Page 31
Setup	Installation	
	Auto Search.....	Page 32
	Manual Adjust.....	Page 32
	Quick Search.....	Page 33
	Reset Data.....	Page 33
	System Setup	
	Video Setup.....	Page 33
	Audio Setup	
	Digital Output.....	Page 34
	Multilingual.....	Page 34
	Time Setup.....	Page 34
	I-Plate Setup.....	Page 35
Option	Information.....	Page 35
	S/W Update (SERVICE ONLY).....	Page 35

NOTE

- The illustrations and on-screen displays in this manual are for explanation purposes and may vary slightly from the actual operations.

Selecting DTV mode

Press **DTV MENU** to directly display DTV menu screen.

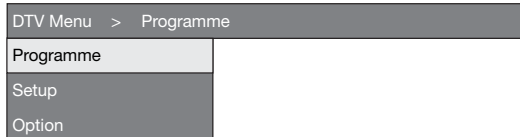
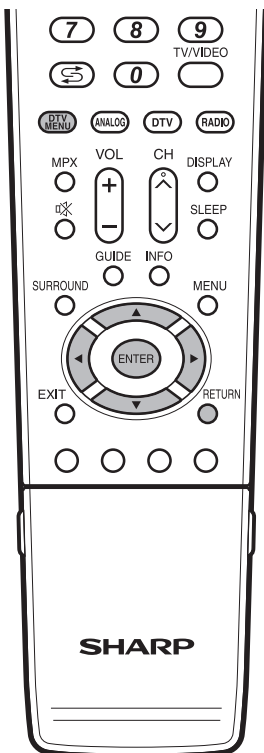

DTV MENU: Press to open or close DTV menu screen.

▲/▼/◀/▶: Press to select a desired item on the screen or adjust a selected item.

ENTER: Press to go to the next step or complete the setting.

RETURN: Press to return to the previous step.

Basic adjustment settings (Digital)

Programme Guide

You can check the schedule of DTV events and view detailed information about current or future events.

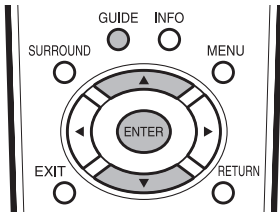

1 Press **GUIDE** to display the programme guide list.

2 Press **▲/▼** to display your desired programme, and then press **ENTER**.

- When you press **ENTER**, the TV jumps to the channel.

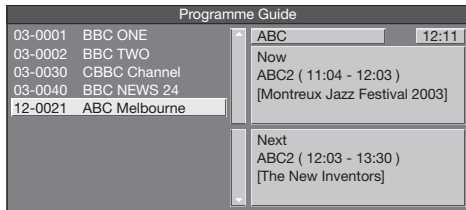

Info

While watching DTV you can check the extended programme information on the screen using **INFO** on the remote control.

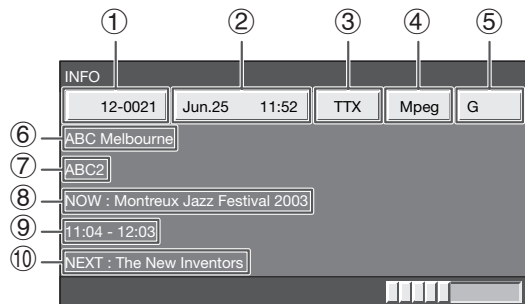
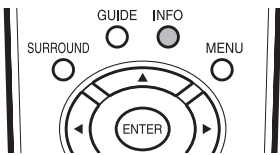

General INFO screen

- | | |
|----------------------------------|----------------------------------|
| ① Current channel number | ⑥ Station name |
| ② Date and current local time | ⑦ Service name |
| ③ Teletext | ⑧ Current programme name |
| ④ Audio system (Dolby D or MPEG) | ⑨ Time for the current programme |
| ⑤ Parental rate | ⑩ Next programme name |

NOTE

- While the I-Plate is still on the screen, you can press **INFO** on the remote control again to call up the extended programme information of the current TV channel.
- Press **INFO** again and you call up the extended information on the next programme.
- Pressing **INFO** again will not display the information for the next programme if "No Available Event Text" under "Next" is displayed.

Favourite Programme List

When you are watching terrestrial TV channels, you can call up the Favourite Programme List using **FAV.** on the remote control.

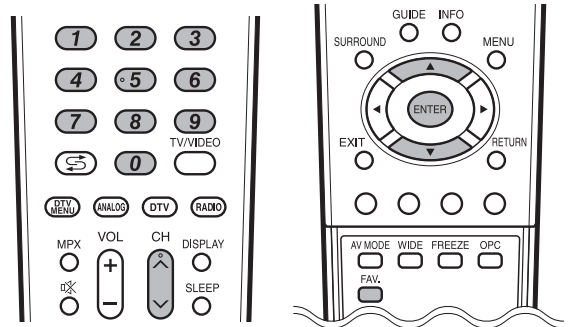

1 Press **FAV.** to display the Favourite Programme List.

2 Press **▲/▼** to select your desired channel, and then press **ENTER**.



NOTE

- Refer to "Favourite & Lock" to register channels to your Favourite Programme List. (See page 31.)

Changing channels within the Favourite Programme List

1 Repeat steps 1 and 2 in **Favourite Programme List**.

2 Select the registered channels in the Favourite Programme List using **CH▲/▼** on the remote control unit or the TV.

- The information plate pops up with the "♥" symbol under the channel.

Selecting channels other than Favourite programmes

1 Directly input the number of the channel you want to watch using **0—9** on the remote control unit or select the channel from "Programme List" in the "Programme" menu.

Basic adjustment settings (Digital)

Programme List

You can select the desired programme from the programme list.

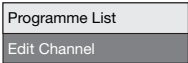
- 1 Press **DTV MENU** to display the DTV menu screen.
- 2 Press **▲/▼** to select "Programme", and then press **ENTER**.
- 3 Press **▲/▼** to select "Programme List", and then press **ENTER**.



- 4 Press **▲/▼** to select your desired programme number and name, and then press **ENTER**.

Favourite & Lock

Assign channels to Favourite or to Lock groups.

- 1 Press **DTV MENU** to display the DTV menu screen.
- 2 Press **▲/▼** to select "Programme", and then press **ENTER**.
- 3 Press **▲/▼** to select "Edit Channel", and then press **ENTER**.
If you have already set the password, enter it here. If not, enter the factory preset password "1234".
 - See page 36 for setting a password.
- 4 Press **▲/▼** to select "Favourite & Lock", and then press **ENTER**.



- 5 Press **▲/▼** to select your desired channel.
- 6 Press **◀/▶** to select "FAV" or "Lock", and then press **ENTER**.

Selected item	Description
FAV	You can easily select your favourite channel from the Favourite Programme List.
Lock	When the channel is locked, you must enter your password whenever you tune to the channel.

NOTE

- Press **ENTER** again to cancel "FAV" (♥) or "Lock" (🔒) settings.

Parental Rate

This function allows TV channels to be restricted. It prevents children from watching violent or sexual scenes that may be considered inappropriate.

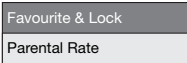
- 1 Repeat steps 1 to 3 in **Favourite & Lock**.
- 2 Press **▲/▼** to select "Parental Rate", and then press **ENTER**.

- 3 Press **▲/▼** to select your desired rating, and then press **ENTER**.

Selected item	Description
General and above (G)	Content is not offensive to most viewers.
Parental Guidance and above (PG)	Content is such that parents may not want their children to view the programme.
Mature and above (M)	Mature Audience only. This programme is specifically designed to be viewed by adults and therefore may be unsuitable for children under 15.
Mature Adult and above (MA)	Mature Adult only. Mature Audience only. This programme is specifically designed to be viewed by adults and therefore may be unsuitable for children under 15.
Adult Violence (AV)	Not for children under age 15. Strong elements of sex and/or violence.
Restricted and above (R)	Not for children under age 18. Strong elements of sex and/or violence.
No Block (-)	Cancel the blocking.

Basic adjustment settings (Digital)

Installation

The first time the receiver is powered on, "Programme list is empty" will display on the screen. Under the main menu, select "Installation" and enter into the sub-menu.

Auto Search

You can automatically search for and download TV channels.

1 Press **DTV MENU** to display the DTV menu screen.

2 Press **▲/▼** to select "Setup", and then press **ENTER**.

3 Press **▲/▼** to select "Installation", and then press **ENTER**.

If you have already set the password, enter it here. If not, enter the factory preset password "1234".

- See page 36 for setting a password.

4 Press **▲/▼** to select "Auto Search", and then press **ENTER**.

5 Press **◀/▶** to select "Yes", and then press **ENTER**.

6 Auto search starts.

- Programme auto search
- You do not need to do anything during the auto search.

NOTE

- Once the DTV signal is scanned, the channel number and programme name will be shown on the programme list.
- The indicator operates concurrently with scanning channels and shows the progress made.

Manual Adjust

You can set some channel items manually.

1 Repeat steps 1 to 3 in **Auto Search**.

2 Press **▲/▼** to select "Manual Adjust", and then press **ENTER**.

3 Press **0-9** or **◀/▶** to select a channel number.

- Channel settings apply to channels 2-69.

4 Press **▲/▼** to select the desired menu item, and make sure the correct frequency is selected.

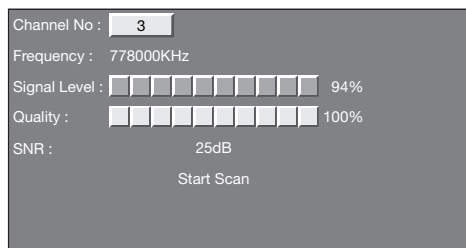

5 Press **▲/▼** to select "Start Scan", and then press **ENTER**.

NOTE

- If a signal locks in, "Start Scan" will change to "Get Channel Success". Then you can press **EXIT** to leave the installation page and watch a programme or continue scanning for other channels. Anytime you watch a DTV channel and want to know the "Signal Level", "Quality" or "SNR", enter into this page.
- If a signal does not lock in, "Start Scan" will show "Timeout Error". You can scan the signal again, or refer to the "Signal Level" and "Quality" for aligning the direction of the antenna to get the signal.
- **Signal Level:** The signal power or intensity from the broadcasted frequency.
Quality: The clean level of the signal from the broadcasted frequency.
SNR: The rate of signal and noise to radiated frequency.

Basic adjustment settings (Digital)

Quick Search

If you live in the cities or regions listed in the “Quick Search” menu, you can scan all DTV channel signals.

- 1 Press **DTV MENU** to display the DTV menu screen.
- 2 Press **▲/▼** to select “Setup”, and then press **ENTER**.
- 3 Press **▲/▼** to select “Installation”, and then press **ENTER**.
If you have already set the password, enter it here. If not, enter the factory preset password “1234”.
 - See page 36 for setting a password.
- 4 Press **▲/▼** to select “Quick Search”, and then press **ENTER**.

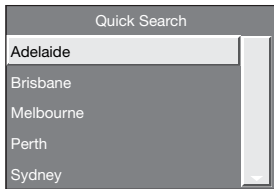
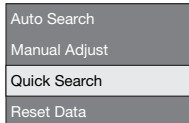

- 5 Press **▲/▼** to select your city or region listed on the screen, and then press **ENTER**.

NOTE

- If channel frequency is changed by the local TV station or a new channel comes up, you have to scan these channels using “Manual Adjust”.

Reset Data

Use this function to clear the channel data.

- 1 Repeat steps 1 to 3 in **Quick Search**.
- 2 Press **▲/▼** to select “Reset Data”, and then press **ENTER**.
- 3 Press **◀/▶** to select “Yes”, and then press **ENTER**.

Video Setup

This function allows you to select an output format.

- 1 Press **DTV MENU** to display the DTV menu screen.
- 2 Press **▲/▼** to select “Setup”, and then press **ENTER**.
- 3 Press **▲/▼** to select “System Setup”, and then press **ENTER**.
- 4 Press **▲/▼** to select “Video Setup”, and then press **ENTER**.
- 5 Press **▲/▼** to select your desired item, and then press **ENTER**.

Selected item	Description
Fix	Displays every DTV broadcast converted to 1080i.
Auto	Displays the DTV broadcast in the format it is received.

Basic adjustment settings (Digital)

Digital Output

This function allows you to select your favourite audio output system.

- 1 Press **DTV MENU** to display the DTV menu screen.
- 2 Press **▲/▼** to select "Setup", and then press **ENTER**.
- 3 Press **▲/▼** to select "System Setup", and then press **ENTER**.
- 4 Press **▲/▼** to select "Audio Setup", and then press **ENTER**.
- 5 Press **▲/▼** to select "Digital Output", and then press **ENTER**.

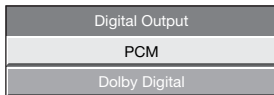
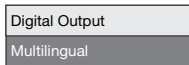

- 6 Press **▲/▼** to select your desired output system, and then press **ENTER**.

Selected item	Description
PCM	The optical output format is normally in PCM.
Dolby Digital	Dolby Digital audio will be output when there is a Dolby Digital audio signal. The output will be in PCM when there is no Dolby Digital audio signal.

Using Digital Audio Output

It is possible to output audio through the DIGITAL AUDIO OUTPUT terminal. PCM audio outputs from the terminal.

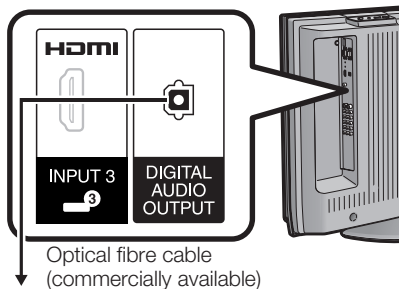

To optical digital input of external audio devices

Multilingual

You can select a different audio language when the broadcast has different audio language.

- 1 Repeat steps 1 to 4 in **Digital Output**.
- 2 Press **▲/▼** to select "Multilingual", and then press **ENTER**.

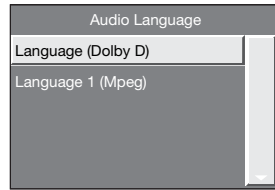
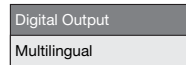

- 3 Press **▲/▼** to select your desired audio language, and then press **ENTER**.

Selected item	Description
Language (Dolby D)	You can enjoy Dolby Digital audio. Outputs Dolby Digital audio from the digital output.
Language (Mpeg)	You can enjoy Mpeg audio. Outputs PCM audio from the digital output regardless of the "Digital Output" setting.

Time Setup

This function allows you to select your local time zone.

- 1 Repeat steps 1 to 3 in **Digital Output**.
- 2 Press **▲/▼** to select "Time Setup", and then press **ENTER**.

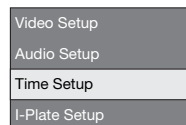

- 3 Press **◀/▶** to select your local time zone, and then press **ENTER**.

Basic adjustment settings (Digital)

I-Plate Setup (Information Plate Setup)

This function allows you to configure the display time and time format for the information plate.

1 Press **DTV MENU** to display the DTV menu screen.

2 Press **▲/▼** to select "Setup", and then press **ENTER**.

3 Press **▲/▼** to select "System Setup", and then press **ENTER**.

4 Press **▲/▼** to select "I-Plate Setup", and then press **ENTER**.

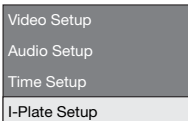

5 Press **▲/▼** to select your desired item.

6 Press **◀/▶** to select your desired value, and then press **ENTER**.



Information

You can check the current version of the hardware and software on the screen.

1 Press **DTV MENU** to display the DTV menu screen.

2 Press **▲/▼** to select "Option", and then press **ENTER**.

3 Press **▲/▼** to select "Information", and then press **ENTER**.



S/W Update (SERVICE ONLY)

This function is only for service personnel to use for software updates.

Useful adjustment settings

Password setting for child lock (for TV/DTV input mode)

Allows you to use a password to protect certain settings from being accidentally changed.

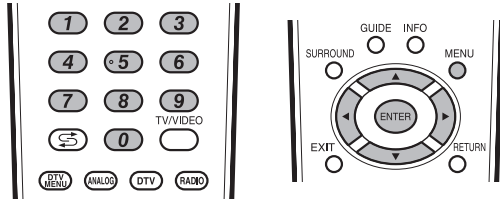

Setting a password

Register a 4-digit password number to use the Child Lock function.

1 Press **MENU** and the MENU screen displays.

2 Press **◀/▶** to select "Setup".

3 Press **▲/▼** to select "Child Lock", and then press **ENTER**.

4 If you already set the password, enter it here. If not, enter the factory preset password "1234".

5 Press **▲/▼** to select "Change password", and then press **ENTER**.

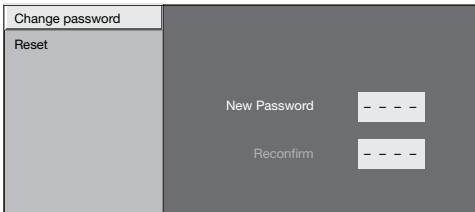

6 Enter the 4-digit number as a password using 0 – 9.

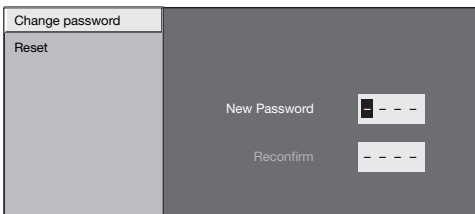

7 Enter the same 4-digit number as in step 6 to confirm.

- "The new password was registered." displays.

NOTE

- To view a locked channel (Lock setting in Programme Setup "Manual Adjust" is set to "On"), you must enter a password. (See page 22.) When you select a locked channel, a password prompt message pops up. Press **ENTER** to display the password input window.

Resetting the password

Allows you to reset your password.

1 Press **MENU** and the MENU screen displays.

2 Press **◀/▶** to select "Setup".

3 Press **▲/▼** to select "Child Lock", and then press **ENTER**.

4 Enter the password.

5 Press **▲/▼** to select "Reset", and then press **ENTER**.

6 Press **◀/▶** to select "Yes", and then press **ENTER**.

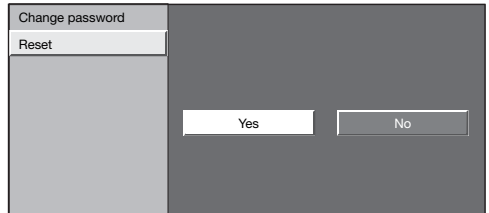

NOTE

- As a precautionary measure, make a note of your password and keep it in a familiar place. If you lose or forget your password, initialise the TV to return all settings except for the TV channel settings to factory preset values. (See page 53.)
- This function is only available for TV/DTV input mode.
- To relock a channel which has been temporarily unlocked by inputting the correct password, turn power off and then on again.

Useful adjustment settings

Input Label

You can assign each input source a label you like.

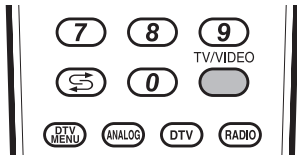

- 1 Press **TV/VIDEO** to select the desired input source.
- 2 Press **MENU** and the MENU screen displays.
- 3 Press **◀▶** to select "Setup".
- 4 Press **▲▼** to select "Input Label", and then press **ENTER**.
- 5 Press **▲▼/◀▶** to select each character of the new name for the input source, and then press **ENTER**.

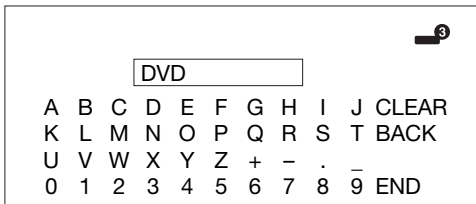

(Example)

- 6 Repeat until the name is fully spelt out.
 - The name can be 6 characters or less.
 - When you want to set an input source name of less than 6 characters, select "END", then press **ENTER** to exit from the labelling menu.

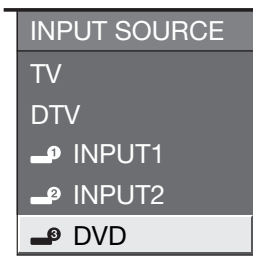

(Example)

NOTE

- You cannot change labels if the input source is TV or DTV.

Image position

For adjusting a picture's horizontal and vertical position.

- 1 Press **MENU** and the MENU screen displays.
- 2 Press **◀▶** to select "Setup".
- 3 Press **▲▼** to select "Position", and then press **ENTER**.
- 4 Press **▲▼** to select "H-Pos." or "V-Pos."



Selected item	Description
H-Pos.	Centres the image by moving it to the left or right.
V-Pos.	Centres the image by moving it up or down.

- 5 Press **◀▶** to adjust the item to your desired position.

NOTE

- For resetting all adjustment items to the factory preset values, press **▲▼** to select "Reset", and then press **ENTER**.
- **Adjustments are stored separately according to input source.**

Useful adjustment settings

Wide Screen Signalling (WSS)

WSS allows a television to switch automatically among the different screen formats.

- 1 Press **MENU** and the MENU screen displays.
- 2 Press **◀/▶** to select "Setup".
- 3 Press **▲/▼** to select "WSS", and then press **ENTER**.
- 4 Press **◀/▶** to select "On" or "Off", and then press **ENTER**.

NOTE

- Try to set WIDE mode if an image does not switch to the correct screen format. When the broadcast signal contains no WSS information, the function will not work even if enabled.

Picture aspect ratio

The WSS signal has 4:3 auto-switching that allows you to select between Panorama and Normal.

- 1 Press **MENU** and the MENU screen displays.
- 2 Press **◀/▶** to select "Setup".
- 3 Press **▲/▼** to select "4:3 Mode", and then press **ENTER**.
- 4 Press **◀/▶** to select "Panorama" or "Normal", and then press **ENTER**.

WSS signal 4:3 screen

4:3 mode "Panorama"



4:3 mode "Normal"



Selected item	Description
Panorama	Wide image without side bars
Normal	Normal range keeping 4:3 or 16:9 aspect ratio

WIDE mode

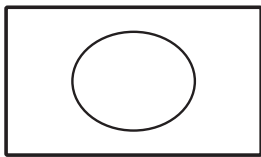
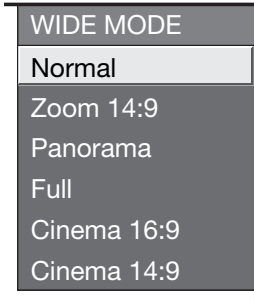
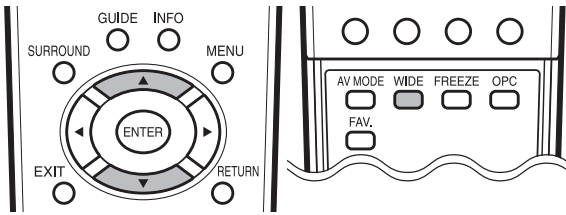

4:3 Mode set to "Panorama"

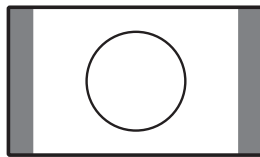

4:3 Mode set to "Normal"

Manual Selection

- 1** Press **WIDE**.
 - The WIDE MODE menu displays.
 - The menu lists the wide mode options selectable for the type of video signal currently received.
- 2** Press **WIDE** or **▲/▼** while the WIDE MODE menu displays on the screen.
 - As you toggle down the options, each mode is immediately reflected on the TV.

Auto Selection

If you set "WSS" and "4:3 Mode" in the Setup menu on page 38, the optimum WIDE mode is automatically chosen for every broadcast containing the WSS information.

"WSS" menu

To enable Auto Selection, set "WSS" in the Setup menu to "On". (See page 38.)

"4:3 Mode" menu

To set the type of the wide screen, select "Panorama" or "Normal" in the 4:3 Mode menu. (See page 38.)

NOTE

- If the broadcast signal contains no WSS information, Auto Selection will not function even when the WSS option is enabled.

Selected item	Description
Normal	For 4:3 "standard" pictures. A side bar appears on each side.
Zoom 14:9	For 14:9 letterbox pictures. A thin side bar appears on each side, and you may also see bars on the top and bottom with some programmes.
Panorama	In this mode the picture is progressively stretched toward each side of the screen.
Full	For 16:9 squeeze pictures.
Cinema 16:9	For 16:9 letterbox pictures. Bars may appear on the top and bottom with some programmes.
Cinema 14:9	For 14:9 letterbox pictures. Bars may appear on the top and bottom with some programmes.

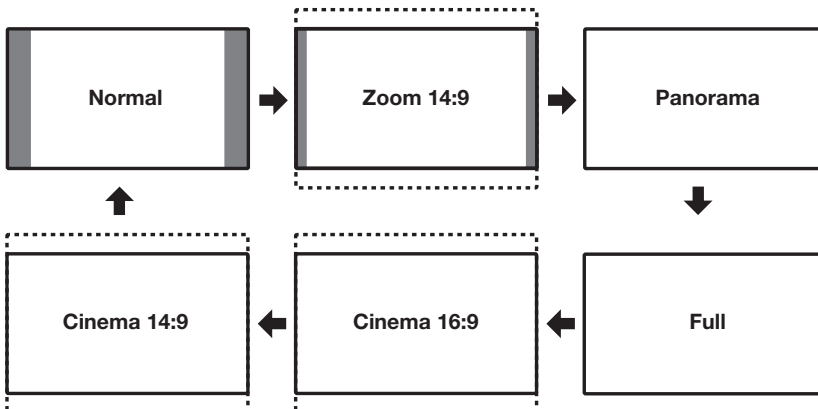

NOTE

- Some screen sizes may not be displayable depending on the input signal.

Useful adjustment settings

Audio Only

When listening to music from a music programme, you can set the display off and enjoy audio only.

- 1 Press **MENU** and the MENU screen displays.
- 2 Press **◀/▶** to select "Option".
- 3 Press **▲/▼** to select "Audio Only", and then press **ENTER**.
- 4 Press **◀/▶** to select "On", and then press **ENTER**.

Selected item	Description
On	Audio is output without screen image.
Off	Both screen images and audio are output.

NOTE

- When you make operations that change the picture on the TV such as by changing the input source, the Audio Only function is set to "Off".

DNR (Digital Noise Reduction)

Produces a clearer video image.

- 1 Press **MENU** and the MENU screen displays.
- 2 Press **◀/▶** to select "Option".
- 3 Press **▲/▼** to select "DNR", and then press **ENTER**.
- 4 Press **▲/▼** to select the desired level, and then press **ENTER**.



HDMI Setup

HDMI (High-Definition Multimedia Interface) terminal selection.

- 1 To watch an HDMI equipment image, select "INPUT3" using **TV/VIDEO** on the remote control unit or on the TV.
- 2 Press **MENU** and the MENU screen displays.
- 3 Press **◀/▶** to select "Option".
- 4 Press **▲/▼** to select "HDMI Setup", and then press **ENTER**.
 - The HDMI Setup can be selected only when "INPUT3" is selected.
- 5 Press **▲/▼** to select the desired item, and then press **ENTER**.

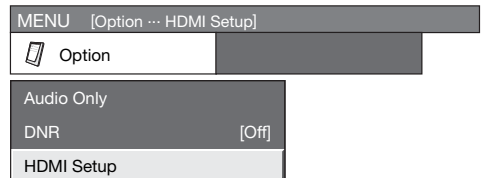

HDMI Setup items	Selectable items	Description
Signal Type	RGB/ YCbCr4:4:4/ YCbCr4:2:2	Select the video signal type from the HDMI terminal.
Auto View	Enable/ Disable	Set whether or not to use WIDE MODE based on signal recognition, including an HDMI signal.
Audio Select	Digital/ Analogue	Select "Digital" for audio signal via the HDMI terminal. Select "Analogue" for audio signal via the AUDIO jack.

- 6 Press **▲/▼/◀/▶** to select the desired setting, and then press **ENTER**.

NOTE

- Refer to your external equipment operation manual for the signal type.
- Item under "Signal Type" can be selected when the equipment is connected with a DVI-HDMI conversion cable.
- When the equipment is connected with an HDMI cable, items are automatically set and cannot be selected.

Useful adjustment settings

Input Select

Selecting input source

Can use for selecting the input source.



1 Press **TV/VIDEO** on the remote control unit or **TV/VIDEO** on the TV.

2 Press **TV/VIDEO** on the remote control unit or **TV/VIDEO** on the TV to select the input source.

- An image from the selected source automatically displays.
- You can also select the input source by pressing **▲/▼**.

Selecting input signal type

For setting the signal type of external equipment.

1 Press **MENU** and the MENU screen displays.

2 Press **◀/▶** to select "Option".

3 Press **▲/▼** to select "Input Select", and then press **ENTER**.

4 Press **▲/▼** to select a signal type you want to set, and then press **ENTER**.

Input source	Selectable item
INPUT 1	AUTO, COMPONENT, VIDEO
INPUT 2	AUTO, COMPONENT, VIDEO

NOTE

- **If no (colour) image displays, try to change the other signal type.**
- Check the operation manual of the external equipment for the signal type.
- When the signal type is set to "AUTO", the input terminal where cable is connected is automatically selected.
- When the signal type is set to "AUTO" and multiple video signal cables are connected, the signal type is selected in the following prioritised order:
INPUT 1/INPUT 2: COMPONENT→VIDEO

Colour system setting

You can change the colour system to one that is compatible with the image on the screen.

1 Press **MENU** and the MENU screen displays.

2 Press **◀/▶** to select "Option".

3 Press **▲/▼** to select "Colour System", and then press **ENTER**.

4 Press **▲/▼** to select a compatible video signal system of your equipment, and then press **ENTER**.

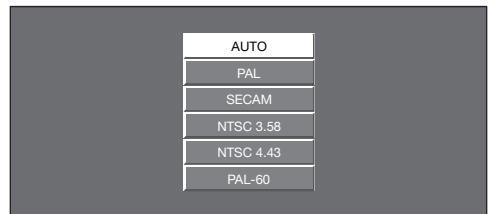

NOTE

- Factory preset value is "AUTO".
- If "AUTO" is selected, colour system for each channel is automatically set. If an image does not display clearly, select another colour system (e.g. PAL, NTSC 4.43).

Useful features

Teletext language setting

If Teletext information does not display correctly, perform the setting procedure below. Select from among 4 kinds of language tables: West Europe, East Europe, Greek/Turkish, Cyrillic. Each table is compatible with the Teletext languages listed below.

1 Press **MENU** and the MENU screen displays.

2 Press **◀/▶** to select "Setup".

3 Press **▲/▼** to select "Text Language", and then press **ENTER**.

4 Press **▲/▼** to select receivable teletext broadcasting language in your country, and then press **ENTER**.

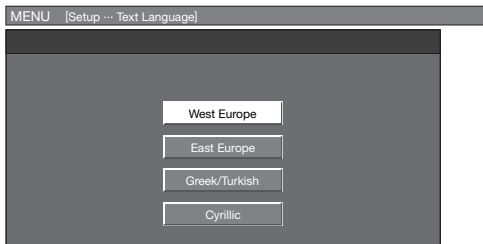

- West Europe — English, French, Scandinavian, Czech, German, Spanish, Italian
- East Europe — Polish, French, Scandinavian, Czech, German, Slovenian/Croatian, Italian, Rumanian
- Greek/Turkish — English, French, Scandinavian, Turkish, German, Spanish, Italian, Greek
- Cyrillic — English, Russian, Estonian, Czech, German, Spanish, Ukrainian, Lettish

NOTE

- Teletext can display only when it is sent by a network. Not used to convert between languages.

Teletext function

What is Teletext?



Teletext broadcasts pages of information and entertainment to specially equipped television sets. Your TV receives Teletext signals broadcast by a TV network, and decodes them into graphical format for viewing. News, weather reports, sports information, stock exchange prices and programme previews are among the many services available.

Teletext mode

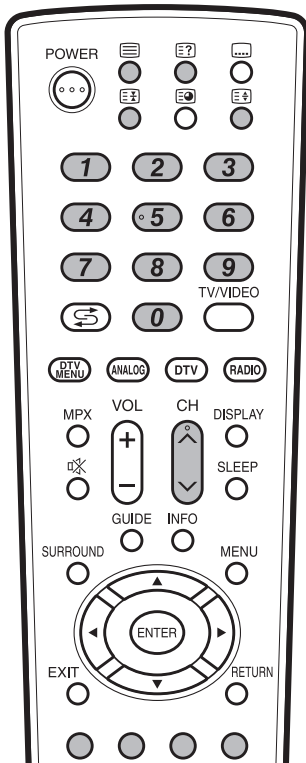
Teletext is turned on/off with  on the remote control unit. You can operate your TV in Teletext mode directly by inputting commands with the remote control unit.



Turning on and off Teletext

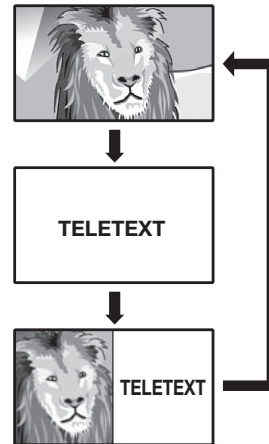

- 1 Select a TV channel or external input source providing the Teletext programme.
- 2 Press  to display the Teletext.
- 3 Press  again to display the Teletext on the right screen and normal image on the left screen.
 - Each time you press , the screen switches as shown upper right.
 - If you select a programme with no Teletext signal, "No Teletext available." is displayed.
 - The same message displays during other modes if no Teletext signal is available.



NOTE

- This dual screen cannot be displayed in DTV mode.

When viewing the Teletext information

- Press **CH**  to increase the page number.
- Press **CH**  to decrease the page number.

Button functions

Colour (Red/Green/Yellow/Blue):

You can select a group or block of pages displayed in the coloured brackets at the bottom of the screen by pressing the corresponding **Colour (Red/Green/Yellow/Blue)** on the remote control unit.

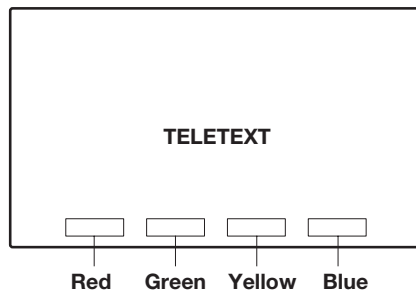

0 – 9:

Directly select any page from 100 to 899 by using **0** – **9**.

(Top/Bottom/Full):

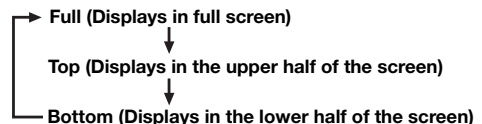

Each time you press , the TELETEXT image switches as shown below.



NOTE

- This function is not available in DTV mode.

(Reveal hidden for TELETEXT):

To reveal hidden information such as an answer to a quiz, press . Press  again to hide the information.

(Hold):

To stop updating Teletext pages automatically, press . Press  again to release the hold mode.

Useful features

Displaying Subtitle

You can display several subtitles as they are transmitted.

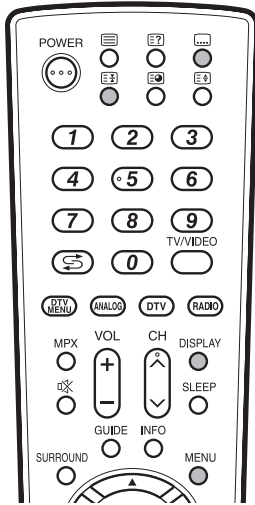

- 1 Press **SUBTITLE** to display the subtitle.
 - Subtitle is updated by information sent by the broadcasting station.
 - To stop updating subtitle automatically, press **STOP**.

- 2 Press **SUBTITLE** to exit the subtitle screen.

NOTE

- Subtitle will not be displayed when the service does not contain the subtitle information.

Time display

You can display the time information included in the Teletext broadcast.

NOTE

- Skip step 1 if receiving DTV broadcasts.

- 1 Select a TV channel providing Teletext information. (The time information is automatically captured.)
- 2 Press **DISPLAY**. The channel display will appear on the display.
- 3 Press **DISPLAY** again within the three-second interval the channel display is on the screen. Time information will display on the lower left of the screen for about three seconds.
- 4 Even when you change the TV channel, you can display the time information with steps 2 to 3 above.

NOTE

- The time display cannot be stored once the power is turned off. When you turn on the power, perform steps 1 to 4 again.
- If acquired successfully the time information will appear in the upper-right corner of the screen by pressing **MENU**.

Displaying Subpages

You can display several subpages as they are transmitted.

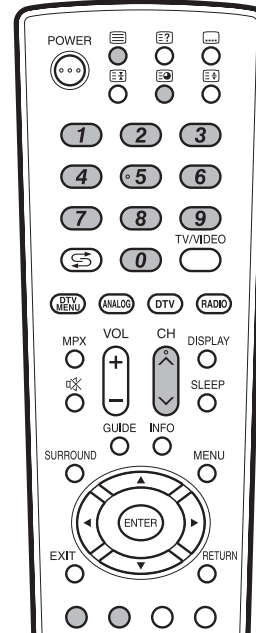

- 1 Press **TELETEXT** to display Teletext.

- 2 Press **TELETEXT** to display the subpage as shown below.

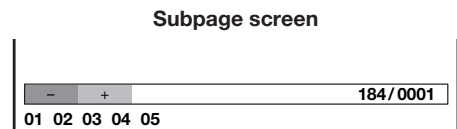

- 3 Select the desired subpage by using **CH** / **CH**, **Red** or **Green**.

- **0 – 9** directly selects the desired subpage.

- 4 Press **TELETEXT** to exit the subpage screen.

NOTE

- You cannot display subpage screens in DTV mode.

Using external equipment

You can connect many types of external equipment to your TV, like a VCR, DVD player, HDTV tuner, game console and camcorder. To view external source images, select the input source from **TV/VIDEO** on the remote control unit or **TV/VIDEO** on the TV.

Displaying an external equipment image

Explanation here is for the setting when connecting DVD to INPUT1 terminal.

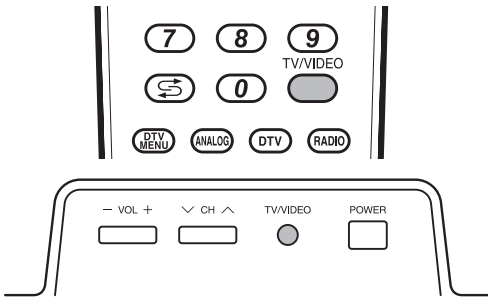

CAUTION

- To protect all equipment, always turn off the TV before connecting to a VCR, DVD player, HDTV tuner, game console, camcorder or other external equipment.

NOTE

- See pages 45 to 47 for external equipment connection.
- Please refer to the relevant operation manual (VCR, DVD player, etc.) carefully before making connections.
- Each time **TV/VIDEO** is pressed, the input source toggles.
- If the image does not come in clearly, you may need to change the input signal type setting on the "Input Select" menu.
- Refer to your external equipment operation manual for the signal type.

Displaying a DVD image (Example)

- To watch a DVD image, select "INPUT1" using **TV/VIDEO** on the remote control unit or **TV/VIDEO** on the TV.

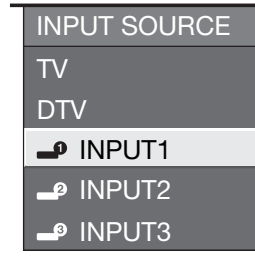

- Select the desired signal type on "Input Select" in the "Option" menu. (See page 41.)

For INPUT1 signal

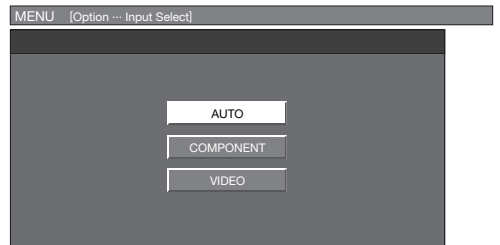

The setting is stored and can be selected.

Connecting a VCR

You can use the INPUT 1 terminals when connecting a VCR and other audiovisual equipment.

To watch an image from this input terminal, you need to select the input source (see page 45) and the input signal type (see page 41).

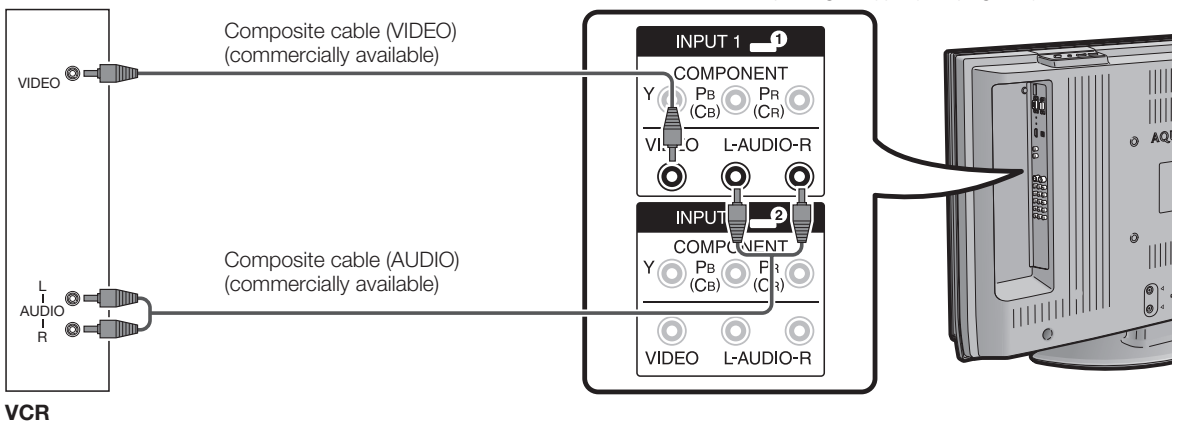

VCR

Using external equipment

Connecting a DVD player

You can use the INPUT 1 or INPUT 3 (HDMI) terminals when connecting to a DVD player and other audiovisual equipment.

NOTE

- When using a DVI-HDMI conversion adaptor, input the Audio Signal from the AUDIO terminal of INPUT 3.

DVD player

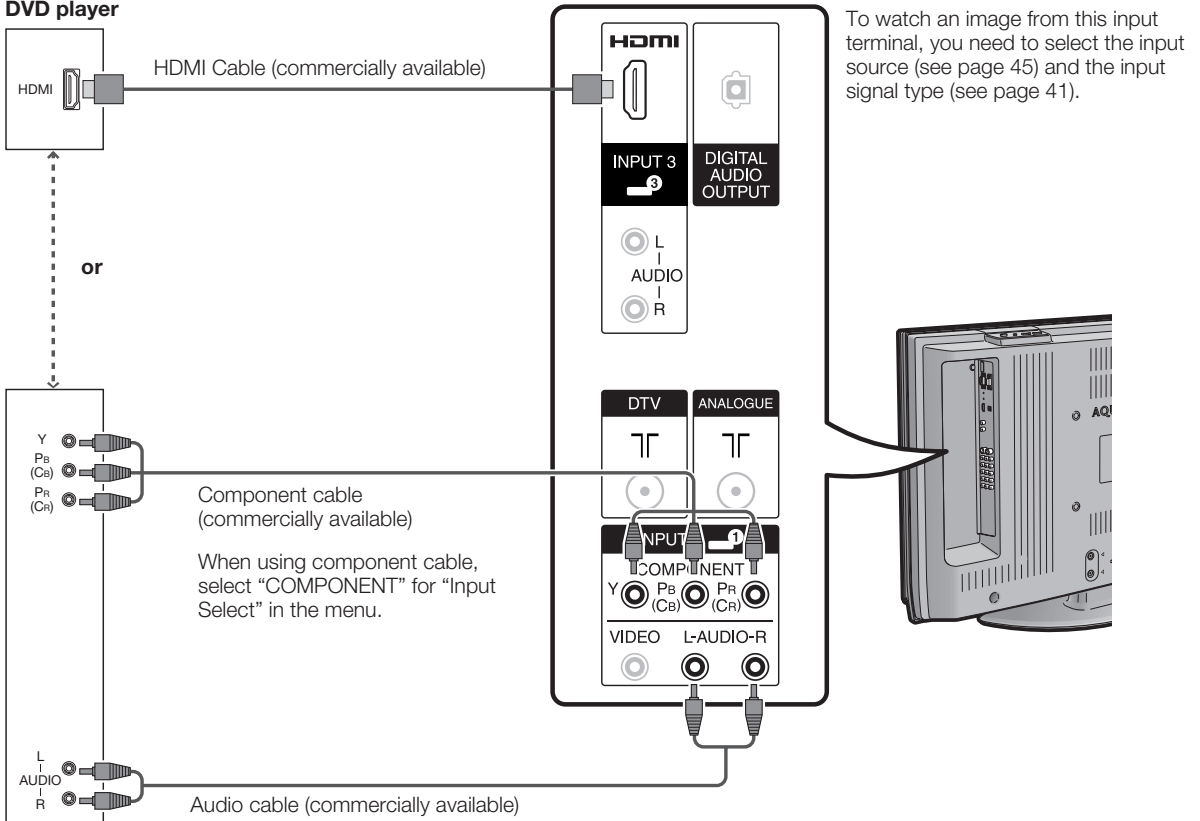

Connecting a game console or camcorder

A game console, camcorder and some other audiovisual equipment are conveniently connected using the INPUT 2 terminals.

To watch an image from this input terminal, you need to select the input source (see page 45) and the input signal type (see page 41).

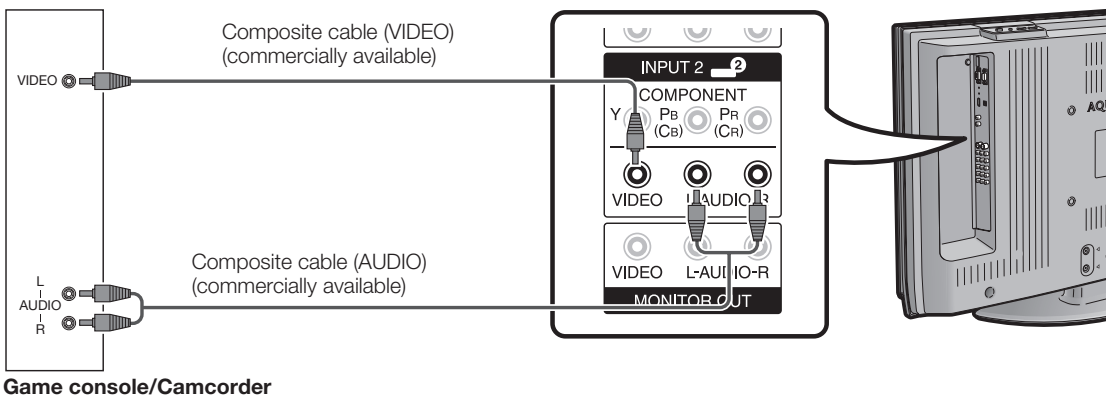

Using external equipment

Connecting an HDTV tuner

You can use the INPUT 2 terminal when connecting to an HDTV tuner and other audiovisual equipment.

To watch an image from this input terminal, you need to select the input source (see page 45) and the input signal type (see page 41).

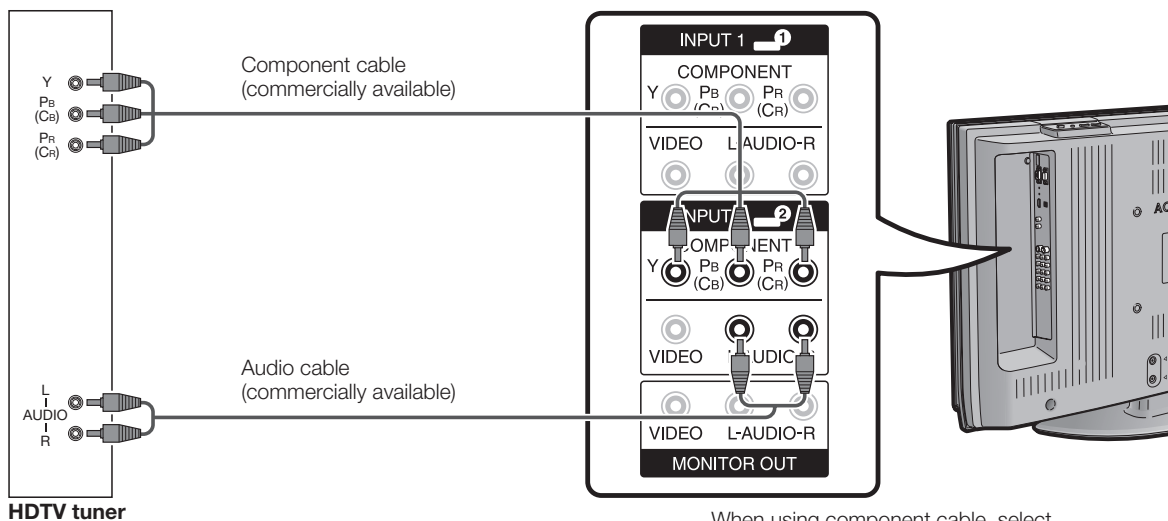

Appendix

Troubleshooting

Problem	Possible Solution
<ul style="list-style-type: none"> No power. 	<ul style="list-style-type: none"> Check if you pressed POWER on the remote control unit. (See page 13.) If the indicator on the TV lights up red, press POWER. Is the AC cord disconnected? (See page 7.) Has the power been turned on? (See page 13.)
<ul style="list-style-type: none"> Unit cannot be operated. 	<ul style="list-style-type: none"> External influences such as lightning, static electricity, etc., may cause improper operation. In this case, operate the unit after first turning the power off the TV or unplugging the AC cord and re-plugging it in after 1 or 2 minutes.
<ul style="list-style-type: none"> Remote control unit does not operate. 	<ul style="list-style-type: none"> Are batteries inserted with polarity (+, -) aligned? (See page 5.) Are batteries worn out? (Replace with new batteries.) Are you using it under strong or fluorescent lighting? Is a fluorescent light illuminated to remote control sensor?
<ul style="list-style-type: none"> Picture is cut off. 	<ul style="list-style-type: none"> Is the image position correct? (See page 37.) Are screen mode adjustments such as picture size made correctly? (See pages 38 and 39.)
<ul style="list-style-type: none"> Strange colour, light colour, or dark, or colour misalignment. 	<ul style="list-style-type: none"> Adjust the picture tone. (See pages 25 to 27 and 40.) Is the room too bright? The picture may look dark in a room that is too bright. Check the colour system setting. (See pages 21 and 41.) Check the input signal setting. (See page 41.) Check the HDMI Setup setting. (See page 40.)
<ul style="list-style-type: none"> Power is suddenly turned off. 	<ul style="list-style-type: none"> The unit's internal temperature has increased. Remove any objects blocking vent or clean. Check the power control setting. (See page 28.) Is sleep timer set? (See page 15.)
<ul style="list-style-type: none"> No picture. 	<ul style="list-style-type: none"> Is connection to other equipment correct? (See pages 45 to 47.) Has input signal setup been done correctly after connection? (See page 41.) Is the correct input selected? (See page 41.) Is picture adjustment correct? (See pages 25 to 27.) Is the antenna connected properly? (See page 8.) Is "On" selected in "Audio Only"? (See page 40.)
<ul style="list-style-type: none"> No sound. 	<ul style="list-style-type: none"> Is the volume too low? (See page 15.)

Troubleshooting (DTV)

Problem	Possible Solution
<ul style="list-style-type: none"> No picture or no sound. 	<ul style="list-style-type: none"> Is the correct input source selected? (See pages 41 and 45.)
<ul style="list-style-type: none"> Block noise appears on the screen. 	<ul style="list-style-type: none"> Is the antenna pointing in the correct direction? Check the Signal Level and Quality. (See page 32.) Are physical objects blocking the antenna? Is the antenna or antenna cable compatible with DTV broadcasts?
<ul style="list-style-type: none"> DTV broadcasts cannot be received. 	<ul style="list-style-type: none"> Is the DTV antenna set up properly? Is the antenna cable connected properly? (See page 8.) Are the channel settings correct? (See pages 32 and 33.)
<ul style="list-style-type: none"> A specific channel cannot be received. 	<ul style="list-style-type: none"> Check the Signal Level and Quality. (See page 32.)

Cautions regarding use in high and low temperature environments

- When the unit is used in a low temperature space (e.g. room, office), the picture may leave trails or appear slightly delayed. This is not a malfunction, and the unit will recover when the temperature returns to normal.
 - Do not leave the unit in a hot or cold location. Also, do not leave the unit in a location exposed to direct sunlight or near a heater, as this may cause the cabinet to deform and the LCD panel to malfunction.
- Storage temperature: -20°C to +60°C.

RS-232C port specifications

PC Control of the TV

- When a programme is set, the TV can be controlled from the PC using the RS-232C terminal. The input signal (PC/video) can be selected, the volume can be adjusted and various other adjustments and settings can be made, enabling automatic programmed playing.
- Attach an RS-232C cable cross-type (commercially available) to the supplied Din/D-sub RS-232C for the connections.

NOTE

- This operation system should be used by a person who is accustomed to using PCs.

Communication conditions

Set the RS-232C communications settings on the PC to match the communications conditions of the TV. The communications settings of the TV are as follows:

Baud rate:	9,600 bps
Data length:	8 bits
Parity bit:	None
Stop bit:	1 bit
Flow control:	None

Communication procedure

Send the control commands from the PC via the RS-232C connector.

The TV operates according to the received command and sends a response message to the PC.

Do not send multiple commands at the same time. Wait until the PC receives the OK response before sending the next command.

Command format

Eight ASCII codes + CR

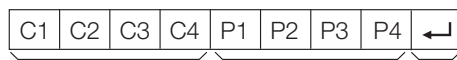

Command 4-digits Parameter 4-digits Return code

Command 4-digits: Command. The text of four characters.
Parameter 4-digits: Parameter 0 — 9, space, ?

Parameter

Input the parameter values, aligning left, and fill with space(s) for the remainder. (Be sure that four values are input for the parameter.)

When the input parameter is not correct, "ERR" returns. (Refer to "Response code format".)

0			
0	0	0	9
-	3	0	
1	0	0	
0	0	5	5

When "?" is input for some commands, the present setting value responds.

?			
?	?	?	?

Appendix

Response code format

Normal response



Return code (ODH)

Problem response (communication error or incorrect command)



Return code (ODH)

Commands

- Commands not indicated here are not guaranteed to operate.

CONTROL ITEM	COMMAND	PARAMETER	CONTROL CONTENTS
POWER SETTING	P O W R	0 _ _ _	POWER OFF (STANDBY)
INPUT SELECTION A	I T G D	_ _ _ _	INPUT SWITCHING (TOGGLE)
	I T V D	_ _ _ _	TV (CHANNEL FIXED)
	I D T V	_ _ _ _	DTV (CHANNEL FIXED)
	I A V D	* _ _ _	INPUT1 - 3 (1 - 3)
CHANNEL	D C C H	* * _ _	TV DIRECT CHANNEL (1 - 99)
	C H U P	_ _ _ _	CHANNEL UP
	C H D W	_ _ _ _	CHANNEL DOWN
	D T V D	* * * _	DTV DIRECT CHANNEL (1 - 999)
	D T U P	_ _ _ _	DTV CHANNEL UP
	D T D W	_ _ _ _	DTV CHANNEL DOWN
	INPUT SELECTION B	I N P 1	0 _ _ _
I N P 1		1 _ _ _	INPUT1 (COMPONENT)
I N P 1		3 _ _ _	INPUT1 (VIDEO)
I N P 2		0 _ _ _	INPUT2 (AUTO)
I N P 2		1 _ _ _	INPUT2 (COMPONENT)
I N P 2		3 _ _ _	INPUT2 (VIDEO)
AV MODE SELECTION	A V M D	0 _ _ _	TOGGLE
	A V M D	1 _ _ _	STANDARD
	A V M D	2 _ _ _	MOVIE
	A V M D	3 _ _ _	GAME
	A V M D	4 _ _ _	USER
	A V M D	5 _ _ _	DYNAMIC

CONTROL ITEM	COMMAND	PARAMETER	CONTROL CONTENTS
VOLUME	V O L M	* * _ _	VOLUME (0 - 60)
POSITION	H P O S	* * * _	H-POSITION (AV) (-10 - +10)
	V P O S	* * * _	V-POSITION (AV) (-20 - +20)
WIDE MODE	W I D E	0 _ _ _	TOGGLE (AV)
	W I D E	1 _ _ _	NORMAL (AV)
	W I D E	2 _ _ _	ZOOM 14:9 (AV)
	W I D E	3 _ _ _	PANORAMA (AV)
	W I D E	4 _ _ _	FULL (AV)
	W I D E	5 _ _ _	CINEMA 16:9 (AV)
MUTE	W I D E	6 _ _ _	CINEMA 14:9 (AV)
	M U T E	0 _ _ _	TOGGLE
	M U T E	1 _ _ _	MUTE ON
SURROUND	M U T E	2 _ _ _	MUTE OFF
	A C S U	0 _ _ _	SURROUND TOGGLE
	A C S U	1 _ _ _	SURROUND ON
AUDIO CHANGE	A C S U	2 _ _ _	SURROUND OFF
	A C H A	_ _ _ _	TOGGLE
SLEEP TIMER	O F T M	0 _ _ _	OFF
	O F T M	1 _ _ _	SLEEP TIMER 30 MIN
	O F T M	2 _ _ _	SLEEP TIMER 1 HOUR
	O F T M	3 _ _ _	SLEEP TIMER 1 HOUR 30 MIN
	O F T M	4 _ _ _	SLEEP TIMER 2 HOUR
	O F T M	5 _ _ _	SLEEP TIMER 2 HOUR 30 MIN
TEXT	T E X T	0 _ _ _	TEXT OFF
	T E X T	1 _ _ _	TEXT ON (TOGGLE)
	D C P G	* * * _	DIRECT PAGE JUMP (100 - 899)

NOTE

- If an underbar (_) appears in the parameter column, enter a space.
- If an asterisk (*) appears, enter a value in the range indicated in brackets under CONTROL CONTENTS.

Specifications

Item		Model	
		LC-32PD5X	LC-37PD5X
LCD panel		32" (80 cm) Advanced Super View & BLACK TFT LCD	37" (94 cm) Advanced Super View & BLACK TFT LCD
Number of dots		3,147,264 dots (1366 × 768 × 3 dots)	
Video Colour System		PAL/SECAM/NTSC 3.58/NTSC 4.43/PAL 60	
TV Function	TV-Standard	PAL: B/G, D/K, I SECAM: B/G, D/K, K/K ₁ NTSC: M	
	Receiving Channel	VHF/UHF	44.25—863.25 MHz
		CATV	S1—S41ch (including Hyperband)
	Digital Terrestrial Broadcast	VHF 48—80 MHz, VHF 149—429 MHz, UHF 429—860 MHz	
	TV-Tuning System	Auto Preset 99 ch	
	STEREO/BILINGUAL	NICAM: B/G, I, D/K A2 stereo: B/G MTS	
Brightness		450 cd/m ²	
Backlight life		60,000 hours (at Backlight Standard position)	
Viewing angles		H : 176° V : 176°	
Audio amplifier		10W × 2	
Speakers		10 × 4 cm 4pcs	
Terminals	Rear	ANALOGUE ANTENNA IN	75 Ω DIN type
		DIGITAL ANTENNA IN	75 Ω DIN type
		INPUT 1	VIDEO in, AUDIO in, COMPONENT in (480I, 576I, 480P, 576P, 720P/50Hz, 720P/60Hz, 1080I/50Hz, 1080I/60Hz)
		INPUT 2	VIDEO in, AUDIO in, COMPONENT in (480I, 576I, 480P, 576P, 720P/50Hz, 720P/60Hz, 1080I/50Hz, 1080I/60Hz)
		INPUT 3	HDMI (HDMI input) (480I, 576I, 480P, 576P, 720P/50Hz, 720P/60Hz, 1080I/50Hz, 1080I/60Hz), AUDIO in
		MONITOR OUTPUT	VIDEO out, AUDIO out
		RS-232C	9 pin D-sub male connector
		DIGITAL AUDIO OUTPUT	Optical Digital audio output
Power Requirement		AC 110—240 V, 50 Hz	
Power Consumption		150 W (1.0 W Standby)	185 W (1.0 W Standby)
Weight	without stand	17.4 kg	21.4 kg
	with stand	19.5 kg	24.0 kg
Operating Temperature		0°C — 40°C	

- As a part of policy of continuous improvement, SHARP reserves the right to make design and specification changes for product improvement without prior notice. The performance specification figures indicated are nominal values of production units. There may be some deviations from these values in individual units.

Optional accessory

The listed optional accessory is available for the LCD colour TV. Please purchase it at your nearest shop.

- Additional optional accessories may be available in the near future. When purchasing, please read the newest catalogue for compatibility and check the availability.

Part name	Model number
Wall mount bracket (for LC-32PD5X/ LC-37PD5X)	AN-37AG2

Dimensional drawings

LC-32PD5X, LC-37PD5X

Unit: mm

NOTE

- Figures within parentheses are for LC-37PD5X.

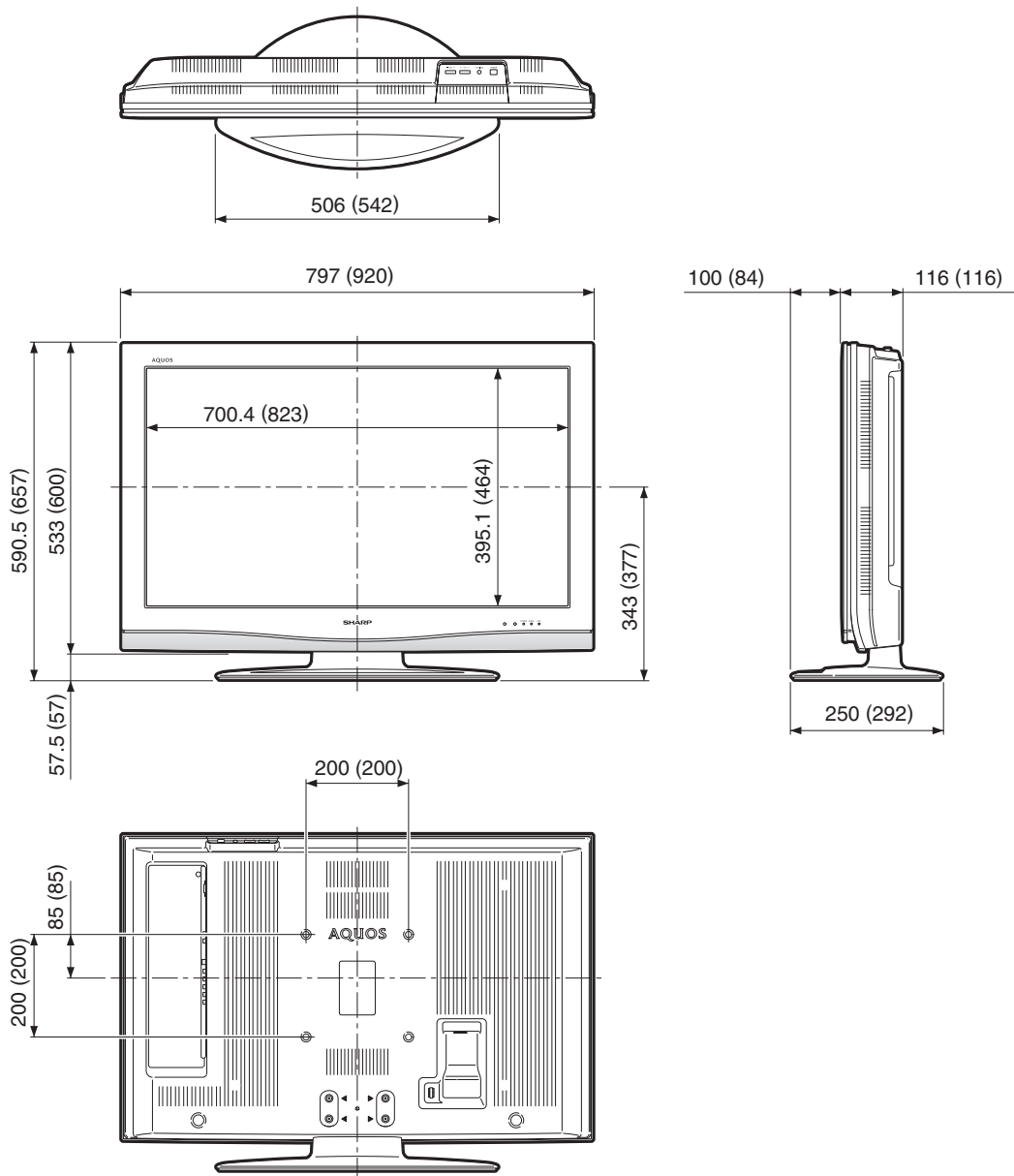

HOW TO SET THE FACTORY PRESETS

Turn off the TV by pressing **POWER** on the TV.

After waiting for about 1 minute, press and hold down **RESET** and press **POWER** on the TV to turn on the TV.

All setting items (except TV channel) return to the factory presetting.

NOTE

- Password will be cleared after running the factory presetting operation.

You can run the Auto Installation again by using the following steps.

- 1 Turn on the power of the TV.
- 2 Press **MENU**. (Make sure the menu screen displays.)
- 3 Press ◀▶ to select "Setup".
- 4 Press ▲/▼ to select "Auto Installation", and then press **ENTER**.
- 5 Press ◀▶ to select "Yes", and then press **ENTER**.



The Password is

--	--	--	--

NOTE

- As a precautionary measure, make a note of your password above, scissor it from this manual, and keep it in a familiar place.

Memo

Memo

Memo

SHARP

FOR LOCATION ENQUIRIES WITHIN

AUSTRALIA

REGARDING YOUR LOCAL

SHARP APPROVED SERVICE CENTRE

VISIT OUR WEBSITE AT

www.sharp.net.au

OR CALL SHARP CUSTOMER CARE

1300 135 022

(LOCAL CALL COST APPLY WITHIN AUSTRALIA)

SHARP CORPORATION OF AUSTRALIA PTY LTD

SHARP

FOR LOCATION ENQUIRIES WITHIN

NEW ZEALAND

REGARDING YOUR LOCAL

SHARP APPROVED SERVICE CENTRE

VISIT OUR WEBSITE AT

www.sharp.net.nz

CONTACT YOUR SELLING DEALER/RETAILER

OR CALL

SHARP CUSTOMER SERVICES

TELEPHONE: 09 573 0111

FACSIMILE: 09 573 0113

SHARP CORPORATION OF NEW ZEALAND LIMITED

SHARP

WARRANTY

Consumer Electronic Products

Congratulations on Your Purchase!

This Sharp product is warranted against faults in materials and manufacture for a period of twelve (12) months from the date of original purchase.

If service is required during the warranty period, please contact your nearest Sharp Approved Service Centre. These repairs would be carried out at no charge to the owner, subject to the conditions specified herein.

The owner is responsible for any transportation and insurance costs if the product has to be returned for repair.

This warranty does not extend to accessories or defects or injuries caused by or resulting from causes not attributable to faulty parts or the manufacture of the product, including but not limited to, defect or injury caused by or resulting from misuse, abuse, neglect, accidental damage, improper voltage, liquid spillage, vermin infestation, software, or any alterations made to the product which are not authorised by Sharp.

Please retain your sales documentation, as this should be produced to validate a warranty claim.

This warranty is in addition to and in no way limits, varies or excludes any express and implied rights and remedies under any relevant legislation in the country of sale.

IMPORTANT DO NOT RETURN THIS DOCUMENT TO SHARP

For your reference, please enter the particulars of your purchase below and retain, with your purchase documentation.

Model No. _____

Serial No. _____

Date of Purchase _____

Retailer _____

SHARP
SHARP CORPORATION OF AUSTRALIA PTY. LIMITED
ABN 40 003 039 405
1 Huntingwood Drive
Huntingwood NSW2148
SHARP CORPORATION OF NEW ZEALAND LIMITED
59 Hugo Johnston Drive
Penrose, Auckland
SPform030 (JUNE 2004)

IMPORTANT NOTICE: This warranty applies only to products sold in Australia & New Zealand

SHARP®

SHARP CORPORATION



Printed on post-consumer recycled paper.

Printed in Malaysia
TINS-C984WJZZ
07P01-MA-NG

Free Manuals Download Website

<http://myh66.com>

<http://usermanuals.us>

<http://www.somanuals.com>

<http://www.4manuals.cc>

<http://www.manual-lib.com>

<http://www.404manual.com>

<http://www.luxmanual.com>

<http://aubethermostatmanual.com>

Golf course search by state

<http://golfingnear.com>

Email search by domain

<http://emailbydomain.com>

Auto manuals search

<http://auto.somanuals.com>

TV manuals search

<http://tv.somanuals.com>