

SHARP
SHARP ELECTRONICS CORPORATION
Sharp Plaza, Mahwah, New Jersey 07430-2135
SHARP CORPORATION

LC-20S5U

OPERATION MANUAL
MODE D'EMPLOI
MANUAL DE OPERACIÓN
MANUAL DE OPERAÇÃO

SHARP

SHARP

LC-20S5U

LIQUID CRYSTAL TELEVISION
TÉLÉVISEUR ACL
TELEVISOR CON PANTALLA DE
CRISTAL LÍQUIDO
TELEVISOR DE CRISTAL LÍQUIDO

OPERATION MANUAL
MODE D'EMPLOI
MANUAL DE OPERACIÓN
MANUAL DE OPERAÇÃO

AQUOS

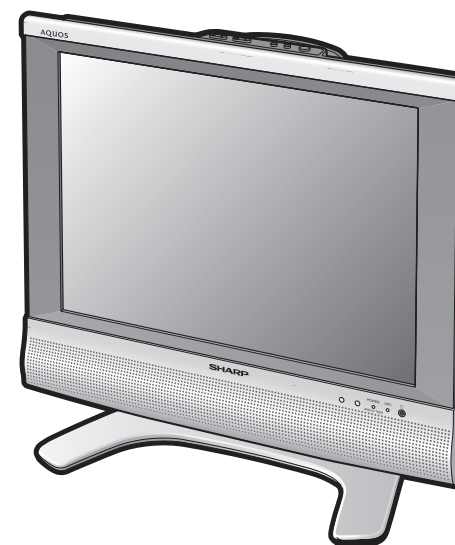

ENHANCED DEFINITION TELEVISION
EDTV
MONITOR

NOM 1245



Printed in Mexico
Imprimé au Mexique
Impreso en México
Impresso no México
TINS-C234WJZZ
06P02-MX-11M



Products that have earned the ENERGY STAR® are designed to protect the environment through superior energy efficiency.
Les produits agréés ENERGY STAR® sont conçus pour protéger l'environnement par un rendement énergétique supérieur.

ENGLISH

FRANÇAIS

ESPAÑOL

PORTUGUÊS

Dimensional Drawings

Unit: inch (mm)

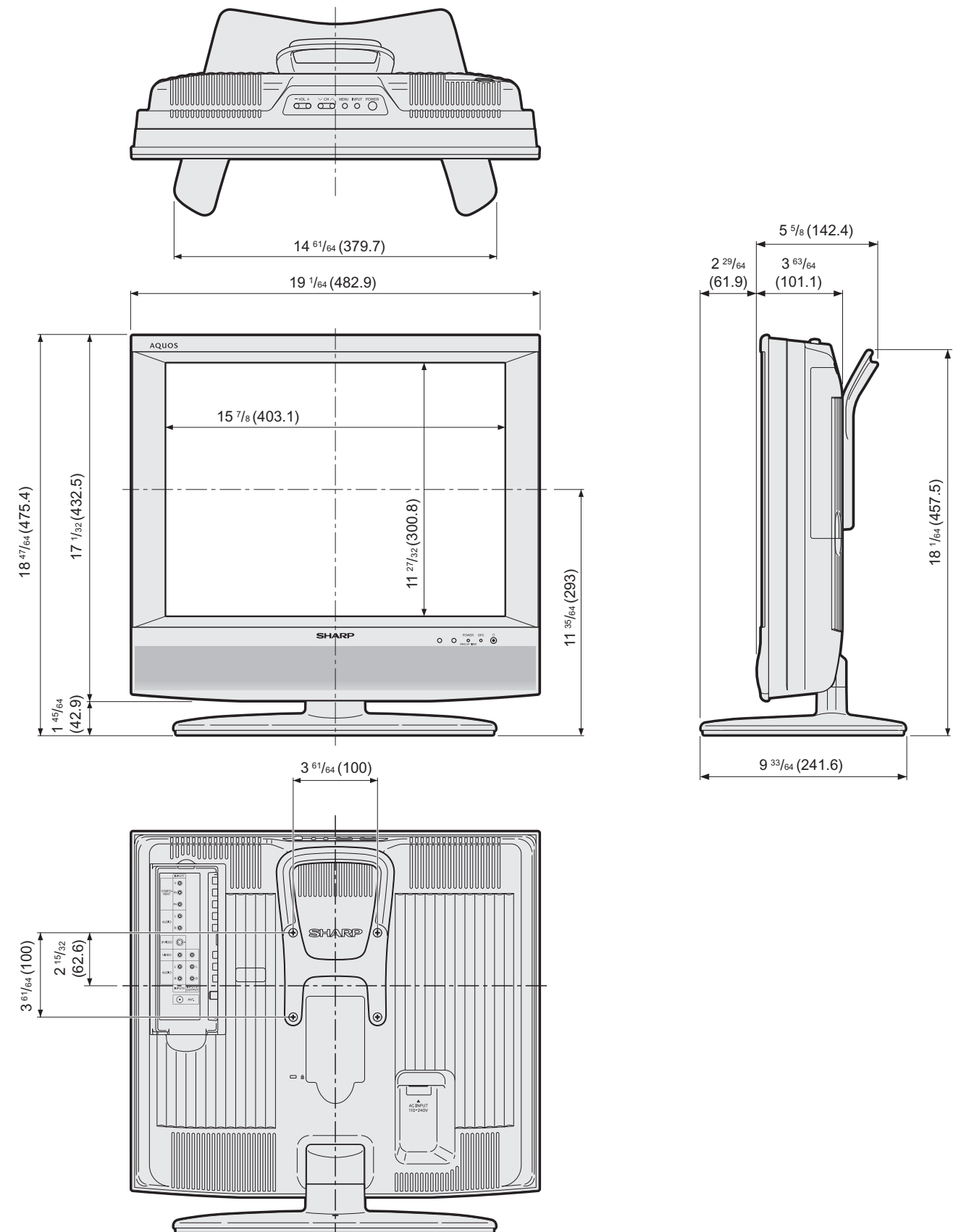

LC-20S5U

OPERATION MANUAL

ENGLISH

IMPORTANT:



To aid reporting in case of loss or theft, please record the TV's model and serial numbers in the space provided. The numbers are located at the rear of the TV.

Model No.:

Serial No.:

IMPORTANT INFORMATION

WARNING: TO REDUCE THE RISK OF FIRE OR ELECTRIC SHOCK, DO NOT EXPOSE THIS PRODUCT TO RAIN OR MOISTURE.

	CAUTION RISK OF ELECTRIC SHOCK DO NOT OPEN	
CAUTION: TO REDUCE THE RISK OF ELECTRIC SHOCK, DO NOT REMOVE COVER (OR BACK). NO USER-SERVICEABLE PARTS INSIDE. REFER SERVICING TO QUALIFIED SERVICE PERSONNEL.		



The lightning flash with arrow-head symbol, within an equilateral triangle, is intended to alert the user to the presence of uninsulated "dangerous voltage" within the product's enclosure that may be of sufficient magnitude to constitute a risk of electric shock to persons.



The exclamation point within a triangle is intended to alert the user to the presence of important operating and maintenance (servicing) instructions in the literature accompanying the product.

CAUTION: TO PREVENT ELECTRIC SHOCK, MATCH WIDE BLADE OF PLUG TO WIDE SLOT, FULLY INSERT.

CAUTION:

DO NOT PLACE THIS PRODUCT ON AN UNSTABLE CART, STAND, TRIPOD, BRACKET, OR TABLE. THE PRODUCT MAY FALL CAUSING SERIOUS PERSONAL INJURY AND SERIOUS DAMAGE TO THE PRODUCT. USE ONLY WITH A CART, STAND, TRIPOD, BRACKET, OR TABLE RECOMMENDED BY THE MANUFACTURER OR SOLD WITH THE PRODUCT. FOLLOW THE MANUFACTURER'S INSTRUCTIONS WHEN INSTALLING THE PRODUCT AND USE MOUNTING ACCESSORIES RECOMMENDED BY THE MANUFACTURER. A PRODUCT AND CART COMBINATION SHOULD BE MOVED WITH CARE. QUICK STOPS, EXCESSIVE FORCE, AND UNEVEN SURFACES MAY CAUSE THE PRODUCT AND CART COMBINATION TO OVERTURN.



WARNING: FCC Regulations state that any unauthorized changes or modifications to this equipment not expressly approved by the manufacturer could void the user's authority to operate this equipment.

U.S.A. ONLY

"Note to CATV system installer: This reminder is provided to call the CATV system installer's attention to Article 820-40 of the National Electrical Code that provides guidelines for proper grounding and, in particular, specifies that the cable ground shall be connected to the grounding system of the building, as close to the point of cable entry as practical."

U.S.A. ONLY

This product utilizes tin-lead solder, and fluorescent lamp containing a small amount of mercury. Disposal of these materials may be regulated due to environmental considerations. For disposal or recycling information, please contact your local authorities or the Electronic Industries Alliance: www.eia.org

DEAR SHARP CUSTOMER

Thank you for your purchase of the Sharp Liquid Crystal Television. To ensure safety and many years of trouble-free operation of your product, please read the Important Safety Precautions carefully before using this product.

IMPORTANT SAFETY PRECAUTIONS

Electricity is used to perform many useful functions, but it can also cause personal injuries and property damage if improperly handled. This product has been engineered and manufactured with the highest priority on safety. However, improper use can result in electric shock and/or fire. In order to prevent potential danger, please observe the following instructions when installing, operating and cleaning the product. To ensure your safety and prolong the service life of your LCD color TV product, please read the following precautions carefully before using the product.

- Read instructions—All operating instructions must be read and understood before the product is operated.
- Keep this manual in a safe place—These safety and operating instructions must be kept in a safe place for future reference.
- Observe warnings—All warnings on the product and in the instructions must be observed closely.
- Follow instructions—All operating instructions must be followed.
- Attachments—Do not use attachments not recommended by the manufacturer. Use of inadequate attachments can result in accidents.
- Power source—This product must operate on a power source specified on the specification label. If you are not sure of the type of power supply used in your home, consult your dealer or local power company. For units designed to operate on batteries or another power source, refer to the operating instructions.
- AC cord protection—The AC cord must be routed properly to prevent people from stepping on it or objects from resting on it. Check the cord at the plugs and product.
- Overloading—Do not overload AC outlets or extension cords. Overloading can cause fire or electric shock.
- Entering of objects and liquids—Never insert an object into the product through vents or openings. High voltage flows in the product, and inserting an object can cause electric shock and/or short internal parts. For the same reason, do not spill water or liquid on the product.
- Servicing—Do not attempt to service the product yourself. Removing covers can expose you to high voltage and other dangerous conditions. Request a qualified service person to perform servicing.
- Repair—If any of the following conditions occurs, unplug the AC cord from the AC outlet, and request a qualified service person to perform repairs.
 - a. When the AC cord or plug is damaged.
 - b. When a liquid was spilled on the product or when objects have fallen into the product.
 - c. When the product has been exposed to rain or water.
 - d. When the product does not operate properly as described in the operating instructions.
Do not touch the controls other than those described in the operating instructions. Improper adjustment of controls not described in the instructions can cause damage, which often requires extensive adjustment work by a qualified technician.
 - e. When the product has been dropped or damaged.
 - f. When the product displays an abnormal condition. Any noticeable abnormality in the product indicates that the product needs servicing.
- Replacement parts—In case the product needs replacement parts, make sure that the service person uses replacement parts specified by the manufacturer, or those with the same characteristics and performance as the original parts. Use of unauthorized parts can result in fire, electric shock and/or other danger.
- Safety checks—Upon completion of service or repair work, request the service technician to perform safety checks to ensure that the product is in proper operating condition.
- Wall or ceiling mounting—When mounting the product on a wall or ceiling, be sure to install the product according to the method recommended by the manufacturer.
- Polarization—This AC cord may be equipped with a polarized alternating current line plug (a plug having one blade wider than the other). This plug will fit into the power outlet only one way. This is a safety feature. If you are unable to insert the plug fully into the outlet, try reversing the plug. If the plug should still fail to fit, contact your electrician to replace your obsolete outlet.
Do not defeat the safety purpose of the polarized plug.

IMPORTANT SAFETY PRECAUTIONS (Continued)

- **Cleaning**—Unplug the AC cord from the AC outlet before cleaning the product. Use a damp cloth to clean the product. Do not use liquid cleaners or aerosol cleaners.

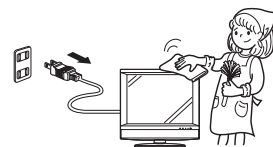

- **Water and moisture**—Do not use the product near water, such as bathtub, washbasin, kitchen sink and laundry tub, swimming pool and in a wet basement.



- **Stand**—Do not place the product on an unstable cart, stand, tripod or table. Placing the product on an unstable base can cause the product to fall, resulting in serious personal injuries as well as damage to the product. Use only a cart, stand, tripod, bracket or table recommended by the manufacturer or sold with the product. When mounting the product on a wall, be sure to follow the manufacturer's instructions. Use only the mounting hardware recommended by the manufacturer.



- When relocating the product placed on a cart, it must be moved with utmost care. Sudden stops, excessive force and uneven floor surface can cause the product to fall from the cart.



- **Ventilation**—The vents and other openings in the cabinet are designed for ventilation. Do not cover or block these vents and openings since insufficient ventilation can cause overheating and/or shorten the life of the product. Do not place the product on a bed, sofa, rug or other similar surface, since they can block ventilation openings. This product is not designed for built-in installation; do not place the product in an enclosed place such as a bookcase or rack, unless proper ventilation is provided or the manufacturer's instructions are followed.



- The Liquid Crystal panel used in this product is made of glass. Therefore, it can break when the product is dropped or applied with impact. Be careful not to be injured by broken glass pieces in case the Liquid Crystal panel breaks.



- **Heat sources**—Keep the product away from heat sources such as radiators, heaters, stoves and other heat-generating products (including amplifiers).

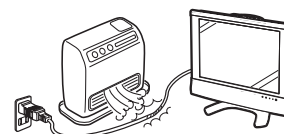

- The Liquid Crystal panel is a very high technology product with 921,600 thin film transistors, giving you fine picture details. Occasionally, a few non-active pixels may appear on the screen as a fixed point of blue, green or red. Please note that this does not affect the performance of your product.

IMPORTANT SAFETY PRECAUTIONS (Continued)

- If an outside antenna is connected to the television equipment, be sure the antenna system is grounded so as to provide some protection against voltage surges and built-up static charges. Section 810 of the National Electrical Code provides information with respect to proper grounding of the mast and supporting structure, grounding of the lead-in wire to an antenna discharge unit, size of grounding conductors, location of antenna-discharge unit, connection to grounding electrodes, and requirements for the grounding electrode.

EXAMPLE OF ANTENNA GROUNDING AS PER NATIONAL ELECTRICAL CODE

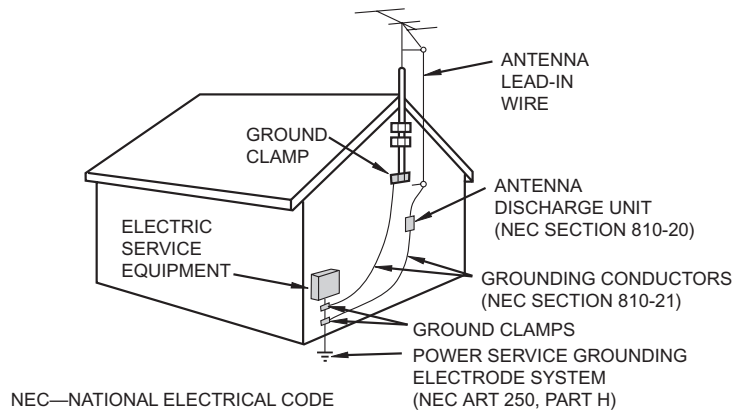

- **Lightning** – For added protection for this television equipment during a lightning storm, or when it is left unattended and unused for a long period of time, unplug it from the wall outlet and disconnect the antenna. This will prevent damage to the equipment due to lightning and power-line surges.



- **Power Lines** – An outside antenna system should not be located in the vicinity of overhead power lines or other electric light or power circuits, or where it can fall into such power lines or circuits. When installing an outside antenna system, extreme care should be taken to keep from touching such power lines or circuits as contact with them might be fatal.

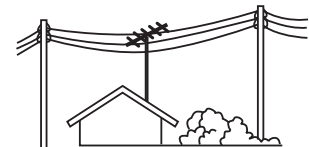

- To prevent fire, never place any type of candle or flames on the top or near the TV set.

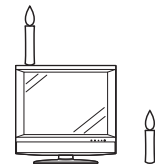

- To prevent fire or shock hazard, do not expose this product to dripping or splashing. No objects filled with liquids, such as vases, should be placed on the product.

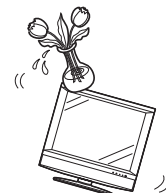

- To prevent fire or shock hazard, do not place the AC cord under the TV set or other heavy items.

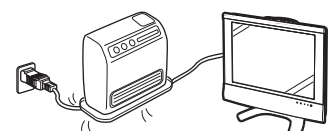

- Do not display a still picture for a long time, as this could cause an afterimage to remain.



- Install the product on the place where the AC cord can be unplugged easily from the AC outlet, or from the AC INPUT terminal on the rear of the product.

Contents

IMPORTANT INFORMATION	1	Basic Adjustment Settings	20
DEAR SHARP CUSTOMER	2	AV MODE	20
IMPORTANT SAFETY PRECAUTIONS	2	OPC.....	20
Supplied Accessories	5	BACKLIGHT	21
Before Using the LCD TV Set	6	PICTURE Adjustments.....	21
Preparation	7	COLOR TEMPERATURE	22
Installing Batteries in the Remote Control.....	7	I/P SETTING	22
Using the Remote Control.....	7	NOISE CLEAN	22
Antenna Connection.....	8	FILM MODE	23
Power Connection.....	9	AUDIO Adjustments	23
Part Names of the Main Unit	10	Useful Features	24
Listening with Headphones.....	10	CH SETUP	24
How to Fix the Cables	11	SETUP	25
Part Names of the Remote Control	12	V-CHIP Settings.....	26
TV Signals in Your Region	12	CLOSED CAPTION	30
Connecting External Devices	13	VIEW MODE	31
Outputting Video and Audio (Video Output).....	13	AUDIO ONLY	32
EZ SETUP (With AUTO CLOCK Setting)	14	BLUE SCREEN	32
EZ SETUP during the First Power On.....	14	SLEEP TIMER.....	33
Setting the CLOCK	15	WAKE-UP TIMER	33
AUTO CLOCK Setting.....	15	NO SIGNAL OFF	34
MANUAL CLOCK Setting	15	NO OPERATION OFF.....	34
TIME DISPLAY.....	16	PICTURE FLIP	34
Basic Operation	16	Troubleshooting	35
Turning On and Off the Main Power.....	16	Specifications	36
Standby	16	Calling for Service	37
Switching the Input Modes		LIMITED WARRANTY	37
(INPUT1/INPUT2/INPUT3/TV).....	17		
Sound Volume.....	17	Dimensional Drawings	
Changing Channels.....	18	• The dimensional drawings for the LCD TV set are	
Selecting Menu Items.....	18	shown on the inside back cover.	

Supplied Accessories

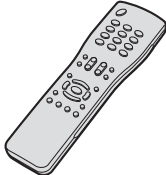
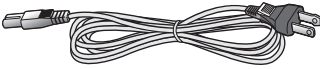
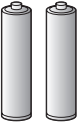
Make sure the following accessories are provided with the LCD TV set.

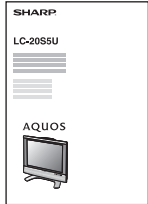
Remote control unit		AC cord	
			
pages 7 and 12		page 9	
"AAA" size batteries (x2)	Cable clamp	Operation manual	
			
page 7	page 11		

NOTE

- The AC cord enclosed in this product is for 110-125V. For using it on the 125-240V AC, please consult the following.
SHARP ELECTRONICS CORPORATION 6100 Blue Lagoon Drive, Suite 230, Miami, Florida 33126, U.S.A.

Before Using the LCD TV Set

To use your LCD TV set, perform steps below.

1 Check the supplied accessories. (See page 5.)

2 Insert two “AAA” size batteries into the remote control. (See page 7.)

- Open the battery cover, and then insert batteries with their terminals corresponding to the (+) and (-) indications in the battery compartment.

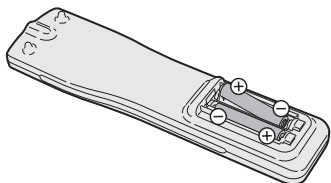

3 Open the terminal cover. (See page 8.)

- Pull down the hook located on the upper side of terminal cover to open the cover.

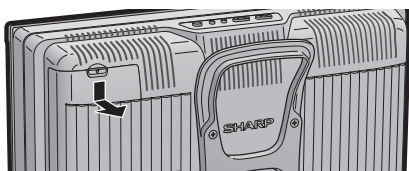

4 Connect the antenna cable. (See page 8.)

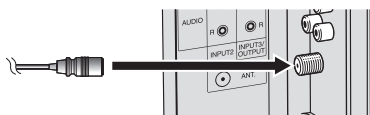

5 Connect with external devices. (See page 13.)

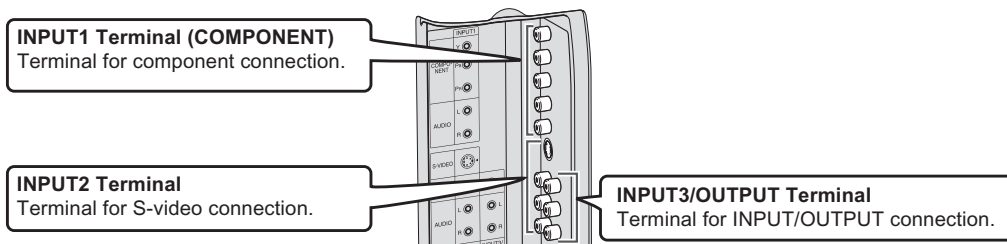

6 Connect the AC cord to the AC INPUT terminal of the LCD TV set and plug in the AC cord to the wall outlet. (See page 9.)

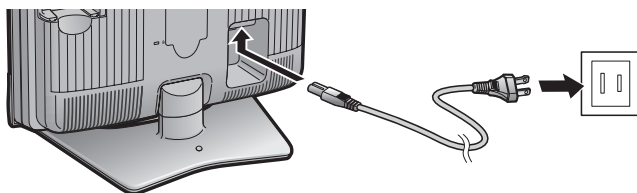

7 Turn on the main power. (See page 16.)

- ① Press **POWER** on the upper side of the main unit.
- ② The **POWER/WAKE UP TIMER** indicator located on the front of the main unit changes from red to green.

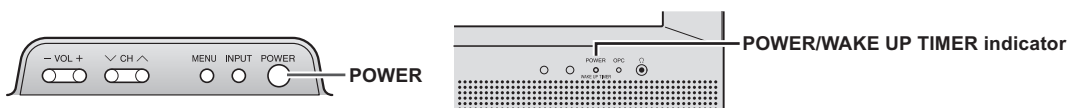

8 Start EZ SETUP. (See page 14.)

- The broadcasting channels and clock will be memorized automatically.

Preparation

Installing Batteries in the Remote Control

Before using the LCD TV set for the first time, install the two "AAA" size batteries supplied in the remote control. When the batteries become depleted and the remote control fails to operate, replace the batteries with new "AAA" size batteries.

1 Open the battery cover.

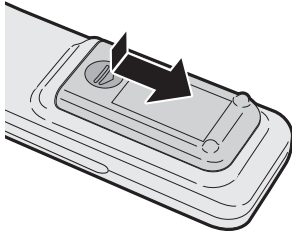

■ Slide the cover while pressing the (▼) part.

2 Insert two "AAA" size batteries.

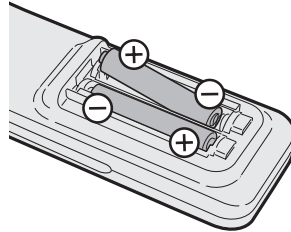

■ Place batteries with their terminals corresponding to the (+) and (-) indications in the battery compartment.

3 Close the battery cover.

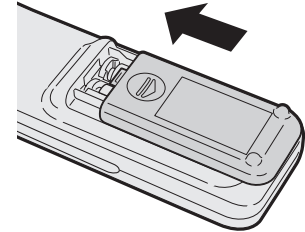

■ Engaging the lower claw with the remote control, close the cover.

⚠ Caution!

Precautions regarding batteries

- Improper use of batteries can result in a leakage of chemicals and/or explosion. Be sure to follow the instructions below.
 - Place batteries with their terminals corresponding to the (+) and (-) indications.
 - Different types of batteries have different characteristics. Do not mix batteries of different types.
 - Do not mix old and new batteries. Mixing old and new batteries can shorten the life of new batteries and/or cause old batteries to leak chemicals.
 - Remove batteries as soon as they are depleted. Chemicals that leak from batteries can cause a rash. If chemical leakage is found, wipe it off with a cloth.
 - The batteries supplied with the LCD TV set may have a shorter operating time due to storage conditions.
 - If the remote control is not to be used for a long period of time, remove the batteries from the remote control.

Using the Remote Control

- Use the remote control by pointing it towards the remote sensor window of the main unit. Objects between the remote control and sensor window may prevent proper operation.

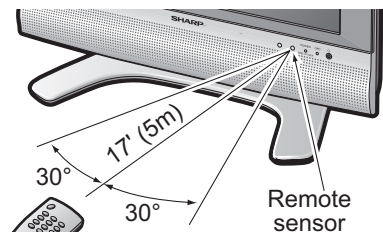

Cautions regarding use of the remote control

- Do not apply shock to the remote control. In addition, do not expose the remote control to liquids, and do not place it in an area with high humidity.
- Do not install or place the remote control in direct sunlight. The heat may cause deformation of the unit.
- The remote control may not work properly if the remote sensor window is in direct sunlight or strong lighting. In such a case, change the angle of the lighting or main unit, or operate the remote control closer to the remote sensor window.

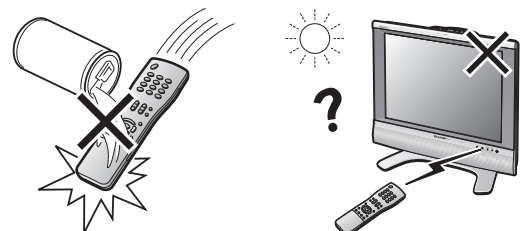

Preparation (Continued)

Antenna Connection

ANTENNAS

- The antenna requirements for good color television reception are more important than those for black & white television reception. For this reason, a good quality outdoor antenna is strongly recommended. The following is a brief explanation of the type of connections that are provided with the various antenna systems.

1. A 75-ohm system is generally a round cable with F-type connector that can easily be attached to a terminal without tools (not supplied).

2. A 300-ohm system is a flat "twin-lead" cable that can be attached to a 75-ohm terminal through a 300/75-ohm adapter (not supplied).

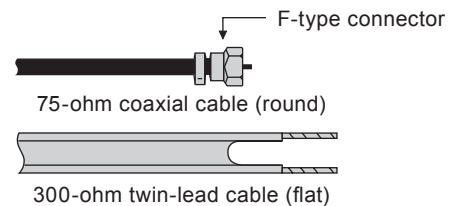

OUTDOOR ANTENNA CONNECTION

- Use one of the following two diagrams if you connect an outdoor antenna.
 - A: Using a VHF/UHF combination outdoor antenna
 - B: Using separate VHF and/or UHF outdoor antennas
- Connect the outdoor antenna cable lead-in to ANT (Antenna terminal) on the rear of the main unit.

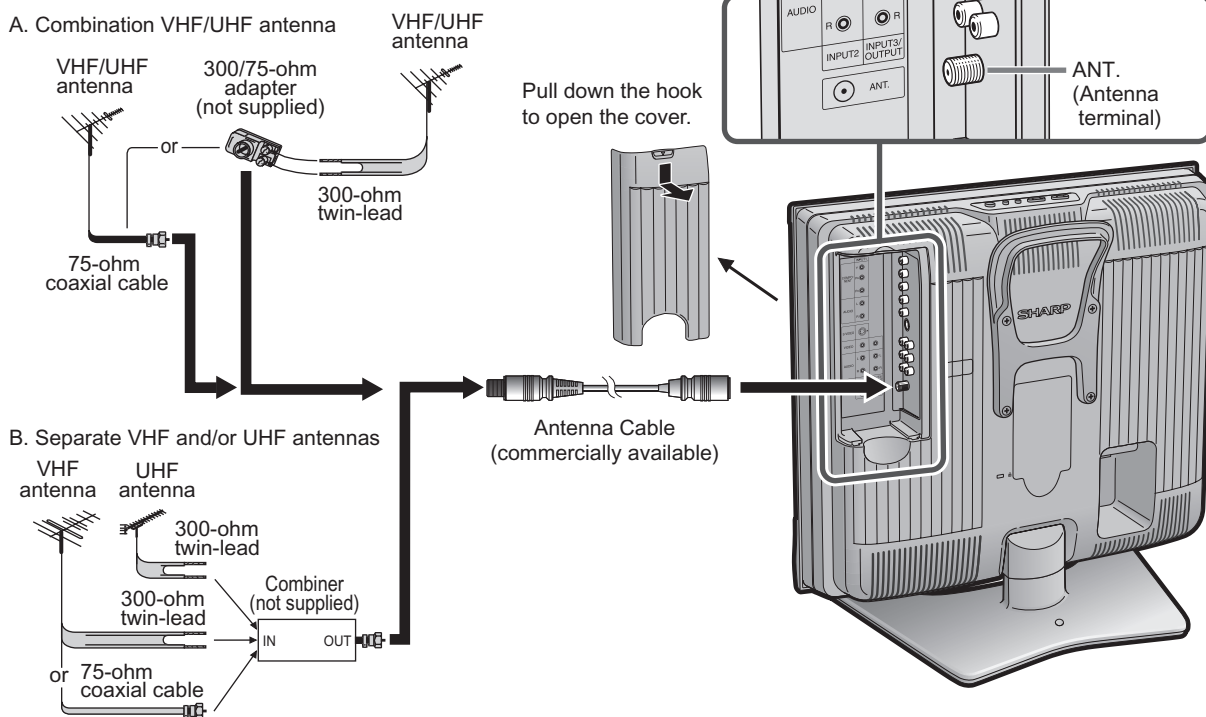

NOTICE

F-type connector

F-type connector should be finger-tightened only.

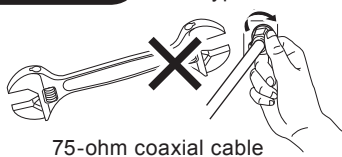

When connecting the RF cable to the LCD TV set, do not tighten F-type connector with tools.

If tools are used, it may cause damage to your LCD TV set. (breaking of internal circuit, etc.)

Antenna Connection (Continued)

CABLE TV (CATV) CONNECTION

- A 75-ohm coaxial cable connector is built into the LCD TV set for easy hookup. When connecting the 75-ohm coaxial cable to the LCD TV set, screw the 75-ohm cable to the ANT terminal.
- Some cable TV companies offer "premium pay channels". Since the signals of these premium pay channels are scrambled, a cable TV converter/descrambler is generally provided to the subscriber by the cable TV company. This converter/descrambler is necessary for normal viewing of the scrambled channels. (Set your TV to channel 3 or 4, typically one of these channels is used. If this is unknown, consult your cable TV company.) For more specific instructions on installing cable TV, consult your cable TV company. One possible method of utilizing the converter/descrambler provided by your cable TV company is explained below. Please note: An RF switch provided with two inputs (A and B) is required (not supplied).

"A" position on the RF switch (not supplied): You can view all unscrambled channels by using the TV's channel keys.
 "B" position on the RF switch (not supplied): You can view the scrambled channels via the converter/descrambler by using the converter's channel keys.

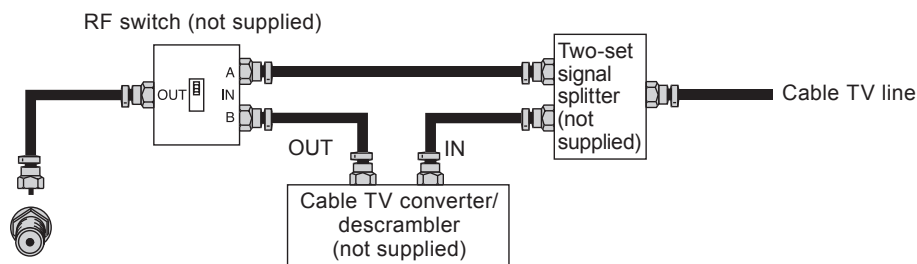

NOTE

- Consult your SHARP Dealer or Service Center for the type of splitter, RF switch or combiner that might be required.

Power Connection

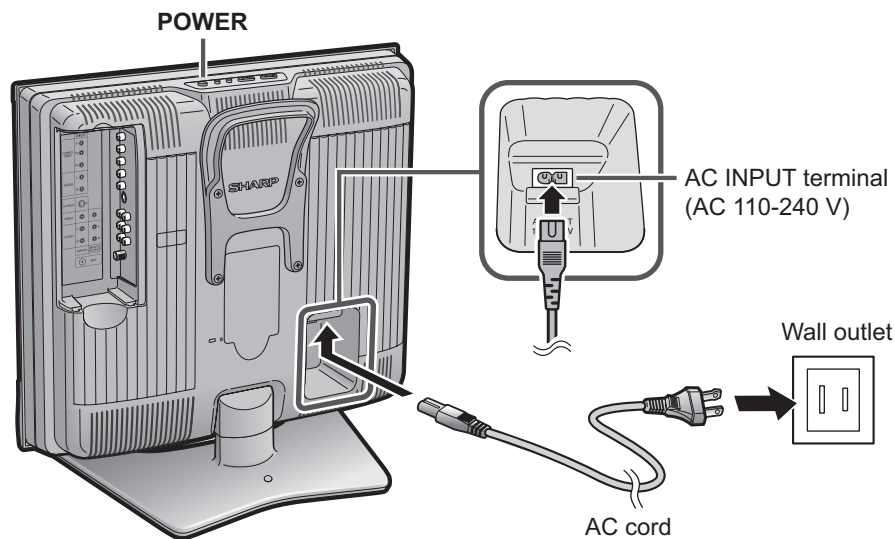

NOTE

- Use a commercially available AC plug adapter, if necessary, depending on the design of the wall outlet.
- Unplug the AC cord from the LCD TV set and wall outlet when LCD TV set is not to be used for a long period of time.

Part Names of the Main Unit

Controls

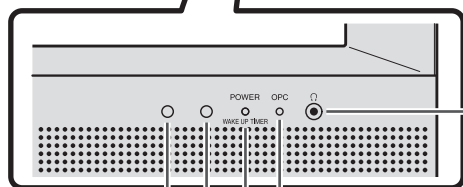
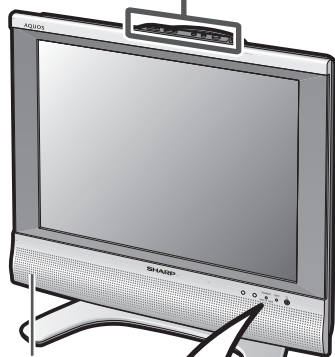
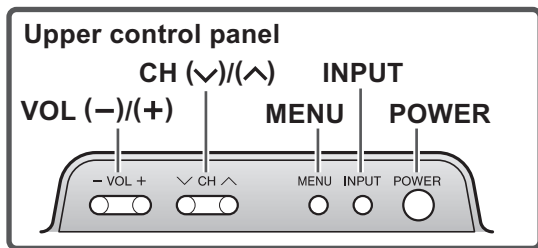

Headphone jack ()

Plug the headphone mini-plug into the headphone jack located on the front of the main unit.

OPC (Optical Picture Control) indicator

The OPC indicator lights up green when "OPC" is set to "ON". (See page 20.)

POWER/WAKE UP TIMER indicator

POWER/WAKE UP TIMER indicator lights up green when the power is on, and red when in the standby mode (the indicator will not light when the main power is off), and orange when the wake up timer is set (the indicator will light when in the standby mode).

How to adjust the angle

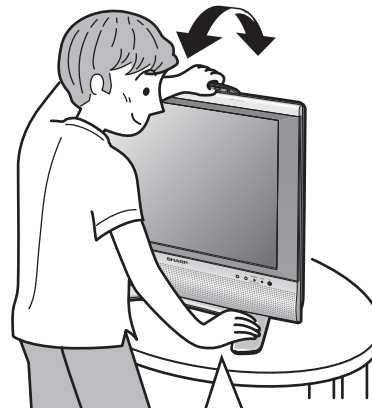

Tilt the display by grabbing onto the carrying handle while securely holding down the stand with your other hand.

To change the vertical angle of the LCD TV set, tilt the screen up to 2.5 degrees forward or 10 degrees backward. Please adjust the angle so that the LCD TV set can be watched most comfortably.

NOTE

- **INPUT**, **CH (v)/(^)**, **VOL (-)/(+)** and **MENU** on the main unit have the same functions as the same buttons on the remote control. Fundamentally, this operation manual provides a description based on operation using the remote control.

Listening with Headphones

- Plug the headphone mini-plug into the headphone jack located on the front of the main unit.

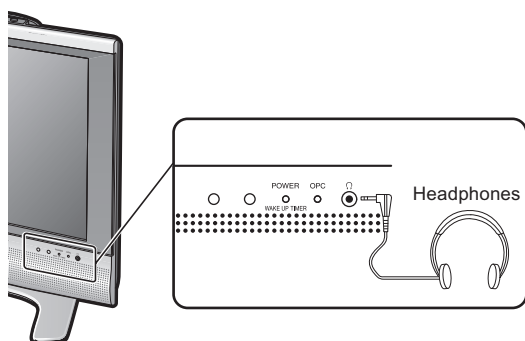

On-screen display



Adjust the sound volume using **VOL (+)/(-)** on the remote control.

NOTE

- Headphones are not included in the supplied accessories.
- No sound is heard from the main unit speakers when a headphone mini-plug is connected into the headphone jack.
- Do not set the volume at a high level. Hearing experts advise against extended listening at high volume levels.

Part Names of the Main Unit (Continued)

Terminals

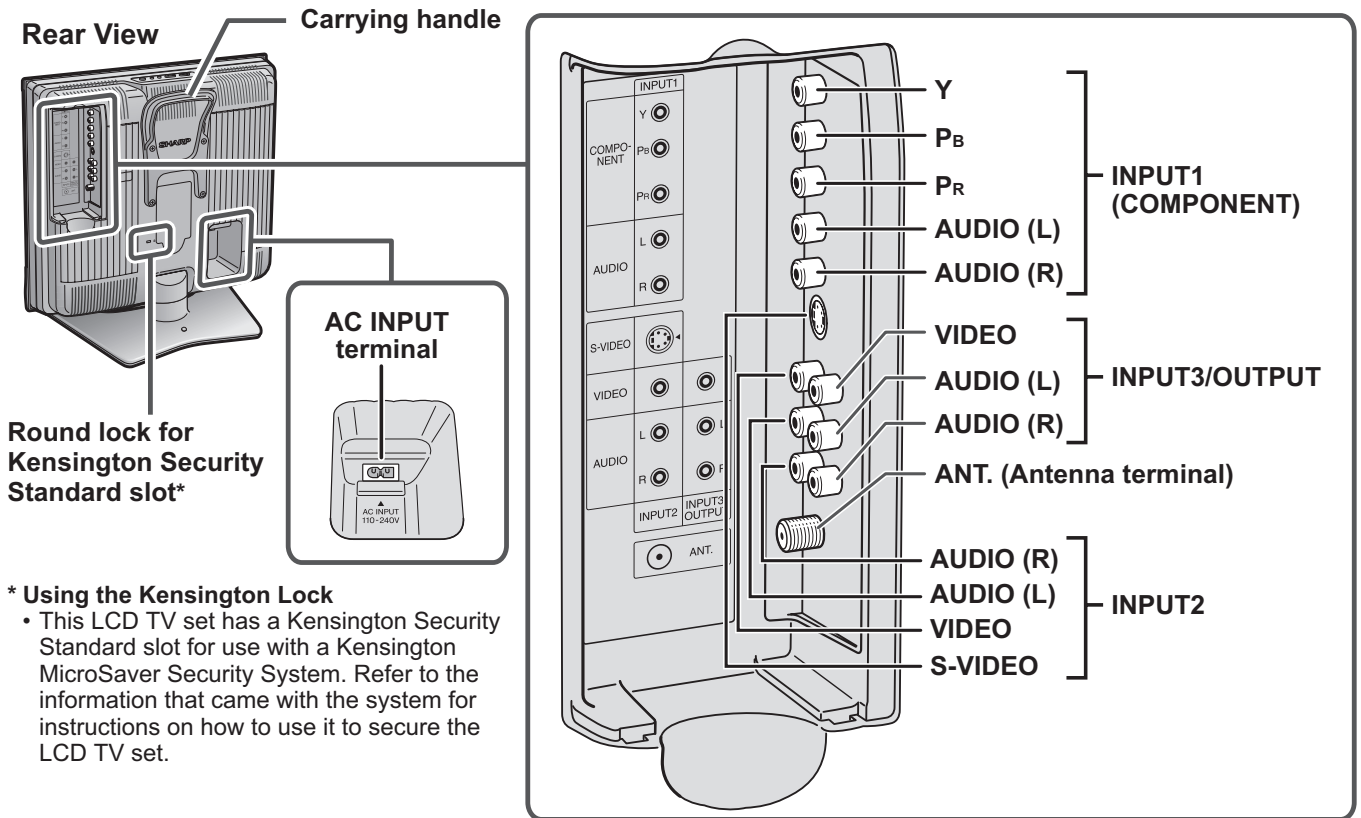

* Using the Kensington Lock

- This LCD TV set has a Kensington Security Standard slot for use with a Kensington MicroSaver Security System. Refer to the information that came with the system for instructions on how to use it to secure the LCD TV set.

How to Fix the Cables

Secure cables and cords with the supplied cable clamp so that they do not get caught when mounting the cover.

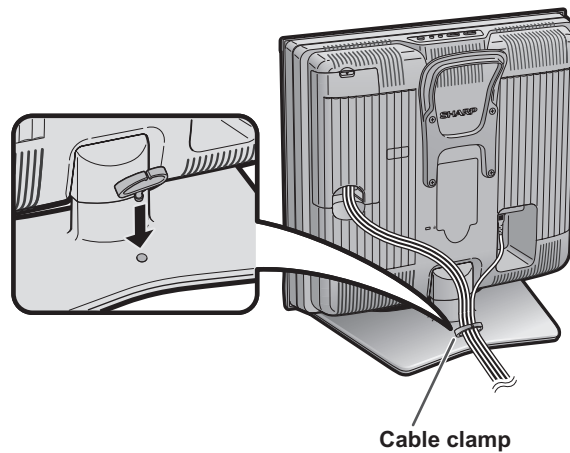

Part Names of the Remote Control

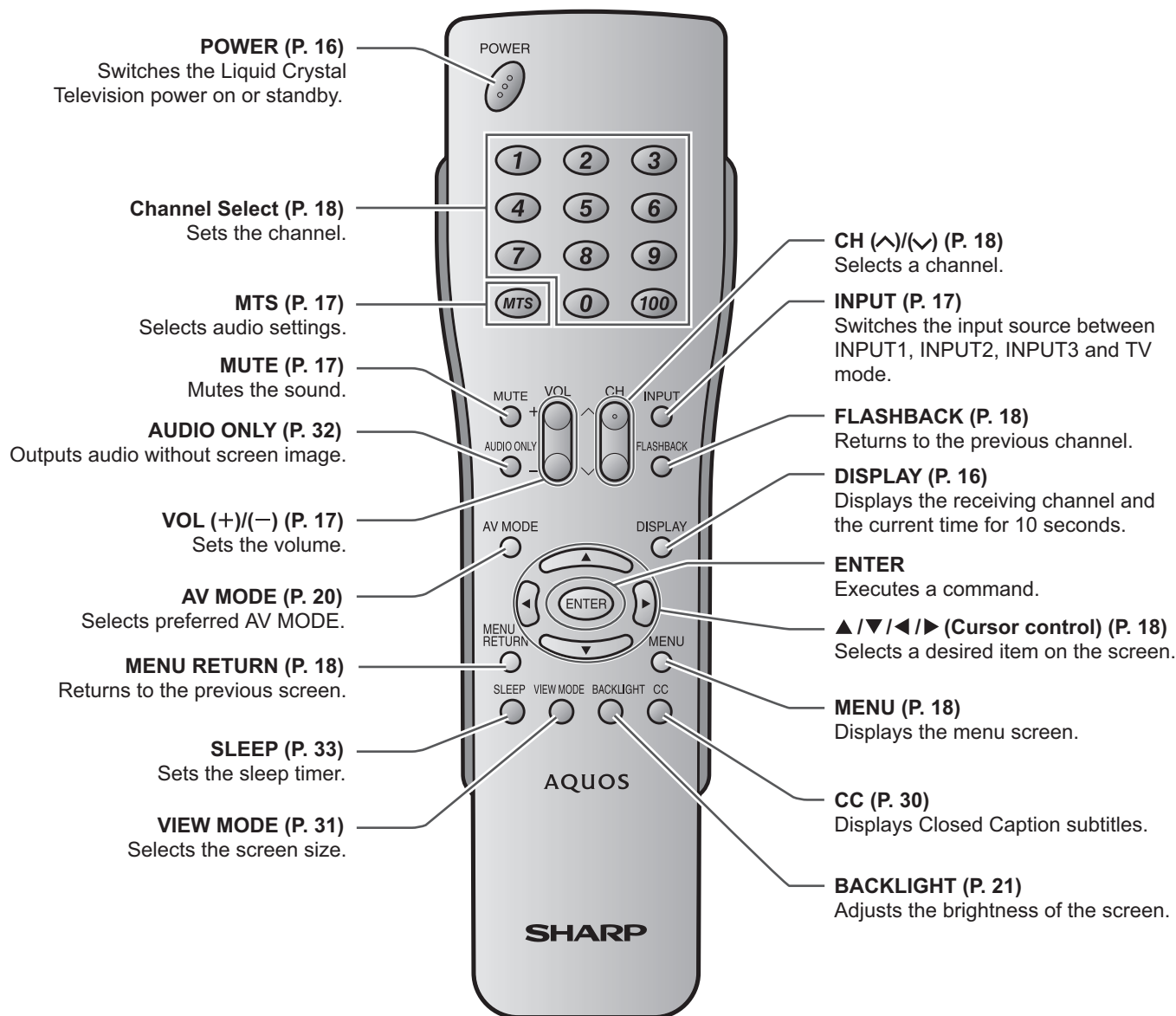

TV Signals in Your Region

This product is factory set to comply with the TV broadcasting system in the United States. For Brazil, Argentina and Uruguay, set the color system according to the country before using this product by following the table below.

The VIDEO INPUT mode is compatible with color systems worldwide and is automatically set.

Country	TV broadcasting system	Factory setting of color system		User setting
		TV	Video	TV
U.S.A.	Color: NTSC TV ch: US ch	NTSC (N358) US ch	World Multi Auto System	Not required or N/A
Canada, Mexico, Latin America	Color: NTSC TV ch: US ch	NTSC (N358) US ch	World Multi Auto System	Not required or N/A
Brazil	Color: PAL-M TV ch: US ch	NTSC (N358) US ch	World Multi Auto System	Set color system to PAL-M (see page 25)
Argentina, Uruguay	Color: PAL-N TV ch: US ch	NTSC (N358) US ch	World Multi Auto System	Set color system to PAL-N (see page 25)

The World Multi Auto System is compatible with all color systems indicated below.

- ① N358
- ② N443
- ③ PAL
- ④ PAL-M
- ⑤ PAL-N
- ⑥ SECAM
- ⑦ PAL-60

NOTE

The 3 Dimensional Y/C separation circuit* works only in the following cases:

- the color system is set to N358 in TV mode or Video mode
- the color system is set to AUTO (N358 signal is received) in Video mode

* The 3 Dimensional Y/C separation circuit is used to remove flickering and color bleeding.

* The 3 Dimensional Y/C separation circuit does not function when S-VIDEO signals are input.

Connecting with External Devices

You can enjoy picture and sound by connecting a VCR or a home video game system to the terminals located on the rear of the LCD TV set.

When connecting an external device, turn off the power of the LCD TV set first to prevent any possible damage.

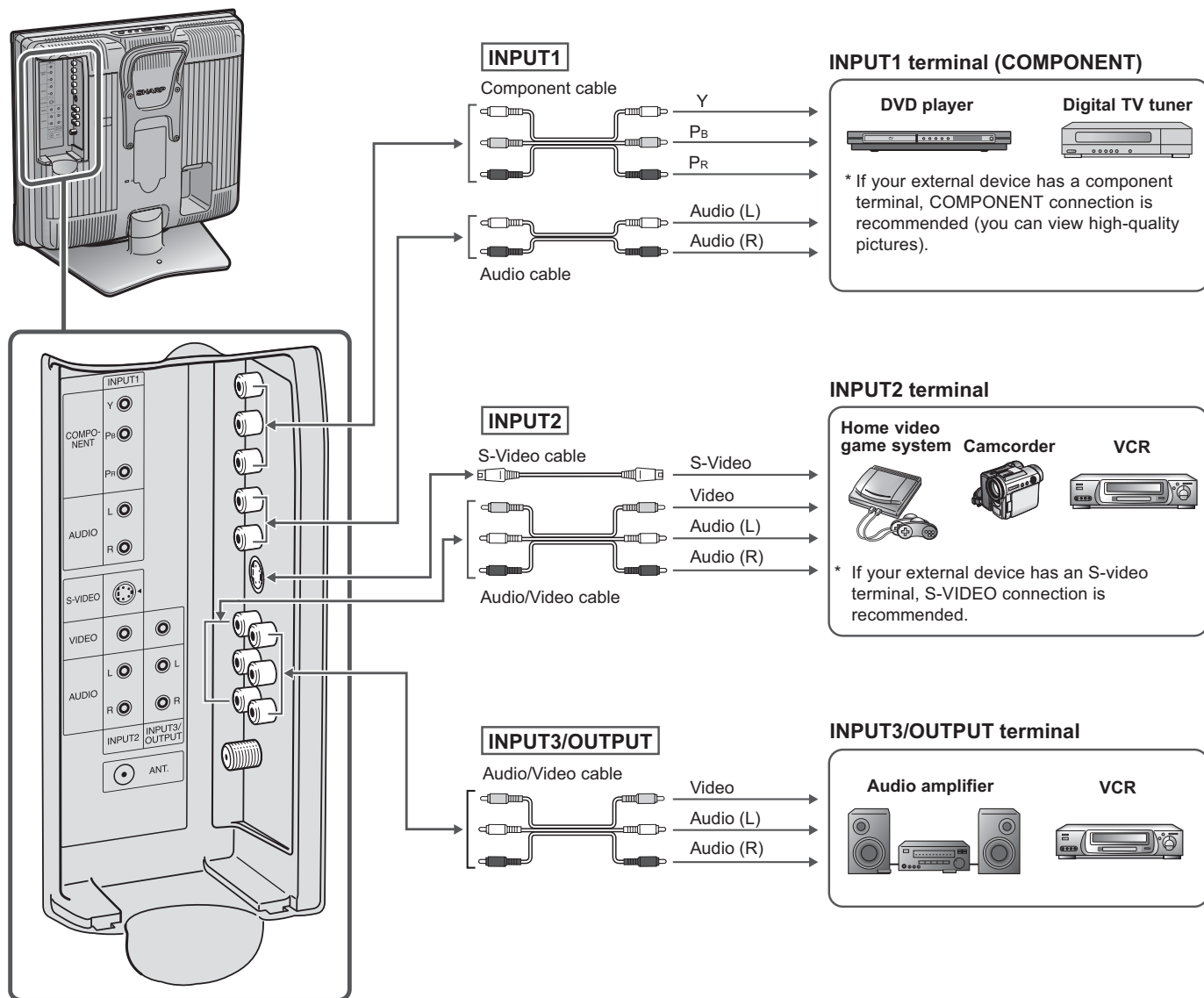

NOTE

- For the cable, use a commercially available audio/video cable.
- PC connection is not possible.
- For more information about external device connections, see the operation manuals of your external devices.
- Make sure that the corresponding cables are connected to each terminal. Connecting other cables may result in a malfunction.
- INPUT2 has two video input terminals, VIDEO and S-VIDEO terminals. If your external device has an S-VIDEO terminal, S-VIDEO connection is recommended. S-VIDEO provides a finer, more detailed picture. If both terminals are connected, S-VIDEO terminal takes a priority.
- For the INPUT1 mode, picture can be displayed only when 480I, 480P, 576I, 576P, 720P or 1080I signal is received.

Outputting Video and Audio (Video Output)

You can output video and audio signals from the LCD TV set through the INPUT3/OUTPUT terminals. (See page 25.)

- When using INPUT3/OUTPUT as an output terminal, select "SETUP" in the Menu and set "INPUT3 SELECT" to "OUT".

NOTE

- When using the S-VIDEO input for INPUT2 or COMPONENT input for INPUT1, no video signal will be made to the INPUT3/OUTPUT terminal, but audio signal will be made for connection to external audio systems.

EZ SETUP (With AUTO CLOCK Setting)

EZ SETUP during the First Power On

- When you turn on the LCD TV set for the first time, it will automatically memorize the broadcasting channels and clock. Please perform the following instructions before you press **POWER**.

- Insert the batteries into the remote control. (See page 7.)
- Connect the antenna cable to the LCD TV set. (See page 8.)
- Connect the AC cord to the AC INPUT terminal of the LCD TV set and plug in the AC cord to the wall outlet. (See page 9.)

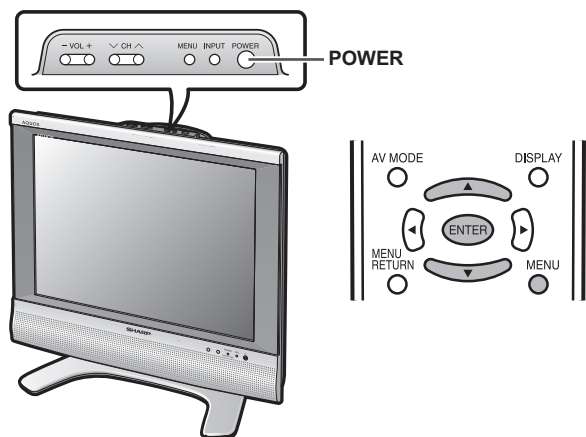

- Press **POWER** on the upper side of the main unit, to turn on the TV. The SELECT LANGUAGE screen will be displayed. Press **▲/▼** to select "ENGLISH", "ESPAÑOL" (Spanish) or "FRANÇAIS" (French).



- Press **ENTER** to access CH SEARCH mode. Press **▲/▼** to select "ON" or "OFF". When you select "ON", the LCD TV set will automatically memorize the broadcasting channels.



NOTE

- If you select "OFF", EZ SETUP will be canceled.

- Press **ENTER** to access AUTO CLOCK mode. Press **▲/▼** to select "ON" or "OFF".

When you select "ON", the LCD TV set will automatically adjust the clock to search time-signals (EDS signals), which are provided by some TV stations. The AUTO CLOCK setting may take from several minutes to an hour depending on the number of channels to receive and signal status. If you know the channel of the EDS signal carrier (PBS or other) in your area, select "OFF" and follow the procedure in **AUTO CLOCK Setting**. (See page 15.)



- Press **ENTER** to access START EZ SETUP mode. Press **▲/▼** to select "YES", and press **ENTER**.

NOTE

- If you want to stop the EZ SETUP process once it has started, press **MENU** and it will be canceled. If you want to set up again, please refer to **CH SETUP** on page 24.



The tuner will automatically search for the broadcasting and cable TV channels. (The channel number will automatically increase when it appears.)



The LCD TV set will automatically switch to searching for EDS signals.

If EDS signals are received, the channel number and time will be displayed, and then the screen shown in step 5 appears.



- Once EZ SETUP is completed, the lowest channel number memorized will be displayed.



NOTE

- Do not let the EZ SETUP screen remain unattended for a long time.
- If EZ SETUP does not memorize all the channels in your region, please refer to page 24 for more information on manually memorizing the channels using CH SETUP.
- It may be difficult to preset when the broadcasting signals are weak, the channel cycle frequency is incorrect or the frequency jamming is occurring around the area. Please refer to page 24 for more information on manually memorizing channels using CH SETUP.
- If there are no channels with EDS signals or the antenna signal is weak, the AUTO CLOCK setting may not operate. In this case, the "EDS CH IS NOT AVAILABLE." message will appear and the mode will change to MANUAL CLOCK setting. Refer to page 15 to set the clock manually.

Setting the CLOCK

AUTO CLOCK Setting

There are two methods of setting the clock: AUTO CLOCK and MANUAL CLOCK. AUTO CLOCK uses EDS signals, which are provided by some TV stations, to automatically adjust the clock. MANUAL CLOCK sets the clock manually in areas where no channel carries EDS signals.

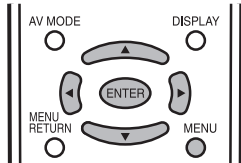

- 1 Press **MENU** to display the Menu screen.
- 2 Press **◀/▶** to select "SETUP".
- 3 Press **▲/▼** to select "CLOCK", and press **ENTER**.

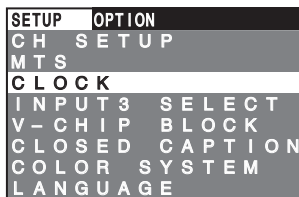

- 4 Press **▲/▼** to select "SET", and press **ENTER**.



- 5 Press **▲/▼** to select "AUTO", and press **ENTER**.

- If you do not know the channel that carries EDS signals in your area, set "EDS CH" to "AUTO" and press **ENTER**. If you know the channel of the EDS signal carrier in your area, press **◀/▶** to select the channel and press **ENTER**.



- When set to "AUTO CLOCK", the current time is acquired automatically when the main power is turned OFF. (This function will not work when EDS CH is not set.)

■ Backup

The clock function is maintained for about 5 minutes even when the AC cord has been shut off due to a power outage or when moving the LCD TV set. (Since about 30 minutes are required to charge the backup power supply, it may not be possible to maintain the clock function if the charging time is excessively short.)

If the clock setting has been reset, repeat the procedures on this page.

NOTE

- **CLOCK:**
The AUTO CLOCK setting may take from several minutes to an hour depending on the number of channels to receive and signal status.
- **EDS CH < AUTO >:**
If there are no channels with EDS signals or the antenna signal is weak, the AUTO CLOCK Setting may not operate. In such a case, the message "EDS CH IS NOT AVAILABLE." appears, and the CLOCK setting screen (in step 4 in **AUTO CLOCK Setting**) is displayed. Refer to **MANUAL CLOCK Setting** to set the clock manually.
- **EDS CH < Not AUTO >:**
If the channel you have selected for "EDS CH" is wrong or the EDS signal carrier is weak, or when there is no broadcast, the AUTO CLOCK Setting may not operate. In such cases, the message "EDS CH (XXX) EDS DATA IS NOT AVAILABLE." appears, and the CLOCK setting screen (in step 4 in **AUTO CLOCK Setting**) is displayed as in the case with EDS CH < AUTO >. Follow step 4 and repeat the AUTO CLOCK Setting procedure.
- If broadcasting channels are not memorized, EDS signals cannot be received even when the "EDS CH" is set to "AUTO". In this case, try EZ SETUP again. (See page 24.)

MANUAL CLOCK Setting

If there are no channels with EDS signals, set the clock manually using MANUAL CLOCK.

- 1 Repeat steps 1 to 4 of **AUTO CLOCK Setting**.
- 2 Press **▲/▼** to select "MANUAL", and press **ENTER**.



- 3 Press **▲/▼** to select "DST", and press **◀/▶** to select "ON" or "OFF".
Press **▲/▼** to select "TIME", and press **◀/▶** to set the time, and press **ENTER**.

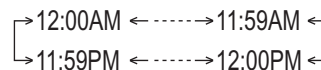

- Holding down **◀/▶** changes the setting at a high speed.



- 4 Press **MENU** to exit.

NOTE

- Make sure to press **ENTER** after adjusting the time. Otherwise, the time will not be set.
- When "DST" is set to "ON", the time entered is forwarded by 1 hour.
- Please be sure to set "DST" before setting "TIME".

Basic Operation

Daylight Saving Time (DST) Adjustment

The Daylight Saving-Time changes as shown below. Set the DST to "ON" to forward the clock by 1 hour. To rewind the clock by 1 hour, set the DST to "OFF".

(Spring)

On the first Sunday in April DST starts.

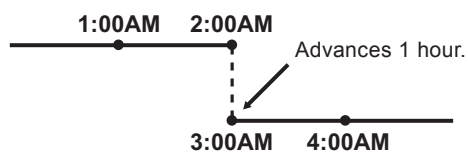

(Autumn)

On the last Sunday in October DST finishes.

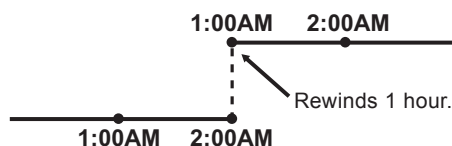

TIME DISPLAY

You can display the current time on the screen.

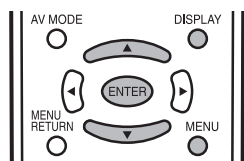

1 Repeat steps 1 to 3 of **AUTO CLOCK Setting** on page 15.

2 Press **▲/▼** to select "TIME DISPLAY", and press **ENTER**.



3 Press **▲/▼** to select "ON" or "OFF", and press **ENTER**.

Selected item	Description
ON	Displays the current time on the screen.
OFF	No display

4 Press **MENU** to exit.

NOTE

- When you press **DISPLAY**, the current time is displayed for about 10 seconds.

Turning On and Off the Main Power

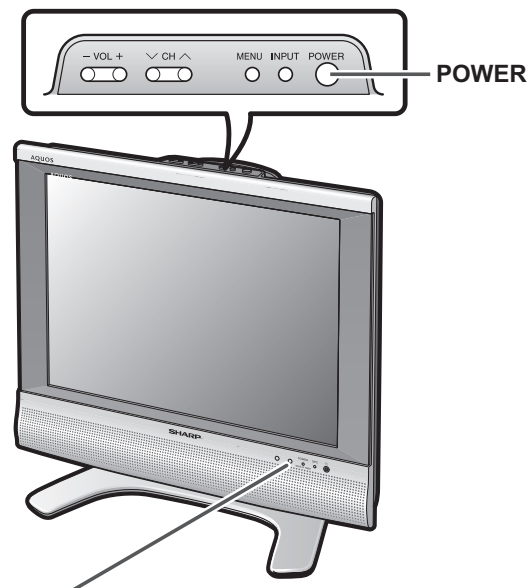

POWER/WAKE UP TIMER indicator

- Press **POWER**. The **POWER/WAKE UP TIMER indicator** instantly changes from red to green and the LCD TV set is turned on.

On-screen display

▶ STEREO
SAP
MONO

NOTE

- The on-screen display disappears in a few seconds.
- To turn off the main power, press **POWER** again.

Standby

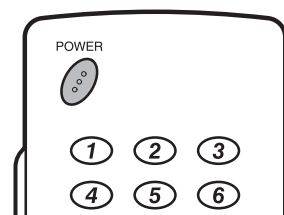

To turn off the LCD TV set

Press **POWER**. The **POWER/WAKE UP TIMER indicator** will turn red.

To turn the LCD TV set back on

Press **POWER** again. The **POWER/WAKE UP TIMER indicator** will turn green.

Switching the Input Modes (INPUT1/INPUT2/INPUT3/TV)

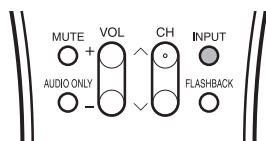

1 Turn on the power of the connected video equipment.

2 Press **INPUT** to select the applicable input source. The screen changes in order of INPUT1, INPUT2, INPUT3 and TV mode each time **INPUT** is pressed.

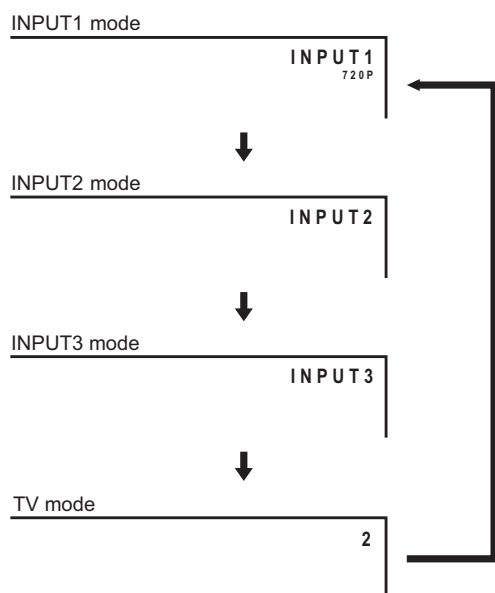

NOTE

- **INPUT1:**
Used for video equipment connected to the COMPONENT input terminals.
- **INPUT2:**
Used for video equipment connected to the INPUT2 terminals.
The S-video input terminal is additionally provided for the INPUT2 terminal. If both the S-video terminal and normal video terminals are connected with cables, the S-video input terminal takes priority.
- **INPUT3/OUTPUT:**
INPUT3 mode is used to adjust the preset settings and IN or OUT can be selected. INPUT3 indication is not displayed when OUT is selected. (For details on setting INPUT3 SELECT, see page 25.)

Sound Volume

■ To adjust the volume

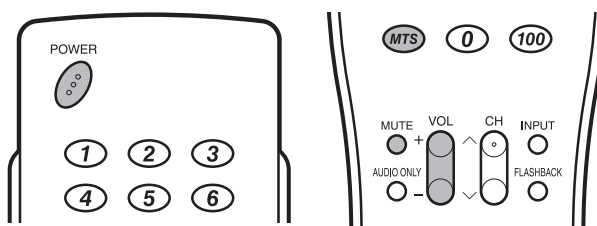

● Press **VOL (+)** to increase the sound volume. The bar indicator shifts right.



● Press **VOL (-)** to decrease the sound volume. The bar indicator shifts left.



■ To mute the sound

● Press **MUTE** to temporarily turn off the sound. The MUTE mark is displayed for 4 seconds.

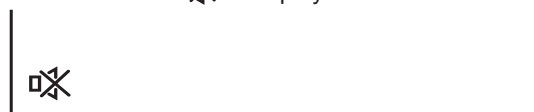

● Press **MUTE** or **VOL (+)/(-)** to turn the sound back to the previous level. The mute function is automatically turned off when any of the following buttons are pressed: **POWER**, **MUTE**, **VOL(+)/(-)** or **MTS**.



NOTE

- When **VOL (+)/(-)** is pressed in the Mute mode, the sound turns on and the volume indicator is displayed.
- The Mute function is canceled when **POWER** is pressed.

■ To select MTS (Multichannel TV Sound)

1 Press **MTS** to display the MTS screen.

2 Press **MTS** to select the MTS settings.

STEREO: stereo audio
SAP: secondary audio program
MONO: monophonic audio

▶ STEREO <ON AIR
SAP <ON AIR
MONO

NOTE

- "ON AIR" appears when a STEREO or SAP broadcast is being aired.

Basic Operation (Continued)

Changing Channels

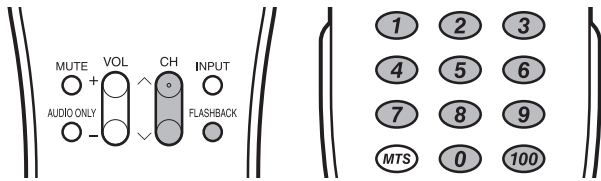



You can select channels using **Channel Select** or **CH (▲)/(▼)**.

- This LCD TV set allows you to select up to 125 channels (1 to 125). To select a channel, enter a 2- or 3-digit number.

■ Using Channel Select

When selecting the channel using **Channel Select**, complete input of the channel number by holding down the button for the last digit for a moment.



To select a 1- or 2-digit channel number (e.g., Channel 5):
Complete the following procedure within 4 seconds.

- 1 Press the **0** button. 
- 2 Press the **5** button. 

NOTE

- When selecting a 1-digit channel number, do not fail to press the **0** button first.

To select a 3-digit channel number (e.g., Channel 115):
Complete the following procedure within 4 seconds.

- 1 Press the **100** button. 
- 2 Press the **1** button. 
- 3 Press the **5** button. 

NOTE

- The 3-digit channel number can be selected only when the receiving mode is set to "CABLE" in "CH SETUP". (For details on setting the receiving mode, see page 24.)

Changing channels with CH (▲)/(▼) on the remote control

- Air:** Press **CH (▲)** and the channels change in the order shown below:
2 → 3 → ... → 68 → 69 → 2 → 3 → ...
Press **CH (▼)** and the channels change in the order shown below:
3 → 2 → 69 → 68 → ... → 3 → 2 → ...
- Cable:** Press **CH (▲)** and the channels change in the order shown below:
1 → 2 → 3 → ... → 125 → 1 → 2 → 3 → ...
Press **CH (▼)** and the channels change in the order shown below:
3 → 2 → 1 → 125 → ... → 3 → 2 → 1 → ...

■ Using FLASHBACK

- Press **FLASHBACK** to switch the currently tuned channel to the previously tuned channel.
- Press **FLASHBACK** again to switch back to the currently tuned channel.

Selecting Menu Items

The menus can be used to adjust the various settings of the LCD TV set. Select the desired menu item by following the steps below. See the next page for each Menu screen.

NOTE

- The items displayed differ depending on the setting conditions.
- The item selected is displayed in yellow.
- Settings most recently adjusted will be saved in memory.

■ Using the remote control

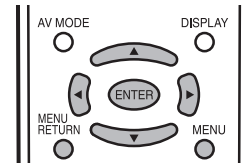

- 1 Press **MENU** on the remote control to display the Menu screen.
- 2 Press **◀/▶** to select the desired menu item.
 - The cursor moves left or right.
 - The cursor indicates the selected menu item.
- 3 Press **▲/▼** to select the desired item, and press **◀/▶** to adjust the selected item.
 - For "AV MODE", "OPC", "ADVANCED" and "RESET", press **ENTER** to display the setting screen.

PICTURE	AUDIO	SETUP	OPTION
AV MODE		[DYNAMIC]	
OPC		[OFF]	
BACKLIGHT		[BRIGHT]	_____
CONTRAST		[40]	_____
BRIGHTNESS		[0]	_____ +
COLOR		[+ 5]	_____ +
TINT		[0]	_____ ■
SHARPNESS		[0]	_____ +
ADVANCED			
RESET			

- 4 Press **MENU RETURN** to return to the previous screen, or press **MENU** to exit.

■ Using the control panel of the main unit

You can also operate the menu with the control panel of the main unit.

Button operations on the control panel correspond to the ones on the remote control as shown below.

Control panel of the main unit



- VOL (–)/(+):** Cursor **◀/▶** on the remote control
CH (▼)/(▲): Cursor **▼/▲** on the remote control
MENU: **MENU** on the remote control
INPUT: **ENTER** on the remote control

■ Menu setting screens

For details on setting each menu item, refer to the page number indicated below.

NOTE

- The illustrations and on-screen displays in this manual are for explanation purposes and may vary slightly from the actual appearance.
- Depending on the setting condition, such as an input mode, it may not be possible to adjust or set some items. In such cases, the alert message (Example: NOT AVAILABLE WITH THIS SIGNAL.) is displayed on the menu setting screen.

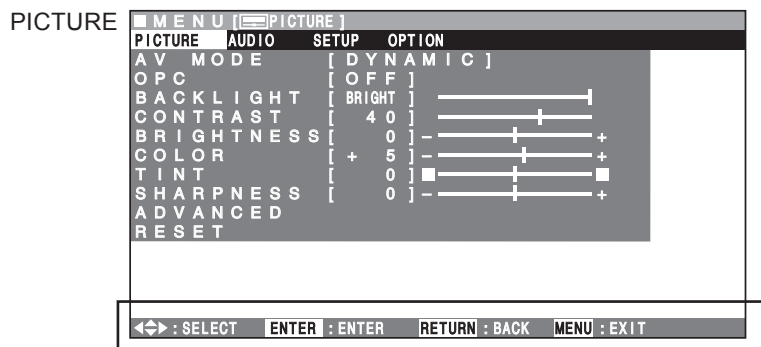

<=> : SELECT ENTER : ENTER RETURN : BACK MENU : EXIT

The bar above is an operational guide for the remote control. The bar will change in accordance with each menu setting screen.

	Page
AV MODE	20
OPC	20
BACKLIGHT	21
CONTRAST	21
BRIGHTNESS	21
COLOR	21
TINT	21
SHARPNESS	21
ADVANCED	22, 23
RESET	21

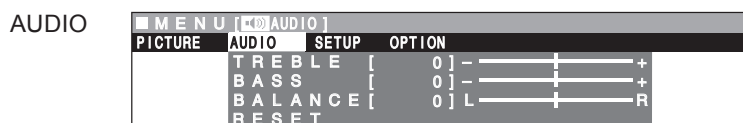

	Page
TREBLE	23
BASS	23
BALANCE	23
RESET	23

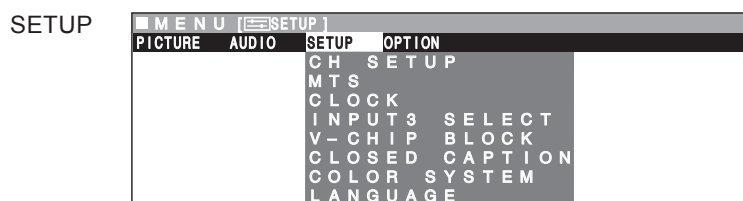

	Page
CH SETUP	24
MTS	17, 25
CLOCK	15, 16
INPUT3 SELECT	25
V-CHIP BLOCK	26-29
CLOSED CAPTION	30
COLOR SYSTEM	12, 25
LANGUAGE	14, 25

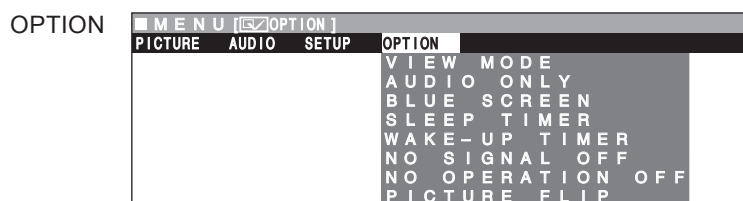

	Page
VIEW MODE	31
AUDIO ONLY	32
BLUE SCREEN	32
SLEEP TIMER	33
WAKE-UP TIMER	33
NO SIGNAL OFF	34
NO OPERATION OFF	34
PICTURE FLIP	34

Basic Adjustment Settings

AV MODE

AV MODE gives you preset options to choose from, to best match the image based on room-brightness and playback software used.

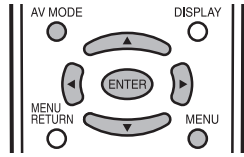

- 1 Press **MENU** to display the Menu screen.
- 2 Press **◀/▶** to select "PICTURE".
- 3 Press **▲/▼** to select "AV MODE", and press **ENTER**.
- 4 Press **▲/▼** to select the desired setting, and press **ENTER**.

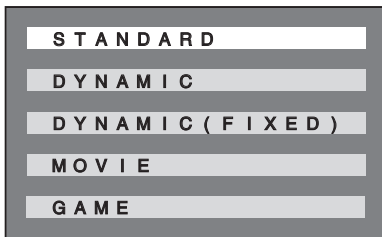

- 5 Press **MENU** to exit.

NOTE

- You can select a different AV MODE item for each input mode. (For example, select "STANDARD" for TV input and "DYNAMIC" for VIDEO input.)
- When "AV MODE" is set to "DYNAMIC (FIXED)", "NO PICTURE ADJUSTMENTS AVAILABLE IN [DYNAMIC (FIXED)]." is displayed and the items in the PICTURE screen (except "OPC" and "ADVANCED") cannot be set.

Directly setting the AV MODE

- 1 Press **AV MODE**.
- 2 Before the AV MODE display disappears, press **AV MODE** again and select your desired setting.
 - Each time you press **AV MODE**, the mode changes as shown below.



Selected item	Description
STANDARD	Changing image settings to standard values.
DYNAMIC	For a clear-cut image emphasizing high contrast for sports viewing.
DYNAMIC (FIXED)	Changing image settings to factory preset values. No adjustments are allowed.
MOVIE	Controlling the contrast to enable easier viewing of dark images.
GAME	Controlling the brightness of video games and other images for easier viewing.

OPC

Automatically adjusts the brightness of the screen.

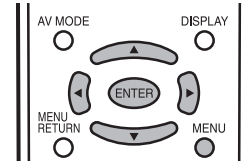

- 1 Press **MENU** to display the Menu screen.
- 2 Press **◀/▶** to select "PICTURE".
- 3 Press **▲/▼** to select "OPC", and press **ENTER**.
- 4 Press **▲/▼** to select "ON" or "OFF", and press **ENTER**.



Selected item	Description
ON	Automatically adjusts the brightness
OFF	No adjustment

- 5 Press **MENU** to exit.

NOTE

- When setting to "ON", the OPC indicator lights up green, senses the surrounding light and automatically adjusts the backlight brightness. Make sure no object obstructs the OPC sensor, which could affect its ability to sense surrounding light.

Basic Adjustment Settings (Continued)

BACKLIGHT

You can adjust the brightness of the picture.

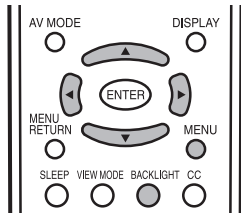

- 1 Press **MENU** to display the Menu screen.
- 2 Press **◀/▶** to select "PICTURE".
- 3 Press **▲/▼** to select "BACKLIGHT".

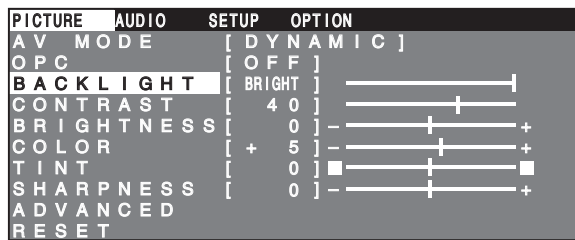

- 4 Press **◀/▶** to adjust the item to the desired position.
- 5 Press **MENU** to exit.

NOTE

- "BACKLIGHT" cannot be adjusted while "OPC" is set to "ON".

Directly setting the BACKLIGHT

- 1 Press **BACKLIGHT** to display the BACKLIGHT screen.



- 2 Press **BACKLIGHT** to change the setting.

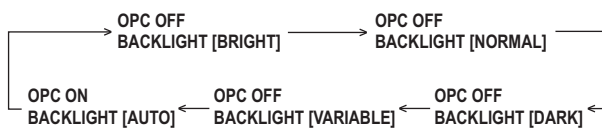

NOTE

- The BACKLIGHT screen automatically disappears in 3 seconds.
- [BRIGHT]: Maximum brightness
- [NORMAL]: Suitable for viewing in a well-lit area. Saves energy.
- [DARK]: Sufficiently bright when viewing in dim areas.
- [VARIABLE]: The brightness can be adjusted to suit your preference using **◀/▶**.
- [AUTO]: Screen brightness adjusts according to the ambient light of the room to conserve power consumption. The OPC indicator lights up green.
- When set to "AUTO", make sure no object obstructs the OPC sensor, which could affect its ability to sense surrounding light.

PICTURE Adjustments

You can adjust the picture to your preference with the following picture settings.

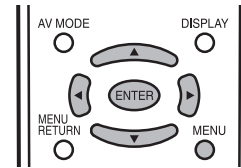

- 1 Press **MENU** to display the Menu screen.
- 2 Press **◀/▶** to select "PICTURE".
- 3 Press **▲/▼** to select a specific adjustment item.

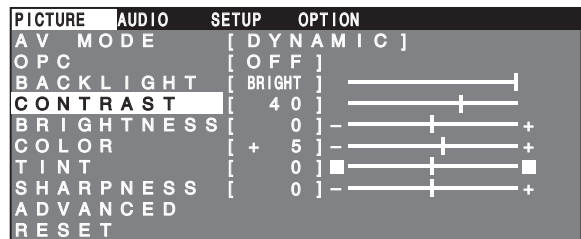

- 4 Press **◀/▶** to adjust the item to the desired position.
- 5 Press **MENU** to exit.

Selected item	◀ button	▶ button
BACKLIGHT	The screen dims	The screen brightens
CONTRAST	For less contrast	For more contrast
BRIGHTNESS	For less brightness	For more brightness
COLOR	For less color intensity	For more color intensity
TINT	Skin tones become purplish	Skin tones become greenish
SHARPNESS	For less sharpness	For more sharpness

NOTE

- Select "ADVANCED", and press **ENTER** to set "COLOR TEMP.", "I/P SETTING", "NOISE CLEAN" or "FILM MODE". See pages 22 and 23.
- When resetting all adjustment items (except for the items on the "AV MODE", "OPC" and "ADVANCED" menus) to factory preset values, perform the following procedure.
 - ① Press **▲/▼** to select "RESET" in the PICTURE screen, and press **ENTER**.
 - ② Press **▲/▼** to select "YES", and press **ENTER**.

Basic Adjustment Settings (Continued)

COLOR TEMPERATURE

You can adjust the color temperature to give a better white balance.

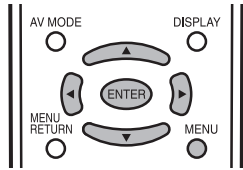

- 1 Press **MENU** to display the Menu screen.
- 2 Press **◀/▶** to select "PICTURE".
- 3 Press **▲/▼** to select "ADVANCED", and press **ENTER**.

PICTURE	AUDIO	SETUP	OPTION
AV MODE	[DYNAMIC]		
OPC	[OFF]		
BACKLIGHT	[BRIGHT]		
CONTRAST	[40]		
BRIGHTNESS	[0]		
COLOR	[+ 5]		
TINT	[0]		
SHARPNESS	[0]		
ADVANCED			
RESET			

- 4 Press **▲/▼** to select "COLOR TEMP.", and press **ENTER**.

COLOR TEMP.	Selected item
RED [0]	USER
GREEN [0]	HIGH
BLUE [0]	MIDDLE
I/P SETTING	LOW
NOISE CLEAN	
FILM MODE	
RESET	

- 5 Press **▲/▼** to select the desired item, and press **ENTER**.
- 6 Press **MENU** to exit.

Selected item	Description
USER	Can set your desired color*
HIGH	White with bluish tone
MIDDLE	↕
LOW	White with reddish tone

* When you select "USER", the following items are adjustable.

Selected item	◀ button	▶ button
RED	Weaker red	Stronger red
GREEN	Weaker green	Stronger green
BLUE	Weaker blue	Stronger blue

NOTE

- When resetting the items in the "USER" setting to factory preset values, perform the following procedure.
 - ① Press **▲/▼** to select "RESET" in the ADVANCED screen, and press **ENTER**.
 - ② Press **▲/▼** to select "YES", and press **ENTER**.

I/P SETTING

Adjusting the image and input signal can give you a more beautiful picture.

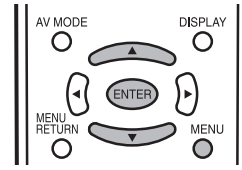

- 1 Repeat steps 1 to 3 of **COLOR TEMPERATURE**.
- 2 Press **▲/▼** to select "I/P SETTING", and press **ENTER**.

INTERLACE
PROGRESSIVE

- 3 Press **▲/▼** to select "INTERLACE" or "PROGRESSIVE", and press **ENTER**.
- 4 Press **MENU** to exit.

Selected item	Description
INTERLACE	Use this setting when you cannot get a clear picture with PROGRESSIVE. (Especially suitable for media with special effects like game software.)
PROGRESSIVE	Normally, you should select this setting.

NOTE

- "I/P SETTING" cannot be set when 480P, 576P, 720P or 1080I signal is received from the COMPONENT terminals.

NOISE CLEAN

Produces a clearer video image.

- 1 Repeat steps 1 to 3 of **COLOR TEMPERATURE**.
- 2 Press **▲/▼** to select "NOISE CLEAN", and press **ENTER**.

ON
OFF

- 3 Press **▲/▼** to select "ON", and press **ENTER**.
- 4 Press **MENU** to exit.

NOTE

- "NOISE CLEAN" cannot be set when 1080I or 720P signal is received from the COMPONENT terminals.

Basic Adjustment Settings (Continued)

FILM MODE

Automatically detects a film-based source (originally encoded at 24 frames/second), analyses it, and then recreates each still film frame for cinematic picture quality.

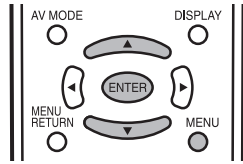

- 1 Repeat steps 1 to 3 of **COLOR TEMPERATURE** on page 22.
- 2 Press ▲/▼ to select "FILM MODE", and press **ENTER**.

- 3 Press ▲/▼ to select "ON", and press **ENTER**.
- 4 Press **MENU** to exit.

NOTE

- Set "FILM MODE" to "ON" manually to detect a film-based source (originally encoded at 24 frames/second).
- "FILM MODE" cannot be set when 480P, 576P, 720P or 1080I signal is received from the COMPONENT terminals.

AUDIO Adjustments

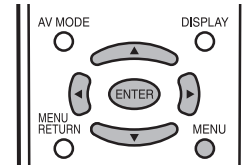
You can adjust the sound quality to your preference with the following settings.

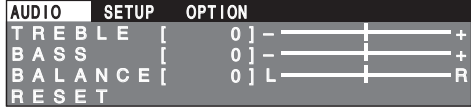

- 1 Press **MENU** to display the Menu screen.
- 2 Press ◀/▶ to select "AUDIO".
- 3 Press ▲/▼ to select a specific adjustment item.

- 4 Press ◀/▶ to adjust the item to the desired position.
- 5 Press **MENU** to exit.

Selected item	◀ button	▶ button
TREBLE	For weaker treble	For stronger treble
BASS	For weaker bass	For stronger bass
BALANCE	Decrease audio from the right speaker	Decrease audio from the left speaker

NOTE

- The items on the AUDIO menu cannot be set when headphones are not used and "INPUT3 SELECT" is set to "OUT ~~X~~ VAO".
- When resetting all adjustment items to factory preset values, perform the following procedure.
 - ① Press ▲/▼ to select "RESET" in the AUDIO screen, and press **ENTER**.
 - ② Press ▲/▼ to select "YES", and press **ENTER**.

Useful Features

CH SETUP

EZ SETUP

When you move to an area with different broadcasting signals, you may have to set the channel numbers and the time with the EZ SETUP function. To activate EZ SETUP, perform the following procedure.

- 1 Press ▲/▼ to select "CH SETUP" in the SETUP screen (see page 19), and press **ENTER**.
- 2 Press ▲/▼ to select "EZ SETUP", and press **ENTER**.
- 3 Press ▲/▼ to select "YES", and press **ENTER**.

Refer to page 14 for more information on EZ SETUP.

Setting the AIR/CABLE

It is necessary to set the receiving mode to AIR or CABLE channels to receive locally broadcast TV programs.

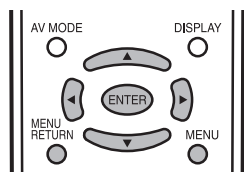

- 1 Press **MENU** to display the Menu screen.
- 2 Press ◀/▶ to select "SETUP".
- 3 Press ▲/▼ to select "CH SETUP", and press **ENTER**.
- 4 Press ▲/▼ to select "AIR/CABLE", and press **ENTER**. Press ▲/▼ to select the desired setting, and press **ENTER**.

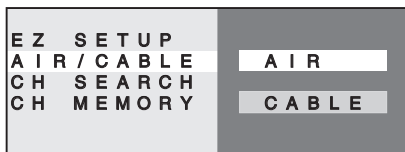

- 5 Press **MENU** to exit.

NOTE

- Receivable channels of the LCD TV set are:
 AIR channels: VHF: 2 through 13. UHF: 14 through 69.
 CABLE channels: 1 (HRC and IRC) 2 through 125 (STD, HRC and IRC)

Saving broadcast TV channels in the memory

- 1 Repeat steps 1 to 3 of **Setting the AIR/CABLE**.
- 2 Press ▲/▼ to select "CH SEARCH", and press **ENTER**.



- 3 Press **ENTER**. The tuner will search through all available channels in your area and add them to the TV memory.



NOTE

- To interrupt CH SEARCH, press **MENU RETURN**. CH SEARCH will stop at the current channel and will not add any higher channels.

Adding weak or additional channels or erasing unwanted channels from TV memory

Individual settings of programs can be adjusted.

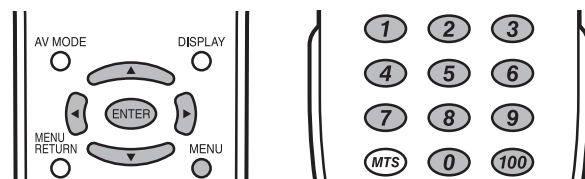

- 1 Repeat steps 1 to 3 of **Setting the AIR/CABLE**.
- 2 Press ▲/▼ to select "CH MEMORY", and press **ENTER**.



- 3 Press ▲/▼ to move the cursor to "CHANNEL", and use ◀/▶ or **Channel Select** to select the desired channel to be added or erased.
- 4 Press ▲/▼ to move the cursor to "SKIP", and use ◀/▶ to select "ON" or "OFF".
- 5 Press **MENU** to exit.

NOTE

- If CH SEARCH is performed again, the previously memorized channels will be lost.

Useful Features (Continued)

SETUP

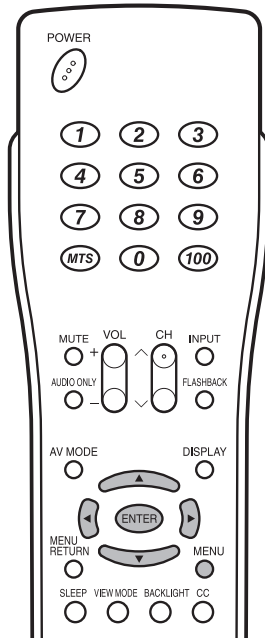

- 1 Press **MENU** to display the Menu screen.
- 2 Press **◀/▶** to select "SETUP".
- 3 Press **▲/▼** to select the desired item, and press **ENTER**.

SETUP	OPTION
CH	SETUP
MTS	
CLOCK	
INPUT 3	SELECT
V-CHIP	BLOCK
CLOSED	CAPTION
COLOR	SYSTEM
LANGUAGE	
- 4 Press **▲/▼** to change the setting, and press **ENTER**.
- 5 Press **MENU** to exit.

Selected item	Factory setting	Setting options
MTS	[STEREO] Stereo audio	[SAP] Secondary audio program [MONO] Monophonic audio
INPUT3 SELECT*1	[IN] INPUT3/OUTPUT terminals selected as input terminals	[OUT <input type="checkbox"/> FAO] Line output is selected, output volume is fixed, speaker output is available. [OUT <input checked="" type="checkbox"/> VAO] Line output is selected, output volume is variable, speaker output is mute.
COLOR SYSTEM	TV mode*2: N358/PAL-M/PAL-N INPUT mode (INPUT2/INPUT3): N358/N443/PAL/PAL-M/PAL-N/SECAM/PAL60/AUTO • When the INPUT1 (COMPONENT) mode is selected, this function cannot be set.	
LANGUAGE	[ENGLISH]	[ESPAÑOL] [FRANÇAIS]

*1 "INPUT3 SELECT" cannot be set when "INPUT3" is selected in "WAKE-UP TIMER" in the OPTION menu.

*2 TV mode:

The LCD TV set is factory set to comply with the color system in the United States (NTSC-N358).

For Brazil (PAL-M), Argentina (PAL-N) or Uruguay (PAL-N), adjust the color system before using the LCD TV set.

For details about the following items, refer to each indicated page.

- CH SETUP Page **24**
- CLOCK Pages **15** and **16**
- V-CHIP BLOCK Pages **26** to **29**
- CLOSED CAPTION Page **30**

Useful Features (Continued)

V-CHIP Settings

V-CHIP

- This function allows TV programs to be restricted and TV usage to be controlled based on FCC data. It prevents children from watching violent or sexual scenes that may be harmful.
- Restriction of TV programs includes two ratings that contain information about the program: the MPAA (Motion Picture Association of America) rating and the TV Parental Guidelines. The MPAA rating is restricted by age. TV Parental Guidelines are restricted by age and content.
- Since a TV program may use either the MPAA rating or the TV Guidelines, both should be adjusted for complete control.

MPAA rating

Rating	Description	
↑↑ age-based ↓↓	G	GENERAL AUDIENCES. All ages admitted.
	PG	PARENTAL GUIDANCE SUGGESTED. Some material may not be suitable for children.
	PG-13	PARENTS STRONGLY CAUTIONED. Some material may be inappropriate for children under 13.
	R	RESTRICTED. Under 17 requires accompanying parent or adult guardian.
	NC-17	NO ONE 17 AND UNDER ADMITTED.
X	X is an older rating that is unified with NC-17 but may be encoded in the data of older movies.	

MPAA rating

Example 1:

PG-13 in the age-based rating is blocked, this will also automatically block the higher ratings R, NC-17 and X.

1. User setting

G	----
PG	----
PG-13	BLOCK
R	BLOCK
NC-17	BLOCK
X	BLOCK

2. Block table

G	Not to block
PG	Not to block
PG-13	Select block
R	Auto-block
NC-17	Auto-block
X	Auto-block

Example 2:

R in the age-based rating is blocked, this will also automatically block the higher ratings NC-17 and X.

1. User setting

G	----
PG	----
PG-13	----
R	BLOCK
NC-17	BLOCK
X	BLOCK

2. Block table

G	Not to block
PG	Not to block
PG-13	Not to block
R	Select block
NC-17	Auto-block
X	Auto-block

NOTE

- The MPAA rating is only age-based.

TV parental guidelines

Rating	content-based					
	FV (Fantasy Violence)	V (Violence)	S (Sexual Situation)	L (Adult Language)	D (Sexually Suggestive Dialog)	
↑↑ age-based ↓↓	TV-Y (All children)	☒	☒	☒	☒	☒
	TV-Y7 (Direct to Older Children)	×	☒	☒	☒	☒
	TV-G (General Audience)		☒	☒	☒	☒
	TV-PG (Parental Guidance Suggested)		×	×	×	×
	TV-14 (Parents Strongly Cautioned)		×	×	×	×
	TV-MA (Mature Audience Only)		×	×	×	

☒: The content rating can be set, but this rating is not normally broadcast by TV stations.

×: The content rating can be set.

TV parental guidelines

Example:

When TV-Y7 in the age-based rating is set to BLOCK, the higher ratings (TV-G, TV-PG, TV-14 and TV-MA) will also be blocked automatically. In addition, D, L, S, V and FV in BLOCK CONTENT are automatically blocked unless you manually set BLOCK CONTENT.

1. User setting

TV-Y	----
TV-Y7	BLOCK
TV-G	BLOCK
TV-PG	BLOCK
TV-14	BLOCK
TV-MA	BLOCK
BLOCK CONTENT (D L S V FV)	

2. Block table

age-based	content-based				
	FV	V	S	L	D
TV-Y					
TV-Y7					
TV-G					
TV-PG					
TV-14					
TV-MA					

TV-Y7 Select block
 Auto-block

NOTE

- Age-based ratings can be modified by the content-based ratings, but only in the combinations indicated by an × in the table above.
- Choosing a lower age-based rating blocks the higher age-based ratings regardless of content rating settings.
- If you set TV-Y or TV-Y7 to BLOCK, BLOCK CONTENT will display all items.

Canadian Rating Systems

- The TV rating systems in Canada are based on the Canadian Radio-Television and Telecommunications Commission (CRTC) policy on violence in television programming.
- While violence is the most important content element to be rated, the structure developed takes into consideration other program content like language, nudity, sexuality and mature themes.
- When setting the V-CHIP on the Canadian system you can choose either the Canadian English ratings or the Canadian French ratings.

Canadian English ratings

Rating		Description
↑↑ age-based ↓↓	C	Children: Intended for younger children under the age of 8 years. Pays careful attention to themes that could threaten their sense of security and well-being.
	C8 +	Children over 8 years old: Contains no portrayal of violence as the preferred, acceptable, or only way to resolve conflict; nor encourage children to imitate dangerous acts which they may see on the screen.
	G	General: Considered acceptable for all age groups. Appropriate viewing for the entire family, contains very little violence, physical, verbal or emotional.
	PG	Parental Guidance: Intended for a general audience, but may not be suitable for younger children (under the age of 8) because it could contain controversial themes or issues.
	14 +	Over 14 Years: Could contain themes where violence is one of the dominant elements of the storyline, but it must be integral to the development of plot or character. Language usage could be profane and nudity present within the context of the theme.
	18 +	Adults: Intended for viewers 18 years and older and might contain depictions of violence, which while related to the development of plot, character or themes, are intended for adult viewing. Could contain graphic language and portrayals of sex and nudity.

Canadian French ratings

Rating		Description
↑↑ age-based ↓↓	G	General: All ages and children, contains minimal direct violence, but may be integrated into the plot in a humorous or unrealistic manner.
	8 ans +	General but inadvisable for young children: May be viewed by a wide public audience, but could contain scenes disturbing to children under 8 who cannot distinguish between imaginary and real situations. Recommended for viewing with parent.
	13 ans +	Over 13 years: Could contain scenes of frequent violent scenes and therefore recommended for viewing with parent.
	16 ans +	Over 16 years: Could contain frequent violent scenes and intense violence.
	18 ans +	Over 18 years: Only for adult viewing. Could contain frequent violent scenes and extreme violence.

Useful Features (Continued)

V-CHIP Settings (Continued)

V-CHIP settings allow you to set MPA A rating, TV GUIDELINES, Canadian English ratings and Canadian French ratings.

Setting V-CHIP

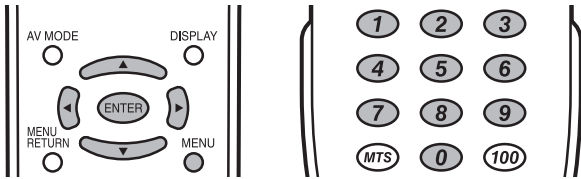

- 1 Press **MENU** to display the Menu screen.
- 2 Press **◀/▶** to select "SETUP".
- 3 Press **▲/▼** to select "V-CHIP BLOCK", and press **ENTER**.
- 4 "INPUT SECRET NO." will be displayed. Input the 4-digit secret number by using **Channel Select**.

NOTE ▶

- When you input the secret number for the first time, press **ENTER** to register. Otherwise, continue to step 5.



- 5 Press **▲/▼** to select the desired item, and press **ENTER**.

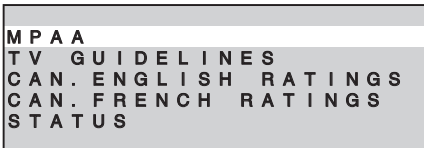

- 6 Press **▲/▼** to select the desired item, press **◀/▶** to select "BLOCK".

(MPAA rating)

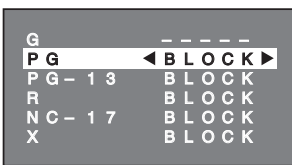

(TV GUIDELINES)

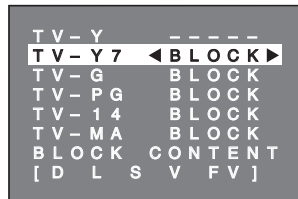

(Canadian English ratings)

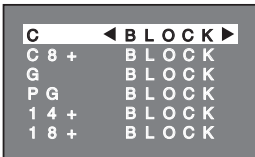

(Canadian French ratings)

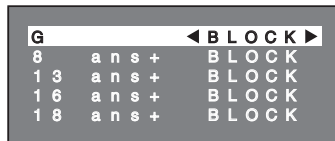

- 7 Press **MENU** to exit.

NOTE ▶

- The setting automatically enters "BLOCK" for any ratings below your selection.

Setting BLOCK CONTENT (TV GUIDELINES)

- 1 Repeat steps 1 to 4 of **Setting V-CHIP**.
- 2 Press **▲/▼** to select "TV GUIDELINES", and press **ENTER**.
- 3 Press **▲/▼** to select "BLOCK CONTENT", and press **ENTER**.

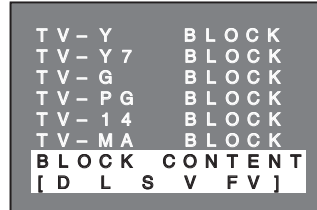

- 4 Press **▲/▼** to select the desired item, and press **◀/▶** to select "BLOCK" or "-----" (unlock).

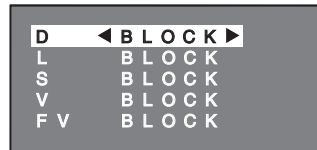

- 5 Press **MENU** to exit.

■ Activating V-CHIP BLOCK

● Setting STATUS

You can activate V-CHIP BLOCK after setting V-CHIP.

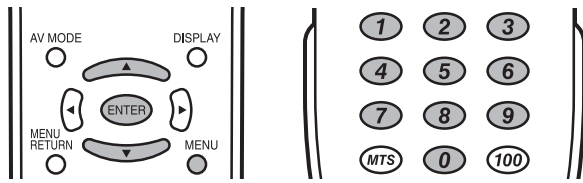

1 Repeat steps 1 to 4 of **Setting V-CHIP** on page 28.

2 Press ▲/▼ to select "STATUS", and press ENTER.



3 Press ▲/▼ to select "ON", and press ENTER.



NOTE

- If "STATUS" is set to "OFF", V-CHIP BLOCK will not be activated.

4 Press MENU to exit.

■ Canceling the V-CHIP BLOCK screen while V-CHIP BLOCK is activated

1 "V-CHIP HAS BEEN ACTIVATED" appears if you watch a program with the same Program Rating data you configured.



NOTE

- "V-CHIP HAS BEEN ACTIVATED" will not be displayed if "STATUS" is set to "OFF".

2 Press MENU to display "INPUT SECRET NO.".



3 Input the 4-digit secret number by using **Channel Select**; V-CHIP BLOCK is temporarily canceled. If you input an incorrect secret number, "SECRET NO. IS INCORRECT." is displayed. In this case, input the correct secret number.

■ Changing V-CHIP BLOCK settings

1 Repeat steps 1 to 3 of **Setting V-CHIP** on page 28, then "INPUT SECRET NO." will be displayed.



2 Input the 4-digit secret number by using **Channel Select**; the V-CHIP select mode will be displayed. Set the V-CHIP BLOCK again.

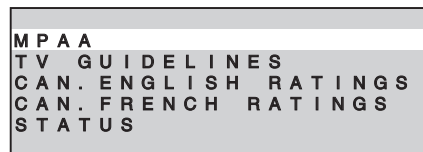

■ Changing or clearing the SECRET NUMBER

If you forgot the secret number, clear the secret number as follows.

Upper control panel of the main unit

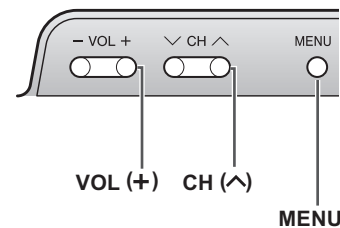

1 Repeat steps 1 to 3 of **Setting V-CHIP** on page 28, or 1 and 2 of **Canceling the V-CHIP BLOCK screen while V-CHIP BLOCK is activated**, then "INPUT SECRET NO." will be displayed.

2 Press and hold both **CH (^)** and **VOL (+)** on the main unit simultaneously until the message "INPUT SECRET NO." blinks.

3 Press **MENU** to exit.

Useful Features (Continued)

CLOSED CAPTION

Setting CLOSED CAPTION

- This LCD TV set is equipped with an internal Closed Caption decoder. "Closed Caption" is a system which allows conversations, narration, and sound effects in TV programs and home videos to be viewed as captions on the TV screen (see the illustration).
- Not all programs and videos will offer closed captioning. Please look for the "CC" symbol to ensure that captions will be shown.
- The Closed Caption broadcasts can be viewed in two modes: CAPTION and TEXT. For each mode, two channels are available: CH1 and CH2.

The CAPTION mode shows subtitles of dialogs and commentaries of TV dramas and news programs while allowing a clear view of the picture.

The TEXT mode displays various information over the picture (such as TV program schedules and weather forecasts, etc.) that is independent of the TV programs.

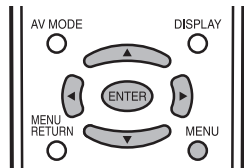

- Press **MENU** to display the Menu screen.
- Press **◀/▶** to select "SETUP".
- Press **▲/▼** to select "CLOSED CAPTION", and press **ENTER**.
- Press **▲/▼** to change the CLOSED CAPTION setting, and press **ENTER**.

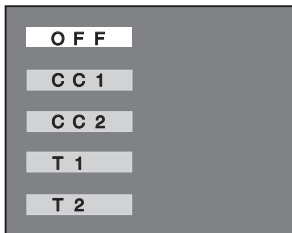

NOTE

- CC1**: CLOSED CAPTION mode for CH1 data
- CC2**: CLOSED CAPTION mode for CH2 data
- T1**: TEXT mode for CH1 data
- T2**: TEXT mode for CH2 data

- Press **MENU** to exit.

Directly setting the CLOSED CAPTION

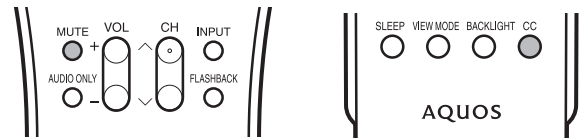

- Press **CC** to display the CC/TEXT screen.



- Press **CC** to change the setting.



NOTE

- CC1**: CLOSED CAPTION mode for CH1 data
- CC2**: CLOSED CAPTION mode for CH2 data
- T1**: TEXT mode for CH1 data
- T2**: TEXT mode for CH2 data

NOTE

- If a broadcast contains Closed Caption data and **MUTE** is pressed, the LCD TV set enters CLOSED CAPTION mode automatically. Pressing **MUTE** again will return the LCD TV set to its previous condition.
- Closed Caption may malfunction (white blocks, strange characters, etc.) if signal conditions are poor or if there are problems at the broadcast source. This does not necessarily indicate a problem with the LCD TV set.
- If any button is pressed to call up the on-screen display while viewing a Closed Caption broadcast, the closed captions will disappear momentarily.
- If no TEXT broadcast is being received while viewing in the TEXT mode, the screen may become blank for some programs. Should this occur, switch the CLOSED CAPTION mode to "OFF".
- If you select "CC1", "CC2", "T1" or "T2" (or **MUTE** is pressed) while "VIEW MODE" is set to "ZOOM" or "STRETCH", "VIEW MODE" will be changed to "4:3" or "16:9" automatically.

VIEW MODE

You can select the picture display size for the playback image of the DVD player from the following four modes: "4:3", "16:9", "ZOOM" and "STRETCH".

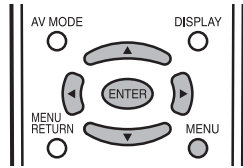

- 1 Press **MENU** to display the Menu screen.
- 2 Press **◀/▶** to select "OPTION".
- 3 Press **▲/▼** to select "VIEW MODE", and press **ENTER**.
- 4 Press **▲/▼** to select the desired setting, and press **ENTER**.

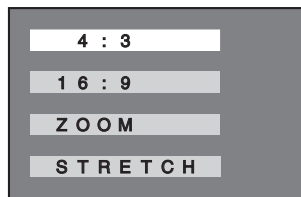

Selected item	Description
4:3	Displays the image in a 4:3 size.
16:9	Stretches the image horizontally to display it in a 16:9 size.
ZOOM	Displays the center part of the image by enlarging it in the horizontal and vertical directions.
STRETCH	Stretches the image horizontally.

Image type	4:3	16:9	ZOOM	STRETCH
(For an image stretched vertically)				
(For an image stretched vertically with bands at the left and right sides)				
(For a 4:3 image)				

- 5 Press **MENU** to exit.

NOTE

- The 4:3 image will be distorted on the screen when the "VIEW MODE" is set to "16:9".
- When "CLOSED CAPTION" is set to "CC1", "CC2", "T1" or "T2", "ZOOM" and "STRETCH" cannot be set for "VIEW MODE".
- You can select a different VIEW MODE item for each input mode (INPUT1, INPUT2, INPUT3 and TV).

■ Directly setting the VIEW MODE

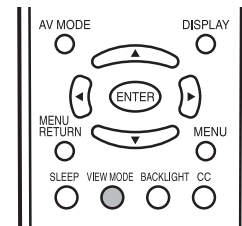

- 1 Press **VIEW MODE** to display the VIEW MODE screen.

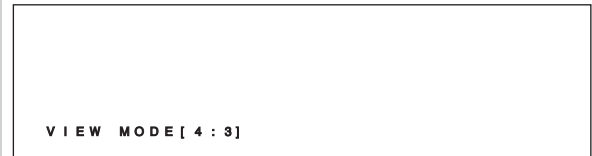

- 2 Each time you press **VIEW MODE**, the mode changes as shown below.

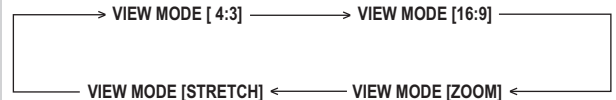

Useful Features (Continued)

AUDIO ONLY

When listening to music from a music program, you can turn the Liquid Crystal display off and enjoy audio only.

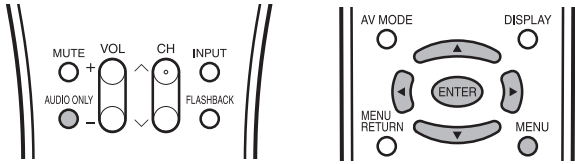

Setting the AUDIO ONLY on the Menu screen

- 1 Press **MENU** to display the Menu screen.
- 2 Press **◀/▶** to select "OPTION".
- 3 Press **▲/▼** to select "AUDIO ONLY", and press **ENTER**.
- 4 Press **▲/▼** to select "ON", and press **ENTER**.



Selected item	Description
ON	Audio is output without screen image.
OFF	Both screen images and audio are output.

Directly setting the AUDIO ONLY

- 1 Press **AUDIO ONLY**. 'PRESS "AUDIO ONLY" FOR VIDEO OFF' is displayed on the screen.



- 2 Press **AUDIO ONLY** again. The screen image will disappear.
- 3 Press **AUDIO ONLY** again. The screen image will be displayed again.

BLUE SCREEN

This function automatically turns the screen blue if no broadcast signal or no input signal is received.

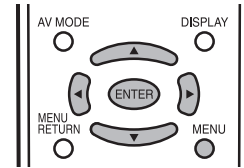

- 1 Press **MENU** to display the Menu screen.
- 2 Press **◀/▶** to select "OPTION".
- 3 Press **▲/▼** to select "BLUE SCREEN", and press **ENTER**.
- 4 Press **▲/▼** to select "ON", and press **ENTER**.
- 5 Press **MENU** to exit.



NOTE

- When received signals are weak or interfered with by some other signals, the BLUE SCREEN function may be activated. To watch the TV under such conditions, set "BLUE SCREEN" to "OFF".

SLEEP TIMER

You can set the SLEEP TIMER to automatically turn off the TV.

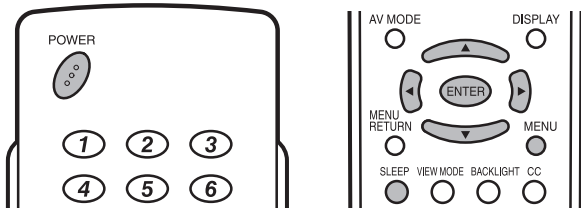

Setting the SLEEP TIMER on the Menu screen

- 1 Press **MENU** to display the Menu screen.
- 2 Press **◀/▶** to select "OPTION".
- 3 Press **▲/▼** to select "SLEEP TIMER", and press **ENTER**.
- 4 Press **▲/▼/◀/▶** to select "30MIN", "60MIN", "90MIN", "120MIN", "150MIN" or "OFF", and press **ENTER**.

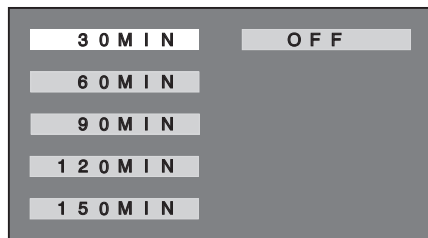

- 5 Press **MENU** to exit.

NOTE

- After you set the SLEEP TIMER, pressing **POWER** on the main unit or **POWER** on the remote control will cancel the SLEEP TIMER setting.
- 5 minutes before the SLEEP TIMER turns off the LCD TV set, "5MIN REMAINING" is displayed on the screen for 4 seconds. The SLEEP TIMER counts down and shows a similar 4-second display for each remaining minute until the timer turns off the LCD TV set.

Directly setting the SLEEP TIMER

- 1 Press **SLEEP** to display the SLEEP TIMER screen.



- 2 Press **SLEEP** to change the setting.

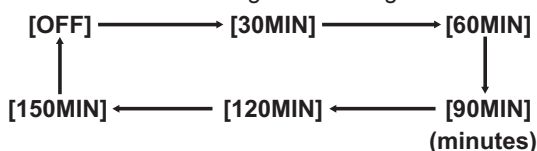

NOTE

- The SLEEP TIMER screen automatically disappears in 3 seconds.

WAKE-UP TIMER

You can set the WAKE-UP TIMER to automatically turn on the TV.

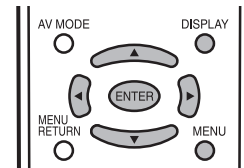

- 1 Repeat steps 1 and 2 of **SLEEP TIMER**.
- 2 Press **▲/▼** to select "WAKE-UP TIMER", and press **ENTER**.
- 3 Press **▲/▼** to select the items, and press **◀/▶** to adjust them.

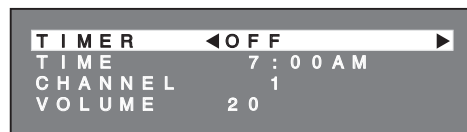

Selected item	Description
TIMER	To activate the WAKE-UP TIMER, set this item to "ON".
TIME	Set the time at which you want to turn on the TV.
CHANNEL	Set the TV channel or input mode when the TV is turned on.
VOLUME	Set the volume when the TV is turned on.

- 4 Press **MENU** to exit.
- 5 Make sure to turn off the LCD TV set with the remote control.
 - The WAKE-UP TIMER will not be activated if the LCD TV is turned off with **POWER** on the main unit.

NOTE

- When you set "WAKE-UP TIMER", the POWER/WAKE UP TIMER indicator lights up orange while in the standby mode.
- Be sure to adjust the clock with "CLOCK" in "SETUP" before setting "SLEEP TIMER" and "WAKE-UP TIMER".
- You can output the picture and sound of the external device with the WAKE-UP TIMER function. Make sure that the external device turns on at the time you specified.
- The CHANNEL setting for "WAKE-UP TIMER" changes in the following order: INPUT1→INPUT2→INPUT3→TV (AIR or CABLE)*
- * The skipped channels cannot be selected.
- When not using LCD TV set for a long period of time, either turn the main power off or set "WAKE-UP TIMER" to "OFF".
- When "WAKE-UP TIMER" has been set to "ON", the TV is turned on at the set time every day until it is set to "OFF".
- After the TV has been turned "ON" by "WAKE-UP TIMER", "SLEEP TIMER" is automatically set to 120 minutes for safety reason.
- The time that is currently set can be checked on the screen by pressing **DISPLAY**.
- When the time set for "WAKE-UP TIMER" is reached when the power is on, the TV changes to the set channel. The volume does not change at this time.

Useful Features (Continued)

NO SIGNAL OFF

The NO SIGNAL OFF function allows you to save energy. When set to "ENABLE", the power will automatically shut down if no signal inputs for 5 minutes.

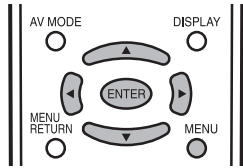

- 1 Press **MENU** to display the Menu screen.
- 2 Press **◀/▶** to select "OPTION".
- 3 Press **▲/▼** to select "NO SIGNAL OFF", and press **ENTER**.
- 4 Press **▲/▼** to select "ENABLE", and press **ENTER**.



- 5 Press **MENU** to exit.

NOTE

- "DISABLE" is factory preset value.
- This function can work only in TV mode.
- If interfered with by other broadcast or radio waves, "NO SIGNAL OFF" may not work properly even when the broadcast is over.

NO OPERATION OFF

When set to "Enable", the power will automatically shut down if there is no operation for 3 hours.

- 1 Repeat steps 1 and 2 of **NO SIGNAL OFF**.
- 2 Press **▲/▼** to select "NO OPERATION OFF", and press **ENTER**.
- 3 Press **▲/▼** to select "ENABLE", and press **ENTER**.

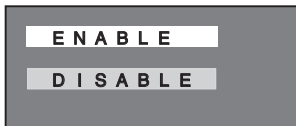

- 5 minutes before the power shuts down, remaining time is displayed every minute.

- 4 Press **MENU** to exit.

NOTE

- "DISABLE" is factory preset value.

PICTURE FLIP

You can set the orientation of the picture.

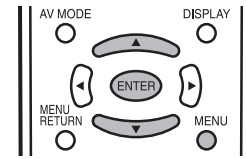

- 1 Repeat steps 1 and 2 of **NO SIGNAL OFF**.
- 2 Press **▲/▼** to select "PICTURE FLIP", and press **ENTER**.
- 3 Press **▲/▼** to select the desired mode, and press **ENTER**.

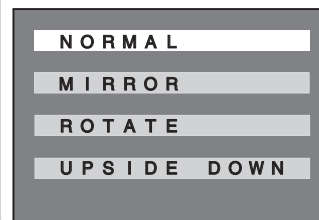

- 4 Press **MENU** to exit.

[NORMAL]
Normal image orientation.



[MIRROR]
To display mirror images for special uses.



[UPSIDE DOWN]
To display upside down images for special uses.









[ROTATE]
To display rotated images for special uses.

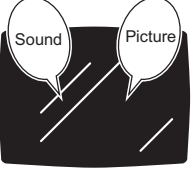
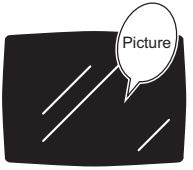

Troubleshooting

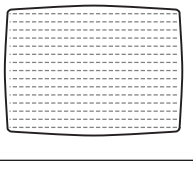
■ Before calling for repair services, make the following checks for possible remedies to the encountered symptoms.

LCD TV set

Problem	Check item	Reference page
 <p>There is no picture or sound.</p>	<ul style="list-style-type: none"> • Make sure the AC cord is properly inserted in the power outlet. • Reception other than those of broadcasting stations can be considered. • Make sure the input mode is set to TV. • Make sure the POWER switch of the main unit is on. 	<p>9</p> <p>–</p> <p>17</p> <p>16</p>
 <p>There is no picture. There is no picture from INPUT1/2/3.</p>	<ul style="list-style-type: none"> • Make sure the BRIGHTNESS is properly adjusted. • Fluorescent lamp may have reached the end of service life. • Make sure the S-VIDEO terminal has nothing connected. • Make sure the AUDIO ONLY is not set to ON. 	<p>21</p> <p>36</p> <p>13</p> <p>32</p>
 <p>There is no sound.</p>	<ul style="list-style-type: none"> • Make sure the volume is not set to minimum. • Make sure the sound is not set to mute. • Make sure that headphones are not connected. 	<p>17</p> <p>17</p> <p>10</p>
 <p>There is no picture or sound, just noise.</p>	<ul style="list-style-type: none"> • Make sure the antenna cable is properly connected. • Bad reception could be the problem. 	<p>8, 9</p> <p>–</p>
 <p>Picture is not clear.</p>	<ul style="list-style-type: none"> • Make sure the antenna cable is properly connected. • Bad reception could be the problem. 	<p>8, 9</p> <p>–</p>
 <p>Picture is light or improperly tinted.</p>	<ul style="list-style-type: none"> • Check color adjustment. • Check COLOR SYSTEM setting. 	<p>21, 22</p> <p>25</p>
 <p>The picture is too dark.</p>	<ul style="list-style-type: none"> • Press the BACKLIGHT button or set the BACKLIGHT or BRIGHTNESS settings. • Check CONTRAST and BRIGHTNESS adjustment. • Fluorescent lamp may have reached the end of service life. 	<p>21</p> <p>21</p> <p>36</p>
Remote control does not work.	<ul style="list-style-type: none"> • Check the batteries of the remote control. • Make sure the remote sensor window is not in strong lighting. 	<p>7</p> <p>7</p>
The clock (AUTO CLOCK) cannot be set.	<ul style="list-style-type: none"> • The broadcasted EDS signal may be weak. Check the antenna. • Carry out EZ SETUP or Setting the CLOCK again. • If EDS signal is not sent, set the clock using MANUAL CLOCK Setting. 	<p>–</p> <p>14, 15, 24</p> <p>15</p>
Unit cannot be operated.	<ul style="list-style-type: none"> • External influences such as lightning, static electricity, etc., may cause improper operation. In this case, operate the unit after first turning the power off, or unplugging the AC cord and re-plugging it in 1 or 2 minutes. 	<p>–</p>

Troubleshooting (Continued)

■ Before calling for repair services, make the following checks for possible remedies to the encountered symptoms.

Antenna

Problem	Check item
The picture is not sharp. The picture moves.	<ul style="list-style-type: none"> • The reception may be weak. • The quality of the broadcast may also be bad. • Make sure the antenna is facing the right direction. • Make sure the outside antenna is connected.
The picture is doubled or tripled.	<ul style="list-style-type: none"> • Make sure the antenna is facing the right direction. • There may be reflected electric waves from mountains or buildings.
The picture is spotted.	<ul style="list-style-type: none"> • There may be interference from automobiles, trains, high voltage lines, neon lights, etc. • There may be interference between the antenna cable and AC cord. Try positioning them further apart.
There are stripes on the screen or colors fade.	<ul style="list-style-type: none"> • Is the unit receiving interference from other devices? Transmission antennas of radio broadcasting stations, transmission antennas of amateur radios and cellular phones may also cause interference. • Use the unit as far apart as possible from devices that may cause possible interference.

■ Cautions regarding use in high and low temperature environments

- When the unit is used in a low temperature space (e.g. room, office), the picture may leave trails or appear slightly delayed. This is not a malfunction, and the unit will recover when the temperature returns to normal.
- Do not leave the unit in a hot or cold location. Also, do not leave the unit in a location exposed to direct sunlight or near a heater, as this may cause the cabinet to deform and the LCD panel to malfunction.
Storage temperature: -4°F to +140°F (-20°C to +60°C)

Specifications

Items	Model	LC-20S5U
LCD panel		20" Advanced Super View & BLACK TFT LCD
Number of dots		921,600 dots VGA
Video color systems		N358, N443, PAL, PAL-M, PAL-N, SECAM, PAL-60
TV function	TV Standard (CCIR)	NTSC/PAL-M/PAL-N
	TV Tuning System	PLL 181 ch.
	STEREO	MTS+SAP
	CATV	125 ch.
Y/C FILTER		3D Y/C FILTER
Brightness		450 cd/m ²
Lamp life (Fluorescent lamp)		60,000 hours*
Viewing angles		H: 170° V: 170°
Audio amplifier		2.1 W × 2
Speakers		1 ³⁷ / ₆₄ × 4 ²¹ / ₆₄ in. (4 × 11 cm), 2 pcs.
Terminals	INPUT1	AUDIO-IN, COMPONENT-IN
	INPUT2	AUDIO-IN, VIDEO-IN, S-VIDEO-IN
	INPUT3/OUTPUT	AUDIO-IN, VIDEO-IN/AUDIO-OUT, VIDEO-OUT
	Antenna	F-Type
	Headphone	Mini-jack for stereo (ø3.5 mm)
OSD language		English/Spanish/French
Power supply		AC 110-240V, 50/60Hz
Power consumption		72 W (0.6 W standby): AC 120V
Weight	Display only	13.9 lbs./6.3 kg
	Display with stand	15.9 lbs./7.2 kg
Operating temperature		+32°F to +104°F (0°C to +40°C)

* Typical time for power output decrease of about one-half assuming continuous use in a room with normal lighting, normal brightness and temperature at 77°F/25°C

Dimensional Drawings

- The dimensional drawings are shown on the inside back cover.

■ As a part of policy of continuous improvement, SHARP reserves the right to make design and specification changes for the LCD TV set improvement without prior notice. The performance specification figures indicated are nominal values of production units. There may be some deviations from these values in individual units.

Calling for Service

For location of the nearest Sharp Authorized Service, or to obtain product literature, accessories, supplies, or customer assistance, please call 1-800-BE-SHARP.

LIMITED WARRANTY

CONSUMER LIMITED WARRANTY

SHARP ELECTRONICS CORPORATION warrants to the first consumer purchaser that this Sharp brand product (the "Product"), when shipped in its original container, will be free from defective workmanship and materials, and agrees that it will, at its option, either repair the defect or replace the defective Product or part thereof with a new or remanufactured equivalent at no charge to the purchaser for parts or labor for the period(s) set forth below.

This warranty does not apply to any appearance items of the Product nor to the additional excluded item(s) set forth below nor to any Product the exterior of which has been damaged or defaced, which has been subjected to improper voltage or other misuse, abnormal service or handling, or which has been altered or modified in design or construction.

In order to enforce the rights under this limited warranty, the purchaser should follow the steps set forth below and provide proof of purchase to the servicer.

The limited warranty described herein is in addition to whatever implied warranties may be granted to purchasers by law. ALL IMPLIED WARRANTIES INCLUDING THE WARRANTIES OF MERCHANTABILITY AND FITNESS FOR USE ARE LIMITED TO THE PERIOD(S) FROM THE DATE OF PURCHASE SET FORTH BELOW. Some states do not allow limitations on how long an implied warranty lasts, so the above limitation may not apply to you.

Neither the sales personnel of the seller nor any other person is authorized to make any warranties other than those described herein, or to extend the duration of any warranties beyond the time period described herein on behalf of Sharp.

The warranties described herein shall be the sole and exclusive warranties granted by Sharp and shall be the sole and exclusive remedy available to the purchaser. Correction of defects, in the manner and for the period of time described herein, shall constitute complete fulfillment of all liabilities and responsibilities of Sharp to the purchaser with respect to the Product, and shall constitute full satisfaction of all claims, whether based on contract, negligence, strict liability or otherwise. In no event shall Sharp be liable, or in any way responsible, for any damages or defects in the Product which were caused by repairs or attempted repairs performed by anyone other than an authorized servicer. Nor shall Sharp be liable or in any way responsible for any incidental or consequential economic or property damage. Some states do not allow the exclusion of incidental or consequential damages, so the above exclusion may not apply to you.

THIS WARRANTY GIVES YOU SPECIFIC LEGAL RIGHTS. YOU MAY ALSO HAVE OTHER RIGHTS WHICH VARY FROM STATE TO STATE.

Model Specific Section

<u>Your Product Model Number & Description:</u>	LC-20S5U LCD Color Television (Be sure to have this information available when you need service for your Product.)
<u>Warranty Period for this Product:</u>	One (1) year parts and labor from the date of purchase.
<u>Additional Item(s) Excluded from Warranty Coverage (if any):</u>	Non-rechargeable batteries.
<u>Where to Obtain Service:</u>	From a Sharp Authorized Servicer located in the United States. To find the location of the nearest Sharp Authorized Servicer, call Sharp toll free at 1-800-BE-SHARP.
<u>What to do to Obtain Service:</u>	Ship prepaid or carry in your Product to a Sharp Authorized Servicer. Be sure to have Proof of Purchase available. If you ship the Product, be sure it is insured and packaged securely.

TO OBTAIN PRODUCT INFORMATION, CALL 1-800-BE-SHARP OR VISIT www.sharpusa.com

SHARP®

SHARP ELECTRONICS CORPORATION

Sharp Plaza, Mahwah, New Jersey 07430-2135

SHARP CORPORATION

Free Manuals Download Website

<http://myh66.com>

<http://usermanuals.us>

<http://www.somanuals.com>

<http://www.4manuals.cc>

<http://www.manual-lib.com>

<http://www.404manual.com>

<http://www.luxmanual.com>

<http://aubethermostatmanual.com>

Golf course search by state

<http://golfingnear.com>

Email search by domain

<http://emailbydomain.com>

Auto manuals search

<http://auto.somanuals.com>

TV manuals search

<http://tv.somanuals.com>