

SHARP

HOME THEATER WITH DVD

MODEL

HT-X1

OPERATION MANUAL

Thank you for purchasing this SHARP product. To obtain the best performance from this product, please read this manual carefully. It will guide you in operating your SHARP product.

HT-X1 Home Theater with DVD consisting of HT-X1 (main unit and subwoofer/amplifier unit), CP-X1F (front speakers), CP-X1C (center speaker) and CP-X1S (surround speakers).



MP3

PROGRESSIVE
SCAN

SPECIAL NOTES



CAUTION: TO REDUCE THE RISK OF ELECTRIC SHOCK, DO NOT REMOVE COVER (OR BACK). NO USER-SERVICEABLE PARTS INSIDE. REFER SERVICING TO QUALIFIED SERVICE PERSONNEL.

Explanation of Graphical Symbols:



The lightning flash with arrowhead symbol, within an equilateral triangle, is intended to alert the user to the presence of uninsulated "dangerous voltage" within the product's enclosure that may be of sufficient magnitude to constitute a risk of electric shock to persons.



The exclamation point within an equilateral triangle is intended to alert the user to the presence of important operating and maintenance (servicing) instructions in the literature accompanying the appliance.

WARNING: TO REDUCE THE RISK OF FIRE OR ELECTRIC SHOCK, DO NOT EXPOSE THIS APPLIANCE TO RAIN OR MOISTURE.

CAUTION:

THIS PRODUCT IS A CLASS 1 LASER PRODUCT. USE OF CONTROLS OR ADJUSTMENTS OR PERFORMANCE OF PROCEDURES OTHER THAN THOSE SPECIFIED HEREIN MAY RESULT IN HAZARDOUS RADIATION EXPOSURE. AS THE LASER BEAM USED IN THIS PRODUCT IS HARMFUL TO THE EYES, DO NOT ATTEMPT TO DISASSEMBLE THE CABINET. REFER SERVICING TO QUALIFIED PERSONNEL ONLY.

Note to CATV system installer:

This reminder is provided to call the CATV system installer's attention to Article 820-40 of the National Electrical Code that provides guidelines for proper grounding and, in particular, specifies that the cable ground shall be connected to the grounding system of the building, as close to the point of cable entry as practical.

NOTE

This equipment has been tested and found to comply with the limits for a Class B digital device, pursuant to Part 15 of the FCC Rules. These limits are designed to provide reasonable protection against harmful interference in a residential installation. This equipment generates, uses, and can radiate radio frequency energy and, if not installed and used in accordance with the instructions, may cause harmful interference to radio communications. However, there is no guarantee that interference will not occur in a particular installation. If this equipment does cause harmful interference to radio or television reception, which can be determined by turning the equipment off and on, the user is encouraged to try to correct the interference by one or more of the following measures:

IMPORTANT SAFETY INSTRUCTIONS

- 1 Read Instructions** - All the safety and operating instructions should be read before the product is operated.
- 2 Retain Instructions** - The safety and operating instructions should be retained for future reference.
- 3 Heed Warnings** - All warnings on the product and in the operating instructions should be adhered to.
- 4 Follow Instructions** - All operating and use instructions should be followed.
- 5 Cleaning** - Unplug this product from the wall outlet before cleaning. Do not use liquid cleaners or aerosol cleaners. Use a damp cloth for cleaning.
- 6 Attachments** - Do not use attachments not recommended by the product manufacturer as they may cause hazards.
- 7 Water and Moisture** - Do not use this product near water - for example, near a bath tub, wash bowl, kitchen sink, or laundry tub; in a wet basement; or near a swimming pool; and the like.
- 8 Accessories** - Do not place this product on an unstable cart, stand, tripod, bracket, or table. The product may fall, causing serious injury to a child or adult, and serious damage to the product. Use only with a cart, stand, tripod, bracket, or table recommended by the manufacturer, or sold with the product. Any mounting of the product should follow the manufacturer's instructions, and should use a mounting accessory recommended by the manufacturer.
- 9** A product and cart combination should be moved with care. Quick stops, excessive force, and uneven surfaces may cause the product and cart combination to overturn. 
- 10 Ventilation** - Slots and openings in the cabinet are provided for ventilation and to ensure reliable operation of the product and to protect it from overheating, and these openings must not be blocked or covered. The openings should never be blocked by placing the product on a bed, sofa, rug, or other similar surface. This product should not be placed in a built-in installation such as a bookcase or rack unless proper ventilation is provided or the manufacturer's instructions have been adhered to.
- 11 Power Sources** - This product should be operated only from the type of power source indicated on the marking label. If you are not sure of the type of power supply to your home, consult your product dealer or local power company. For products intended to operate from battery power, or other sources, refer to the operating instructions.
- 12 Grounding or Polarization** - This product may be equipped with a polarized alternating-current line plug (a plug having one blade wider than the other). This plug will fit into the power outlet only one way. This is a safety feature. If you are unable to insert the plug fully into the outlet, try reversing the plug. If the plug should still fail to fit, contact your electrician to replace your obsolete outlet. Do not defeat the safety purpose of the polarized plug.
Alternate Warnings - This product is equipped with a three-wire grounding-type plug, a plug having a third (grounding) pin. This plug will only fit into a grounding-type power outlet. This is a safety feature. If you are unable to insert the plug into the outlet, contact your electrician to replace your obsolete outlet. Do not defeat the safety purpose of the grounding-type plug.
- 13 Power-Cord Protection** - Power-supply cords should be routed so that they are not likely to be walked on or pinched by items placed upon or against them, paying particular attention to cords at plugs, convenience receptacles, and the point where they exit from the product.
- 14 Protective Attachment Plug** - The product is equipped with an attachment plug having overload protection. This is a safety feature. See Instruction Manual for replacement or resetting of protective device. If replacement of the plug is required, be sure the service technician has used a replacement plug specified by the manufacturer that has the same overload protection as the original plug.

IMPORTANT SAFETY INSTRUCTIONS (continued)

15 Outdoor Antenna Grounding - If an outside antenna or cable system is connected to the product, be sure the antenna or cable system is grounded so as to provide some protection against voltage surges and built-up static charges. Article 810 of the National Electrical Code, ANSI/NFPA 70, provides information with regard to proper grounding of the mast and supporting structure, grounding of the lead-in wire to an antenna discharge unit, size of grounding conductors, location of antenna discharge unit, connection to grounding electrodes, and requirements for the grounding electrode.

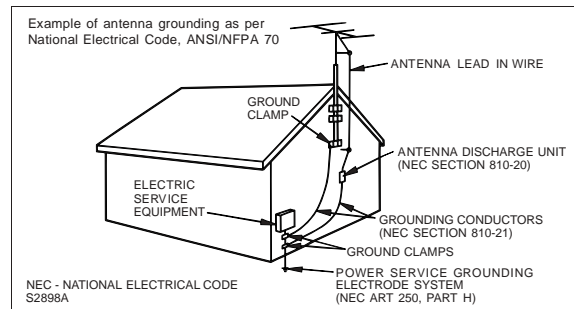

16 Lightning - For added protection for this product during a lightning storm, or when it is left unattended and unused for long periods of time, unplug it from the wall outlet and disconnect the antenna or cable system. This will prevent damage to the product due to lightning and power-line surges.

17 Power Lines - An outside antenna system should not be located in the vicinity of overhead power lines or other electric light or power circuits, or where it can fall into such power lines or circuits. When installing an outside antenna system, extreme care should be taken to keep from touching such power lines or circuits as contact with them might be fatal.

18 Overloading - Do not overload wall outlets, extension cords, or integral convenience receptacles as this can result in a risk of fire or electric shock.

19 Object and Liquid Entry - Never push objects of any kind into this product through openings as they may touch dangerous voltage points or short-out parts that could result in a fire or electric shock. Never spill liquid of any kind on the product.

20 Servicing - Do not attempt to service this product yourself as opening or removing covers may expose you to dangerous voltage or other hazards. Refer all servicing to qualified service personnel.

21 Damage Requiring Service - Unplug this product from the wall outlet and refer servicing to qualified service personnel under the following conditions:

- a) When the power-supply cord or plug is damaged,
- b) If liquid has been spilled, or objects have fallen into the product,
- c) If the product has been exposed to rain or water,
- d) If the product does not operate normally by following the operating instructions. Adjust only those controls that are covered by the operating instructions as an improper adjustment of other controls may result in damage and will often require extensive work by a qualified technician to restore the product to its normal operation,
- e) If the product has been dropped or damaged in any way, and
- f) When the product exhibits a distinct change in performance - this indicates a need for service.

22 Replacement Parts - When replacement parts are required, be sure the service technician has used replacement parts specified by the manufacturer or have the same characteristics as the original part. Unauthorized substitutions may result in fire, electric shock, or other hazards.

23 Safety Check - Upon completion of any service or repairs to this product, ask the service technician to perform safety checks to determine that the product is in proper operating condition.

24 Wall or Ceiling Mounting - The product should be mounted to a wall or ceiling only as recommended by the manufacturer.

25 Heat - The product should be situated away from heat sources such as radiators, heat registers, stoves, or other products (including amplifiers) that produce heat.

"DTS" and "DTS Digital Surround" are registered trademarks of Digital Theater Systems, Inc.

Manufactured under license from Dolby Laboratories. "Dolby", "Pro Logic" and the double-D symbol are trademarks of Dolby Laboratories.

NOTES

- Licensed under one or more of U.S. Pat. 4,972,484, 5,214,678, 5,323,396, 5,530,655, 5,539,829, 5,544,247, 5,606,618, 5,610,985, 5,740,317, 5,777,992, 5,878,080 or 5,960,037.
- Supply of this product does not convey a license nor imply any right to distribute content created with this product in revenue-generating broadcast systems (terrestrial, satellite, cable and/or other distribution channels), revenue-generating streaming applications (via Internet, intranets and/or other networks), other revenue-generating content distribution systems (pay-audio or audio-on-demand applications and the like) or on revenue-generating physical media (compact discs, digital versatile discs, semiconductor chips, hard drives, memory cards and the like). An independent license for such use is required. For details, please visit <http://mp3licensing.com>.

MPEG Layer-3 audio coding technology licensed from Fraunhofer IIS and Thomson.

ENERGY STAR® Program Information



Products that have earned the ENERGY STAR® are designed to protect the environment through superior energy efficiency.

ENERGY STAR

ENERGY STAR® is a U.S. registered mark.

Copyright Information:

- Unauthorized copying, broadcast, public display, transmission, public performance and rental (regardless of whether or not such activities are for profit) of disc contents are prohibited by law.
- This system is equipped with copy protection technology that causes substantial degradation of images when the contents of a disc are copied to a video tape.

Copy Protection:

This unit supports Macrovision copy protection.

On DVD discs that include a copy protection code, if the contents of the DVD disc are copied using a VCR, the copy protection code prevents the videotape copy from playing normally.

Apparatus Claims of U.S. Patent Nos. 4,631,603, 4,577,216, 4,819,098 and 4,907,093 licensed for limited viewing uses only.







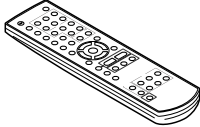
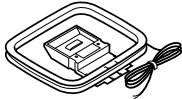
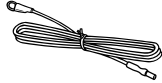

This product incorporates copyright protection technology that is protected by method claims of certain U.S. patents and other intellectual property rights owned by Macrovision Corporation and other rights owners. Use of this copyright protection technology must be authorized by Macrovision Corporation, and is intended for home and other limited viewing uses only unless otherwise authorized by Macrovision Corporation. Reverse engineering or disassembly is prohibited.

NOTICE FOR PROGRESSIVE SCAN OUTPUTS:

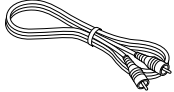
CONSUMERS SHOULD NOTE THAT NOT ALL HIGH DEFINITION TELEVISION SETS ARE FULLY COMPATIBLE WITH THIS PRODUCT AND MAY CAUSE ARTIFACTS TO BE DISPLAYED IN THE PICTURE. IN CASE OF 525 OR 625 PROGRESSIVE SCAN PICTURE PROBLEMS, IT IS RECOMMENDED THAT THE USER SWITCH THE CONNECTION TO THE 'STANDARD DEFINITION' OUTPUT. IF THERE ARE QUESTIONS REGARDING OUR TV SET COMPATIBILITY WITH THIS MODEL 525p AND 625p DVD PLAYER, PLEASE CONTACT OUR CUSTOMER SERVICE CENTER.

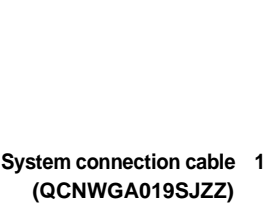
Accessories

Please confirm that the following accessories are included.

 <p>Remote control × 1 (RRMCGA027SJZZ)</p>	 <p>AM loop antenna × 1 (QANTL0008SJZZ)</p>	 <p>FM antenna × 1 (QANTWA001SJZZ)</p>	 <p>White (for left front speaker) approx. 16 feet (5 m)</p>	 <p>Red (for right front speaker) approx. 16 feet (5 m)</p>
 <p>Video cable 1 (QCNWGA004SJZZ)</p>	 <p>AC power cord 1 (QACCU0003SJ00)</p>	 <p>System connection cable 1 (QCNWGA019SJZZ)</p>	 <p>Blue (for left surround speaker) approx. 49 feet (15 m)</p>	 <p>Gray (for right surround speaker) approx. 49 feet (15 m)</p>
<p>Pattern paper for main unit 1 (TCAUZA010SJZZ)</p>	<p>Button name label 1 (HDECPA003SJZZ)</p>		 <p>Green (for center speaker) approx. 16 feet (5 m)</p> <p>Speaker connection cord 5 (QCNWGA008SJZZ)</p>	

Caution:

Do not use the supplied AC power cord for other equipment. Fire or electric shock may result.

Note:

Only the above accessories are included.

Contents

HT-X1

	Page		Page
■ General Information		■ Audio CD Operation	
Precautions	8	Playing an audio CD	
Description of discs	9 - 11	To play in random order (random play)	42
Controls and indicators	12 - 16	To start playback from the desired point (direct play)	43
■ Preparation for Use		■ MP3, WMA and JPEG Disc Operation	
System installation	17	Playing an MP3, WMA or JPEG disc	44, 45
Main unit preparation	18	■ Radio	
System connections	19 - 25	Listening to the radio	46, 47
Remote control	26	■ Advanced Features	
General control	27	Enjoying surround sound (sound mode)	48 - 51
■ DVD Operation		Changing the default setting of the amplifier	52 - 54
Playing a disc	28 - 30	Changing the initial setting of DVD	55 - 58
Basic operation		Language code list for disc language	59
To locate the beginning of a chapter/track (skip)	31	Sleep operation	60
Fast forward/Fast reverse (search)	31	Audio connection to other equipment	61
To start playback from the desired point (direct play)	32	To install the main unit on the wall	62
Useful operation		■ References	
To change the subtitle language	33	Troubleshooting chart	63, 64
To change the audio language (audio output)	34	Maintenance	65
To brighten an image	34	Error indicators and warnings	65
To improve the image quality	35	Optional accessory	65
To select a title from the top menu of the disc	36	Specifications	66, 67
To select a subtitle or audio language from the disc menu	36	CONSUMER LIMITED WARRANTY	Back cover
Still picture/Frame advance	36		
Slow-motion play	36		
To change the angle	37		
To zoom in on an image (zoom)	37		
To play in the desired order (programmed playback)	38		
To play repeatedly (repeat play)	39		
To play the contents between the specified points repeatedly (A-B repeat)	40		
To change the display on the main unit	40		
To change the display on TV screen	41		

Precautions

■ General

- Please ensure that the equipment is positioned in a well-ventilated area and that there is at least 4" (10 cm) of free space along the sides and back. There must also be a minimum of 6" (15 cm) of free space on the top of the unit.

Main unit

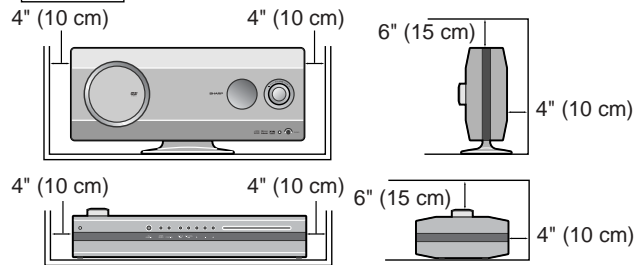

Subwoofer/amplifier unit

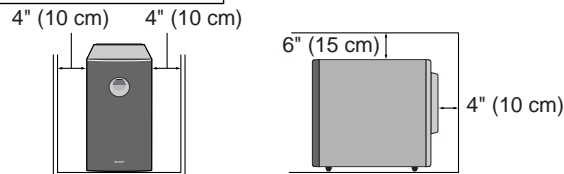

- Use the system on a firm, level surface free from vibration.

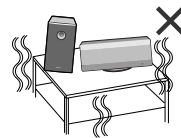

- Keep the system away from direct sunlight, strong magnetic fields, excessive dust, humidity and electronic/electrical equipment (home computers, facsimiles, etc.) which generates electrical noise.

- Do not place anything on top of the components.
- Do not expose the system to moisture, to temperatures higher than 140°F (60°C) or to extremely low temperatures.
- If your system does not work properly, disconnect the AC power cord from the AC outlet. Plug the AC power cord back in, and then turn on your system.

- This system should only be used within the range of 41°F - 95°F (5°C - 35°C).

Warning:

The voltage used must be the same as that specified by this system. Using this product with a higher voltage other than that specified is dangerous and may result in a fire or other types of accident, causing damage. SHARP will not be held responsible for any damage resulting from the use of this system with a voltage other than that specified.

■ Volume control

The sound level at a given volume setting depends on speaker efficiency, location and various other factors. It is advisable to avoid exposure to high volume levels, which occurs while turning the unit on with the volume control setting up high, or while continually listening at high volumes.

Description of discs

HT-X1

■ Types of playable discs

The unit can play back discs bearing any of the following marks:

DVD

DVD-Video Disc for NTSC system	DVD-R for NTSC system	DVD-RW for NTSC system	DVD+R for NTSC system	DVD+RW for NTSC system
-----------------------------------	-----------------------------	------------------------------	-----------------------------	------------------------------

Recorded in the vid-

Some DVD may not function as described in the manual. See the disc jacket for restrictions.

- For unplayable discs, see page 11.

Description of discs (continued)

■ DVD-Video

A popular type of DVD disc of the same size as a CD, mainly containing video images.

Region number

DVD discs are programmed with region numbers indicating countries in which they can be played. This system can play discs with region number "1" or "ALL".

Region number
(playable area number)



Title and chapter

DVD-Video discs are divided into "titles" and "chapters". If the disc has more than one movie on it, each movie is a separate "title". "Chapters" are subdivisions of titles.

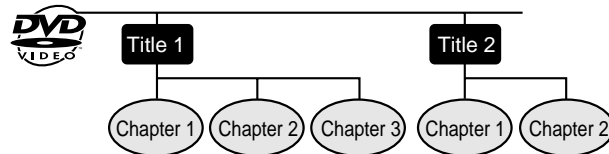

■ DVD-R/DVD-RW/DVD+R/DVD+RW

- You can play DVD-R/DVD-RW/DVD+R/DVD+RW discs recorded in the video mode.
- **Before playing DVD-R/DVD-RW/DVD+R/DVD+RW discs with this unit, finalize them with the equipment used for recording.**

■ Audio CD

Track

The audio CD is composed of "tracks". Tracks are equivalent to songs on a CD.



■ MP3/WMA/JPEG format on CD-R/CD-RW

An MP3 file is audio data compressed in the MPEG 1 audio layer 3 format. MP3 files have the extension ".mp3". (Files with the extension ".mp3" may not play, or noise may occur during playback if not recorded in the MP3 format.)

WMA is an audio file format developed by Microsoft with the ".wma" extension. This type of audio file is recorded through Microsoft Windows operating system.

A JPEG file is still image data compressed in the JPEG (Joint Photographic Experts Group) format. JPEG files have the extension ".jpg".



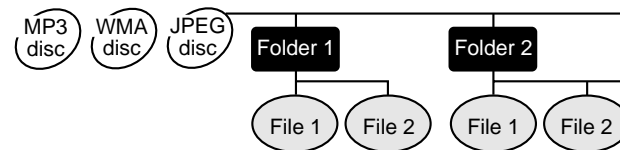

Folder and file

MP3/WMA/JPEG discs consist of "folders" and "files".



■ Icons used on DVD discs

Check the icons of the DVD jacket before playing your discs.

Display	Description
Format recorded on the DVD 	Select a type according to the connected TV type.
Type of subtitles recorded Example:  <ol style="list-style-type: none"> 1. English 2. German 	Recorded subtitle languages. You can select a subtitle language.
Number of camera angles 	Number of angles recorded on the DVD. You can view scenes from different angles.
Number of audio tracks and audio recording systems  Example: <ol style="list-style-type: none"> 1: Original <English> (Dolby Digital 5.1 Surround) 2. German (Dolby Digital 2 ch) 	The number of audio tracks and audio recording systems are indicated. <ul style="list-style-type: none"> ● You can change the audio language. ● Audio and recording system vary depending on the DVD. Check them in the DVD's manual.

■ Discs that cannot be played

- DVDs without the region number "1" or "ALL".
- DVDs with PAL system
- DVDs with SECAM system
- DVDs with MPEG sound
- DVD-ROM
- DVD-RAM
- DVD-Audio
- CDG
- Super video CD/Video CD
- Photo CD
- CD-ROM
- SACD
- Discs recorded in special formats, etc.

Notes:

- The discs above cannot be played at all, or no sound is heard although images appear on the screen or vice versa.
- Faulty playback may damage the speakers and can have an adverse effect on your hearing when played at high volume settings.
- **This DVD player adopts the NTSC system. Discs that were made in foreign countries may not be played back. Check the recording system before purchasing discs.**
- You cannot play illegally produced discs.
- A disc with scratches or fingerprints may not play properly. Refer to "Care of discs" (page 65) and clean the disc.

Controls and indicators

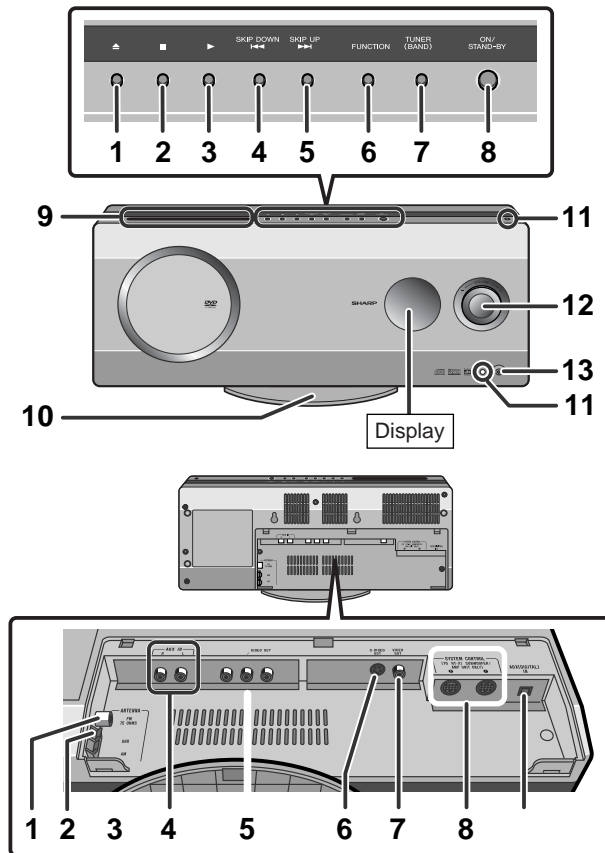

■ Top and front panel

	Reference page
1. Disc Eject Button	29
2. Stop Button	28, 29
3. Play Button	29
4. Chapter (Track) Skip Down or Fast Reverse Button	31
5. Chapter (Track) Skip Up or Fast Forward Button	31
6. Function Selector Button	49
7. Tuner (Band) Button	46
8. On/Stand-by Button	25
9. Disc Compartment	28
10. Main Unit Stand	18
11. Remote Sensor	26
12. Volume Control	27
13. Headphone Jack	24

■ Rear panel

	Reference page
1. FM 75 Ohm Antenna Jack	19, 20
2. Antenna Ground Terminal	19, 20
3. AM Antenna Terminal	19, 20
4. Auxiliary (Audio Signal) Input Jacks	61
5. Component Video Output Jacks	23
6. S-video Output Jack	23
7. Video Output Jack	22
8. System Connection Jacks (to subwoofer/amplifier unit)	19, 20
9. Optical Digital Audio Input Jack	61

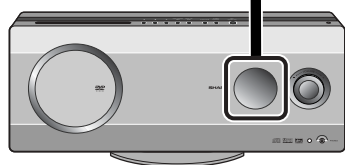
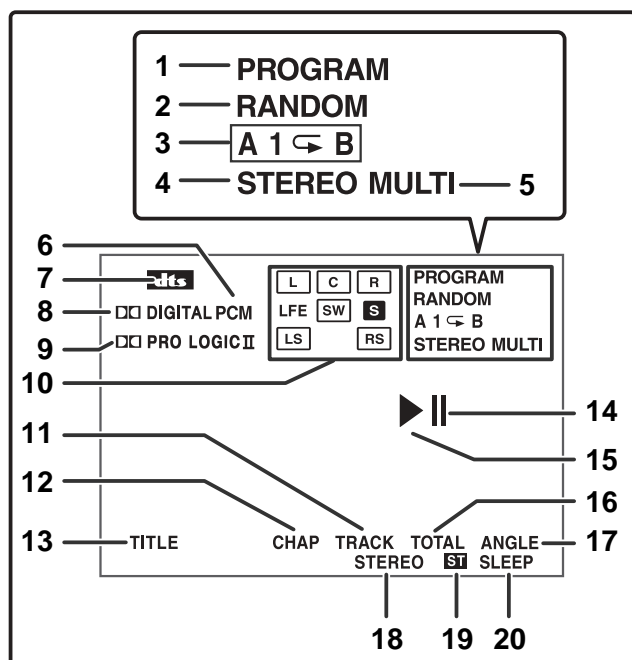

■ Display

	Reference page
1. Program Indicator	38, 47
2. Random Play Indicator	42
3. Repeat/One Track Repeat/A - B Repeat Indicators ...	39, 40
4. 2 channel Stereo Sound Mode Indicator	50
5. Multi Channel Sound Mode Indicator	51
6. PCM Signal Indicator	48
7. DTS Signal Indicator	48
8. Dolby Digital Signal Indicator	48
9. Dolby Pro Logic II Indicator	48
10. Audio Signal/Speaker Indicators	49
11. Track Indicator	40
12. Chapter Indicator	40
13. Title Indicator	40
14. Pause Indicator	29
15. Play Indicator	29
16. Total Indicator	40
17. Angle Indicator	37
18. FM Stereo Mode Indicator	46
19. FM Stereo Receiving Indicator	46
20. Sleep Indicator	60

Controls and indicators (continued)

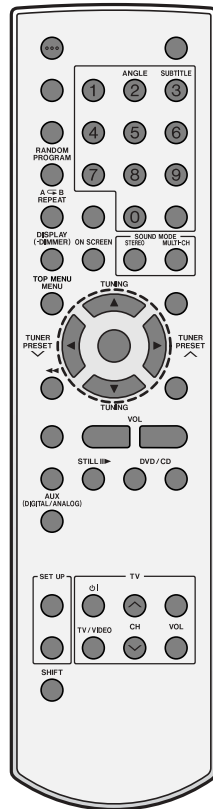

■ Remote control

	Reference page
1. Remote Control Transmitter	26
2. Direct Number Buttons	32
3. On/Stand-by Button	26
4. Sleep Button	60
5. Clear Button	38
6. Random or Program Button	38, 42
7. A - B Repeat or Repeat Button	39, 40
8. Unit Display Select or Dimmer Button	27, 40
9. On Screen Display On/Off Button	41
10. Top Menu or Menu Button	36
11. Chapter (Track) Skip Down or Fast Reverse Button	31
12. Disc Eject Button	29
13. Multi Channel Select Button	51
14. Return Button	52, 55
15. Stereo (2 channel) Select Button	50
16. Chapter (Track) Skip Up or Fast Forward Button	31
17. Angle Button	37
18. DVD Audio Language Select or CD Audio Output Select Button	34
19. Gamma Button	34
20. Direct Button	32
21. Subtitle Button	33
22. Super Picture Button	35
23. Zoom Button	37
24. Progressive Scan Mode Select Button	22
25. Tuner Preset Down or Cursor Button	37, 47
26. Tuning Up or Cursor Button	37, 46
27. Tuner Preset Up or Cursor Button	37, 47
28. Tuning Down or Cursor Button	37, 46
29. Enter Button	32

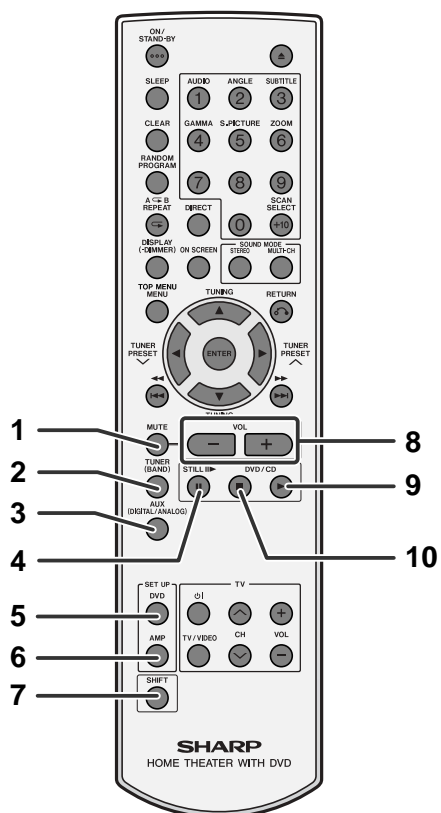

Remote control

	Reference page
1. Mute Button	27
2. Tuner (Band) Button	46
3. Auxiliary Button	61
4. Frame Advance or Pause Button	29, 36
5. DVD Initial Setting Button	55
6. Amplifier Initial Setting Button	50
7. Shift Button	33
8. Volume Up and Down Buttons	27
9. Play Button	29
10. Stop Button	28, 29

TV Operation Buttons

You can operate some functions of SHARP's TVs with the remote control of this system.

However, some models cannot be operated.

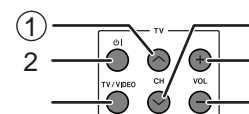

TV Channel Up Button

Switches the TV channel up.

TV Channel Down Button

Switches the TV channel down.

TV On/Stand-by Button

Sets the TV power to "ON" or "STAND-BY".

TV Volume Up Button

Turns up the TV volume.

TV/VCR Input Select Button

Switches the input to TV or VCR.

TV Volume Down Button

Turns down the TV volume.

Controls and indicators (continued)

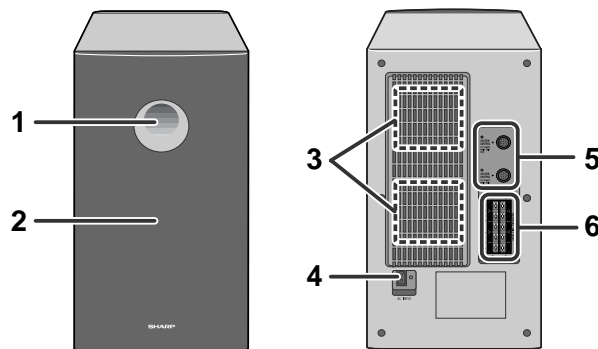
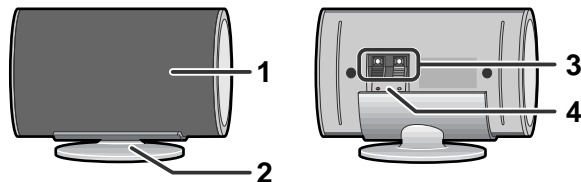
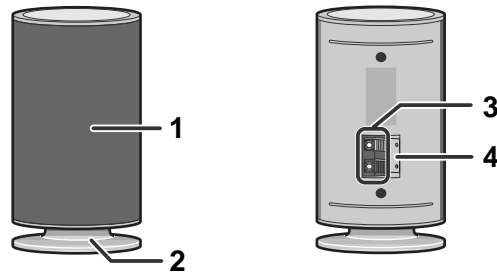

■ Front/surround speakers

Reference page

- 1. Speaker
- 2. Speaker Stand 21
- 3. Speaker Terminals 19, 21
- 4. Color Label
 - ① White ... Left Front Speaker
 - ② Red ... Right Front Speaker
 - ③ Blue ... Left Surround Speaker
 - ④ Gray ... Right Surround Speaker

■ Center speaker

Reference page

- 1. Speaker
- 2. Speaker Stand 19, 21
- 3. Speaker Terminals 19, 21
- 4. Color Label: Green

■ Subwoofer/amplifier unit

Reference page

- 1. Bass Reflex Duct
- 2. Woofer
- 3. Cooling Fan 25
- 4. AC Power Input Jack 25
- 5. System Connection Jacks (to main unit) 19, 20
- 6. Speaker Terminals 19, 21

System installation

HT-X1

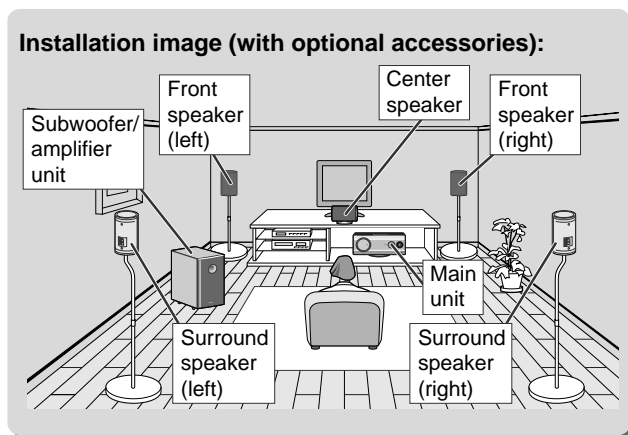

■ Magnetically shielded speakers

The front and center speakers may be placed beside or near the TV as they are magnetically shielded. However, color variation may occur, depending on the type of the TV.

If color variation occurs...

Turn off the TV (from the power switch).
After 15 - 30 minutes, turn the TV on again.

If the color variation is still present...

Move the speakers further away from the TV.
Refer to the user's manual of the TV for details.

Note:

The surround speakers and subwoofer/amplifier unit are not magnetically shielded.

■ Placing the speaker system

The best surround effect will be achieved by placing each speaker at the same distance from the listening position. It is recommended to arrange the speakers as shown below.

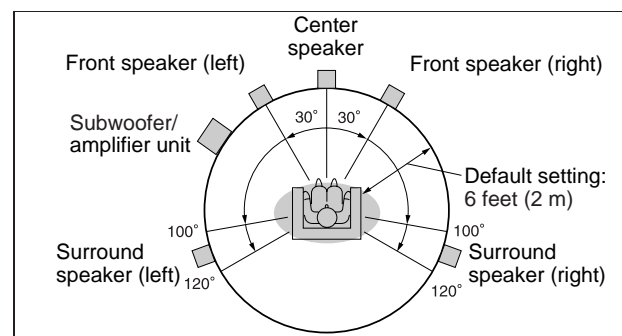

Notes:

- The default distance is set to 6 feet (2 m). If speakers cannot be placed at equal distances, refer to "Speaker delay setting" (see page 53).
- Place the TV halfway between the front speakers.
- It is recommended that the center speaker be placed near the television.
- Place the surround speakers at a position just above the height of your ears.
- Place the subwoofer/amplifier unit on a sturdy and stable surface as it tends to vibrate while reproducing bass sounds.

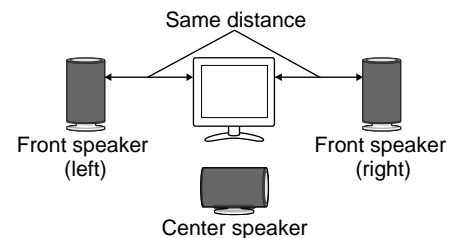

HT-X1

Main unit preparation

Preparation for Use



System conn

Make sure to disconnect the power cord from the back cover of the monitor before you connect/disconnect cables to the monitor unit.
After connecting cables to the monitor unit.

Make sure to disconnect the power cord from the back cover of the monitor before you connect/disconnect cables to the monitor unit.
After connecting cables to the monitor unit.

17-18



...
better

Installing the

Outdoor FM or AM antenna:

Use an outdoor FM or AM antenna if you require better reception. Consult your dealer. When using an outdoor AM antenna, be sure to keep the wire of the antenna connected.

■ Speaker connection

Make sure to leave the AC power cord disconnected when connecting the speakers.

To prevent accidental short-circuits between \oplus and \ominus terminals, connect the speaker wires to the speakers first and then to the subwoofer/amplifier unit.

When connecting speakers, match the colors of the back label on the speaker, to the tube for the speaker wire, and speaker terminal of the subwoofer/amplifier unit.

1 Connect the wires to the speakers.

Example: To connect the left front speaker.

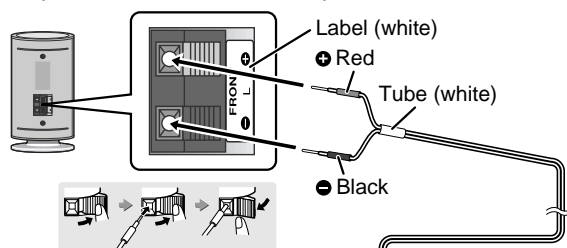

2 Connect the other end to the subwoofer/amplifier unit.

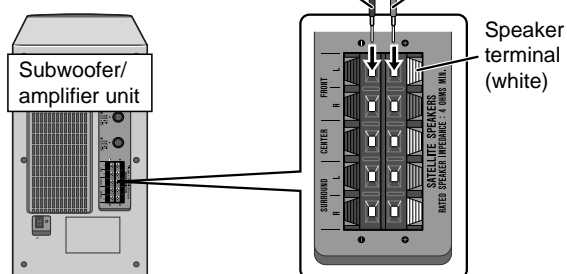

Caution:

- The supplied speakers are exclusively for the HT-X1. Do not connect them to other equipment, and do not connect other speakers to the HT-X1. It may cause malfunction.
- Do not mistake the \oplus and \ominus , and right and left terminals of the speaker wires. (The right speaker is placed on the right when you face the subwoofer/amplifier unit.)
- Do not stand or sit on the speakers. You may be injured.
- Do not allow any objects to fall into or to be placed in the bass reflex ducts of the subwoofer/amplifier unit.

■ Attaching the optional floor speaker stand

The front speakers and surround speakers support the optional floor speaker stand (see page 65). Remove the original stand for each speaker using a screwdriver first. For details, refer to the manual for the floor speaker stand.

Note:

Keep the removed speaker stands or screw in a safe place.

System connections (continued)

■ TV connection

Three types of jacks (VIDEO OUT, S-VIDEO OUT and COMPONENT VIDEO OUT) are available for connection of a TV and the main unit. Connect according to your TV.

Connecting to a TV with a video input jack:

You can enjoy DVD images by connecting your TV and the main unit with the supplied video cable.

Set the video mode to "Interlace" (default setting). For the procedure, refer to "Changing the video output mode".

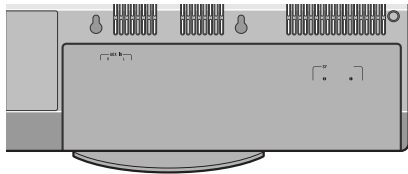

What is progressive scanning?

The conventional TV system displays 30 frames of still images per second to complete sequential movement (interlaced scanning). Whereas, progressive scanning displays one frame every 1/60th of a second (60 frames per second) to realize less-flicker, high-density images.

Notes:

- Change the TV input in accordance with the connected jack.
- Do not connect other equipment (VCR, etc.) between the TV and the main unit. Images may be distorted.
- Refer to the operation manual of the equipment to be connected.
- Insert the plugs fully to avoid fuzzy pictures or noise.

Connecting to a TV with an S-video input jack:

If your TV is equipped with an S-video input jack, you can enjoy higher quality images by connecting it with an S-video cable (not supplied).

Set the video mode to "Interlace" (default setting). For the procedure, refer to "Changing the video output mode" on page 22.

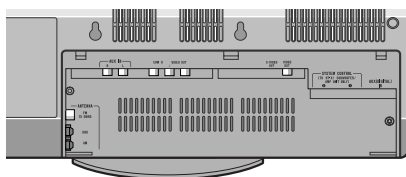
**Connecting to a TV with component video input jacks:**

If your TV is equipped with component video input jacks, purchase a component video cable to enjoy higher quality images.

Note:

When the video and S-video cables are both connected, the images from the S-video input jack appears on your TV.

Notes:

- If your TV has different indications for the component video inputs (Y, CB and CR or Y, B-Y and P-Y), connect jacks with its matching color.
- Some component video jacks designed for the high-vision system are not compatible with DVD. Do not connect this unit to those component video input jacks. (Images may appear distorted or may not appear due to the system difference.)

System connections (continued)

■ Attaching the back cover

After making all the connections, attach the back cover to the main unit. Fit the claws into the holes.

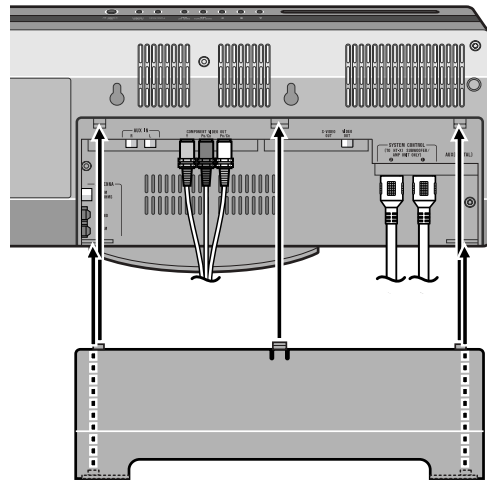

■ Headphones

- Before plugging in or unplugging the headphones, reduce the volume.
- Be sure your headphones have a 1/8" (3.5 mm) diameter plug and impedance between 16 and 50 ohms. The recommended impedance is 32 ohms.
- Plugging in the headphones disconnects the speakers automatically. Adjust the volume using the VOLUME control.

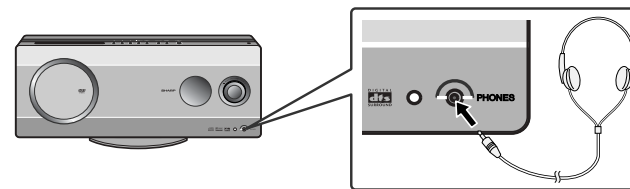

■ Connecting the AC power cord

After checking all the connections have been made correctly, plug the AC power cord to the AC power input jack of the subwoofer/amplifier unit, and then to the AC outlet.

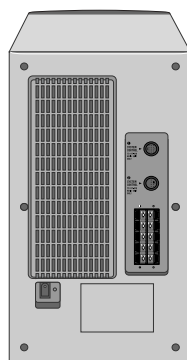

Notes:

- Never use a power cord other than the one supplied. Otherwise, a malfunction or an accident may occur.
- Unplug the AC power cord from the wall outlet if the subwoofer/amplifier unit will not be in use for a prolonged period of time.

Cooling fan:

A cooling fan is built into this subwoofer/amplifier unit for better heat radiation. Do not cover the opening in this section with any obstacles to avoid damage to the subwoofer/amplifier unit.

■ To turn the power on

Press the ON/STAND-BY button.

If the power does not turn on, check if the AC power cord and system connection cable are plugged in properly.

To set the system to stand-by mode:

Press the ON/STAND-BY button again.

Note:

After the system enters the power stand-by mode, wait a few seconds to turn on again.

Remote control

■ Battery installation

Use 2 "AAA" size batteries (UM-4, R03, HP-16 or similar).
Batteries are not included.

- 1 **Remove the battery cover.**
- 2 **Insert the batteries according to the direction indicated in the battery compartment.**
When inserting or removing the batteries, push them toward the ⊖ battery terminals.
- 3 **Replace the cover.**

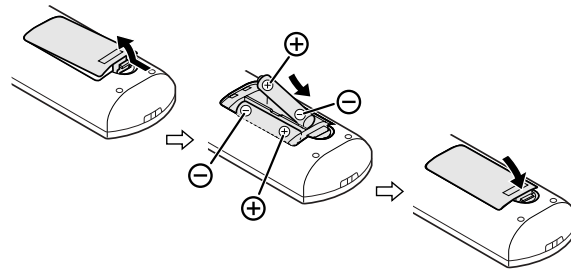

Precautions for battery use:

- Replace all old batteries with new ones at the same time.
- Do not mix old and new batteries.
- Remove the batteries if the system will not be used for long periods of time. This will prevent potential damage due to battery leakage.

Caution:

- Do not use rechargeable batteries (nickel-cadmium battery, etc.).
- Installing the batteries incorrectly may cause the system to malfunction.

Battery removal:

Remove the battery cover. Push each battery toward the ⊖ battery terminal and take them out.

Notes concerning use:

- Replace the batteries if the operating distance is reduced or if the operation becomes erratic.
- Periodically clean the transmitter on the remote control and the sensor on the main unit with a soft cloth.
- Exposing the sensor on the main unit to strong light may interfere with operation. Change the lighting or the direction of the main unit if this occurs.
- Keep the remote control away from moisture, heat, shock, and vibrations.

■ Test of the remote control

Check the remote control after checking all the connections (see pages 19 - 25).
Point the remote control directly at the remote sensor on the main unit.

The remote control can be used within the range shown below:
Press the ON/STAND-BY button. Does the power turn on? Now, you can enjoy music.

- The main unit is equipped with 2 remote sensors. Use them according to the installation method as shown below.

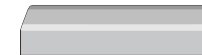

General control

HT-X1

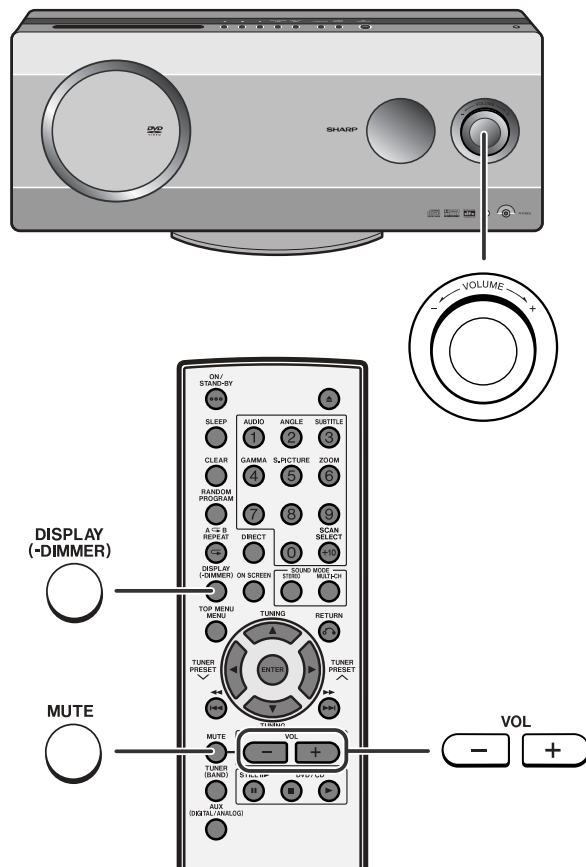

■ Volume control

Main unit operation:

When the VOLUME control is turned clockwise, the volume will increase. When it is turned counterclockwise, the volume will decrease.

Remote control operation:

Press the VOL (+ or -) button to increase or decrease the volume.

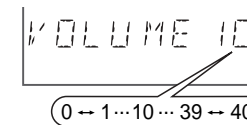

■ Muting

The volume is muted temporarily when pressing the MUTE button.

- Press again to restore the volume.
- The mute status is canceled when you adjust the volume.

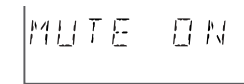

■ To change the display brightness (2 levels)

Hold the DISPLAY/(-DIMMER) button down for 3 seconds or more. Each time you press, brightness changes.

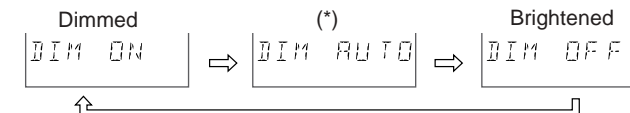

- (*) After approx. 5 seconds of DVD playback, the display dims and the original brightness returns when you stop playback. The brightness remains unchanged during playback of other media.

Playing a disc

Turn on the TV, and switch the input to the "VIDEO 1" or "VIDEO 2", etc. accordingly.

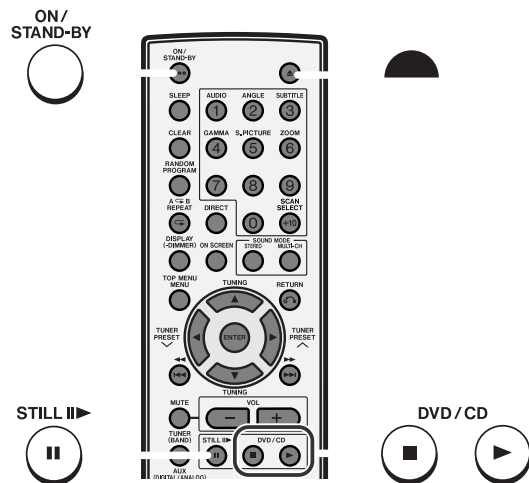

4 If playback does not start, press the ► (DVD/CD ►) button.

The sound mode in use appears during DVD playback.

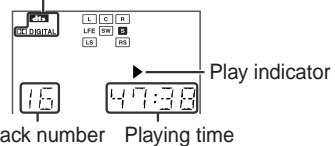

When the menu appears on the TV screen:

On DVD, select an item by using the cursor (▲, ▼, ◀ or ▶) button and press the ENTER button.

To interrupt playback:

Press the STILL  button on the remote control. To resume playback from the same point, press the DVD/CD ► button.



To stop playback:

DVD:
Press the  button twice.

CD/MP3/WMA/JPEG:

Press the  button.

Caution when inserting disc:

- Do not touch the playback side.



- Do not insert two or more discs in the disc insertion slot.
- Discs with labels, stickers or glue attached may cause damage to the main unit.



- Do not use discs of special shapes (heart, octagon, etc.) or 3" (8 cm) discs with an adaptor. Malfunction may result.



- A disc with scratches or fingerprints may not play properly. Refer to "Care of discs (page 65)" and clean the disc.
- Insert or remove the disc straight. Otherwise, damage may result.

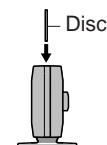

To remove the disc:

- In the stop mode, press the ▲ button.
- Remove the disc.

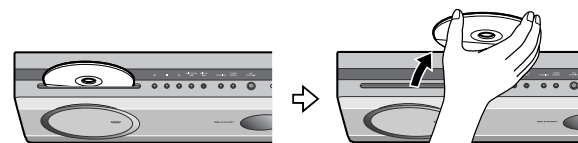

Playing a disc (continued)

Notes:





- When you turn on the power or switch the input to "DVD" initialization starts and operation is not possible for a few seconds.
- Stop positions may be recorded on some discs. When you play such a disc, playback stops there.
- During an operation, "⏏" may appear indicating that the operation is disabled by the disc.
- Some DVD may not function as described in the manual. See the disc jacket for restrictions.
- Some CD-R/CD-RW may not play properly due to the status of the disc or equipment used for recording. Change the recording speed or disc. For more details, see the manual for the equipment.
- Sound may skip at high volume depending on the disc. In this case, turn down the volume.

Caution:

- Be careful not to damage the disc when inserting or removing it.
 - A disc does not play if damaged, dirty or loaded upside down.
 - Make sure to remove the disc before transporting the main unit. Otherwise the disc inside may cause malfunction.
 - Do not let coins, clips, etc. get into the disc insertion slot. Malfunction may occur.
 - When attempting to play discs with scratches or of a different region number, or unplayable or restricted (*1) discs, an error message will appear on the TV display and the disc will not play.
- (*1) Viewing is prohibited on some DVDs according to the audience age.

■ To resume playback after stopping (resume play)

You can resume playback from the point playback is stopped.

1 While the disc is playing, press the  button.	 Pre-Stop
The system stores the point you stopped.	
2 To restart play, press the  (DVD/CD ) button.	 Play
Playback resumes from the point you left off.	

To cancel resume play:

Press the  button again.

 Stop

Notes:

- The resume play feature is disabled on some discs.
- Depending on the disc, playback may resume slightly before the position where it was stopped.

Basic operation

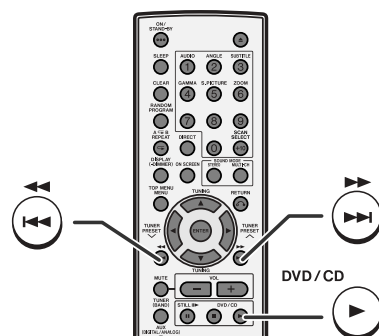

■ To locate the beginning of a chapter/track (skip) DVD CD MP3 WMA JPEG

You can skip the current chapter (track) to the next or previous.

While a disc is playing, press the ◀◀ or ▶▶ button.

Press the ▶▶ button to skip to the next chapter (track).

On DVD/Audio CD:

Press the ◀◀ button to skip to the beginning of the current chapter (track). Press the ◀◀ button again to skip to the beginning of the previous chapter (track).

On MP3/WMA/JPEG discs:

Press the ◀◀ button to skip to the beginning of the previous track (not the current one).

Notes:

- Some discs do not display the chapter (track) and the skip feature is disabled.
- On a DVD, you cannot skip across titles.

■ Fast forward/Fast reverse (search)

DVD CD MP3 WMA

You can search the desired point as you play the disc.

- 1 While a disc is playing, hold down the ◀◀ or ▶▶ button for 2 seconds or more.

▶▶ Fast Forward 2x

The scanning speed will change as follows at each press of the button.

The speed changes as follows on DVD/audio CD:



- The disc is forwarded by the ▶▶ button and reversed by the ◀◀ button.
- The speed cannot be changed on MP3 and WMA discs.

- 2 Press the ▶ (DVD/CD ▶) button to return to the normal playback.

Notes:

- On some discs, the search function is disabled.
- On DVD, search does not operate across titles.
- On MP3 and WMA, search does not operate across files.
- While searching on a DVD, the sound is not heard and the subtitles do not appear.
- Audio CD or MP3/WMA disc sounds will break up during search. This is not a malfunction.
- When a search is performed during playback, pictures may not be forwarded or reversed in the search speed specified in this manual, depending on the disc or the scene being played.

Basic operation (continued)

■ To start playback from the desired point (direct play)

To select and play the desired title:

Playback starts from chapter 1 of the selected title.

- 1 While in the stop or playback mode, press the DIRECT button.
 - 2 Within 10 seconds, select the title by pressing the cursor (◀ or ▶) button.
 - 3 Enter the desired title number by using the direct number buttons. Title number
- 
- 4 Within 10 seconds, press the ENTER button.

To select and play the desired chapter:

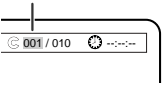
- 1 Perform steps 1 - 3 of "To select and play the desired title" above.
 - 2 Within 10 seconds, select the chapter by pressing the cursor (◀ or ▶) button.
 - 3 Enter the desired chapter number by using the direct number buttons. Chapter number
- 
- 4 Within 10 seconds, press the ENTER button.

Notes:

- Direct play feature is disabled on some discs.
- Some discs may not display the chapter number.

Entering title or chapter numbers using the direct number buttons:
If the number is 2 digits or more, press "+10" and enter the number.

Example:

To select chapter 1, press "1".

To select chapter 12, press "+10" and "2".

To select chapter 22, press "+10", "+10" and "2".

To select chapter 112, press "+10" eleven times and press "2".

To play by specifying time (time search):

- 1 While a disc is playing, press the DIRECT button.
- 2 Within 10 seconds, select the time by pressing the cursor (◀ or ▶) button. Time
- 3 Specify the time by using the direct number buttons.
 - To specify 1 hour 23 minutes and 40 seconds, enter "012340".
 - If you enter the wrong number, start over from step 1.
- 4 Within 10 seconds, press the ENTER button.

Notes:

- Some discs cannot play from the specified point.
- Time search feature is disabled on some discs.

Useful operation

The subtitle language and the audio language you select during playback are reset each time you set this system to the stand-by mode or change the disc. To keep your preferred languages, set them in the initial setting screen (see page 55).

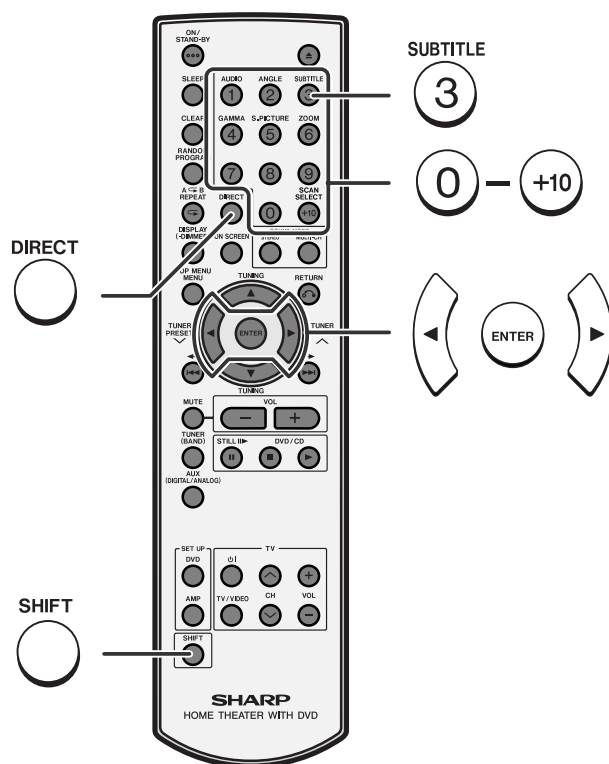

■ To change the subtitle language **DVD**

You can change the subtitle language or hide subtitles during playback.

- While a disc is playing, press the **SHIFT** button and then the **SUBTITLE** button.

Subtitle 01/09: English
- Repeat step 1 to select the desired subtitle language.

Subtitle 02/09: Spanish

English → French → ... → Spanish → Subtitle Off

- You can select one from the subtitle languages that are recorded on a DVD.
- To hide subtitles on the screen, select "Subtitle Off".

Notes:

- Some DVDs prohibit changing the subtitle language.
- If no subtitles are recorded on the disc, "0" is displayed.
- It may take a little time to switch the subtitle language to the selected one.
- When you set the unit to the stand-by mode or replace the disc, settings return to the default.

Useful operation (continued)

■ To change the audio language (audio output)

DVD CD MP3

During playback, you can change the audio language (audio output).

- 1** While a disc is playing, press the **SHIFT** button and then the **AUDIO** button.

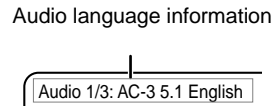

- 2** Repeat step 1 to select the desired audio number.

When playing DVD, the language changes as follows:

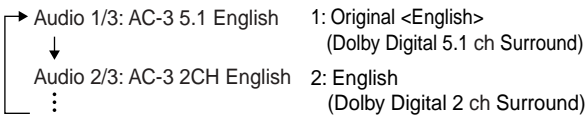

When playing audio CD and MP3, the sound changes as follows:



Notes:

- The audio language on some DVDs may not be changed.
- For audio language and audio system, refer to the manual of the disc.
- When you set the unit to the stand-by mode or replace the disc, settings return to the default.

■ To brighten an image DVD

- 1** During playback, press the **SHIFT** button and then the **GAMMA** button to select "ON".

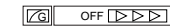

"ON" and "OFF" will be switched by each press of these buttons.

- 2** Within 10 seconds, press the cursor (**◀** or **▶**) button to set the level.

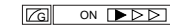

Level	Setting	Level	Setting
OFF ▶▶▶	Normal image	ON ▶▶▶	Brighter
ON ▶▶▶	Slightly brighter	ON ▶▶▶▶	A lot brighter

To restore the original brightness:

In step 1, select "OFF".

■ To improve the image quality

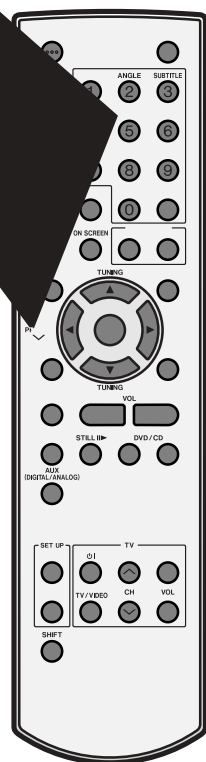

To restore the original image quality:
In step 1, select "OFF".

Useful operation (continued)

■ To select a title from the top menu of the disc DVD

On a DVD with multiple titles, you can select a title from the top menu.

<p>1 In the stop mode or during playback, press the SHIFT button and then the TOP MENU/MENU button.</p>	<p>Example</p> <table border="1" style="margin-left: auto; margin-right: auto;"> <tr> <td style="padding: 2px;">1 Drama</td> <td style="padding: 2px;">2 Action</td> </tr> <tr> <td style="padding: 2px;">3 SF</td> <td style="padding: 2px;">4 Comedy</td> </tr> </table>	1 Drama	2 Action	3 SF	4 Comedy
1 Drama	2 Action				
3 SF	4 Comedy				
<p>2 Press the cursor (▲, ▼, ◀ or ▶) button to change the setting and press the ENTER button.</p> <ul style="list-style-type: none"> ● The selected title is played. ● You can also use the direct number buttons for some discs. 					

Note:

The procedure shown here provides only general steps. The actual procedure for using the disc menu depends on the disc you are using. See the disc jacket for details.

■ To select a subtitle or audio language from the disc menu DVD

You can select the desired subtitle/audio language and sound system (5.1 ch Dolby Digital or DTS sound) on your DVD if it has a disc menu.

<p>1 In the stop mode or during playback, press the TOP MENU/MENU button.</p>	<p>Example</p> <table border="1" style="margin-left: auto; margin-right: auto;"> <tr> <td style="padding: 2px;">Menu</td> </tr> <tr> <td style="padding: 2px;">1. Highlights</td> </tr> <tr> <td style="padding: 2px;">2. Start Movie</td> </tr> </table>	Menu	1. Highlights	2. Start Movie
Menu				
1. Highlights				
2. Start Movie				
<p>2 Press the cursor (▲, ▼, ◀ or ▶) button to change the setting and press the ENTER button.</p> <p>You can also use the direct number buttons for some discs.</p>				

Note:

The procedure shown here provides only general steps. The actual procedure for using the disc menu depends on the disc you are using. See the disc jacket for details.

■ Still picture/Frame advance DVD

You can freeze the image and advance frame by frame.

<p>1 While a disc is playing, press the STILL ⏸ button.</p>	<p>⏸ Pause</p>
<p>2 Each press of the STILL ⏸ button advances the frame in the still mode.</p>	
<p>3 Press the ▶ (DVD/CD ▶) button to return to the normal playback.</p>	

Note:

Still picture and frame advance features are disabled on some discs.

■ Slow-motion play DVD

You can slow down the playback speed.



<p>1 While a disc is playing, press the STILL ⏸ button.</p>	<p>⏸ Pause</p>
<p>2 Hold down the ◀◀ or ▶▶ button for 2 seconds or more.</p>	<p>▶▶ Slow Forward</p> <p style="text-align: center;">◀◀ Slow Backward / ▶▶ Slow Forward</p>
<p>3 Press the ▶ (DVD/CD ▶) button to return to the normal playback.</p>	

Note:

On some discs, slow-motion play functions are disabled.

■ To change the angle DVD

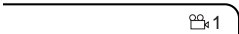
You can change the angle of view when playing a DVD video disc that contains scenes recorded from multiple angles.

1 When "ANGLE" appears on the TV during playback, press the SHIFT button and then the ANGLE button.	
TV screen	Unit display
	
2 Repeat step 1 to select the desired angle number.	

Notes:

- Some DVDs prohibit changing the angle.
- The angle number is not displayed if there is no other angle recorded. "●" is displayed instead.
- Refer to the manual of the disc as the operation may vary depending on the disc.

■ To zoom in on an image (zoom)

You can magnify images during playback.

To return to normal view:

Press the SHIFT button and then the ZOOM button. Repeat this to select "Zoom off".

When you cancel the zoom function, you cannot shift the view.

Notes:

- An image may become distorted when zoomed.
- Subtitles cannot be zoomed.
- The position of the current part is indicated in the lower left of the screen.

Useful operation (continued)

■ To play in the desired order (programmed playback) DVD CD MP3 WMA JPEG

You can play back the desired chapters, tracks or files in the sequence you want.

Maximum of 40 numbers can be programmed.

1 In the stop mode, press the RANDOM/PROGRAM button.

The programming screen appears.

2 Press the cursor (▲ or ▼) button to select "Add" and press the ENTER button.

When programming for discs other than DVD, go to step 4.

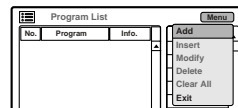

3 Press the cursor (▲ or ▼) button to select a title number and press the ENTER button.

The chapter selection screen appears.

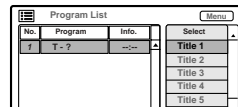

4 Press the cursor (▲ or ▼) button to select a number and press the ENTER button.

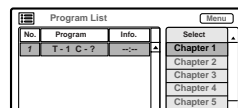

5 Repeat steps 3 - 4 to program more. Up to 40 chapters, tracks or files can be programmed.

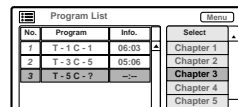

6 Press the cursor (◀) button to finish programming.

To delete the wrong number, press the cursor (▲ or ▼) button to select it and press the CLEAR button.

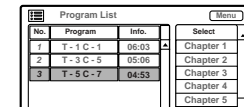

7 Use the cursor (▲ or ▼) button to select a number to start with, and press the ► (DVD/CD ►) button.

- Playback starts from the selected number and ends after the last number in the program.
- "PROGRAM" lights up on the main unit during programmed play.
- Programmed numbers are stored until a disc is removed or you turn the power off.

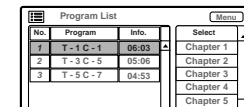

To change the programmed contents:

- 1 While stopped, press the RANDOM/PROGRAM button to show the programming screen.
- 2 Press the TOP MENU/MENU button to show the menu list.
- 3 Use the cursor (▲ or ▼) button to select the desired menu item and then press the ENTER button.
 - "Add" Adds a chapter, track or file to the program.
 - "Insert" Inserts a chapter, track or file above (before) the selected number of a program.
 - "Modify" Modifies the program.
 - "Delete" Deletes the selected number.
 - "Clear All" Deletes the program.
 - "Exit" Turn off the programming screen.

Notes:

- Titles cannot be programmed.
- Programming cannot be performed while paused or in the playback mode.
- On some discs, programmed play does not work.

■ To play repeatedly (repeat play)

DVD CD MP3 WMA JPEG

You can play a chapter (track) or a title repeatedly by specifying it during playback.

1 While the disc is playing, press the A ◀ B REPEAT/◀ button.

Each time the button is pressed, the repeat play mode changes in the following order.

TV screen

Unit display

For DVD, the mode changes as follows:

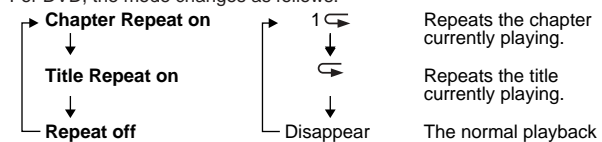

For audio CD, the mode changes as follows:

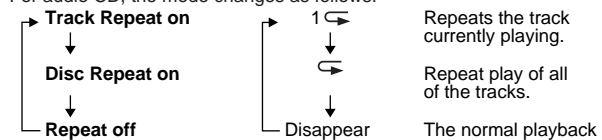

For MP3/WMA/JPEG discs, the mode changes as follows:

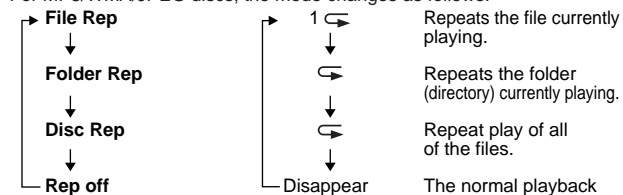

2 Select "Repeat off" by pressing the A ◀ B REPEAT/◀ button repeatedly to return to the normal playback.

Caution:

After performing repeat play, be sure to press the ■ button. Otherwise, the disc will play continuously.

Notes:

- Repeat play is not available on some discs.
- Repeat play is not possible during random play.

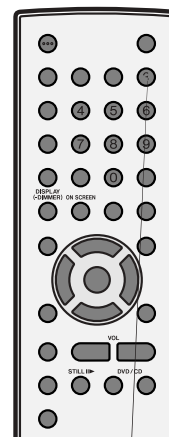

Useful operation (continued)

■ To play the contents between the specified points repeatedly (A-B repeat) **DVD CD**

You can play the desired portion repeatedly by specifying it during playback.

- 1 While a disc is playing, press the **SHIFT** button and then the **A B REPEAT** button.

TV screen

Unit display

A-B Set A

A

This registers the start point (A).

- 2 Press the **SHIFT** button and then the **A B REPEAT** button again to enter the end point (B).

A-B Repeat on

A B

A-B repeat plays from the start point (A) to the end point (B).

- 3 Press the **SHIFT** button and then the **A B REPEAT** button to return to the normal playback.

Notes:

- A-B repeat play is disabled on some discs.
- Some scenes in DVD may not allow A-B repeat play.
- A-B repeat play for DVD is possible only within a title.
- A-B repeat play for audio CD is possible only within a track.
- When you press the **■** button, the current A-B repeat play is canceled. (For DVD, press the **■** button twice.)

■ To change the display on the main unit **DVD CD**

During playback, press the **DISPLAY/(-DIMMER)** button.

Each time you press the button, the display changes as follows:

DVD:

Title elapsed time Title/Chapter number Chapter elapsed time



CD:

Track elapsed time Total elapsed time

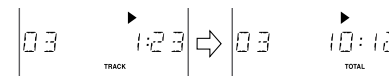

Notes:

- Title/chapter numbers or elapsed time may not appear depending on the disc.
- The playing time of the disc specified on the jacket, etc. may not include silence between tracks, and may differ from that displayed on the main unit.
- Elapsed time on the display does not indicate the actual time.

■ To change the display on TV screen **DVD** **CD**

You can display or hide the operation indicators on the TV screen.
While the disc is playing, press the ON SCREEN button. (The display is changed at each press of this button.)

When playing DVD, the display changes as follows:

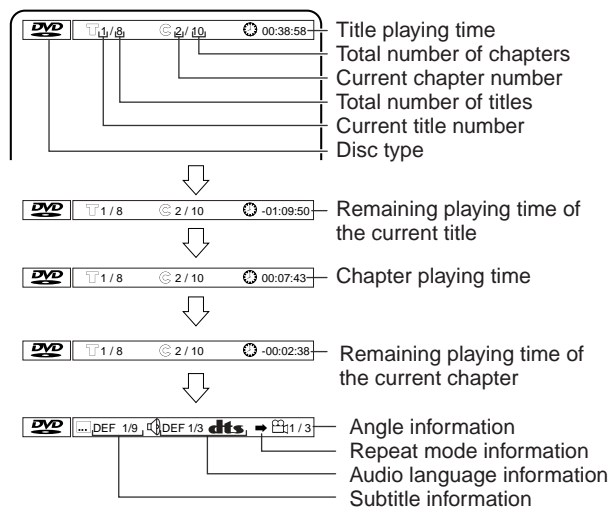

When playing an audio CD, the display changes as follows:

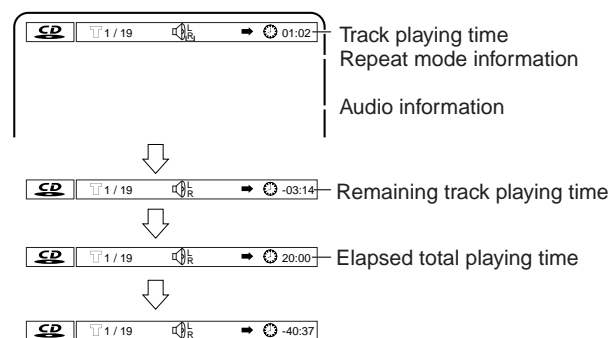

Playing an audio CD

	Page
The following playback functions are the same as DVD operations.	
Playing a disc	28 - 30
To locate the beginning of a chapter/track (skip)	31
Fast forward/Fast reverse (search)	31
To change the audio language (audio output)	34
To play in the desired order (programmed playback)	38
To play repeatedly (repeat play)	39
To play the contents between the specified points repeatedly (A-B repeat)	40
To change the display on the main unit	40
To change the display on TV screen	41

■ To play in random order (random play)

The tracks on the disc can be played in random order automatically.

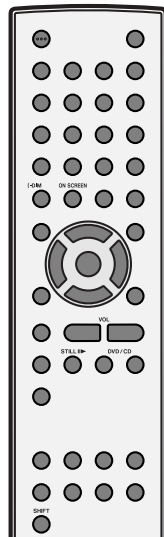

To cancel random play:

Press the  button.

Notes:

- On some discs, this function cannot be used.
- You cannot set the random play while in the playback or pause mode.
- Random play is not allowed during programmed playback.
- In random play, the unit will select and play tracks automatically. (You cannot select the order of the tracks.)
- Repeat play is not possible during random play.

rt playb

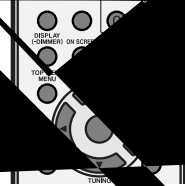

Playing an MP3, WMA or JPEG disc

The following playback functions are the same as DVD or CD operations.

	Page
Playing a disc	28 - 30
To locate the beginning of a chapter/track (skip)	31
Fast forward/Fast reverse (search)	31
To change the audio language (audio output)	34
To play in the desired order (programmed playback)	38
To play repeatedly (repeat play)	39
To play in random order (random play)	42
To start playback from the desired point (direct play)	43

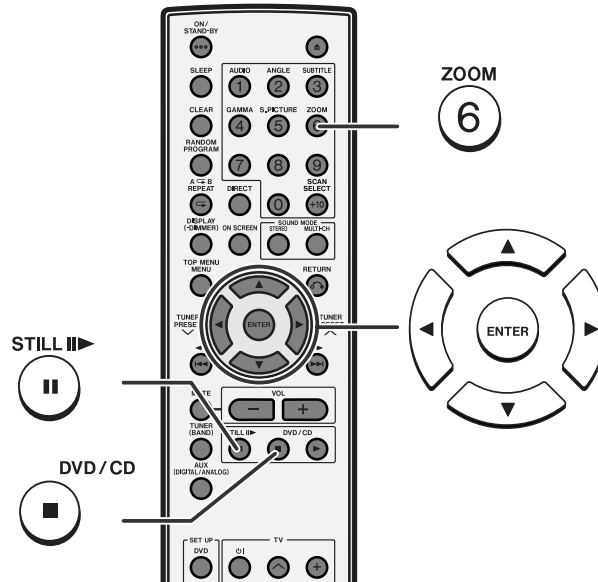

You can play CD-R/RW recorded in the MP3, WMA and JPEG formats. MP3 WMA JPEG

Insert a disc containing MP3, WMA and JPEG files.

A menu screen appears and playback starts automatically.

- ... Folder
- ... MP3 file
- ... WMA file
- ... JPEG file

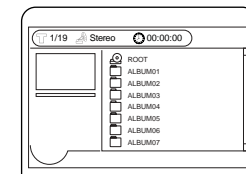

Example of playback sequence

- Playback is performed in the order of 1 to 11 in this example.
- Files on some discs cannot be played in order.

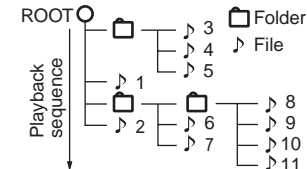

When playing JPEG files

- Playback skips to the next file approx. every 5 seconds.
- To return to the menu screen, press the button.

Selecting a folder/file on the menu screen:

In the stop mode, press the cursor (or) button to select a folder/file and press the ENTER button.

Caution:

If you convert MP3 data to "audio CD" data when recording on a CD-R/RW, play it as an audio CD. The MP3 operation cannot be performed.

Notes:

- Up to 20 characters can be displayed for a folder name and a file name. Underlines, asterisks, and spaces may not be displayed.
- Due to the structure of the disc information, it takes longer to read an MP3, WMA or JPEG disc than a normal CD.

■ **Zo**

7. Press the **ZOOM** button when the "Zoom on" message appears.

8. Press the **ZOOM** button again when the "Zoom 150 Pct" message appears.

9. Press the **ZOOM** button again when the "Zoom 200 Pct" message appears.

10. Press the **ZOOM** button again when the "Zoom 150 Pct ↔ Zoom 200 Pct" message appears.

3 To zoom in on a zoomed part of a zoomed image, press the **ZOOM** button repeatedly.

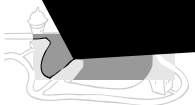

To return to normal view:
Press the SHIFT button and then the ZOOM button again, "Zoom off" will show on the screen.

Note:
Some images may not be zoomed or rotated (" " appears).

Listening to the radio

■ Tuning

TUNER
(BAND)



TUNER
(BAND)

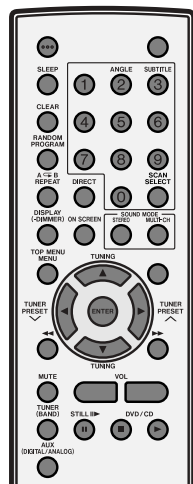

Notes:

- When radio interference occurs, auto scan tuning may stop automatically at that point.
- Auto scan tuning will skip weak signal stations.
- To stop the auto tuning, press the TUNING button again.

To receive an FM stereo transmission:

Press the TUNER (BAND) button to display the "STEREO" indicator.

- " " will appear when an FM broadcast is in stereo.
- If the FM reception is weak, press the TUNER (BAND) button to extinguish the "STEREO" indicator. The reception changes to monaural, and the sound becomes clearer.

■ Memorizing a station

You can store 40 AM and FM stations in memory and recall them at the push of a button. (Preset tuning)

- 1 Perform steps 1 - 3 in "Tuning" on page 46.**
- 2 Press the ENTER button to enter the preset tuning saving mode.**

- 3 Within 5 seconds, press the TUNER PRESET (∨ or ∧) button to select the preset channel number.**
Store the stations in memory, in order, starting with preset channel 1.
- 4 Within 5 seconds, press the ENTER button to store that station in memory.**

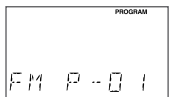

If the "PROGRAM" and preset number indicators go out before the station is memorized, repeat the operation from step 2.
- 5 Repeat steps 1 - 4 to set other stations, or to change a preset station.**
When a new station is stored in memory, the station previously memorized will be erased.

Note:

The backup function protects the memorized stations for a few hours should there be a power failure or the AC power cord get disconnected.

■ To recall a memorized station

Press the TUNER PRESET (∨ or ∧) button for less than 0.5 seconds to select the desired station.

To select a preset station with the direct number buttons:

- 1 Press the corresponding number ("0" - "9").
- 2 Press the ENTER button.

Example:

To select 28, press "2", "8" and "ENTER".

■ To scan the preset stations

The stations saved in memory can be scanned automatically. (Preset memory scan)

- 1 Press the TUNER PRESET (∨ or ∧) button for more than 0.5 seconds.
The preset number will flash and the programmed stations will be tuned in sequentially, for 5 seconds each.
- 2 Press the TUNER PRESET (∨ or ∧) button again when the desired station is located.

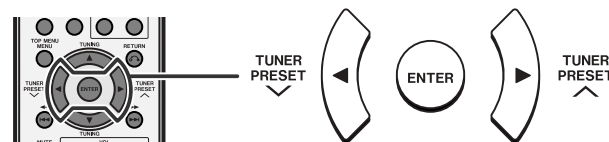

■ To erase entire preset memory

- 1 Hold the CLEAR button down for 4 seconds or more.
- 2 Within 10 seconds, press the ENTER button.



Enjoying surround sound (sound mode)

Dolby Digital

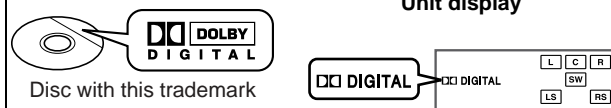

A 5.1 surround sound decoding used for home theater surround sound. You can enjoy the stereophonic effect in the home theater system.

When you set the audio output to Dolby Digital for a disc recorded in Dolby Digital, the DIGITAL indicator lights up (see page 34).

DTS (Digital Theater Systems)

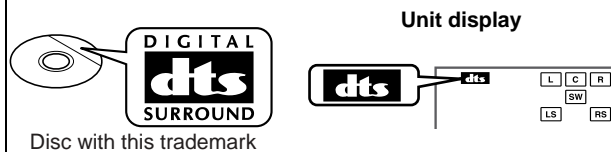

A 5.1 surround sound decoding used for home theater surround sound. As the sound quality is emphasized, you can enjoy the realistic sound effect in the home theater system.

When you set the audio output to DTS for a disc recorded in DTS, the indicator lights up (see page 34).

Unit display



Linear PCM

A signal recording format without compression

Used in DVD and CD featuring a musical or concert.

Dolby Pro Logic II

Stereo-recorded discs and video tapes

Dolby Pro Logic II decodes 2 channel stereo sound from discs, videotapes, etc. to reproduce 5.1 channel surround sound. You can enjoy a three-dimensional sound field.

When Dolby Pro Logic II is activated, the PRO LOGIC II indicator lights up.

■ Audio Signal/Speaker Indicators

Audio signal indicators light up for the corresponding audio source, and speaker indicators are illuminated according to signals sent to the speakers.

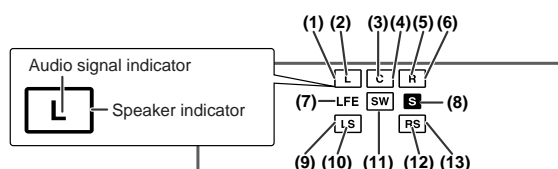

Example:

When 2.1 channel audio signals (L, R, LFE) are received, the audio signal indicators "L", "R" and "LFE" light up.

The illustration below indicates that 2 channel stereo sound (L and R) is reproduced.

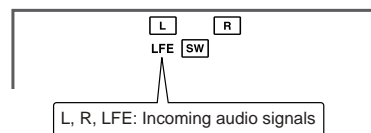

When Dolby Pro Logic II is activated

2 channel stereo sound is converted to 5.1 channel surround sound, and all the speaker indicators "□" light up.

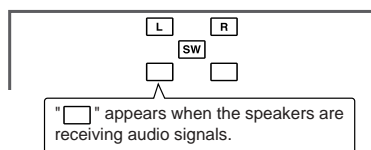

Audio Signal/Speaker Indicators:

- (1) Left Front Speaker Indicator
- (2) Left Indicator
- (3) Center Indicator
- (4) Center Speaker Indicator
- (5) Right Indicator
- (6) Right Front Speaker Indicator
- (7) Low Frequency Effect Indicator
- (8) Surround Monaural Signal Indicator
(Lights up when the surround speakers receive monaural signals.)
- (9) Left Surround Speaker Indicator
- (10) Left Surround Indicator
- (11) Subwoofer Indicator
- (12) Right Surround Indicator
- (13) Right Surround Speaker Indicator

Notes:

- You can switch the audio output when the disc contains sounds of multiple audio formats (Dolby Digital, DTS, etc.). See page 34.
- Sound may not be produced from the subwoofer/amplifier unit depending on the disc.
- You cannot change the multi channel mode or stereo mode while listening to the radio.
- If sound is unpleasant to listen to, change the multi channel mode or stereo mode.
- Settings for the multi channel mode and stereo mode are retained by input (DVD, AUX DIGITAL and AUX ANALOG).

Enjoying surround sound (sound mode) (continued)

You can enjoy spacious sound recorded in Dolby Digital or DTS. Also, Dolby Pro Logic II allows you to enjoy spacious 2 channel stereo sound.

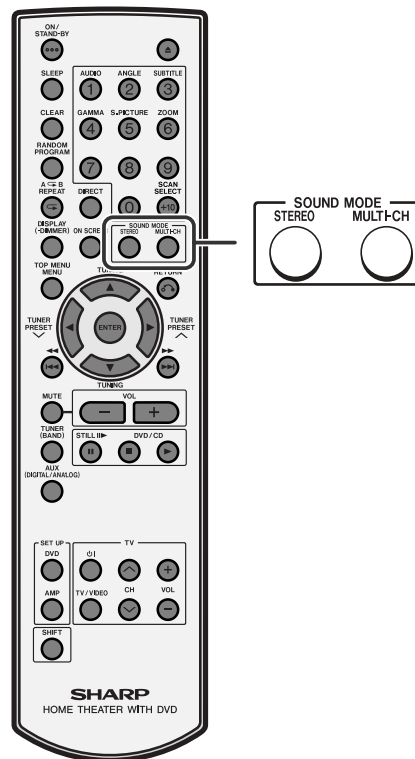

■ Listening to 2 channel stereo sounds

While the disc is playing, press the **STEREO** button.

Example: DTS format



You can enjoy 2 channel stereo sound.

When you press once, the last used setting appears. To change it, press the button repeatedly within 3 seconds.

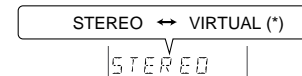

STEREO: You can enjoy the great acoustic effects of the front speakers and subwoofer/amplifier unit.

VIRTUAL (*): Although the surround speaker does not work, you can enjoy spacious surround effects. It sounds as if speakers are also placed in .

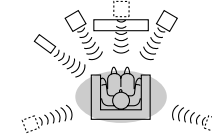

(*) For CD playback, "SURROUND" appears instead of "VIRTUAL" (effects are the same).

Notes:

- When the surround mode is set to "STEREO" or "VIRTUAL (SURROUND)", the same monaural sound is reproduced in the both of the right and left channels.
- Some discs are recorded at 96 kHz (sampling frequency). When this type of disc is played on a compatible player and signals are digitally [AUX (DIGITAL) IN] sent to this unit, the sound mode is changed to "STEREO" automatically. The sound mode cannot be changed during playback.

■ Listening to sounds in the multi channel mode (5.1 ch, etc.)

DVD (Dolby Digital or DTS)

While the disc is playing, press the MULTI-CH button.

Example: DTS format

A maximum of 5.1-ch surround sound is reproduced to provide three-dimensional effect.

When you press once, the last used setting appears. To change it, press the button repeatedly within 3 seconds.

- STANDARD:** You can enjoy the original sound as it is.
- MOVIE:** The bass level is increased for powerful sound effect.
- MUSIC:** You can enjoy lively sound by producing the articulate sound.
- NIGHT:** The dynamic range control (compression) is activated automatically and you can enjoy clear sound even at low volumes.

Note:

When listening to Dolby Digital or DTS sound, you cannot select "STADIUM" and "HALL".

Notes:

- When monaural signals are received in the multi channel mode, only the center speaker and subwoofer/amplifier unit produce sound. If played in the "STEREO" mode, the same sound is reproduced from the right and left speakers.
- When you play Dolby Digital or DTS sound with "STADIUM" or "HALL" set, surround is automatically set to "STANDARD".

Changing the default setting of the amplifier

Change settings according to the connected speakers.

Speaker delay setting (See page 53.)

Speaker level setting (See page 54.)

Test tone (See page 54.)

Example:

If the right surround speaker is 10 feet (3.3 m) away from the listening position, change settings as shown below (adjust the SR).

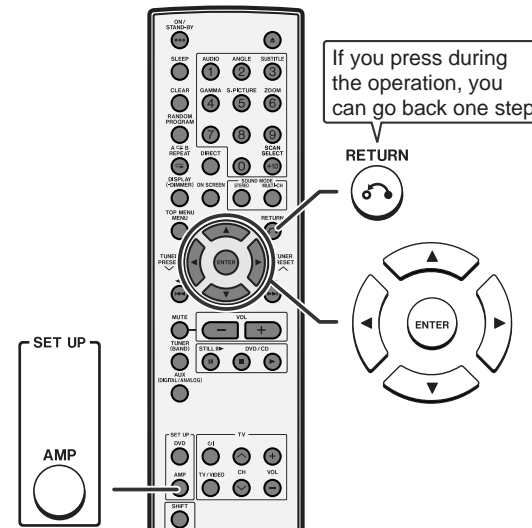
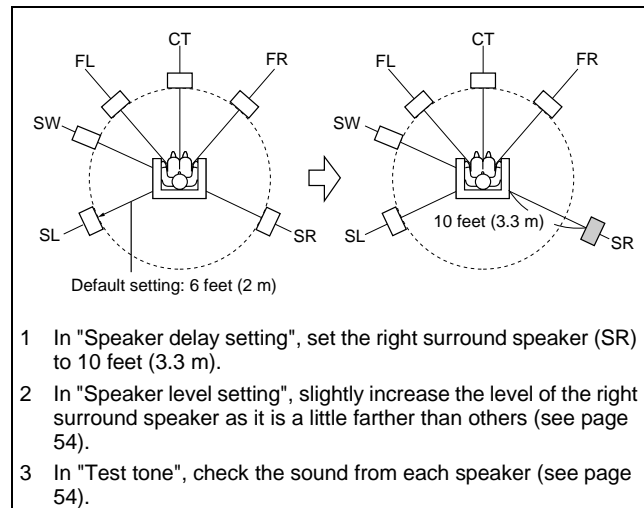

	Speaker type	Delay range	Level range
FL	Front speaker (Left)	1 to 29 ft	- 6 dB to + 6 dB
CT	Center speaker	1 to 29 ft	- 6 dB to + 6 dB
FR	Front speaker (Right)	1 to 29 ft	- 6 db to + 6 dB
SR	Surround speaker (Right)	1 to 29 ft	- 6 dB to + 6 dB
SL	Surround speaker (Left)	1 to 29 ft	- 6 dB to + 6 dB
SW	Subwoofer/amplifier unit	—	- 10 dB to + 10 dB

Default settings:

Delay --- 6 ft (2 m)

Level --- 0 dB (FL, CT, FR, SR, SL), + 5 dB (SW)

In the stop mode, you can change the amplifier settings on the TV screen.

1 Press the SET UP AMP button.

The amplifier setting screen appears.

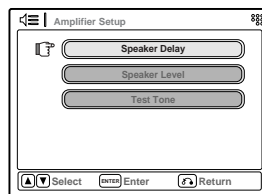

2 Press the ▲ or ▼ button to select the menu and press the ENTER button.

3 Press the ▲, ▼, ◀ or ▶ button to change the setting.

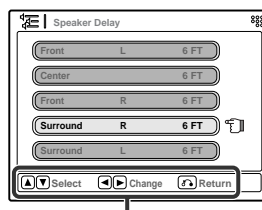

Repeat the operation as instructed.

(The number of repetition depends on the setting item.)

To change other settings, begin from step 2.

4 Press the RETURN ↵ button twice.

The setting is complete.

Notes:

- You cannot change the amplifier settings unless the input source is set to DVD/CD.
- The amplifier settings cannot be changed in the tuner mode and do not affect the tuner sound.

Speaker delay setting

When some of the speakers are at a different distance from the listening point, you can select the speaker delay to make it seem as though the speaker distances are the same.

1 Press the SET UP AMP button.

2 Within 10 seconds, press the ▲ or ▼ button to select "SP DELAY", and then press the ENTER button.

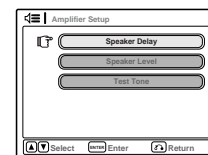

3 Within 10 seconds, press the ▲ or ▼ button to select the desired speaker.

The indicator of the selected speaker flashes.

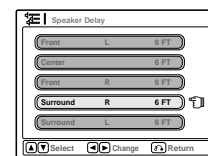

4 Within 10 seconds, press the ◀ or ▶ button to select the distance.

- You can change the distance in 1 foot (0.3 m) steps.
- To set the distance of other speakers, repeat the operation from step 3.

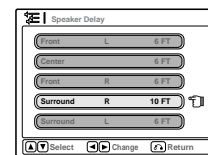

5 Press the RETURN ↵ button twice.

The setting is complete.

Note:

The speaker delay setting is not available when the surround is "STEREO" or "VIRTUAL (SURROUND)".

Changing the default setting of the amplifier (continued)

■ Speaker level setting

If sounds from the speakers are uneven, you can equalize them by adjusting the speaker levels.

1 Press the SET UP AMP button.

2 Within 10 seconds, press the ▲ or ▼ button to select "SP LEVEL", and then press the ENTER button.

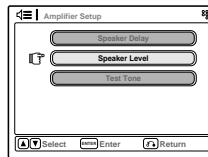

3 Within 10 seconds, press the ▲ or ▼ button to select the desired speaker.

The indicator of the selected speaker flashes.

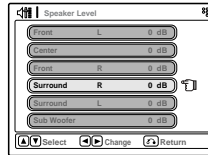

4 Within 10 seconds, press the ◀ or ▶ button to adjust the level.

- You can adjust the level at 1 dB intervals.
- To set the level of other speakers, repeat the operation from step 3.

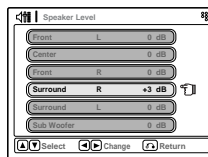

5 Press the RETURN button twice.

The setting is complete.

Notes:

- The speaker level setting is only available for the front speakers and subwoofer/amplifier unit when the surround is "STEREO" or "VIRTUAL (SURROUND)".
- If subwoofer/amplifier unit sound is distorted, lower the subwoofer/amplifier unit level.

■ Test tone

You can check each speaker sound by a test tone. Readjust the volume set in "Speaker level setting".

1 Press the SET UP AMP button.

2 Within 10 seconds, press the ▲ or ▼ button to select "TONE", and press the ENTER button.

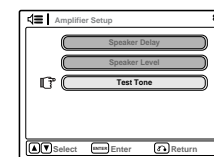

The test tone will be heard from each speaker in order, at about 2-second intervals.

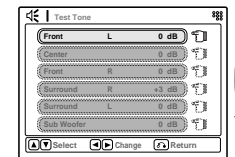

To adjust speaker levels

While the test tone is heard:

Adjust the level with the ◀ or ▶ button.

Press the ▲ or ▼ to select a speaker.

3 Press the RETURN button twice.

The setting is complete.

Note:

The test tone is produced only from the front speakers and subwoofer/amplifier unit when the surround is "STEREO" or "VIRTUAL (SURROUND)".

Changing the initial setting of DVD

HT-X1

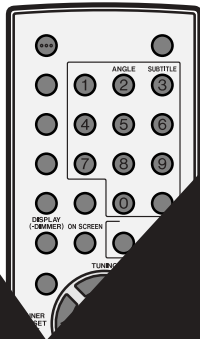

Changing the initial setting of DVD (continued)

Setting	Selectable parameters (* indicates initial settings.)		Description	Reference page
Language Setup	OSD Language	English* Français Español	A language for screen display can be set, such as for initial settings or messages.	—
	Audio	English* Other	A language for audio can be set. You can specify a language for conversation and narration.	
	Subtitle	English* Other Off	A language for subtitle can be set. The subtitles are displayed in a specified language.	
	Disc menu	English* Other	A language for disc menus can be set. Menu screens are displayed in a specified language.	
Video Setup	TV screen	4:3 PS 4:3 LB* 16:9	The screen mode should be set according to the connected TV type. 4:3 PS When playing a wide image (16:9) disc, the left and right sides of the image are cut (pan scan) to display a natural-looking 4:3 size image. A 4:3 disc is played in 4:3. 4:3 LB When playing a wide image (16:9) disc, black bands are inserted at the top and bottom and you can enjoy full wide images (16:9) on a 4:3 size TV. A 4:3 disc is played in 4:3. 16:9 A wide image (16:9) is displayed when playing a wide image (16:9) disc. <ul style="list-style-type: none"> ● When playing a 4:3 image disc, the image size depends on the setting of the connected TV. ● If you play back a wide image (16:9) disc with the main unit connected to a 4:3 TV, images appear stretched vertically. 	—
	TV type	NTSC* Auto	Selects the correct color system (TV standard). NTSC: Select this mode for the NTSC TV. Auto: Select this mode for the multi-system TV.	
	Video output	Interlace* Progressive	The video output mode should be set according to the connected TV type. Interlace: Select this for a non-progressive scan TV (use a video cable, S-video cable, or component video cable). Progressive: Select this for a progressive scan TV (use a component video cable).	

Setting	Selectable parameters (* indicates initial settings.)		Description	Reference page
Video Setup	Picture mode	Auto Film Video Smart*	Select a mode to optimize DVD images on a TV. Auto: Images are automatically optimized according to the video source. Film: Suitable for progressive video output. Select for DVD movies, etc. Video: Suitable for interlaced video output. Select for DVD karaoke, etc. Smart: Optimize special effects for progressive video output.	—
Display Setup	Angle mark	On* Off	Select whether to display "⌘" (On) or not (Off).	P. 37
	Screen saver	On Off*	Select whether to use a screen saver (On) or not (Off). On: Press the ■ button. After 5 minutes or more of inactivity, a screen saver appears. To turn off the screen saver on the screen, press any button on the main unit or remote control. Off: Cancel the screen saver setting.	—
	Closed caption	On Off*	Select whether to display the closed caption (On) or not (Off). On: The closed caption data (subtitles) appear on the TV screen automatically. You can see the closed caption data when playing DVD discs (with "CC" on the jacket) on this unit. Off: Cancel the closed caption setting.	—
System Setup	Parental setting	Level: 1 : : 6* : : No Limit	Sets a restriction level for DVD viewing. Level 1 - 8: The level 1 is the least strict, and the level 8 is the strictest (restriction differs depending on the country). No Limit: Parental level control is canceled.	P. 58
	Please enter a 4-digit password. (Default setting: 6629)	Code: USA* : :	Set a country code according to a parental control level of discs.	—
	Password Edit	-----	Password setting.	P. 58
	Restore Info	-----	This resets all settings to the factory defaults.	P. 58

Changing the initial setting of DVD (continued)

Other language settings

You can set the "Other" language for audio, subtitle, and disc menu. (Refer to "Language code list for disc language" on page 59.)
Example: To select HU (Hungarian) as a disc menu

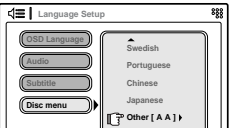
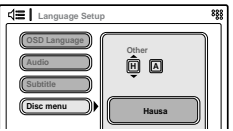
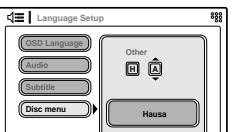
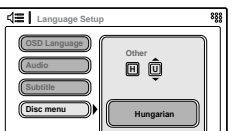
- 1 On the initial setting screen, select "Language Setup" (see steps 1 - 2 on page 55), and select "Disc menu" and press the ENTER button.
- 2 Press the cursor (▲ or ▼) button to select "Other" and press the ENTER button.
 
- 3 Press the ▲ or ▼ button to select "H" for the first letter.
 
- 4 Press the ◀ or ▶ button to move cursor for entering the second letter.
 
- 5 Press the ▲ or ▼ button to select "U" for the second letter.
 
- 6 Press the ENTER button.
- 7 Press the RETURN ⏪ button twice.
The new setting is memorized.

Parental level setting

- 1 Select "System Setup" on the setup menu screen (see steps 1 - 2 on page 55).
- 2 Select "Parental setting" in step 3 on page 55.
- 3 Press the cursor (▲ or ▼) button to select "Level" and press the ENTER button.
- 4 Enter a 4-digit password with the direct number buttons. (Default setting: 6629)
- 5 Set the parental level (see page 57) and press the ENTER button.
- 6 Press the SET UP DVD button.

Note:

While playing a disc with parental lock, the display may appear requesting a password in order to watch some restricted scenes. In such a case, enter the password to temporarily change the parental level.

To change the password:

- 1 Select "System Setup" on the setup menu screen (see steps 1 - 2 on page 55).
- 2 Select "Password Edit" in step 3 on page 55.
- 3 Enter a 4-digit old password with the direct number buttons. (Default setting: 6629)
- 4 Enter a 4-digit new password with the direct number buttons.
- 5 Enter the new password again for confirmation.
- 6 Press the SET UP DVD button.

When you forget your password:

- 1 Select "System Setup" on the setup menu screen (see steps 1 - 2 on page 55).
- 2 Select "Restore Info" in step 3 on page 55.
- 3 Enter 2486 with the direct buttons.
When reset is done according to this method, all settings will be reset to the factory defaults.

Language code list for disc language

HT-X1

Code	Language name	Code	Language name	Code	Language name	Code	Language name
AA	Afar	FY	Frisian	MG	Malagasy	SN	Shona
AB	Abkhazian	GA	Irish	MI	Maori	SO	Somali
AF	Afrikaans	GD	Scots Gaelic	MK	Macedonian	SQ	Albanian
AM	Amharic	GL	Galician	ML	Malayalam	SR	Serbian
AR	Arabic	GN	Guarani	MN	Mongolian	SS	Siswati
AS	Assamese	GU	Gujarati	MO	Moldavian	ST	Sesotho
AY	Aymara	HA	Hausa	MR	Marathi	SU	Sundanese
AZ	Azerbaijani	HI	Hindi	MS	Malay	SV	Swedish
BA	Bashkir	HR	Croatian	MT	Maltese	SW	Swahili
BE	Byelorussian	HU	Hungarian	MY	Burmese	TA	Tamil
BG	Bulgarian	HY	Armenian	NA	Nauru	TE	Telugu
BH	Bihari	IA	Interlingua	NE	Nepali	TG	Tajik
BI	Bislama	IE	Interlingue	NL	Dutch	TH	Thai
BN	Bengali; Bangla	IK	Inupiak	NO	Norwegian	TI	Tigrinya
BO	Tibetan	IN	Indonesian	OC	Occitan	TK	Turkmen
BR	Breton	IS	Icelandic	OM	(Afan) Oromo	TL	Tagalog
CA	Catalan	IT	Italian	OR	Oriya	TN	Setswana
CO	Corsican	IW	Hebrew	PA	Panjabi	TO	Tonga
CS	Czech	JA	Japanese	PL	Polish	TR	Turkish
CY	Welsh	JI	Yiddish	PS	Pashto, Pushto	TS	Tsonga
DA	Danish	JW	Javanese	PT	Portuguese	TT	Tatar
DE	German	KA	Georgian	QU	Quechua	TW	Twi
DE	German	KK	Kazakh	RM	Rhaeto-Romance	UK	Ukrainian
DZ	Bhutani	KL	Greenlandic	RN	Kirundi	UR	Urdu
EL	Greek	KM	Cambodian	RO	Romanian	UZ	Uzbek
EN	English	KN	Kannada	RU	Russian	VI	Vietnamese
EO	Esperanto	KO	Korean	RW	Kinyarwanda	VO	Volapuk
ES	Spanish	KS	Kashmiri	SA	Sanskrit	WO	Wolof
ET	Estonian	KU	Kurdish	SD	Sindhi	XH	Xhosa
EU	Basque	KY	Kirghiz	SG	Sango	YO	Yoruba
FA	Persian	LA	Latin	SH	Serbo-Croatian	ZH	Chinese
FI	Finnish	LN	Lingala	SI	Singhalese	ZU	Zulu
FJ	Fiji	LO	Laothian	SK	Slovak		
FO	Faroese	LT	Lithuanian	SL	Slovenian		
FR	French	LV	Latvian, Lettish	SM	Samoan		

Sleep operation

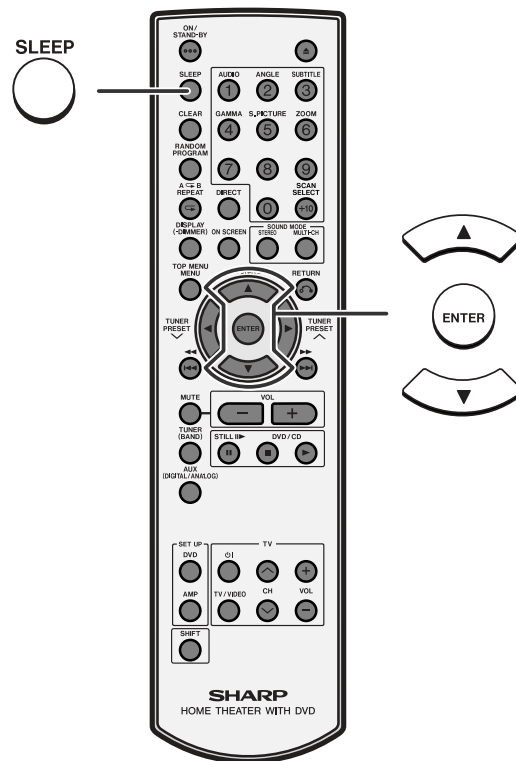

You can set the system to the power stand-by mode at the specified time.



- 1 Play back the desired sound source.
- 2 Press the SLEEP button and within 8 seconds, press the ENTER button.



To change the sleep time:

While the sleep time is displayed, press the  or  button.
(Maximum: 3 hours - Minimum: 5 minutes)

- 3 Within 30 seconds, press the ENTER button.
- 4 The system will enter the power stand-by mode automatically after the preset time has elapsed.
The volume will be turned down 30 seconds before the sleep operation finishes.

To confirm the remaining sleep time:

Press the SLEEP button while the sleep timer is set.
The remaining sleep time is displayed for about 8 seconds.

To cancel the sleep operation:

Press the ON/STAND-BY button while the sleep timer is set.

Audio connection to other equipment

You can hear the sound of other equipment via this product. Connect the DVD player, VCR or digital tuner to a TV directly to receive the images (refer to the operation manual of each equipment).

Caution:

Turn off the other equipment before making this connection.

Notes:

- Change the audio between analog and digital with the AUX (DIGITAL/ANALOG) button.
- Insert the plugs fully to avoid fuzzy pictures or noise.

■ Connection for the analog sound (VCR, etc.)

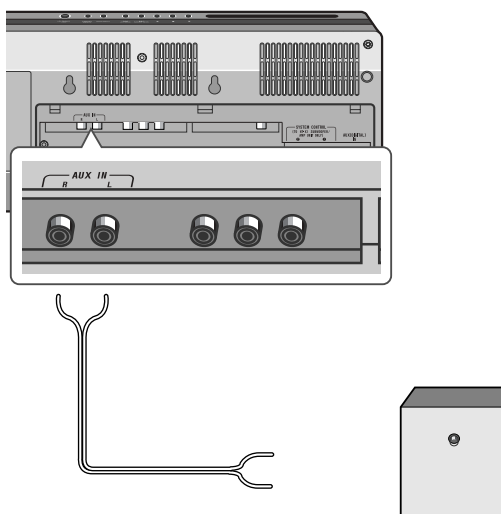

■ Connection for the digital tuner sound (or other optical digital equipment such as an MD player)

If the digital equipment has an optical output jack, you can enjoy better sound by connecting it to the optical digital input jack of the main unit using the optical digital cable.

Note:

When connecting with an optical digital cable, set the digital output of the digital tuner to PCM. Refer to the operation manual of the digital tuner.

To install the main unit on the wall

Preparation:

Remove the stand from the main unit (perform steps 1 - 2 on page 18).

Sharp has designed the main unit so you can hang it on the wall. Use appropriate screws (not supplied). See the illustration on the right for size and type.

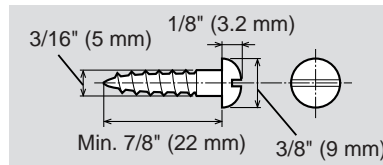

1 Drive two screws into the wall for main unit, as shown in the illustration.

Make sure that both the screw and the wall can support a load of 4.9 lbs. (2.2 kg).

Drive the screws, so the screw head extends about $7/32$ " (5.5 mm) out from the wall.

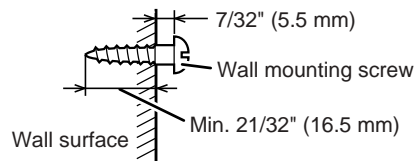

2 Fix the pattern paper and drive two screws into the wall with a distance of $5-3/25$ " (130 mm) in between.

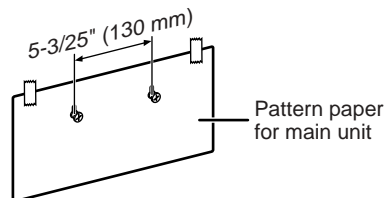

3 Tighten the screws and remove the paper. Hook the main unit on the screw heads and make sure it is secure.

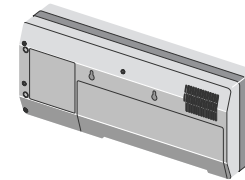

CAUTION:

- Make sure to prevent the main unit [4.9 lbs. (2.2 kg)] from falling when mounting it on the wall.
- Before mounting, check the wall strength. (Do not put on a veneer plaster or whitewashed wall. The main unit may fall.) If it is not clear, consult with a qualified service technician.
- Mounting screws are not supplied. Use appropriate ones.
- Check all mounting screws for looseness and that they are engaged in the main unit.
- Mount the main unit on the wall with 2 screws.
- Select a good location. If not, accidents may occur or the main unit may get damaged.
- Avoid placing on a bed, sofa, water tank, sink and hallway wall.
- SHARP is not responsible for accidents resulting from improper installation.

Troubleshooting chart

Many potential problems can be resolved by the owner without calling a service technician.

If something is wrong with this product, check the following before calling your authorized SHARP dealer or service center.

■ General

Symptom	Possible cause
The power is not turned on.	<ul style="list-style-type: none"> ● Is the system unplugged? ● Are the system connection cords disconnected?
No sound is heard.	<ul style="list-style-type: none"> ● Is the volume level set to "0"? ● Are the headphones connected? ● Are the speaker wires disconnected?
The sound from speakers is not well balanced.	<ul style="list-style-type: none"> ● Are the speaker wires connected to the wrong channels?
Noise is heard during playback.	<ul style="list-style-type: none"> ● Move the system away from any computers or mobile phones.
When a button is pressed, the system does not respond.	<ul style="list-style-type: none"> ● Set the system to the power stand-by mode and then turn it back on. ● If the system still malfunctions, reset it. (Refer to page 64.)
Interference or noise occurs on the TV image.	<ul style="list-style-type: none"> ● Is the system placed near TV with internal antenna? Use an outdoor antenna.
The display on the main unit is dark.	<ul style="list-style-type: none"> ● Is the display in the dimmer mode?
No images are displayed.	<ul style="list-style-type: none"> ● Is the TV turned on? ● Is the TV input switched on? ● The video output mode may not match the jacks you are using. Change the mode as follows. In the stop mode, press the SHIFT button and SCAN SELECT button on the remote control a few times (see page 22).

■ DVD player

Symptom	Possible cause
Even though a disc is loaded, "No Disc" is displayed.	<ul style="list-style-type: none"> ● Is the disc loaded upside down? ● Is the disc very dirty? ● Does the disc satisfy the standards? ● Is the system located near excessive vibrations?
Playback sounds are skipped.	<ul style="list-style-type: none"> ● Is condensation formed inside the system?
The control buttons do not function. Music or video playback is interrupted.	<ul style="list-style-type: none"> ● Is the disc very dirty? ● Does the disc satisfy the standards? ● Is the system located near excessive vibrations? ● Is condensation formed inside the system?
Pictures and sound are skipped.	<ul style="list-style-type: none"> ● Is the disc very dirty? ● Is the system located near excessive vibrations? ● Is condensation formed inside the system?
The system does not operate even if the power is on.	<ul style="list-style-type: none"> ● Is a disc other than a DVD (region number 1 or ALL), audio CD, CD-R or CD-RW loaded?
Images cannot be played back. (Sound is not heard.)	<ul style="list-style-type: none"> ● Are the video and audio cables connected improperly? ● Is a disc other than a DVD (region number 1 or ALL), audio CD, CD-R or CD-RW loaded? ● Is the disc very dirty? ● Is the disc loaded upside down? ● Is the optical pickup dirty? ● Is the TV input set to video (VIDEO 1, VIDEO 2, etc.)? ● Is the system turned on?

Troubleshooting chart (continued)

■ Tuner

Symptom	Possible cause
The radio makes unusual noises continuously.	<ul style="list-style-type: none"> ● Is the system placed near the TV or computer? ● Is the FM antenna or AM loop antenna placed properly? Move the antenna away from the AC power cord if it's located nearby.
The preset channel cannot be recalled.	<ul style="list-style-type: none"> ● Did you remove the plug from the wall jack, or did a power failure occur? Set the channel again.

■ Remote control

Symptom	Possible cause
The remote control does not operate.	<ul style="list-style-type: none"> ● Is the battery polarity correct? ● Are the batteries dead? ● Is the distance or angle incorrect? ● Are there any obstructions in front of the main unit? ● Is the remote control sensor exposed to strong light (inverter fluorescent light, direct sunlight, etc.)? ● Is the remote control for another equipment used simultaneously?
The system cannot be turned on with the remote control.	<ul style="list-style-type: none"> ● Is the AC power cord of the subwoofer/amplifier unit plugged in? ● Are the batteries inserted?

■ Condensation

Sudden temperature changes, storage or operation in an extremely humid environment may cause condensation inside the cabinet (laser pickup, etc.) or on the transmitter on the remote control. Condensation may cause the system to malfunction. If this happens, leave the power on with no disc in the system until normal playback is possible (about 1 hour). Wipe off any condensation on the transmitter with a soft cloth before operating the system.

■ If trouble occurs

When this product is subjected to strong external interference (mechanical shock, excessive static electricity, abnormal supply voltage due to lightning, etc.) or if it is operated incorrectly, it may malfunction.

If such a problem occurs, do the following:

- 1 Set the system to the stand-by mode and turn the power on again.
- 2 If the system is not restored in the previous operation, unplug and plug in the subwoofer/amplifier unit, and then turn the power on.

Note:

If neither operation above restores the system, clear all the memory by resetting it.

■ Clearing all the memory (reset)

- 1 Press the ON/STAND-BY button to enter the power stand-by mode.
- 2 While pressing down the ■ button and the FUNCTION button, press the ON/STAND-BY button until "SYS RESTORE" appears.



Caution:

When you reset, all data is deleted and the settings return to the default. (DVD initial settings are retained.)

Maintenance

■ Cleaning the laser pickup lens

In order to ensure proper operation of the DVD player, preventative maintenance (cleaning of the laser pickup lens) should be performed periodically. Lens cleaners are commercially available. Contact your local DVD software dealer for options.

■ Cleaning the cabinet

Periodically wipe the cabinet with a soft cloth and a diluted soap solution, then with a dry cloth.

Caution:

- Do not use chemicals for cleaning (gasoline, paint thinner, etc.). It may damage the cabinet finish.
- Do not apply oil to the inside of each component as this may cause malfunctions.
- Since the disc insertion slot faces upward, dust may accumulate on it. Clean it with a cotton swab, etc.



■ Care of discs

Discs are fairly resistant to damage, however mistracking can occur due to an accumulation of dirt on the disc surface. Follow the guidelines below for maximum enjoyment from your disc collection and player.

- Do not write on either side of the disc, particularly the non-label side from which signals are read. Do not mark this surface.
- Keep your discs away from direct sunlight, heat, and excessive moisture.
- Always hold the discs by the edges. Fingerprints, dirt, or water on the discs can cause noise or mistracking. If a disc is dirty or does not play properly, clean it with a soft, dry cloth, wiping straight out from the center, along the radius.

Error indicators and warnings

When you load an unplayable disc or fail to perform operations properly, the following messages are displayed on the TV screen.

Optional accessory

Use only the specified optional accessory to operate this product properly.
For speaker installation, read instructions supplied with stands.

HT-X1

Specifications

As part of our policy of continuous improvement, SHARP reserves the right to make design and specification changes for product improvement without prior notice. The performance specification figures indicated are nominal values of production units. There may be some deviations from these values in individual units.

■ Main unit

Dimensions	Including the stand Width: 17" (430 mm) Height: 7-5/8" (192 mm) Depth: 4" (100 mm) Excluding the stand Width: 17" (430 mm) Height: 6-3/4" (171 mm) Depth: 3-1/2" (88 mm)
Weight	4.9 lbs. (2.2 kg)
Frequency range	FM: 87.5 - 108 MHz AM: 530 - 1,720 kHz
Video output terminals	Video output: RCA type × 1 S-video output: S-terminal × 1 Component video output: RCA type × 3 (Y/PB/PR)
Audio output terminal	Headphones: 16 - 50 ohms (recommended: 32 ohms)
Audio input terminals	Audio input (AUX): RCA type × 2 Optical digital input: Square type × 1
Other terminal	System control × 2
Signal system	NTSC color
Supported disc types	DVD (region number 1 or ALL), DVD-R/RW (video mode), DVD+R/RW (video mode), audio CD, CD-R, CD-RW
Video signal	Horizontal resolution: 500 lines S/N ratio: 70 dB

Audio signal	Frequency characteristics	Linear PCM DVD: 4 Hz to 22 kHz (sampling rate: 48 kHz) 4 Hz to 44 kHz (sampling rate: 96 kHz) CD: 4 Hz to 20 kHz
	S/N ratio	CD: 96 dB (1 kHz)
	Dynamic range	Linear PCM DVD: 95 dB CD: 94 dB
	Total harmonic distortion ratio	0.006 % maximum

■ Front speakers

Type	Full range system (magnetic shield) 3-1/8" (8 cm) speaker × 1
Maximum input power	100 W
Rated input power	50 W
Impedance	4 ohms
Dimensions	Width: 4-1/8" (105 mm) Height: 8-1/8" (205 mm) Depth: 4-1/8" (105 mm)
Weight	2.0 lbs. (0.9 kg)/each

■ Surround speakers

Type	Full range system 3-1/8" (8 cm) speaker × 1
Maximum input power	100 W
Rated input power	50 W
Impedance	4 ohms
Dimensions	Width: 4-1/8" (105 mm) Height: 8-1/8" (205 mm) Depth: 4-1/8" (105 mm)
Weight	1.7 lbs. (0.75 kg)/each

■ Center speaker

Type	Full range system (magnetic shield) 3-1/8" (8 cm) speaker × 1
Maximum input power	100 W
Rated input power	50 W
Impedance	4 ohms
Dimensions	Width: 7-1/4" (185 mm) Height: 4-7/8" (123 mm) Depth: 4-1/2" (115 mm)
Weight	2.0 lbs. (0.9 kg)

■ Subwoofer/amplifier unit

Amplifier:

Power source	AC 120 V, 60 Hz
Power consumption	208 W
Dimensions	Width: 7-7/8" (200 mm) Height: 15" (380 mm) Depth: 17-1/2" (443 mm)
Weight	23.2 lbs. (10.5 kg)
Speaker terminals	Front speakers, center speaker and surround speakers: more than 4 ohms
Other terminals	System control × 2
Power output (FTC)	50 watts minimum RMS per channel into 4 ohms from 150 Hz to 20 kHz, 10% total harmonic distortion Subwoofer: 50 watts minimum RMS into 4 ohms from 20 Hz to 150 Hz, 10% total harmonic distortion
Rated power output	Front: 50 W + 50 W, Center: 50 W, Surround: 50 W + 50 W (4 ohms at 1 kHz, 10 % T.H.D.) Subwoofer: 50 W (4 ohms at 100 Hz, 10 % T.H.D.)

Subwoofer:

Type	Bass reflex, 1 way system 6-1/2" (16 cm) woofer × 1
Maximum input power	100 W
Rated input power	50 W
Impedance	4 ohms

CONSUMER LIMITED WARRANTY

SHARP ELECTRONICS CORPORATION warrants to the first consumer purchaser that this Sharp brand product (the "Product"), when shipped in its original container, will be free from defective workmanship and materials, and agrees that it will, at its option, either repair the defect or replace the defective Product or part thereof with a new or remanufactured equivalent at no charge to the purchaser for parts or labor for the period(s) set forth below.

This warranty does not apply to any appearance items of the Product nor to the additional excluded item(s) set forth below nor to any Product the exterior of which has been damaged or defaced, which has been subjected to improper voltage or other misuse, abnormal service or handling, or which has been altered or modified in design or construction.

In order to enforce the rights under this limited warranty, the purchaser should follow the steps set forth below and provide proof of purchase to the servicer.

The limited warranty described herein is in addition to whatever implied warranties may be granted to purchasers by law. ALL IMPLIED WARRANTIES INCLUDING THE WARRANTIES OF MERCHANTABILITY AND FITNESS FOR USE ARE LIMITED TO THE PERIOD(S) FROM THE DATE OF PURCHASE SET FORTH BELOW. Some states do not allow limitations on how long an implied warranty lasts, so the above limitation may not apply to you.

Neither the sales personnel of the seller nor any other person is authorized to make any warranties other than those described herein, or to extend the duration of any warranties beyond the time period described herein on behalf of Sharp.

The warranties described herein shall be the sole and exclusive warranties granted by Sharp and shall be the sole and exclusive remedy available to the purchaser. Correction of defects, in the manner and for the period of time described herein, shall constitute complete fulfillment of all liabilities and responsibilities of Sharp to the purchaser with respect to the Product, and shall constitute full satisfaction of all claims, whether based on contract, negligence, strict liability or otherwise. In no event shall Sharp be liable, or in any way responsible, for any damages or defects in the Product which were caused by repairs or attempted repairs performed by anyone other than an authorized servicer. Nor shall Sharp be liable or in any way responsible for any incidental or consequential economic or property damage. Some states do not allow the exclusion of incidental or consequential damages, so the above exclusion may not apply to you.

THIS WARRANTY GIVES YOU SPECIFIC LEGAL RIGHTS. YOU MAY ALSO HAVE OTHER RIGHTS WHICH VARY FROM STATE TO STATE.

Model Specific Section

Your Product Model Number & Description:

HT-X1 Home Theater with DVD

(Be sure to have this information available when you need service for your Product.)

Warranty Period for this Product:

One (1) year parts and labor from the date of purchase.

Additional Item(s) Excluded from Warranty Coverage (if any):

Non-functional accessories, supplies, and consumable items.

Where to Obtain Service:

At a Sharp Authorized Servicer located in the United States.

To find a location of the nearest Sharp Authorized Servicer, call Sharp toll free at 1-800-BE-SHARP.

What to do to Obtain Service:

Ship prepaid or carry in your Product to a Sharp Authorized Servicer.

Be sure to have **Proof of Purchase** available. If you ship the Product, be sure it is insured and packaged securely.

TO OBTAIN SUPPLY, ACCESSORY OR PRODUCT INFORMATION, CALL **1-800-BE-SHARP**.

SHARP

SHARP ELECTRONICS CORPORATION

Sharp Plaza, Mahwah, New Jersey 07430-2135

SHARP CORPORATION

Printed in China
TINSEA050SJZZ
05B N HK ①

Free Manuals Download Website

<http://myh66.com>

<http://usermanuals.us>

<http://www.somanuals.com>

<http://www.4manuals.cc>

<http://www.manual-lib.com>

<http://www.404manual.com>

<http://www.luxmanual.com>

<http://aubethermostatmanual.com>

Golf course search by state

<http://golfingnear.com>

Email search by domain

<http://emailbydomain.com>

Auto manuals search

<http://auto.somanuals.com>

TV manuals search

<http://tv.somanuals.com>