

SHARP®

Carousel™ MICROWAVE OVEN

J

**MODELS R-222T(W)
R-201T(W)**

OPERATION MANUAL and COOKING GUIDE

CONTENTS	Pages
Warranty	1
Warning	2
Special Notes and Warning	3
Installation Instructions	4
Oven Diagram	4
Operation of Control Panel	5
Control Panel Display	5
Touch Control Panel Layout	5
Before Operating	6
Getting Started	6
Clock Setting	6
Stop/Clear	6
To Cancel a Programme During Cooking	6
Manual Operations	7
Microwave Time Cooking	7
Sequence Cooking	8
Instant Cook™	8
Increasing Time During a Cooking Programme	9
Automatic Operations	10
Notes for Automatic Operations	10
Instant Action	10
Express Defrost	11
Easy Defrost	12
Other Convenient Features	13
Less/More Setting	13
Timer	14
Child Lock	14
Demonstration Mode	14
Alarm	14
Care and Cleaning	15
Service Call Check	15
Specifications	15
Cooking Guides	①~⑧

Thank you for buying a Sharp Microwave Oven. Please keep this operation manual handy, as it describes all the features of your oven and will enable you to cook many varieties of foods.

The manual is divided into two sections:

1. OPERATION (P2~P15)

This section describes your oven and teaches you how to use all the features.

2. COOKING GUIDES

This section is at the back of the manual, it contains the more commonly used information such as how to prepare food, which cooking utensil to use, standing time.

It also contains recipes for automatic cooking and manual cooking.

Please take some time to read your operation manual carefully, paying particular attention to the warnings and special notes, the automatic cooking menus programmed into your new oven have been carefully developed to give optimum results when the step by step instructions are followed.

When selecting another home appliance, please again consider our full range of Sharp products.

SHARP WARRANTY

Consumer Electronic Products Congratulations on Your Purchase!

This Sharp product is warranted against faults in materials and manufacture for a period of twelve(12) months from the date of original purchase.

If service is required during the warranty period, please contact your nearest Sharp Approved Service Centre. These repairs would be carried out at no charge to the owner, subject to the conditions specified herein.

The owner is responsible for any transportation and insurance costs if the product has to be returned for repair.

This warranty does not extend to accessories or defects or injuries caused by or resulting from causes not attributable to faulty parts or the manufacture of the product, including but not limited to, defect or injury caused by or resulting from misuse, abuse, neglect, accidental damage, improper voltage, liquid spillage, vermin infestation, software, or any alterations made to the product which are not authorised by Sharp.

Please retain your sales documentation, as this should be produced to validate a warranty claim.

This warranty is in addition to and in no way limits, varies or excludes any express and implied rights and remedies under any relevant legislation in the country of sale.

IMPORTANT

DO NOT RETURN THIS DOCUMENT TO SHARP

For your reference, please enter the particulars of your purchase below and retain, with your purchase documentation.

Model No. _____
Serial No. _____
Date of Purchase _____
Retailer _____

SHARP
SHARP CORPORATION OF AUSTRALIA PTY. LIMITED
ABN 40 003 039 405
1 Hummingwood Drive
Huntingwood NSW 2148
SHARP CORPORATION OF NEW ZEALAND LIMITED
59 Hugo Johnston Drive
Penrose, Auckland

IMPORTANT NOTICE: This warranty applies only to products sold in Australia & New Zealand

SHARP

FOR LOCATION ENQUIRIES WITHIN

AUSTRALIA

REGARDING YOUR LOCAL

SHARP APPROVED SERVICE CENTRE

VISIT OUR WEBSITE AT

www.sharp.net.au

OR CALL SHARP CUSTOMER CARE

1300 135 022

(LOCAL CALL COST APPLY WITHIN AUSTRALIA)

SHARP CORPORATION OF AUSTRALIA PTY LTD

SHARP

FOR LOCATION ENQUIRIES WITHIN

NEW ZEALAND

REGARDING YOUR LOCAL

SHARP APPROVED SERVICE CENTRE

VISIT OUR WEBSITE AT

www.sharp.net.nz

CONTACT YOUR SELLING DEALER/RETAILER
OR CALL

SHARP CUSTOMER SERVICES

TELEPHONE: 09 573 0111

FACSIMILE: 09 573 0113

SHARP CORPORATION OF NEW ZEALAND LIMITED

WARNING

IMPORTANT SAFETY INSTRUCTIONS : READ CAREFULLY AND KEEP FOR FUTURE REFERENCE.

To reduce the risk of fire in the oven cavity:

- a. Do not overcook food.
- b. Remove wire twist-ties from paper or plastic bags before placing bag in the oven.
- c. Do not heat oil or fat for deep frying. The temperature of the oil cannot be controlled.
- d. Look at the oven from time to time when food is heated in disposable containers made of plastic, paper or other combustible materials for signs of smoke or burning.
- e. If materials inside the oven should ignite, or smoke is observed, keep oven door closed, turn oven off, and disconnect the power plug, or shut off power at the fuse or circuit breaker panel.

To reduce the risk of an explosion or delayed eruptive boiling when handling the container.

Your microwave oven is capable of heating food and beverages very quickly therefore, it is very important that you select the appropriate cooking time and power level for the type and quantity of food to be heated. If you are unsure of the cooking time and power level required, begin with low cooking times and power levels until the food is sufficiently heated evenly throughout.

Additionally:

- a. Do not place sealed containers in the oven. Babies bottles fitted with a screw cap or teat are considered to be sealed containers.
- b. Do not use excessive amount of time.
- c. When boiling liquids in the oven, use a wide-mouthed container.
- d. Stand at least for 20 seconds at the end of cooking to avoid delayed eruptive boiling of liquids.
- e. Stir the liquid before and during cooking. Use extreme care when handling the container or inserting a spoon or other utensil into the container.

This oven is for home food preparation only and should only be used for heating, cooking and defrosting food and beverage.

It is not suitable for commercial, laboratory use, or heating therapeutic devices eg. Wheat bags.

Never operate the oven whilst any object is caught or jammed between the door and the oven.

Do not try to adjust or repair the oven yourself.

It is hazardous for anyone other than a qualified service technician trained by SHARP to carry out any service or repair operation. Especially those which involve the removal of a cover which gives protection against exposure to microwave energy are very hazardous.

Do not operate the oven if it is not working correctly or damaged until it has been repaired by a qualified service technician trained by SHARP. It is particularly important that the oven door closes properly and that there is no damage to:

(1) Door (warped), (2) Hinges and Latches (broken or loosened), (3) Door Seals, Sealing Surfaces and oven cavity (buckled or deformed), (4) Burn marks on the door seal faces.

Do not bump, or catch utensils, loose clothes and your accessories on the door safety latches when removing food from the oven.

Never poke an object, particularly a metal object, through a grille or between the door and the oven while the oven is operating.

Never tamper with or deactivate the door safety latches.

Always use oven gloves to prevent burns when handling utensils that are in contact with hot food. Enough heat from the food can transfer through utensils to cause skin burns.

Should the power supply cord become damaged, it must be replaced with a special cord supplied by a SERVICE CENTRE APPROVED BY SHARP and it must be replaced by a qualified service technician trained by SHARP in order to avoid a hazard.

If the oven lamp fails please consult your dealer or a qualified service technician trained by SHARP.

Avoid steam burns by directing steam away from the face and hands.

Slowly lift the furthest edge of a dish's cover including microwave plastic wrap etc., and carefully open popcorn and oven cooking bags away from the face.

Make sure that the power supply cord is undamaged, and that it does not run under the oven or over any hot surfaces or sharp edges.

To prevent the turntable from breaking:

- a. Before cleaning the turntable with water, leave the turntable to cool.
- b. Do not place anything hot on a cold turntable.
- c. Do not place anything cold on a hot turntable.

Do not place anything on the outer cabinet.

Do not store food or any other items inside the oven.

Make sure the utensil does not touch the interior walls during cooking.

Only allow children to use the oven without supervision when adequate instructions have been given so that the child is able to use the oven in a safe way and understands the hazards of improper use.

This appliance is not intended for use by persons (including children) with reduced physical, sensory or mental capabilities, or lack of experience and knowledge, unless they have been given supervision or instruction concerning use of the appliance by a person responsible for their safety.

Children should be supervised to ensure that they do not play with the appliance.

SPECIAL NOTES AND WARNING

	DO	DON'T
Eggs, fruits, vegetables, nuts, seeds, sausages and oysters	<ul style="list-style-type: none"> * Puncture egg yolks and whites and oysters before cooking to prevent "explosion". * Pierce skins of potatoes, apples, squash, hot dogs, sausages and oysters so that steam escapes. 	<ul style="list-style-type: none"> * Cook eggs in shells. This prevents "explosion", which may damage the oven or injure yourself. * Cook hard/soft boiled eggs. * Overcook oysters. * Dry nuts or seeds in shells.
Popcorn	<ul style="list-style-type: none"> * Use specially bagged popcorn for the microwave oven. * Listen while popping corn for the popping to slow to 1-2 seconds. 	<ul style="list-style-type: none"> * Pop popcorn in regular brown bags or glass bowls. * Exceed maximum time on popcorn package.
Baby food	<ul style="list-style-type: none"> * Transfer baby food to small dish and heat carefully, stirring often. Check for suitable temperature to prevent burns. * Remove the screw cap and teat before warming baby bottles. After warming shake thoroughly. Check for suitable temperature. 	<ul style="list-style-type: none"> * Heat disposable bottles. * Overheat baby bottles. Only heat until warm. * Heat bottles with nipples on. * Heat baby food in original jars.
General	<ul style="list-style-type: none"> * Food with filling should be cut after heating, to release steam and avoid burns. * Use a deep bowl when cooking liquids or cereals to prevent boiling over. 	<ul style="list-style-type: none"> * Heat or cook in closed glass jars or airtight containers. * Deep fat fry. * Heat or dry wood, herbs, wet papers, clothes or flowers. * Operate the oven without a load (i.e. an absorbing material such as food or water) in the oven cavity.
Liquids (Beverages)	<ul style="list-style-type: none"> * For boiling or cooking liquids see WARNING on page 2 to prevent explosion and delayed eruptive boiling. 	<ul style="list-style-type: none"> * Heat for longer than recommended time. See REHEATING-FOOD CHART on page ⑧.
Canned foods	<ul style="list-style-type: none"> * Remove food from can. 	<ul style="list-style-type: none"> * Heat or cook food while in cans.
Sausage rolls, Pies, Christmas pudding	<ul style="list-style-type: none"> * Cook for the recommended time. (These foods have high sugar and/or fat contents.) 	<ul style="list-style-type: none"> * Overcook as they may catch fire.
Meats	<ul style="list-style-type: none"> * Use a microwave proof roasting rack to collect drained juices. 	<ul style="list-style-type: none"> * Place meat directly on the turntable for cooking.
Utensils	<ul style="list-style-type: none"> * Check the utensils are suitable for MICROWAVE cooking before you use them. 	<ul style="list-style-type: none"> * Use metal utensils for MICROWAVE cooking. Metal reflects microwave energy and may cause an electrical discharge known as arcing.
Aluminium foil	<ul style="list-style-type: none"> * Use to shield food to prevent over cooking. * Watch for sparking. Reduce foil or keep clear of cavity walls. 	<ul style="list-style-type: none"> * Use too much. * Shield food close to cavity walls. Sparking can damage the cavity.
Browning dish	<ul style="list-style-type: none"> * Place a suitable insulator such as a microwave and heat proof dinner plate between the turntable and the browning dish. 	<ul style="list-style-type: none"> * Exceed the preheating time recommended by the manufacturer. Excessive preheating can cause the glass turntable to shatter and/or damage internal parts of the oven.

INSTALLATION INSTRUCTIONS

1. Remove all packing materials from the oven cavity, **(do not remove the waveguide cover)**, and the feature sticker from the outside of the door, if there is one. Check the unit for any damage, such as a misaligned door, damaged door seals around the door or dents inside the oven cavity or on the door. If there is any damage, please do not operate the oven until it has been checked by a SERVICE CENTRE APPROVED BY SHARP and repaired, if necessary.
2. Accessories provided
 - 1) Turntable
 - 2) Roller stay
 - 3) Operation manual and Cooking guide
3. Place the roller stay in the coupling on the oven floor, then place the turntable on to the roller stay, ensuring it is located firmly. Refer to OVEN DIAGRAM below. NEVER operate the oven without the roller stay and turntable.
4. This oven is designed for countertop or cabinet use as well. It should not be installed in any area where excessive heat and steam are generated, for example, next to a conventional oven unit. The oven should be installed so as not to block ventilation openings. Allow a space of at least 10 cm on the top, 5 cm on both sides and at the rear of the oven for adequate air circulation. When installing in a cabinet, the minimum inside dimension of the cabinet should be 560 mm (W) x 375 mm (H) x 418 mm (D). This oven is not designed for built-in installation.
WARNING: The electrical outlet must be readily accessible so that the unit can be unplugged easily in an emergency.
5. Neither the manufacturer nor the distributors can accept any liability for damage to the machine or personal injury for failure to observe the correct electrical connecting procedure.
The A.C. voltage must be single phase 230 – 240V, 50Hz.
6. This appliance must be earthed.
7. Operate the oven from a general purpose domestic outlet.
If a generator is used, do not operate the oven with non-sinusoidal outputs.

OVEN DIAGRAM

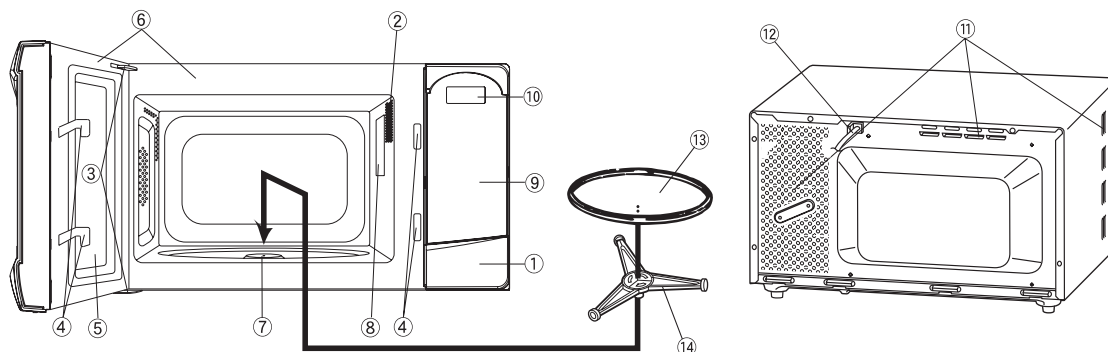

1. Door open button
2. Oven lamp
3. Door hinges
4. Door safety latches
5. See through door
6. Door seals and sealing surfaces
7. Coupling
8. Waveguide cover (Do not remove)
9. Touch control panel (See page 5)
10. Liquid crystal display
11. Ventilation openings
12. Power supply cord
13. Turntable
14. Roller stay

OPERATION OF CONTROL PANEL

The operation of the oven is controlled by pressing the appropriate pads arranged on the surface of the control panel.

An entry signal tone should be heard each time you press the control panel to make a correct entry.

In addition the oven will beep for approximately 2 seconds at the end of the cooking cycle, or 4 times when cooking procedure is required.

Control Panel Display



Touch Control Panel Layout

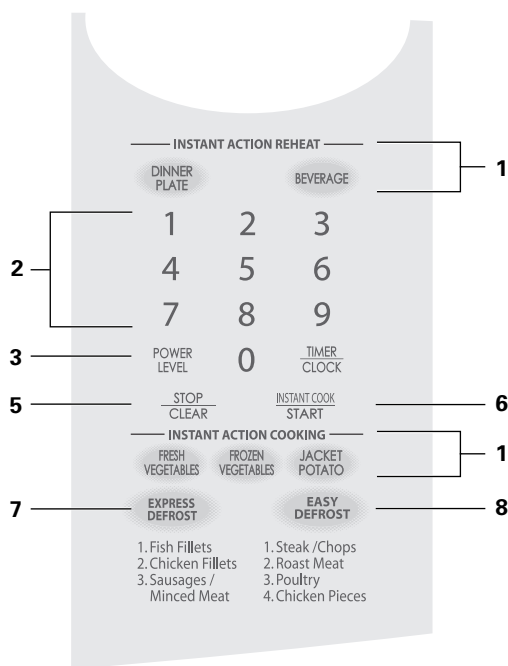

R-201T(W)

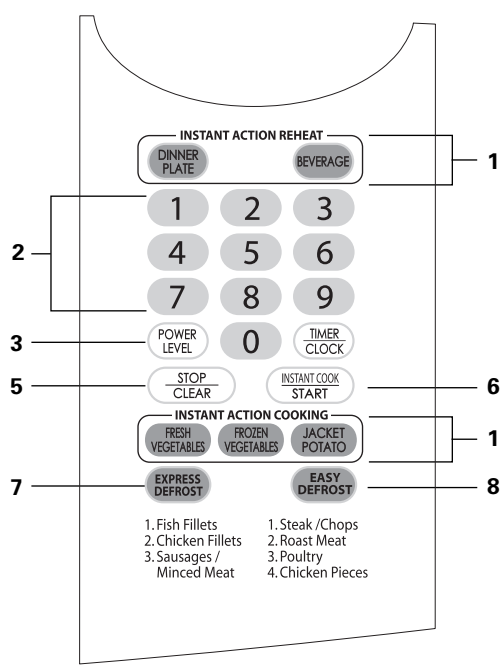



R-222T(W)

- | | | |
|------------------------------------------------------------------------------------------------------------------------------------------------------------------------------------------------------------------------------------------------------------------------------------------------------------------------------------------------------------------------------------------------------------------------------|-------------------------------------------------------------------------------------------------------------------------------------------------------------------------------------------------------------------------------------------------------------------------------------------------------------------------|--------------------------------------------------------------------------------------------------------------------------------------------------------------------------------------------------------------------------------------------------------------------------------------------------------------------------------------------------------------------------------------------------------------------------------------|
| <ol style="list-style-type: none"> 1. INSTANT ACTION PADS
Press to cook or reheat 5 popular menus. 2. NUMBER PADS
Press to enter cooking time, clock time, weight of food. 3. POWER LEVEL PAD
Press to select microwave power setting.
If not pressed, 100% is automatically selected.
Press to alter the cooking result for automatic operations. | <ol style="list-style-type: none"> 4. TIMER/CLOCK PAD
Press to set clock, timer, child lock or demonstration mode. 5. STOP/CLEAR PAD
Press to clear during programming.
Press once to stop operation of oven during cooking; press twice to cancel cooking programme. | <ol style="list-style-type: none"> 6. INSTANT COOK/START PAD
Press once to cook for 1 minute at 100% or increase by 1 minute multiples each time this pad is pressed during cooking.
Press to start oven after setting programmes. 7. EXPRESS DEFROST PAD
Press to select the Express Defrost menu. 8. EASY DEFROST PAD
Press to select the Easy Defrost menu. |
|------------------------------------------------------------------------------------------------------------------------------------------------------------------------------------------------------------------------------------------------------------------------------------------------------------------------------------------------------------------------------------------------------------------------------|-------------------------------------------------------------------------------------------------------------------------------------------------------------------------------------------------------------------------------------------------------------------------------------------------------------------------|--------------------------------------------------------------------------------------------------------------------------------------------------------------------------------------------------------------------------------------------------------------------------------------------------------------------------------------------------------------------------------------------------------------------------------------|



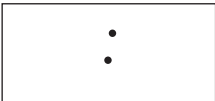

BEFORE OPERATING

Getting Started

Step	Procedure	Pad Order	Display
1	Ensure the oven door is closed. Plug the oven into a power point and switch on the power.		 Flashing eights.
2	Press the STOP/CLEAR pad so that the oven beeps.		 Only the dots will remain.

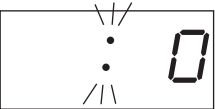
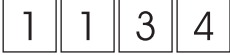
Clock Setting

* To enter the present time of day 11:34 (AM or PM).

Step	Procedure	Pad Order	Display
1	Press the TIMER/CLOCK pad.		 The dots (:) will flash on and off.
2	Enter the correct time of day by pressing the numbers in sequence.		
3	Press the TIMER/CLOCK pad again.		

This is a 12 hour clock. If you attempt to enter an incorrect clock time (eg. 13:45),  will appear in the display.

Press the STOP/CLEAR pad and re-enter the time of day (eg. 1:45).

If you wish to know the time of day during the cooking or timer mode, press the TIMER/CLOCK pad. As long as your finger is pressing the TIMER/CLOCK pad, the time of day will be displayed.

Stop/Clear

Press the STOP/CLEAR pad once to:

1. Stop the oven temporarily during cooking.
2. Clear if you make a mistake during programming.

To Cancel a Programme During Cooking

Press the STOP/CLEAR pad twice.

MANUAL OPERATIONS

Microwave Time Cooking

This is a manual cooking feature, first enter the cooking time then the power level. There are five different power levels. You can programme up to 99 minutes, 99 seconds.

Power level	10% (LOW)	30% (MEDIUM LOW)	50% (MEDIUM)	70% (MEDIUM HIGH)	100% (HIGH)
Display	10P	30P	50P	70P	100P
Examples of foods typically cooked on microwave oven power level	Keeping food warm	Defrost, Softening butter	Casseroles Seafood	Cakes Muffins Slices	Vegetables Rice/Pasta Fruit

This variable cooking control allows you to select the rate of microwave cooking.

If a power level is not selected, then 100% power is automatically used.

* Suppose you want to time cook for 2 minutes 30 seconds on 100% power.

Step	Procedure	Pad Order	Display
1	Enter desired cooking time.	2 3 0	2.30
2	Press the INSTANT COOK/START pad.	INSTANT COOK START	2.30 COOK The timer begins to count down.

To lower the power press the POWER LEVEL pad until desired power level is displayed.

* Suppose you want to cook Fish Fillets for 10 minutes on 50% power.

Step	Procedure	Pad Order	Display
1	Enter desired cooking time.	1 0 0 0	10.00
2	Select power level by pressing the POWER LEVEL pad as required (for 50% press three times).	POWER LEVEL x 3	50P
3	Press the INSTANT COOK/START pad.	INSTANT COOK START	10.00 COOK The timer begins to count down.

If the door is opened during cooking process, the cooking time in the display automatically stops. The cooking time starts to count down again when the door is closed and the INSTANT COOK/START pad is pressed.

If you wish to know the power level during cooking, press the POWER LEVEL pad. As long as your finger is pressing the POWER LEVEL pad, the power level will be displayed.

If more than 20 minutes on 100% power is entered, the microwave power will be reduced after 20 minutes to avoid overheating.

Sequence Cooking

Your oven can be programmed with up to 3 automatic cooking sequences, automatically switching from one variable power setting to the next.

* Suppose you want to cook for 10 minutes on 50% followed by 5 minutes on 100%.

Step	Procedure	Pad Order	Display
1	Enter desired cooking time.	1 0 0 0	10.00
2	Select desired power level by pressing the POWER LEVEL pad (for 50% press three times).	POWER LEVEL x 3	5 0 P
3	For second sequence, enter desired time for cooking time. If power is not selected the oven will operate at 100% power.	5 0 0	5.00
4	Press the INSTANT COOK/START pad.	INSTANT COOK START	<div style="display: flex; flex-direction: column; align-items: center;"> <div style="display: flex; align-items: center;"> <div style="margin-right: 5px;">COOK</div> <div style="font-size: 2em;">10.00</div> </div> <div style="margin: 5px 0;">The timer begins to count down to zero. When it reaches zero,</div> <div style="display: flex; align-items: center;"> <div style="margin-right: 5px;">COOK</div> <div style="font-size: 2em;">5.00</div> </div> <div style="margin: 5px 0;">the second sequence will appear and the timer will begin counting down to zero again.</div> </div>

Instant Cook™

For your convenience Sharp's Instant Cook allows you to easily cook for one minute on 100% power.

Step	Procedure	Pad Order	Display
1	Press the INSTANT COOK/START pad. Within 3 minutes of closing the door.	INSTANT COOK START	<div style="display: flex; align-items: center;"> <div style="margin-right: 5px;">COOK</div> <div style="font-size: 2em;">1.00</div> </div> <div style="margin-top: 5px;">The timer begins to count down.</div>

Press the INSTANT COOK/START pad until desired time is displayed.
Each time the pad is pressed, the cook time is increased by 1 minute.

Increasing Time During a Cooking Programme



Microwave time can be added during a cooking programme using the INSTANT COOK/START pad.

* Suppose you want to increase the cooking time by 2 minutes during 5 minutes on 50% power cooking. (at the moment the remaining cooking time is 1 min. 30 sec.)

Step	Procedure	Pad Order	Display
1	Enter desired cooking time.	5 0 0	5.00
2	Select power level by pressing the POWER LEVEL pad as required (for 50% press three times).	POWER LEVEL x 3	5 0P
3	Press the INSTANT COOK/START pad.	INSTANT COOK START	5.00 COOK The timer starts to count down. 1.30 COOK
4	Press the INSTANT COOK/START pad twice to increase the cooking time by two minutes.	INSTANT COOK START x 2	3.30 COOK

AUTOMATIC OPERATIONS







Notes for Automatic Operations

- When using the automatic features, carefully follow the instructions provided in each MENU GUIDE to achieve the best result.
If the instructions are not followed carefully, the food may be overcooked or undercooked or  may be displayed.
- Food weighing more or less than the quantity or weight listed in each MENU GUIDE, cook manually. Refer to manual cooking charts in RECIPES section.
- To change the final cooking or defrosting result from the standard setting, press the POWER LEVEL pad once (for more) or twice (for less) after selecting desired setting. Refer to page 13.
- The final cooking result will vary according to the food condition (e.g. initial temperature, shape, quality). Check the food after cooking and if necessary continue cooking manually.
- To avoid children's misuse, each INSTANT ACTION pad can be used only within 3 minutes of a preceding operation.
- To defrost foods above or below the weights allowed on the EXPRESS DEFROST MENU GUIDE, use EASY DEFROST or defrost manually.
-  will be displayed if:
more or less than weight of foods suggested in EASY DEFROST MENU GUIDE is programmed when the INSTANT COOK/START pad is pressed.
To clear, press the STOP/CLEAR pad and reprogramme.
- When entering the weight of the food, round off the weight to the nearest 0.1 kg (100 g). For example, 1.35 kg would become 1.4 kg.

Instant Action

The Instant Action allows you to cook or reheat several popular foods. Follow the instructions provided in the INSTANT ACTION MENU GUIDE on page ④ of the cooking guides.

* Suppose you want to cook 1 Jacket Potato.

Step	Procedure	Pad Order	Display
1	Press the JACKET POTATO pad until desired quantity is displayed (for 1 piece press once).	 x 1	 ↓ After about 2 sec.  The cooking time will begin counting down. The oven will "beep" 4 times and stop. COOK indicator will go off and CHECK will flash on and off.
2	Open the door. Turn over potatoes. Close the door.		 CHECK will be flashing
3	Press the INSTANT COOK/START pad.		 The cooking time will begin counting down. When it reaches zero, the oven will "beep".

Express Defrost







1. Fish Fillets
2. Chicken Fillets
3. Sausages / Minced Meat

**EXPRESS
DEFROST**

EXPRESS DEFROST rapidly defrosts 0.5 kg of specific foods.

Follow the instructions provided in the EXPRESS DEFROST MENU GUIDE on page ⑤ of the cooking guides.

* Suppose you want to defrost 0.5 kg of Chicken Fillets.

Step	Procedure	Pad Order	Display
1	Press the EXPRESS DEFROST pad until the desired menu number is displayed (for Chicken Fillets press twice).	 x 2	
2	Press the INSTANT COOK/START pad.		 The defrosting time will begin counting down. The oven will "beep" 4 times and stop. COOK indicator will go off and CHECK will flash on and off.
3	Open the door. Remove defrosted pieces, turn over remaining pieces. Close the door.		 CHECK will be flashing.
4	Press the INSTANT COOK/START pad.		 The defrosting time will begin counting down. When it reaches zero, the oven will "beep".







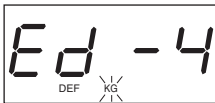

Easy Defrost

1. Steak / Chops
2. Roast Meat
3. Poultry
4. Chicken Pieces

**EASY
DEFROST**

EASY DEFROST will automatically compute the microwave power and defrosting time. Follow the instructions provided in the EASY DEFROST MENU GUIDE on page 6 of the cooking guides.

* Suppose you want to defrost 1.0 kg of Chicken Pieces.

Step	Procedure	Pad Order	Display
1	Press the EASY DEFROST pad until the desired menu number is displayed (for Chicken Pieces press four times).	 x 4	 KG will flash on and off.
2	Press the number pads to enter weight.		 KG stops flashing and remains on display
3	Press the INSTANT COOK/START pad.		 The defrosting time will begin counting down. The oven will "beep" 4 times and stop. COOK indicator will go off and CHECK will flash on and off.
4	Open the door. Remove defrosted pieces, turn over remaining pieces. Close the door.		 CHECK will be flashing.
5	Press the INSTANT COOK/START pad.		 The defrosting time will begin counting down. When it reaches zero, the oven will "beep".

OTHER CONVENIENT FEATURES

Less/More Setting



The cooking times programmed into the automatic menus are tailored to the most popular tastes. To adjust the cooking time to your individual preference use the "more" or "less" feature to either add (more) or reduce (less) cooking time.

The Less/More setting can be used to adjust the cooking time of the following features

- INSTANT ACTION
- EXPRESS DEFROST
- EASY DEFROST





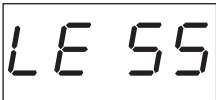

(1) INSTANT ACTION

* Suppose you want to reheat 1 cup of Beverage for less time than the standard setting.

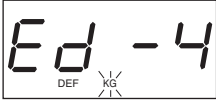
Step	Procedure	Pad Order	Display
1	Press the BEVERAGE pad once.	 x 1	
2	Press the POWER LEVEL pad twice within 2 seconds.	 x 2	

(2) EXPRESS DEFROST / EASY DEFROST

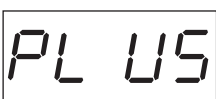
* Suppose you want to defrost 1.0 kg of Chicken Pieces (Easy Defrost) for more time than the standard setting.

Step	Procedure	Pad Order	Display
1	Press the EASY DEFROST pad four times for Chicken Pieces.	 x 4	
2	Press the number pads to enter weight.	 	
3	Press the POWER LEVEL pad once.	 x 1	
4	Press the INSTANT COOK/START pad.		

For EXPRESS DEFROST select the menu using the EXPRESS DEFROST pad instead of the EASY DEFROST pad in step 1, and go to step 3.

Timer

Use this feature as a general purpose timer. Examples include:
 timing boiled eggs cooked on the stove top.
 timing the recommended standing time of food.

You can enter any time up to 99 minutes, 99 seconds. If you want to cancel the timer during the count down phase simply press STOP/CLEAR and the display will return to showing the time of day.

* Suppose you want to set the timer for 3 minutes to boil an egg on the stove top.

Step	Procedure	Pad Order	Display
1	Enter desired time.	3 0 0	3.00
Once the egg has come to the boil in the saucepan you can start the timer.			
2	Press the TIMER/CLOCK pad .	TIMER CLOCK	3.00 The timer begins to count down. When the timer reaches zero, the oven will "beep". <code>End</code> will appear in the display.

Child Lock

If the oven is accidentally started with no food/liquid in the cavity, the oven could be damaged. To prevent accidents like this, your oven has a "Child Lock" feature that you can set when the oven is not in use.

To set the Child Lock, press the TIMER/CLOCK pad, press the number pad `1` and finally press the INSTANT COOK/START pad and hold for 3 seconds. `SAFE` will appear in the display. The Control Panel is now locked, each time a pad is pressed, the display will show "SAFE".

To unlock the control panel, press the TIMER/CLOCK pad, the number pad `1` and the STOP/CLEAR pad. The time of day is displayed and the oven is ready to use.

Demonstration Mode

This feature is mainly for use by retail outlets, and also allows you to practice the key operation.

To demonstrate, press the TIMER/CLOCK pad, press the number pad `0` and finally press the INSTANT COOK/START pad and hold for 3 seconds. `DISP` will appear in the display. Cooking operations can now be demonstrated with no power in the oven. For example, press INSTANT COOK/START pad, and the display will show `1:00` and count down to zero at ten times the speed. When the timer reaches zero, `End` will appear in the display.

To cancel, press the TIMER/CLOCK pad, the number pad `0` and the STOP/CLEAR pad.

Alarm

Your oven has an alarm function. If you leave food in the oven after cooking, the oven will "beep" 3 times after 2 minutes.

If you do not remove the food at that time, the oven will "beep" 3 times after 4 minutes and 6 minutes.



CARE AND CLEANING

Disconnect the power supply cord before cleaning or leave the door open to inactivate the oven.

CLEAN THE OVEN AT REGULAR INTERVALS - Keep the oven clean and remove any food deposits, or it could lead to deterioration of the surface. This could adversely affect the life of the appliance and possibly result in a hazardous situation.

Exterior:

The outside may be cleaned with mild soap and warm water, wipe clean with a damp cloth. Avoid the use of harsh abrasive cleaners. Keep the ventilation openings free of dust.

Door:

Wipe the door and window on both sides, the door seals and adjacent parts frequently with a damp cloth to remove any spills or spatters. Do not use abrasive cleaners.

Touch Control Panel:

Wipe the panel with a cloth dampened slightly with water only.

Do not scrub or use any sort of chemical cleaners. Avoid the use of excess water.

Interior walls:

To clean the interior surfaces, wipe with a soft cloth and warm water. After use wipe the waveguide cover in the oven with a soft damp cloth to remove any food splashes. Built-up splashes may overheat and begin to smoke or catch fire. Do not remove the waveguide cover. **DO NOT USE A COMMERCIAL OVEN CLEANER, ABRASIVE OR HARSH CLEANERS AND SCOURING PADS ON ANY PART OF YOUR MICROWAVE OVEN. NEVER SPRAY OVEN CLEANERS DIRECTLY ONTO ANY PART OF YOUR OVEN.**

Avoid using excess water. After cleaning the oven, ensure any water is removed with a soft cloth.

Turntable/Roller Stay:

Wash with mild soapy water and dry thoroughly.

SERVICE CALL CHECK

Please check the following before calling for service:

1. At the power point, switch off the power for 10 seconds and switch back on.
Does 88:88 appear in the display? YES _____ NO _____
2. Place one cup of water (approx. 250 ml) in a glass measure in the oven and close the door securely.
Press the INSTANT COOK/START pad twice.
 - A. Does the oven lamp come on? YES _____ NO _____
 - B. Does the cooling fan work? YES _____ NO _____
(Put your hand over the rear ventilation openings.)
 - C. Does the turntable rotate? YES _____ NO _____
(The turntable can rotate clockwise or counterclockwise. This is quite normal.)
 - D. After two minutes, did an audible signal sound and COOK indicator go off? YES _____ NO _____
 - E. Is the water inside the oven hot? YES _____ NO _____

If "NO" is the answer to any of the above questions, please check your wall socket and the fuse in your meter box. If both the wall socket and the fuse are functioning properly, CONTACT YOUR NEAREST SERVICE CENTRE APPROVED BY SHARP.

- NOTE:
1. If time in the display is counting down rapidly, check Demonstration Mode (See page 14 for detail).
 2. If you cook the food over 20 minutes on 100 % power, the microwave power will be automatically reduced to avoid overcooking.

SPECIFICATIONS

AC Line Voltage	Single phase 230–240V, 50Hz
AC Power Required	1.22 kW
Output Power	800 W* (IEC test procedure)
Microwave Frequency	2450 MHz (Class B/Group 2)**
Outside Dimensions (W x H x D)	460mm x 275mm x 368mm
Depth with the door open	697mm
Cooking Uniformity	Turntable (ø272mm tray) system
Weight	Approx. 12 kg

* When tested in accordance with AS/NZS 2895.1:2007

** This is the classification of ISM (Industrial, Scientific and Medical) equipment described in the International Standard CISPR11.



FROZEN VEGETABLE CHART

1. Cook vegetables in a flan dish. Cover with a lid or plastic wrap.
2. Allow to stand 1-2 minutes before serving.

VEGETABLE	WEIGHT	MICROWAVE TIME AT 100%	SPECIAL PROCEDURES
Beans (green, cut)	250 g	5-6 minutes	
Broccoli	500 g	8-10 minutes	Break apart as soon as possible. Arrange with flower towards the centre.
Brussels sprouts	500 g	7-9 minutes	
Carrots (whole)	500 g	8-9 minutes	
(sliced)	500 g	8-9 minutes	
Cauliflower	500 g	8-10 minutes	Break apart as soon as possible. Arrange with flower towards the centre.
Corn (on cob)	4 pieces (500 g)	8-10 minutes	Add 1/2 cup water and 1 teaspoon sugar. Turn 1/2 way during cooking.
(kernel)	250 g	3-5 minutes	Add 3 tablespoons water and 1 teaspoon of butter.
Peas (green)	250 g	4-6 minutes	
Spinach	250 g	5-6 minutes	
Mixed Vegetables	250 g	4-5 minutes	Break apart as soon as possible.

REHEATING-FOOD CHART

FOOD	WEIGHT	COOKING TIME AND POWER LEVEL	SPECIAL INSTRUCTIONS
Beverage 250 ml per cup (room temp.)	1 cup 2 cups	1 1/2-2 1/2 minutes on 100% 3 1/2-4 minutes on 100%	Stir after reheating.
Canned food (eg. Spaghetti, Baked Beans) (room temp.)	440 g can 740 g can	9-10 minutes on 50% 10-11 minutes on 50%	Place food in bowl. Cover with plastic wrap or lid. Stir halfway through cooking. Stir after reheating.
Canned Soup 250 ml per cup (room temp.)	1 cup 2 cups	2-2 1/2 minutes on 100% 5-6 minutes on 100%	Place food in bowl. Cover with plastic wrap or lid. Stir after reheating.
Dinner Plate-400 g per serve (refrigerated)	1 serve	7-8 minutes on 50%	Cover plate with plastic wrap. Place directly on turntable. Stand 2 minutes. * Slice potato.
Casserole 250 g per serve (refrigerated)	1 serve 2 serves	8-9 minutes on 50% 12-15 minutes on 50%	Place in a casserole dish, cover with lid. Place directly on turntable. Stir halfway through cooking. Stand 2-3 mins.



NOTE: Room Temperature +20°C
Refrigerator Temperature +3°C

FRESH VEGETABLE CHART

VEGETABLE	AMOUNT	COOKING PROCEDURE	MICROWAVE TIME AT 100%
Artichokes	2 medium	Trim. Rinse well. Place onto a dinner plate. Cover with plastic wrap.	3½-5 minutes
* Asparagus	250 g	Wash and place in a freezer bag.	2-3 minutes
Beans	250 g	Cut into 4 cm pieces. Cook in 1-litre casserole dish with 1 tablespoon water. Cover.	3-4 minutes
* Broccoli	500 g	Cut into uniform florets. Arrange with flower towards centre in a pie plate. Cover with plastic wrap.	6-7 minutes
Brussels sprouts	500 g	Arrange in a pie plate. Arrange with stalk towards outside. Cover with plastic wrap.	3-4 minutes
* Cabbage	250 g	Shred and cook in a 1.5-litre casserole dish with 2 tablespoons water. Cover.	3-5 minutes
* Carrots	250 g	Cut carrots into circular pieces and place into a 1-litre casserole dish with 1 tablespoon of water. Cover.	3-4 minutes
* Cauliflower	500 g	Cut into uniform florets. Arrange with flower towards centre in a pie plate with 1 tablespoon water. Cover with plastic wrap.	4-5 minutes
Chokos	500 g (2)	Peel, cut into quarters. Place in a pie plate with 1 tablespoon of water. Cover with plastic wrap.	6-7 minutes
* Corn (on cob)	2	Arrange in a pie plate with ¼ cup water. Cover with plastic wrap.	7-9 minutes
	4	Arrange in a pie plate with ⅓ cup water. Cover with plastic wrap.	14-15 minutes
Eggplant	500 g	Cut into 2 cm cubes. Place in a 1-litre casserole dish with 2 tablespoons water. Cover.	4-5 minutes
* Mushrooms	500 g	Sliced or whole. Place in a 1-litre casserole dish with 2 teaspoons butter. Cover.	5-7 minutes
Peas - Green	500 g	Cook in a 1-litre casserole dish with 1 teaspoon sugar and 1 tablespoon water. Cover.	2-4 minutes
- Snow	250 g	Remove string from pod. Cook in a 1-litre casserole dish with 1 tablespoon water.	2½-3½ minutes
* Potatoes (jacket)	2 medium 4 small	Pierce skin with a fork. Place on turntable. Turn over halfway through cooking. Stand wrapped in foil for 2-3 minutes.	4-6 minutes
(steamed)	2 medium 4 small	Peel and cube potatoes. Cook, covered, in a 1-litre casserole dish with ½ cup water.	5-7 minutes
* Pumpkin	500 g	Peel and cut into serving-size pieces. Place in a 1-litre casserole dish. Cover.	5-7 minutes
Spinach	250 g	Wash and shred. Cook, covered, in a 1.5-litre casserole dish with 2 tablespoons water.	3-5 minutes
* Squash	250 g	Wash and place in a 1 litre casserole dish with 1 tablespoon of butter or water. Cover. Pierce whole squash with a fork.	4-5 minutes
Sweet Potato	500 g	Peel and cube potatoes. Cook, covered, in a 1-litre casserole dish with ½ cup water.	5-7 minutes
Tomatoes	500 g	Cut into quarters. Place in a 1-litre casserole dish. Season and cover.	4-5 minutes
* Zucchini	250 g	Cut into uniform-size pieces. Place in a 1-litre casserole dish with 1 tablespoon water and 1 tablespoon butter. Cover.	3½-5 minutes

*Stand vegetables for 1-2 minutes before serving.

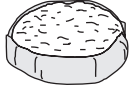
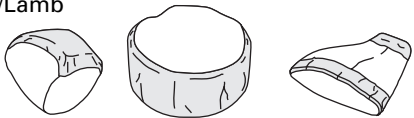
EASY DEFROST MENU GUIDE

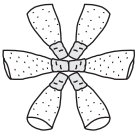
NO.	Menu	Quantity (kg's)	Procedure	⌚ Standing Time (minutes)
1	Steak Chops 	0.1 – 1.5	<ul style="list-style-type: none"> • Shield thin end of chops or steaks with foil. • Position the food with thinner parts in the centre in a single layer on the defrost rack. If pieces are stuck together, try to separate as soon as possible. • The oven will “beep” and stop, CHECK will flash on and off. Remove defrosted pieces, turn over and shield the warm portion of remaining pieces. • Press start to continue defrosting. • After defrost time, stand covered with aluminium foil. 	5 - 20
	Minced Meat Beef 	0.1 – 1.5	<ul style="list-style-type: none"> • Place frozen minced meat on a defrost rack. Shield edges. • The oven will “beep” and stop, CHECK will flash on and off. Remove defrosted portions of mince, turn over and shield edges with foil strips. • Press start to continue defrosting. • After defrost time, stand covered with aluminium foil. 	5 - 20
2	Roast Meat Beef/Pork/Lamb 	0.1 – 1.5	<ul style="list-style-type: none"> • Shield the bone and the edge with foil strips about 2.5 cm wide. • Place joint with lean side face upwards (if possible) on a defrost rack. • The oven will “beep” and stop, CHECK will flash on and off. Turn over and shield the warm portions. • Press start to continue defrosting. • After defrost time, stand covered with aluminium foil. 	5 - 30
3	Poultry 	1.0 – 1.5	<ul style="list-style-type: none"> • Remove from original wrapper. Shield wing and leg tips with foil. • Place breast side down on a defrost rack. • The oven will “beep” and stop, CHECK will flash on and off. Turn over and shield the warm portions. • Press start to continue defrosting. • After defrost time, stand covered with aluminium foil. <p style="margin-left: 20px;">[N.B.] After standing run under cold water to remove giblets if necessary.</p>	15 - 20
4	Chicken Pieces 	0.1 – 1.5	<ul style="list-style-type: none"> • Shield the exposed bone with foil. • Place chicken pieces on a defrost rack. • The oven will “beep” and stop, CHECK will flash on and off. Remove defrosted pieces, turn over and shield the warm portions of remaining pieces. • Press start to continue defrosting. • After defrost time, stand covered with aluminium foil. 	5 - 15



Food not listed in the Guide can be defrosted manually using 30 % setting.

NOTE: When freezing minced meat, shape it into flat even sizes.

For chicken pieces, steaks and chops, freeze separately in single flat layers and if necessary interleave with freezer plastic to separate layers. This will ensure even defrosting.

It is also a good idea to label the packs with the correct weights.



EXPRESS DEFROST MENU GUIDE

NO.	Menu	Quantity (kg's)	Procedure	⌚ Standing Time (minutes)
1	Fish Fillets 	0.5	<ul style="list-style-type: none"> • Place fish fillets on a defrost rack. • The oven will "beep" and stop, CHECK will flash on and off. Turn over and separate into pieces. • Press start to continue defrosting. • After defrost time, stand covered with aluminium foil. 	5
2	Chicken Fillets 	0.5	<ul style="list-style-type: none"> • Place chicken fillets on a defrost rack. • The oven will "beep" and stop, CHECK will flash on and off. Break apart and turn over. • Press start to continue defrosting. • After defrost time, stand covered with aluminium foil. 	5
3	Sausages / Minced Meat 	0.5	<ul style="list-style-type: none"> • Place sausages / minced meat on a defrost rack. • The oven will "beep" and stop, CHECK will flash on and off. Remove defrosted portions, turn over and shield edges with foil strips. • Press start to continue defrosting. • After defrost time, stand covered with aluminium foil. 	5







NOTE: When freezing minced meat, shape it into flat even sizes.
 For fish fillets, chicken fillets and sausages, freeze separately in single flat layers and if necessary interleave with freezer plastic to separate layers. This will ensure even defrosting.
 It is also a good idea to label the packs with the correct weights.

INSTANT ACTION MENU GUIDE

The final cooking result will vary according to the food condition (e.g. initial temperature, shape, quality). Check the food after cooking and if necessary continue cooking manually.

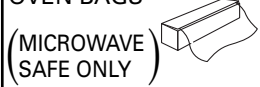
Menu		Quantity (Unit per pressing each INSTANT ACTION pad)	Initial Temperature (approx.) 	Procedure	 Standing Time (minutes)
Dinner Plate		1 serve (approx. 400 g)	+ 3°C Refrigerated	<ul style="list-style-type: none"> • Cover with plastic wrap. • After cooking, stand covered. 	2
MEAT 175-180g	POTATO 125g	VEGETABLES 100g			
Beef, Lamb Chicken, T-Bone	sliced	2 varieties eg. sliced Carrot, Zucchini Broccoli			
Beverage includes: Tea Coffee Water		1 – 4 cups (1 cup, 250 ml)	+ 20°C Room temperature	<ul style="list-style-type: none"> • No cover • Place on the outside of turntable. • After reheating, stir. 	
Fresh Vegetables		0.1 – 0.6 kg (0.1 kg)	+ 3°C Refrigerated	<ul style="list-style-type: none"> • Wash the vegetables. • Arrange the vegetables in a shallow dish in the following way: hard vegetables around the outside, soft vegetables in the centre, medium vegetables in-between. • Cover with glass lid or plastic wrap. • After cooking, stand covered and stir. 	1 - 5
Carrots	} hard vegetables				
Potato	} medium vegetables				
Beans / Brussels Sprouts	} medium vegetables				
Broccoli / Cauliflower	} medium vegetables				
Zucchini / Spinach / Cabbage	} soft vegetables				
Frozen Vegetables		0.1 – 0.6 kg (0.1 kg)	- 18°C Frozen	<ul style="list-style-type: none"> • Before cooking, separate vegetables eg. broccoli as much as possible. • Arrange the vegetables in a shallow dish in the following way : hard vegetables around the outside, soft vegetables in the centre, medium vegetables in-between. • Cover with a glass lid or plastic wrap. • After cooking, stand covered and stir. 	1 - 5
Carrots	} hard vegetables				
Beans / Brussels Sprouts	} medium vegetables				
Broccoli / Cauliflower	} medium vegetables				
Corn	} soft vegetables				
Green Peas	} soft vegetables				
Mixed Vegetables	} soft vegetables				
Jacket Potato Potato (whole)		1 – 6 pieces (1 piece, approx. 150 g)	+ 20°C Room temperature	<ul style="list-style-type: none"> • Use washed new potatoes. • Pierce twice with fork on each side. • Place on outside of turntable. • The oven will “beep” and stop, CHECK will flash on and off. • Turn over potatoes and press start to continue cooking. • After cooking , stand, covered with aluminium foil. 	3 - 10

COOKWARE AND UTENSIL GUIDE

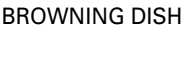
Utensil	Use	Advice
GLASSWARE/CERAMIC (HEAT RESISTANT) 	YES	GLASSWARE <ul style="list-style-type: none"> • Ordinary glass is not suitable for cooking but may be used for short periods for heating foods. CERAMIC <ul style="list-style-type: none"> • Most ovenproof china, and ceramics, are suited. • Avoid dishes that are decorated with gold or silver leaf. • Avoid using antique pottery. • If unsure, check with the manufacturer.
METAL COOKWARE 	NO	<ul style="list-style-type: none"> • Metal cookware should be avoided when cooking in the microwave oven. • Microwave energy is reflected by metal.
PLASTIC WRAP/ OVEN BAGS (MICROWAVE SAFE ONLY) 	YES	<ul style="list-style-type: none"> • Plastic wrap can be used to cover food. • Some shrinkage of the wrap may occur, over an extended cooking time. • When removing wrap, lift it in such a way to avoid steam burns. • Do not tie oven bags with metal twist ties, substitute with string. • For cooking food with high fat content, do not bring the wrap in contact with the food as it may melt.
ALUMINIUM FOIL 	FOR SHIELDING	<ul style="list-style-type: none"> • Small amounts may be used to shield certain parts of meat and fish when cooking or defrosting. • Remove food in foil trays, if possible, and place in a microwave safe dish. • If not possible, place the foil tray onto a heat proof plate allowing 2.5 cm between the walls of the oven.
STRAW AND WOOD 	NO	<ul style="list-style-type: none"> • Excessive over heating of these materials may cause a fire in the microwave oven.
PAPER 	YES	<ul style="list-style-type: none"> • Paper towels and waxed paper are suitable to use to prevent splatters. • These are suitable for use when reheating foods or for short cooking times.
PLASTIC COOKWARE MICROWAVE SAFE 	YES	<ul style="list-style-type: none"> • Ideal for cooking, reheating and defrosting. • Some microwave safe plastic cookware are not suitable for cooking foods with high fat and sugar content.
BROWNING DISH 	YES	<ul style="list-style-type: none"> • Ensure that the preheating time of the dish is not exceeded. • Ensure that a microwave heat proof dinner plate or suitable insulator be placed between the turntable and the browning dish.
THERMOMETERS • MICROWAVE SAFE • CONVENTIONAL	YES NO	

HELPFUL HINTS

1. THE ARRANGEMENT

Arrange foods carefully. Place thickest areas toward outside of dish.



3. COVERING

Cover foods in the microwave if you would normally cover the food in your ordinary oven, or to retain moisture. Cover foods such as Vegetables, Casseroles, or when Reheating.

Use to cover foods:

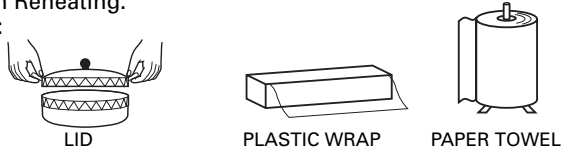

5. SHIELDING

Shield using small pieces of aluminium foil to shield thin areas of meat, fish and poultry or edges of cakes to prevent overcooking.

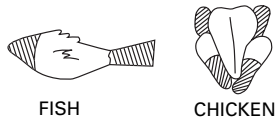

7. STIRRING

Stir foods from the outside to the centre of the dish, once or twice during cooking if possible.
Eg. Casseroles and Sauces.



9. DENSITY

The depth to which microwaves penetrate food varies depending on the food's density. Porous foods like minced beef or mashed potatoes microwave faster than dense ones like steak or whole potatoes.

11. STARTING TEMPERATURE

Frozen or refrigerated foods take longer to heat than food at room temperature. Cooking times in this book are based on normal storage temperatures. Since rooms, refrigerators and freezers differ in temperature, check cooking result at the minimum time.

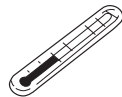

13. CONDENSATION

Condensation is a normal part of microwave cooking. The humidity and moisture in food will influence the amount of condensation in the oven. Generally, covered foods will not cause as much condensation as uncovered foods. Ensure that the ventilation openings are not blocked.

2. TURNING

Foods such as poultry and joints of meat should be turned over after half the cooking time.

4. PIERCING

Pierce potatoes, eggs, tomatoes or any foods with a skin or membrane to allow steam to escape.

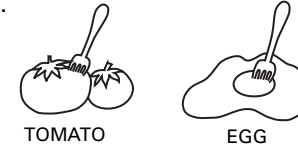

6. STANDING TIME

Standing time is important. After cooking or defrosting ensure adequate standing time. This allows the food to continue cooking or heating. Refer to cooking guides for each menu or according to manufacturers instructions.

8. SIZE

Small pieces cook faster than large ones. To speed up cooking, cut pieces smaller than 5 cm so microwaves can penetrate to the centre from all sides. For even cooking, make all the pieces the same size.

10. FAT AND BONE

Marbling within meat, or a thin, even layer of fat on a roast, speeds cooking. Large fatty areas or excess drippings in dish attract energy away from meat, and slows cooking. Centre bones do not affect cooking, but bone on the side of meat conducts heat to the areas next to it.

12. QUANTITY

Microwave cooking times are directly related to the amount of food in the oven. Because energy is absorbed by the food itself, one potato or a single piece of chicken cooks rapidly. When the energy is divided among several items, cooking takes more time.





14. GENERAL

Your microwave oven is capable of heating food and beverages very quickly therefore, it is very important that you select the appropriate cooking time and power level for the type and quantity of food to be heated. If you are unsure of the cooking time and power level required, begin with low cooking times and power levels until the food is sufficiently heated evenly throughout.

SHARP

COOKING GUIDES

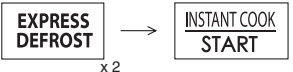
QUICK REFERENCE GUIDE

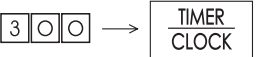
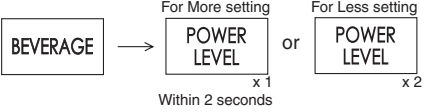
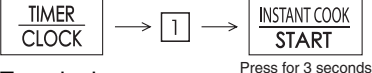
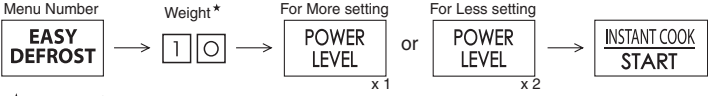
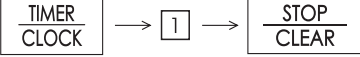
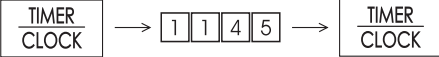
FEATURE	QUICK OPERATION GUIDE	FEATURE	QUICK OPERATION GUIDE
Instant Action	To cook 2 Jacket Potatoes. 	Variable Cooking control	To soften Cream Cheese or Butter for 40 seconds on 30%. Cooking Time 
Express Defrost	To defrost 0.5 kg of Chicken Fillets. Menu Number 	Instant Cook	Just One Touch  Within 3 minutes of closing the door
Easy Defrost	To defrost 1.0 kg of Chicken Pieces. Menu Number Weight 	Timer	To set for 3 minutes. 
Less/More Setting	For Instant Action.  <p>For More setting or For Less setting Within 2 seconds</p>	Child Lock	To lock.  <p>Press for 3 seconds</p>
	For Express Defrost and Easy Defrost. Menu Number Weight *  <p>* Express Defrost does not need to enter weight.</p>		To unlock. 
		Clock	To set for 11:45 am 

CONTENTS COOKING GUIDE

QUICK REFERENCE GUIDE ①	HELPFUL HINTS ②	COOKWARE AND UTENSIL GUIDE ③	INSTANT ACTION MENU GUIDE ④	EXPRESS DEFROST MENU GUIDE ⑤	EASY DEFROST MENU GUIDE ⑥	CHART ⑦ - ⑧
-------------------------	-----------------	------------------------------	-----------------------------	------------------------------	---------------------------	-------------

SHARP

SHARP CORPORATION OSAKA, JAPAN

①

TINSEB282WRRZ-J01
Printed in Thailand

Free Manuals Download Website

<http://myh66.com>

<http://usermanuals.us>

<http://www.somanuals.com>

<http://www.4manuals.cc>

<http://www.manual-lib.com>

<http://www.404manual.com>

<http://www.luxmanual.com>

<http://aubethermostatmanual.com>

Golf course search by state

<http://golfingnear.com>

Email search by domain

<http://emailbydomain.com>

Auto manuals search

<http://auto.somanuals.com>

TV manuals search

<http://tv.somanuals.com>