



SHARP®

OPERATION MANUAL

MODEL

PG-A10X

PG-A10S

SHARP®

SHARP CORPORATION



Introduction

Connections and Setup

Basic Operation

Easy to Use Functions

Appendix

LCD PROJECTOR



Printed in Japan
TINS-A505WJN1
03P02-JWM

香港電器安全規格
(國際電工委員會規格適合)

03.2.4, 1:59 PM



IMPORTANT

For your assistance in reporting the loss or theft of your Projector, please record the Serial Number located on the bottom of the projector and retain this information. Before recycling the packaging, please be sure that you have checked the contents of the carton thoroughly against the list of "Supplied accessories" on page 14.

Model No.:

Serial No.:

This equipment complies with the requirements of Directives 89/336/EEC and 73/23/EEC as amended by 93/68/EEC.

Dieses Gerät entspricht den Anforderungen der EG-Richtlinien 89/336/EWG und 73/23/EWG mit Änderung 93/68/EWG.

Ce matériel répond aux exigences contenues dans les directives 89/336/CEE et 73/23/CEE modifiées par la directive 93/68/CEE.

Dit apparaat voldoet aan de eisen van de richtlijnen 89/336/EEG en 73/23/EEG, gewijzigd door 93/68/EEG.

Dette udstyr overholder kravene i direktiv nr. 89/336/EEC og 73/23/EEC med tillæg nr. 93/68/EEC.

Quest' apparecchio è conforme ai requisiti delle direttive 89/336/EEC e 73/23/EEC, come emendata dalla direttiva 93/68/EEC.

Η εγκατάσταση αυτή ανταποκρίνεται στις απαιτήσεις των οδηγιών της Ευρωπαϊκής Ένωσης 89/336/EOK και 73/23/EOK, όπως οι κανονισμοί αυτοί συμπληρώθηκαν από την οδηγία 93/68/EOK.

Este equipamento obedece às exigências das directivas 89/336/CEE e 73/23/CEE, na sua versão corrigida pela directiva 93/68/CEE.



Este aparato satisface las exigencias de las Directivas 89/336/CEE y 73/23/CEE, modificadas por medio de la 93/68/CEE.

Denna utrustning uppfyller kraven enligt riktlinjerna 89/336/EEC och 73/23/EEC så som kompletteras av 93/68/EEC.

Dette produktet oppfyller betingelsene i direktivene 89/336/EEC og 73/23/EEC i endringen 93/68/EEC.

Tämä laite täyttää direktiivien 89/336/EEC ja 73/23/EEC vaatimukset, joita on muutettu direktiivillä 93/68/EEC.

**SPECIAL NOTE FOR USERS IN THE U.K.**

The mains lead of this product is fitted with a non-rewireable (moulded) plug incorporating a 5A fuse. Should the fuse need to be replaced, a BSI or ASTA approved BS 1362 fuse marked  or  and of the same rating as above, which is also indicated on the pin face of the plug, must be used.

Always refit the fuse cover after replacing the fuse. Never use the plug without the fuse cover fitted.

In the unlikely event of the socket outlet in your home not being compatible with the plug supplied, cut off the mains plug and fit an appropriate type.

DANGER:

The fuse from the cut-off plug should be removed and the cut-off plug destroyed immediately and disposed of in a safe manner.

Under no circumstances should the cut-off plug be inserted elsewhere into a 5A socket outlet, as a serious electric shock may occur.

To fit an appropriate plug to the mains lead, follow the instructions below:

IMPORTANT:

The wires in the mains lead are coloured in accordance with the following code:

Blue: Neutral

Brown: Live

As the colours of the wires in the mains lead of this product may not correspond with the coloured markings identifying the terminals in your plug, proceed as follows:

- The wire which is coloured blue must be connected to the plug terminal which is marked N or coloured black.
 - The wire which is coloured brown must be connected to the plug terminal which is marked L or coloured red.
- Ensure that neither the brown nor the blue wire is connected to the earth terminal in your three-pin plug.

Before replacing the plug cover make sure that:

- If the new fitted plug contains a fuse, its value is the same as that removed from the cut-off plug.
- The cord grip is clamped over the sheath of the mains lead, and not simply over the lead wires.

IF YOU HAVE ANY DOUBT, CONSULT A QUALIFIED ELECTRICIAN.



The supplied CD-ROM contains operation instructions in English, German, French, Swedish, Spanish, Italian, Dutch, Portuguese, Chinese (Traditional Chinese and Simplified Chinese) and Korean. Carefully read through the operation instructions before operating the projector.

Die mitgelieferte CD-ROM enthält Bedienungsanleitungen in Englisch, Deutsch, Französisch, Schwedisch, Spanisch, Italienisch, Niederländisch, Portugiesisch, Chinesisch (Traditionelles Chinesisch und einfaches Chinesisch) und Koreanisch. Bitte lesen Sie die Bedienungsanleitung vor der Verwendung des Projektors sorgfältig durch.

Le CD-ROM fourni contient les instructions de fonctionnement en anglais, allemand, français, suédois, espagnol, italien, néerlandais, portugais, chinois (chinois traditionnel et chinois simplifié) et coréen. Veuillez lire attentivement ces instructions avant de faire fonctionner le projecteur.

Den medföljande CD-ROM-skivan innehåller bruksanvisningar på engelska, tyska, franska, svenska, spanska, italienska, holländska, portugisiska, kinesiska (traditionell kinesiska och förenklad kinesiska) och koreanska. Läs noga igenom bruksanvisningen innan projektorn tas i bruk.

El CD-ROM suministrado contiene instrucciones de operación en inglés, alemán, francés, sueco, español, italiano, holandés, portugués, chino (chino tradicional y chino simplificado) y coreano. Lea cuidadosamente las instrucciones de operación antes de utilizar el proyector.

Il CD-ROM in dotazione contiene istruzioni per l'uso in inglese, tedesco, francese, svedese, spagnolo, italiano, olandese, portoghese, cinese (cinese tradizionale e cinese semplificato) e coreano. Leggere attentamente le istruzioni per l'uso prima di usare il proiettore.

De meegeleverde CD-ROM bevat handleidingen in het Engels, Duits, Frans, Zweeds, Spaans, Italiaans, Nederlands, Portugees, Chinees (Traditioneel Chinees en Vereenvoudigd Chinees) en Koreaans. Lees de handleiding zorgvuldig door voor u de projector in gebruik neemt.

O CD-ROM fornecido contém instruções de operação em Inglês, Alemão, Francês, Sueco, Espanhol, Italiano, Holandês, Português, Chinês, (Chinês Tradicional e Chinês Simplificado) e Coreano. Leia cuidadosamente todas as instruções de operação antes de operar o projetor.

附送之CD-ROM光碟中，有用英文、德文、法文、瑞典文、西班牙文、意大利文、荷蘭文、葡萄牙文、中文（繁體中文和簡體中文）和韓國文所寫的使用說明書。在操作本投影機之前，請務必仔細閱讀整本使用說明書。

附送之CD-ROM光碟中，有用英文、德文、法文、瑞典文、西班牙文、意大利文、荷蘭文、葡萄牙文、中文（繁體中文和簡體中文）和韓國文所寫的使用說明書。在操作本投影机之前，请务必仔细阅读整本使用说明书。

제공된 CD-ROM에는 영어, 독일어, 프랑스어, 스웨덴어, 스페인어, 이탈리아어, 네덜란드어, 포르투갈어, 중국어(번체자와 간체자), 그리고 한국어로 작성된 조작 설명서가 포함되어 있습니다. 프로젝터를 조작하기 전에 조작 지침을 상세하게 숙지하십시오.



Before using the projector, please read this operation manual carefully.

Introduction

ENGLISH

There are two important reasons for prompt warranty registration of your new SHARP Projector, using the REGISTRATION CARD packed with the projector.

1. WARRANTY

This is to assure that you immediately receive the full benefit of the parts, service and labor warranty applicable to your purchase.

2. CONSUMER PRODUCT SAFETY ACT

To ensure that you will promptly receive any safety notification of inspection, modification, or recall that SHARP may be required to give under the 1972 Consumer Product Safety Act, PLEASE READ CAREFULLY THE IMPORTANT "LIMITED WARRANTY" CLAUSE. U.S.A. ONLY

WARNING: High brightness light source. Do not stare into the beam of light, or view directly. Be especially careful that children do not stare directly into the beam of light.

WARNING: To reduce the risk of fire or electric shock, do not expose this product to rain or moisture.

See bottom of projector.

	CAUTION RISK OF ELECTRIC SHOCK. DO NOT REMOVE SCREWS EXCEPT SPECIFIED USER SERVICE SCREW.	
CAUTION: TO REDUCE THE RISK OF ELECTRIC SHOCK, DO NOT REMOVE COVER. NO USER-SERVICEABLE PARTS EXCEPT LAMP UNIT. REFER SERVICING TO QUALIFIED SERVICE PERSONNEL.		



The lightning flash with arrowhead symbol, within an equilateral triangle, is intended to alert the user to the presence of uninsulated "dangerous voltage" within the product's enclosure that may be of sufficient magnitude to constitute a risk or electric shock to persons.



The exclamation point within a triangle is intended to alert the user to the presence of important operating and maintenance (servicing) instructions in the literature accompanying the product.

WARNING: FCC Regulations state that any unauthorized changes or modifications to this equipment not expressly approved by the manufacturer could void the user's authority to operate this equipment. U.S.A. ONLY

INFORMATION

This equipment has been tested and found to comply with the limits for a Class A digital device, pursuant to Part 15 of the FCC Rules. These limits are designed to provide reasonable protection against harmful interference when the equipment is operated in a commercial environment. This equipment generates, uses, and can radiate radio frequency energy and, if not installed and used in accordance with the operation manual, may cause harmful interference to radio communications. Operation of this equipment in a residential area is likely to cause harmful interference, in which case the user will be required to correct the interference at his own expense. U.S.A. ONLY

The enclosed computer cable must be used with the device. The cable is provided to ensure that the device complies with FCC Class A verification. U.S.A. ONLY

WARNING:

This is a Class A product. In a domestic environment this product may cause radio interference in which case the user may be required to take adequate measures.



WARNING:

The cooling fan in this projector continues to run for about 90 seconds after the projector is turned off. During normal operation, when turning the power off always use the POWER OFF button on the projector or on the remote control. Ensure the cooling fan has stopped before disconnecting the power cord.
DURING NORMAL OPERATION, NEVER TURN THE PROJECTOR OFF BY DISCONNECTING THE POWER CORD. FAILURE TO OBSERVE THIS WILL RESULT IN PREMATURE LAMP FAILURE.

PRODUCT DISPOSAL

This projector utilizes tin-lead solder, and a pressurized lamp containing a small amount of mercury. Disposal of these materials may be regulated due to environmental considerations. For disposal or recycling information, please contact your local authorities or, if you are located in the United States of America, the Electronic Industries Alliance: www.eiae.org.

Caution Concerning Lamp Replacement

See "Replacing the Lamp" on page 57.

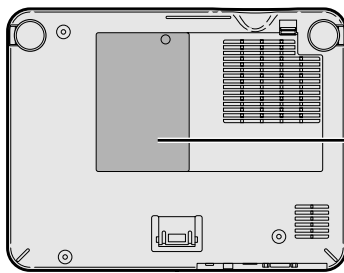

⚠ LAMP REPLACEMENT CAUTION
 BEFORE REMOVING THE SCREW, DISCONNECT POWER CORD. HOT SURFACE INSIDE. ALLOW 1 HOUR TO COOL BEFORE REPLACING THE LAMP. REPLACE WITH SAME SHARP LAMP UNIT TYPE BQC-PGA10X//1 ONLY.
 UV RADIATION : CAN CAUSE EYE DAMAGE. TURN OFF LAMP BEFORE SERVICING.
 HIGH PRESSURE LAMP : RISK OF EXPLOSION. POTENTIAL HAZARD OF GLASS PARTICLES IF LAMP HAS RUPTURED. HANDLE WITH CARE. SEE OPERATION MANUAL.

⚠ PRECAUTIONS A OBSERVER LORS DU REMPLACEMENT DE LA LAMPE.
 DEBRANCHER LE CORDON D'ALIMENTATION AVANT DE RETIRER LA VIS. L'INTERIEUR DU BOITIER ETANT EXTREMEMENT CHAUD, ATTENDRE 1 HEURE AVANT DE PROCEDER AU REMPLACEMENT DE LA LAMPE. NE REMPLACER QUE PAR UNE LAMPE SHARP DE TYPE BQC-PGA10X//1.
 RAYONS ULTRAVIOLETS : PEUVENT ENDOMMAGER LES YEUX. ETEINDRE LA LAMPE AVANT DE PROCEDER A L'ENTRETIEN.
 LAMPE A HAUTE PRESSION : RISQUE D'EXPLOSION. DANGER POTENTIEL DE PARTICULES DE VERRE EN CAS D'ECLATEMENT DE LA LAMPE. A MANIPULER AVEC PRECAUTION, SE REPORTER AU MODE D'EMPLOI.

When Attaching the "QUICK GUIDE" Label

Attaching the "QUICK GUIDE" Label (supplied) on the projector will help you check the setup procedure. When you attach the "QUICK GUIDE" Label on the projector, be sure to align the label bottom and the upper part of the "Notevision" logo on the top cabinet of the projector as shown in the drawing on the right. Do not attach the "QUICK GUIDE" Label anywhere else.

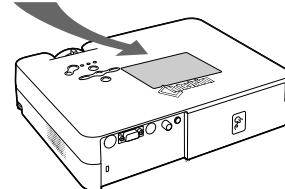
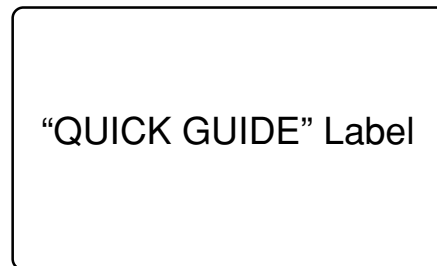



Outstanding Features

1. Light and Compact Design

- A4 / letter size projector weighing only 2.9 kg / 6.4 lbs can be easily transported from room to room or location to location.

2. Comfortable Operation, Classroom and Meeting Room Friendly

- Low fan noise and front directed exhaust outlet insure minimal disturbance to your audience seated adjacent to the projector.
- Short throw lens allows for image size of 100" at just 3.2 meters (10' 6").

3. Simply and Easy Operation

- Color-coded connections allows for hassle-free set-up.
- Frequently used buttons, lens placement are positioned for easy operation.

4. High Brightness Despite Compact Size

- Use of 165 W SHP lamp achieves excellent color uniformity and high brightness.
- The Eco mode function reduces noise levels and power consumption while also extending lamp life.

5. Wide Input Signal Compatibility

- Video systems compatible (NTSC3.58, PAL, SECAM, PAL-N, PAL-M, PAL-60 and NTSC4.43)
- HD input compatible (1080I, 720P and 480P)
- Computer input compatible (VGA, SVGA, XGA, SXGA and SXGA+)

6. Anti-Theft and Keylock

- The Anti-Theft function renders the projector useless to prevent unauthorized use until a keycode is entered.
- The Keylock function allows you to easily lock the operation buttons on the projector to prevent unauthorized adjustment.

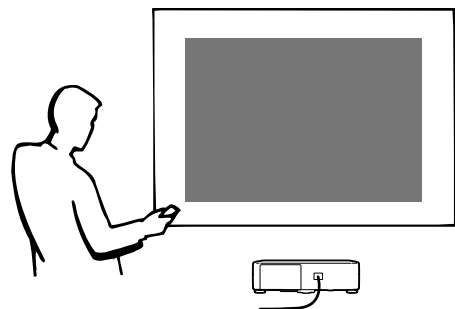



Contents

Introduction

Outstanding Features	3
Contents	4
IMPORTANT SAFEGUARDS	6
How to Access the PDF Operation Manuals	9
Part Names	10
Projector (Front and Top View)	10
Projector (Rear View)	11
Remote Control (Front View)	12
Using the Remote Control	13
Usable Range	13
Inserting the Batteries	13
Accessories	14

Connections and Setup

Connecting the Projector to Other Devices	15
Before Connecting	15
This projector can be connected to:	15
Connecting the Power Cord	15
Connecting the Projector to a Computer	16
Connecting to Video Equipment	18
Controlling the Projector Using a Computer	20
Setup	21
Using the Adjustment Feet	21
Adjusting the Lens	22
Setting up the Screen	23
Screen Size and Projection Distance	24
Projecting a Reversed/Inverted Image	25

Basic Operation

Image Projection	26
Basic Procedure	26
Selecting the On-screen Display Language	28
Keystone Correction (Correcting Trapezoidal Distortion)	29
Menu Items	30
Using the Menu Screen	32
Menu Selections (Adjustments)	32
Menu Selections (Settings)	34
Picture Adjustment	36
Adjusting the Image	36
CLR Temp (Adjusting the Color Temperature)	36
Gamma (Gamma Correction)	37
sRGB (sRGB Setting)	37
Signal Type (Signal Type Setting)	37
Memory (Storing and Selecting the Adjustment Settings)	37
Computer Image Adjustment	38
Adjusting the Computer Image	38
Special Modes (Special Mode Settings)	38
Signal Info (Checking the Input Signal)	39

Easy to Use Functions

Picture Display Mode	40
Switching the Picture Display Mode	40
Still and Zoom Image	42
Freezing a Moving Image	42
Displaying an Enlarged Portion of an Image	42
Keylock Function	43
Locking the operation Buttons	43
Taking the Keylock off	43
Using the "Options" Menu	44
Lamp Timer (Life) (Checking the Lamp Life Status)	44
OSD Display (Setting On-screen Display)	44
Video System (Setting the Video System)	45
Background (Selecting a Startup and Background Image)	45
Eco Mode (Setting the Eco Mode)	45
Auto Power Off (Auto Power Off Function)	46
Menu Position (Selecting the Menu Screen Position)	46
Menu Color (Selecting the Menu Color)	46
Password (Setting a Password)	47
If You Forget Your Password	47
Anti-Theft (Setting the Anti-Theft)	48
Reversing /Inverting Projected Images	50
Setting the Projection Mode	50



Appendix

Carrying the Projector	51
How to Use the Carrying Case	51
Maintenance	52
Replacing the Air Filter	53
Cleaning and Replacing the Air Filter	53
Maintenance Indicators	55
Regarding the Lamp	57
Lamp	57
Caution Concerning the Lamp	57
Replacing the Lamp	57
Removing and Installing the Lamp Unit	58
Resetting the Lamp Timer	59
Connecting Pin Assignments	60
RS-232C Specifications and	
Command Settings	61
Computer Compatibility Chart	62
Troubleshooting	63
For SHARP Assistance	65
Specifications	66
Dimensions	67
Glossary	68
Index	69

This operation manual includes "Introduction", "IMPORTANT SAFEGUARDS" and "How to Access the PDF Operation Manuals" in German, French, Swedish, Spanish, Italian, Dutch, Portuguese, Chinese (Traditional Chinese) and Korean on pages 71 to 109.

Deutsch

Einführung	71
WICHTIGE SICHERHEITSHINWEISE	72
Zugriff auf die PDF-Bedienungsanleitungen ...	74

Français

Introduction	75
MESURES DE SÉCURITÉ IMPORTANTES	76
Comment accéder aux modes d'emploi PDF ...	78

Svenska

Introduktion	79
VIKTIGA SÄKERHETSFÖRESKRIFTER	80
Hur du läser PDF-bruksanvisningarna	82

Español

Introducción	83
IMPORTANTES MEDIDAS DE SEGURIDAD	84
Cómo acceder a los manuales de manejo en	
formato PDF	86

Italiano

Introduzione	87
NORME DI SICUREZZA IMPORTANTI	88
Per accedere ai manuali di istruzioni nel	
formato PDF	90

Nederlands

Inleiding	91
BELANGRIJKE VEILIGHEIDSVORSCHRIFTEN ...	92
Toegang krijgen tot de PDF-	
gebruiksaanwijzingen	94

Português

Introdução	95
INFORMAÇÕES DE SEGURANÇA	96
Como Aceder os Manuais de Operação PDF ...	98

中文

入門	99
重要的安全措施	100
如何訪問 PDF 使用說明書	102

한국어

시작하기	103
안전을 위한 주의사항	104
주요 안전 지침	108
PDF 조작매뉴얼의 사용법	109



IMPORTANT SAFEGUARDS

CAUTION: Please read all of these instructions before you operate this product and save these instructions for later use.

Electrical energy can perform many useful functions. This product has been engineered and manufactured to assure your personal safety. BUT IMPROPER USE CAN RESULT IN POTENTIAL ELECTRICAL SHOCK OR FIRE HAZARDS. In order not to defeat the safeguards incorporated in this product, observe the following basic rules for its installation, use and servicing.

1. Read Instructions

All the safety and operating instructions should be read before the product is operated.

2. Retain Instructions

The safety and operating instructions should be retained for future reference.

3. Heed Warnings

All warnings on the product and in the operating instructions should be adhered to.

4. Follow Instructions

All operating and use instructions should be followed.

5. Cleaning

Unplug this product from the wall outlet before cleaning. Do not use liquid cleaners or aerosol cleaners. Use a damp cloth for cleaning.

6. Attachments

Do not use attachments not recommended by the product manufacturer as they may cause hazards.

7. Water and Moisture

Do not use this product near water—for example, near a bath tub, wash bowl, kitchen sink, or laundry tub; in a wet basement; or near a swimming pool; and the like.

8. Accessories

Do not place this product on an unstable cart, stand, tripod, bracket, or table. The product may fall, causing serious injury to a child or adult, and serious damage to the product. Use only with a cart, stand, tripod, bracket, or table recommended by the manufacturer, or sold with the product. Any mounting of the product should follow the manufacturer's instructions, and should use a mounting accessory recommended by the manufacturer.

9. Transportation

A product and cart combination should be moved with care. Quick stops, excessive force, and uneven surfaces may cause the product and cart combination to overturn.



10. Ventilation

Slots and openings in the cabinet are provided for ventilation to ensure reliable operation of the product and to protect it from overheating, and these openings must not be blocked or covered. The openings should never be blocked by placing the product on a bed, sofa, rug, or other similar surface. This product should not be placed in a built-in installation such as a bookcase or rack unless proper ventilation is provided or the manufacturer's instructions have been adhered to.

11. Power Sources

This product should be operated only from the type of power source indicated on the marking label. If you are not sure of the type of power supply to your home, consult your product dealer or local power company. For products intended to operate from battery power, or other sources, refer to the operating instructions.

12. Grounding or Polarization

This product is provided with one of the following types of plugs. If the plug should fail to fit into the power outlet, please contact your electrician.

Do not defeat the safety purpose of the plug.

- Two-wire type (mains) plug.
- Three-wire grounding type (mains) plug with a grounding terminal.

This plug will only fit into a grounding type power outlet.

13. Power-Cord Protection

Power-supply cords should be routed so that they are not likely to be walked on or pinched by items placed upon or against them, paying particular attention to cords at plugs, convenience receptacles, and the point where they exit from the product.

14. Lightning

For added protection for this product during a lightning storm, or when it is left unattended and unused for long periods of time, unplug it from the wall outlet and disconnect the cable system. This will prevent damage to the product due to lightning and power-line surges.

15. Overloading

Do not overload wall outlets, extension cords, or integral convenience receptacles as this can result in a risk of fire or electric shock.

16. Object and Liquid Entry

Never push objects of any kind into this product through openings as they may touch dangerous voltage points or short-out parts that could result in a fire or electric shock. Never spill liquid of any kind on the product.

17. Servicing

Do not attempt to service this product yourself as opening or removing covers may expose you to dangerous voltage or other hazards. Refer all servicing to qualified service personnel.



18. Damage Requiring Service

Unplug this product from the wall outlet and refer servicing to qualified service personnel under the following conditions:

- a. When the power-supply cord or plug is damaged.
- b. If liquid has been spilled, or objects have fallen into the product.
- c. If the product has been exposed to rain or water.
- d. If the product does not operate normally by following the operating instructions. Adjust only those controls that are covered by the operating instructions, as an improper adjustment of other controls may result in damage and will often require extensive work by a qualified technician to restore the product to normal operation.
- e. If the product has been dropped or damaged in any way.
- f. When the product exhibits a distinct change in performance, this indicates a need for service.

19. Replacement Parts

When replacement parts are required, be sure the service technician has used replacement parts specified by the manufacturer or have the same characteristics as the original part. Unauthorized substitutions may result in fire, electric shock, or other hazards.

20. Safety Check

Upon completion of any service or repairs to this product, ask the service technician to perform safety checks to determine that the product is in proper operating condition.

21. Wall or Ceiling Mounting

This product should be mounted to a wall or ceiling only as recommended by the manufacturer.

22. Heat

This product should be situated away from heat sources such as radiators, heat registers, stoves, or other products (including amplifiers) that produce heat.

- Microsoft and Windows are registered trademarks of Microsoft Corporation in the United States and/or other countries.
- PC/AT is a registered trademark of International Business Machines Corporation in the United States.
- Adobe Acrobat is a trademark of Adobe Systems Incorporated.
- Macintosh is a registered trademark of Apple Computer, Inc. in the United States and/or other countries.
- All other company or product names are trademarks or registered trademarks of their respective companies.



IMPORTANT SAFEGUARDS

Be sure to read the following safeguards when setting up your projector.

Caution concerning the lamp unit

- Potential hazard of glass particles if lamp ruptures. In case of lamp rupture, contact your nearest Sharp Authorized Projector Dealer or Service Center for a replacement.

See "Replacing the Lamp" on page 57.

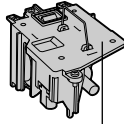

Caution concerning the setup of the projector

- For minimal servicing and to maintain high image quality, SHARP recommends that this projector be installed in an area free from humidity, dust and cigarette smoke. When the projector is subjected to these environments, the lens must be cleaned more often. As long as the projector is regularly cleaned, use in these environments will not reduce the overall operation life of the unit. Internal cleaning should only be performed by a Sharp Authorized Projector Dealer or Service Center.

Do not set up the projector in places exposed to direct sunlight or bright light.

- Position the screen so that it is not in direct sunlight or room light. Light falling directly on the screen washes out the colors, making viewing difficult. Close the curtains and dim the lights when setting up the screen in a sunny or bright room.

The projector may be safely tilted to a maximum angle of 12 degrees.

- Placement should be within ± 12 degrees of horizontal.



Do not subject the projector to hard impact and/or vibration.

- Take care with the lens so as not to hit or damage the surface of the lens.

Rest your eyes occasionally.

- Continuously watching the screen for long hours will cause eye strain. Be sure to occasionally rest your eyes.

Avoid locations with extremes of temperature.

- The operating temperature of the projector is from 41°F to 95°F (+5°C to +35°C).
- The storage temperature of the projector is from -4°F to 140°F (-20°C to +60°C).

Do not block the exhaust and intake vents.

- Allow at least 7 7/8 inches (20 cm) of space between the exhaust vent and the nearest wall or obstruction.

- Be sure that the intake vent and the exhaust vent are not obstructed.
- If the cooling fan becomes obstructed, a protection circuit will automatically turn off the projector. This does not indicate a malfunction. Remove the projector power cord from the wall outlet and wait at least 10 minutes. Place the projector where the intake and exhaust vents are not blocked, plug the power cord back in and turn on the projector. This will return the projector to the normal operating condition.

Caution regarding transportation of the projector

- When transporting the projector, be sure not to subject it to hard impact and/or vibration, as this can result in damage. Take extra care with the lens. Before moving the projector, be sure to unplug the power cord from the wall outlet, and disconnect any other cables connected to it.

Other connected equipment

- When connecting a computer or other audio-visual equipment to the projector, make the connections AFTER turning off the projector and the equipment to be connected.
- Please read the operation manuals of the projector and the equipment to be connected for instructions on how to make the connections.

Using the projector in other countries

- The power supply voltage and the shape of the plug may vary depending on the region or country you are using the projector in. When using the projector overseas, be sure to use an appropriate power cord for the country you are in.

Temperature monitor function

- If the projector starts to overheat due to setup problems or blockage of the air vents, "TEMP." and "TEMP." will illuminate in the lower left corner of the picture. If the temperature continues to rise, the lamp will turn off, the temperature warning indicator on the projector will blink, and after a 90-second cooling-off period the power will be shut off. Refer to "Maintenance Indicators" on page 55 for details.



Info

- The cooling fan regulates the internal temperature, and its performance is automatically controlled. The sound of the fan may change during projector operation due to changes in the fan speed. This does not indicate malfunction.
- Do not unplug the power cord during projection or cooling fan operation. This can cause damage due to rise in internal temperature, as the cooling fan also stops.





How to Access the PDF Operation Manuals

PDF operation manuals in several languages are included in the CD-ROM, so that you can work with the projector, even if you do not have this manual. To utilize these manuals, you need to install Adobe Acrobat Reader on your PC (Windows or Macintosh). If you have not installed Acrobat Reader yet, you can install it from the CD-ROM.

To install Acrobat Reader from the CD-ROM

For Windows:

- ① Insert the CD-ROM in the CD-ROM drive.
- ② Double click the "My Computer" icon.
- ③ Double click the "CD-ROM" drive.
- ④ Double click the "ACROBAT" folder.
- ⑤ Double click the language (name of the folder) that you want to view.
- ⑥ Double click the installation program and follow the instructions on the screen.

For Macintosh:

- ① Insert the CD-ROM in the CD-ROM drive.
- ② Double click the "CD-ROM" icon.
- ③ Double click the "ACROBAT" folder.
- ④ Double click the language (name of the folder) that you want to view.
- ⑤ Double click the installation program and follow the instructions on the screen.

For other operating systems:

Please download Acrobat Reader from the Internet (<http://www.adobe.com>).

For other languages:

If you prefer using Acrobat Reader for languages other than those included in the CD-ROM, please download the appropriate version from the Internet.

Accessing the PDF Manuals

For Windows:

- ① Insert the CD-ROM in the CD-ROM drive.
- ② Double click the "My Computer" icon.
- ③ Double click the "CD-ROM" drive.
- ④ Double click the "MANUALS" folder.
- ⑤ Double click the language (name of the folder) that you want to view.
- ⑥ Double click the "A10" pdf file to access the projector manuals.

For Macintosh:

- ① Insert the CD-ROM in the CD-ROM drive.
- ② Double click the "CD-ROM" icon.
- ③ Double click the "MANUALS" folder.
- ④ Double click the language (name of the folder) that you want to view.
- ⑤ Double click the "A10" pdf file to access the projector manuals.



Note

- If the desired pdf file cannot be opened by double clicking the mouse, start Acrobat Reader first, then specify the desired file using the "File", "Open" menu.
- See the "readme.txt" file on the CD-ROM for important information not included in this operation manual.



Part Names

Numbers in **■** refer to the main pages in this operation manual where the topic is explained.

Projector (Front and Top View)

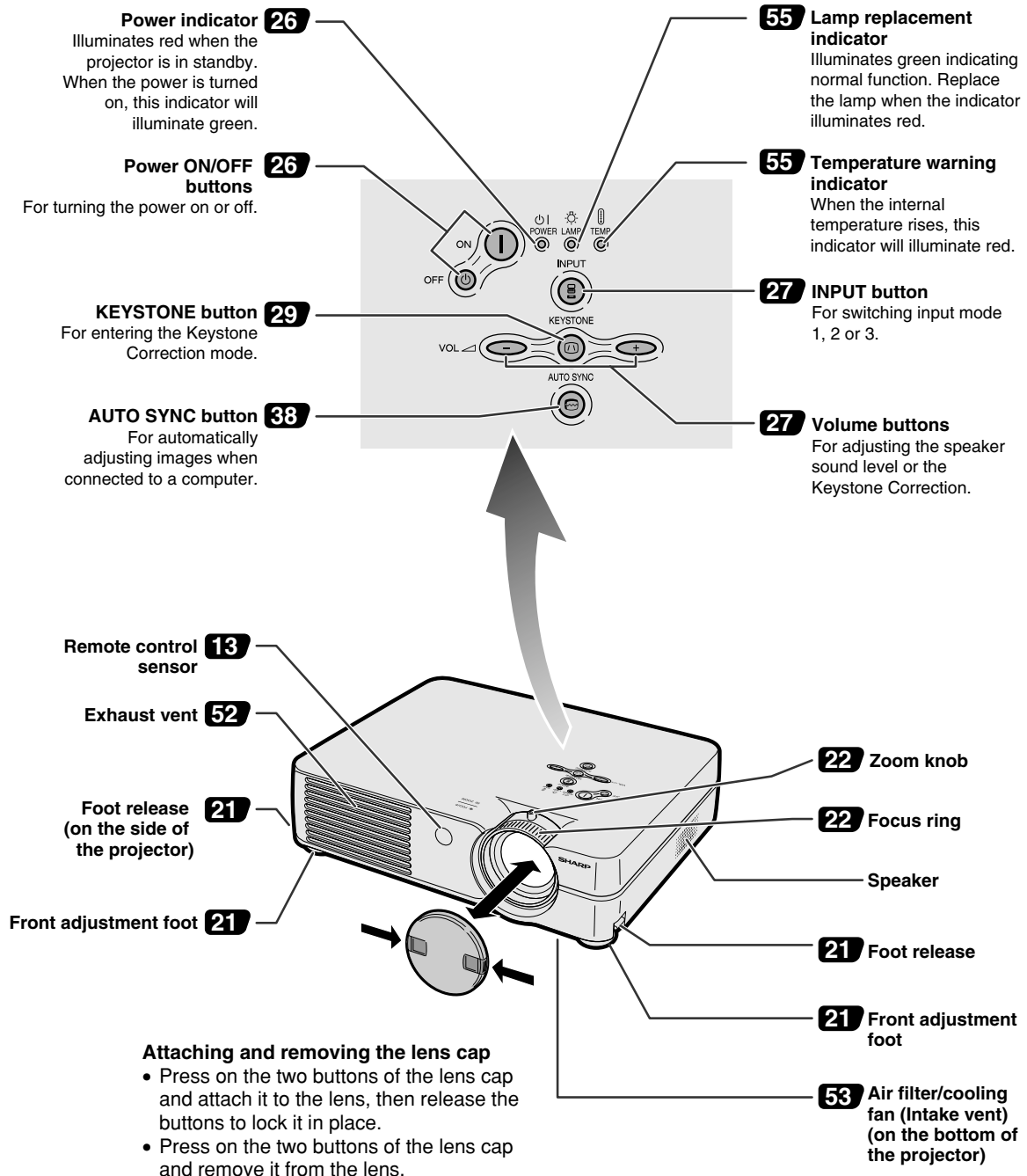



Projector (Rear View)

INPUT 1 terminal 16
Terminal for computer RGB and component signals.

RS-232C terminal 20
For controlling the projector using a computer.

Kensington Security Standard connector

Using the Kensington Lock
• This projector has a Kensington Security Standard connector for use with a Kensington MicroSaver Security System. Refer to the information that came with the system for instructions on how to use it to secure the projector.

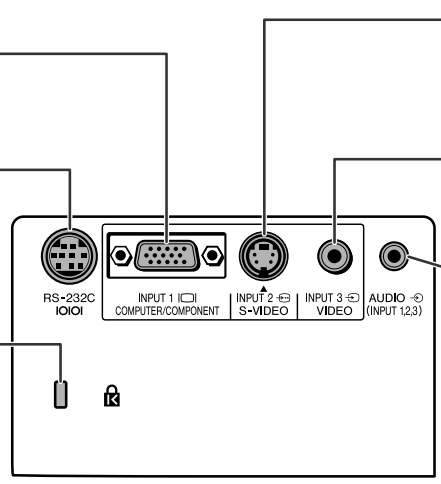

18 INPUT 2 terminal
Terminal for connecting video equipment with an S-video terminal.

18 INPUT 3 terminal
Terminal for connecting video equipment.

16 AUDIO INPUT terminal
Shared audio input terminal for INPUT 1, 2 and 3.

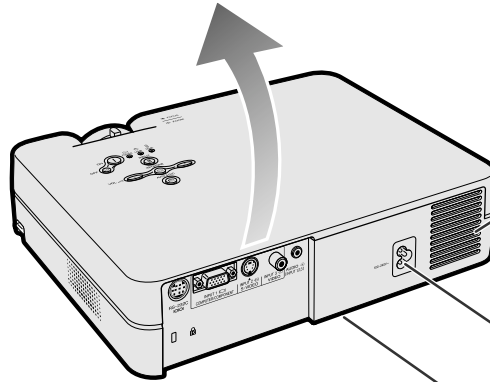

52 Intake vent

15 AC socket

21 Rear adjustment foot
(on the bottom of the projector)

Part Names

Numbers in **■** refer to the main pages in this operation manual where the topic is explained.

Remote Control (Front View)

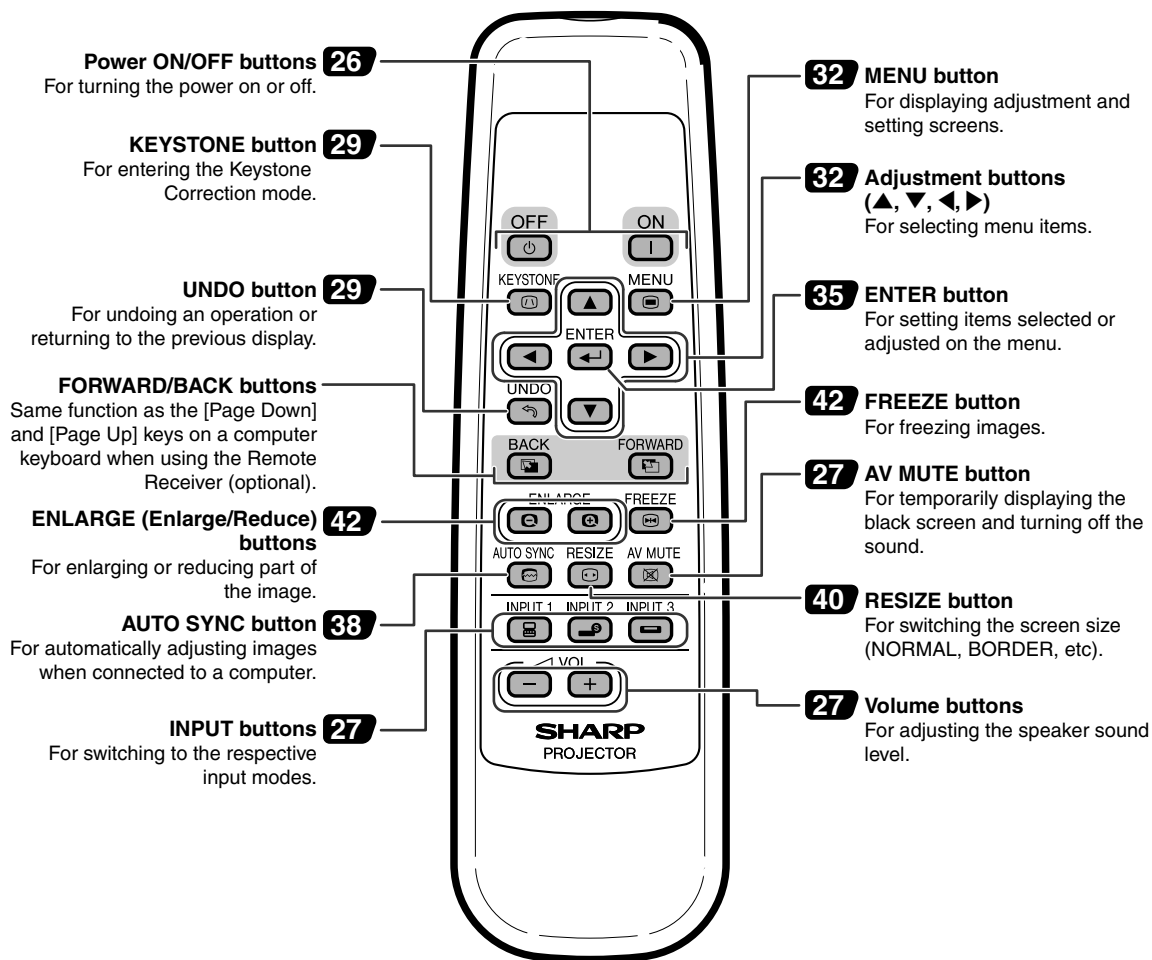



Using the Remote Control

Usable Range

- The remote control can be used to control the projector within the ranges shown in the illustration.

Note

- The signal from the remote control can be reflected off a screen for easy operation. However, the effective distance of the signal may differ depending on the screen material.

When using the remote control:

- Be sure not to drop, expose to moisture or high temperature.
- The remote control may malfunction under a fluorescent lamp. In this case, move the projector away from the fluorescent lamp.

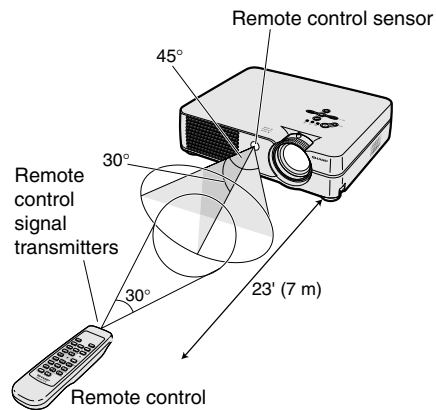

Inserting the Batteries

The batteries (two R-6 batteries ("AA" size, UM/SUM-3, HP-7 or similar)) are supplied in the package.

1 Press the ▲ mark on the cover and slide it in the direction of the arrow.

2 Insert the batteries.

- Insert the batteries making sure the polarities correctly match the ⊕ and ⊖ marks inside the battery compartment.

3 Attach the cover and slide it until it clicks into place.

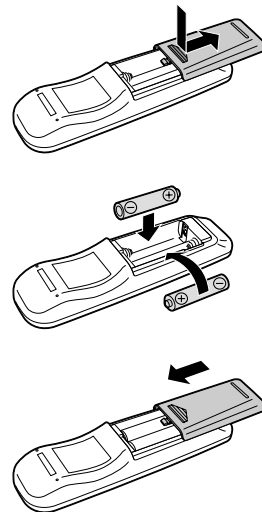

Incorrect use of the batteries may cause them to leak or explode. Please follow the precautions below.

⚠ Caution

- Insert the batteries making sure the polarities correctly match the ⊕ and ⊖ marks inside the battery compartment.
- Batteries of different types have different properties, therefore do not mix batteries of different types.
- Do not mix new and old batteries.
This may shorten the life of new batteries or may cause old batteries to leak.
- Remove the batteries from the remote control once they have run out, as leaving them in can cause them to leak. Battery fluid from leaked batteries is harmful to skin, therefore be sure to first wipe them and then remove them using a cloth.

- The batteries included with this projector may run down in a short period, depending on how they are kept. Be sure to replace them as soon as possible with new batteries.
- Remove the batteries from the remote control if you will not be using the remote control for a long time.



Accessories

Supplied accessories



Remote control
RRMCGA138WJSA



Two R-6 batteries
("AA" size, UM/SUM-3, HP-7 or similar)

Power cord*

(1)

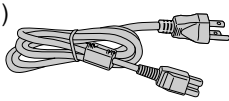

For U.S., Canada, etc.
(6' (1.8 m))
QACCDAA016WJPZ

(2)

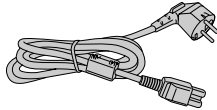

For Europe, except U.K.
(6' (1.8 m))
QACCVA006WJPZ

(3)

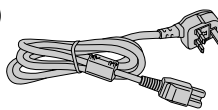

For U.K., Hong Kong and
Singapore
(6' (1.8 m))
QACCBA015WJPZ

(4)

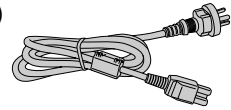

For Australia, New
Zealand and Oceania
(6' (1.8 m))
QACCLA005WJPZ

* Use the power cord that corresponds to the wall outlet in your country.

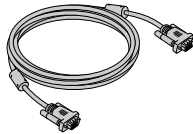

RGB cable
(9'10" (3.0 m))
QCNWGA012WJPZ



DIN-D-sub RS-232C
adaptor (5 57/64" (15 cm))
QCNWGA015WJPZ

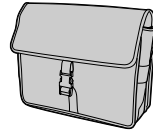

Carrying case
GCASNA006WJSA

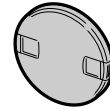

Lens cap (attached)
CCAPHA007WJ01

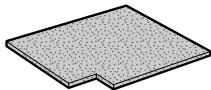

Extra air filter
PFILDA008WJZZ

Projector manual and
technical reference
CD-ROM
UDSKAA022WJN1

"QUICK GUIDE" label
TLABZA191WJZZ

Operation manual
(this manual)

Optional accessories

- | | |
|--|--|
| ■ 3 RCA to 15-pin D-sub cable (9'10" (3.0 m)) | AN-C3CP |
| ■ Computer RGB cable (32'10" (10.0 m)) | AN-C10BM
(for IBM-PC, NEC PC-9821 and PC-98NX series)
AN-C10MC (for Macintosh series)
AN-C10PC
(for NEC PC-98 series (Except NEC PC-9821 and
PC-98NX series)) |
| ■ 5 BNC to 15-pin D-sub cable (9'10" (3.0 m)) | AN-C3BN |
| ■ RS-232C serial control cable (32'10" (10.0 m)) | AN-C10RS |
| ■ Remote receiver | AN-MR1EL |

Note

- Some of the cables may not be available depending on the region. Please check with your nearest Sharp Authorized Projector Dealer or Service Center.





Connecting the Projector to Other Devices

Before Connecting



- Before connecting, be sure to turn off both the projector and the devices to be connected. After making all connections, turn on the projector and then the other devices. When connecting a computer, be sure that it is the last device to be turned on after all the connections are made.
- Be sure to read the operation manuals of the devices to be connected before making connections.

This projector can be connected to:

A computer using:

- An RGB cable and a ø3.5 mm audio cable (commercially available) (See page 16.)
- A DIN-D-sub RS-232C adaptor and an RS-232C serial control cable (AN-C10RS) (sold separately) (See page 20.)

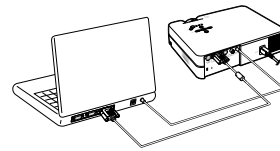

Component video or audio-visual equipment:

- A VCR, Laser disc player or other audio-visual equipment (See page 18.)
- A DVD player or DTV* decoder (See page 19.)

*DTV is the umbrella term used to describe the new digital television system in the United States.

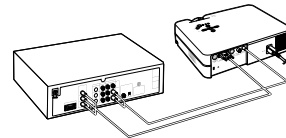
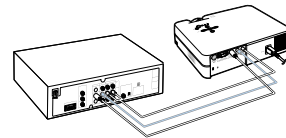

Connecting the Power Cord

Plug the supplied power cord into the AC socket on the rear of the projector.

Supplied accessory

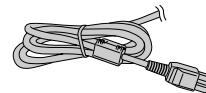

Power cord

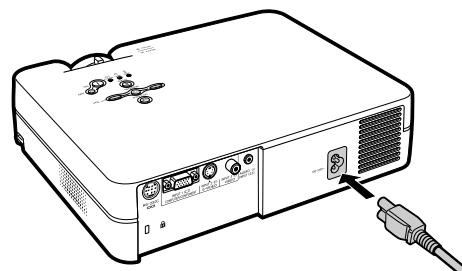



Connecting the Projector to Other Devices

Connecting the Projector to a Computer

Connecting to a Computer Using the RGB Cable

1 Connect the projector to the computer using the supplied RGB cable.

- Secure the connectors by tightening the thumbscrews.

2 To input an audio signal, connect the projector to the computer using a $\varnothing 3.5$ mm audio cable (commercially available or available as Sharp service part QCNWGA013WJPZ).

Note

- When connecting the projector to a computer in this way, select "RGB" for "Signal Type" in the "Picture" menu. See page 37.
- See page 62 "Computer Compatibility Chart" for a list of computer signals compatible with the projector. Use with computer signals other than those listed may cause some of the functions to not work.
- A Macintosh adaptor may be required for use with some Macintosh computers. Contact your nearest Sharp Authorized Projector Dealer or Service Center.
- Depending on the computer you are using, an image may not be projected unless the signal output setting of the computer is switched to the external output. Refer to the computer operation manual for switching the computer signal output settings.

Supplied accessories



RGB cable

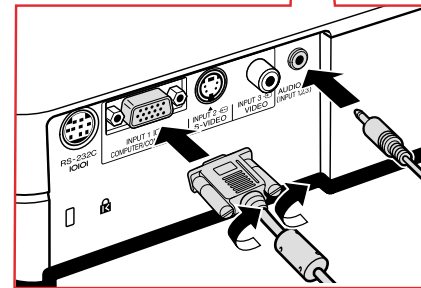
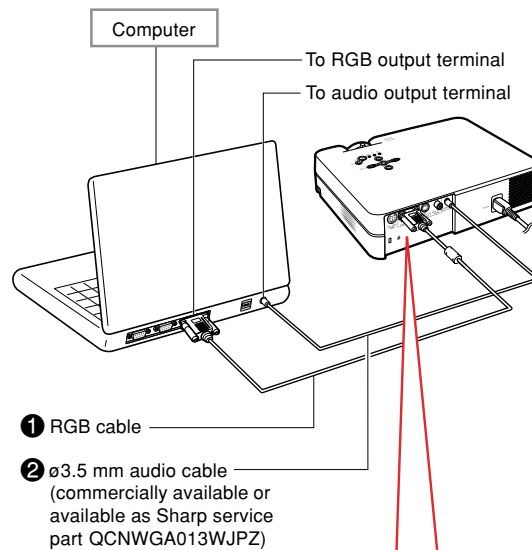

Connecting the thumbscrew cables

- Connect the thumbscrew cable making sure that it fits correctly into the terminal. Then, firmly secure the connectors by tightening the screws on both sides of the plug.
- Do not remove ferrite cores attached to the RGB cable.

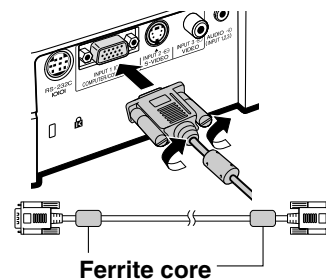



“Plug and Play” function (when connecting to a 15-pin terminal)

- This projector is compatible with VESA-standard DDC 1/DDC 2B. The projector and a VESA DDC compatible computer will communicate their setting requirements, allowing for quick and easy setup.
- Before using the “Plug and Play” function, be sure to turn on the projector first and the connected computer last.



Note

- The DDC “Plug and Play” function of this projector operates only when used in conjunction with a VESA DDC compatible computer.



Connecting the Projector to Other Devices

Connecting to Video Equipment

Connecting to Video Equipment Using an S-video, a Composite Video or an Audio Cable

Using an S-video, video, or audio cable, a VCR, laser disc player or other audio-visual equipment can be connected to INPUT 2, INPUT 3 and AUDIO input terminals.

1 Connect the projector to the video equipment using an S-video cable or a composite video cable (both commercially available).

2 Connect the projector to the video equipment using a $\varnothing 3.5$ mm minijack to RCA audio cable (commercially available).

Note

- The INPUT 2 (S-VIDEO) terminal uses a video signal system in which the picture is separated into color and luminance signals to realize a higher-quality image. To view a higher-quality image, use a commercially available S-video cable to connect the INPUT 2 terminal on the projector and the S-video output terminal on the video equipment.
- A $\varnothing 3.5$ mm minijack to RCA audio cable (commercially available) is required for audio input.

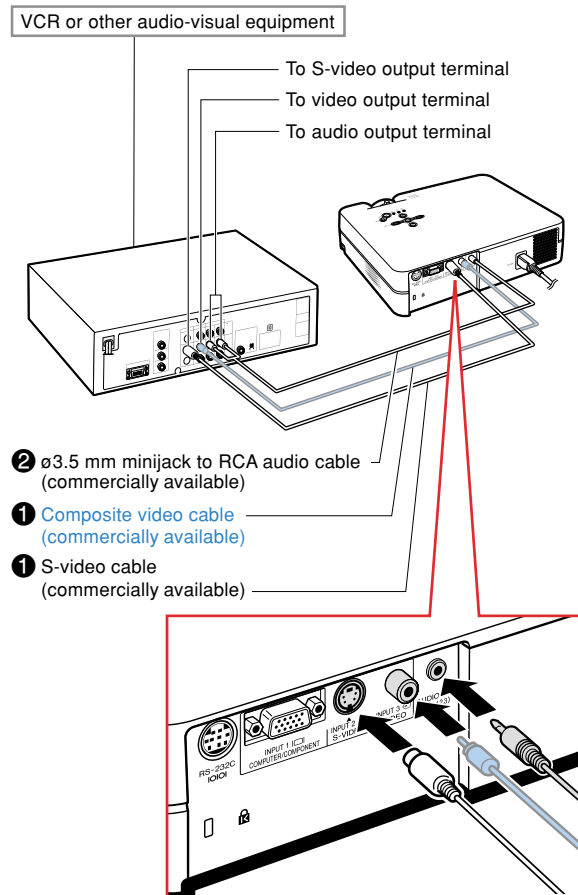



Connecting to Component Video Equipment

Use a 3 RCA to 15-pin D-sub cable when connecting to the INPUT 1 terminal, component video equipment such as DVD players and DTV* decoders.

*DTV is the umbrella term used to describe the new digital television system in the United States.

1 Connect the projector to the video equipment using the 3 RCA to 15-pin D-sub cable.

2 Connect the projector to the video equipment using a $\varnothing 3.5$ mm minijack to RCA audio cable (commercially available).

Note

- When connecting the projector to the video equipment in this way, select "Component" for "Signal Type" in the "Picture" menu. See page 37.
- A $\varnothing 3.5$ mm minijack to RCA audio cable (commercially available) is required for audio input.

Optional cable

3RCA to 15-pin D-sub cable
Type: AN-C3CP
(9'10" (3.0 m))

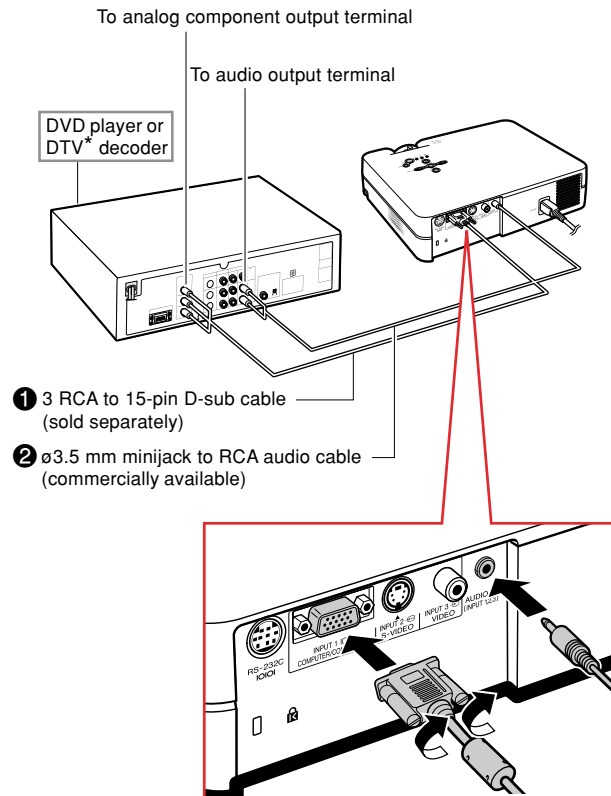



Connecting the Projector to Other Devices

Controlling the Projector Using a Computer

Connecting to a Computer Using a DIN-D-sub RS-232C Adaptor and an RS-232C Serial Control Cable

When the RS-232C terminal on the projector is connected to a computer with a DIN-D-sub RS-232C adaptor and an RS-232C serial control cable (cross type, sold separately), the computer can be used to control the projector and check the status of the projector. See page 61 for details.

1 Connect the supplied DIN-D-sub RS-232C adaptor to an RS-232C serial control cable (sold separately).

2 Use the above cables to connect the projector and the computer.

Note

- Do not connect or disconnect an RS-232C serial control cable to or from the computer while it is on. This may damage your computer.
- The RS-232C function may not operate if your computer terminal is not correctly set up. Refer to the operation manual of the computer for details.
- See page 60 for connection of an RS-232C serial control cable.

Supplied accessory

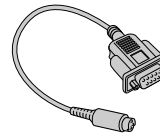

DIN-D-sub RS-232C adaptor

Optional cable

RS-232C serial control cable
Type: AN-C10RS (32'10" (10.0 m))

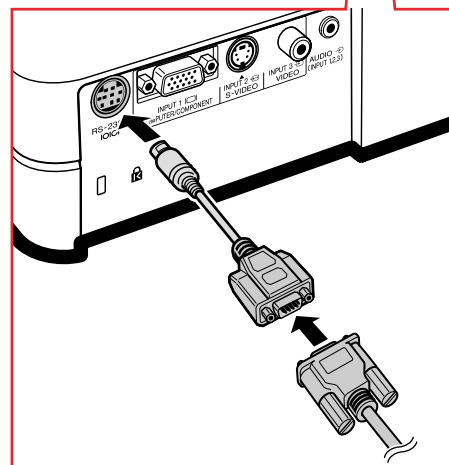
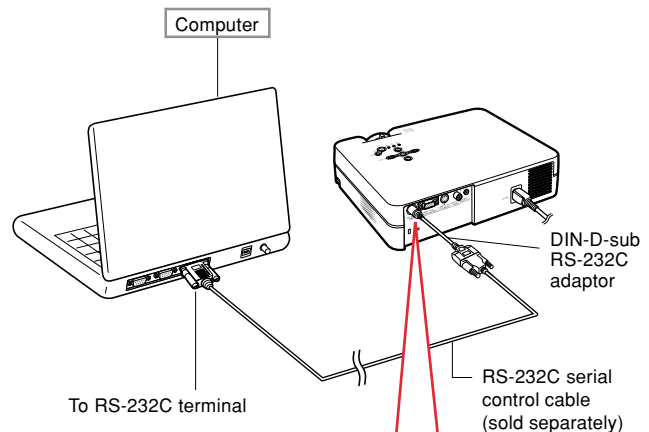

Setup

Using the Adjustment Feet

The height of the projector can be adjusted using the adjustment feet at the front and rear of the projector when the surface the projector is placed on is uneven or when the screen is slanted.

The projection of the image can be made higher by adjusting the projector when it is in a lower place than the screen.

1 While pressing the foot releases on both sides, lift the projector to adjust its height and then remove your fingers from the foot releases.

2 Rotate the adjustment feet at the front of the projector for fine adjustment.

- You can adjust the projection by using the rear adjustment foot on the bottom of the projector when the projector is positioned at the higher place than the screen.

Note

- When returning the projector to its original position, hold the projector firmly, press the foot releases and then gently lower it.
- The projector is adjustable up to approximately 12 degrees at the front and 3 degrees at the back from the standard position.

Info

- Do not press the foot releases when the adjustment feet are extended without firmly holding the projector.
- Do not hold the lens when lifting or lowering the projector.
- When lowering the projector, be careful not to get your fingers caught in the area between the adjustment foot and the projector.

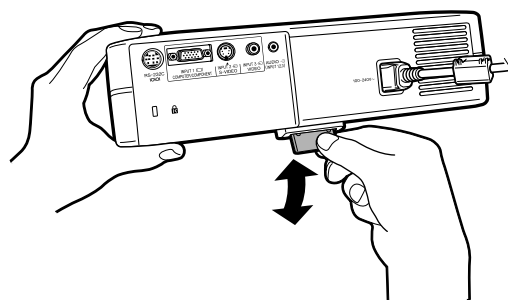
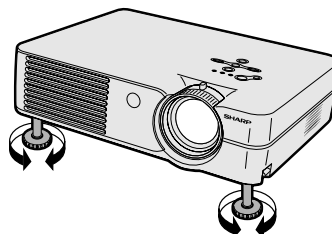
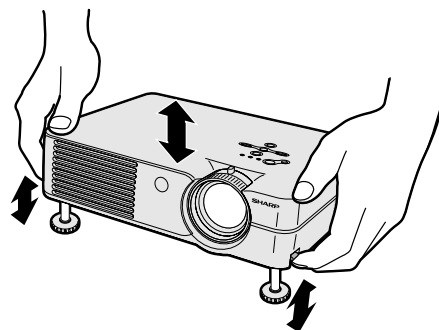
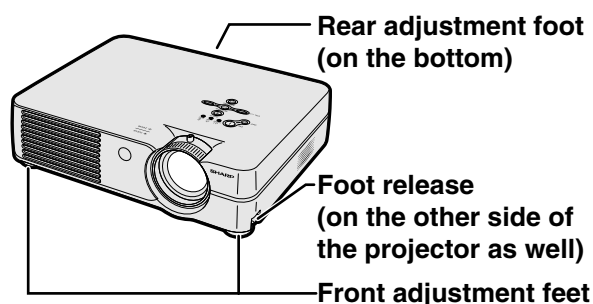



Setup

Adjusting the Lens

The image is focused and adjusted to the desired size using the focus ring or zoom knob on the projector.

Focus ring Zoom knob

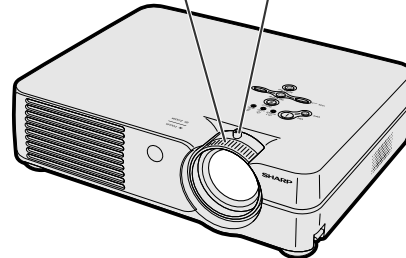

- 1** Adjust the focus by rotating the focus ring.

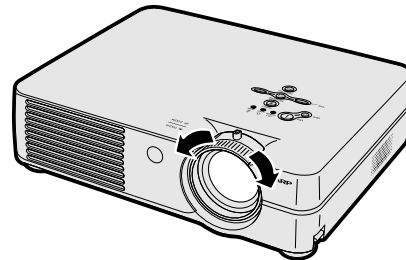

- 2** Adjust zooming by moving the zoom knob.

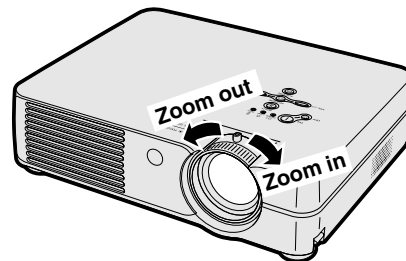



Setting up the Screen

Position the projector perpendicular to the screen with all feet flat and level to achieve an optimal image.

Note

- The projector lens should be centered in the middle of the screen. If the horizontal line passing through the lens center is not perpendicular to the screen, the image will be distorted, making viewing difficult.
- For an optimal image, position the screen so that it is not in direct sunlight or room light. Light falling directly on the screen washes out the colors, making viewing difficult. Close the curtains and dim the lights when setting up the screen in a sunny or bright room.
- A polarizing screen cannot be used with this projector.

Standard Setup (Front Projection)

- Place the projector at the required distance from the screen according to the desired picture size. (See page 24.)

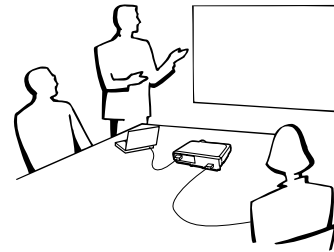

Example of standard setup

Side View

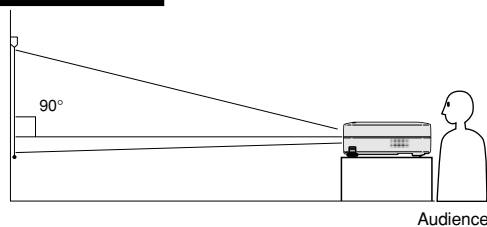

- The distance from the screen to the projector may vary depending on the size of the screen.

P.24

- The default setting can be used, when placing the projector in front of the screen. If the projected image is reversed or inverted, readjust the setting to "Front" in the "PRJ Mode" menu.

P.50

Top View

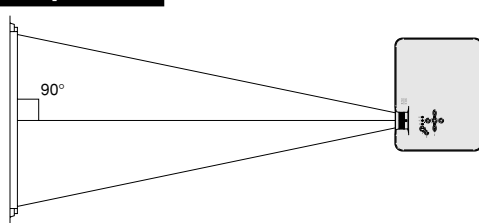

- Place the projector so that an imaginary horizontal line that passes through the center of the lens is perpendicular to the screen.

Setup

Screen Size and Projection Distance

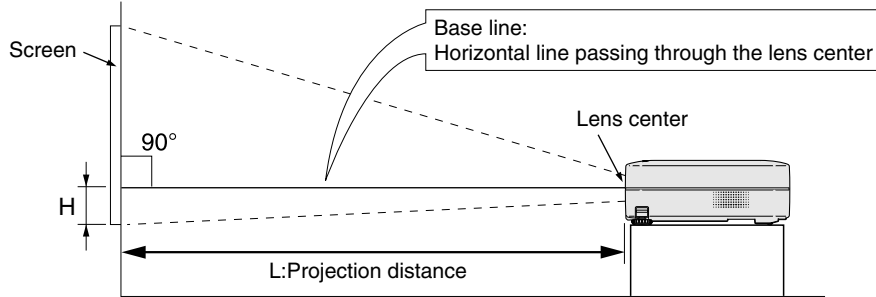

NORMAL Mode (4:3)

Picture (Screen) size			Projection distance (L)		Distance from the lens center to the bottom of the image (H)
Diag. (χ)	Width	Height	Maximum (L1)	Minimum (L2)	
300" (762 cm)	240" (610 cm)	180" (457 cm)	38' 9" (11.8 m)	32' 2" (9.8 m)	18 3/16" (46.2 cm)
250" (635 cm)	200" (508 cm)	150" (381 cm)	32' 2" (9.8 m)	26' 11" (8.2 m)	15 5/32" (38.5 cm)
200" (508 cm)	160" (406 cm)	120" (305 cm)	25' 11" (7.9 m)	21' 4" (6.5 m)	12 1/8" (30.8 cm)
150" (381 cm)	120" (305 cm)	90" (229 cm)	19' 4" (5.9 m)	16' 1" (4.9 m)	9 3/32" (23.1 cm)
100" (254 cm)	80" (203 cm)	60" (152 cm)	12' 10" (3.9 m)	10' 6" (3.2 m)	6 1/16" (15.4 cm)
84" (213 cm)	67" (170 cm)	50" (128 cm)	10' 10" (3.3 m)	8' 10" (2.7 m)	5 3/32" (12.9 cm)
72" (183 cm)	58" (147 cm)	43" (110 cm)	9' 2" (2.8 m)	7' 7" (2.3 m)	4 23/64" (11.1 cm)
60" (152 cm)	48" (122 cm)	36" (91 cm)	7' 7" (2.3 m)	6' 3" (1.9 m)	3 41/64" (9.2 cm)
40" (102 cm)	32" (81 cm)	24" (61 cm)	4' 11" (1.5 m)	4' 3" (1.3 m)	2 27/64" (6.2 cm)

The formula for picture size and projection distance

[Feet/inches]

$$L1 (ft) = (0.0396X - 0.0546) / 0.3048$$

$$L2 (ft) = (0.0330X - 0.0546) / 0.3048$$

$$H (in) = 0.0606X$$

[m/cm]

$$L1 (m) = 0.0396X - 0.0546$$

$$L2 (m) = 0.0330X - 0.0546$$

$$H (cm) = 0.0606X \times 2.54$$

χ: Picture size (diag.) (in/cm)

L: Projection distance (ft/m)

L1: Maximum projection distance (ft/m)

L2: Minimum projection distance (ft/m)

H: Distance from the lens center to the bottom of the image (in/cm)

STRETCH Mode (16:9)

Picture (Screen) size			Projection distance (L)		Distance from the lens center to the bottom of the image (H)
Diag. (χ)	Width	Height	Maximum (L1)	Minimum (L2)	
250" (635 cm)	218" (553 cm)	123" (311 cm)	35' 1" (10.7 m)	29' 2" (8.9 m)	-4 33/64" (-11.5 cm)
225" (572 cm)	196" (498 cm)	110" (280 cm)	31' 10" (9.7 m)	26' 3" (8.0 m)	-4 1/16" (-10.3 cm)
200" (508 cm)	174" (443 cm)	98" (249 cm)	28' 3" (8.6 m)	23' 3" (7.1 m)	-3 39/64" (-9.2 cm)
150" (381 cm)	131" (332 cm)	74" (187 cm)	21' (6.4 m)	17' 5" (5.3 m)	-2 45/64" (-6.9 cm)
133" (338 cm)	116" (294 cm)	65" (166 cm)	18' 8" (5.7 m)	15' 5" (4.7 m)	-2 13/32" (-6.1 cm)
106" (269 cm)	92" (235 cm)	52" (132 cm)	14' 9" (4.5 m)	12' 6" (3.8 m)	-1 59/64" (-4.9 cm)
100" (254 cm)	87" (221 cm)	49" (125 cm)	14' 1" (4.3 m)	11' 6" (3.5 m)	-1 13/16" (-4.6 cm)
92" (234 cm)	80" (204 cm)	45" (115 cm)	12' 10" (3.9 m)	10' 10" (3.3 m)	-1 21/32" (-4.2 cm)
84" (213 cm)	73" (186 cm)	41" (105 cm)	11' 10" (3.6 m)	9' 10" (3.0 m)	-1 33/64" (-3.9 cm)
72" (183 cm)	63" (159 cm)	35" (90 cm)	10' 2" (3.1 m)	8' 2" (2.5 m)	-1 19/64" (-3.3 cm)
60" (152 cm)	52" (133 cm)	29" (75 cm)	8' 2" (2.5 m)	6' 11" (2.1 m)	-1 5/64" (-2.8 cm)
40" (102 cm)	35" (89 cm)	20" (50 cm)	5' 7" (1.7 m)	4' 7" (1.4 m)	-23/32" (-1.8 cm)

The formula for picture size and projection distance

[Feet/inches]

$$L1 (ft) = (0.04314X - 0.0546) / 0.3048$$

$$L2 (ft) = (0.03595X - 0.0546) / 0.3048$$

$$H (in) = -0.01807X$$

[m/cm]

$$L1 (m) = 0.04314X - 0.0546$$

$$L2 (m) = 0.03595X - 0.0546$$

$$H (cm) = -0.01807X \times 2.54$$

Note

- There may be an error of ± 3% in the above values.
- Values with a minus (-) sign indicate the distance from the lens center below the bottom of the image.



Projecting a Reversed/Inverted Image

Projection from behind the Screen

- Place a translucent screen between the projector and the audience.
- Reverse the image by setting “Rear” in the “PRJ Mode” menu. See page 50 for use of this function.

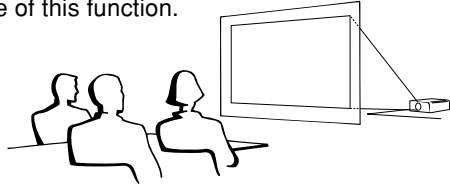

When using the default setting.
▼On-screen Display

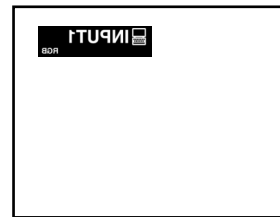

The image is reversed.

Projection Using a Mirror

- Place a mirror (normal flat type) in front of the lens.

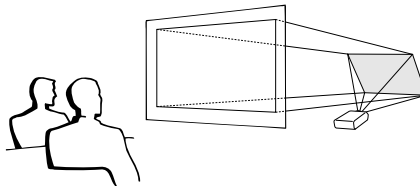

Info

- When using a mirror, be sure to carefully position both the projector and the mirror so the light does not shine into the eyes of the audience.

Ceiling-mount Setup

- It is recommended that you use the optional Sharp ceiling-mount bracket for this installation. Before mounting the projector, contact your nearest Sharp Authorized Projector Dealer or Service Center to obtain the recommended ceiling-mount bracket (sold separately).
 - AN-PGCM95 ceiling-mount bracket, its AN-EP101B extension tube and AN-JT299 universal bracket, adaptor for non-level ceiling installation (for U.S.A.).
 - BB-A10T ceiling adaptor, its BB-NVHOLDER280, BB-NVHOLDER550, BB-NVHOLDER900 ceiling mount systems (for GERMANY).
 - AN-A10T ceiling-mount bracket, its AN-TK201 and AN-TK202 extension tubes (for countries other than the U.S.A. and GERMANY).

- Be sure to adjust the position of the projector to match the distance (H) from the lens center position (see page 24) to the lower edge of the image, when mounting the projector on the ceiling.

- Invert the image by setting “Ceiling+Front” in the “PRJ Mode” menu. See page 50 for use of this function.

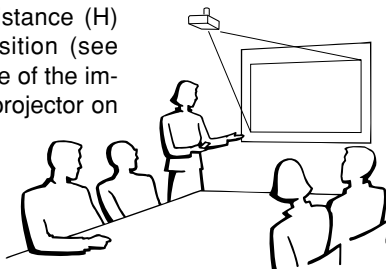

When using the default setting.
▼On-screen Display

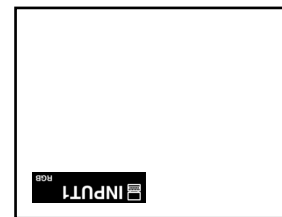

The image is inverted.



Image Projection

Basic Procedure

Connect the required external equipment to the projector before carrying out the following procedures.

Info

- The language preset at the factory is English. If you want to change the on-screen display to another language, reset the language according to the procedure on page 28.

1 Plug the power cord into the wall outlet.

- The power indicator illuminates red, and the projector enters standby mode.

2 Press ON (I) on the projector or ON (I) on the remote control.

- The power indicator illuminates green. After the lamp replacement indicator illuminates and the warming up message on the display disappears, the projector is ready to start operation.

Note

- The lamp replacement indicator illuminates, indicating the status of the lamp.
 - Green:** The lamp is ready.
 - Blinking in green:** The lamp is warming up and shutting down.
 - Red:** The lamp should be replaced.
- If the power is turned off and immediately switched on again, the lamp replacement indicator may take some time to illuminate.
- When controlling the projector using RS-232C commands from a computer, wait for at least 30 seconds after the power has been turned on, and then transmit the commands.
- The projector cannot be operated while the warming up message is displayed.

- When "Anti-Theft" (see page 48) is set, the keycode input box will appear. Enter the keycode.

Note

- When entering the keycode, press the buttons previously set on the projector or the remote control.
- For details about the Anti-Theft function, refer to "Anti-Theft (Setting the Anti-Theft)" on page 48.

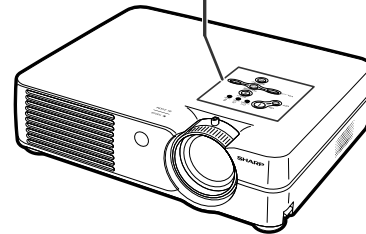
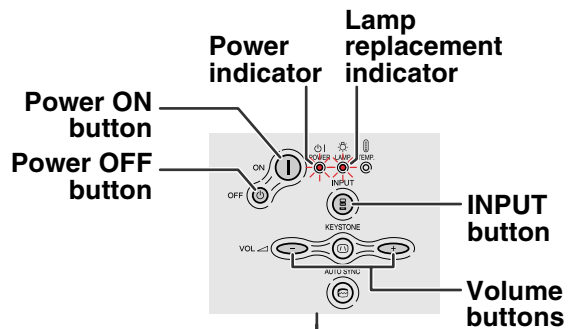

▼Warming up message

Warming Up. Please Wait.

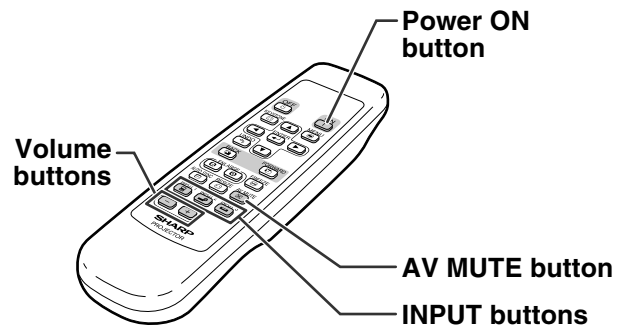



▼Keycode input box

Anti-Theft [] - - -



3 Press , or on the remote control to select the INPUT mode.

- After pressing  once on the projector, use  to select the desired input mode.

Note





- When no signal is received, "NO SIGNAL" will be displayed. When a signal that the projector is not preset to receive is received, "NOT REG." will be displayed.
- The INPUT mode is not displayed when "OSD Display" is set to "OFF". (See page 44.)

About the INPUT mode

INPUT 1 (RGB/ Component)	Used for projecting images from equipment that sends RGB signals or component signals connected to the RGB input terminal.
INPUT 2 (S-Video)	Used for projecting images from equipment connected to the S-VIDEO input terminal.
INPUT 3 (Video)	Used for projecting images from equipment connected to the VIDEO input terminal.

4 Press or on the remote control to adjust the volume.

Note

- Pressing  will lower the volume. Pressing  will raise the volume.
- On the projector, the volume can be adjusted by pressing  or .

5 Press on the remote control to temporarily display a black screen and turn off the sound.

Note

- Pressing  again will turn the projected image and sound back on.

▼ On-screen Display (Example)

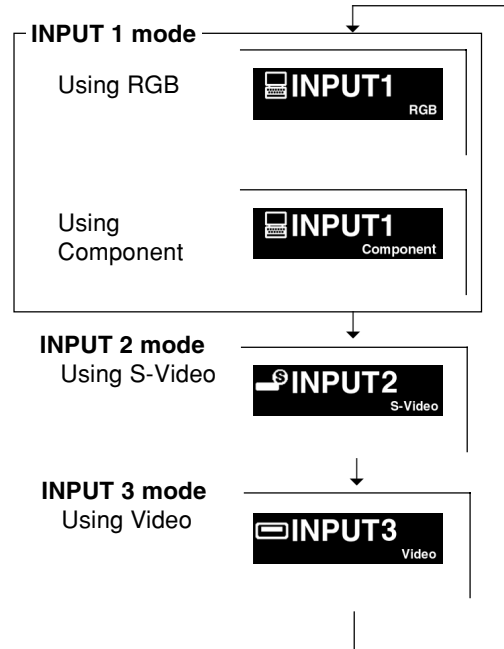

VOLUME





AV MUTE

Image Projection

- 6** Press **OFF**  on the projector or **OFF**  on the remote control, then press that button again while the confirmation message is displayed, to turn off the projector.

Note

- If you accidentally pressed **OFF**  or **OFF**  and do not want to turn off the power, wait until the confirmation message disappears.
- The projector cannot be operated while a message "Shutting down. Please wait." is displayed.

Info

- Do not unplug the power cord during projection or cooling fan operation. This can cause damage due to rise in internal temperature, as the cooling fan also stops.

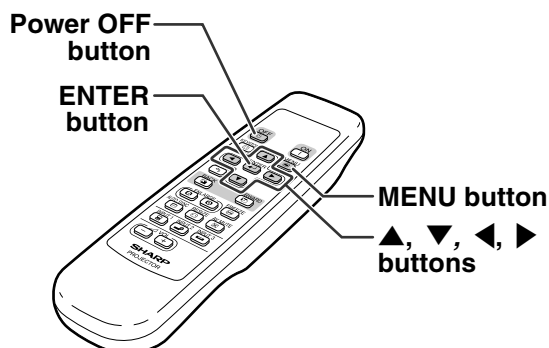



 Turn Power OFF?
Yes: Press Again. No: Please Wait.

Shutting down. Please wait.

Selecting the On-screen Display Language

The on-screen display language of the projector can be set to English, German, Spanish, Dutch, French, Italian, Swedish, Portuguese, Chinese, Korean or Japanese. For operating the menu screen, see pages 32 to 35.

- 1** Press **MENU**  on the remote control.
 - The "Picture" menu will be displayed.
- 2** Press **◀** or **▶** to select the "Language" menu icon.
 - The "Language" menu will be displayed.
- 3** Press **▲** or **▼** to select the desired language, and then press **ENTER** .
- 4** Press **MENU** .
 - The desired language will be set as the on-screen display.

"Language" menu icon





Keystone Correction (Correcting Trapezoidal Distortion)







Correcting Trapezoidal Distortion

This function allows for Keystone (On-screen Trapezoidal Distortion) Correction.

Note



- When the image is projected either from the top or from the bottom towards the screen at an angle, the image becomes distorted trapezoidally. The function for correcting trapezoidal distortion is called Keystone Correction.
- The Keystone Correction can be adjusted up to an angle of approximately ± 35 degrees.

- 1 Press  . You can also use  on the projector.

- 2 Press , ,  and  to adjust the Keystone correction. You can also adjust the Keystone correction using the  or  buttons on the projector.

Note

- Since the trapezoidal distortion of the image can be corrected up to an angle of approximately ± 35 degrees, the actual screen can be diagonally set up to that angle as well.
- Press  to make the default setting.
- Straight lines or the edges of images may appear jagged while adjusting the image.

- 3 Press  . You can also use  on the projector.

Note

- You can use the same settings used in NORMAL mode 4:3 for 16:9.

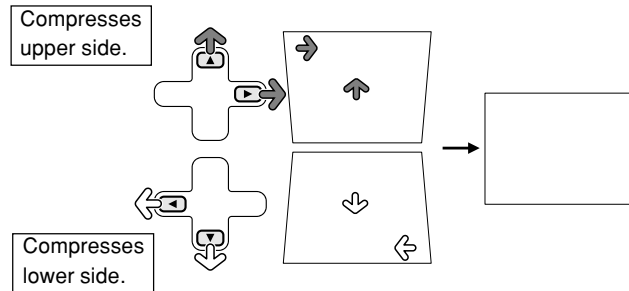
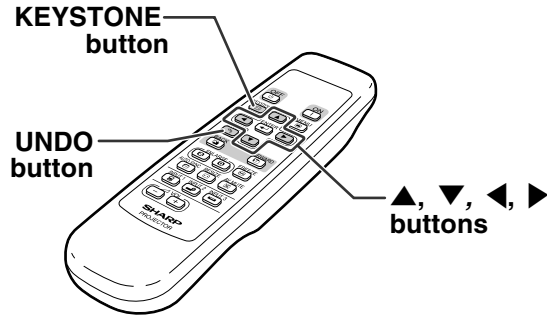



Menu Items

This list shows the items that can be set in the projector.

INPUT 1 Mode

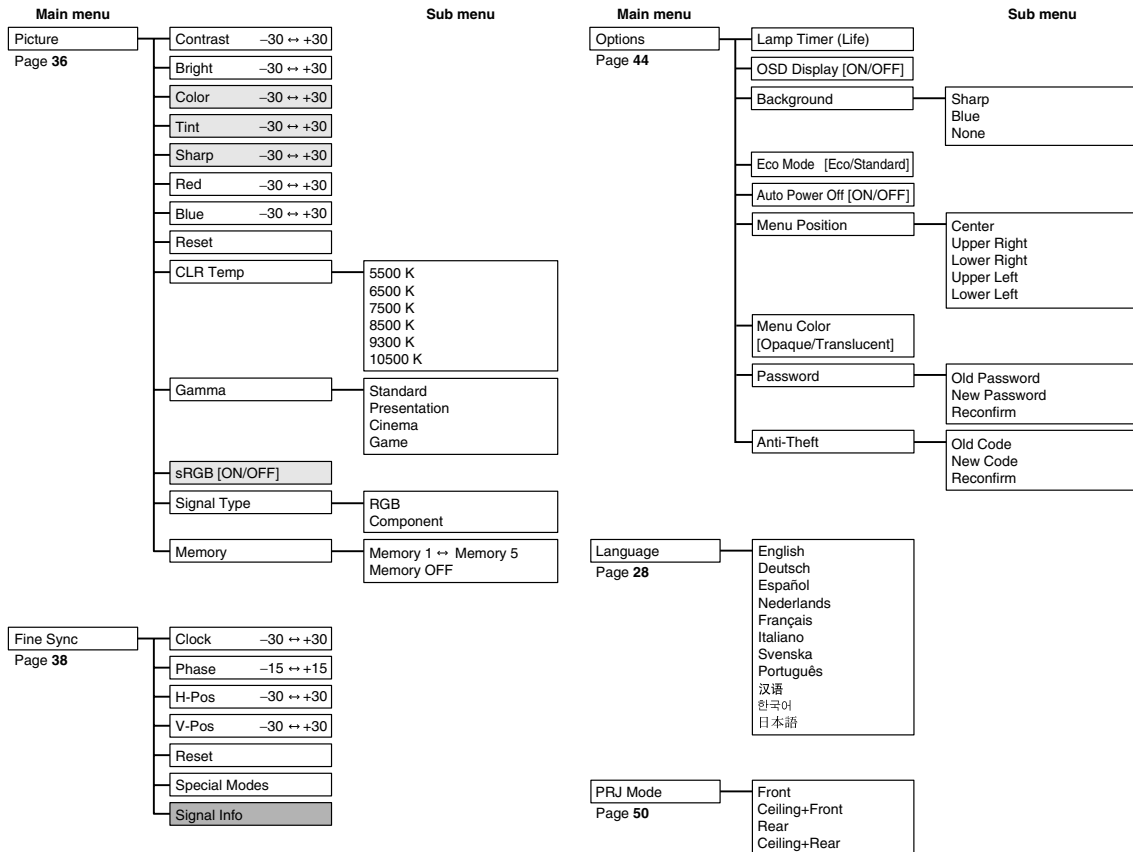

Note

- In the "Picture" menu of INPUT 1, "Color", "Tint" and "Sharp" are only displayed when "Signal Type" is set to "Component".
- In the "Picture" menu of INPUT 1, "sRGB" is only displayed when "Signal Type" is set to "RGB".
- In the "Fine Sync" menu of INPUT 1, "Signal Info" can only be selected when "Signal Type" is set to "Component".





■ INPUT 2 / 3 Mode

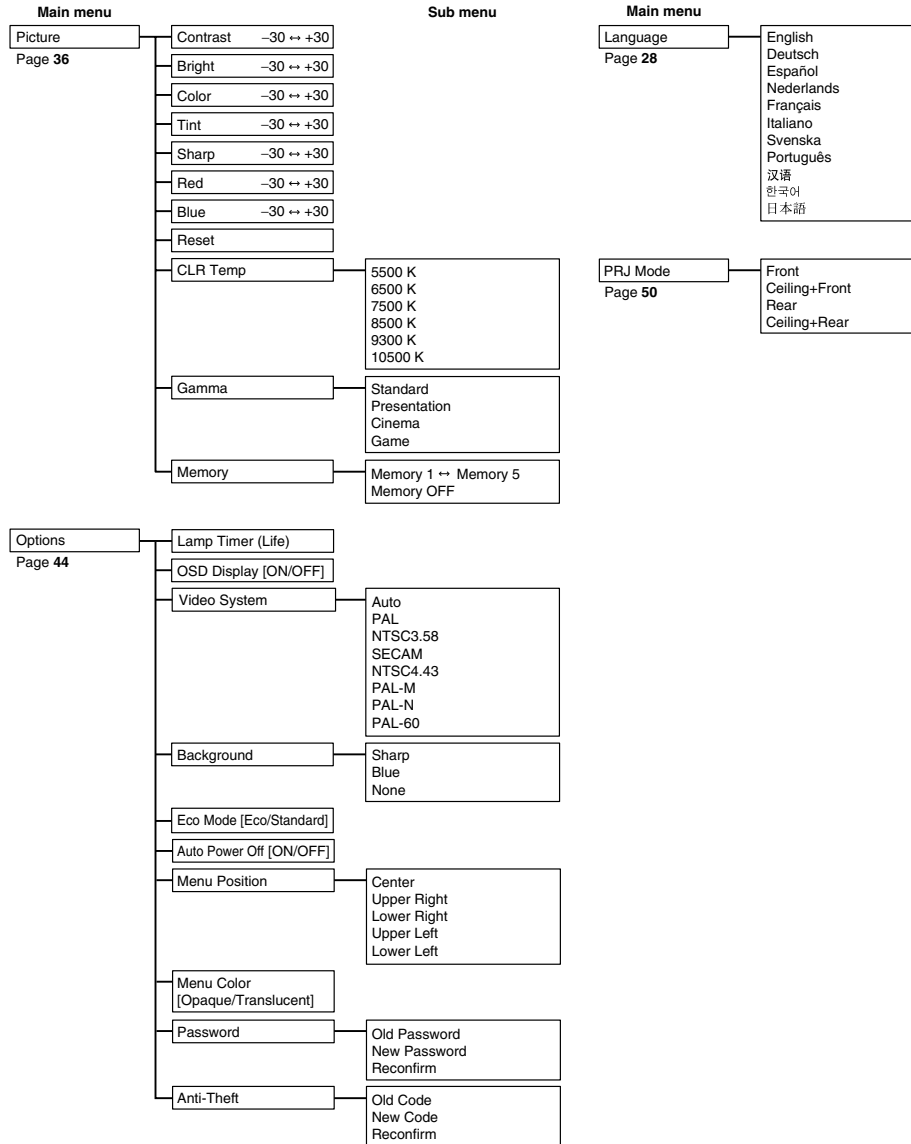



Using the Menu Screen

The menu screens allow you to adjust the image and various projector settings. You can operate the menus from the remote control using the following procedure.

Example: "Picture" menu screen for INPUT 1 (RGB) mode

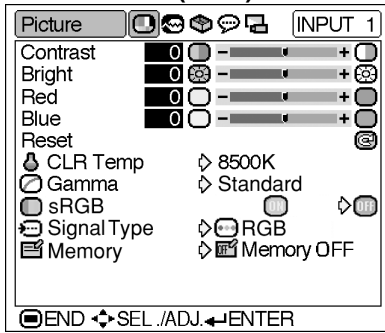

Menu Selections (Adjustments)

1 Press MENU.

- The "Picture" menu screen for the selected input mode is displayed.

Note

- The on-screen display shown on the right is displayed when the INPUT 1 (RGB) mode is selected.

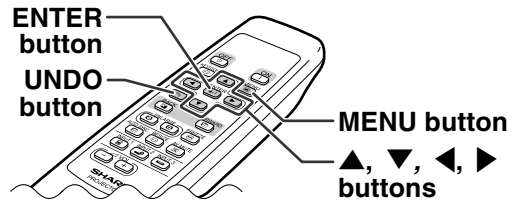

2 Press or to display the other menu screens.

- The menu icon for the selected menu screen is highlighted.

Menu icon	Menu screen
	Picture
	Fine Sync
	Options
	Language
	PRJ Mode

Note

- The "Fine Sync" menu is not available for INPUT 2 or 3.
- For details on the menus, see the tree charts on pages 30 and 31.

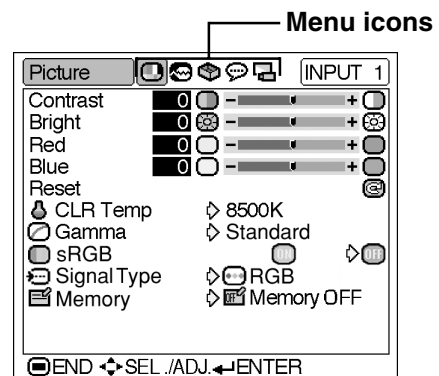



3 Press ▲ or ▼ to select the item you want to adjust.

- The selected item is highlighted.

Note

- To display a single adjustment item, press after selecting the item. Only the selected adjustment item will be displayed. Then if you press ▲ or ▼, the following item ("Red" after "Bright") will be displayed.
- Press to return to the previous screen.

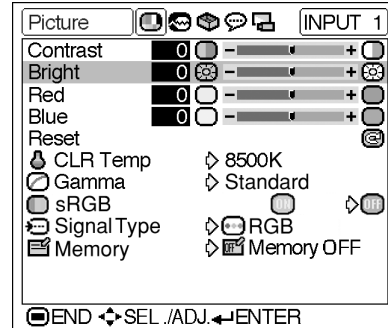

4 Press ◀ or ▶ to adjust the item selected.

- The adjustment is stored.

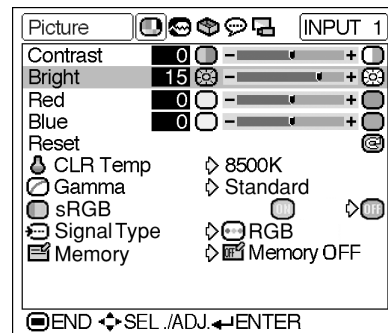

5 Press .

- The menu screen will disappear.



Using the Menu Screen

Menu Selections (Settings)

1 Press .

- The "Picture" menu screen for the selected input mode is displayed.



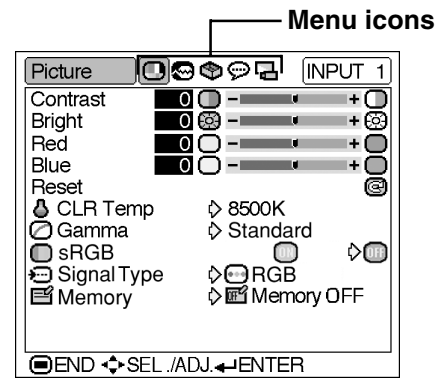
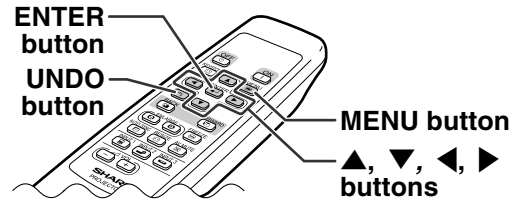

Note

- The on-screen display shown on the right is displayed when INPUT 1 (RGB) mode is selected.



2 Press or to display the other menu screens.

- The menu icon for the selected menu screen is highlighted.

Menu icon	Menu screen
	Picture
	Fine Sync
	Options
	Language
	PRJ Mode

Note

- The "Fine Sync" menu is not available for INPUT 2 or 3.
- For details on the menus, see the tree charts on pages 30 and 31.

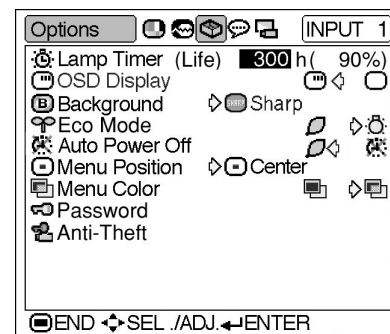



- 3** Press ▲ or ▼ to select the item you want to set, and then press ► to display the sub menu.
- The selected item is highlighted.

Note

UNDO

- Press or ◀ to return to the previous screen.
- For some items, press ◀ or ▶ to select the icon using “”.

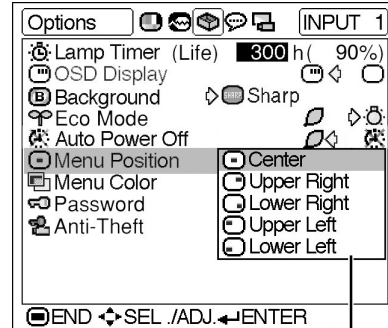

Sub menu

- 4** Press ▲ or ▼ to select the setting of the item displayed in the sub menu.

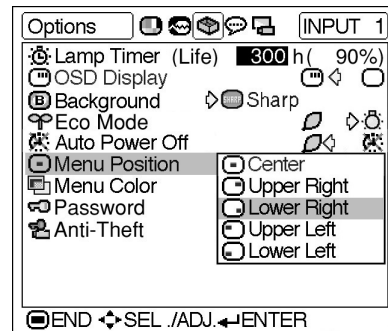

- 5** Press .
- The item selected is set.

- 6** Press .
- The menu screen will disappear.





Picture Adjustment

You can adjust the projector's picture to your preferences using the "Picture" menu. For operation of the menu screen, see pages 32 to 35.

Example: "Picture" screen menu for INPUT 1 (RGB) mode

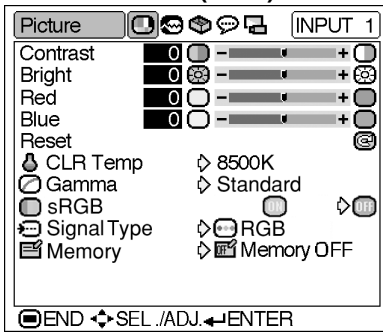

Adjusting the Image

Select the item on the "Picture" menu and adjust the image.

Description of Adjustment Items

Selectable items	Press ◀	Press ▶
Contrast	for less contrast.	for more contrast.
Bright	for less brightness.	for more brightness.
Color	for less color intensity.	for more color intensity.
Tint	for making skin tones purplish.	for making skin tones greenish.
Sharp	for less sharpness.	for more sharpness.
Red	for weaker red.	for stronger red.
Blue	for weaker blue.	for stronger blue.

Note

- "Color", "Tint" and "Sharp" are not displayed when selecting INPUT 1 and setting the "Signal Type" to "RGB".
- "Sharp" can be adjusted when 480I, 480P, 540P, 580I, 580P, 720P, 1035I or 1080I signals are detected while "Signal Type" for INPUT 1 is set to "Component".
- To reset all adjustment items, select "Reset" and press .

CLR Temp (Adjusting the Color Temperature)

Select "CLR Temp" on the "Picture" menu and the desired color temperature setting.

Description of Color Temperature Settings

Selectable settings	Description
5500K	For lower color temperature for warmer, reddish incandescent-like images.
6500K	
7500K	
8500K	
9300K	For higher color temperature for cooler, bluish, fluorescent-like images.
10500K	

Note

- Values for "CLR Temp" are only approximations.





Gamma (Gamma Correction)

Gamma is an image quality enhancement function that offers a richer image by brightening the darker portions of the image without altering the brightness of the brighter portions.

When you are displaying images with frequent dark scenes, such as a film or concert, or when you are displaying images in a bright room, this feature makes the dark scenes easier to see and gives the impression of greater depth in the image.

Select “Gamma” on the “Picture” menu and the desired gamma mode.

Standard
Presentation
Cinema
Game

Description of Gamma Modes

Selectable settings	Description
Standard	For standard image
Presentation	Brightens darker portions of image for more enhanced presentations.
Cinema	Gives greater depth to darker portions of image for a more exciting theater experience.
Game	For natural color gradation for playing a game, etc.

Note

- Gamma is not available for INPUT 1 when “sRGB” on the “Picture” menu is set to “ON”.

sRGB (sRGB Setting)

Select “sRGB” on the “Picture” menu and set it to “ON” when you want to display the image in a natural tint based on an original image.

Note

- When “sRGB” is set to “ON”;
 - Gamma is not available.
 - “Red”, “Blue” or “CLR Temp” on the “Picture” menu cannot be adjusted.
- For additional information about the sRGB function, visit “<http://www.srgb.com/>”.

Info

- When “sRGB” is set to “ON”, the projected image may become dark, but this does not indicate a malfunction.

Signal Type (Signal Type Setting)

Select “Signal Type” on the “Picture” menu and set it to “RGB” or “Component” for INPUT 1.

Description of Signal Type Settings

Selectable settings	Description
<input type="radio"/> RGB	Set when RGB signals are received.
<input type="radio"/> Component	Set when Component signals are received.

Memory (Storing and Selecting the Adjustment Settings)

Use this function to store the adjustment settings on the “Picture” menu. No matter which input mode or signal type is selected, you can select and apply the settings you have stored in a memory location.

Select “Memory” on the “Picture” menu and the memory location where you want to store the settings. Then adjust the setting items on the “Picture” menu.

Description of Memory Positions

Selectable settings	Description
Memory 1	Settings of all items on the “Picture” menu can be stored in memory location.
Memory 2	The stored settings can be selected in any input mode.
Memory 3	
Memory 4	
Memory 5	
Memory OFF	Besides “Memory 1” to “Memory 5”, other settings on the “Picture” menu can be stored for each input mode. The settings stored in “Memory OFF” cannot be applied when another input mode is selected.

If you want to apply the stored settings on the “Picture” menu, select “Memory” on the “Picture” menu and the memory location where you have stored the settings.

Note

- You can change the stored settings after selecting the memory location for those settings.



Computer Image Adjustment

Using the “Fine Sync” menu, you can adjust the computer image, match the computer display mode, and check the input signal. For operation of the menu screen, see pages 32 to 35.

Example: “Fine Sync” menu screen for INPUT 1 mode

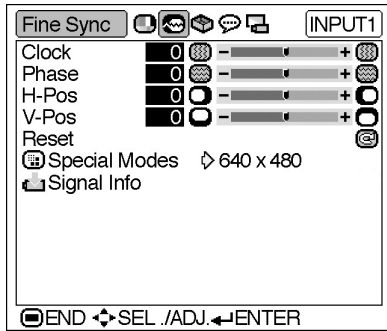

Adjusting the Computer Image

In case of irregularities such as vertical stripes or flickering in portions of the screen, adjust “Clock”, “Phase”, “H-Pos” or “V-Pos” to obtain an optimal computer image.

Select the item on the “Fine Sync” menu and adjust the computer image.

Description of Adjustment Items

Selectable items	Use ◀ and ▶ to
Clock	adjust vertical noise.
Phase	adjust horizontal noise (similar to tracking on your VCR).
H-Pos	center the on-screen image by moving it to the left or right.
V-Pos	center the on-screen image by moving it up or down.

Note

- You can automatically adjust the computer image by pressing on the projector or on the remote control.
- To reset all adjustment items, select “Reset” and press .

Special Modes (Special Mode Settings)

Ordinarily, the type of input signal is detected and the correct resolution mode is automatically selected. However, for some signals, the optimal resolution mode in “Special Modes” on the “Fine Sync” menu may need to be selected to match the computer display mode.

Select “Special Modes” on the “Fine Sync” menu and the appropriate resolution.

Note

- Avoid displaying computer patterns which repeat every other line (horizontal stripes). (Flickering may occur, making the image hard to see.)
- When a DVD player or Digital Video is connected, select 480P as the input signal.
- See “Signal Info (Checking the Input Signal)” on the next page for information on the currently selected input signal.



Signal Info (Checking the Input Signal)

Select “Signal Info” on the “Fine Sync” menu to check the current input signal information.

Note

- The projector will display the number of scanned lines available from audio-visual equipment such as a DVD player or Digital Video.



Picture Display Mode

This function allows you to modify or customize the picture display mode to enhance the input image. Depending on the input signal, you can choose “NORMAL”, “DOT BY DOT”, “BORDER” or “STRETCH” image.

Switching the Picture Display Mode

Press .

- Pressing changes the display as shown on pages 40 and 41.
- To return to the standard image, press while “RESIZE” is displayed on the screen.

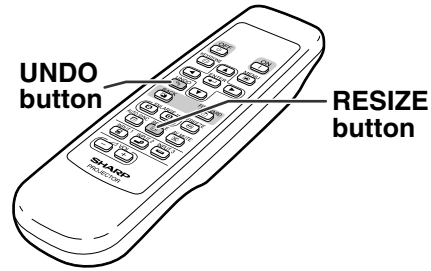

COMPUTER

		NORMAL		DOT BY DOT		BORDER		STRETCH	
		PG-A10X	PG-A10S	PG-A10X	PG-A10S	PG-A10X	PG-A10S	PG-A10X	PG-A10S
4:3 aspect ratio	SVGA (800 × 600)	1024 × 768	800 × 600	800 × 600	—	768 × 576	600 × 450	1024 × 576	800 × 450
	XGA (1024 × 768)			—	1024 × 768				
	SXGA (1280 × 960)			1280 × 960	1280 × 960				
	SXGA+ (1400 × 1050)			1400 × 1050	1400 × 1050				
Other aspect ratios	SXGA (1280 × 1024)	960 × 768	750 × 600	1280 × 1024	1280 × 1024	720 × 576	562 × 450	960 × 576	750 × 450
	1280 × 720	—	—	—	—	—	—	1024 × 576	800 × 450

Input Signal			Output screen image			
Computer		Image type	NORMAL	DOT BY DOT	BORDER	STRETCH
PG-A10X	PG-A10S		Projects a full screen image while maintaining the aspect ratio.	Projects the original resolution signal of the image.	Projects 4:3 image fully in STRETCH (the following column) image.	Projects 16:9 image evenly over entire screen (top/bottom blank bands).
Resolution lower than XGA	Resolution lower than SVGA	4:3 aspect ratio				
XGA	SVGA	4:3 aspect ratio		—		
Resolution higher than XGA	Resolution higher than SVGA	4:3 aspect ratio				
SXGA (1280 × 1024)		5:4 aspect ratio				
1280 × 720		16:9 aspect ratio	—	—	—	

* Mode for projecting an image with the original aspect ratio without cutting any portions.

: Cutout area on which images cannot be projected.
 : Area where the signals are off screen.







VIDEO

		NORMAL		BORDER		STRETCH	
		PG-A10X	PG-A10X	PG-A10X	PG-A10S	PG-A10X	PG-A10S
480I, 480P, 540P, NTSC, PAL, SECAM	4:3 aspect ratio. Letter box, squeeze	1024 × 768	800 × 600	768 × 576	600 × 450	1024 × 576	800 × 450
720P, 1080I	16:9 aspect ratio	—	—	—	—	—	—

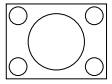
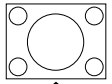
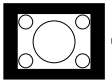
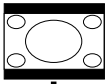
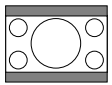
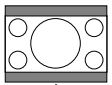
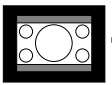
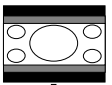
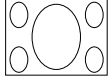
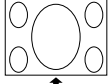
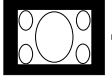
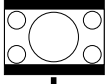
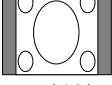
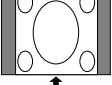
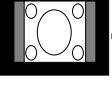
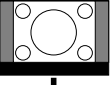
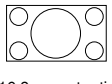
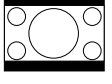
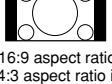
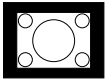
• "STRETCH" is fixed when 720P or 1080I signals are entered.

Input Signal		Output screen image		
		NORMAL Projects a full screen image.	BORDER Projects 4:3 image fully in STRETCH (the following column) image.	STRETCH Projects 16:9 image evenly over entire screen (top/bottom black bands).
DVD / Video	Image type			
480I, 480P, 540P, NTSC, PAL, SECAM	 4:3 aspect ratio	* 	* 	
	 Letter box	* 	* 	
	 Squeezed 16:9 image			* 
	 Squeezed 4:3 image			* 
720P, 1080I (16:9)	 16:9 aspect ratio	—	—	* 
	 16:9 aspect ratio (4:3 aspect ratio in 16:9 screen)	—	—	* 

* Mode for projecting an image with the original aspect ratio without cutting any portions.

 : Cutout area on which images cannot be projected.

 : Area on which the image is not included in the original signals.

Still and Zoom Image

You can instantly freeze a moving image and enlarge a specific portion of an image with the remote control. Using these functions, you can explain the image to the audience more effectively.

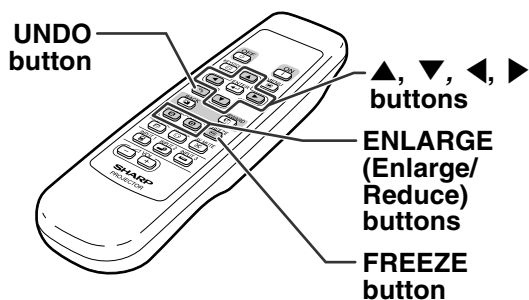

Freezing a Moving Image

1 Press .

- The projected image is frozen.

2 Press again to return to the moving image from the currently connected device.

Displaying an Enlarged Portion of an Image

1 Press .

- Pressing or enlarges or reduces the projected image.

Note

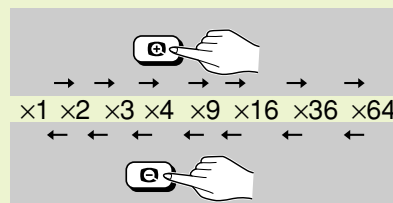

- You can change the location of the enlarged image using ▲, ▼, ◀ and ▶.

2 Press to cancel the operation.

- The magnification then returns to x1.

Note

In the following cases, the image will return to the normal size (x1).

- When switching the INPUT mode.
- When has been pressed.
- When the input signal is changed.
- When the input signal resolution and refresh rate (vertical frequency) change.

Keylock Function

Use this function to lock the operation buttons on the projector.

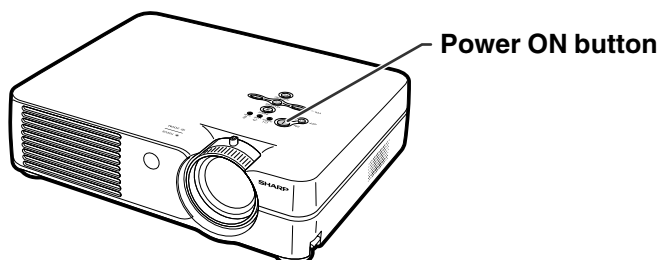

Locking the Operation Buttons

Hold down **ON**  on the projector for about 3 seconds while the projector is being turned on.

Note

- The keylock function does not affect the operation with the remote control buttons.
- You cannot use the keylock function while the projector is warming up.

Taking the Keylock off

Hold down **ON**  on the projector for about 3 seconds while the projector is being turned on.

- You can take the keylock off by holding down **ON**  on the projector for about 3 seconds while the projector is in standby mode.

Keylock function ON

Keylock function OFF

Using the “Options” Menu

You can use the “Options” menu to enhance the usage for the projector. For operation of the menu screen, see pages 32 to 35.

Example: “Options” menu screen for INPUT 2 (S-Video) mode

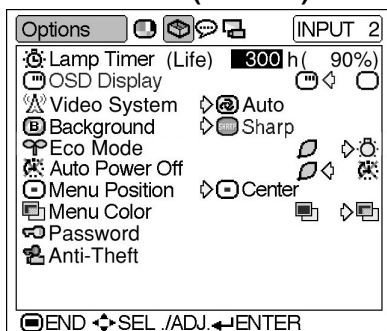

Lamp Timer (Life) (Checking the Lamp Life Status)

You can confirm the cumulative lamp usage time and the remaining lamp life (percentage).

Display the “Options” menu to check the lamp life status.

Description of Lamp Life

Lamp usage condition	Remaining lamp life	
	100%	5%
Used with only “” (Eco mode) in “Eco Mode”	4,500 hours	about 225 hours
Used with only “” (Standard mode) in “Eco Mode”	3,000 hours	about 150 hours

Note

- It is recommended that the lamp be changed when the remaining lamp life becomes 5%. For lamp replacement, contact your nearest Sharp Authorized Projector Dealer or Service Center.
- The table above indicates rough estimates in the case of using only in each mode shown. Remaining lamp life changes within the range of the values shown depending on the frequency at which “Eco Mode” is switched to “” (Eco mode) and “” (Standard mode) (see page 45).

OSD Display (Setting On-screen Display)

This function allows you to turn the on-screen messages on or off.

Select “” (ON) or “” (OFF) in “OSD Display” on the “Options” menu.

Description of “OSD Display” Settings

Selectable settings	Description
<input checked="" type="radio"/> ON	All On-screen Displays are displayed.
<input type="radio"/> OFF	INPUT/VOLUME/AV MUTE/FREEZE/AUTO SYNC/ENLARGE/ “An invalid button has been pressed.” / “All buttons on Projector are locked.” are not displayed.





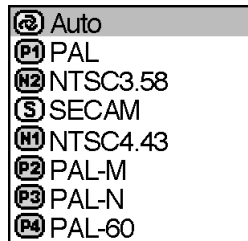

Video System (Setting the Video System)

The video input system mode is preset to “Auto”; however, a clear picture from the connected audio-visual equipment may not be received, depending on the video signal difference. In that case, switch the video signal.

Select “Video System” on the “Options” menu and the appropriate video system.



Description of Video Systems

Selectable settings	Description
 PAL	When connected to PAL video equipment.
 SECAM	When connected to SECAM video equipment.
 NTSC4.43	When reproducing NTSC signals in PAL video equipment.
 NTSC3.58	When connected to NTSC video equipment.

Note



- The video signal can only be set in INPUT 2 or INPUT 3 mode.
- In “Auto”, images are displayed in PAL even if PAL-N or PAL-M input signals are received.

Background (Selecting a Startup and Background Image)

Select “Background” on the “Options” menu and the image displayed upon the projector’s startup and when no signal is being sent to the projector.





Description of Background Images

Selectable settings	Description
 Sharp	SHARP default image
 Blue	Blue screen
 None	Black screen



Note

- If the input signal has interference, the screen will be displayed during interference.



Eco Mode (Setting the Eco Mode)

Select “” (Eco Mode) or “” (Standard Mode) in “Eco Mode” on the “Options” menu.

Description of Eco Mode

Selectable settings	Brightness	Power consumption (When using AC 100V)	Lamp life
 (Eco mode)	80%	190 W	4,500 hours
 (Standard mode)	100%	240 W	3,000 hours

Note

- Although lamp life and noise are improved when “Eco Mode” is set to “” (Eco mode), brightness decreases by 20%.
- “Eco Mode” mode is factory preset to “” (Standard mode).



Using the “Options” Menu

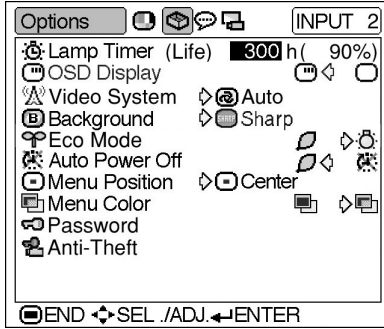

Example: “Options” menu screen for INPUT 2 (S-Video) mode



Auto Power Off (Auto Power Off Function)

When no input signal is detected for more than 15 minutes, the projector will automatically power off if set to “ON”.

The Auto Power Off function will be disabled if it has been set to “OFF”.

Select “” (ON) or “” (OFF) in “Auto Power Off” on the “Options” menu.

Note

- When the Auto Power Off function is set to “ON”, 5 minutes before the power turns off, the message “Power OFF in X min.” will appear on the screen to indicate the remaining minutes before power off.

Menu Position (Selecting the Menu Screen Position)

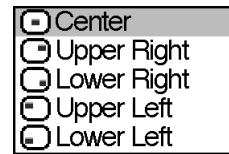

Select “Menu Position” on the “Options” menu and the desired position for the menu screen.



Description of Menu Positions

Selectable settings	Description
<input checked="" type="radio"/> Center	Displayed on the center of the image.
<input type="radio"/> Upper Right	Displayed on the upper right of the image.
<input type="radio"/> Lower Right	Displayed on the lower right of the image.
<input type="radio"/> Upper Left	Displayed on the upper left of the image.
<input type="radio"/> Lower Left	Displayed on the lower left of the image.

Menu Color (Selecting the Menu Color)

Select “” (Opaque) or “” (Translucent) in “Menu Color” on the “Options” menu.

Description of Menu Colors

Selectable settings	Description
<input checked="" type="checkbox"/> Opaque	The menu is displayed opaquely.
<input type="checkbox"/> Translucent	The menu is displayed translucently. The part of the menu on the image becomes transparent.



Password (Setting a Password)

A password must be set to activate the “Anti-Theft” function (Page 48).

There is no factory preset for the password or the “Anti-Theft” settings. In this way, anyone can freely set a new password and “Anti-Theft” settings. It is therefore recommended that even if you do not want to use the “Anti-Theft” function, you at least set a password to prevent others from setting the “Anti-Theft” function.

A password can only be set by using the remote control.

Select “Password” on the “Options” menu, then press and follow the procedure below to enter the password.

Password				
Old Password	-	-	-	-
New Password	-	-	-	-
Reconfirm	-	-	-	-
	END			

1 Press or to select the desired number and then press .

2 Enter the 3 remaining digits and press .

3 Enter the password again in “Reconfirm” and press .

Note

- When a password is set, you need to enter the password to change the “Anti-Theft” setting.

If you want to change the password, follow the procedure below.

Password				
Old Password	-	-	-	-
New Password	-	-	-	-
Reconfirm	-	-	-	-
	END			

1 Press , and to enter the password in “Old Password” and press .

2 Press , and to set the new password and press .

3 Enter the new 4-digit password again in “Reconfirm” and press .

Note

- If you do not want to set a password, leave the fields in steps 2 and 3 blank and press .
- To cancel the password settings, press .

If You Forget Your Password

If you forget the password, delete it using the following procedure and set a new password.

Press → → → → → → .

Note

- You can only use the buttons on the projector to delete the password.
- The password cannot be deleted using the above described procedures while the “Anti-Theft” function is set. If you forget your password while the “Anti-Theft” function is activated, you will need to contact your nearest Sharp Authorized Projector Dealer or Service Center (see page 65). You may need to bring your projector to them to restore the projector to original factory condition (password and keycode reset).



Using the “Options” Menu

Example: “Options” menu screen for INPUT 2 (S-Video) mode

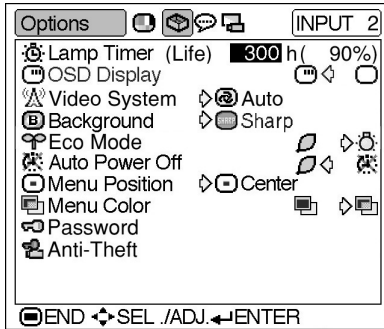

Anti-Theft (Setting the Anti-Theft)

The anti-theft function prevents unauthorized use of the projector. You can choose to use this function or not. If you do not want to use this function, just do not enter the keycode. Once the anti-theft function is activated, users will need to enter the correct keycode each time the projector is turned on. Failure to enter the correct keycode will cause images to not be projected. The following procedures explain how to use this function.

Select “Anti-Theft” on the “Options” menu, then press  and follow the procedure below to enter the keycode.



Note

- “Anti-Theft” cannot be selected unless “Password” is set. (See page 47.)
- When “Anti-Theft” is selected, the password input box will appear. Enter the keycode after the right password is entered.

Info

- Once the function is activated, you must remember the correct keycode. We suggest you record the keycode in a safe place where only authorized users have access. If you lose or forget your keycode, you will need to contact your nearest Sharp Authorized Projector Dealer or Service Center (see page 65). You may need to bring your projector to them to restore the projector to original factory condition (password and keycode reset).

1 Press any button you like on the remote control or projector to set the first digit in “New Code”.

Note

- The following buttons on the remote control and projector cannot be set as keycodes:
 - POWER ON/OFF buttons
 - ENTER button
 - UNDO button
 - MENU button
 - FORWARD button
 - BACK button

2 Enter the remaining 3 digits by pressing any buttons you like.

3 Enter the same keycode once more in “Reconfirm”.

Info

When “Anti-Theft” is set, the keycode inputting box appears after the power is turned on. When it appears, enter the right keycode.

- Press the buttons on the remote control if the buttons on the remote control are used for setting the keycode. In the same manner, press the buttons on the projector if the buttons on the projector are used for setting the keycode.

If you want to change the keycode, follow the procedure below.

Anti-Theft				
Old Code	—	—	—	—
New Code	—	—	—	—
Reconfirm	—	—	—	—
 END				

 Note

- When “Anti-Theft” is selected, the password input box will appear. After the password has been entered, you can change the keycode.

1 Press the buttons on the remote control or the projector to enter the preset 4-digit keycode in “Old Code”.

2 Press any button you like on the remote control or the projector to enter the new keycode.

3 Enter the same 4-digit keycode in “Reconfirm”.

 Note

- If you do not want to set a keycode, leave the keycode field blank in steps 2 and 3 and press .



Reversing/Inverting Projected Images

You can reverse or invert the projected image for various applications using the “PRJ Mode” menu. For operation of the menu screen, see pages 32 to 35.

Example: “PRJ Mode” menu screen for INPUT 1 (RGB) mode

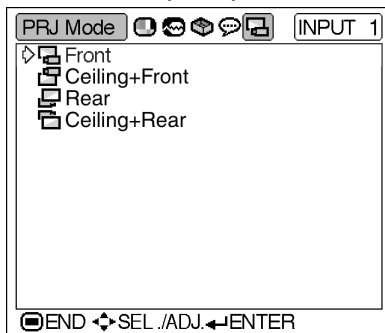

Setting the Projection Mode

Display the “PRJ Mode” menu and select the desired projection mode.

Description of Projection Modes

Selectable settings	Description
Front	Normal image
Ceiling+Front	Inverted image
Rear	Reversed image
Ceiling+Rear	Reversed and inverted image

Note

- This function is used for the reversed image and ceiling-mount setups. See page 25 for these setups.

Carrying the Projector

How to Use the Carrying Case

When carrying the projector, attach the lens cap to the lens, and place it in the supplied carrying case.

1 Open the cover of the carrying case.

2 Remove the inner padding from the carrying case, and fold it in the direction of the arrows.

3 Reinsert the inner padding into the carrying case.

Info

- Be sure to insert the inner padding to protect the lens and the projector.

4 Place the projector and the accessories in the carrying case.

Info

- Be sure to attach the lens cap to protect the lens.
- Be sure the projector has cooled down sufficiently before placing it in the case.

Info

- This carrying case is only for storing and carrying the projector.
- Sending the projector in the carrying case as a parcel may cause damage to the projector. If you send the projector in the carrying case as a parcel, be sure to place it in a sturdy case and with enough shock absorbing material to avoid any damage.
- Do not expose the carrying case or projector to direct sunlight, near heat sources, or leave them in a car. The carrying case or projector may change color or become deformed.

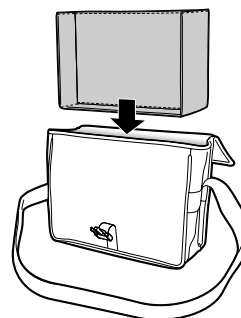
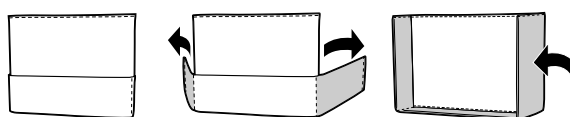
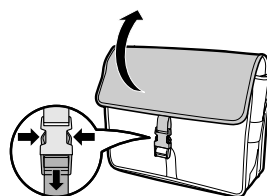

Lens cap

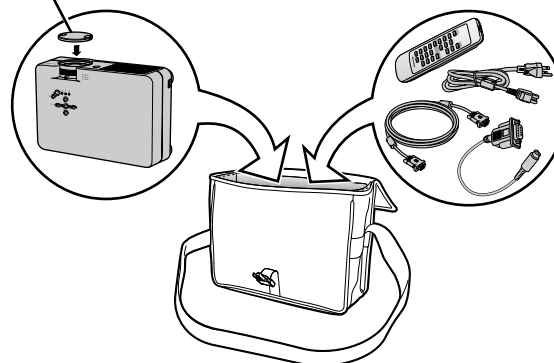

Adjust the shoulder strap.

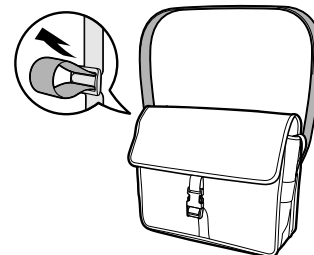



Maintenance

Cleaning the projector

- Be sure to unplug the power cord before cleaning the projector.
- The cabinet as well as the operation panel is made of plastic. Avoid using benzene or thinner, as these can damage the finish on the cabinet.
- Do not use volatile agents such as insecticides on the projector.
Do not attach rubber or plastic items to the projector for a long time.
The effects of some of the agents in the plastic may cause damage to the quality or finish of the projector.

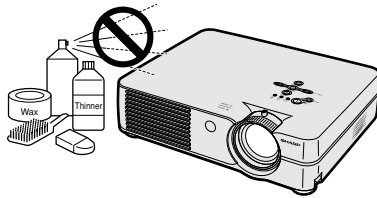

- Wipe off dirt gently with a soft flannel cloth.

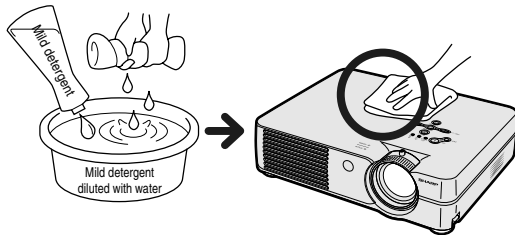

- When the dirt is hard to remove, soak a cloth in a mild detergent diluted with water, wring the cloth well and then wipe the projector. Strong cleaning detergents may discolor, warp or damage the coating on the projector. Make sure to test on a small, inconspicuous area on the projector before use.

Cleaning the lens

- Use a commercially available blower or lens cleaning paper (for glasses and camera lenses) for cleaning the lens. Do not use any liquid type cleaning agents, as they may wear off the coating film on the surface of the lens.
- As the surface of the lens can easily get damaged, be sure not to scrape or hit the lens.

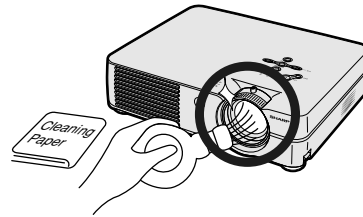

Cleaning the exhaust and intake vents

- Use a vacuum cleaner to clean dust from the exhaust vent and the intake vent.

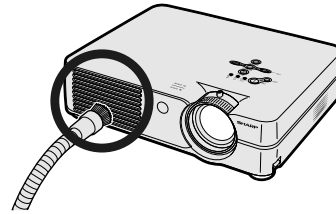



Replacing the Air Filter

- This projector is equipped with air filters to ensure the optimal operating condition of the projector.
- The air filters should be cleaned every 100 hours of use. Clean the filters more often when the projector is used in a dusty or smoky location.
- Ask your nearest Sharp Authorized Projector Dealer or Service Center to exchange the filter (PFILDA008WJZZ) when it is no longer possible to clean.

▼ Bottom view

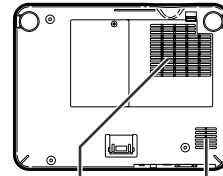

Air filter

Air filter (not removable)



▼ Rear view



Air filter (not removable)

Cleaning and Replacing the Air Filter

1 Turn off the power and disconnect the power cord.

- Press OFF  on the projector or  on the remote control. Wait until the cooling fan stops.

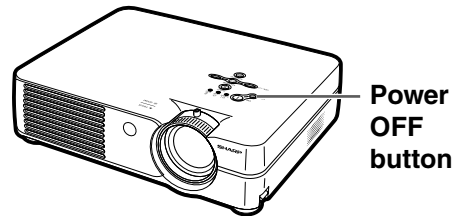

Power OFF button

Power OFF button

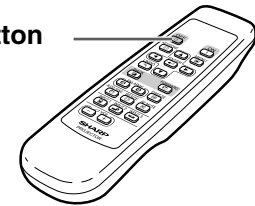

2 Remove the filter/lamp unit cover.

- Turn the projector over. Loosen the user service screw (1) that secures the filter/lamp unit cover. Pressing the tab (2), remove the filter/lamp unit cover (3).

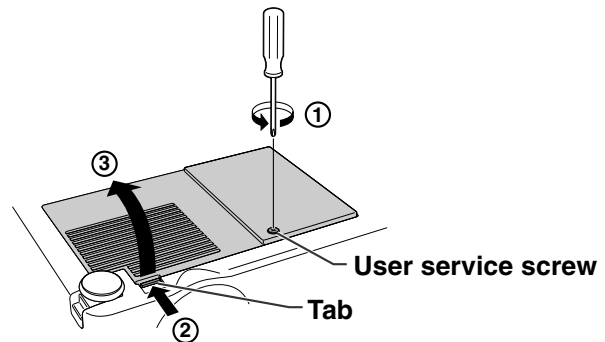

User service screw

Tab

3 Remove the air filter.

- Pick the air filter up with your fingers and lift it out of the filter/lamp unit cover.

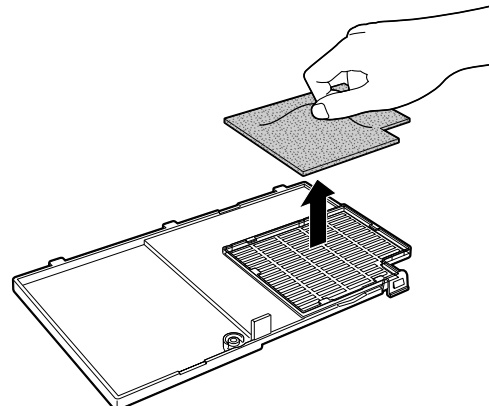

Replacing the Air Filter

4 Clean the air filter.

- Clean the dust off the air filter and cover with a vacuum cleaner extension hose.

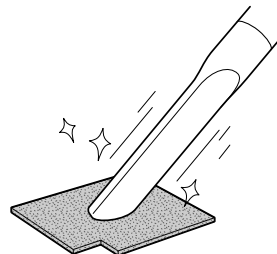

5 Replace the air filter.

- Place the air filter underneath the tabs on the filter/lamp unit cover.

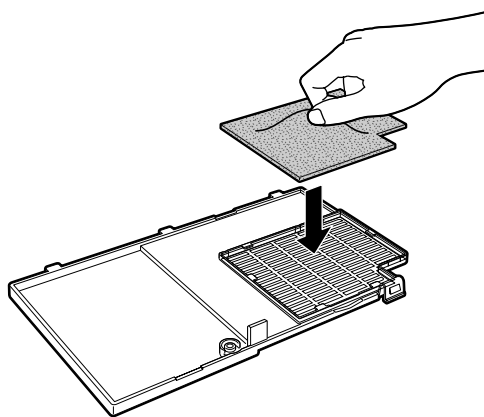

6 Replace the filter/lamp unit cover.

- Align the tab on the filter/lamp unit cover (①) and place it while pressing the tab (②) to close it. Then tighten the user service screw (③) to secure the filter/lamp unit cover.

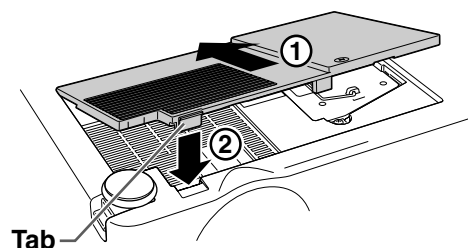

Note

- Be sure the filter/lamp unit cover is securely installed. The power will not turn on unless it is correctly installed.
- If dust or dirt has collected inside the rear and bottom air filters (not removable), clean the filter with a vacuum cleaner extension hose.

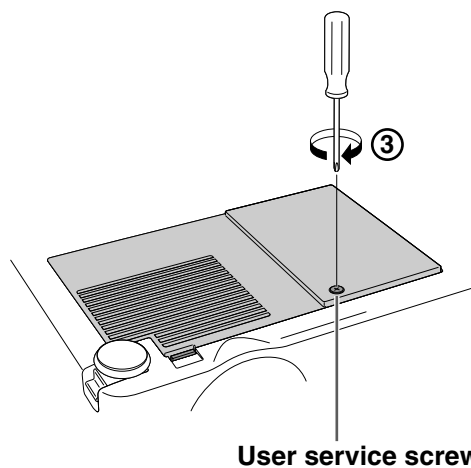

Maintenance Indicators

- The warning lights on the projector indicate problems inside the projector.
- If a problem occurs, either the temperature warning indicator or the lamp replacement indicator will illuminate red, and the power will turn off. After the power has been turned off, follow the procedures given below.

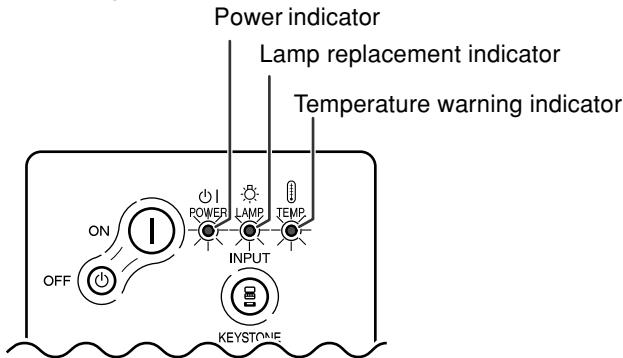

About the temperature warning indicator

If the temperature inside the projector increases, due to blockage of the air vents, or the setting location, "TEMP." will illuminate in the lower left corner of the picture. If the temperature keeps on rising, the lamp will turn off and the temperature warning indicator will blink, the cooling fan will run for a further 90 seconds, and then the power will be shut off. After "TEMP." appears, be sure to perform the following measures.



About the lamp replacement indicator





- The lamp life becomes 0%, when used for approximately 4,500 hours with "Eco Mode" or when used for approximately 3,000 hours with "Standard Mode" (see page 45).
- When the remaining lamp life becomes 5% or less, "5%" (yellow) will be displayed on the screen. When the percentage becomes 0%, "0%" will change to "0%" (red), the lamp will automatically turn off and then the projector as well. At this time, the lamp replacement indicator will illuminate in red.
- If you try to turn on the projector a fourth time without replacing the lamp, the projector will not turn on.

Maintenance indicator	Condition		Problem	Possible Solution	
	Normal	Abnormal			
Temperature warning indicator	Off	Red on/ Power off	<ul style="list-style-type: none"> • Blocked air intake • Cooling fan break-down • Internal circuit failure • Clogged air intake 	<ul style="list-style-type: none"> • Relocate the projector to an area with proper ventilation. • Take the projector to your nearest Sharp Authorized Projector Dealer or Service Center (see page 65) for repair. 	
Lamp replacement indicator	Green on Green blinks when the lamp is active.	Red on	Time to change the lamp	<ul style="list-style-type: none"> • Remaining lamp life becomes 5% or less. 	<ul style="list-style-type: none"> • Carefully replace the lamp. (See page 58) • Take the projector to your nearest Sharp Authorized Projector Dealer or Service Center (see page 65) for repair. • Please exercise care when replacing the lamp.
		Red on/ Power off	The lamp does not illuminate.	<ul style="list-style-type: none"> • Burnt-out lamp • Lamp circuit failure 	
Power indicator	Green on/ Red on	Red blinks	<ul style="list-style-type: none"> • The filter/lamp unit cover is open. 	<ul style="list-style-type: none"> • Securely install the cover. • If the power indicator blinks even when the filter/lamp unit cover is securely installed, contact your nearest Sharp Authorized Projector Dealer or Service Center for advice. 	



Maintenance Indicators

Info

- If the temperature warning indicator illuminates, and the power turns off, follow the above possible solutions and then wait until the projector has cooled down completely before plugging in the power cord and turning the power back on. (At least 5 minutes.)
- If the power is turned off and then turned on again, as during a brief test, the lamp replacement indicator may be triggered, preventing the power from going on. Should this occur, disconnect the power cord from the wall outlet and plug it back in again.
- If you want to clean the air vents during projector operation, be sure to first press OFF  on the projector or OFF  on the remote control and after the power has turned off and the cooling fan has stopped, then clean the vents.
- Do not unplug the power cord after the power has been turned off and while the cooling fan is running. The cooling fan runs for about 90 seconds.



Regarding the Lamp

Lamp

- It is recommended that the lamp (sold separately) be replaced when the remaining lamp life becomes 5% or less, or when you notice a significant deterioration in the picture and color quality. The lamp life (percentage) can be checked with the on-screen display. See page 44.
- For lamp replacement, please consult your nearest Sharp Authorized Projector Dealer or Service Center.

IMPORTANT NOTE TO U.S. CUSTOMERS:

The lamp included with this projector is backed by a 90-day parts and labor limited warranty. All service of this projector under warranty, including lamp replacement, must be obtained through a Sharp Authorized Projector Dealer or Service Center. For the name of the nearest Sharp Authorized Projector Dealer or Service Center, please call toll-free: 1-888-GO-SHARP (1-888-467-4277).

U.S.A. ONLY

Caution Concerning the Lamp

- This projector utilizes a pressurized mercury lamp. A loud sound may indicate lamp failure. Lamp failure can be attributed to numerous sources such as: excessive shock, improper cooling, surface scratches or deterioration of the lamp due to a lapse of usage time. The period of time up to failure largely varies depending on the individual lamp and/or the condition and the frequency of use. It is important to note that failure can often result in the bulb cracking.
- When the lamp replacement indicator and on-screen display icon are illuminated, it is recommended that the lamp be replaced with a new one immediately, even if the lamp appears to be operating normally.
- Should the lamp break, the glass particles may spread inside the lamp cage or gas contained in the lamp may be vented into the room from the exhaust vent. Because the gas in this lamp includes mercury, ventilate the room well if the lamp breaks and avoid all exposure to the released gas. In case of exposure to the gas, consult a doctor as soon as possible.
- Should the lamp break, there is also a possibility that glass particles may spread inside of the projector. In such a case, it is recommended you contact your nearest Sharp Authorized Projector Dealer or Service Center to remove the damaged lamp and assure safe operation.

Replacing the Lamp

Caution

- Do not remove the lamp unit immediately after operation of the projector. The lamp will be hot and touching it can lead to burn or injury.
- Wait at least one hour after the power cord is disconnected to allow the surface of the lamp unit to fully cool before removing the lamp unit.
- If the new lamp does not light after replacement, take your projector to the nearest Sharp Authorized Projector Dealer or Service Center for repair. Purchase a replacement lamp unit of type BQC-PGA10X//1 from your nearest Sharp Authorized Projector Dealer or Service Center. Then carefully change the lamp by following the instructions described in this section. If you wish, you may have the lamp replaced at your nearest Sharp Authorized Projector Dealer or Service Center.

Regarding the Lamp

Removing and Installing the Lamp Unit

Info

- Be sure to remove the lamp unit using the handle. Be sure not to touch the glass surface of the lamp unit or the inside of the projector.
- To avoid injury to yourself and damage to the lamp, be sure to carefully follow the steps below.
- Do not loosen other screws except for the filter/lamp unit cover and lamp unit.
- Please refer to the installation manual included with the lamp unit.

1 Press OFF on the projector to turn off the power.

- Wait until the cooling fan stops.

Warning!

- Do not remove the lamp unit from the projector right after use. The lamp will be very hot and may cause burn or injury.

2 Disconnect the power cord.

- Unplug the power cord from the AC socket.
- Leave the lamp until it has fully cooled down (about 1 hour).

3 Change the air filter.

- Change the air filter whenever you install the lamp unit (see pages 53 and 54).

4 Remove the filter/lamp unit cover.

- Turn the projector over. Loosen the user service screw (①) that secures the filter/lamp unit cover. Pressing the tab (②), remove the filter/lamp unit cover (③).

Lamp unit

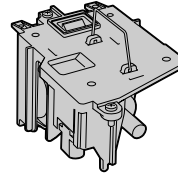

BQC-PGA10X//1

Power OFF button

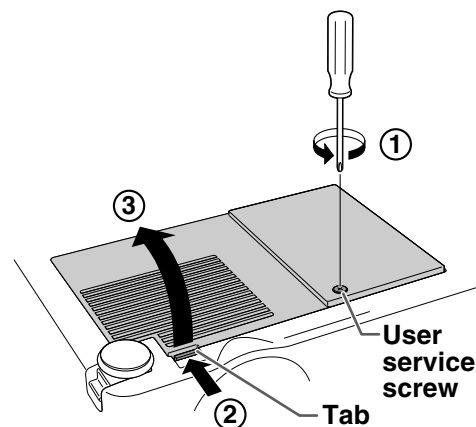
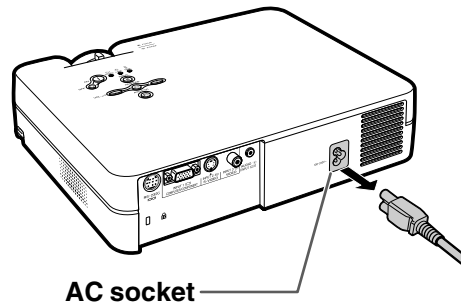
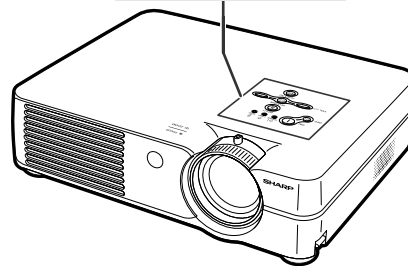
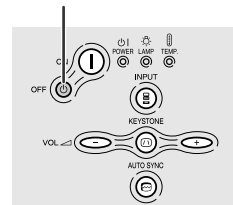



5 Remove the lamp unit.

- Loosen the securing screws from the lamp unit. Hold the lamp unit by the handle and pull it in the direction of the arrow. At this time, keep the lamp unit horizontal and do not tilt it.

6 Insert the new lamp unit.

- Press the lamp unit firmly into the lamp unit compartment. Fasten the securing screws.

7 Replace the filter/lamp unit cover.

- Align the tab on the filter/lamp unit cover (1) and place it while pressing the tab (2) to close it. Then tighten the user service screw (3) to secure the filter/lamp unit cover.

Info

- If the lamp unit and filter/lamp unit cover are not correctly installed, the power will not turn on, even if the power cord is connected to the projector.

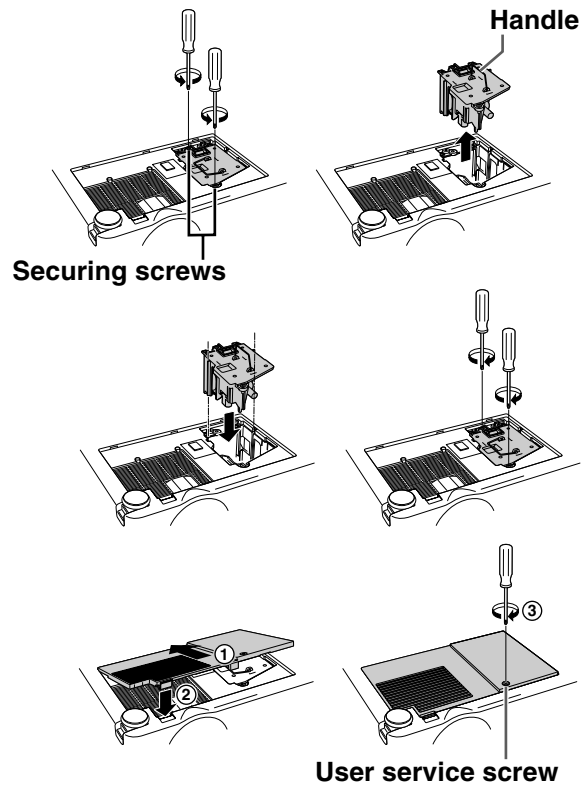

Resetting the Lamp Timer

Reset the lamp timer after replacing the lamp.

1 Connect the power cord.

- Plug the power cord into the AC socket of the projector.

2 Reset the lamp timer.

- While simultaneously holding down and on the projector, press and on the projector.
- "LAMP 0000H" is displayed, indicating that the lamp timer is reset.

Info

- Make sure to reset the lamp timer only when replacing the lamp. If you reset the lamp timer and continue to use the same lamp, this may cause the lamp to become damaged or explode.

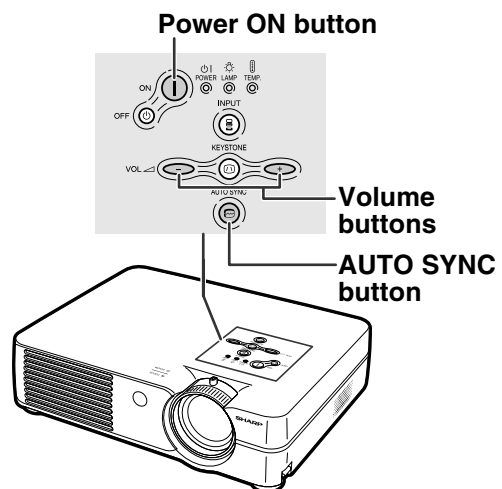
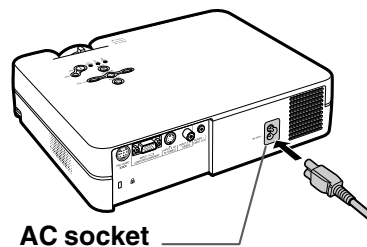

Connecting Pin Assignments

INPUT 1 RGB Signal Terminal: 15-pin Mini D-sub female connector

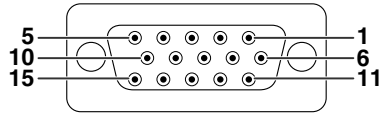

RGB Input

1. Video input (red)
2. Video input (green/sync on green)
3. Video input (blue)
4. Not connected
5. Not connected
6. Earth (red)
7. Earth (green/sync on green)
8. Earth (blue)
9. Not connected
10. GND
11. Not connected
12. Bi-directional data
13. Horizontal sync signal
14. Vertical sync signal
15. Data clock

Component Input

1. P_R (C_R)
2. Y
3. P_B (C_B)
4. Not connected
5. Not connected
6. Earth (P_R)
7. Earth (Y)
8. Earth (P_B)
9. Not connected
10. Not connected
11. Not connected
12. Not connected
13. Not connected
14. Not connected
15. Not connected

RS-232C Terminal: 9-pin Mini DIN female connector

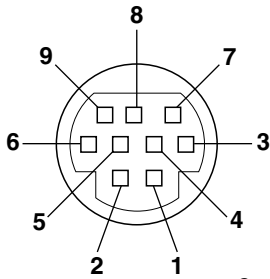

Pin No.	Signal	Name	I/O	Reference
1				Not connected
2	RD	Receive Data	Input	Connected to internal circuit
3	SD	Send Data	Output	Connected to internal circuit
4				Not connected
5	SG	Signal Ground		Connected to internal circuit
6				Not connected
7				Not connected
8				Not connected
9				Not connected

9-pin D-sub male connector of the DIN-D-sub RS-232C adaptor

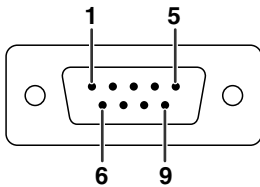

Pin No.	Signal	Name	I/O	Reference
1				Not connected
2	RD	Receive Data	Input	Connected to internal circuit
3	SD	Send Data	Output	Connected to internal circuit
4				Not connected
5	SG	Signal Ground		Connected to internal circuit
6				Not connected
7				Not connected
8				Not connected
9				Not connected

RS-232C Cable recommended connection: 9-pin D-sub female connector

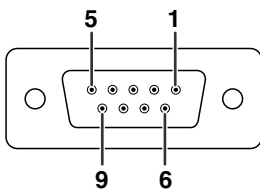

Pin No.	Signal	Pin No.	Signal
1	CD	1	CD
2	RD	2	RD
3	SD	3	SD
4	ER	4	ER
5	SG	5	SG
6	DR	6	DR
7	RS	7	RS
8	CS	8	CS
9	CI	9	CI

Note

- Depending on the controlling device used, it may be necessary to connect Pin 4 and Pin 6 on the controlling device (e.g. PC).



RS-232C Specifications and Command Settings

PC control

A computer can be used to control the projector by connecting an RS-232C serial control cable (cross type, sold separately) to the projector. (See page 20 for connection.)

Communication conditions

Set the serial port settings of the computer to match that of the table.

Signal format: Conforms to RS-232C standard.

Baud rate: 9,600 bps

Data length: 8 bits

Parity bit: None

Stop bit: 1 bit

Flow control: None

Basic format

Commands from the computer are sent in the following order: command, parameter, and return code. After the projector processes the command from the computer, it sends a response code to the computer.

Command format

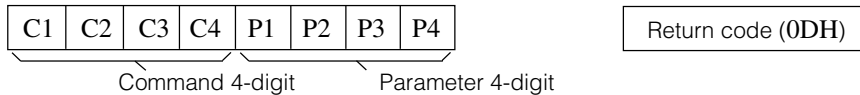

Response code format

Normal response

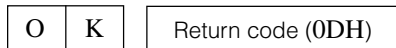

Problem response (communication error or incorrect command)



Info

- When more than one code is being sent, send each command only after the response code for the previous command from the projector is verified.

Commands

Example: When turning on the projector, make the following setting.

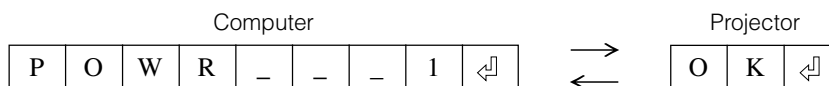

	CONTROL CONTENTS	COMMAND	PARAMETER	RETURN
BUTTONS & REMOTE CONTROL KEY	Power Off (Standby)	P O W R	_ _ _	0 OK or ERR
	Power On	P O W R	_ _ _	1 OK or ERR
	INPUT1	I R G B	_ _ _	1 OK or ERR
	INPUT2	I V E D	_ _ _	1 OK or ERR
	INPUT3	I V E D	_ _ 2	2 OK or ERR
	Lamp Usage Time (hour)	T L T T	_ _ _	1 0-9999
	Remaining Lamp Life (Percentage)	T L T L	_ _ _	1 0-100
	Lamp Status	T L P S	_ _ _	1 0:Off, 1:On, 2:Retry, 3:Waiting, 4:Lamp Error
	Unit Status	T A B N	_ _ _	1 0:Normal, 1:Temp High, 2:Fan Err, 4:Filter Cover Err, 8:Lamp 100 hours, 16:Lamp Burnt-out, 32:Lamp Not Lit, 64:Temp Abnormally High
	Model Name Check	T N A M	_ _ _	1 PROJECTOR NAME
	AV Mute Off	I M B K	_ _ _	0 OK or ERR
	AV Mute On	I M B K	_ _ _	1 OK or ERR
	Auto Sync Start	A D J S	_ _ _	1 OK or ERR

Note

- If an underbar (_) appears in the parameter column, enter a space. If an asterisk (*) appears, enter a value in the range indicated in brackets under CONTROL CONTENTS.



Computer Compatibility Chart

Computer

- Multiple signal support
Horizontal Frequency: 15–70 kHz, Vertical Frequency: 43–85 Hz, Pixel Clock: 12–108 MHz
- Compatible with sync on green and composite sync signals
- SXGA+ and SXGA compatible in intelligent compression
- Intelligent Compression and Expansion System resizing technology

The following is a list of modes that conform to VESA. However, this projector supports other signals that are not VESA standards.

PC/MAC/WS	Resolution	Horizontal Frequency (kHz)	Vertical Frequency (Hz)	VESA Standard	Display	
PC	VGA	640 × 350	27.0	60		Upscale
			31.5	70		
			37.5	85	✓	
		640 × 400	27.0	60		
			31.5	70		
			37.9	85	✓	
		720 × 350	27.0	60		
			31.5	70		
			27.0	60		
		720 × 400	31.5	70		
			37.9	85	✓	
			26.2	50		
	640 × 480	31.5	60	✓		
		34.7	70			
		37.9	72	✓		
		37.5	75	✓		
		43.3	85	✓		
		31.4	50			
		35.1	56	✓		
		37.9	60	✓		
	SVGA	800 × 600	46.6	70	✓	
			48.1	72	✓	
			46.9	75	✓	
			53.7	85	✓	
			35.5	43		
			40.3	50		
			48.4	60	✓	
			56.5	70	✓	
XGA	1,024 × 768	60.0	75	✓		
		68.7	85	✓		
		55.0	60			
		66.2	70			
		67.5	75	✓		
SXGA	1,152 × 864	64.0	60	✓		
		64.0	60			
	SXGA+	1,400 × 1,050	64.0	60		
MAC 13"	VGA	640 × 480	34.9	67	Upscale	
MAC 16"	SVGA	832 × 624	49.7	75	Upscale	
MAC 19"	XGA	1,024 × 768	60.2	75	True	
MAC 21"	SXGA	1,152 × 870	68.7	75	Intelligent Compression	





Note

- This projector may not be able to display images from notebook computers in simultaneous (CRT/LCD) mode. Should this occur, turn off the LCD display on the notebook computer and output the display data in "CRT only" mode. Details on how to change display modes can be found in your notebook computer's operation manual.
- When this projector receives 640 × 350 VESA format VGA signals, "640 × 400" appears on the screen.

DTV

Signal	Horizontal Frequency (kHz)	Vertical Frequency (Hz)
480I	15.7	60
480P	31.5	60
540P	33.8	60
580I	15.6	50
580P	31.3	50
720P	45.0	60
1035I	28.1	50
1035I	33.8	60
1080I	28.1	50
1080I	33.8	60

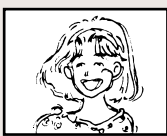
Troubleshooting

Problem	Check	Page
 No picture and no sound or projector does not start.	• Projector power cord is not plugged into the wall outlet.	15
	• Power to the external connected devices is off.	—
	• The selected input mode is wrong.	27
	• The AV MUTE function is working.	27
	• Cables incorrectly connected to rear panel of the projector.	16-20
	• Remote control batteries have run out.	13
	• External output has not been set when connecting notebook computer.	16
	• The filter/lamp unit cover is not installed correctly.	54,59
 Sound is heard but no picture appears.	• Cables incorrectly connected to the rear panel of the projector.	16-20
	• “Bright” is set to minimum position.	36
 Color is faded or poor.	• Picture adjustments are incorrectly set.	36
	(Video Input only) • Video input system is incorrectly set.	45
	(INPUT 1 only) • Input signal type (RGB/Component) is incorrectly set.	37
 Picture is blurred; noise appears.	• Adjust the focus.	22
	• The projection distance exceeds the focus range.	24
	(Computer Input only) • Perform “Fine Sync” Adjustments (“Clock” Adjustment)	38
	• Perform “Fine Sync” Adjustments (“Phase” Adjustment)	38
	• Noise may appear depending on the computer.	—
 Picture appears but no sound is heard.	• Cables incorrectly connected to rear panel of projector.	16-20
	• Volume is set to minimum.	27
An unusual sound is occasionally heard from the cabinet.	• If the picture is normal, the sound is due to cabinet shrinkage caused by room temperature changes. This will not affect operation or performance.	—
Maintenance indicator illuminates.	• See “Maintenance Indicators”.	55
Power cannot be turned on or off using the power buttons on the projector.	• The keylock is set. If the keylock is set to ON, all the buttons are locked.	43



Troubleshooting

Problem	Check	Page
Picture is green on INPUT 1 COMPONENT.	• Change the input signal type setting.	37
Picture is pink (no green) on INPUT 1 RGB.		
Picture is dark.	• The lamp replacement indicator is illuminating in red. Replace the lamp.	55
Picture is too bright and whitish.	• Picture adjustments are incorrectly set.	36

For SHARP Assistance

If you encounter any problems during setup or operation of this projector, first refer to the “Troubleshooting” section on pages 63 and 64. If this operation manual does not answer your question, please contact the SHARP Service departments listed below.

U.S.A.	Sharp Electronics Corporation 1-888-GO-SHARP (1-888-467-4277) lcdsupport@sharpsec.com http://www.sharplcd.com	Benelux	SHARP Electronics Benelux BV 0900-SHARPCE (0900-7427723) Nederland 9900-0159 Belgium http://www.sharp.nl http://www.sharp.be http://www.sharp.lu
Canada	Sharp Electronics of Canada Ltd. (905) 568-7140 http://www.sharp.ca	Australia	Sharp Corporation of Australia Pty. Ltd. 1300-135-022 http://www.sharp.net.au
Mexico	Sharp Electronics Corporation Mexico Branch (525) 716-9000 http://www.sharp.com.mx	New Zealand	Sharp Corporation of New Zealand (09) 634-2059, (09) 636-6972 http://www.sharpnz.co.nz
Latin America	Sharp Electronics Corp. Latin American Group (305) 264-2277 www.servicio@sharpsec.com http://www.siempresharp.com	Singapore	Sharp-Roxy Sales (S) Pte. Ltd. 65-226-6556 ckng@srs.global.sharp.co.jp http://www.sharp.com.sg
Germany	Sharp Electronics (Europe) GMBH 01805-234675 http://www.sharp.de	Hong Kong	Sharp-Roxy (HK) Ltd. (852) 2410-2623 dcmktg@srh.global.sharp.co.jp http://www.sharp.com.hk
U.K.	Sharp Electronics (U.K.) Ltd. 0161-205-2333 custinfo@sharp-uk.co.uk http://www.sharp.co.uk	Taiwan	Sharp Corporation (Taiwan) 0800-025111 http://www.sharp-scot.com.tw
Italy	Sharp Electronics (Italy) S.P.A. (39) 02-89595-1 http://www.sharp.it	Malaysia	Sharp-Roxy Sales & Service Co. (60) 3-5125678
France	Sharp Electronics France 01 49 90 35 40 hotlined@sef.sharp-eu.com http://www.sharp.fr	U.A.E.	Sharp Middle East Fze 971-4-81-5311 helpdesk@smef.global.sharp.co.jp
Spain	Sharp Electronica Espana, S.A. 93 5819700 sharplcd@sees.sharp-eu.com http://www.sharp.es	Thailand	Sharp Thebnakorn Co. Ltd. 02-236-0170 svc@stcl.global.sharp.co.jp http://www.sharp-th.com
Switzerland	Sharp Electronics (Schweiz) AG 0041 1 846 63 11 cattaneo@sez.sharp-eu.com http://www.sharp.ch	Korea	Sharp Electronics Incorporated of Korea (82) 2-3660-2002 lcd@sharp-korea.co.kr http://www.sharpkorea.co.kr
Sweden	Sharp Electronics (Nordic) AB (46) 8 6343600 vision.support@sen.sharp-eu.com http://www.sharp.se	India	Sharp Business Systems (India) Limited (91) 11- 6431313 service@sharp-oa.com
Austria	Sharp Electronics Austria (Ges.m.b.H.) 0043 1 727 19 123 pogats@sea.sharp-eu.com http://www.sharp.at		



Specifications

Product type	LCD Projector
Model	PG-A10X / PG-A10S
Video system	NTSC3.58/NTSC4.43/PAL/PAL-M/PAL-N/PAL-60/SECAM/ DTV480I/DTV480P/DTV540P/DTV580I/DTV580P/DTV720P/DTV1035I/DTV1080I
Display method	LCD panel × 3, RGB optical shutter method
LCD panel	Panel size: 0.79" (20.0 mm) (12 [H] × 16 [W] mm) No. of dots: [PG-A10X] 786,432 dots (1,024 [H] × 768 [V]) [PG-A10S] 480,000 dots (800 [H] × 600 [V])
Standard lens	1–1.2 × zoom lens, F1.9–2.2, f = 26–31 mm
Projection lamp	SHP 165 W lamp
Component input signal	15-pin mini D-sub connector
(INPUT1)	Y: 1.0 Vp-p, sync negative, 75 Ω terminated P _B : 0.7 Vp-p, 75 Ω terminated P _R : 0.7 Vp-p, 75 Ω terminated
Horizontal resolution	[PG-A10X] 700 TV lines (DTV720P) [PG-A10S] 520 TV lines (DTV720P)
Computer RGB input signal	15-pin mini D-sub connector
(INPUT 1)	RGB separate/sync on green type analog input: 0–0.7 Vp-p, positive, 75 Ω terminated HORIZONTAL SYNC. SIGNAL: TTL level (positive/negative) VERTICAL SYNC. SIGNAL: Same as above
S-video input signal	4-pin mini DIN connector
(INPUT 2)	Y (luminance signal): 1.0 Vp-p, sync negative, 75 Ω terminated C (chrominance signal): Burst 0.286 Vp-p, 75 Ω terminated
Video input signal	RCA connector: VIDEO, composite video, 1.0 Vp-p, sync negative, 75 Ω terminated
(INPUT 3)	
Computer control signal (RS-232C)	9-pin mini DIN connector
Pixel clock	12–108 MHz
Vertical frequency	43–85 Hz
Horizontal frequency	15–70 kHz
Audio input signal	ø3.5 mm minijack: AUDIO, 0.5 Vrms, more than 47 kΩ (stereo)
Audio output	1.0 W (monaural)
Speaker system	2.8 cm round × 1
Rated voltage	AC 100–240 V
Input current	2.4 A
Rated frequency	50/60 Hz
Power consumption	240 W (Standard mode)/190 W (Eco mode) with AC 100 V 226 W (Standard mode)/182 W (Eco mode) with AC 240 V
Power consumption (standby)	5 W (AC 100 V) – 8 W (AC 240 V)
Heat dissipation	900 BTU/hour (Standard mode)/710 BTU/hour (Eco mode) with AC 100 V 850 BTU/hour (Standard mode)/680 BTU/hour (Eco mode) with AC 240 V
Operating temperature	41°F to 95°F (+5°C to +35°C)
Storage temperature	–4°F to 140°F (–20°C to +60°C)
Cabinet	Plastic
I/R carrier frequency	38 kHz
Dimensions (approx.)	11 45/64" × 3 13/64" × 9 1/32" (297 (W) × 81 (H) × 229 (D) mm) (main body only) 11 45/64" × 3 33/64" × 9 1/32" (297 (W) × 89 (H) × 229 (D) mm) (including adjustment foot and projecting parts)
Weight (approx.)	6.4 lbs. (2.9 kg)
Supplied accessories	Remote control, Two R-6 batteries, Power cord for U.S., Canada etc. (6', 1.8 m), Power cord for Europe, except U.K. (6', 1.8 m), Power cord for U.K., Hong Kong and Singapore (6', 1.8 m), Power cord for Australia, New Zealand and Oceania (6', 1.8 m), RGB cable (9'10", 3.0 m), DIN-D-sub RS-232C adaptor (5 57/64", 15 cm), Carrying case, Lens cap (attached), Extra air filter, Projector manual and technical reference CD-ROM, "QUICK GUIDE" label, Operation manual
Replacement parts	Lamp unit (Lamp/cage module) (BQC-PGA10X//1), Remote control (RRMCGA138WJSA), Two R-6 batteries ("AA" size, UM/SUM-3, HP-7, or similar), Power cord for U.S., Canada etc. (QACCCA016WJPZ), Power cord for Europe, except U.K. (QACCVA006WJPZ), Power cord for U.K., Hong Kong and Singapore (QACCCA015WJPZ), Power cord for Australia, New Zealand and Oceania (QACCLA005WJPZ), RGB cable (QCNWGA012WJPZ), DIN-D-sub RS-232C adaptor (QCNWGA015WJPZ), Carrying case (GCASNA006WJSA), Lens cap (CCAPHA007WJ01), Air filter (PFILDA008WJZZ), Projector manual and technical reference CD-ROM (UDSKAA022WJN1), "QUICK GUIDE" label (TLABZA191WJZZ), Operation manual (TINS-A505WJN1)

This SHARP projector uses an LCD (Liquid Crystal Display) panel. This very sophisticated panel contains 786,432 (PG-A10X) / 480,000 (PG-A10S) pixels (× RGB) TFTs (Thin Film Transistors). As with any high technology electronic equipment such as large screen TVs, video systems and video cameras, there are certain acceptable tolerances that the equipment must conform to.

This unit has some inactive pixels within acceptable tolerances which may result in inactive dots on the picture screen. This will not affect the picture quality or the life expectancy of the unit.



Dimensions

Units: inches (mm)

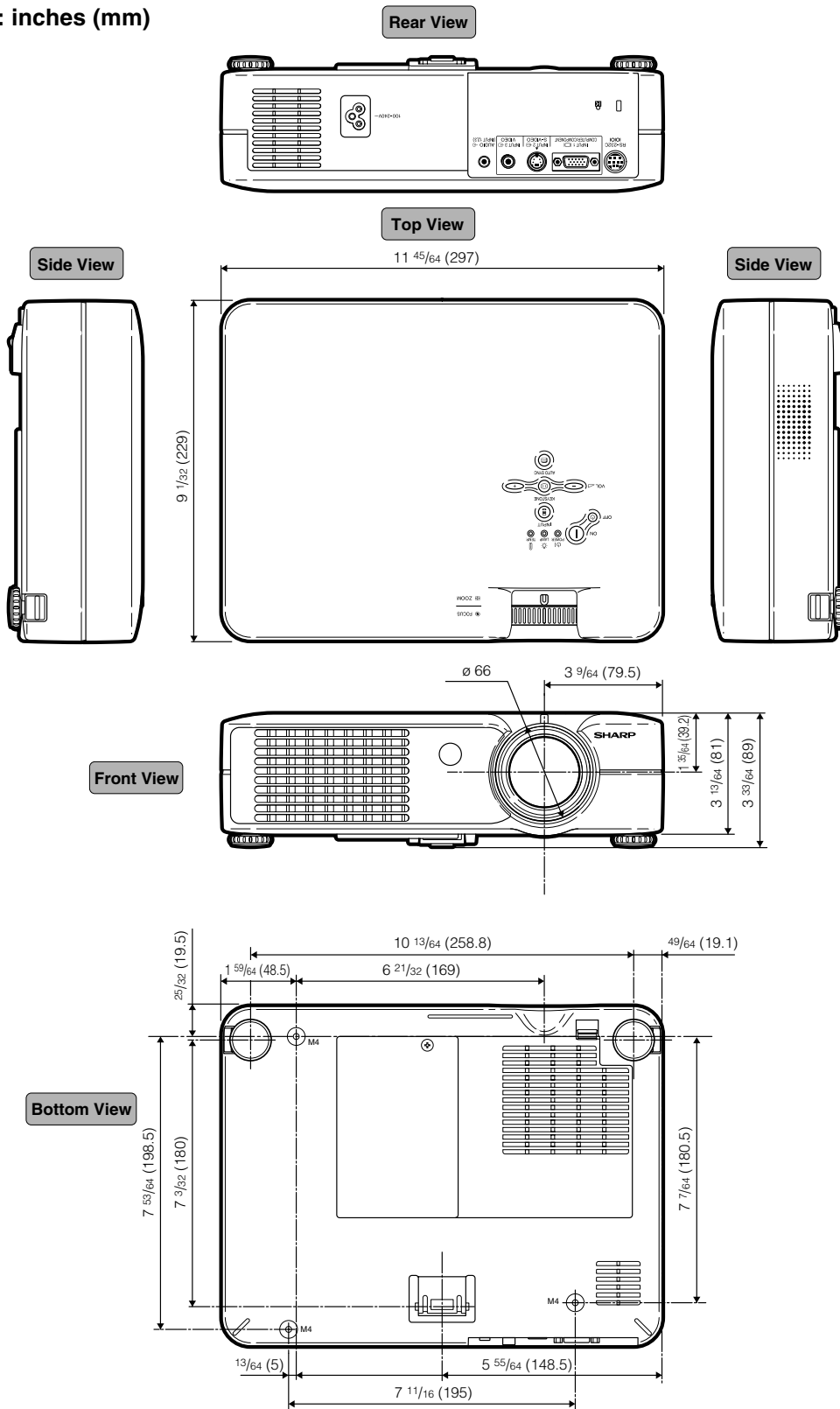



Glossary

Anti-Theft

If the "Keycode" set in the projector is not correctly entered, the projector will not operate even if signals are entered.

Aspect Ratio

Width and height ratio of an image. The normal aspect ratio of a computer and video image is 4:3. There are also wide images with an aspect ratio of 16:9 and 21:9.

Auto Sync

Optimizes projected computer images by automatically adjusting certain characteristics.

Background

Initial setting image projected when no signal is being output.

Border

Projects a 4:3 image fully within a 16:9 screen by keeping the aspect ratio at 4:3.

Clock

Clock adjustment is used to adjust vertical noise when clock level is incorrect.

CLR Temp (Color temperature)

Function that can be used to adjust the color temperature to suit the type of image input to the projector. Decrease the color temperature to create warmer, reddish images for natural flesh tones, or increase to create cooler, bluish images for a brighter picture.

Dot by dot

Mode that projects images in their native resolution.

Gamma

Image quality enhancement function that offers a richer image by brightening the darker portions of the image without altering the brightness of the brighter portions. You can select four different modes: STANDARD, PRESENTATION, CINEMA and GAME.

Intelligent compression

High quality resizing of lower and higher resolution images to fit the projector's native resolution.

Keylock

Mode that can lock the operation of projector buttons to prevent unauthorized adjustment.

Keystone correction

Function to digitally correct a distorted image when the projector is set up at an angle, smoothens out jaggies on keystone images and compresses the image not only horizontally but vertically keeping the 4:3 aspect ratio.

Password

A password is set so that changes cannot be made in the "Anti-Theft" setting.

Phase

Phase shift is a timing shift between isomorphic signals with the same resolution. When phase level is incorrect, the projected image typically displays horizontal flicker.

Resize

Allows you to modify or customize the picture display mode to enhance the input image. You can select four different modes: NORMAL, DOT BY DOT, BORDER and STRETCH.

sRGB

An international standard of color reproduction regulated by the IEC (International Electrotechnical Commission). As the fixed color area has been decided by the IEC, the color changes according to LCD features, so that the images are displayed in a natural tint based on an original image, when "sRGB" is set to "ON".

Stretch

Mode that stretches the 4:3 image horizontally to display it fully on a 16:9 screen.



Index

AC socket	15	Memory	37
Adjusting the Lens	22	MENU button	32
Adjustment buttons	32	Menu Color	46
Adjustment feet	21	Menu Position	46
Air filter	53	NORMAL	40
Anti-Theft	48	Optional accessories	14
Aspect ratio	40	Options	44
AUDIO INPUT terminal	16	OSD Display	44
Auto Power off	46	Password	47
Auto Sync adjustment	38	PDF	9
AUTO SYNC button	38	Phase	38
AV MUTE button	27	Picture Adjustment	36
BACK button	12	Power buttons	26
Background	45	Power cord	15
Batteries	13	Power indicator	26
Blue	36	PRJ mode (Reversing/Inverting Projected Images)	50
BORDER	40	Red	36
Bright	36	Remote control	12
Carrying case	51	Remote control sensor	13
Ceiling-mount setup	25	Replacing the lamp	57
Clock	38	RESIZE button	40
CLR Temp (Color Temperature)	36	RGB cable	16
Color	36	RS-232C terminal	20
Computer Image Adjustment	38	Sharp	36
Contrast	36	Signal Info	39
DIN-D-sub RS-232C adaptor	20	Signal Type	37
DOT BY DOT	40	Special Modes	38
Eco Mode	45	sRGB	37
ENLARGE buttons	42	STRETCH	40
ENTER button	35	Supplied accessories	14
Exhaust vent	52	Temperature warning indicator	55
Fine Sync	38	Tint	36
Focus ring	22	UNDO button	29
Foot release	21	Video System	45
FORWARD button	12	Volume buttons	27
FREEZE button	42	V-Pos	38
Gamma	37	Zoom knob	22
H-Pos	38		
INPUT 1 terminal	16		
INPUT 1 – 3 modes	27		
INPUT 2 terminal	18		
INPUT 3 terminal	18		
INPUT button	27		
Intake vent	52		
Kensington Security Standard connector	11		
Keylock	43		
KEystone button	29		
Keystone correction	29		
Lamp	57		
Lamp replacement indicator	55		
Lamp Timer (Life)	44		
Language (on-screen display language)	28		
Lens cap	10		



MEMO





Bitte lesen Sie diese Bedienungsanleitung vor der Verwendung des Projektors sorgfältig durch.

Einführung

DEUTSCH

Es gibt zwei wichtige Gründe für die baldige Garantie-Registrierung dieses neuen Projektors von SHARP mit Hilfe der dem Projektor beiliegenden REGISTRIERUNGS-KARTE:

1. GARANTIE

Hierdurch wird sichergestellt, dass Sie sofort den vollständigen Anspruch auf die Garantie auf Bauteile, Service und Personalkosten dieses Gerätes haben.

2. CONSUMER PRODUCT SAFETY ACT

Um sicherzustellen, dass Sie sofort über Sicherheitshinweise zu Inspektionen, Modifizierungen oder einen Rückruf benachrichtigt werden, die von SHARP aufgrund des Consumer Product Safety Act von 1972 durchgeführt werden müssen, LESEN SIE BITTE DEN WICHTIGEN ABSCHNITT ÜBER DIE "EINGESCHRÄNKTE GARANTIE" DURCH.

NUR USA

WARNUNG: Helle Lichtquelle. Nicht in den Lichtstrahl schauen oder ihn direkt anschauen. Besonders Kinder sollten nicht direkt in den Lichtstrahl schauen.



WARNUNG: Um das Risiko von elektrischem Schlag zu verringern, sollte dieses Gerät nicht Regen oder Feuchtigkeit ausgesetzt werden.

Siehe Unterseite des Projektors.



VORSICHT
RISIKO VON ELEKTRISCHEM SCHLAG. NICHT DIE SCHRAUBEN ENTFERNEN, AUSGENOMMEN DIE BESONDERS AUSGEWIESENEN SERVICESCHRAUBEN FÜR DEN BENUTZER.



VORSICHT: ZUR VERRINGERUNG DES RISIKOS VON ELEKTRISCHEM SCHLAG NICHT DIE ABDECKUNG ENTFERNEN. KEINE DURCH DEN BENUTZER ZU WARTENDEN BAUTEILE AUSSER DER LAMPENEINHEIT. DIE WARTUNG SOLLTE NUR DURCH QUALIFIZIERTES WARTUNGSPERSONAL AUSGEFÜHRT WERDEN.



Der Blitz mit dem Pfeilsymbol innerhalb eines gleichseitigen Dreiecks warnt den Benutzer vor dem Vorhandensein unisolierter, potentiell gefährlicher Stromspannung im Geräteinneren, die ein Risiko darstellt bzw. elektrische Schläge verursachen kann.



Das Ausrufezeichen innerhalb eines gleichseitigen Dreiecks macht den Benutzer auf wichtige Anweisungen zu Bedienung und Wartung (Service) des Gerätes in der mitgelieferten Dokumentation aufmerksam.

WARNUNG: Die FCC-Vorschriften besagen, dass jede nicht durch den Hersteller genehmigte Änderung oder Modifizierung des Gerätes zu einer Annullierung der Betriebsgenehmigung des Gerätes führen kann.

NUR USA

INFORMATION

Dieses Gerät wurde getestet und entspricht den Einschränkungen bei den Anforderungen für ein digitales Klasse A-Gerät, wie sie in Teil 15 der FCC-Regelung beschrieben werden. Diese Einschränkungen wurden erstellt, um einen sinnvollen Schutz gegen schädliche Interferenzen zu gewährleisten, wenn das Gerät in einer kommerziellen Umgebung betrieben wird. Dieses Gerät entwickelt, verwendet und strahlt Radiofrequenz-Energie ab und kann unter Umständen - wenn es nicht in Übereinstimmung mit dem Benutzerhandbuch aufgestellt und betrieben wird - schädliche Interferenzen bei der Radiokommunikation verursachen. Der Betrieb dieses Gerätes in einem Wohnbereich führt aller Wahrscheinlichkeit nach zu schädlichen Interferenzen; in einem solchen Fall liegt es beim Benutzer, auf eigene Kosten geeignete Maßnahmen zur Beseitigung der Interferenzen zu ergreifen.

NUR USA

Das mitgelieferte Computer-Kabel muss mit diesem Gerät verwendet werden. Das Kabel wird mitgeliefert um sicherzustellen, dass das Gerät den FCC-Vorschriften der Klasse A entspricht.

NUR USA

WARNUNG:

Dies ist ein Gerät der Klasse A. Dieses Gerät kann im Wohnbereich Funkstörungen verursachen; in diesem Fall kann vom Betreiber verlangt werden, angemessene Gegenmaßnahmen durchzuführen und dafür aufzukommen.

Geräuschpegel

NORMALBETRIEB: < 70 dB (A)
gemessen nach DIN 45635
EN 27779





WICHTIGE SICHERHEITSHINWEISE

ACHTUNG: Vor der ersten Inbetriebnahme dieses Gerätes sollten Sie diese Bedienungsanleitung durchlesen und für die Bezugnahme gut aufbewahren.

Elektrische Energie kann viele nützliche Funktionen ausführen. Dieses Gerät wurde so konstruiert, dass es die Sicherheit von Personen gewährleistet. FALSCHER VERWENDUNG KANN ZU ELEKTRISCHEN SCHLÄGEN ODER ZU EINEM BRAND FÜHREN. Damit die in diesem Gerät eingebauten Sicherheitsfunktionen nicht umgangen werden, sollten die folgenden Hinweise für Installation, Gebrauch und Wartung befolgt werden.

1. Lesen Sie die Anleitungen

Alle Sicherheitshinweise und Bedienungsanleitungen sollten vor der Verwendung des Gerätes gelesen werden.

2. Bewahren Sie die Anleitungen auf

Die Sicherheitshinweise und Bedienungsanleitungen sollten für zukünftige Bezugnahme aufbewahrt werden.

3. Beachten Sie die Warnungen

Alle Warnungen auf dem Gerät und in der Bedienungsanleitung sollten beachtet werden.

4. Folgen Sie den Anleitungen

Alle Bedienungs- und Gebrauchsanleitungen sollten befolgt werden.

5. Reinigung

Den Stecker dieses Gerätes vor dem Reinigen von der Steckdose abtrennen. Keine flüssigen Reinigungsmittel oder Sprühreiniger verwenden. Zum Reinigen ein angefeuchtetes Tuch verwenden.

6. Zubehör

Vom Geräte-Hersteller nicht empfohlenes Zubehör sollte nicht verwendet werden, da es eine Gefahrenquelle darstellen kann.

7. Wasser und Feuchtigkeit

Dieses Gerät nicht in der Nähe von Wasser verwenden - z.B. in der Nähe einer Badewanne, eines Waschbeckens, einer Küchenspüle oder einer Waschmaschine, in einem feuchten Keller oder in der Nähe eines Schwimmbeckens usw.

8. Zubehör

Das Gerät nicht auf einen instabilen Wagen, einem Ständer, einem Stativ, einer Halterung oder auf einem Tisch aufstellen. Das Gerät kann herunterfallen und es können ernsthafte Körperverletzungen bei Kindern oder Erwachsenen auftreten oder es kann zu Beschädigungen des Gerätes kommen. Nur Wagen, Ständer, Stativ, Halterung oder einen Tisch verwenden, der vom Hersteller empfohlen wird oder zusammen mit dem Gerät verkauft wird. Bei Befestigung an einer Wand oder in einem Regal den Anleitungen des Herstellers folgen und einen vom Hersteller empfohlenen Befestigungssatz verwenden.

9. Transport

Das auf einem Regal aufgestellte Gerät sollte zusammen mit dem Regal vorsichtig bewegt werden. Ein schnelles Anhalten, übermäßige Gewalt und unebene Oberflächen können zum Umstürzen des Gerätes oder des Regals führen.



10. Belüftung

Schlitze und Öffnungen im Gehäuse sind für die Belüftung vorgesehen, stellen den Betrieb des Gerätes sicher und schützen vor Überhitzen. Diese Öffnungen sollten niemals blockiert werden, indem das Gerät auf einem Bett, Sofa, Teppich oder einer ähnlichen Oberfläche aufgestellt wird. Das Gerät sollte nur in einem anderem Gehäuse, z.B. einem Bücherregal oder Schrank eingebaut werden, wenn eine ausreichende Belüftung sichergestellt ist oder den Anleitungen des Herstellers Folge geleistet wurde.

11. Stromversorgung

Dieses Gerät sollte nur mit der auf dem Aufkleber bezeichneten Stromquelle betrieben werden. Falls Fragen über die Art der Stromversorgung auftreten, wenden Sie sich an den Händler oder das örtliche Energieversorgungsunternehmen. Bei Geräten, die mit Batterien oder anderen Stromquellen betrieben werden, siehe die Bedienungsanleitung.

12. Erdung oder Polarisierung

Dieses Produkt ist mit einer der folgenden Arten von Steckern ausgestattet. Sollte es nicht möglich sein, den Stecker in die Netzsteckdose einzustecken, lassen Sie sich bitte von Ihrem Elektriker beraten. Umgehen Sie jedoch auf keinen Fall den Sicherheitszweck des Steckers.

- Zweidraht (Netz)-Stecker.

- Dreidraht-Erde (Netz)-Stecker mit einem Erdungsanschluss.

Dieser Stecker passt ausschließlich in eine Erdungs-Netzsteckdose.

13. Schutz des Netzkabels

Netzkabel sollten nicht im Durchgangsbereich von Personen verlegt werden oder an Orten, an denen Gegenstände auf sie gestellt oder gelegt werden. Besondere Beachtung sollten die Stecker der Kabel, Verlängerungskabel mit Steckdosen und die Stellen finden, an denen die Kabel aus dem Gerät austreten.

14. Blitzschlag

Als zusätzlicher Schutz dieses Gerätes während eines Gewitters, oder wenn es für längere Zeit unbeaufsichtigt steht und nicht verwendet wird, sollte der Netzstecker von der Steckdose abgetrennt werden. Dadurch wird eine Beschädigung des Gerätes durch Blitzschlag und Spannungstöße in der Stromleitung vermieden.

15. Überladung

Nicht die Netzsteckdosen, die Verlängerungskabel oder Verlängerungskabel mit Steckdosen überladen, da dies Feuer oder elektrischen Schlag verursachen kann.

16. Eindringen von Gegenständen und Flüssigkeiten

Niemals Gegenstände durch die Öffnungen in das Gerät einführen, da dies zum Kontakt mit stromführenden Teilen und zu Kurzschlüssen führen und Feuer oder elektrischen Schlag zur Folge haben kann. Keine Flüssigkeiten auf dem Gerät verschütten.

17. Wartung

Nicht versuchen, das Gerät selbst zu warten, da beim Öffnen oder Entfernen der Abdeckungen gefährliche Stromspannungen oder anderen Gefahren vorhanden sind. Alle Wartungsarbeiten dem Kundendienst überlassen.

18. Wartung durch den Kundendienst

Das Gerät sofort von der Steckdose abtrennen und den Kundendienst benachrichtigen, falls folgende Situationen eintreten:

- Wenn das Netzkabel oder der Netzstecker beschädigt ist.
- Wenn Flüssigkeit in das Gerät eingedrungen ist oder Gegenstände hineingefallen sind.
- Wenn das Gerät mit Regen oder Wasser in Kontakt gekommen ist.
- Wenn das Gerät nicht normal betrieben werden kann, selbst wenn die Bedienungsanweisungen befolgt werden. Nur diejenigen Regler einstellen, die in der Bedienungsanleitung beschrieben werden, da die falsche Einstellung anderer Regler eine Beschädigung zur Folge haben kann, und umfangreiche Reparaturarbeiten durch einen qualifizierten Techniker zur Wiederherstellung des Gerätes für einen normalen Betrieb notwendig werden.
- Wenn das Gerät fallengelassen und beschädigt wurde.
- Wenn eine Änderung des normalen Betriebs festgestellt wird, die eine Wartung notwendig macht.

19. Austauschteile

Falls Austauschteile benötigt werden, ist sicherzustellen, dass der Wartungstechniker die vom Hersteller vorgeschriebenen Bauteile verwendet, welche die gleichen Eigenschaften wie die Original-Bauteile aufweisen. Die Verwendung von anderen als Original-Bauteilen kann Feuer, elektrischen Schlag oder andere Gefahren zur Folge haben.

20. Sicherheitsprüfung

Nach Beendigung einer Wartung oder Reparatur dieses Gerätes den Wartungstechniker mit der Durchführung einer Sicherheitsprüfung beauftragen und überprüfen lassen, dass das Gerät in einem sicheren Betriebszustand ist.

21. Wand- oder Deckenmontage

Dieses Gerät sollte nur so an eine Wand oder Decke montiert werden, wie es vom Hersteller empfohlen wird.

22. Wärmequellen

Dieses Gerät sollte nicht in der Nähe von Wärmequellen wie Heizkörpern, Heizern, Öfen oder anderen Geräten (einschließlich Verstärkern) aufgestellt werden, die Wärme produzieren.



Lesen Sie beim Setup Ihres Projektors unbedingt die folgenden Sicherheitshinweise.

Vorsichtsmaßnahmen bei der Handhabung der Lampeneinheit

- Wenn die Lampe zerspringt, kann es zu Verletzungen durch Glassplitter kommen. Falls die Lampe zerspringt, sollten Sie die Lampe von einem von SHARP autorisierten Händler für Projektoren oder vom Kundendienst austauschen lassen.

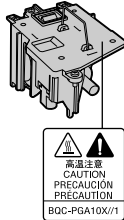

Vorsichtsmaßnahmen bei der Aufstellung des Projektors

- Im Hinblick auf möglichst wenig Wartungsintervalle und Aufrechterhaltung der Bildqualität empfiehlt SHARP, den Projektor nicht in Räumen mit hoher Luftfeuchtigkeit, Staub und Zigarettenrauch aufzustellen. Wenn der Projektor in dieser Umgebung verwendet wird, muss das Objektiv öfter gereinigt werden. Wenn der Projektor regelmäßig gereinigt wird, wird die Betriebsdauer bei Verwendung des Gerätes in einer solchen Umgebung nicht reduziert. Eine interne Gerätereinigung darf nur von einem von SHARP autorisierten Händler für Projektoren oder vom Kundendienst durchgeführt werden.

Stellen Sie den Projektor nicht dort auf, wo er direktem Sonnenlicht oder hellem Licht ausgesetzt ist.

- Positionieren Sie die Bildwand so, dass sie nicht direktem Sonnenlicht oder Raumbelichtung ausgesetzt ist. Licht, das direkt auf die Bildwand einfällt, schwächt die Farben und macht das Betrachten schwierig. Schließen Sie die Vorhänge und dämpfen Sie das Licht, wenn die Bildwand in einem sonnigen oder hellen Raum aufgestellt wird.

Der Projektor kann gefahrlos auf den Maximalwinkel von 12 Grad geneigt werden.

- Eine Platzierung sollte innerhalb von ± 12 Grad horizontal erfolgen.

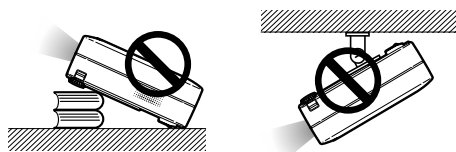

Setzen Sie den Projektor keinen harten Stößen und/oder Vibrationen aus.

- Handhaben Sie das Objektiv vorsichtig und schlagen Sie nicht gegen das Objektiv bzw. beschädigen Sie die Objektivoberfläche nicht.

Gönnen Sie Ihren Augen gelegentlich eine Pause.

- Ununterbrochenes Betrachten der Bildwand über Stunden überanstrengt Ihre Augen. Gönnen Sie Ihren Augen unbedingt gelegentlich eine Pause.

Vermeiden Sie Aufstellungsorte, an denen extreme Temperaturen herrschen.

- Die Betriebstemperatur für den Projektor liegt bei 41°F bis 95°F (+5°C bis +35°C).
- Die Lagertemperatur für diesen Projektor liegt bei -4°F bis 140°F (-20°C bis +60°C).

Blockieren Sie nicht die Luftaustritt- und Einsaugöffnungen.

- Halten Sie mindestens $7 \frac{7}{8}$ Inches (20 cm) Abstand zwischen der Luftaustrittöffnung und der nächsten Wand oder einem Gegenstand ein.
- Vergewissern Sie sich, dass die Einsaugöffnung und die Luftaustrittöffnung nicht blockiert ist.
- Wenn der Kühlventilator blockiert wird, schaltet die Schutzschaltung den Projektor automatisch aus. Dies zeigt keine Fehlfunktion an. Stellen Sie den Projektor dort auf, wo die Einsaug- und Austrittöffnungen nicht blockiert werden, stecken Sie das Netzkabel wieder und schalten Sie den Projektor. Dadurch wird der Projektor wieder auf den normalen Betrieb eingestellt.

Vorsichtsmaßnahmen beim Transport des Projektors

- Beim Transport des Projektors darf er keinen Erschütterungen und/oder Vibrationen ausgesetzt werden, da er anderenfalls beschädigt werden könnte. Handhaben Sie das Objektiv besonders vorsichtig. Trennen Sie vor dem Transport des Projektors unbedingt das Netzkabel von der Steckdose und andere Anschlusskabel ab.

Andere angeschlossene Geräte

- Wenn ein Computer oder ein anderes audiovisuelles Gerät an den Projektor angeschlossen wird, führen Sie die Anschlüsse NACH Ausschalten des Projektors und des anzuschließenden Gerätes aus.
- Bitte lesen Sie für die Anschlussausführung die Bedienungsanleitung des Projektors und des anzuschließenden Gerätes.

Verwendung des Projektors in anderen Ländern

- Die Stromspannung und die Steckerform kann je nach Region oder Land, in dem Sie den Projektor verwenden, unterschiedlich sein. Verwenden Sie, wenn der Projektor in Übersee verwendet wird, unbedingt das für das jeweilige Land zu verwendende Netzkabel.

Temperatur-Überwachungsfunktion

- Wenn der Projektor aufgrund von Problemen bei der Aufstellung oder wegen eines Blockierens der Luftöffnungen zu warm wird, leuchtet  und "TEMP." in der unteren linken Ecke des Bildes. Wenn die Temperatur weiterhin ansteigt, wird die Lampe ausgeschaltet und die TEMPERATURWARN-Anzeige auf dem Projektor blinkt. Nach einer Abkühlzeit von 90 Sekunden wird das Gerät ausgeschaltet.



Info

- Der Kühlventilator reguliert die interne Temperatur; seine Leistung wird automatisch geregelt. Das Ventilatorgeräusch kann sich während des Projektorbetriebes entsprechend der Ventilator Drehzahl ändern. Dies zeigt keine Fehlfunktion an.
- Trennen Sie das Netzkabel nicht während der Projektion oder des Kühlventilatorbetriebs ab. Dies kann eine Beschädigung durch einen Anstieg der internen Temperatur hervorrufen, da auch der Kühlventilatorbetrieb stoppt.



Zugriff auf die PDF-Bedienungsanleitungen

Die CD-ROM beinhaltet Bedienungsanleitungen im PDF-Format in mehreren Sprachen, damit Sie auch dann mit dem Projektor arbeiten können, wenn Sie dieses Handbuch nicht vorliegen haben. Zur Verwendung dieser Anleitungen muss der Adobe Acrobat Reader auf Ihrem PC (Windows oder Macintosh) installiert sein. Sollten Sie Acrobat Reader noch nicht installiert haben, können Sie das Programm von der CD-ROM herunterladen.

Installation von Acrobat Reader von der CD-ROM

Für Windows:

- ① Die CD-ROM in das CD-ROM-Laufwerk einlegen.
- ② Das Symbol "Arbeitsplatz" doppelt anklicken.
- ③ Das "CD-ROM"-Laufwerk doppelt anklicken.
- ④ Den "ACROBAT"-Ordner doppelt anklicken.
- ⑤ Die einzusehende Sprache (Ordnername) doppelt anklicken.
- ⑥ Das Installationsprogramm doppelt anklicken und die Anweisungen auf dem Bildschirm befolgen.

Für Macintosh:

- ① Die CD-ROM in das CD-ROM-Laufwerk einlegen.
- ② Das Symbol "CD-ROM" doppelt anklicken.
- ③ Den "ACROBAT"-Ordner doppelt anklicken.
- ④ Die einzusehende Sprache (Ordnername) doppelt anklicken.
- ⑤ Das Installationsprogramm doppelt anklicken und die Anweisungen auf dem Bildschirm befolgen.

Für andere Betriebssysteme:

Bitte laden Sie Acrobat Reader aus dem Internet (<http://www.adobe.com>) herunter.

Für andere Sprachen:

Wenn Acrobat Reader für andere nicht auf dieser CD-ROM enthaltene Sprachen verwendet werden soll, kann die entsprechende Version aus dem Internet heruntergeladen werden.

Zugriff auf die PDF-Bedienungsanleitungen

Für Windows:

- ① Die CD-ROM in das CD-ROM-Laufwerk einlegen.
- ② Das Symbol "Arbeitsplatz" doppelt anklicken.
- ③ Das "CD-ROM"-Laufwerk doppelt anklicken.
- ④ Den "MANUALS"-Ordner doppelt anklicken.
- ⑤ Die einzusehende Sprache (Ordnername) doppelt anklicken.
- ⑥ Die PDF-Datei "A10" doppelt anklicken, um auf die Bedienungsanleitung des Projektors zuzugreifen.

Für Macintosh:

- ① Die CD-ROM in das CD-ROM-Laufwerk einlegen.
- ② Das Symbol "CD-ROM" doppelt anklicken.
- ③ Den "MANUALS"-Ordner doppelt anklicken.
- ④ Die einzusehende Sprache (Ordnername) doppelt anklicken.
- ⑤ Die PDF-Datei "A10" doppelt anklicken, um auf die Bedienungsanleitung des Projektors zuzugreifen.



Hinweis

- Wenn die gewünschte PDF-Datei nicht durch das doppelte Anklicken mit der Maus geöffnet werden kann, sollte zuerst Acrobat Reader gestartet und dann die gewünschte Datei mit den Menüs "Datei", "Öffnen" bestimmt werden.
- Die Datei "readme.txt" auf der CD-ROM enthält wichtige Informationen, die nicht in der vorliegenden Bedienungsanleitung enthalten sind.



Avant d'utiliser ce projecteur, veuillez lire attentivement ce mode d'emploi.

Introduction

FRANÇAIS

Il y a au moins deux raisons valables pour enregistrer sans retard l'acquisition de ce projecteur SHARP en retournant la carte de garantie que contient l'emballage du projecteur.

1. GARANTIE

Vous êtes assuré de bénéficier pleinement des pièces et services attachés à la garantie aussitôt que la carte nous est retournée.

2. ACTE SUR LA SÉCURITÉ DE L'UTILISATEUR D'UN PRODUIT

Vous serez promptement informé de toute question concernant la sécurité, de toute modification nécessaire et de tout rappel en usine que SHARP serait tenu d'offrir dans le cadre de l'Acte de 1972 sur la sécurité de l'utilisateur d'un produit. VEUILLEZ LIRE ATTENTIVEMENT LE PARAGRAPHE IMPORTANT "GARANTIE LIMITÉE".

Etats-Unis uniquement

AVERTISSEMENT : Source de lumière de grande intensité. Ne pas fixer les yeux sur le faisceau lumineux, ne pas le regarder directement. S'assurer tout spécialement que les enfants ne fixent pas les yeux directement sur le faisceau.



AVERTISSEMENT : Pour réduire les risques d'incendie et d'électrocution, ne pas exposer cet appareil à la pluie ou à l'humidité.

Voir le dessous du projecteur.

	ATTENTION RISQUE D'ÉLECTROCUTION. NE PAS RETIRER LES VIS À L'EXCEPTION DE LA VIS RÉSERVÉE À L'ENTRETIEN.	
ATTENTION : AFIN D'ÉVITER LES RISQUES D'ÉLECTROCUTION, NE PAS RETIRER LE CAPOT SUPÉRIEUR. L'APPAREIL NE CONTIENT AUCUNE PIÈCE QUE L'UTILISATEUR PUISSE REMPLACER, À L'EXCLUSION DE LA LAMPE. CONFIER TOUTE RÉPARATION À UN PERSONNEL QUALIFIÉ.		



Le symbole de l'éclair inscrit dans un triangle équilatéral est un avertissement à l'attention de l'utilisateur sur la présence, à l'intérieur du produit, de pièces non isolées soumises à une "très haute tension" pouvant provoquer une électrocution.



Le symbole du point d'exclamation, inscrit dans un triangle équilatéral, a pour objet d'appeler l'attention de l'utilisateur sur la présence, dans la documentation accompagnant le produit, d'importantes instructions concernant son mode opératoire et son entretien (réparation).

AVERTISSEMENT : Les règles FCC stipulent que toute modification et transformation apportées à cet appareil qui ne seraient pas expressément approuvées par le fabricant peuvent entraîner, pour l'utilisateur, la perte du droit de faire fonctionner cet appareil.

Etats-Unis uniquement

INFORMATIONS

Cet appareil a été testé et reconnu conforme aux limites prescrites pour le matériel numérique de Classe A, selon les spécifications de la 15ème partie des Règles de la Commission Fédérale des Communications (FCC). Ces règles sont conçues pour assurer une protection suffisante contre des interférences nuisibles dans une zone résidentielle. Cet appareil génère, utilise et peut émettre des signaux radioélectriques et, s'il n'est pas installé et employé conformément aux prescriptions de son mode d'emploi, il peut provoquer des interférences de communications radio. Etant donné que cet appareil risque de provoquer effectivement des interférences nuisibles dans une zone résidentielle, l'utilisateur sera tenu d'y remédier et d'éliminer les interférences à son propre compte.

Etats-Unis uniquement

Le câble d'ordinateur fourni doit être utilisé avec l'appareil. Ce câble garantit la conformité de l'appareil avec les règles FCC concernant la Classe A.

Etats-Unis uniquement

AVERTISSEMENT :

Ce produit appartient à la Classe A. Dans un environnement résidentiel, il peut provoquer des interférences radio et, dans ce cas, l'utilisateur peut être obligé de prendre les mesures nécessaires.





MESURES DE SÉCURITÉ IMPORTANTES

ATTENTION : Veuillez lire toutes ces instructions avant de faire fonctionner ce produit et les conserver pour toutes consultations ultérieures.

L'électricité peut être utilisée pour beaucoup de fonctions utiles. Ce produit a été conçu et fabriqué pour assurer une utilisation en toute sécurité. CEPENDANT, TOUTE UTILISATION INCORRECTE PEUT CAUSER UNE ÉLECTROCUTION OU DÉCLANCHER UN INCENDIE. Pour éviter de contourner les dispositifs de sécurité incorporés à ce produit, veuillez respecter les règles de base suivantes pour son installation, utilisation et entretien.

1. Lire les instructions

Avant d'utiliser l'appareil, veuillez lire les instructions de sécurité et d'emploi.

2. Conservez les instructions

Les instructions de sécurité et d'emploi doivent être soigneusement conservées pour référence ultérieure.

3. Respectez les avertissements

Tous les avertissements apposés sur l'appareil ou notés dans le mode d'emploi doivent être respectés.

4. Suivre les instructions

Toutes les instructions de fonctionnement et d'emploi doivent être scrupuleusement suivies.

5. Nettoyage

Débranchez la prise secteur de l'appareil avant de le nettoyer. N'utilisez pas de liquides ou aérosols de nettoyage. Utilisez uniquement un chiffon humide pour nettoyer l'appareil.

6. Options

N'utilisez pas d'option non conseillée par le fabricant de l'appareil qui pourrait présenter le moindre risque.

7. Eau et humidité

N'utilisez pas cet appareil près d'un point d'eau, —à proximité d'une baignoire, d'un lavabo, d'un évier ou dans un sous-sol humide par exemple.

8. Accessoires

Ne déposez pas l'appareil sur un support instable. L'appareil risque de tomber et de causer des blessures graves à un enfant ou un adulte et d'être sérieusement endommagé. Utilisez uniquement les types de support conseillés par le fabricant ou vendus avec l'appareil. La fixation de l'appareil à un accessoire doit être conforme aux instructions du fabricant et doit être réalisée au moyen des pièces conseillées par le fabricant.

9. Transport

L'ensemble appareil et chariot doit être manoeuvré avec soin. Tout arrêt brutal, effort excessif ou inégalement du sol risque d'entraîner le renversement du chariot et la chute de l'appareil.



10. Ventilation

Les orifices et découpes pratiqués sur le coffret sont destinés à assurer la ventilation de l'appareil afin d'obtenir un fonctionnement fiable et d'éviter les surchauffes. Ces ouvertures ne doivent pas être obstruées en plaçant par exemple l'appareil sur un lit, un canapé, un tapis et toute autre surface similaire. L'appareil ne doit pas être installé dans un meuble, bibliothèque ou étagères si la ventilation adéquate ne peut être assurée et les instructions du fabricant respectées.

11. Sources d'alimentation

Cet appareil ne doit être alimenté qu'à partir du type de source indiqué sur la plaquette signalétique. Au moindre doute concernant le type de source disponible, contactez le revendeur de l'appareil ou la compagnie d'électricité. Dans le cas d'appareils fonctionnant sur batterie ou autre source que le secteur, reportez-vous au mode d'emploi.

12. Mise à la terre et polarisation

Ce produit est équipé d'un des types de prise suivant. Si la prise mâle du câble d'alimentation ne correspondant pas à celle du secteur, contactez un électricien pour la remplacer. N'utilisez la prise sans la sécurité supplémentaire offerte par ce type de prise.

- Type de prise à deux fils (secteur).
- Type de prise à trois fils (secteur) avec une borne de mise à la masse.
Cette dernière ne s'enfiche que dans une prise du secteur adéquate.

13. Protection du câble d'alimentation

Faites passer le câble d'alimentation de façon à ce qu'il ne puisse abîmé, piétiné, écrasé par un meuble ou tout objet lourd ; examinez soigneusement le cheminement du câble d'alimentation entre la prise du secteur et l'entrée de l'appareil.

14. Orage

Par mesure de protection complémentaire, débranchez le câble d'alimentation de la prise du secteur dès que survient un orage ou encore lorsque l'appareil ne va pas être utilisé pendant une longue période. Ainsi, l'appareil ne sera pas exposé à une surtension éventuelle du secteur due à la foudre.

15. Surcharge

Évitez de surcharger les prises du secteur murales ou intégrées ainsi que les rallonges car cela risque de provoquer un incendie ou une électrocution.

16. Introduction d'objets étrangers ou de liquide

N'essayez pas d'introduire des objets dans les ouvertures de l'appareil car ceux-ci risquent d'entrer en contact avec les composants soumis à des hautes tensions et provoquer un incendie ou une électrocution. Éviter d'asperger ou de renverser le moindre liquide sur l'appareil.

17. Réparation

Ne tentez aucune réparation de cet appareil par vous-même car l'ouverture ou le retrait du boîtier expose des composants soumis à des hautes tensions qui présentent des risques importants d'électrocution. S'adresser à un technicien qualifié pour toute réparation.

18. Dégâts entraînant une réparation

Dans les cas suivants, débranchez le câble d'alimentation et faites vérifier ou réparer l'appareil par du personnel qualifié :

- Le câble d'alimentation ou sa fiche est endommagé.
- Un liquide a été renversé sur l'appareil ou un objet étranger a été introduit dans l'appareil.
- L'appareil a été exposé à la pluie ou à l'eau.
- L'appareil ne fonctionne pas normalement bien que les instructions du mode d'emploi aient été respectées. N'utilisez pas d'autres commandes que celles mentionnées dans ce document car toute action risque d'endommager l'appareil et d'entraîner, le plus souvent, l'intervention coûteuse d'un technicien qualifié afin de rétablir les conditions normales de fonctionnement.
- L'appareil est tombé ou a été endommagé d'une manière ou d'une autre.
- Les performances de l'appareil se sont nettement dégradées et un entretien semble nécessaire.

19. Pièces de rechange

Si une pièce doit être remplacée, assurez-vous auprès du service de réparation que le remplacement sera effectué avec une pièce prescrite par le fabricant ou ayant des caractéristiques identiques. Des pièces de rechange non autorisées pourraient causer un incendie, une électrocution ou d'autres dangers.

20. Contrôle de sécurité

À la fin de toute intervention d'entretien ou de réparation, demandez au technicien d'effectuer les vérifications de sécurité pour déterminer si le produit est en état de fonctionnement correct.

21. Montage mural ou au plafond

Ce produit doit être monté sur un mur ou au plafond uniquement de la manière recommandée par le fabricant.

22. Chaleur

Cet appareil doit être placé loin des sources de chaleur telles que les radiateurs, accumulateurs de chaleur, poêles et autres appareils produisant de la chaleur (y compris les amplificateurs).



Assurez-vous de lire les mesures de sécurité suivantes lors de la mise en route de votre projecteur.

Mise en garde concernant l'ensemble lampe

- Prenez les précautions nécessaires en raison des risques potentiels présentés par les particules de verre en cas de rupture de la lampe. En cas de rupture, contactez le revendeur ou SAV agréé Sharp le plus proche pour effectuer son remplacement.

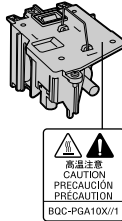

Précautions concernant la mise en route du projecteur

- Pour réduire l'entretien au minimum et maintenir une haute qualité d'image, SHARP recommande que ce projecteur soit installé dans un endroit à l'abri de l'humidité, de la poussière et de la fumée de cigarette. Lorsque le projecteur est exposé à ces éléments, l'objectif doit être nettoyé plus souvent. Tant que le projecteur est nettoyé régulièrement, son utilisation dans cet environnement ne réduira pas sa durée de fonctionnement. Le nettoyage interne doit être effectué uniquement par un revendeur ou SAV agréé Sharp.

N'installez pas le projecteur dans les endroits exposés au soleil ou à un fort éclairage.

- Positionnez l'écran de façon à ce qu'il ne soit pas exposé directement au soleil ou à l'éclairage de la pièce. Toute lumière directe sur l'écran délave les couleurs et rend le visionnage difficile. Fermez les rideaux et diminuez l'éclairage lorsque vous installez l'écran dans une pièce ensoleillée ou très éclairée.

Le projecteur peut sans risques être incliné à un angle maximum de 12 degrés.

- Le placement doit être de +/- 12 degrés par rapport à l'horizontale.



N'installez pas le projecteur dans les endroits où il pourrait être soumis à des chocs ou à des vibrations.

- Prenez garde à ne pas cogner ou endommager la lentille de l'objectif.

Reposez vos yeux de temps en temps.

- Le visionnage continu de l'écran pendant des heures fatigue les yeux. Assurez-vous de reposer vos yeux.

Évitez les endroits où règnent des conditions de température extrêmes.

- La température de fonctionnement du projecteur doit être comprise entre 41°F et 95°F (+5 et +35°C).
- La température de stockage du projecteur doit être comprise entre -4°F et 140°F (-20°C et +60°C).

Ne pas obstruer les orifices d'entrée ou d'évacuation d'air.

- Laissez un espace d'au moins 7 7/8" (20 cm) entre l'orifice d'évacuation d'air et le mur ou l'obstacle le plus proche.
- Assurez-vous que les arrivées ou les évacuations d'air ne sont pas obstrués.
- Si le ventilateur de refroidissement est obstrué, un circuit de protection arrêtera automatiquement le projecteur. Cela n'est pas un signe de dysfonctionnement. Débranchez le câble d'alimentation au niveau de la prise du secteur et attendez au moins 10 minutes. Placez le projecteur dans un endroit où les orifices d'entrée ou d'évacuation d'air ne sont pas obstrués, puis rebranchez le câble d'alimentation et mettez le projecteur en marche. Cette opération remettra le projecteur en état normal de fonctionnement.

Précautions à prendre pour le transport du projecteur

- Lorsque vous transportez le projecteur, prenez garde de ne pas le soumettre à des chocs et / ou à des vibrations car les chocs risquent de l'endommager. Faites extrêmement attention à l'objectif. Avant de déplacer le projecteur, débranchez le câble d'alimentation de la prise du secteur ainsi que tout autre câble de raccordement.

Autres équipements connectés

- Avant de raccorder au projecteur un ordinateur ou tout autre équipement audiovisuel, veillez à tous les éteindre d'abord.
- Veuillez lire les modes d'emploi du projecteur et des équipements à connecter avant de procéder au raccordement.

Utilisation du projecteur dans d'autres pays

- La tension et la forme de la prise du secteur peuvent varier suivant la région ou le pays où vous souhaitez utiliser le projecteur. Quand le projecteur est utilisé dans un autre pays, assurez-vous d'utiliser le câble d'alimentation approprié.

Fonction de surveillance de la température

- Si le projecteur commence à surchauffer à cause de problèmes d'installation ou d'obstruction des ouïes de ventilation, "X" et "TEMP." se mettent à s'allumer dans le coin inférieur gauche de l'image. Si la température continue d'augmenter, la lampe s'éteindra, le voyant d'alarme de température élevée sur le projecteur se mettra à clignoter et après une période de refroidissement de 90 secondes, l'alimentation sera coupée.



Info

- Le ventilateur de refroidissement régule la température intérieure du projecteur et son fonctionnement est contrôlé automatiquement. Le bruit du ventilateur peut changer en cours de projection à cause de la modification de sa vitesse. Cela n'est pas un signe de dysfonctionnement.
- Ne pas débrancher le câble d'alimentation pendant la projection ou le fonctionnement du ventilateur de refroidissement. L'appareil risque d'être endommagé par l'augmentation de sa température interne consécutive à l'arrêt du ventilateur qui ne peut assurer le cycle de refroidissement prévu.



Comment accéder aux modes d'emploi PDF

Les manuels techniques au format PDF et en plusieurs langues sont inclus dans le CD-ROM afin que vous puissiez travailler avec le projecteur même si vous ne possédez pas ce manuel. Pour utiliser ces manuels, le programme Adobe Acrobat Reader doit être installé sur votre PC (Windows ou Macintosh). Si Acrobat Reader n'est pas encore installé sur votre machine, vous pouvez l'installer à partir du CD-ROM.

Pour installer Acrobat Reader à partir du CD-ROM

Sous Windows :

- ① Placez le CD-ROM dans le lecteur.
- ② Double-cliquez sur l'icône "Poste de travail".
- ③ Double-cliquez sur le lecteur de CD-ROM.
- ④ Double-cliquez sur le dossier "ACROBAT".
- ⑤ Double-cliquez sur la langue (nom du dossier) que vous souhaitez utiliser.
- ⑥ Double-cliquez sur le programme d'installation et suivez les instructions qui s'affichent à l'écran.

Sur Macintosh :

- ① Placez le CD-ROM dans le lecteur.
- ② Double-cliquez sur l'icône "CD-ROM".
- ③ Double-cliquez sur le dossier "ACROBAT".
- ④ Double-cliquez sur la langue (nom du dossier) que vous souhaitez utiliser.
- ⑤ Double-cliquez sur le programme d'installation et suivez les instructions qui s'affichent à l'écran.

Pour les autres systèmes d'exploitation :

Veillez télécharger Acrobat Reader sur le site Internet (<http://www.adobe.com>).

Pour les autres langues :

Si vous préférez utiliser Acrobat Reader dans une autre langue que celles incluses sur le CD-ROM, veuillez télécharger la version appropriée sur le site Internet.

Accès aux modes d'emploi PDF

Sous Windows :

- ① Placez le CD-ROM dans le lecteur.
- ② Double-cliquez sur l'icône "Poste de travail".
- ③ Double-cliquez sur le lecteur de CD-ROM.
- ④ Double-cliquez sur le dossier "MANUALS".
- ⑤ Double-cliquez sur la langue (nom du dossier) que vous souhaitez utiliser.
- ⑥ Double-cliquez sur le fichier pdf "A10" pour accéder aux manuels du projecteur.

Sur Macintosh :

- ① Placez le CD-ROM dans le lecteur.
- ② Double-cliquez sur l'icône "CD-ROM".
- ③ Double-cliquez sur le dossier "MANUALS".
- ④ Double-cliquez sur la langue (nom du dossier) que vous souhaitez utiliser.
- ⑤ Double-cliquez sur le fichier pdf "A10" pour accéder aux manuels du projecteur.



Remarque

- Si le fichier PDF souhaité ne peut être ouvert par un double clic de souris, lancez d'abord Acrobat Reader, spécifiez ensuite le fichier souhaité en utilisant le menu "Fichier", "Ouvrir".
- Reportez-vous au fichier "readme.txt" sur le CD-ROM pour obtenir des informations importantes n'apparaissant pas dans ce manuel technique.

Läs noga denna bruksanvisning innan projektorn tas i bruk.

Introduktion

SVENSKA

Det finns två viktiga anledningar till att snabbt registrera garantin för din SHARP-projektor med hjälp av registreringskortet som medföljer projektorn.

1. GARANTI

Denna är till för att försäkra att du erhåller alla förmåner ifråga om reservdelar, service och arbete som garanteras för enheten vid inköpet.

2. SÄKERHETSLAG FÖR KONSUMENTPRODUKT

För att försäkra att du snabbt erhåller säkerhetsbesked om inspektion, modifiering eller återkallning som SHARP är förpliktad att ge enligt 1972 års Säkerhetslag för Konsumentprodukter, BÖR DU NOGA LÄSA DEN VIKTIGA KLAUSULEN "BEGRÄNSAD GARANTI".

ENBART USA

VARNING: Våldigt skarp ljuskälla. Titta inte rakt in i strålen. Var speciellt noga med att barn inte tittar direkt in i ljusstrålen.

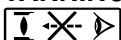

VARNING: För att begränsa risken för brand eller elstötar skall enheten hållas borta från regn och fukt.

Se projektorns undersida.

	OBSERVERA RISK FÖR ELSTÖTAR. AVLÄGSNA INTE NÅGRA SKRUVAR UTÖVER DE SPECIFIKT ANGIVNA SERVICEKRUVARNA.	
OBSERVERA: FÖR ATT REDUCERA RISKEN FÖR ELSTÖTAR FÅR LOCKET INTE TAS AV. UTÖVER LAMPENHETEN FINNS DET INGA DELAR SOM KONSUMENTEN KAN REPARERA. ÖVERLÅT ALLT SERVICEARBETE TILL KVALIFICERAD PERSONAL.		



Symbolen med en blixtnuti en liksidig triangel är avsedd att varna användaren för närvaron av oisolerad "farlig spänning" inuti enheten som är tillräcklig kraftig för att orsaka elstötar.



Utropstecknet inuti en triangel gör användaren uppmärksam på viktiga föreskrifter för drift och underhåll (service) i dokumentationen som medföljer enheten.

VARNING: De amerikanska FCC-bestämmelserna fastslår att ändringar eller modifieringar utan särskilt tillstånd från tillverkaren kan häva användarens rätt att använda enheten.

ENBART USA

INFORMATION

Denna utrustning har testats och funnits uppfylla gränserna för digitala produkter av klass A, i enlighet med del 15 i de amerikanska FCC-reglerna. Dessa gränser är fastställda för att erbjuda rimligt skydd mot skadliga störningar i en kommersiell miljö. Denna utrustning alstrar, använder sig av och kan avge radiofrekvensenergi och kan störa radiomottagning om den inte installeras eller används i enlighet med anvisningarna i denna bruksanvisning. Användning av denna utrustning i en hemmiljö kommer sannolikt att orsaka störningar, i vilket fall kunden själv måste lösa problemet på egen hand.

ENBART USA

Den medlevererade datorkabeln måste användas med enheten. Denna kabel försäkras att enheten uppfyller FCC:s godkännande av produkten för klass A.

ENBART USA

VARNING:

Detta är en produkt av klass A. I hemmiljö kan produkten störa radiomottagning, i vilket fall användaren kan behöva vidta motåtgärder.

VIKTIGA SÄKERHETSFORESKRIFTER

OBSERVERA: Läs dessa föreskrifter innan du använder produkten för första gången och spara dem för framtida bruk.

Man kan använda elektricitet till många praktiska saker. Denna produkt har utvecklats och tillverkats för att kunna säkerställa din personliga säkerhet. FELAKTIG HANTERING KAN MEDFÖRA RISK FÖR ELEKTRISKA STÖTAR ELLER BRAND. För att inte sätta de säkerhetsanordningar som byggts in i denna produkt ur spel, måste följande grundregler beaktas vid installation, användning och underhåll.

1. Läs anvisningarna

Läs noga alla föreskrifter om säkerhet och drift innan produkten tas i bruk.

2. Bevara anvisningarna

Alla föreskrifter om säkerhet och drift bör förvaras på ett säkert ställe för framtida referens.

3. Lakta varningarna

lakta samtliga varningar som förekommer i bruksanvisningen och på själva produkten.

4. Följ anvisningarna

Följ noga samtliga instruktioner om säkerhet och tillvägagångssätt.

5. Rengöring

Koppla loss enheten från el-uttaget före rengöring. Använd inte flytande rengöringsmedel eller sådana av sprejtyp. Rengör med en fuktig trasa.

6. Anordningar

Använd inte anordningar som inte specifikt rekommenderas av tillverkaren då sådana kan orsaka problem.

7. Vatten och fukt

Använd inte enheten i närheten av vatten – t.ex. nära ett badkar, tvättställ, diskbänk eller tvättmaskin, och ej heller i en fuktig källare, nära en simbassäng e.dyl.

8. Tillbehör

Placera inte enheten på en ostadig vagn, ställning, stativ, hållare eller bord. Enheten kan falla och skadas eller utsätta någon för personskador. Använd endast en vagn, ställning, stativ, hållare eller bord som rekommenderas av tillverkaren eller säljs tillsammans med enheten. Montering av enheten bör utföras enligt tillverkarens anvisningar och med monteringsstillbehör som rekommenderas av tillverkaren.

9. Transport

En kombination av denna enhet och en vagn bör flyttas med största försiktighet. Hastiga stopp, kraftiga stötar och ojämna underlag kan göra att ekipaget välter och skadas.



10. Ventilation

Skåror och öppningar är avsedda att förse enheten med ventilation som försäkras mot felrikt drift och skyddar mot överhettning. Dessa öppningar bör aldrig täckas över eller blockeras genom att placera enheten på en säng, soffa, tjock matta eller liknande underlag. Enheten bör ej heller placeras på inneslutna ställen såsom i en bokhylla eller ställning såvida inte lämplig ventilation kan försäkras enligt tillverkarens anvisningar.

11. Strömkällor

Denna produkt får endast drivas med den typ av strömkälla som anges på märketiketten. Kontakta din återförsäljare eller det lokala elkraftbolaget om du är osäker på vilken spänning som används i hemmet. För produkter som skall drivas med batterier eller någon annan strömkälla bör du anläta bruksanvisningen som medföljer denna.

12. Jordning och polarisation

Till denna produkt medföljer en av de följande typerna av stickproppar. Om stickproppen inte kan stickas in i eluttaget, skall du kontakta en elektriker. Koppla inte ur jorden i stickproppen. Upphäv inte stickproppens säkerhetssyfte.

- Tvåtrådig (nät-) stickpropp.
- Tretrådig jordad (nät-) stickpropp med jorduttag.

Denna stickpropp passar endast i ett jordat eluttag.

13. Skydd av nätkabeln

Alla nätkablar skall dras så att det inte finns risk att någon trampar på dem eller att de kläms av möbler eller andra föremål. Var speciellt försiktig med kablarnas kontakter, förlängningsledningar närintaget på enheten.

14. Åskväder

Koppla för säkerhets skull loss nätkabeln från både eluttaget och närintaget på enheten vid åskväder och inför perioder då enheten inte skall användas under en längre tid. Detta förhindrar skador på enheten som kan orsakas av blixtnedslag eller strömrusning.

15. Överbelastning

Akta dig för att överbelasta vägguttag, förlängningskablar och stickproppsadaptrar då detta kan skapa risk för brand och elstötar.

16. Intrång av föremål och vätskor

Stick aldrig in föremål av något slag i öppningarna på enheten då de kan vidröra delar med högspänning eller kortsluta kretsar och därmed skapa risk för brand och elstötar. Var också noga med att inte spillta vätskor på enheten.

17. Servicearbete

Försök aldrig att reparera produkten på egen hand då öppning eller borttagning av locken kan utsätta dig för hög spänning eller andra faror. Överlåt alla servicearbeten till en kvalificerad servicetekniker.

18. Skador som kräver service

Koppla loss enheten från eluttaget och kontakta kvalificerad servicepersonal om något av det följande inträffar:

- Nätkabeln eller dess stickpropp har skadats.
- Vätska har spillts på eller föremål har trängt in i produkten.
- Produkten har utsatts för regn eller vattenstänk.
- Om produkten uppträder onormalt trots att den hanteras enligt bruksanvisningen. Använd endast de reglage som specifikt anges i bruksanvisningen då felaktig justering med övriga reglage kan leda till svåra skador, som kan kräva omfattande reparationer av en kvalificerad tekniker.
- Produkten har tappats eller på något sätt utsatts för skador.
- Service kan också behövas när bild- och ljudkvalitet skiljer sig märkbart från den normala.

19. Reservdelar

Om några delar behöver bytas skall du försäkra att teknikern använder delar som specifikt anges av tillverkaren eller som har samma egenskaper som den ursprungliga delen. Delar som ej godkänts kan medföra risk för brand, elektriska stötar eller annan fara.

20. Säkerhetskontroll

Efter avslutad service eller reparationsarbete skall du be teknikern att utföra en fullständig säkerhetskontroll för att försäkra att produkten är i fullgod driftskondition.

21. Tak- eller väggmontering

Vid montering av enheten på en vägg eller hängande i taket skall tillverkarens rekommendationer noggrant följas.

22. Värme

Produkten bör hållas på behörigt avstånd från värmekällor som element, värmeutsläpp, spisar och andra föremål (inklusive förstärkare) som avger värme.



Observera följande säkerhetsföreskrifter vid projektorns uppställning.

Observera angående lampenheten

- Det föreligger risk för skärsår om lampan råkar spricka. Kontakta närmaste auktoriserade Sharp-projektorhandlare eller en serviceverkstad för att köpa en byteslampa om detta inträffar.

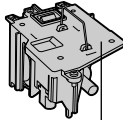

Observera angående projektorns uppställning

- För att reducera behovet för servicearbete och försäkra en fortsatt hög bildkvalitet rekommenderar SHARP att projektorn installeras på ett ställe som ej utsätts för fukt, damm och cigarrettrök. Objektivt måste rengöras oftare om projektorn används i en sådan miljö. Användning i dessa slags miljöer förkortar dock inte projektorns livslängd så länge den rengörs regelbundet. Intern rengöring bör endast utföras av en auktoriserad Sharp-projektorhandlare eller en serviceverkstad.

Placera inte projektorn på en plats som utsätts för direkt solljus eller mycket stark belysning.

- Placera duken så att den inte utsätts för direkt solljus eller rummets belysning. Ljus som träffar duken direkt orsakar bleka färger och försvårar tittningen. Dra för gardinerna och dämpa belysningen i rummet om visningen görs i ett rum med mycket solljus eller annan stark belysning.

Projektorn kan lutas till en vinkel på högst 12 grader.

- Placeringen ska vara inom ± 12 grader horisontellt.



Utsätt inte projektorn för hårda stötar och/eller skakningar.

- Se upp så att objektivet inte utsätts för stötar eller att linsytan skadas.

Låt dina ögon vila med jämna mellanrum.

- Kontinuerligt tittande på skärmen under flera timmar är ansträngande för ögonen. Ta därför paus in emellan för att vila ögonen.

Undvik platser med extrema temperaturer.

- Projektorns arbetsmiljö är från 41°F till 95°F (+5°C till +35°C).
- Projektorns förvaringstemperatur är från -4°F till 140°F (-20°C till +60°C).

Blockera inte ventilationsöppningarna.

- Lämna ett utrymme på minst 7 7/8" (20 cm) mellan luftuttaget och närmaste vägg eller annat föremål.
- Se till att luftintaget och ventilationsöppningarna inte blockeras.
- En skyddsanordning slår automatiskt av projektorlampan om kylfläkten blockeras. Detta tyder inte på något fel. Koppla loss projektorns nätkabel från eluttaget och vänta i minst 10 minuter. Se till att projektorn står på en plats där luftintaget och ventilationsöppningarna inte blockeras, anslut nätkabeln igen och sätt på projektorn. Projektorn bör då fungera som vanligt.

Observera angående transport av projektorn

- Se till att projektorn inte utsätts för hårda stötar och/eller skakningar när den ska transporteras, eftersom detta kan orsaka skador. Var mycket försiktig med objektivet. Innan projektorn flyttas, ska du koppla loss dess nätkabel från eluttaget samt andra kablar som anslutits till den.

Annan ansluten utrustning

- Vid anslutning till en dator eller annan audio-visuell utrustning ska dessa anslutningar göras EFTER att strömmen slagits av på projektorn samt på den utrustning som ska anslutas.
- Läs bruksanvisningarna för projektorn och den andra utrustningen som ska anslutas för information om hur anslutningarna görs rätt.

Användning av projektorn i andra länder

- Strömförsörjningen och stickkontaktens utformning kan vara annorlunda i andra länder där projektorn ska användas. Om projektorn ska användas i ett annat land, ska du anskaffa en korrekt nätkabel för det land du tänker besöka.

Temperaturövervakningsfunktion

-  och "TEMP." visas i bildens nedre vänstra hörn, om projektorn börjar överhettas på grund av felaktig installation eller blockerade ventilationsöppningar. Om temperaturen därefter fortsätter att stiga sloknar lampan, temperaturvarningsindikatorn (TEMP.) på projektorn börjar blinka och strömmen slås sedan av efter en kylperiod på 90 sekunder.



Försiktig

- Kylfläkten reglerar den interna temperaturen och dess funktion kontrolleras automatiskt. Ljudet från fläkten kan variera under användning p.g.a. växlingar i fläkthastigheten. Detta är normalt och tyder inte på något fel.
- Koppla inte loss nätkabeln under bildvisning eller när kylfläkten är igång. Detta kan orsaka skador i projektorn som följd av överhettning, eftersom kylfläkten då stannar.

Hur du läser PDF-bruksanvisningarna

På CD-ROM-skivan finns bruksanvisningar i PDF-format på flera olika språk så att du kan använda projektorn även om du inte har denna bruksanvisning. För att kunna använda dessa anvisningar måste du installera Adobe Acrobat Reader i din persondator (Windows eller Macintosh). Om du inte redan har installerat Acrobat Reader, kan du göra det från CD-ROM-skivan.

Installation av Acrobat Reader från din CD-ROM-skiva

För Windows:

- ① Sätt in CD-ROM-skivan i din CD-ROM-enhet.
- ② Dubbelklicka på ikonen "Den här datorn".
- ③ Dubbelklicka på "CD-ROM-enhet".
- ④ Dubbelklicka på mappen "ACROBAT".
- ⑤ Dubbelklicka på det språk (mappnamn) som du vill se.
- ⑥ Dubbelklicka på installationsprogrammet och följ anvisningarna på skärmen.

För Macintosh:

- ① Sätt in CD-ROM-skivan i din CD-ROM-enhet.
- ② Dubbelklicka på ikonen "CD-ROM".
- ③ Dubbelklicka på mappen "ACROBAT".
- ④ Dubbelklicka på det språk (mappnamn) som du vill se.
- ⑤ Dubbelklicka på installationsprogrammet och följ anvisningarna på skärmen.

För andra operativsystem:

Nerladda Acrobat Reader från Internet (<http://www.adobe.com>).

För andra språk:

Om du vill använda Acrobat Reader för språk utöver de som inkluderas på CD-ROM-skivan, kan du ladda ner lämplig version från Internet.

Hur du läser PDF-bruksanvisningarna

För Windows:

- ① Sätt in CD-ROM-skivan i din CD-ROM-enhet.
- ② Dubbelklicka på ikonen "Den här datorn".
- ③ Dubbelklicka på "CD-ROM-enhet".
- ④ Dubbelklicka på mappen "MANUALS".
- ⑤ Dubbelklicka på det språk (mappnamn) som du vill se.
- ⑥ Dubbelklicka på pdf-filen "A10" för att öppna projektorns bruksanvisningar.

För Macintosh:

- ① Sätt in CD-ROM-skivan i din CD-ROM-enhet.
- ② Dubbelklicka på ikonen "CD-ROM".
- ③ Dubbelklicka på mappen "MANUALS".
- ④ Dubbelklicka på det språk (mappnamn) som du vill se.
- ⑤ Dubbelklicka på pdf-filen "A10" för att öppna projektorns bruksanvisningar.



Anm

- Om den önskade pdf-filen inte kan öppnas genom att dubbelklicka med musen, ska du först starta Acrobat Reader och sedan specificera önskad fil med menyn "Fil", "Öppna".
- I "readme.txt"-filen på CD-ROM-skivan finns viktig information som inte finns i denna bruksanvisning.



Antes de emplear el proyector, lea con atención este manual de manejo.

Introducción

ESPAÑOL

Hay dos razones importantes por las que debe registrar rápidamente la garantía de su nuevo proyector SHARP, empleando para ello la TARJETA DE REGISTRO entregada con el proyector.

1. GARANTÍA

Ésta es para asegurar que usted reciba inmediatamente todos los beneficios relacionados con la garantía de los componentes, servicio y mano de obra aplicables a su adquisición.

2. ACTA DE SEGURIDAD DE PRODUCTOS DEL CONSUMIDOR

Para asegurar que usted reciba rápidamente cualquier aviso de inspección de seguridad, modificación o retirada del mercado que SHARP tenga que llevar a cabo cumpliendo con el Acta de Seguridad de Productos del Consumidor, bajo de la ley 1972 LEA CON ATENCIÓN LA IMPORTANTE CLÁUSULA DE "GARANTÍA LIMITADA".

EE.UU. solamente

ADVERTENCIA: Fuente de iluminación intensa. No mire fija ni directamente al haz de luz. Tenga especial cuidado de que los niños no miren fijamente hacia el haz de luz.



ADVERTENCIA: Para reducir el riesgo de que se produzca una descarga eléctrica, no exponga este producto a la lluvia ni a la humedad.

Vea la parte inferior del proyector.

	PRECAUCIÓN RIESGO DE DESCARGA ELÉCTRICA. NO RETIRE LOS TORNILLOS, EXCEPTO AQUELLOS ESPECIFICADOS PARA QUE EL USUARIO PUEDA REALIZAR EL MANTENIMIENTO	
PRECAUCIÓN: PARA REDUCIR EL RIESGO DE DESCARGA ELÉCTRICA NO RETIRE LA TAPA. A EXCEPCIÓN DE LA LÁMPARA, NO HAY COMPONENTES QUE PUEDA REPARAR EL USUARIO. SOLICITE LAS REPARACIONES A PERSONAL DE SERVICIO CUALIFICADO.		



El signo del rayo con punta de flecha en el interior de un triángulo equilátero, tiene la finalidad de avisar al usuario de la presencia de una tensión peligrosa sin aislar dentro de la caja del producto que puede ser de suficiente magnitud como para constituir un riesgo de descarga eléctrica para las personas.



El signo de exclamación en el interior de un triángulo tiene la finalidad de avisar al usuario de la presencia de importantes instrucciones de operación y mantenimiento (servicio) en los documentos que acompañan al producto.

ADVERTENCIA: Las normas de la FCC estipulan que cualquier cambio o modificación realizado en este equipo sin la aprobación expresa del fabricante podrá anular la autoridad que el usuario tiene para utilizar este equipo.

EE.UU. solamente

INFORMACIÓN

Este equipo ha sido probado y ha demostrado cumplir con las limitaciones para dispositivos digitales de la Clase A, de conformidad con el apartado 15 de las Normas de la FCC. Estas limitaciones han sido designadas para proporcionar una protección razonable contra interferencias perjudiciales cuando el equipo se opera en una instalación comercial. Este equipo genera, utiliza y puede radiar energía de radiofrecuencia, y, si no se instala y utiliza según las instrucciones del manual de manejo, puede causar interferencias perjudiciales en las comunicaciones de radio. Es probable que el funcionamiento de este equipo en un área residencial cause interferencias perjudiciales, en tal caso se requerirá de la intervención del usuario para corregir la interferencia por su cuenta.

EE.UU. solamente

El cable de ordenador suministrado deberá ser utilizado con el dispositivo. Este cable se suministra para asegurar que el dispositivo cumpla con las indicaciones de la Clase A de la FCC.

EE.UU. solamente

ADVERTENCIA:

Éste es un producto Clase A. En un entorno doméstico, este producto puede causar interferencias, en cuyo caso, el usuario deberá tomar las medidas adecuadas.





IMPORTANTES MEDIDAS DE SEGURIDAD

PRECAUCIÓN: Lea completamente estas instrucciones antes de usar el producto y consérvelas para poder consultarlas en el futuro.

La energía eléctrica puede tener muchas aplicaciones útiles. Este producto ha sido diseñado y fabricado para garantizar la seguridad del usuario. SIN EMBARGO, EL USO INCORRECTO DEL PRODUCTO PUEDE OCASIONAR DESCARGAS ELÉCTRICAS E INCENDIOS. A fin de no anular los dispositivos de seguridad incorporados en este producto, observe las siguientes reglas básicas para la instalación, uso y mantenimiento del producto.

1. Lectura de instrucciones

Antes de utilizar el producto deberán leerse todas las instrucciones de seguridad y funcionamiento.

2. Conservación de las instrucciones

Las instrucciones de seguridad y funcionamiento deberán conservarse para poder utilizarlas como referencia en el futuro.

3. Cumplimiento de advertencias

Deberán cumplirse todas las advertencias que aparecen en el producto y en el manual de instrucciones.

4. Seguimiento de las instrucciones

Deberán seguirse todas las instrucciones de funcionamiento y utilización.

5. Limpieza

Desenchufe este producto de la toma de corriente antes de limpiarlo. No emplee limpiadores líquidos ni aerosoles. Para la limpieza, utilice un paño húmedo.

6. Aditamentos

No utilice aditamentos que no hayan sido recomendados por el fabricante del producto porque podrán causar peligros.

7. Agua y humedad

No utilice este producto cerca del agua como, por ejemplo, próximo a una bañera, lavabo, fregadero o lavadora; ni en un sótano húmedo, al lado de una piscina o lugares similares.

8. Accesorios

No coloque este producto encima de un carrito, soporte, trípode, ménsula o mesa inestable porque podría caerse y estropearse seriamente o causar lesiones graves a un niño o a un adulto. Utilícelo solamente con un carrito, soporte, trípode, ménsula o mesa que sea recomendado por el fabricante o que se venda con el producto. Al montar el producto deberán seguirse siempre las instrucciones del fabricante, y deberán utilizarse los accesorios de montaje recomendados por él.

9. Transporte

La combinación del producto y el carrito deberá moverse con cuidado. Las paradas repentinas, la fuerza excesiva y las superficies desniveladas podrían hacer que la combinación del producto y el carrito volcase.



10. Ventilación

Las ranuras y aberturas de la caja tienen la finalidad de que el aparato pueda ventilarse; para asegurar así su buen funcionamiento y protegerlo contra el recalentamiento. Las aberturas no deberán cubrirse ni bloquearse nunca colocando el producto en una cama, sofá, alfombra u otra superficie similar. Este producto no deberá colocarse en una instalación empotrada como, por ejemplo, una librería o estantería para libros, a menos que se disponga de la ventilación apropiada o se hayan seguido las instrucciones del fabricante.

11. Fuentes de alimentación

Este producto sólo deberá funcionar con el tipo de alimentación indicado en la etiqueta de características. Si no está seguro del tipo de alimentación empleado en su hogar, consulte al distribuidor del producto o a la compañía eléctrica local. Para los productos diseñados para funcionar con la alimentación de pilas o baterías, u otras fuentes, consulte las instrucciones de uso respectivas.

12. Conexión a tierra o polarización

Este producto está equipado con uno de los tipos siguientes de enchufe. Si su enchufe no se adapta a la toma de corriente, por favor contacte a un electricista para dar solución al problema. No anule la característica de seguridad del enchufe.

- Enchufe (principales) de tipo bifilar
- Enchufe (principales) de tipo trifilar con un terminal a tierra.

Este enchufe solo se ajustará dentro de una toma de corriente a tierra.

13. Protección de los cables de alimentación

Los cables de alimentación deberán colocarse de forma que no sean pisados por personas ni aplastados por los objetos que se pongan sobre o contra ellos, y deberá tenerse mucho cuidado en los puntos donde las clavijas se unen a los cables, en las tomas de alimentación y en los puntos por donde salen del producto.

14. Tormentas eléctricas

Para mayor protección de este producto durante tormentas eléctricas o cuando se deje sin atender durante un periodo de tiempo prolongado, desenchufe el cable de alimentación de la toma de corriente y desconéctelo del proyector. Esto impedirá que se estropee el producto debido a las tormentas eléctricas y a la sobretensión de la línea.

15. Sobrecarga

No sobrecargue las tomas de corriente, cables de extensión o receptáculos de alimentación integrales porque esto puede causar un riesgo de incendio o descarga eléctrica.

16. Entrada de objetos sólidos y líquidos

No introduzca nunca objetos de ninguna clase en este producto a través de las aberturas porque podrán tocar puntos peligrosos de alta tensión o crear cortocircuitos, lo que a su vez podría producir un incendio o una descarga eléctrica. No derrame nunca ningún tipo de líquido sobre el producto.

17. Reparaciones

No intente reparar este producto usted mismo ya que al abrir o retirar las cubiertas podrá exponerse a una tensión peligrosa o a otros peligros. Solicite cualquier reparación a personal de servicio cualificado.

18. Daños que requieren reparaciones

Desenchufe este producto de la toma de corriente y solicite el servicio de reparaciones a personal cualificado cuando se produzcan las condiciones siguientes:

- Si el cable o el enchufe de alimentación está estropeado.
- Si se han derramado líquidos o han caído objetos en el interior del producto.
- Si el producto ha estado expuesto a la lluvia o al agua.
- Si el producto no funciona normalmente a pesar de haberse seguido las instrucciones de uso. Ajuste solamente los controles indicados en este manual de instrucciones, ya que un ajuste mal hecho en otros controles podría causar daños y tal vez requiera el trabajo laborioso de un técnico cualificado para que el producto vuelva a funcionar normalmente.
- Si el producto se ha caído o estropeado de cualquier otra forma.
- Si el producto muestra un cambio patente en su funcionamiento, esto indicará la necesidad de tener que repararlo.

19. Reemplazo de componentes

Cuando sea necesario reemplazar componentes, asegúrese de que el técnico de servicio utilice los componentes de reemplazo especificados por el fabricante o que posean las mismas características que los originales. Las sustituciones no autorizadas pueden ocasionar incendios, descargas eléctricas u otros peligros.

20. Comprobación de seguridad

Al terminar cualquier trabajo de mantenimiento o reparación en este producto, solicite al técnico de servicio que realice comprobaciones de seguridad para determinar si el producto se encuentra en buenas condiciones de funcionamiento.

21. Instalación en la pared o en el techo

Este producto debe montarse en una pared o techo sólo de la forma indicada por el fabricante.

22. Calor

Este producto deberá instalarse lejos de fuentes de calor tales como radiadores, salidas de aire caliente, estufas y otros productos (incluidos amplificadores) que produzcan calor.



Al instalar el proyector, asegúrese de leer y observar las siguientes medidas de seguridad.

Advertencia acerca de la lámpara

- Si la lámpara se rompe las partículas de cristal pueden ser un peligro. Si la lámpara se rompe, solicite el reemplazo de la misma en el centro de servicio o distribuidor Sharp autorizado más cercano.

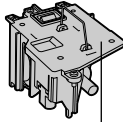

Precauciones a tener en cuenta para la instalación del proyector

- Para minimizar la necesidad de mantenimiento y mantener una alta calidad de imagen, SHARP recomienda instalar este proyector en un lugar que esté libre de humedad, polvo y humo de cigarrillo. Si se instala el proyector en un ambiente expuesto a estas condiciones, será necesario limpiar el objetivo con mayor frecuencia de lo normal. Siempre que el proyector sea limpiado periódicamente, el uso del mismo en estos ambientes no reducirá su vida útil. La limpieza interna sólo debe ser realizada por un centro de servicio o distribuidor Sharp autorizado.

No instale el proyector en lugares expuestos a la luz directa del sol o a luz intensa.

- Sitúe la pantalla de modo que no quede expuesta a la luz directa del sol o a la iluminación de la habitación. La luz que incide directamente en la pantalla atenúa los colores, lo cual dificulta la visualización de la imagen. Si instala la pantalla en una habitación soleada o luminosa, cierre las cortinas y baje la intensidad de las luces.

El proyector puede inclinarse hasta un máximo de 12 grados.

- El proyector debe instalarse dentro de un ángulo ± 12 grados respecto del plano horizontal.

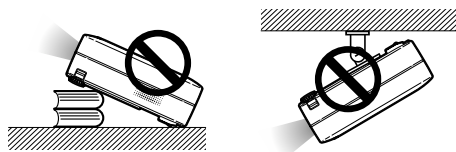

No someta el proyector a impactos fuertes y/o vibración.

- Tenga cuidado de no golpear o dañar la superficie del objetivo.

Descanse la vista ocasionalmente.

- Si mira continuamente la pantalla durante horas, se le cansará la vista.

Evite los lugares con temperaturas demasiado altas o bajas.

- La temperatura de funcionamiento del proyector es de 41°F a 95°F (+5°C a +35°C).
- La temperatura de almacenamiento del proyector es de -4°F a 140°F (-20°C a +60°C).

No bloquee las aberturas de entrada y salida de aire.

- Deje un espacio de al menos 7 7/8" (20 cm) entre la abertura de ventilación y la pared u objeto más cercano.
- Asegúrese de que las aberturas de entrada y de ventilación de aire no estén obstruidas.
- Si se obstruye el ventilador de enfriamiento, un circuito de protección apaga automáticamente el proyector. Esto no indica mal funcionamiento. Retire el cable de alimentación del proyector desde el tomacorriente y espere por lo menos 10 minutos. Instale el proyector en un lugar donde las aberturas de entrada y de ventilación de aire no queden bloqueadas, enchufe el cable de alimentación y encienda el proyector. Esto restablecerá la condición normal de funcionamiento del proyector.

Precauciones al transportar el proyector

- Al transportar el proyector, asegúrese de no someterlo a impactos fuertes y/o vibración, ya que éstos pueden dañarlo. Tenga especial cuidado con el objetivo. Antes de trasladar el proyector, asegúrese de desenchufar el cable de alimentación de la toma de corriente mural, y desconecte todos los demás cables conectados al proyector.

Conexión de otros equipos

- Al conectar un ordenador u otro equipo audiovisual al proyector, haga las conexiones DESPUÉS de apagar el proyector y el equipo que va a conectar.
- Para instrucciones sobre cómo hacer las conexiones, lea los manuales de manejo del proyector y del equipo que va a conectar.

Uso del proyector en otros países

- La tensión de alimentación y la forma del enchufe pueden variar dependiendo de la región o país en que vaya a usar el proyector. Al usar el proyector en el extranjero, asegúrese de utilizar el cable de alimentación apropiado para el país en que se encuentre.

Función de monitor de temperatura

- Si el proyector comienza a recalentarse debido a problemas de configuración u obstrucción de las aberturas de ventilación, "TEMPERATURA" se iluminará en la esquina inferior izquierda de la imagen. Si la temperatura sigue aumentando, la lámpara se apagará, el indicador de advertencia de temperatura parpadeará en el proyector y la alimentación eléctrica se desconectará tras un período de enfriamiento de 90 segundos.



Información

- El ventilador de enfriamiento regula la temperatura interna del proyector, y su funcionamiento se controla de forma automática. El sonido del ventilador puede variar durante el funcionamiento del proyector debido a cambios en la velocidad del ventilador. Esto no indica mal funcionamiento.
- No desenchufe el cable de alimentación durante la proyección de imágenes o mientras el ventilador de enfriamiento está en funcionamiento. Esto podría causar daños debido al aumento de la temperatura interna, ya que en este caso el ventilador de enfriamiento dejará de funcionar.

Cómo acceder a los manuales de manejo en formato PDF

El CD-ROM incluye los manuales de manejo en varios idiomas en formato PDF, para que pueda utilizar el proyector aunque no tenga el presente manual. Para poder usar estos manuales debe tener instalado Adobe Acrobat Reader en su PC (Windows o Macintosh). Si todavía no tiene instalado el programa Acrobat Reader, puede hacerlo desde el CD-ROM.

Para instalar Acrobat Reader desde el CD-ROM

Para Windows:

- ① Inserte el CD-ROM en la unidad de CD-ROM.
- ② Haga doble clic en el icono "Mi PC".
- ③ Haga doble clic en el icono de la unidad "CD-ROM".
- ④ Haga doble clic en la carpeta "ACROBAT".
- ⑤ Haga doble clic en el idioma (nombre de la carpeta) que desea ver.
- ⑥ Haga doble clic en el programa de instalación y siga las instrucciones en pantalla.

Para Macintosh:

- ① Inserte el CD-ROM en la unidad CD-ROM.
- ② Haga doble clic en el icono "CD-ROM".
- ③ Haga doble clic en la carpeta "ACROBAT".
- ④ Haga doble clic en el idioma (nombre de la carpeta) que desea ver.
- ⑤ Haga doble clic en el programa de instalación y siga las instrucciones en pantalla.

Para otros sistemas operativos:

Descargue Acrobat Reader desde Internet (<http://www.adobe.com>).

Para otros idiomas:

Si desea usar Acrobat Reader para un idioma distinto de aquellos incluidos en el CD-ROM, descargue la versión apropiada desde Internet.

Cómo acceder a los manuales de uso en formato PDF

For Windows:

- ① Inserte el CD-ROM en la unidad de CD-ROM.
- ② Haga doble clic en el icono "Mi PC".
- ③ Haga doble clic en el icono de la unidad "CD-ROM".
- ④ Haga doble clic en la carpeta "MANUALS".
- ⑤ Haga doble clic en el idioma (nombre de la carpeta) que desea ver.
- ⑥ Haga doble clic en el archivo "A10" en formato PDF para acceder a los manuales del proyector.

For Macintosh:

- ① Inserte el CD-ROM en la unidad CD-ROM.
- ② Haga doble clic en el icono "CD-ROM".
- ③ Haga doble clic en la carpeta "MANUALS".
- ④ Haga doble clic en el idioma (nombre de la carpeta) que desea ver.
- ⑤ Haga doble clic en el archivo "A10" en formato PDF para acceder a los manuales del proyector.



Nota

- Si no puede abrir el fichero PDF deseado haciendo doble clic con el ratón, inicie primero Acrobat Reader y luego especifique el fichero deseado seleccionando el comando "Abrir" en el menú "Archivo".
- Véase el archivo "readme.txt" en el CD-ROM para leer información importante no incluida en este manual de manejo.



Prima di utilizzare il proiettore, leggere con attenzione il presente manuale di istruzioni.

Introduzione

ITALIANO

Vi sono due ragioni di rilievo per registrare rapidamente la garanzia del nuovo proiettore SHARP appena acquistato servendosi della CARTOLINA DI REGISTRAZIONE contenuta nella sua confezione.

1. GARANZIA

La prima consiste nell'assicurarsi la possibilità di ricevere immediatamente tutti i vantaggi della garanzia su componenti, assistenza e manodopera applicabili all'acquisto effettuato.

2. LEGGE SULLA SICUREZZA DEI PRODOTTI PER I CONSUMATORI

La seconda consiste nell'assicurarsi la possibilità di ricevere immediatamente qualunque notifica di sicurezza relativa a controlli, modifiche o ritiri che SHARP sia eventualmente tenuta a fornire ai sensi della legge 1972 sulla sicurezza dei prodotti per i consumatori. LEGGERE ATTENTAMENTE L'IMPORTANTE CLAUSOLA RELATIVA AI "LIMITI DI GARANZIA".

SOLTANTO NEGLI USA

ATTENZIONE:



Sorgente di luce ad elevata brillantezza. Non fissare lo sguardo sul fascio di luce e non guardarlo direttamente. Prestare particolare attenzione per evitare che i bambini guardino direttamente nella direzione del fascio luminoso.

ATTENZIONE:

Per ridurre il rischio di incendi o di scosse elettriche, non esporre questo prodotto alla pioggia o all'umidità.

Vedere sotto al proiettore.



Il simbolo con il fulmine con la punta a freccia all'interno di un triangolo equilatero serve per avvertire l'utente della presenza di "tensione pericolosa" non isolata, all'interno dell'involucro del prodotto; essa risulterà essere di entità sufficiente a dare luogo a rischi di scosse elettriche per le persone.



Il simbolo con il punto esclamativo all'interno di un triangolo equilatero serve per avvertire l'utente della presenza di istruzioni di rilievo per il funzionamento e la manutenzione (l'assistenza tecnica) nella documentazione fornita unitamente al prodotto.

ATTENZIONE:

In base alle normative FCC, tutte le variazioni o le modifiche non autorizzate apportate alla presente attrezzatura senza l'approvazione esplicita del fabbricante possono annullare la facoltà dell'utente di utilizzare tale attrezzatura.

SOLTANTO NEGLI USA

NOTA INFORMATIVA

Questo componente è stato sottoposto a vari test che hanno provato la sua conformità con i limiti per i dispositivi digitali della Classe A, giusto la Parte 15 delle norme FCC. Questi limiti sono stati stabiliti per fornire una protezione ragionevole contro interferenze dannose quando il componente viene usato in un ambiente commerciale. Questo componente genera, utilizza e può irradiare l'energia di frequenze radio e, se non viene installato ed usato in conformità con il manuale delle istruzioni, può causare interferenze dannose alle comunicazioni radio. L'uso di questo componente in un'area residenziale può causare interferenze dannose e in tal caso, l'utente dovrà correggere queste interferenze a sue spese.

SOLTANTO NEGLI USA

Utilizzare il cavo per computer in dotazione con il dispositivo. Il cavo viene fornito per garantire la conformità del dispositivo con le norme di verifica della Classe A FCC.

SOLTANTO NEGLI USA

ATTENZIONE:

Questo è un prodotto Classe A. In un ambiente domestico questo prodotto può causare interferenze radio, nel qual caso l'utilizzatore può essere tenuto a prendere provvedimenti adeguati.





NORME DI SICUREZZA IMPORTANTI

ATTENZIONE: Leggete queste istruzioni prima di usare il prodotto e poi conservate le istruzioni per ogni riferimento futuro.

L'energia elettrica può effettuare molte funzioni utili. Questo prodotto è stato prodotto per assicurare la vostra sicurezza personale. MA L'USO ERRATO PUO' CAUSARE POTENZIALI SCOSSE ELETTRICHE O RISCHI DI INCENDI. Per non disabilitare le protezioni incorporate in questo prodotto, osservate le seguenti regole principali per l'installazione, l'uso e il lavoro di servizio.

1. Leggere le di istruzioni

Prima di utilizzare il prodotto, occorre leggere tutte le istruzioni di sicurezza e di funzionamento.

2. Conservare le istruzioni

Occorre conservare le istruzioni di sicurezza e di funzionamento per potervi fare riferimento in futuro.

3. Rispettare le avvertenze

Occorre seguire scrupolosamente tutte le avvertenze presenti sul prodotto e nelle istruzioni per il funzionamento.

4. Seguire le istruzioni

Occorre seguire tutte le istruzioni per l'uso e per il funzionamento.

5. Pulizia

Prima di effettuare la pulizia, scollegare il prodotto dalla presa di corrente. Per la pulizia, non usare detergenti liquidi o aerosol. Usare un panno umido.

6. Accessori

Non utilizzare accessori non consigliati dal fabbricante del prodotto poiché essi possono causare pericoli.

7. Acqua e umidità

Non utilizzare il prodotto in prossimità di acqua, ad esempio presso una vasca da bagno, un lavabo, un lavandino o un lavatoio, in cantine umide, presso una piscina e così via.

8. Collocazione

Non collocare il prodotto su carrelli, supporti, cavalletti, staffe o tavoli instabili. Il prodotto potrebbe cadere causando gravi lesioni a bambini o adulti e danneggiandosi gravemente. Utilizzare esclusivamente carrelli, supporti, cavalletti, staffe o tavoli consigliati dal fabbricante o venduti unitamente al prodotto. Il prodotto deve sempre essere installato seguendo le istruzioni del fabbricante e utilizzando accessori di montaggio consigliati da quest'ultimo.

9. Trasporto

La combinazione di prodotto e carrello deve essere spostata con attenzione. Le fermate brusche, l'applicazione di una forza eccessiva e gli spostamenti su superfici accidentate possono provocare il ribaltamento del prodotto e del carrello.



10. Ventilazione

L'involucro è dotato di fessure e aperture di ventilazione volte a garantire un funzionamento affidabile del prodotto e a proteggerlo dal surriscaldamento. Non coprire o ostruire le aperture collocando il prodotto su letti, divani, tappeti o altre superfici simili. Il prodotto non deve essere collocato in strutture incassate come librerie o rastrelliere, a meno che non venga fornita una ventilazione adeguata o che siano comunque rispettate rigorosamente le istruzioni del fabbricante.

11. Sorgenti di alimentazione

Questo prodotto deve essere alimentato esclusivamente da sorgenti di alimentazione del tipo indicato sull'etichetta di identificazione. Se non si è sicuri del tipo di alimentazione disponibile, rivolgersi al rivenditore del prodotto o all'azienda elettrica locale. Per i prodotti progettati per funzionare a batterie o con alimentazione di altro genere, fare riferimento alle istruzioni per il funzionamento.

12. Messa a terra o polarità

Questo prodotto è stato dotato di uno dei seguenti tipi di spine. Se la spina non dovesse entrare nella presa murale, rivolgetevi ad un elettricista. Non modificate la spina togliendo la spina di messa a terra.

- Spina a due cavi (principale).
- Spina a tre cavi (principale) con un terminale di messa a terra. Questa spina entra solo nelle prese murali con messa a terra.

13. Protezione del cavo di alimentazione

Il percorso dei cavi di alimentazione deve essere scelto in modo che sia improbabile calpestarli o schiacciarli collocando oggetti sopra o contro di essi; occorre prestare particolare attenzione ai cavi in corrispondenza delle spine, delle prese multiple e dei punti di uscita dal prodotto.

14. Fulmini

Per una maggiore protezione del prodotto durante i temporali, o nei periodi in cui esso non è sotto sorveglianza o rimane inutilizzato a lungo, scollegarlo dalla presa di rete e staccare il cavo di alimentazione. Ciò previene eventuali danni al prodotto dovuti a fulmini e a sbalzi della tensione di alimentazione.

15. Sovraccarico

Non sovraccaricare le prese di corrente, le prolunghe o le prese multiple integrate, poiché ciò può causare rischi di incendi o scosse elettriche.

16. Penetrazione di oggetti e liquidi

Non spingere oggetti di alcun tipo all'interno del prodotto attraverso le aperture, poiché essi possono venire a contatto con punti in cui è presente una tensione pericolosa o mettere in corto circuito componenti che possono dare luogo a incendi o scosse elettriche. Non versare sul prodotto liquidi di alcun genere.

17. Assistenza tecnica

Non tentare di effettuare personalmente interventi di assistenza tecnica sul prodotto, poiché l'apertura o la rimozione dei coperchi può comportare l'esposizione a tensioni pericolose o ad altri pericoli. Rivolgersi esclusivamente a personale qualificato.

18. Problemi che richiedono assistenza tecnica

Qualora si verificano le seguenti condizioni, scollegare il prodotto dalla presa di corrente e rivolgersi a personale qualificato per l'assistenza tecnica:

- se il cavo o la spina di alimentazione sono danneggiati.
- se nel prodotto sono penetrati liquidi o corpi estranei.
- se il prodotto è stato esposto alla pioggia o all'acqua.
- se il prodotto non funziona in modo normale quando si seguono le istruzioni per il funzionamento. Regolate esclusivamente i comandi descritti nelle istruzioni per il funzionamento, poiché una regolazione errata di altri comandi può provocare danni e comporta spesso lunghi interventi dei tecnici qualificati per ripristinare il funzionamento normale del prodotto.
- se il prodotto è caduto o è stato danneggiato in qualunque modo.
- se il prodotto presenta chiare variazioni delle prestazioni.

19. Ricambi

Accertarsi che i tecnici che effettuano gli interventi di assistenza tecnica utilizzino i ricambi specificati dal fabbricante o ricambi con caratteristiche identiche a quelle dei componenti originali. L'uso di pezzi di ricambio impropri può causare incendi, scosse elettriche o altri pericoli.

20. Controlli per la sicurezza

Al termine di qualsiasi intervento di assistenza tecnica o di riparazione di questo prodotto, richiedere al tecnico addetto all'assistenza di effettuare i controlli per la sicurezza per verificare che il prodotto sia in condizioni di funzionamento adeguate.

21. Montaggio a parete o a soffitto

Questo prodotto va montato a parete o a soffitto nel modo raccomandato dal fabbricante.

22. Calore

Questo prodotto deve essere collocato lontano da sorgenti di calore come radiatori, riscaldatori, fornelli o altri prodotti (compresi gli amplificatori) che dissipano calore.



Assicuratevi di leggere le seguenti norme di sicurezza prima di impostare il proiettore.

Precauzioni riguardanti l'unità lampada

- Se si rompe la lampada si possono verificare dei danni causati dai frammenti di vetro. In caso si dovesse rompere la lampada, rivolgetevi al più vicino rivenditore autorizzato dalla Sharp o al centro di servizio per una sostituzione.

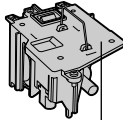

Precauzioni riguardanti l'impostazione del proiettore

- Per un minimo di lavori di servizio e per mantenere un'alta qualità dell'immagine, la SHARP raccomanda di installare questo proiettore in un'area priva di umidità, polvere e fumo di sigarette. Quando il proiettore viene esposto a tali ambienti, bisogna pulire l'obiettivo più spesso. Se il proiettore viene pulito regolarmente, l'uso dello stesso in tali ambienti non riduce la durata operativa generale dell'unità. La pulizia interna va eseguita solo da un rivenditore autorizzato dalla Sharp o presso un centro di servizio.

Non installate il proiettore in luoghi dove potrebbe essere esposto alla luce diretta del sole o ad una forte illuminazione.

- Posizionate lo schermo in modo tale che non sia esposto alla luce diretta del sole o esposto a fonti di illuminazione. Se la luce dovesse colpire lo schermo direttamente, i colori saranno sbiaditi e sarà difficile vedere le immagini correttamente. Chiudete le tende e diminuite le luci se dovete installare lo schermo in una stanza assoluta o illuminata.

Il proiettore può essere inclinato in modo sicuro ad un angolo massimo di 12 gradi.

- Il posizionamento deve avvenire entro ± 12 gradi rispetto alla posizione orizzontale.

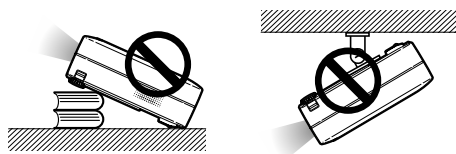

Non esponete il proiettore ad urti violenti e/o vibrazioni.

- Fate attenzione all'obiettivo per non colpire o danneggiare la superficie dell'obiettivo.

Riposatevi gli occhi ogni tanto.

- Se fissate lo schermo per delle ore vi stancherete gli occhi. Assicuratevi di riposare gli occhi ogni tanto.

Evitare luoghi con temperature estreme.

- La temperatura operativa del proiettore va da 41°F a 95°F (da +5°C a +35°C).
- La temperatura di immagazzinaggio del proiettore va da -4°F a 140°F (da -20°C a +60°C).

Non bloccate le valvole di aspirazione e scarico.

- Lasciate uno spazio di almeno 7 7/8 pollici (20 cm) tra la valvola di scarico e la parete o un'altra superficie.
- Assicuratevi che non siano bloccate la valvola di aspirazione e la valvola di scarico.
- Se il ventilatore di raffreddamento è bloccato, scatta un circuito di protezione che spegne il proiettore automaticamente. Questo non è segno di malfunzionamento. Rimuovete il cavo di alimentazione del proiettore dalla presa murale ed attendere almeno 10 minuti. Posizionate il proiettore in una posizione dove le valvole di aspirazione e scarico non sono bloccate, ricollegate il cavo di alimentazione ed accendete il proiettore. Il proiettore ritorna alla condizione operativa normale.

Precauzioni riguardante il trasporto del proiettore

- Quando trasportate il proiettore, assicuratevi di non esporre lo stesso ad urti violenti e/o vibrazioni, altrimenti si possono verificare dei danni. Fate particolare attenzione all'obiettivo. Prima di spostare il proiettore, assicuratevi di scollegare il cavo di alimentazione dalla presa murale e scollegate eventuali cavi connessi alla stessa.

Altri componenti collegati

- Quando collegate un computer o un altro componente Audio/Video al proiettore, fate i collegamenti DOPO aver spento il proiettore e il componente da collegare.
- Leggete il manuale di istruzioni del proiettore e del componente da collegare per ulteriori informazioni su come effettuare i collegamenti.

Utilizzo del proiettore in altre nazioni

- Il voltaggio di alimentazione e la forma della spina possono variare secondo la regione e la nazione in cui usate il proiettore. Quando usate il proiettore oltremare, assicuratevi di usare il cavo di alimentazione appropriato per la nazione in cui vi trovate.

Funzione monitoraggio temperatura

- Se inizia il surriscaldamento del proiettore per via dei problemi di impostazione o per il bloccaggio delle valvole dell'aria, "TEMPERATURA" si illuminano nell'angolo inferiore sinistro dell'immagine. Se continua ad aumentare la temperatura, la lampada si spegne, l'indicatore avvertimento temperatura lampeggia sul proiettore e dopo un periodo di raffreddamento di 90 secondi, si spegne la corrente.



Informazioni

- Il ventilatore di raffreddamento regola la temperatura interna e le prestazioni sono controllate automaticamente. Il suono del ventilatore può cambiare durante il funzionamento del proiettore per via dei cambiamenti della velocità del ventilatore. Questo non è segno di malfunzionamento.
- Non scollegate il cavo di alimentazione durante la proiezione o il raffreddamento. Altrimenti si possono verificare dei danni dovuti all'aumento della temperatura interna ed inoltre si ferma il ventilatore di raffreddamento.



Per accedere ai manuali di istruzioni nel formato PDF

Nel CD-ROM sono disponibili i manuali d'uso in formato PDF in più lingue, in modo da poter utilizzare il proiettore anche senza questo manuale. Per usare questi manuali, bisogna installare Adobe Acrobat Reader nel PC (Windows o Macintosh). Se non è stato ancora installato Acrobat Reader, è possibile installarlo dal CD-ROM.

Per installare Acrobat Reader dal CD-ROM

Per Windows:

- ① Inserite il CD-ROM nel drive CD-ROM.
- ② Cliccate due volte sull'icona "Risorse del computer".
- ③ Cliccate due volte sul drive "CD-ROM".
- ④ Cliccate due volte sulla cartella "ACROBAT".
- ⑤ Cliccate due volte sulla lingua (nome della cartella) da visualizzare.
- ⑥ Cliccate due volte sul programma d'installazione e seguire le istruzioni a video.

Per Macintosh:

- ① Inserite il CD-ROM nel drive CD-ROM.
- ② Cliccate due volte sull'icona "CD-ROM".
- ③ Cliccate due volte sulla cartella "ACROBAT".
- ④ Cliccate due volte sulla lingua (nome della cartella) da visualizzare.
- ⑤ Cliccate due volte sul programma d'installazione e seguire le istruzioni a video.

Per gli altri sistemi operativi:

Scaricate Acrobat Reader da Internet (<http://www.adobe.com>).

Per le altre lingue:

Se preferite usare Acrobat Reader per lingue diverse da quelle incluse nel CD-ROM, scaricate la versione appropriata da Internet.

Accesso ai manuali PDF

Per Windows:

- ① Inserite il CD-ROM nel drive CD-ROM.
- ② Cliccate due volte sull'icona "Risorse del computer".
- ③ Cliccate due volte sul drive "CD-ROM".
- ④ Cliccate due volte sulla cartella "MANUALS".
- ⑤ Cliccate due volte sulla lingua (nome della cartella) da visualizzare.
- ⑥ Cliccate due volte sul file pdf "A10" per accedere ai manuali del proiettore.

For Macintosh:

- ① Inserite il CD-ROM nel drive CD-ROM.
- ② Cliccate due volte sull'icona "CD-ROM".
- ③ Cliccate due volte sulla cartella "MANUALS".
- ④ Cliccate due volte sulla lingua (nome della cartella) da visualizzare.
- ⑤ Cliccate due volte sul file pdf "A10" per accedere ai manuali del proiettore.



Nota

- Se il file PDF desiderato non si apre quando cliccate due volte con il mouse, avviate Acrobat Reader, poi specificate il file desiderato usando il menù "File", "Apri".
- Consultare il file "readme.txt" disponibile sul CD-ROM per informazioni importanti non incluse in questo manuale di istruzioni.



Lees deze gebruiksaanwijzing zorgvuldig door voordat u de projector in gebruik neemt.

Inleiding

NEDERLANDS

Er zijn twee belangrijke redenen om de garantie van uw nieuwe SHARP-projector onmiddellijk in orde te brengen met de REGISTRATIEKAART die verpakt zit bij de projector.

1. GARANTIE

U komt meteen in aanmerking voor de volledige garantie op onderdelen, service en reparatiewerkzaamheden die van toepassing is op dit product.

2. CONSUMENT-VEILIGHEIDSWETGEVING

U wordt onmiddellijk op de hoogte gesteld van eventuele veiligheidsbepalingen betreffende inspecties, modificaties of het terugroepen van producten die door SHARP moeten worden uitgevoerd op basis van de 1972 Consumer Product Safety Act. LEES ZORGVULDIG DE BELANGRIJKE "BEPERKTE GARANTIE" CLAUSULE.

ALLEEN VOOR DE VERENIGDE STATEN

WAARSCHUWING: Zeer sterke lichtbron. Kijk niet rechtstreeks in de lichtbundel. Let er vooral op dat kinderen niet rechtstreeks in de lichtbundel kijken.



WAARSCHUWING: Stel het apparaat niet bloot aan regen of vocht om brand of een gevaarlijke elektrische schok te voorkomen.

Zie onderkant van projector.

	LET OP GEVAARLIJKE SPANNINGEN. GEENSCHROEVEN VERWIJDEREN, BEHALVE DE VOORGESCHREVEN GEBRUIKER-ONDERHOUDSSCHROEVEN.	
LET OP: OM DE KANS OP EEN ELEKTRISCHE SCHOK TE VERMINDEREN, MAG DE BEHUIZING NIET WORDEN GEOPEND. ER ZIJN GEEN DOOR DE GEBRUIKER REPAREREERBARE ONDERDELEN IN HET APPARAAT, BEHALVE DE LAMPEENHEID. LAAT ONDERHOUD EN REPARATIE OVER AAN BEVOEGD ONDERHOUDSPERSONEEL.		



Een bliksemsymbool in een gelijkzijdige driehoek maakt de gebruiker attent op de aanwezigheid van niet-geïsoleerde "gevaarlijke spanningen" in het inwendige van het apparaat, die zo groot kunnen zijn dat zij een ernstige elektrische schok kunnen veroorzaken.



Een uitroepteken in een gelijkzijdige driehoek maakt de gebruiker attent op belangrijke bedienings- en onderhoudsinformatie in de documentatie die bij het apparaat wordt geleverd.

WAARSCHUWING: De FCC-bepalingen schrijven voor dat wijzigingen of modificaties in de apparatuur die niet uitdrukkelijk door de fabrikant zijn goedgekeurd tot gevolg kunnen hebben dat het gebruik van de apparatuur niet meer toegestaan is.

ALLEEN VOOR DE VERENIGDE STATEN

INFORMATIE

Deze apparatuur is getest en bleek te voldoen aan de eisen en limieten voor Klasse A digitale apparatuur, overeenkomstig Deel 15 van de FCC-bepalingen, die ontworpen zijn om redelijke bescherming te verlenen tegen dergelijke storingen bij gebruik in een commerciële omgeving. In deze apparatuur worden radiogolven opgewekt en verwerkt, en deze golven kunnen uitgestraald worden. Als bij de installatie en/of het gebruik de instructies in de gebruiksaanwijzing niet strikt opgevolgd worden, kan de apparatuur storing in radio-ontvangst veroorzaken. Gebruik van deze apparatuur in een woongebied zal waarschijnlijk storingen veroorzaken. In dat geval dient de gebruiker op zijn/haar eigen kosten alle maatregelen te nemen die nodig kunnen zijn om de storing op te heffen.

ALLEEN VOOR DE VERENIGDE STATEN

Gebruik met deze apparatuur de meegeleverde computerkabel. Deze kabel zorgt ervoor dat de apparatuur voldoet aan de voorschriften van FCC Klasse A.

ALLEEN VOOR DE VERENIGDE STATEN

WAARSCHUWING:

Dit is een Klasse A-product. Het is mogelijk dat dit product in de huiselijke omgeving radiostoringen veroorzaakt waartegen de gebruiker afdoende maatregelen dient te nemen.



BELANGRIJKE VEILIGHEIDSVOORSCHRIFTEN

LET OP: Lees al deze instructies door alvorens dit apparaat in gebruik te nemen en bewaar ze voor later gebruik.

Met elektrische energie kunt u heel wat nuttige functies uitvoeren. Dit apparaat is zodanig ontworpen en vervaardigd dat uw persoonlijke veiligheid wordt gevrijwaard. ONJUIST GEBRUIK KAN EVENWEL LEIDEN TOT EEN EVENTUELE ELEKTRISCHE SCHOK OF BRANDGEVAAR. Om de ingebouwde veiligheidsvoorzieningen van dit apparaat niet teniet te doen, dient u de volgende basisregels goed in acht te nemen bij de installatie, het gebruik en het onderhoud van de projector.

1. Lees de gebruiksaanwijzing

Lees alle veiligheids- en bedieningsinstructies in de gebruiksaanwijzing voordat u het apparaat gebruikt.

2. Bewaar de gebruiksaanwijzing

Bewaar de gebruiksaanwijzing voor het geval u deze in de toekomst nogmaals nodig heeft.

3. Neem alle waarschuwingen in acht

Neem alle waarschuwingen op het product en in de gebruiksaanwijzing in acht.

4. Volg alle instructies op

Alle bedieningsinstructies e.d. moeten nauwgezet worden opgevolgd.

5. Reinigen

Trek de stekker uit het stopcontact voordat u begint met schoonmaken. Gebruik geen vloeibare reinigingsmiddelen of sprays. Reinig het apparaat uitsluitend met een vochtige doek.

6. Hulpstukken

Voorkom problemen en gebruik geen hulpstukken die niet door de fabrikant van het apparaat worden aanbevolen.

7. Water en vocht

Gebruik het apparaat niet in de buurt van water; bijvoorbeeld in de buurt van een bad, wastafel, aanrecht, wasmachine, zwembad of in een vochtige kelder enz.

8. Accessoires

Plaats het apparaat niet op een wankel rek, karretje, statief, steunbeugel of tafel. Het apparaat zou kunnen vallen en een kind of volwassene ernstig kunnen verwonden, en tevens kan het apparaat zelf zwaar worden beschadigd. Gebruik uitsluitend een rek, karretje, statief, steunbeugel of tafel die door de fabrikant wordt aanbevolen of die bij het apparaat wordt verkocht. Volg voor eventuele montagewerkzaamheden altijd de instructies van de fabrikant op en gebruik ook uitsluitend montage-accessoires die door de fabrikant worden aanbevolen.

9. Transport

Als het apparaat op een verplaatsbaar rek is gezet, dient dit voorzichtig te worden verplaatst. Het rek kan namelijk omvallen bij plotseling stoppen, te hard duwen of rijden over een ongelijke ondergrond.



10. Ventilatie

In de behuizing van het apparaat zijn gleuven en openingen die dienen voor de ventilatie. Voor een veilige werking en bescherming tegen oververhitting mogen de ventilatie-openingen nooit worden geblokkeerd of afgedekt door het apparaat op een bed, divan, dijk vloerkleed e.d. te zetten. Het apparaat mag ook niet in een afgesloten ruimte, zoals een boekenkast, worden geplaatst, tenzij voor een goede ventilatie wordt gezorgd of alle instructies van de fabrikant zijn opgevolgd.

11. Voeding

Het apparaat mag uitsluitend op de stroomvoorzieningsbron worden gebruikt die op het typelabel is vermeld. Raadpleeg uw dealer of het plaatselijke elektriciteitsbedrijf indien u niet zeker bent van het type stroomvoorziening in uw huis. Voor apparaten die gebruikt worden op batterijen of op andere stroombronnen wordt verwezen naar de gebruiksaanwijzing die bij het apparaat wordt geleverd.

12. Uitvoering van de netstekker

Dit apparaat is uitgerust met één van de volgende soorten stekkers. Als de stekker niet in het stopcontact past, neemt u contact op met uw elektricien.

Negeer de veiligheidsvoorziening van de stekker niet.

- Tweedraads (net) stekker.
- Driedraads geaarde (net) stekker met aardingspen. Deze stekker past alleen in een geaard stopcontact.

13. Bescherming van het netsnoer

Leg het netsnoer zodanig dat er niet gemakkelijk iemand op gaat staan of dat het snoer door een voorwerp wordt platgedrukt. Let hier vooral goed op in de buurt van de stekkers, bij het stopcontact en op de plaats waar het snoer uit het apparaat komt.

14. Bliksem

Om veiligheidsredenen dient u bij bliksem of wanneer u het apparaat langere tijd niet denkt te gebruiken, de stekker van het netsnoer uit het stopcontact te trekken. Dit om beschadiging van het apparaat te voorkomen als gevolg van blikseminslag of plotselinge stroompieken in de stroomleiding.

15. Overbelasting

Zorg dat de stopcontacten, verlengsnoeren en stekkerdozen niet overbelast worden, want dit kan resulteren in brand of een elektrische schok.

16. Binnendringen van voorwerpen en vloeistoffen

Duw nooit voorwerpen via de openingen in de behuizing van het apparaat naar binnen, omdat deze dan onderdelen die onder hoogspanning staan kunnen raken of kortsluiting kunnen veroorzaken, met brand of een elektrische schok tot gevolg. Let tevens op dat er nooit vloeistof op het apparaat wordt gemorst.

17. Reparaties

Probeer het apparaat nooit zelf te repareren. Bij het openen of verwijderen van de afdekplaten stelt u zich bloot aan een ernstige elektrische schok en andere gevaren. Laat reparatie over aan erkend onderhoudspersoneel.

18. Beschadigingen die reparatie vereisen

Bij de volgende omstandigheden moet u de stekker uit het stopcontact trekken en het apparaat door erkend onderhoudspersoneel laten repareren:

- Als het netsnoer of de netstekker is beschadigd.
- Als er vloeistof of een voorwerp in het apparaat terecht is gekomen.
- Als het apparaat blootgesteld is geweest aan regen of water.
- Als de normale aanwijzingen worden opgevolgd, maar het apparaat niet juist functioneert. Gebruik alleen de bedieningsorganen die in de gebruiksaanwijzing worden aangegeven. Bij een onjuiste instelling van andere bedieningsorganen kan het apparaat mogelijk beschadigd worden, met tot gevolg dat reparatiewerkzaamheden voor een juiste werking van het apparaat door erkend onderhoudspersoneel moeilijker en duurder kunnen worden.
- Als het apparaat is gevallen of de behuizing is beschadigd.
- Als het apparaat duidelijk minder goed functioneert. Dit duidt erop dat het tijd is voor onderhoud.

19. Vervangingsonderdelen

Wanneer onderdelen vervangen moeten worden, zorg er dan voor dat het onderhoudspersoneel uitsluitend onderdelen gebruikt die door de fabrikant worden aanbevolen of die dezelfde eigenschappen hebben als de originele onderdelen. Het gebruik van andere onderdelen kan brand, een elektrische schok of andere problemen veroorzaken.

20. Veiligheidscontrole

Vraag het onderhoudspersoneel om na de onderhouds- of reparatiewerkzaamheden een veiligheidscontrole uit te voeren, zodat u zeker weet dat het apparaat juist en veilig functioneert.

21. Wand- of plafondmontage

Dit apparaat mag uitsluitend volgens de aanbevelingen van de fabrikant aan een wand of het plafond worden bevestigd.

22. Hitte

Houd het apparaat uit de buurt van warmtebronnen zoals verwarmingsradiators, haarden, kachels en andere voorwerpen (inclusief versterkers) die warmte afgeven.



Lees de volgende veiligheidsvoorschriften voordat u uw projector opstelt.

Voorzichtig met de lampeenheid

- Als de lamp gesprongen is, kunnen glassplinters gevaar veroorzaken. Indien de lamp gesprongen is, neemt u contact op met de dichtstbijzijnde erkende Sharp projector dealer of servicecentrum om de lamp te laten vervangen.

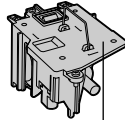

Voorzichtig bij het opstellen van de projector

- Met het oog op een minimaal onderhoud en het behoud van een hoge beeldkwaliteit beveelt SHARP aan deze projector te installeren in een ruimte die vrij is van vocht, stof en sigarettenrook. Wanneer de projector aan vocht, stof of rook wordt blootgesteld, moet de lens vaker dan normaal worden gereinigd. Gebruik van de projector in dit soort ruimten zal de levensduur van de projector niet verkorten mits u de projector regelmatig laat reinigen. Het reinigen van het inwendige gedeelte van de projector mag uitsluitend door een erkende Sharp projector dealer of servicecentrum worden uitgevoerd.

Stel de projector niet op in ruimten die blootstaan aan direct zonlicht of fel licht.

- Plaats het scherm zo dat het zich niet in direct zonlicht of kamerverlichting bevindt. Licht dat direct op het scherm valt, zal de kleuren doen verbleken en het kijken bemoeilijken. Doe de gordijnen dicht en dim de verlichting wanneer u het scherm opstelt in een zonnige of fel verlichte ruimte.

De projector kan veilig worden gekanteld tot een hoek van maximaal 12 graden.

- Plaats de projector binnen een hoek van ± 12 graden ten opzichte van de horizontale stand.

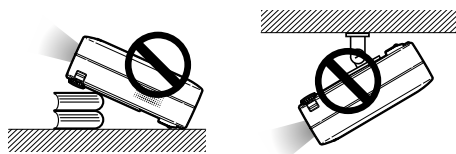

Stel de projector niet bloot aan sterke schokken en/of trillingen.

- Wees voorzichtig met de lens en vermijd dat het oppervlak ervan wordt geraakt of beschadigd.

Gun uw ogen af en toe wat rust.

- Het gedurende langere tijd ononderbroken kijken naar het scherm is zeer.

Vermijd plaatsen met extreme temperaturen.

- De bedrijfstemperatuur voor de projector ligt tussen 41°F en 95°F (+5°C en +35°C)
- De opslagtemperatuur voor de projector ligt tussen -4°F en 140°F (-20°C en +60°C)

Blokkeer de uitlaat- en inlaatopeningen niet.

- Laat tenminste 7 7/8" (20 cm) ruimte tussen de uitlaatopening en de dichtstbijzijnde wand of ander obstakel.
- Controleer of de inlaatopening en de ventilatiegleuven niet geblokkeerd zijn.
- Als de koelventilator geblokkeerd wordt, zal een veiligheidsvoorziening automatisch de projector uitschakelen. Dit duidt niet op een defect. Haal de stekker van het netsnoer van de projector uit het stopcontact en wacht minstens 10 minuten. Plaats de projector zodanig dat de inlaat- en uitlaatopeningen niet zijn geblokkeerd, steek dan de stekker weer in het stopcontact en zet de projector aan. De projector zal vervolgens weer normaal functioneren.

Voorzichtig bij het vervoeren van de projector

- Tijdens het vervoer moet u ervoor zorgen dat de projector niet onderhevig is aan sterke schokken en/of trillingen, aangezien dit beschadiging kan veroorzaken. Wees bijzonder voorzichtig met de lens. Alvorens de projector te verplaatsen, trekt u het netsnoer uit het stopcontact en maakt u alle kabels die op de projector aangesloten zijn los.

Andere aangesloten apparatuur

- Bij het aansluiten van een computer of andere audiovisuele apparatuur op de projector brengt u de aansluitingen tot stand NADAT u de projector en de aan te sluiten apparatuur hebt uitgeschakeld.
- Lees de gebruiksaanwijzingen van de projector en de aan te sluiten apparatuur door en volg de instructies betreffende de aansluitingen.

Gebruik van de projector in andere landen

- De voedingsspanning en de vorm van de stekker kunnen verschillen afhankelijk van de streek of het land waar u de projector gebruikt. Wanneer u de projector in het buitenland gebruikt, dient u het juiste netsnoer te gebruiken voor het land waar u zich bevindt.

Temperatuur-verklikkerfunctie

- Wanneer de projector oververhit raakt vanwege een verkeerde instelling of geblokkeerde ventilatiegleuven, lichten "TEMPERATUUR" en "TEMPERATUUR" links onder in het beeld op. Als de temperatuur blijft stijgen, gaat de lamp uit, begint de temperatuurindicator op de projector te knipperen en wordt de projector na een afkoelperiode van 90 seconden automatisch uitgeschakeld.



Info

- De koelventilator regelt de binnentemperatuur automatisch. Daarom kan het geluid van de ventilator veranderen tijdens het gebruik van het apparaat. Dit duidt niet op een defect.
- Trek de stekker van het netsnoer niet uit het stopcontact tijdens de projectie of de werking van de koelventilator. Dit kan beschadiging veroorzaken door het stijgen van de binnentemperatuur, aangezien de koelventilator eveneens uitgeschakeld wordt.

Bij dit produkt zijn batterijen geleverd. Wanneer deze leeg zijn, moet u ze niet weggooien maar inleveren als KCA.





Toegang krijgen tot de PDF-gebruiksaanwijzingen

De cd-rom bevat handleidingen in PDF-formaat in verscheidene talen zodat u de projector kunt bedienen, zelfs als u deze handleiding niet tot uw beschikking heeft. Om deze handleiding te kunnen gebruiken, moet eerst Adobe Acrobat Reader op uw PC (Windows of Macintosh) geïnstalleerd zijn. Als u Acrobat Reader nog niet heeft, kunt u dit programma installeren vanaf de cd-rom.

Installeren van Acrobat Reader vanaf de CD-ROM

Voor Windows:

- ① Plaats de CD-ROM in het CD-ROM-station.
- ② Dubbelklik op het pictogram "Deze Computer".
- ③ Dubbelklik op het "CD-ROM"-station.
- ④ Dubbelklik op de map "ACROBAT".
- ⑤ Dubbelklik op de taal (naam van de map) die u wilt bekijken.
- ⑥ Dubbelklik op het installatieprogramma en volg de instructies op het scherm.

Voor Macintosh:

- ① Plaats de CD-ROM in het CD-ROM-station.
- ② Dubbelklik op het "CD-ROM"-pictogram.
- ③ Dubbelklik op de map "ACROBAT".
- ④ Dubbelklik op de taal (naam van de map) die u wilt bekijken.
- ⑤ Dubbelklik op het installatieprogramma en volg de instructies op het scherm.

Voor andere besturingssystemen:

Download de juiste versie van Acrobat Reader van het internet (<http://www.adobe.com>).

Voor andere talen:

Als u liever Acrobat Reader wilt hebben in een versie of in een taal die niet op de CD-ROM staat, dan kunt u deze van het internet halen.

Openen van de PDF-gebruiksaanwijzingen

Voor Windows:

- ① Plaats de CD-ROM in het CD-ROM-station.
- ② Dubbelklik op het pictogram "Deze Computer".
- ③ Dubbelklik op het "CD-ROM"-station.
- ④ Dubbelklik op de map "MANUALS".
- ⑤ Dubbelklik op de taal (naam van de map) die u wilt openen.
- ⑥ Dubbelklik op het PDF-bestand "A10" om de handleidingen van de projector te openen.

Voor Macintosh:

- ① Plaats de CD-ROM in het CD-ROM-station.
- ② Dubbelklik op het "CD-ROM"-pictogram.
- ③ Dubbelklik op de map "MANUALS".
- ④ Dubbelklik op de taal (naam van de map) die u wilt openen.
- ⑤ Dubbelklik op het PDF-bestand "A10" om de handleidingen van de projector te openen.

Opmerking

- Als u het gewenste PDF-bestand niet kunt openen door te dubbelklikken met de muis, dient u eerst Acrobat Reader op te starten en daarna het gewenste bestand op te geven via het menu "File", "Open".
- Lees het bestand "readme.txt" op de cd-rom voor belangrijke informatie die niet is opgenomen in deze handleiding.



Antes de utilizar este projetor, leia atentamente este Manual de Operação.

INTRODUÇÃO

PORTUGUÊS

Existem duas boas razões para que você faça, sem demora, o registro de garantia do seu novo Projetor SHARP, usando o CARTÃO DE REGISTRO que acompanha o aparelho.

1. GARANTIA

Para assegurar que você receba imediatamente todos os benefícios de garantia para peças, assistência técnica e mão de obra especializada a que você tem direito.

2. ESTATUTO DE SEGURANÇA PARA PRODUTOS DE CONSUMO

Para assegurar que você receba, prontamente, todas as notificações relativas a segurança, tais como inspeções, modificações ou recolha, que a SHARP poderá ser requerida a executar com base no Estatuto de Segurança para Produtos de Consumo de 1972. RECOMENDA-SE UMA LEITURA CUIDADOSA DA IMPORTANTE CLÁUSULA "GARANTIA LIMITADA". Somente para OS E.U.A.

ATENÇÃO: Fonte de iluminação intensa. Não olhe direta nem fixamente o feixe de luz. Tenha muito cuidado com crianças, não permitindo que olhem fixamente o feixe de luz.



ATENÇÃO: Para reduzir riscos de incêndios ou choques elétricos, não exponha este aparelho à chuva ou umidade.

Veja o fundo do projetor.

	CUIDADO RISCO DE CHOQUE ELÉTRICO. NÃO RETIRE OS PARAFUSOS, EXCETO AQUELES DEVIDAMENTE ESPECIFICADOS PARA MANUSEIO PELO USUÁRIO.	
CUIDADO: PARA REDUZIR O RISCO DE CHOQUES ELÉTRICOS, NÃO RETIRE A TAMPA. NÃO HÁ PEÇAS QUE POSSAM SER CONSERTADAS PELO USUÁRIO NA PARTE INTERNA, EXCETO A LÂMPADA. ENCAMINHE OS CONSERTOS A UM POSTO DE ASSISTÊNCIA TÉCNICA QUALIFICADA.		



O símbolo do raio com a extremidade em forma de flecha dentro de um triângulo equilátero destina-se a alertar o usuário sobre a presença de "voltagens perigosas" e sem isolamento dentro do produto, que podem ser de magnitude suficiente para constituir perigo de choque elétrico para pessoas.



O ponto de exclamação dentro de um triângulo equilátero destina-se a alertar o usuário sobre a existência de instruções de operação e manutenção (assistência técnica) importantes na literatura que acompanha o produto.

ATENÇÃO: Os regulamentos FCC declaram que qualquer alteração ou modificação efetuada neste aparelho, que não seja expressamente aprovada pelo fabricante, poderá anular o direito de operação do equipamento pelo usuário. SOMENTE PARA OS E.U.A.

INFORMAÇÃO

Este equipamento foi testado e aprovado de acordo com os limites Classe A para dispositivos digitais, em conformidade com a Parte 15 das Normas FCC. Estes limites são designados a fim de prover uma proteção razoável contra interferências nocivas quando o equipamento for operado em ambientes comerciais. Este equipamento gera, usa e pode irradiar energia em frequência de rádio e, caso não seja instalado e utilizado de acordo com o manual de operação, pode causar interferências prejudiciais a comunicações de rádio. Entretanto, não há nenhuma garantia que não ocorrerão interferências em uma instalação em particular. A operação deste equipamento numa área residencial é susceptível de causar interferências prejudiciais, e nesse caso o utilizador será obrigado a corrigir a interferência a suas próprias custas. SOMENTE PARA OS E.U.A.

O cabo de computador incluso deve ser usado com este aparelho. O cabo é fornecido a fim de assegurar que o aparelho esteja de acordo com os requerimentos das normas FCC Classe A. SOMENTE PARA OS E.U.A.

ATENÇÃO:

Este aparelho é um produto de classe A. Ele poderá causar interferências de rádio em ambientes residenciais, sobre as quais o usuário poderá ser requerido a tomar as devidas providências por conta própria.





INFORMAÇÕES DE SEGURANÇA

ATENÇÃO: Leia por favor todas estas instruções antes de operar este produto e guarde-as para uso posterior.

A energia elétrica pode realizar muitas funções úteis. Este produto foi concebido e fabricado para garantir a sua segurança pessoal. MAS A UTILIZAÇÃO INCORRETA PODERÁ RESULTAR EM POTENCIAL CHOQUE ELÉTRICO OU PERIGO DE INCÊNDIO. A fim de não neutralizar as seguranças incorporadas neste produto, observe as seguintes regras básicas para a sua instalação, uso e assistência.

1. Leia as instruções

Todas as instruções de segurança e de operação devem ser lidas antes de utilizar o aparelho.

2. Guarde as instruções

Todas as instruções de segurança e de operação devem ser guardadas para consultas futuras.

3. Observe as advertências

Todas as advertências e as instruções de operação devem ser observadas.

4. Siga as instruções

Todas as instruções de uso e de operação devem ser seguidas.

5. Limpeza

Desligue o aparelho da tomada elétrica antes de limpá-lo. Não utilize produtos de limpeza líquidos ou em aerosol, apenas um pano úmido.

6. Adaptadores

Utilize somente os adaptadores recomendados pelo fabricante para não danificar o aparelho.

7. Água e umidade

Não utilize o aparelho perto da água. Por exemplo: perto de uma banheira, pia da cozinha ou tanque de lavar roupa, de um porão úmido ou perto de uma piscina, etc.

8. Acessórios

Não coloque este aparelho sobre um carrinho, suporte, tripé ou mesa instáveis. Ele pode cair, causando ferimentos graves a alguém ou ficar bastante danificado. Use somente os acessórios recomendados pelo fabricante ou vendidos junto com o aparelho. A fixação do aparelho e o acessório a ser utilizado devem seguir as recomendações do fabricante.

9. Transporte

Caso o aparelho esteja colocado sobre uma mesa com rodas, o conjunto deve ser movido com cuidado. Paradas repentinas, força excessiva e superfície desnivelada podem derrubá-lo.



10. Ventilação

Os furos e aberturas no gabinete foram projetados para proporcionar ventilação e garantir o funcionamento adequado do aparelho, protegendo-o contra superaquecimento. As aberturas não devem ser obstruídas, e assim sendo, não coloque o aparelho sobre uma cama, sofá, tapete ou qualquer outra superfície semelhante. Não o instale em um móvel fechado, como uma estante ou um "rack", a não ser que disponha de ventilação adequada e que as instruções do fabricante sejam cumpridas.

11. Alimentação

Este aparelho deve ser operado apenas com o tipo de alimentação indicado na etiqueta. Se não tiver certeza acerca do tipo de alimentação na sua casa, consulte um revendedor autorizado ou a companhia elétrica local. Consulte o manual de instruções para aparelhos que irão funcionar com pilhas ou outras fontes de energia.

12. Aterramento ou polarização

Este produto está equipado com um dos seguintes tipos de plugues. Se o plugue não servir na tomada de força, por favor contate o seu electricista.

Não anule a característica de segurança do plugue.

- Plugue de tipo de dois fios (corrente).
- Plugue de tipo de três fios com terra (corrente) com um terminal de aterramento.
Este plugue apenas servirá numa tomada de força de tipo com terra.

13. Proteção do cabo de alimentação

Os fios de alimentação devem ser instalados em locais que não possam ser pisados, nem posicionados sob objetos que possam pressioná-los. Preste atenção especial ao encaixe dos fios nos plugues, nas régulas de tomada e nos pontos onde saem do aparelho.

14. Relâmpagos

Para maior proteção deste equipamento durante tempestades, ou quando o mesmo não vá ser usado por um longo período, aconselha-se desligá-lo da tomada. Isto irá prevenir danos ao aparelho, causados por raios ou por sobretensão na energia elétrica.

15. Sobrecarga

Não sobrecarregue as tomadas elétricas, fios de extensão ou régulas de tomada pois podem causar incêndios ou choques elétricos.

16. Entrada de líquidos ou objetos

Nunca introduza nenhum tipo de objeto nas aberturas do aparelho porque este pode tocar pontos perigosos de tensão ou causar curto-circuito, provocando incêndio ou choque elétrico. Nunca derrame qualquer líquido no equipamento.

17. Assistência técnica

Não tente consertar o aparelho por conta própria, pois ao abrir ou retirar as tampas, você ficará exposto a altas tensões e outros perigos. Caso necessário, solicite sempre o serviço de técnicos qualificados.

18. Danos que necessitam assistência

Desligue o aparelho da tomada elétrica e solicite o serviço de técnicos qualificados nas seguintes circunstâncias:

- Quando o cabo de alimentação ou o plugue estiverem danificados.
- Se algum líquido ou objetos caírem dentro do equipamento.
- Se o equipamento for exposto à chuva ou à água.
- Se o equipamento não estiver funcionando normalmente, mesmo depois de verificadas as instruções de uso. Ajuste somente os controles indicados no manual já que o ajuste incorreto de outros controles pode causar danos outros que, muitas vezes, podem requerer o trabalho intenso de um técnico qualificado para que o equipamento volte a funcionar devidamente.
- Se o equipamento tiver caído ou sofrido algum dano.
- Quando o equipamento apresentar uma alteração brusca no desempenho, indicando a necessidade de conserto.

19. Reposição de peças

Quando houver necessidade de reposição de alguma peça, certifique-se de que o técnico use peças indicadas pelo fabricante ou que possuem as mesmas características das peças originais. Substituições por peças não autorizadas podem causar incêndio, choque elétrico ou outros perigos.

20. Inspeção de segurança

Após o término ou reparo de qualquer serviço, peça ao técnico que realize inspeções de segurança para determinar se o equipamento está em perfeitas condições de uso.

21. Montagem na Parede ou no Teto

Este aparelho só deve ser montado no teto ou na parede conforme recomendação do fabricante.

22. Calor

Este aparelho deve ficar longe de qualquer fonte de calor, como radiadores, saídas de calor, aquecedores ou outros produtos geradores de calor (incluindo amplificadores).



Leia cuidadosamente as seguintes informações de segurança quando instalar o seu projetor.

Cuidados relativos à lâmpada

- Perigo de ferimentos com partículas de vidro caso a lâmpada se quebre. Caso a lâmpada venha a quebrar, contatar um Revendedor Autorizado de Projetores Sharp ou um Centro de Assistência para trocar a lâmpada.

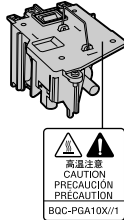

Cuidados relativos à instalação do projetor

- Para um mínimo de assistência e para manter uma elevada qualidade de imagem, a SHARP recomenda que este projetor seja instalado em uma área isenta de umidade, poeira e fumo de tabaco. Caso o projetor seja sujeito a estes ambientes, a lente deverá ser limpa mais frequentemente. Desde que o projetor seja limpo regularmente, a utilização nesses ambientes não reduzirá o tempo total de vida da unidade. A limpeza interna deverá ser efetuada apenas por um Revendedor Autorizado de Projetores Sharp ou um Centro de Assistência.

Não instale o projetor em locais expostos à luz solar direta ou a luzes fortes.

- Posicione a tela de forma a que esta não fique sob a luz solar ou luz ambiente diretas. A luz incidindo diretamente na tela esvanece as cores, dificultando a visualização. Feche as cortinas e reduza a iluminação quando instalar a tela em uma sala exposta ao sol ou muito iluminada.

O projetor pode ser inclinado com segurança em um ângulo máximo de 12 graus.

- A colocação deve estar dentro de ± 12 graus da horizontal.

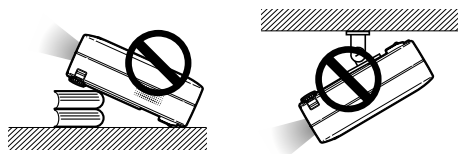

Não sujeite o projetor a pancadas fortes e/ou vibrações.

- Tome cuidado para não atingir nem danificar a superfície da lente.

Repouse seus olhos de vez em quando.

- Olhar continuamente para a tela durante longas horas cansará seus olhos. Não deixe de descansar seus olhos de vez em quando.

Evite locais com temperaturas extremas.

- A temperatura de operação para o projetor é de 41°F a 95°F (+5°C a +35°C)
- A temperatura de armazenagem para o projetor é de -4°F a 140°F (-20°C a +60°C).

Não bloqueie as grelhas de ventilação de entrada e de saída.

- Deixe um espaço de pelo menos 7 7/8" unidades (20 cm) entre a grelha de ventilação e a parede ou obstáculo mais próximos.
- Confira se a grelha de ventilação de entrada e de saída não estão obstruídas.
- Se a ventoinha de esfriamento ficar obstruída, um circuito de proteção desligará automaticamente o projetor. Isto não indica uma avaria. Desconecte o cabo de alimentação do projetor da rede elétrica e espere pelo menos 10 minutos. Coloque o projetor onde as grelhas de ventilação de entrada e saída não estejam bloqueadas, ligue novamente o plugue do cabo de força e ligue o projetor. Isto fará voltar o projetor ao modo de funcionamento normal.

Cuidados relativos ao transporte do projetor

- Quando transportar o projetor, tenha o cuidado de não o sujeitar a pancadas fortes esfriamento, dado que isso poderá originar danos. Tome cuidado especial com a lente. Antes de deslocar o projetor, retire o plugue do cabo de força da tomada, e desligue quaisquer outros cabos a ele ligados.

Outro equipamento conectado

- Quando conectar um computador ou outro equipamento audio-visual ao projetor, efetue as conexões APÓS desligar o projetor e o equipamento a ser conectado.
- Leia por favor os manuais de operação do projetor e o equipamento a ser conectado para instruções sobre como efetuar as conexões.

Utilização do projetor em outros países

- A tensão de força de alimentação e a forma do plugue poderão variar dependendo da região ou país no qual você está utilizando o projetor. Quando utilizar o projetor no estrangeiro, certifique-se que usa o cabo de força apropriado para o país no qual se encontra.

Função de monitorização de temperatura

- Se o projetor começar aquecendo devido a problemas de instalação ou bloqueamento das grelhas de ventilação, "X" e "TEMP" iluminar-se-á no canto inferior esquerdo da imagem. Se a temperatura continuar aumentando, a lâmpada apagará, o indicador de Aviso de Temperatura no projetor piscará, e após um período de esfriamento de 90 segundos a força será desligada.



Informação

- A ventoinha de esfriamento regula a temperatura interna, e o seu funcionamento é controlado automaticamente. O som da ventoinha poderá variar durante a operação de projeção devido a alterações da velocidade da ventoinha. Isto não indica uma avaria.
- Não retire o plugue do cabo de força durante a projeção ou o funcionamento da ventoinha de esfriamento. Isto poderá originar danos devido à subida da temperatura interna, quando a ventoinha de esfriamento parar.

Como Aceder os Manuais de Operação PDF

O CD-ROM inclui os manuais de operação (em formato PDF) em vários idiomas, para que você possa trabalhar com o projetor, mesmo que você não possua este manual. Para utilizar estes manuais, você precisará instalar Adobe Acrobat Reader no seu PC (Windows ou Macintosh). Mesmo que você não tenha instalado o Acrobat Reader, você poderá instalá-lo desde o CD-ROM.

Para instalar Acrobat Reader a partir do CD-ROM

Para Windows:

- ① Insira o CD-ROM no compartimento do CD-ROM.
- ② Dê um duplo clique no ícone "Meu Computador".
- ③ Dê um duplo clique no "CD-ROM".
- ④ Dê um duplo clique na pasta "ACROBAT".
- ⑤ Dê um duplo clique no idioma (nome da pasta) que você deseja visualizar.
- ⑥ Dê um duplo clique no programa de instalação e siga as instruções na tela.

Para Macintosh:

- ① Insira o CD-ROM no compartimento do CD-ROM.
- ② Dê um duplo clique no ícone "CD-ROM".
- ③ Dê um duplo clique na pasta "ACROBAT".
- ④ Dê um duplo clique no idioma (nome da pasta) que você deseja visualizar.
- ⑤ Dê um duplo clique no programa de instalação e siga as instruções na tela.

Para outros sistemas operacionais:

Instale Acrobat Reader pela Internet (<http://www.adobe.com>).

Para outros idiomas:

Se você prefere usar Acrobat Reader em um idioma que não esteja incluído no CD-ROM, favor obter a versão adequada pela Internet.

Para acessar os manuais PDF

Para Windows:

- ① Insira o CD-ROM no compartimento do CD-ROM.
- ② Dê um duplo clique no ícone "Meu Computador".
- ③ Dê um duplo clique no "CD-ROM".
- ④ Dê um duplo clique na pasta "MANUAIS".
- ⑤ Dê um duplo clique no idioma (nome da pasta) que você deseja visualizar.
- ⑥ Dê um duplo clique no arquivo PDF "A10" para acessar os manuais do projetor.

Para Macintosh:

- ① Insira o CD-ROM no compartimento do CD-ROM.
- ② Dê um duplo clique no ícone "CD-ROM".
- ③ Dê um duplo clique na pasta "MANUAIS".
- ④ Dê um duplo clique no idioma (nome da pasta) que você deseja visualizar.
- ⑤ Dê um duplo clique no arquivo PDF "A10" para acessar os manuais do projetor.

Nota

- Se o arquivo PDF desejado não puder ser aberto fazendo clique duplo com o mouse, inicie primeiro Acrobat Reader, e então especifique o arquivo desejado utilizando o menu "Arquivo", "Abrir".
- Consulte o arquivo "readme.txt" no CD-ROM para importantes informações não incluídas neste manual de operação.



MEMO

Free Manuals Download Website

<http://myh66.com>

<http://usermanuals.us>

<http://www.somanuals.com>

<http://www.4manuals.cc>

<http://www.manual-lib.com>

<http://www.404manual.com>

<http://www.luxmanual.com>

<http://aubethermostatmanual.com>

Golf course search by state

<http://golfingnear.com>

Email search by domain

<http://emailbydomain.com>

Auto manuals search

<http://auto.somanuals.com>

TV manuals search

<http://tv.somanuals.com>