



# SHARP®



## OPERATION MANUAL

MODEL

# XG-P25X

## LCD PROJECTOR

*Conference Series*

香港電器安全規格  
(國際電工委員會規格適合)



- Important Information
- Setup & Connections
- Operation Buttons
- Basic Operation
- Multiple Function
- Maintenance & Troubleshooting
- Appendix



**IMPORTANT**

For your assistance in reporting the loss or theft of your Color LCD Projector, please record the Serial Number located on the bottom of the projector and retain this information. Before recycling the packaging, please be sure that you have checked the contents of the carton thoroughly against the list of "Supplied Accessories" on page [15](#).

**Model No.: XG-P25X****Serial No.:**

This equipment complies with the requirements of Directives 89/336/EEC and 73/23/EEC as amended by 93/68/EEC.

Dieses Gerät entspricht den Anforderungen der EG-Richtlinien 89/336/EWG und 73/23/EWG mit Änderung 93/68/EWG.

Ce matériel répond aux exigences contenues dans les directives 89/336/CEE et 73/23/CEE modifiées par la directive 93/68/CEE.

Dit apparaat voldoet aan de eisen van de richtlijnen 89/336/EEG en 73/23/EEG, gewijzigd door 93/68/EEG.

Dette udstyr overholder kravene i direktiv nr. 89/336/EEC og 73/23/EEC med tillæg nr. 93/68/EEC.

Quest' apparecchio è conforme ai requisiti delle direttive 89/336/EEC e 73/23/EEC, come emendata dalla direttiva 93/68/EEC.

Η εγκατάσταση αυτή ανταποκρίνεται στις απαιτήσεις των οδηγιών της Ευρωπαϊκής Ένωσης 89/336/ΕΟΚ και 73/23/ΕΟΚ, όπως οι κανονισμοί αυτοί συμπληρώθηκαν από την οδηγία 93/68/ΕΟΚ.

Este equipamento obedece às exigências das directivas 89/336/CEE e 73/23/CEE, na sua versão corrigida pela directiva 93/68/CEE.



Este aparato satisface las exigencias de las Directivas 89/336/CEE y 73/23/CEE, modificadas por medio de la 93/68/CEE.

Denna utrustning uppfyller kraven enligt riktlinjerna 89/336/EEC och 73/23/EEC så som kompletteras av 93/68/EEC.

Dette produktet oppfyller betingelsene i direktivene 89/336/EEC og 73/23/EEC i endringen 93/68/EEC.

Tämä laite täyttää direktiivien 89/336/EEC ja 73/23/EEC vaatimukset, joita on muutettu direktiivillä 93/68/EEC.

**SPECIAL NOTE FOR USERS IN THE U.K.**

The mains lead of this product is fitted with a non-rewireable (moulded) plug incorporating a 13A fuse. Should the fuse need to be replaced, a BSI or ASTA approved BS 1362 fuse marked  or  and of the same rating as above, which is also indicated on the pin face of the plug, must be used. Always refit the fuse cover after replacing the fuse. Never use the plug without the fuse cover fitted. In the unlikely event of the socket outlet in your home not being compatible with the plug supplied, cut off the mains plug and fit an appropriate type.

**DANGER:**

The fuse from the cut-off plug should be removed and the cut-off plug destroyed immediately and disposed of in a safe manner.

Under no circumstances should the cut-off plug be inserted elsewhere into a 13A socket outlet, as a serious electric shock may occur.

To fit an appropriate plug to the mains lead, follow the instructions below:

**IMPORTANT:**

The wires in the mains lead are coloured in accordance with the following code:

Blue: Neutral  
Brown: Live

As the colours of the wires in the mains lead of this product may not correspond with the coloured markings identifying the terminals in your plug, proceed as follows:

- The wire which is coloured blue must be connected to the plug terminal which is marked N or coloured black.
- The wire which is coloured brown must be connected to the plug terminal which is marked L or coloured red.

Ensure that neither the brown nor the blue wire is connected to the earth terminal in your three-pin plug.

Before replacing the plug cover make sure that:

- If the new fitted plug contains a fuse, its value is the same as that removed from the cut-off plug.
- The cord grip is clamped over the sheath of the mains lead, and not simply over the lead wires.

IF YOU HAVE ANY DOUBT, CONSULT A QUALIFIED ELECTRICIAN.





The supplied CD-ROM contains operation instructions in English, German, French, Swedish, Spanish, Italian, Dutch, Portuguese, Chinese (Traditional Chinese and Simplified Chinese), Korean and Arabic. Carefully read through the operation instructions before operating the LCD projector.

Die mitgelieferte CD-ROM enthält Bedienungsanleitungen in Englisch, Deutsch, Französisch, Schwedisch, Spanisch, Italienisch, Niederländisch, Portugiesisch, Chinesisch (Traditionelles Chinesisch und einfaches Chinesisch), Koreanisch und Arabisch. Bitte lesen Sie die Bedienungsanleitung vor der Verwendung des LCD-Projektors sorgfältig durch.

Le CD-ROM fourni contient les instructions de fonctionnement en anglais, allemand, français, suédois, espagnol, italien, néerlandais, portugais, chinois (chinois traditionnel et chinois simplifié), coréen et arabe. Veuillez lire attentivement ces instructions avant de faire fonctionner le projecteur LCD.

Den medföljande CD-ROM-skivan innehåller bruksanvisningar på engelska, tyska, franska, svenska, spanska, italienska, holländska, portugisiska, kinesiska (traditionell kinesiska och förenklad kinesiska), koreanska och arabiska. Läs noga igenom bruksanvisningen innan projektorn tas i bruk.

El CD-ROM suministrado contiene instrucciones de operación en inglés, alemán, francés, sueco, español, italiano, holandés, portugués, chino (chino tradicional y chino simplificado), coreano y árabe. Lea cuidadosamente las instrucciones de operación antes de utilizar el proyector LCD.

Il CD-ROM in dotazione contiene istruzioni per l'uso in inglese, tedesco, francese, svedese, spagnolo, italiano, olandese, portoghese, cinese (cinese tradizionale e cinese semplificato), coreano e arabo. Leggere attentamente le istruzioni per l'uso prima di usare il proiettore LCD.

De meegeleverde CD-ROM bevat handleidingen in het Engels, Duits, Frans, Zweeds, Spaans, Italiaans, Nederlands, Portugees, Chinees (Traditioneel Chinees en Vereenvoudigd Chinees), Koreaans en Arabisch. Lees de handleiding zorgvuldig door voor u de LCD projector in gebruik neemt.

O CD-ROM fornecido contém instruções de operação em Inglês, Alemão, Francês, Sueco, Espanhol, Italiano, Holandês, Português, Chinês (Chinês Tradicional e Chinês Simplificado), Coreano e Árabe. Leia cuidadosamente todas as instruções de operação antes de operar o projetor LCD.

附送之CD-ROM光碟中，有用英文、德文、法文、瑞典文、西班牙文、意大利文、荷蘭文、葡萄牙文、中文（繁體中文和簡體中文）、韓國文和阿拉伯文所寫的使用說明書。在操作液晶投影機之前，請務必仔細閱讀整本使用說明書。

附送之CD-ROM光碟中，有用英文、德文、法文、瑞典文、西班牙文、意大利文、荷蘭文、葡萄牙文、中文（繁體中文和簡體中文）、韓國文和阿拉伯文所寫的使用說明書。在操作液晶投影机之前，请务必仔细阅读整本使用说明书。

제공된 CD-ROM에는 영어, 독일어, 프랑스어, 스웨덴어, 스페인어, 이탈리아어, 덴마크어, 포르투갈어, 중국어 (번체, 간체), 한국어, 그리고 아랍어로 작성된 조작 설명서가 포함되어 있습니다. LCD 프로젝터를 조작하기 전에 조작 지침을 상세 하게 숙지하십시오.

اسطوانة CD-ROM المجهزة تتضمن تعليمات التشغيل لكل من اللغات الانجليزية، الالمانية، الفرنسية، السويدية، الاسبانية، الايطالية، الهولندية، البرتغالية، الصينية (الصينية التقليدية والصينية المبسطة)، الكورية والعربية. قم بعناية بقراءة تعليمات التشغيل قبل تشغيل جهاز العرض الاسقاطي بشاشة الكريستال السائل.



Important Information



# Introduction

ENGLISH

There are two important reasons for prompt warranty registration of your new SHARP LCD Projector, using the REGISTRATION CARD packed with the projector.

### 1. WARRANTY

This is to assure that you immediately receive the full benefit of the parts, service and labor warranty applicable to your purchase.



### 2. CONSUMER PRODUCT SAFETY ACT

To ensure that you will promptly receive any safety notification of inspection, modification, or recall that SHARP may be required to give under the 1972 Consumer Product Safety Act, PLEASE READ CAREFULLY THE IMPORTANT "LIMITED WARRANTY" CLAUSE. U.S.A. ONLY

**WARNING:** High brightness light source. Do not stare into the beam of light, or view directly. Be especially careful that children do not stare directly into the beam of light. 

**WARNING:** To reduce the risk of fire or electric shock, do not expose this product to rain or moisture.

See bottom of actual set.

	<b>CAUTION</b> <b>RISK OF ELECTRIC SHOCK.</b> <b>DO NOT REMOVE SCREWS</b> <b>EXCEPT SPECIFIED USER</b> <b>SERVICE SCREWS.</b>	
<b>CAUTION: TO REDUCE THE RISK OF ELECTRIC SHOCK,</b> <b>DO NOT REMOVE COVER.</b> <b>NO USER-SERVICEABLE PARTS EXCEPT LAMP UNIT.</b> <b>REFER SERVICING TO QUALIFIED SERVICE</b> <b>PERSONNEL.</b>		



The lightning flash with arrowhead symbol, within an equilateral triangle, is intended to alert the user to the presence of uninsulated "dangerous voltage" within the product's enclosure that may be of sufficient magnitude to constitute a risk or electric shock to persons.



The exclamation point within a triangle is intended to alert the user to the presence of important operating and maintenance (servicing) instructions in the literature accompanying the product.

**WARNING:** FCC Regulations state that any unauthorized changes or modifications to this equipment not expressly approved by the manufacturer could void the user's authority to operate this equipment. U.S.A. ONLY

### INFORMATION

This equipment has been tested and found to comply with the limits for a Class A digital device, pursuant to Part 15 of the FCC Rules. These limits are designed to provide reasonable protection against harmful interference when the equipment is operated in a commercial environment. This equipment generates, uses, and can radiate radio frequency energy and, if not installed and used in accordance with the operation manual, may cause harmful interference to radio communications. Operation of this equipment in a residential area is likely to cause harmful interference, in which case the user will be required to correct the interference at his own expense. U.S.A. ONLY

The enclosed computer cable must be used with the device. The cable is provided to ensure that the device complies with FCC Class A verification. U.S.A. ONLY

### WARNING:

This is a class A product. In a domestic environment this product may cause radio interference in which case the user may be required to take adequate measures.

### WARNING:

The cooling fan in this projector continues to run for about 90 seconds after the projector is turned off. During normal operation, when turning the power off, always use the **POWER OFF** button on the projector or on the remote control. Ensure the cooling fan has stopped before disconnecting the power cord. **DURING NORMAL OPERATION, NEVER TURN THE PROJECTOR OFF BY DISCONNECTING THE POWER CORD. FAILURE TO OBSERVE THIS WILL RESULT IN PREMATURE LAMP FAILURE.**





## PRODUCT DISPOSAL

This projector utilizes tin-lead solder, and a pressurized lamp containing a small amount of mercury. Disposal of these materials may be regulated due to environmental considerations. For disposal or recycling information, please contact your local authorities or, if you are located in the United States of America, the Electronics Industries Alliance: [www.eiae.org](http://www.eiae.org).

Important  
Information

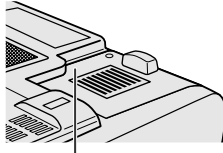

## Caution Concerning the Lamp Replacement

See "Replacing the Lamp" on pages [62](#) and [63](#).

### LAMP REPLACEMENT CAUTION

BEFORE REMOVING THE SCREW, DISCONNECT  
POWER CORD. HOT SURFACE INSIDE.  
ALLOW 1 HOUR TO COOL BEFORE REPLACING  
THE LAMP. REPLACE WITH SAME SHARP LAMP  
UNIT TYPE B0C-XGP25X/1 ONLY.  
UV RADIATION : CAN CAUSE EYE DAMAGE.  
TURN OFF LAMP BEFORE SERVICING.  
MEDIUM PRESSURE LAMP : RISK OF EXPLOSION,  
POTENTIAL HAZARD OF GLASS PARTICLES IF  
LAMP HAS RUPTURED. HANDLE WITH CARE.  
SEE OPERATION MANUAL.





## IMPORTANT SAFEGUARDS

**CAUTION:** Please read all of these instructions before you operate this product and save these instructions for later use.

Electrical energy can perform many useful functions. This product has been engineered and manufactured to ensure your personal safety. But IMPROPER USE CAN RESULT IN POTENTIAL ELECTRICAL SHOCK OR FIRE HAZARD. In order not to defeat the safeguards incorporated into this LCD Projector, observe the following basic rules for its installation, use and servicing.

### 1. Read Instructions

All the safety and operating instructions should be read before the product is operated.

### 2. Retain Instructions

The safety and operating instructions should be retained for future reference.

### 3. Heed Warnings

All warnings on the product and in the operating instructions should be adhered to.

### 4. Follow Instructions

All operating and use instructions should be followed.

### 5. Cleaning

Unplug this product from the wall outlet before cleaning. Do not use liquid cleaners or aerosol cleaners. Use a damp cloth for cleaning.

### 6. Attachments

Do not use attachments not recommended by the product manufacturer as they may cause hazards.

### 7. Water and Moisture

Do not use this product near water—for example, near a bathtub, wash bowl, kitchen sink, or laundry tub; in a wet basement; or near a swimming pool; and the like.

### 8. Accessories

Do not place this product on an unstable cart, stand, tripod, bracket, or table. The product may fall, causing serious injury to a child or adult, and serious damage to the product. Use only with a cart, stand, tripod, bracket, or table recommended by the manufacturer, or sold with the product. Any mounting of the product should follow the manufacturer's instructions, and should use a mounting accessory recommended by the manufacturer.

### 9. Transportation

A product and cart combination should be moved with care. Quick stops, excessive force, and uneven surfaces may cause the product and cart combination to overturn.



### 10. Ventilation

Slots and openings in the cabinet are provided for ventilation to ensure reliable operation of the product and to protect it from overheating, and these openings must not be blocked or covered. The openings should never be blocked by placing the product on a bed, sofa, rug, or other similar surface. This product should not be placed in a built-in installation such as a bookcase or rack unless proper ventilation is provided or the manufacturer's instructions have been adhered to.

### 11. Power Sources

This product should be operated only from the type of power source indicated on the marking label. If you are not sure of the type of power supply to your home, consult your product dealer or local power company. For products intended to operate from battery power, or other sources, refer to the operating instructions.

### 12. Grounding or Polarization

This product is provided with one of the following types of plugs. If the plug should fail to fit into the power outlet, please contact your electrician.

Do not defeat the safety purpose of the plug.

- a. Two-wire type (mains) plug.
- b. Three-wire grounding type (mains) plug with a grounding terminal.  
This plug will only fit into a grounding type power outlet.

### 13. Power-Cord Protection

Power-supply cords should be routed so that they are not likely to be walked on or pinched by items placed upon or against them, paying particular attention to cords at plugs, convenience receptacles, and the point where they exit from the product.

### 14. Lightning

For added protection for this product during a lightning storm, or when it is left unattended and unused for long periods of time, unplug it from the wall outlet and disconnect the cable system. This will prevent damage to the product due to lightning and power-line surges.

### 15. Overloading

Do not overload wall outlets, extension cords, or integral convenience receptacles as this can result in a risk of fire or electric shock.

### 16. Object and Liquid Entry

Never push objects of any kind into this product through openings as they may touch dangerous voltage points or short-out parts that could result in a fire or electric shock. Never spill liquid of any kind on the product.

### 17. Servicing

Do not attempt to service this product yourself as opening or removing covers may expose you to dangerous voltage or other hazards. Refer all servicing to qualified service personnel.



## IMPORTANT SAFEGUARDS

Important  
Information



### 18. Damage Requiring Service

Unplug this product from the wall outlet and refer servicing to qualified service personnel under the following conditions:

- a. If the power-supply cord or plug is damaged.
- b. If liquid has been spilled, or objects have fallen into the product.
- c. If the product has been exposed to rain or water.
- d. If the product does not operate normally by following the operating instructions. Adjust only those controls that are covered by the operating instructions, as an improper adjustment of other controls may result in damage and will often require extensive work by a qualified technician to restore the product to normal operation.
- e. If the product has been dropped or damaged in any way.
- f. If the product exhibits a distinct change in performance, this indicates a need for service.

### 19. Replacement Parts

When replacement parts are required, be sure the service technician has used replacement parts specified by the manufacturer or have the same characteristics as the original part. Unauthorized substitutions may result in fire, electric shock, or other hazards.

### 20. Safety Check

Upon completion of any service or repairs to this product, ask the service technician to perform safety checks to determine that the product is in proper operating condition.

### 21. Wall or Ceiling Mounting

This product should be mounted to a wall or ceiling only as recommended by the manufacturer.

### 22. Heat

This product should be situated away from heat sources such as radiators, heat registers, stoves, or other products (including amplifiers) that produce heat.

- Microsoft and Windows are registered trademarks of Microsoft Corporation, in the United States and/or other countries.
- PC/AT is a registered trademark of International Business Machines Corporation in the United States.
- Adobe Acrobat is a trademark of Adobe Systems Incorporated.
- Macintosh is a registered trademark of Apple Computer, Inc. in the United States and/or other countries.
- All other company or product names are trademarks or registered trademarks of their respective companies.
- This software is based in part on the work of the Independent JPEG Group.





## IMPORTANT SAFEGUARDS

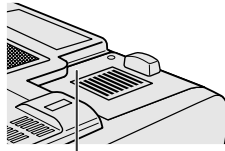

**LAMP REPLACEMENT CAUTION**

BEFORE REMOVING THE SCREW, DISCONNECT POWER CORD. HOT SURFACE INSIDE. ALLOW 1 HOUR TO COOL BEFORE REPLACING THE LAMP. REPLACE WITH SAME SHARP LAMP UNIT TYPE BQC-XGP25X/1 ONLY.

UV RADIATION - CAN CAUSE EYE DAMAGE. TURN OFF LAMP BEFORE SERVICING.

MEDIUM PRESSURE LAMP - RISK OF EXPLOSION. POTENTIAL HAZARD OF GLASS PARTICLES IF LAMP HAS RUPTURED. HANDLE WITH CARE. SEE OPERATION MANUAL.

### Caution Concerning the Lamp Replacement

See "Replacing the Lamp" on pages 62 and 63.

#### PRODUCT DISPOSAL

This projector utilizes tin-lead solder, and a pressurized lamp containing a small amount of mercury. Disposal of these materials may be regulated due to environmental considerations. For disposal or recycling information, please contact your local authorities or, if you are located in the United States of America, the Electronics Industries Alliance: [www.eiae.org](http://www.eiae.org).

### Caution Concerning the Lamp Unit

Potential hazard of glass particles if lamp ruptures. In case of lamp rupture, contact your nearest Sharp Authorized LCD Projector Dealer or Service Center for a replacement.

See "Replacing the Lamp" on pages 62 and 63.

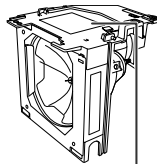

高温注意  
CAUTION  
PRECAUCION  
PRECAUCION

BQC-XGP25X/1

### Cautions Concerning the Setup of the Projector

For minimal servicing and to maintain high image quality, SHARP recommends that this projector be installed in an area free from humidity, dust and cigarette smoke. When the projector is subjected to these environments, the lens must be cleaned more often. As long as the projector is properly maintained in this manner, use in these environments will not reduce the overall operation life. Please note that all internal cleaning must be performed by a Sharp Authorized LCD Projector Dealer or Service Center.

### Notes on Operation

- The exhaust vent, the lamp cage cover and adjacent areas may be extremely hot during projector operation. To prevent injury, do not touch these areas until they have sufficiently cooled.
- Allow at least 12 inches (30 cm) of space between the exhaust vent and the nearest wall or obstruction.
- If the cooling fan becomes obstructed, a protection device will automatically turn off the projector lamp. This does not indicate a malfunction. Remove the projector power cord from the wall outlet and wait at least 10 minutes. Then turn on the power by plugging the power cord back in. This will return the projector to the normal operating condition.







## IMPORTANT SAFEGUARDS

Important Information



### Temperature Monitor Function

If the projector starts to overheat due to setup problems or a dirty air filter, "TEMP." and "TEMP." will blink in the lower-left corner of the picture. If the temperature continues to rise, the lamp will turn off, the TEMPERATURE WARNING indicator on the projector will blink, and after a 90-second cooling-off period the power will shut off. Refer to "Lamp/Maintenance Indicators" on page 61, for details.

#### NOTE

- The cooling fan regulates the internal temperature, and its performance is automatically controlled. The sound of the fan may change during projector operation due to changes in the fan speed.



### Lamp Monitor Function

When the projector is turned on after the lamp has been used for 1,400 hours, "LAMP" and "LAMP" will blink in the lower-left corner of the picture to advise you to replace the lamp. See pages 62 and 63 for lamp replacement. If the lamp has been used for 1,500 hours, the projector power will automatically turn off and the projector will enter standby mode. Refer to "Lamp/Maintenance Indicators" on page 61, for details.

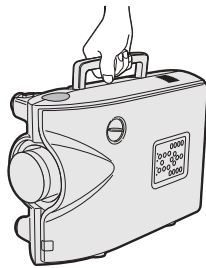

### Using the Carrying Handle

When transporting the projector, carry it by the carrying handle on the side.

#### CAUTION

- Always put on the lens cap to prevent damage to the lens when transporting the projector.
- Do not lift or carry the projector by the lens or the lens cap as this may damage the lens.

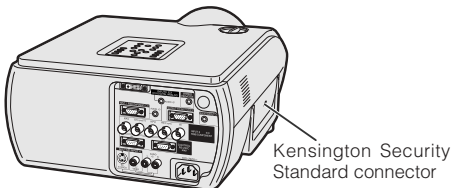

### Using the Kensington Lock

This projector has a Kensington Security Standard connector for use with a Kensington MicroSaver Security System. Refer to the information that came with the system for instructions on how to use it to secure the projector.



## Outstanding Features

### 1. High-end LCD Projector with Ultra High Brightness

- **AC 270 W Lamp**

Use AC 270 W lamp for excellent color uniformity and ultra high brightness.

### 2. Computer Compatibility

- **Compatible with resolutions including VGA-SVGA (expanded), XGA (true resolution) and SXGA-UXGA (compressed) as well as DTV formats (480I, 480P, 580I, 580P, 720P, 1035I and 1080I).**

### 3. XGA Image Quality

- **OCS LCD panel enhances color uniformity.**
- **Various other circuits are also used to provide high quality video images.**

### 4. Computer & Video Integrated Composer Technology

- **New Progressive Mode**

I/P conversion with new algorithm used to achieve beautiful image quality.

- **Enhanced Up-scaling and Digital Image Enlargement**

Enables sharper image quality without jaggies even for enlarged images.

- **Superior 16:9 Image**

4:3 images can be converted to 16:9 images using Smart Stretch (sides stretched, center untouched), previously not achievable with LCD projectors.

- **Intelligent Digital Keystone Correction**

Smooths out jaggies on keystone images and compresses the image not only horizontally but vertically keeping the 4:3 aspect ratio. Even if the 4:3 aspect ratio changes due to lens shift, v-size adjustment allows you to keep this ratio.

- **New Intelligent Compression**

Efficiently compresses UXGA (1,600 × 1,200) images to XGA (1,024 × 768).

- **Enhanced three-two pull down**

Converts cinema mode DVD images transformed with three-two pull down enhancement to progressive mode images for easier viewing by Film Mode.

- **Dynamic GAMMA Correction**

Optimizing GAMMA correction frame by frame in real time.

### 5. 3D Digital Uniformity and Digital Convergence

- **Three-Dimensional Digital Uniformity compensates uneven picture brightness even for pictures at any brightness level from white to dark. And, with Digital Convergence, a slight distortion of convergence can be adjusted on the service menu screen without having to touch the LCD panel.**

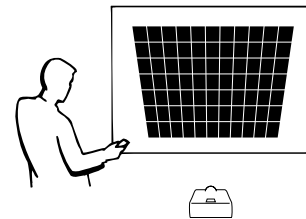



## Outstanding Features

Important Information



### 6. Network Capability

- **Self-Diagnosis/Projector Status**

Self-diagnosis/Projector status function sends e-mail messages to a specified computer about lamp usage time and any malfunctions.

- **Multiple & Group Projector Control**

Up to 250 projectors can be controlled over a network. Projector RS-232C OUT can be used for daisy chain connection.

- **Simple Stacking and Videowall Display**

Comes with software for easy stacking and videowall processing even for input from a single source.

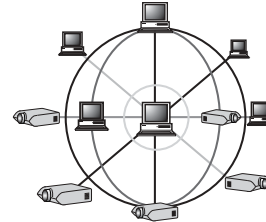

### 7. Two Optional Lenses for Maximum Flexibility

- **Screw mount type: Fixed Wide Lens, Tele-Zoom Lens**

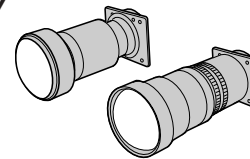

### 8. Multiple Input and Output Terminals

- BNC Terminal for RGB/Component/Video Signal
- PC Digital Input (DVI)
- Output terminal with VAO (variable audio output) support

### 9. Easy Setup

- Lens Shift, Power Zoom & Focus, Digital Keystone Correction
- High Speed Auto Sync Technology

### 10. Useful Features

- Picture-in-Picture, Digital Enlargement, Freeze
- Customizable Startup Screen & Background Screen

### 11. Application Software

- "Sharp Advanced Presentation Software Professional Edition" (Network and Remote Control)

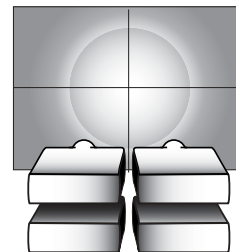
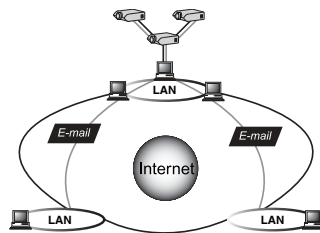



**Important Information**

**Setup & Connections**

**Operation Buttons**

**Basic Operation**

**Multiple Function**

**Maintenance & Troubleshooting**

**Appendix**

# Contents

## Important Information

- Introduction** ..... **1**
- IMPORTANT SAFEGUARDS** ..... **3**
- Outstanding Features** ..... **7**
- Contents** ..... **9**
- How to Access the PDF Operation Manuals** ..... **11**
- Part Names** ..... **12**
- Using the Remote Control** ..... **14**
- Accessories** ..... **15**

## Setup & Connections

- Connections** ..... **16**
  - Power Supply ..... **16**
  - Projecting Computer Images ..... **17**
  - Watching Video Images ..... **20**
  - Watching Component Video Images ..... **21**
  - For Better Sound ..... **21**
  - Power ON/OFF ..... **22**
- Setting Up the Screen** ..... **23**
  - Using the Adjustment Feet ..... **23**
  - Using the Lens Shift ..... **23**
  - LENS Button ..... **24**
  - Adjusting the Projection Distance ..... **25**
- Image Projection** ..... **30**
  - Rear Projection ..... **30**
  - Projection Using a Mirror ..... **30**
  - Ceiling-mount Projection ..... **30**

## Operation Buttons

- Using the Operation Buttons** ..... **31**
  - Selecting the Input Signal Source ..... **31**
  - Adjusting the Volume ..... **31**
  - Muting the Sound ..... **31**
  - Superimposing a Black Screen ..... **32**
  - Displaying a Still Image ..... **32**
  - Magnifying a Specific Portion of an Image ..... **33**
  - Display and Setting the Break Timer ..... **34**
  - Computer Image Adjustments using AUTO SYNC ..... **34**
  - Adjusting the Picture Aspect Ratio ..... **35**
  - Gamma Correction Function ..... **37**

## Basic Operation

- Using the GUI (Graphical User Interface) Menu Screen** ..... **38**
  - Basic Operations ..... **38**
  - Menu Bars ..... **39**
  - Adjusting the Picture ..... **41**
  - Adjusting the Computer Images (RGB menu only) ..... **43**
  - Adjusting the Sound ..... **46**
  - Displaying Dual Pictures (RGB menu only) ..... **47**
  - Reducing Image Noise (VIDEO menu only) ..... **47**
  - Turning On/Off the On-screen Display ... **48**
  - Setting the Video Signal (VIDEO menu only) ..... **48**
  - Selecting a Background Image ..... **49**
  - Selecting a Startup Image ..... **49**
  - Selecting the Economy Mode ..... **50**
  - Confirming the Lamp Usage Time ..... **51**
  - Reversing/Inverting Projected Images ... **51**
  - Setting the Stacking Mode ..... **52**
  - Locking the Operation Buttons on the Projector ..... **52**
  - Deselecting Inputs ..... **53**
  - Selecting the Transmission Speed (RS-232C) ..... **53**
  - Controlling Multiple Projectors with ID Numbers ..... **54**
  - Protecting Important Settings with a Password ..... **55**
  - Selecting the On-screen Display Language ..... **56**
  - Displaying the Adjustment Settings ..... **56**



## Contents



## Multiple Function

Using Extended Functionality Features .....	<b>57</b>
---	-----------



## Maintenance & Troubleshooting

Lamp/Maintenance Indicators .....	<b>61</b>
Replacing the Lamp .....	<b>62</b>
Replacing the Air Filter .....	<b>64</b>
Troubleshooting .....	<b>65</b>
For SHARP Assistance .....	<b>66</b>



## Appendix

Connecting Pin Assignments .....	<b>67</b>
(RS-232C) Specifications and Command Settings .....	<b>68</b>
Wired Remote Control Terminal Specifications .....	<b>71</b>
Compatibility Chart .....	<b>72</b>
Dimensions .....	<b>73</b>
Specifications .....	<b>74</b>
Glossary .....	<b>75</b>
Index .....	<b>76</b>

Important Information



Setup & Connections



Operation Buttons



Basic Operation



Multiple Function



Maintenance & Troubleshooting



Appendix





## How to Access the PDF Operation Manuals

PDF operation manuals in several languages are included in the Projector Manual and Technical Reference CD-ROM. To utilize these manuals, you need to install Adobe Acrobat Reader on your PC (Windows or Macintosh). If you have not installed Acrobat Reader yet, you can download it from the Internet (<http://www.adobe.com>) or install it from the CD-ROM.

### To Install Acrobat Reader from the CD-ROM

#### For Windows:

- ① Insert the CD-ROM in the CD-ROM drive.
- ② Double click on the "My Computer" icon.
- ③ Double click on the "CD-ROM" drive.
- ④ Double click on the "acrobat" folder.
- ⑤ Double click on the desired installation program and follow the instructions on the screen.

#### For Macintosh:

- ① Insert the CD-ROM in the CD-ROM drive.
- ② Double click on the "CD-ROM" icon.
- ③ Double click on the "acrobat" folder.
- ④ Double click on the desired installation program and follow the instructions on the screen.

#### For other operating systems:

Please download Acrobat Reader from the Internet (<http://www.adobe.com>).

#### For other languages:

If you prefer using Acrobat Reader for languages other than those included in the CD-ROM, please download the appropriate version from the Internet.

### Accessing the PDF Manuals

#### For Windows:

- ① Insert the CD-ROM in the CD-ROM drive.
- ② Double click on the "My Computer" icon.
- ③ Double click on the "CD-ROM" drive.
- ④ Double click on the "manuals" folder.
- ⑤ Double click on the language (name of the folder) that you want to view.
- ⑥ Double click on the "p25x" pdf file to access the projector manual.
- ⑦ Double click on the pdf file.

#### For Macintosh:

- ① Insert the CD-ROM in the CD-ROM drive.
- ② Double click on the "CD-ROM" icon.
- ③ Double click on the "manuals" folder.
- ④ Double click on the language (name of the folder) that you want to view.
- ⑤ Double click on the "p25x" pdf file to access the projector manual.
- ⑥ Double click on the pdf file.

#### NOTE

- If the desired pdf file cannot be opened by double clicking the mouse, start Acrobat Reader first, then specify the desired file using the "File", "Open" menu.
- See the "readme.txt" file on the CD-ROM for important information on the CD-ROM not included in this operation manual.



# Part Names

Numbers next to the part names refer to the main pages in this manual where the topic is explained.

Important Information



## Projector

### Front View

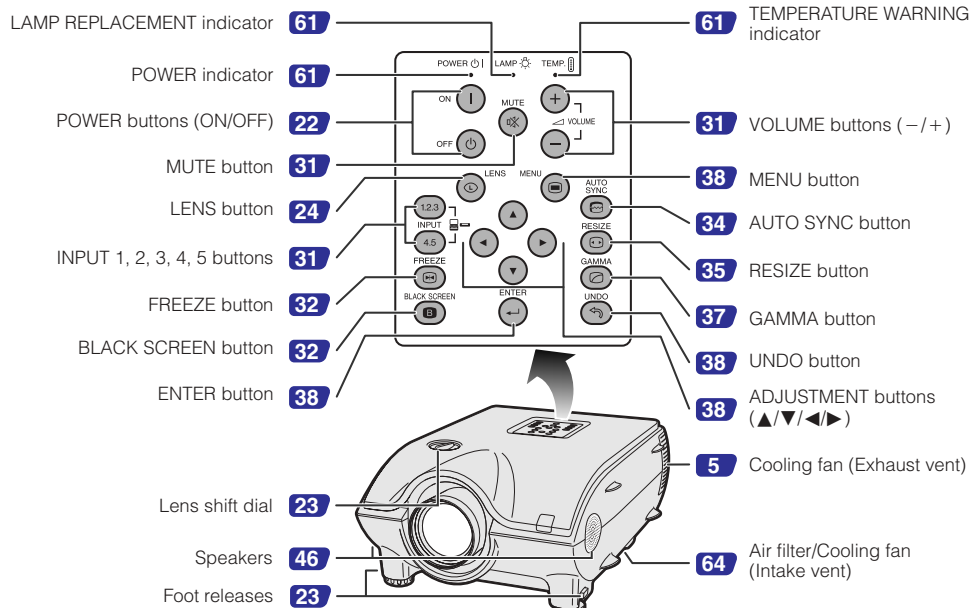

### Rear View

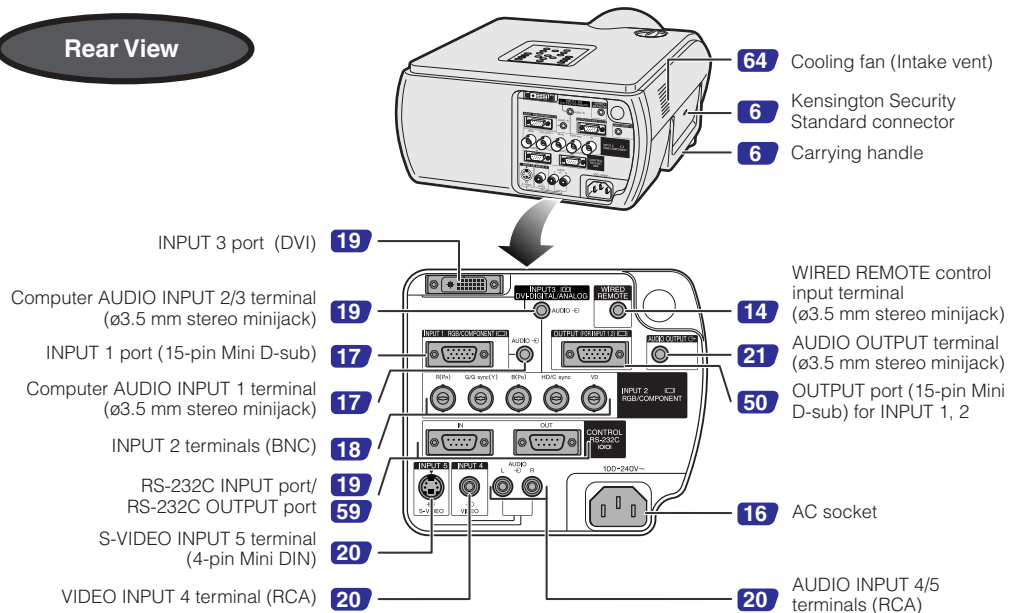



Important Information



## Part Names

Numbers next to the part names refer to the main pages in this manual where the topic is explained.

### Remote Control

#### Front View

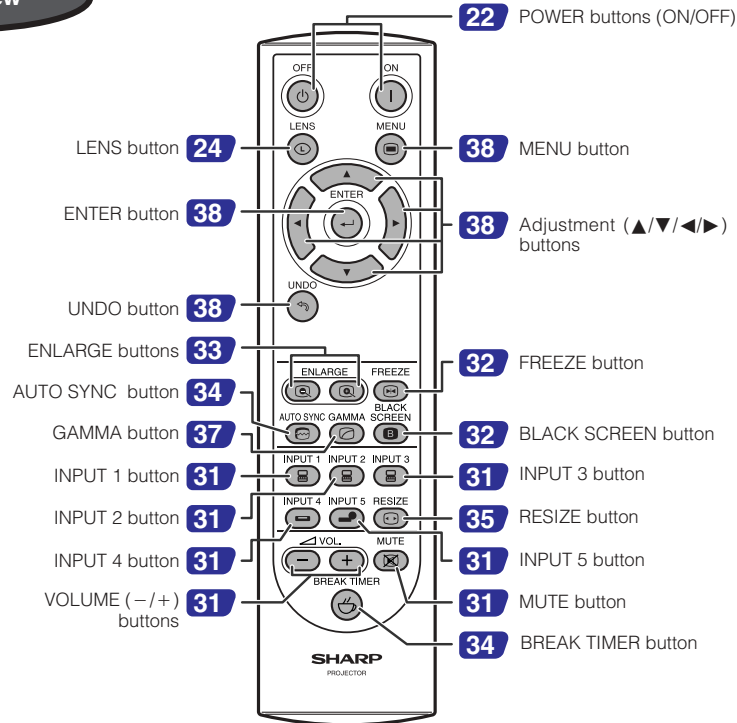

#### Bottom View

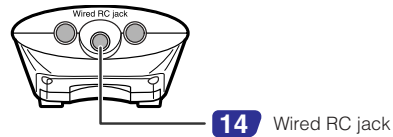





## Using the Remote Control

Important Information

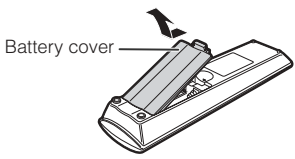
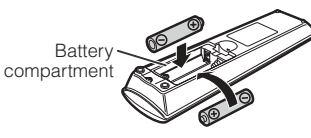
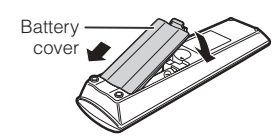

### Inserting the batteries

<p><b>1</b> Press the tab and lift open the battery cover in the direction of the arrow.</p>	<p><b>2</b> Insert two R-6 batteries ("AA" size, UM/SUM-3, HP-7 or similar), making sure the polarities match the + and - marks inside the battery compartment.</p>	<p><b>3</b> Insert the tabs on the end of the battery cover into their slots and press the cover into position.</p>
 <p>Battery cover</p>	 <p>Battery compartment</p>	 <p>Battery cover</p>

Incorrect use of the batteries may cause them to leak or explode. Please follow the precautions below.

#### CAUTION

- Insert the batteries making sure the polarities correctly match the + and - marks inside the battery compartment.
- Batteries of different types have different properties, therefore do not mix batteries of different types.
- Do not mix new and old batteries.  
This may shorten the life of new batteries or may cause old batteries to leak.
- Remove the batteries from the remote control once they have run out, as leaving them can cause them to leak. Battery fluid from leaked batteries is harmful to your skin, therefore be sure to first wipe them and then remove them using a cloth.
- The batteries included with this projector may be used up over a short period, depending on how they are kept. Be sure to replace them as soon as possible with new batteries.
- Remove the batteries from the remote control if you will not be using the remote control for a long time.

### Available Range of the Remote Control

The remote control can be used to control the projector within the ranges shown in the illustration.

#### NOTE

- The signal from the remote control can be reflected off a screen for easy operation. However, the effective distance of the signal may differ due to the screen material.

When using the remote control:

- Be sure not to drop, expose to moisture or high temperature.
- The remote control may malfunction under a fluorescent lamp. Under that circumstance, move the projector away from the fluorescent lamp.

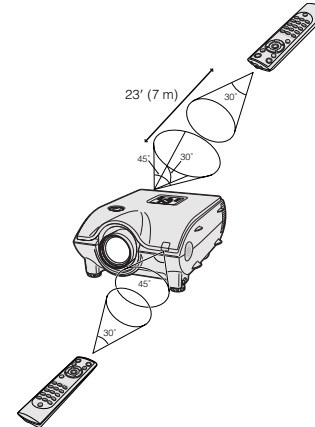

### Using as a Wired Remote Control

When the remote control cannot be used due to the range or positioning of the projector (rear projection, etc.), connect a  $\varnothing 3.5$  mm minijack cable (commercially available) from the wired RC jack on the bottom of the remote control to the WIRED REMOTE control input terminal on the rear of the projector.

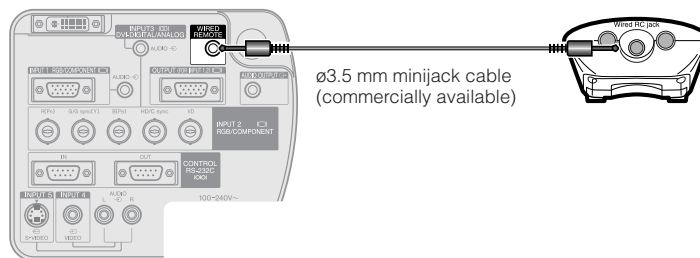

E-14





Important  
Information



## Accessories

### Supplied Accessories



Remote control  
RRMCGA048WJSA



Two R-6 batteries  
("AA" size, UM/SUM-3,  
HP-7 or similar)

Power cord  
(1)

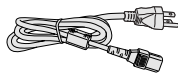

For U.S., Canada etc.  
(11' 10", 3.6m)  
QACCD A010WJPZ

(2)

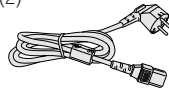

For Europe, except U.K.  
(6', 1.8m)  
QACCV4002CEZZ

(3)

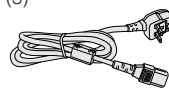

For U.K., Hong Kong  
and Singapore  
(6', 1.8m)  
QACCB5024CENA

(4)

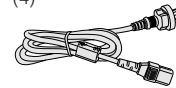

For Australia, New  
Zealand and Oceania  
(6', 1.8m)  
QACCL3022CEZZ

#### NOTE

- Depending on the region, projectors only ship with one power cord (See above). Use the power cord that corresponds to the wall outlet in your country.



RGB cable  
(9' 10", 3m)  
QCNWGA012WJPZ



Three BNC-RCA adaptors  
QPLGJ0107GEZZ

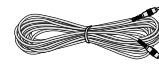

Computer audio cable  
(ø3.5 mm stereo minijack cable)  
(9' 10", 3m)  
QCNWGA013WJPZ



Lens cap  
(attached)  
PCAPH1056CESA



Extra air filter  
PFILD0080CEZZ

Projector Manual and Technical  
Reference CD-ROM  
UDSKAA004WJZZ

LCD projector operation manual  
TINS-A133WJZZ

Sharp Advanced Presentation  
Software installation guide  
TINS-A139WJZZ

Sharp Advanced Presentation  
Software CD-ROM  
UDSKAA005WJZZ

Quick reference guides

ID number seal  
TLABZ0781CEZZ

### Optional Accessories

DVI cable (9' 10" (3.0 m))  
3 RCA to 15-pin D-sub cable (9' 10" (3.0 m))  
Computer RGB cable (32' 10" (10.0 m))

AN-C3DV  
AN-C3CP  
AN-C10BM  
(for IBM-PC, NEC PC-9821 and PC-98NX series)  
AN-C10MC  
(for Macintosh series)  
AN-C10PC  
(for NEC PC-98 series (Except NEC PC-9821 and PC-98NX series))

5 BNC to 15-pin D-sub cable (9' 10" (3.0 m))  
RS-232C serial control cable (32' 10" (10.0 m))  
DVI to 15-pin D-sub adaptor (7.9" (20 cm))

AN-C3BN  
AN-C10RS  
AN-A1DV

#### NOTE

- All cables may not be available in all regions. Please check with your nearest Sharp Authorized LCD Projector Dealer or Service Center.

E-15





## Connections



### Power Supply

#### Connecting the Power Cord

Plug the supplied power cord into the AC socket on the rear of the projector.

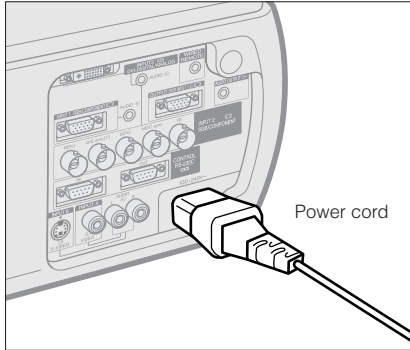

Make the necessary connections before proceeding. Connect the power cord to a wall outlet. The POWER indicator lights up red and the projector enters standby mode.

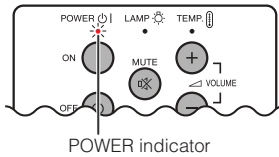

#### NOTE

- If the bottom filter cover is not securely installed, the POWER indicator flashes.



## Projecting Computer Images

### Connecting the Projector to a Computer

You can connect your projector to a computer for projection of full color computer images.

#### Connecting to a computer using the standard 15-pin Input

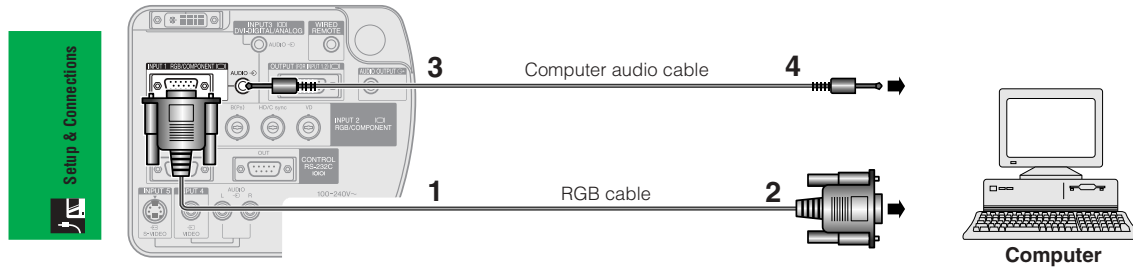

- 1 Connect one end of the supplied RGB cable to the INPUT 1 port on the projector.
- 2 Connect the other end to the monitor output port on the computer. Secure the connectors by tightening the thumb screws.
- 3 To use the built-in audio system, connect one end of the supplied computer audio cable to the AUDIO INPUT 1 terminal on the projector.
- 4 Connect the other end to the audio output terminal on the computer.

#### CAUTION

- Before connecting, be sure to turn both the projector and the computer off. After making all connections, turn the projector on first. The computer should always be turned on last.

#### NOTE

- Please read the computer's operation manual carefully before making connections.
- Refer to page 72 "Compatibility Chart" for a list of computer signals compatible with the projector. Use with computer signals other than those listed may cause some of the functions not to work.
- A ø3.5 mm stereo minijack to stereo RCA audio cable adaptor may be necessary.

When connecting this projector to a computer, select "RGB" for "Signal Type" on the GUI menu. (See page 41.)

#### NOTE

- A Macintosh adaptor may be required for use with some Macintosh computers. Contact your nearest Sharp Authorized LCD Projector Dealer or Service Center.
- AUDIO INPUT 1 can be used to input audio corresponding to the INPUT 1.





## Projecting Computer Images

- This projector uses a 5 BNC computer input to prevent deterioration of image quality.
- Connect the R (P<sub>R</sub>), G/G sync (Y), B (P<sub>B</sub>), HD/C sync and VD cables (sold separately) to the correct input terminals on the projector and an RGB switcher (sold separately) connected to the computer, or connect a 5 BNC cable (sold separately) directly from the input terminals on the projector to the computer.

### Connecting to an external RGB switcher or other compatible computers using the BNC Input (Typically used in larger installations)

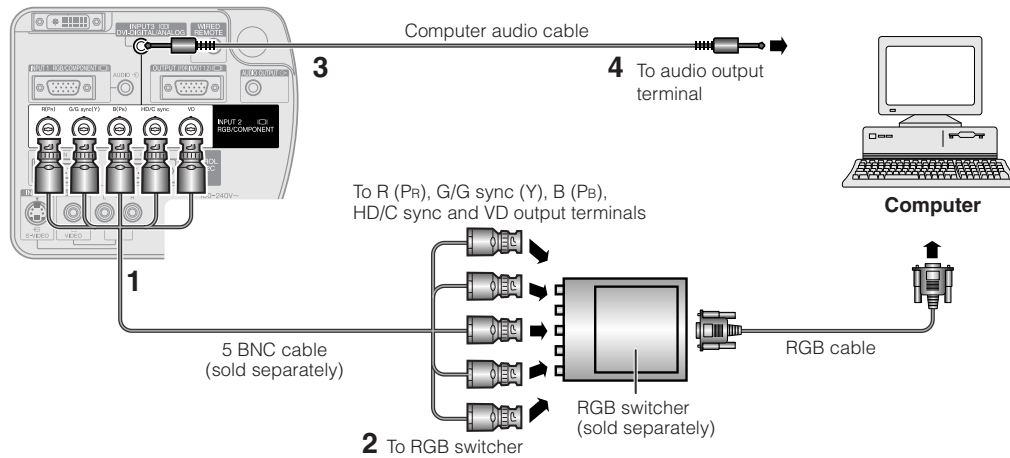

Setup & Connections



- 1** Connect each BNC connector of a 5 BNC cable to the corresponding INPUT 2 terminals on the projector.
- 2** Connect the other end of the 5 BNC cable to the corresponding BNC terminals on the external RGB switcher. Connect the RGB switcher to the computer using a RGB cable.
- 3** To use the built-in audio system, connect one end of the supplied computer audio cable to the AUDIO INPUT 2/3 terminal on the projector.
- 4** Connect the other end to the audio output terminal on the computer or external audio system.

#### NOTE

- A ø3.5 mm stereo minijack to stereo RCA audio cable adaptor may be necessary.

When connecting the projector to a compatible computer other than a PC (VGA/SVGA/XGA/SXGA/UXGA) or Macintosh (i.e. Workstation), a separate cable may be needed. Please contact your dealer for more information.

When connecting this projector to a computer, select "RGB" for "Signal Type" on the GUI menu. (See page 41.)

#### NOTE

- Connecting computers other than the recommended types may result in damage to the projector, the computer, or both.
- AUDIO INPUT 2/3 can be used to input audio corresponding to the INPUT 2/3.

### "Plug and Play" function (when connecting to a 15-pin terminal)

- This projector is compatible with VESA-standard DDC 1/DDC 2B. The projector and a VESA DDC compatible computer will communicate their setting requirements, allowing for quick and easy setup.
- Before using the "Plug and Play" function, be sure to turn on the projector first and the connected computer last.

#### NOTE

- The DDC "Plug and Play" function of this projector operates only when used in conjunction with a VESA DDC compatible computer.





## Projecting Computer Images

### Connecting to a computer using the RS-232C Port

When the RS-232C port on the projector is connected to a computer with an RS-232C serial control cable (cross type, sold separately), the computer can be used to control the projector and check the status of the projector. See pages 68, 69 and 70 for details.

Connect an RS-232C serial control cable (cross type, sold separately) to the serial port on the computer. See page 67 for recommended connection of an RS-232C serial control cable.

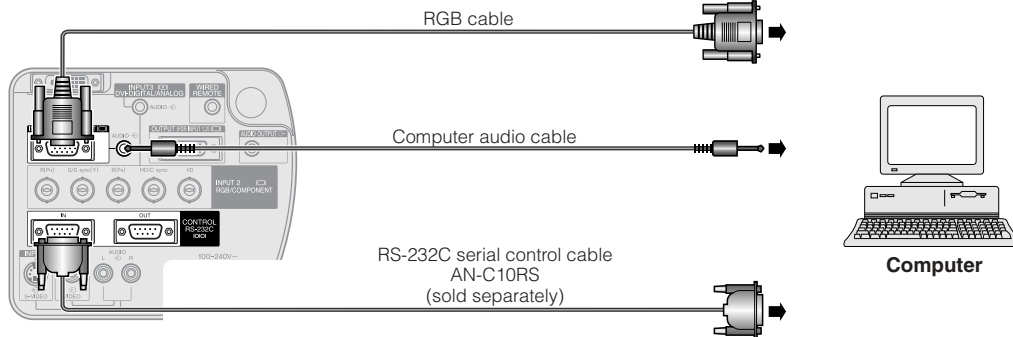

#### CAUTION

- Do not connect or disconnect an RS-232C cable to or from the computer while it is on. This may damage your computer.

#### NOTE

- The wireless mouse or RS-232C function may not operate if your computer port is not correctly set up. Please refer to the operation manual of the computer for details on setting up/installing the correct mouse driver.
- A Macintosh adaptor may be required for use with some Macintosh computers. Contact your nearest Sharp Authorized LCD Projector Dealer or Service Center.

### Connecting to a computer using the direct digital input port

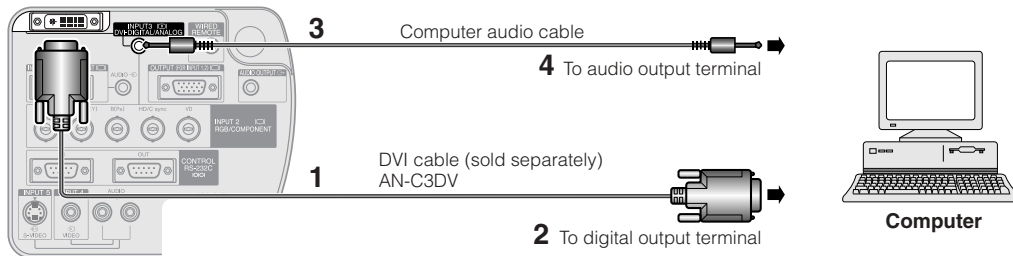

- Connect one end of the DVI cable to the INPUT 3 port on the projector.
- Connect the other end to the corresponding terminal on a computer.
- To use the built-in audio system, connect one end of the supplied computer audio cable to the AUDIO INPUT 2/3 terminal on the projector.
- Connect the other end to the audio output terminal on the computer.

#### NOTE

- This DVI port is DVI version 1.0 compatible. Therefore when the signal is input from copy guard system compatible (DVI version 2.0) equipment, no signal will be received.
- The analog RGB signal inputs on the DVI port are only compatible with separate sync.





## Watching Video Images

### Connecting to a VCR, laser disc player and other audiovisual equipment using the standard video Input

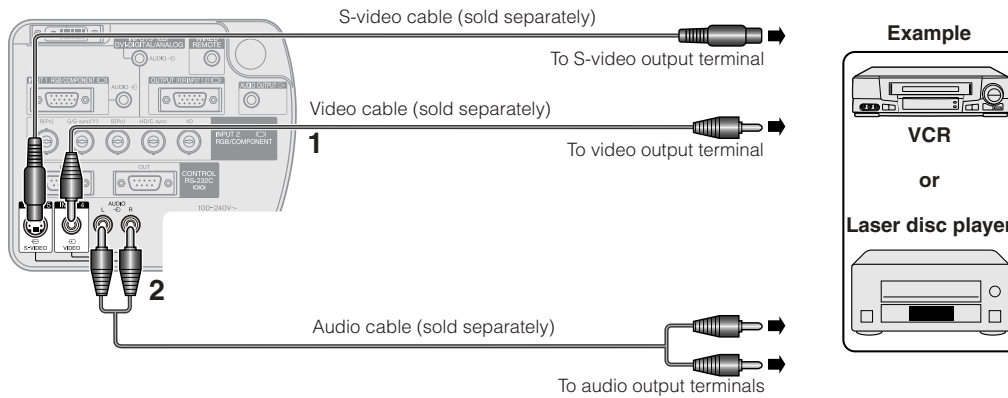

- 1** Connect the yellow RCA connectors to the corresponding yellow VIDEO INPUT 4 terminal on the projector and the Video output terminal on the video source.
- 2** To use the built-in audio system, connect the red and white RCA connectors to the corresponding red and white AUDIO INPUT 4/5 terminals on the projector and the Audio output terminals on the video source.

The S-VIDEO INPUT 5 terminal uses a video signal system in which the picture is separated into a color and a luminance signal to realize a higher-quality image.

**NOTE**

- For higher quality video, you may use the S-VIDEO INPUT 5 terminal on the projector. S-video cable is sold separately.
- If your video equipment does not have an S-video output terminal, use a composite video cable.

**CAUTION**

- Always turn off the projector before connecting to video equipment, in order to protect both the projector and the equipment being connected.



## Watching Component Video Images

### Connecting to a DVD video player, DTV\* decoder and other component video equipment using the 5 BNC Input

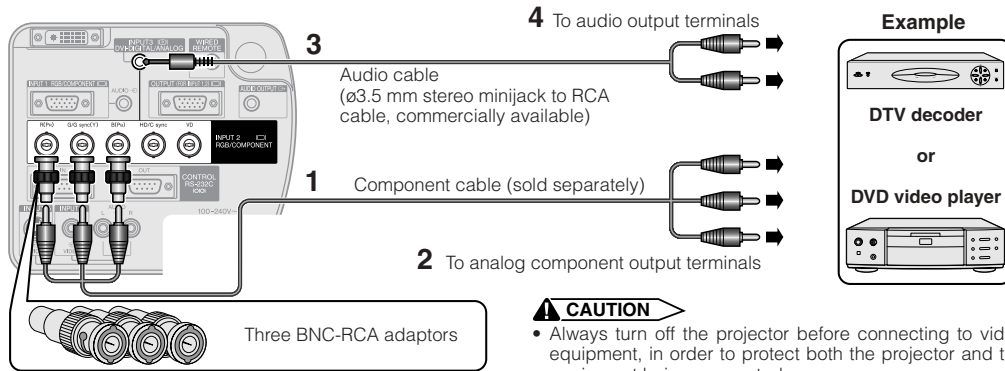

- 1 Connect each BNC connector of a component cable to the corresponding BNC INPUT 2 terminals on the projector.
- 2 Connect the other end of the cable to the corresponding terminals on a DVD video player or DTV decoder.
- 3 To use the built-in audio system, connect one end of an audio cable (sold separately) to the AUDIO INPUT 2/3 terminal on the projector.
- 4 Connect the other end to the audio output terminal on the DVD video player or DTV decoder.

#### NOTE

- BNC-RCA adaptors are included for use with RCA type cables and sources.
- A ø3.5 mm stereo minijack to stereo RCA audio cable adaptor may be necessary.

When connecting this projector to a DVD video player or DTV decoder, select "Component" for "Signal Type" on the GUI menu. (See page 41.)

\*DTV is the umbrella term used to describe the new digital television system in the United States.

## For Better Sound

### Connecting to an amplifier and other audio components

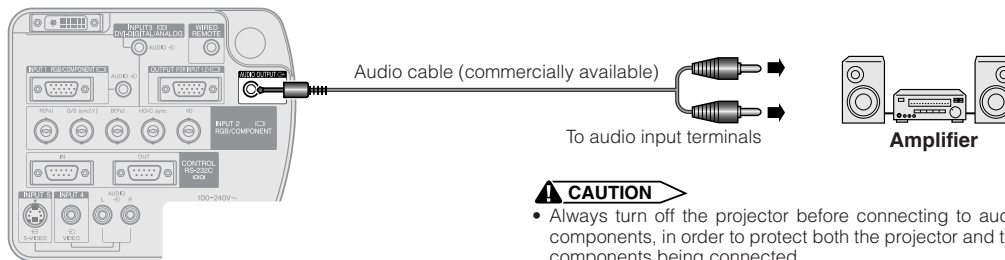

#### NOTE

- By using external audio components, the volume can be amplified for better sound.
- The AUDIO OUTPUT terminal allow you to output audio to audio components from the selected AUDIO INPUT 1 to 5 terminals connected to audiovisual equipment.
- For details on Variable Audio Output (VAO) and Fixed Audio Output (FAO), see page 46.
- A ø3.5 mm stereo minijack to stereo RCA audio cable adaptor may be necessary.





## Power ON/OFF

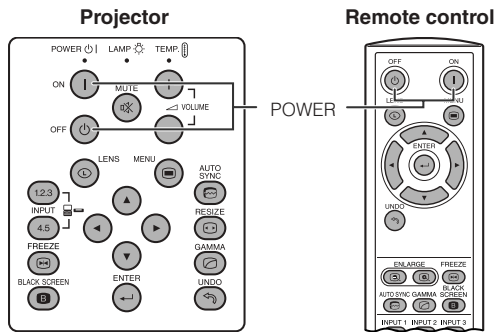

### Press **POWER ON**.

- The blinking green LAMP REPLACEMENT indicator shows that the lamp is warming up. Wait until the indicator stops blinking before operating the projector.
- If the power is turned off and then immediately turned on again, it may take a short while before the lamp turns on.

#### **NOTE**

- After the projector is unpacked and turned on for the first time, a slight odor may be emitted from the exhaust vent. This odor will soon disappear with use.

When the power is on, the LAMP REPLACEMENT indicator lights, indicating the status of the lamp.

**Green:** Lamp is ready.

**Green blinking:** Warming up.

**Red:** Change the lamp.

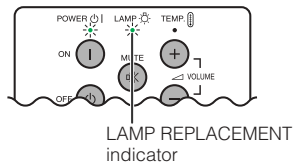

### On-screen Display



### Press **POWER OFF**.

Press **POWER OFF** again while the message is displayed to turn off the power.

#### **NOTE**

- If you accidentally pressed **POWER OFF** and do not want to turn off the power, wait until the power off screen disappears.
- When the power is turned off, the POWER indicator will light up red and the cooling fan will run for about 90 seconds. The projector will then enter standby mode.
- Wait until the cooling fan stops before disconnecting the power cord.
- The power can be turned on again by pressing **POWER ON**. When the power is turned on, the POWER indicator and the LAMP REPLACEMENT indicator light green.
- The POWER indicator flashes if the bottom filter cover is not securely installed.

#### **WARNING:**

The cooling fan in this projector continues to run for about 90 seconds after the projector is turned off. During normal operation, when turning the power off always use the **POWER OFF** button on the projector or on the remote control. Ensure the cooling fan has stopped before disconnecting the power cord. **DURING NORMAL OPERATION, NEVER TURN THE PROJECTOR OFF BY DISCONNECTING THE POWER CORD. FAILURE TO OBSERVE THIS WILL RESULT IN PREMATURE LAMP FAILURE.**





## Setting Up the Screen

### Using the Adjustment Feet

Setup & Connections

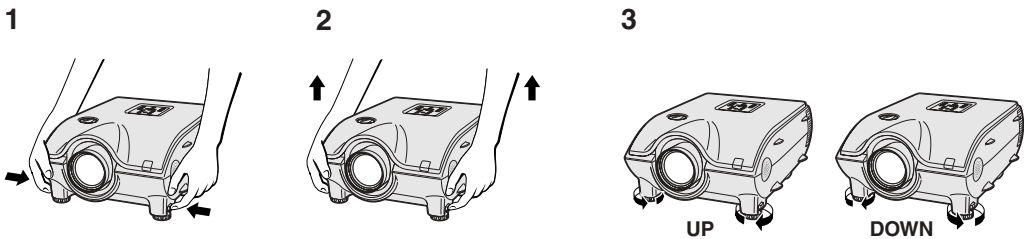

1 Press foot releases.

2 Adjust height of projector and remove hands from foot releases.

3 Rotate feet to make minor changes.

**NOTE**

- The projector is adjustable up to approximately 10° from the standard position.
- When the height of the projector is adjusted, the image may become distorted (keystoned), depending on the relative positions of the projector and the screen.

**CAUTION**

- Do not press the foot releases when the adjustment feet are extended without firmly holding the projector.
- Do not hold the lens when lifting or lowering the projector.
- When lowering the projector, be careful not to get your fingers caught in the area between the adjustment feet and the projector.

### Using the Lens Shift

The picture can be adjusted within the shift range of the lens by rotating the dial on the top of the projector.

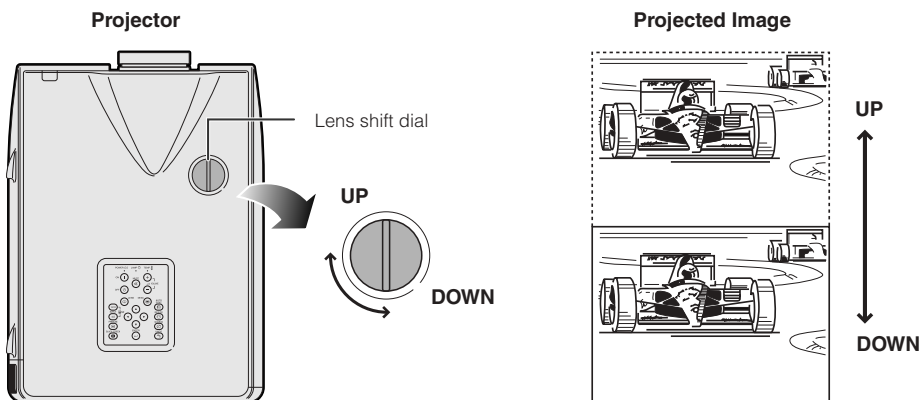

**NOTE**

- The lens shift dial is set to the upper most position at the factory. Remember to adjust lower by turning the dial when operating the projector.
- The lens shift dial has two points to help orient the position. The center of the lens and bottom of the screen are the same height (10:0) and the center of the lens and center of the screen are the same height (5:5). When either position is reached by turning the dial, you will notice a slight latching feeling.
- Do not forcefully turn the lens shift dial beyond the 10:0 and 5:5 orientating positions; doing so may result in damaging the equipment.
- When the AN-P9MX of optional lens is attached, lens shift cannot be used.





## LENS Button

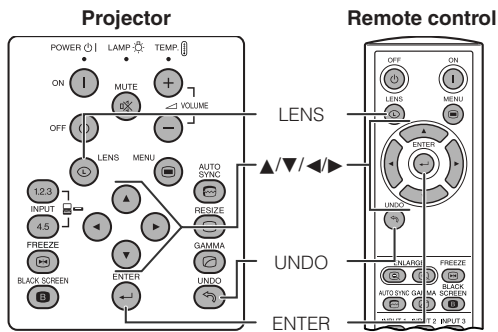

### Digital Image Adjustments

This function can be used to adjust the focus, zoom, keystone, v-size and digital shift settings.

- 1 Press **LENS** to select mode. Each time **LENS** is pressed, the screen changes as shown on the left.
- 2 Press **ENTER** to display test pattern.
- 3 Press **▲/▼/◀/▶** to make adjustments.
- 4 a. Press **LENS** until normal screen appears.  
b. To reset the “KEYSTONE”, “V-SIZE” and “DIGITAL SHIFT” setting, press **UNDO**.

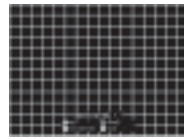

Setup & Connections



On-screen Display  
(Example: 4:3  
NORMAL image)



On-screen Display  
(Example: 16:9  
WIDE image)



#### NOTE

- Do not touch the lens when adjusting the focus or zoom.

#### Keystone setting

Trapezoidal distortion is caused when the projector image is positioned away from the center axis of the screen. This function allows you to correct the keystone effect for excellent picture quality.

#### NOTE

- Straight lines and the edges of the displayed image may appear jagged, when adjusting the KEYSTONE setting.

#### V-size setting

During keystone correction an error can occur in the aspect ratio depending on the amount of lens shift. Use the V-SIZE fine-tuning function to correct this error.

#### NOTE

- V-SIZE is only displayed and can only be adjusted when performing KEYSTONE correction.

#### Digital shift setting

For easier viewing, this function shifts the image projected on the screen up or down eliminating either the upper or lower black band found in 16:9 and other wide aspect ratios.

#### NOTE

- Digital shift function only works with BORDER, STRETCH or SMART STRETCH of VIDEO and DTV inputs. (See page 35 for details.) The DIGITAL SHIFT screen is not displayed when projecting images other than WIDE.

#### Digital Shift



Press ▲.

or



Press ▼.





## Adjusting the Projection Distance

Position the projector perpendicular to the screen with all feet flat and level to achieve an optimal image. Move the projector forward or backward if the edges of the image are distorted.

### NOTE

- The projector lens should be centered in the middle of the screen. If the lens center is not perpendicular to the screen, the image will be distorted, making viewing difficult.
- Position the screen so that it is not in direct sunlight or room light. Light falling directly onto the screen washes out colors, making viewing difficult. Close the curtains and dim the lights when setting up the screen in a sunny or bright room.
- A polarizing screen cannot be used with this projector.

Two optional lenses from Sharp are also available for specialized application. Please see your local Sharp Authorized LCD Projector Dealer to details on all the lenses. (Refer to the lens operation manual when attaching a lens.) Also, be sure to have service personnel install the AN-P9MX and AN-P48EZ optional lenses.

## Throw Distance

The graph below is for 100 inches (254 cm) screen with 4:3 normal mode.

### Screen

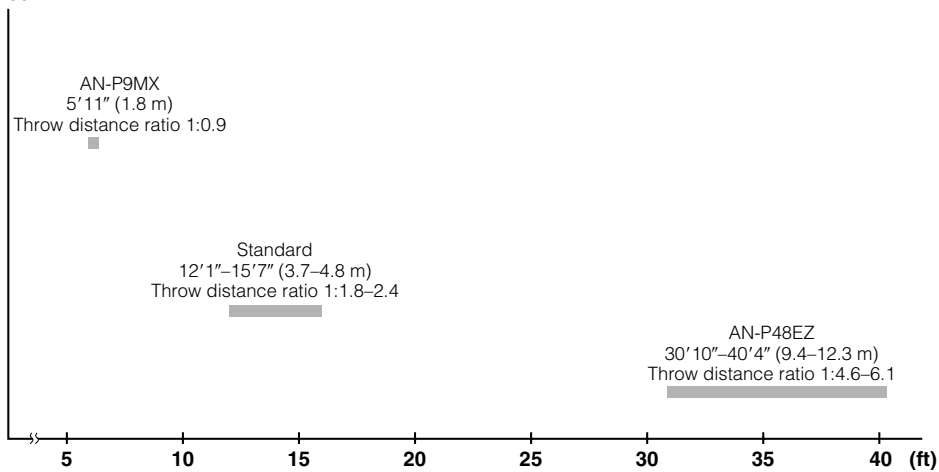

## Standard Setup (Front Projection)

Place the projector at the required distance from the screen according to the desired picture size. (See pages 27 to 29.)

### NOTE

- Two optional lenses from Sharp are available for specialized application. Please see your local Sharp Authorized LCD Projector Dealer for details on all the lenses.

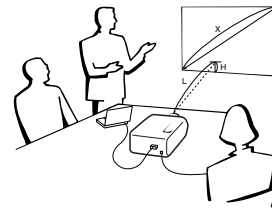

### NORMAL Mode (4:3)

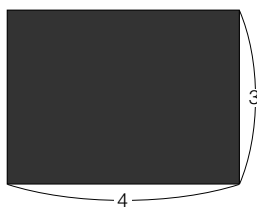

■ : Screen size and Picture size (4:3)

### STRETCH Mode (16:9)

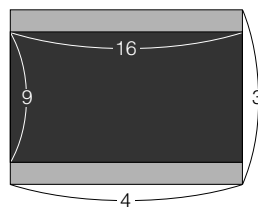

■ : Screen size and Picture size (16:9)  
■ : Signal mask area





## Adjusting the Projection Distance

### Upper and Lower Lens Shift Position

- This projector is equipped with a lens shift function that lets you adjust the projection height.
- Adjust to match the setup configuration.

Screen size: 100 inches (254 cm)  
 STRETCH Mode: 16:9  
 Standard Lens as an example

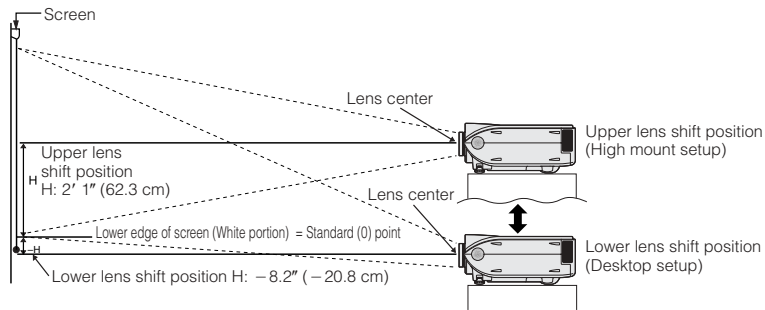

### Upper and Lower Lens Shift Position (Ceiling Mount)

When the projector is in the inverted position, use the upper edge of the screen as the base line, and exchange the lower and upper lens shift values.

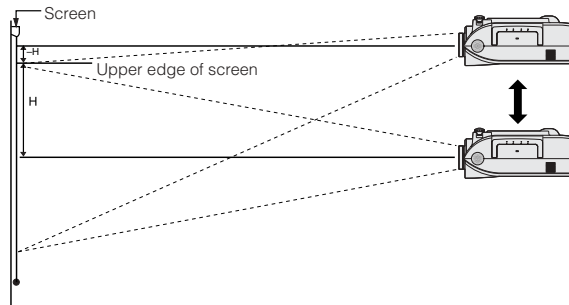

#### NOTE

- Optimal image quality is produced with the projector positioned perpendicular to the screen with all feet flat and level. Tilting or angling the projector will reduce the effectiveness of the lens shift function.





## Adjusting the Projection Distance

### Standard Lens Throw distance ratio 1:1.8 to 2.4

#### NORMAL Mode (4:3)

Screen size (4:3) (X)			Projection distance (L)		Lens center to the lower edge of the screen (H)	
Diag.	Width	Height	Maximum (l <sub>1</sub> )	Minimum (l <sub>2</sub> )	Upper lens shift position (h <sub>1</sub> )	Lower lens shift position (h <sub>2</sub> )
300"	240"	180"	48' 2" (14.7 m)	37' 4" (11.4 m)	7' 6" (228.6 cm)	0.0" (0.0 cm)
200"	160"	120"	32' 2" (9.8 m)	24' 6" (7.5 m)	5' 0" (152.4 cm)	0.0" (0.0 cm)
150"	120"	90"	24' 0" (7.3 m)	18' 4" (5.6 m)	3' 9" (114.3 cm)	0.0" (0.0 cm)
100"	80"	60"	15' 7" (4.8 m)	12' 1" (3.7 m)	2' 6" (76.2 cm)	0.0" (0.0 cm)
84"	67"	50"	13' 1" (4.0 m)	10' 2" (3.1 m)	2' 1" (64.0 cm)	0.0" (0.0 cm)
72"	58"	43"	11' 2" (3.4 m)	8' 5" (2.6 m)	1' 10" (54.9 cm)	0.0" (0.0 cm)
60"	48"	36"	9' 2" (2.8 m)	7' 2" (2.2 m)	1' 6" (45.7 cm)	0.0" (0.0 cm)
40"	32"	24"	6' 2" (1.9 m)	4' 6" (1.4 m)	1' 0" (30.5 cm)	0.0" (0.0 cm)

The formula for screen size and projection distance

$$l_1 (\text{Max.}) = (0.0495x - 0.1302) \times 3.28$$

$$l_2 (\text{Min.}) = (0.0383x - 0.1153) \times 3.28$$

$$h_1 (\text{Upper}) = 0.3x$$

$$h_2 (\text{Lower}) = 0$$

x: Screen size (diag.) (X) (inches)

l: Projection distance (L) (feet)

h: Lens center to the lower edge of the screen (H) (inches)

#### STRETCH Mode (16:9)

Screen size (4:3) (X)			Projection distance (L)		Lens center to the lower edge of the screen (H)	
Diag.	Width	Height	Maximum (l <sub>1</sub> )	Minimum (l <sub>2</sub> )	Upper lens shift position (h <sub>1</sub> )	Lower lens shift position (h <sub>2</sub> )
300"	261"	147"	52' 5" (16.0 m)	40' 7" (12.4 m)	6' 2" (186.8 cm)	-2' 1" (-62.3 cm)
200"	174"	98"	34' 8" (10.6 m)	26' 9" (8.2 m)	4' 1" (124.5 cm)	-1' 4" (-41.5 cm)
150"	131"	74"	26' 2" (8.0 m)	20' 3" (6.2 m)	3' 1" (93.4 cm)	-1' 0" (-31.1 cm)
133"	116"	65"	23' 3" (7.1 m)	17' 7" (5.4 m)	2' 9" (82.8 cm)	-10.9" (-27.6 cm)
106"	92"	52"	18' 4" (5.6 m)	14' 1" (4.3 m)	2' 2" (66.0 cm)	-8.7" (-22.0 cm)
100"	87"	49"	17' 4" (5.3 m)	13' 5" (4.1 m)	2' 1" (62.3 cm)	-8.2" (-20.8 cm)
92"	80"	45"	15' 7" (4.8 m)	12' 1" (3.7 m)	1' 11" (57.3 cm)	-7.5" (-19.1 cm)
84"	73"	41"	14' 4" (4.4 m)	11' 2" (3.4 m)	1' 9" (52.3 cm)	-6.9" (-17.4 cm)
72"	63"	35"	12' 5" (3.8 m)	9' 5" (2.9 m)	1' 6" (44.8 cm)	-5.9" (-14.9 cm)
60"	52"	29"	10' 2" (3.1 m)	7' 9" (2.4 m)	1' 3" (37.4 cm)	-4.9" (-12.5 cm)
40"	35"	20"	6' 6" (2.0 m)	5' 2" (1.6 m)	9.8" (24.9 cm)	-3.3" (-8.3 cm)

The formula for screen size and projection distance

$$l_1 (\text{Max.}) = (0.0538x - 0.1242) \times 3.28$$

$$l_2 (\text{Min.}) = (0.0417x - 0.1135) \times 3.28$$

$$h_1 (\text{Upper}) = 0.2451x$$

$$h_2 (\text{Lower}) = -0.0817x$$

x: Screen size (diag.) (X) (inches)

l: Projection distance (L) (feet)

h: Lens center to the lower edge of the screen (H) (inches)

#### NOTE

- There is an error of  $\pm 3\%$  in the formula above.
- Values with a minus (-) sign indicate the distance of the lens center below the bottom of the screen.



## Adjusting the Projection Distance

### AN-P9MX Throw distance ratio 1:0.9

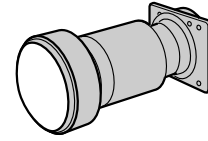

#### NORMAL Mode (4:3)

Screen size (4:3) (X)			Projection distance (L)	Lens center to the lower edge of the screen (H)
Diag.	Width	Height		
300"	240"	180"	18' 1" (5.5 m)	7' 6" (228.6 cm)
200"	160"	120"	12' 0" (3.7 m)	5' 0" (152.4 cm)
150"	120"	90"	9' 0" (2.7 m)	3' 9" (114.3 cm)
100"	80"	60"	5' 11" (1.8 m)	2' 6" (76.2 cm)
84"	67"	50"	4' 11" (1.5 m)	2' 1" (64.0 cm)
72"	58"	43"	4' 2" (1.3 m)	1' 10" (54.9 cm)
60"	48"	36"	3' 6" (1.1 m)	1' 6" (45.7 cm)
40"	32"	24"	2' 3" (0.7 m)	1' 0" (30.5 cm)

The formula for screen size and projection distance

$$l = (0.0186x - 0.0563) \times 3.28$$

$$h = 0.3x$$

x: Screen size (diag.) (X) (inches)

l: Projection distance (L) (feet)

h: Lens center to the lower edge of the screen (H) (inches)

#### STRETCH Mode (16:9)

Screen size (4:3) (X)			Projection distance (L)	Lens center to the lower edge of the screen (H)
Diag.	Width	Height		
300"	261"	147"	19' 9" (6.0 m)	6' 2" (186.8 cm)
200"	174"	98"	13' 2" (4.0 m)	4' 1" (124.5 cm)
150"	131"	74"	9' 10" (3.0 m)	3' 1" (93.4 cm)
133"	116"	65"	8' 8" (2.6 m)	2' 9" (82.8 cm)
106"	92"	52"	6' 10" (2.1 m)	2' 2" (66.0 cm)
100"	87"	49"	6' 6" (2.0 m)	2' 1" (62.3 cm)
92"	80"	45"	5' 11" (1.8 m)	1' 11" (57.3 cm)
84"	73"	41"	5' 4" (1.6 m)	1' 9" (52.3 cm)
72"	63"	35"	4' 8" (1.4 m)	1' 6" (44.8 cm)
60"	52"	29"	3' 9" (1.2 m)	1' 3" (37.4 cm)
40"	35"	20"	2' 6" (0.8 m)	10.0" (24.9 cm)

The formula for screen size and projection distance

$$l = (0.0203x - 0.0579) \times 3.28$$

$$h = 0.2451x$$

x: Screen size (diag.) (X) (inches)

l: Projection distance (L) (feet)

h: Lens center to the lower edge of the screen (H) (inches)

#### NOTE

- There is an error of  $\pm 3\%$  in the formula above.
- Values with a minus ( - ) sign indicate the distance of the lens center below the bottom of the screen.



## Adjusting the Projection Distance

### AN-P48EZ Throw distance ratio 1:4.6 to 6.1

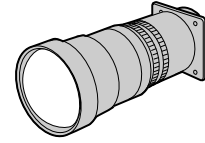

#### NORMAL Mode (4:3)

Screen size (4:3) (X)			Projection distance (L)		Lens center to the lower edge of the screen (H)	
Diag.	Width	Height	Maximum (L)	Minimum (L)	Upper lens shift position (h <sub>1</sub> )	Lower lens shift position (h <sub>2</sub> )
300"	240"	180"	119' 9" (36.5 m)	91' 6" (27.9 m)	7' 6" (228.6 cm)	0.0" (0.0 cm)
200"	160"	120"	80' 1" (24.4 m)	61' 4" (18.7 m)	5' 0" (152.4 cm)	0.0" (0.0 cm)
150"	120"	90"	60' 0" (18.3 m)	45' 11" (14.0 m)	3' 9" (114.3 cm)	0.0" (0.0 cm)
100"	80"	60"	40' 4" (12.3 m)	30' 10" (9.4 m)	2' 6" (76.2 cm)	0.0" (0.0 cm)
84"	67"	50"	33' 10" (10.3 m)	25' 11" (7.9 m)	2' 1" (64.0 cm)	0.0" (0.0 cm)
72"	58"	43"	29' 2" (8.9 m)	22' 4" (6.8 m)	1' 10" (54.9 cm)	0.0" (0.0 cm)
60"	48"	36"	24' 3" (7.4 m)	18' 8" (5.7 m)	1' 6" (45.7 cm)	0.0" (0.0 cm)

The formula for screen size and projection distance

$$l_1 (\text{Max.}) = (0.1214x + 0.1272) \times 3.28$$

$$l_2 (\text{Min.}) = (0.0927x + 0.1233) \times 3.28$$

$$h_1 (\text{Upper}) = 0.3x$$

$$h_2 (\text{Lower}) = 0$$

x: Screen size (diag.) (X) (inches)

l: Projection distance (L) (feet)

h: Lens center to the lower edge of the screen (H) (inches)

#### STRETCH Mode (16:9)

Screen size (4:3) (X)			Projection distance (L)		Lens center to the lower edge of the screen (H)	
Diag.	Width	Height	Maximum (L)	Minimum (L)	Upper lens shift position (h <sub>1</sub> )	Lower lens shift position (h <sub>2</sub> )
300"	261"	147"	130' 7" (39.8 m)	99' 9" (30.4 m)	6' 2" (186.8 cm)	-2' 1" (-62.3 cm)
200"	174"	98"	87' 3" (26.6 m)	66' 7" (20.3 m)	4' 1" (124.5 cm)	-1' 4" (-41.5 cm)
150"	131"	74"	65' 7" (20.0 m)	50' 2" (15.3 m)	3' 1" (93.4 cm)	-1' 0" (-31.1 cm)
133"	116"	65"	58' 1" (17.7 m)	44' 7" (13.6 m)	2' 9" (82.8 cm)	-10.9" (-27.6 cm)
106"	92"	52"	46' 3" (14.1 m)	35' 5" (10.8 m)	2' 2" (66.0 cm)	-8.7" (-22.0 cm)
100"	87"	49"	44' 0" (13.4 m)	33' 6" (10.2 m)	2' 1" (62.3 cm)	-8.2" (-20.8 cm)
92"	80"	45"	40' 4" (12.3 m)	30' 10" (9.4 m)	1' 11" (57.3 cm)	-7.5" (-19.1 cm)
84"	73"	41"	36' 9" (11.2 m)	28' 3" (8.6 m)	1' 9" (52.3 cm)	-6.9" (-17.4 cm)
72"	63"	35"	31' 10" (9.7 m)	24' 3" (7.4 m)	1' 6" (44.8 cm)	-5.9" (-14.9 cm)
60"	52"	29"	26' 7" (8.1 m)	20' 4" (6.2 m)	1' 3" (37.4 cm)	-4.9" (-12.5 cm)

The formula for screen size and projection distance

$$l_1 (\text{Max.}) = (0.1323x + 0.1272) \times 3.28$$

$$l_2 (\text{Min.}) = (0.101x + 0.1233) \times 3.28$$

$$h_1 (\text{Upper}) = 0.2451x$$

$$h_2 (\text{Lower}) = -0.0817x$$

x: Screen size (diag.) (X) (inches)

l: Projection distance (L) (feet)

h: Lens center to the lower edge of the screen (H) (inches)

#### NOTE

- There is an error of  $\pm 3\%$  in the formula above.
- Values with a minus (-) sign indicate the distance of the lens center below the bottom of the screen.





## Image Projection



### Rear Projection

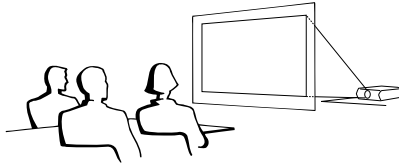

- Place a translucent screen between the projector and the audience.
- Use the projector's menu system to reverse the projected image. (See page 51 for use of this function.)

#### NOTE

- Optimal image quality can be achieved when the projector is positioned perpendicular to the screen with all feet flat and level.



### Projection Using a Mirror

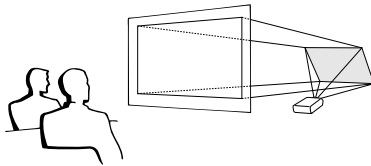

- When the distance between the projector and screen is not sufficient for normal rear projection, you can use a mirror to reflect the image onto the screen.
- Place a mirror (normal flat type) in front of the lens.
- Project the normal image onto the mirror.
- The image reflected from the mirror is projected onto the translucent screen.

#### CAUTION

- When using a mirror, be sure to carefully position both the projector and the mirror so the light does not shine into the eyes of the audience.



### Ceiling-mount Projection

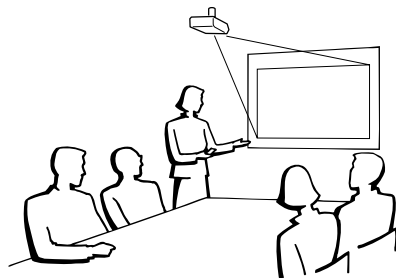

- It is recommended that you use the optional Sharp ceiling-mount bracket for this installation.
- Before mounting the projector, contact your nearest Sharp Authorized LCD Projector Dealer or Service Center to obtain the recommended ceiling-mount bracket (sold separately). (AN-XGCM61 ceiling-mount bracket and its AN-EP101AP extension tube (for U.S.A.), or AN-NV6T ceiling-mount bracket and its AN-TK201/AN-TK202 extension tubes (for countries other than the U.S.A.))
- When the projector is in the inverted position, use the upper edge of the screen as the base line.
- Use the projector's menu system to select the appropriate projection mode. (See page 51 for use of this function.)





## Using the Operation Buttons



### Selecting the Input Signal Source

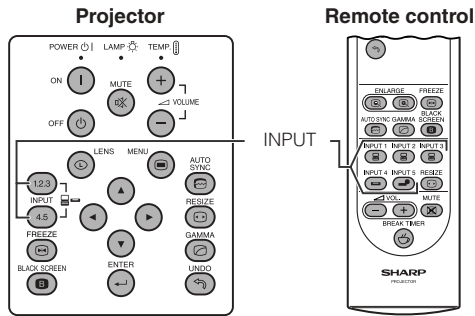

Press **INPUT 1.2.3** or **INPUT 4.5** on the projector or **INPUT (1, 2, 3, 4 or 5)** on the remote control to change the mode.

#### NOTE

- When no signal is received, "NO SIGNAL" will be displayed.
- When a signal that the projector is not preset to receive is received, "NOT REG." will be displayed.

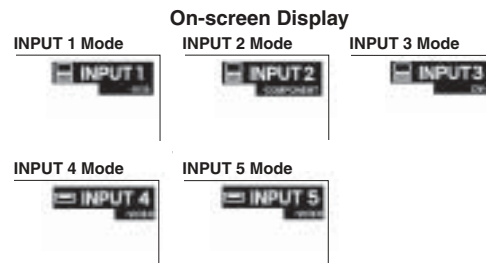

### Adjusting the Volume

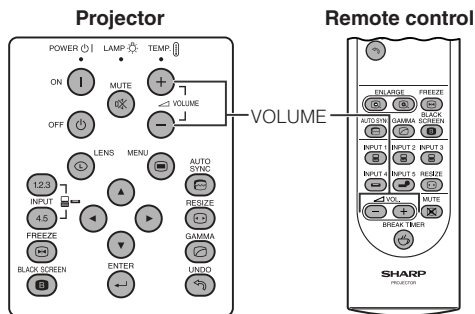

Press **VOLUME -/+** to adjust the volume.

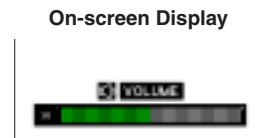

### Muting the Sound

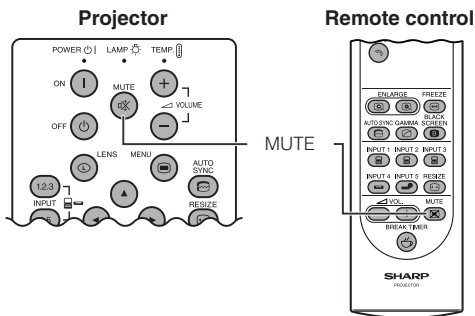

Press **MUTE** to temporarily turn off the sound. Press **MUTE** again to turn the sound back on.





## Superimposing a Black Screen

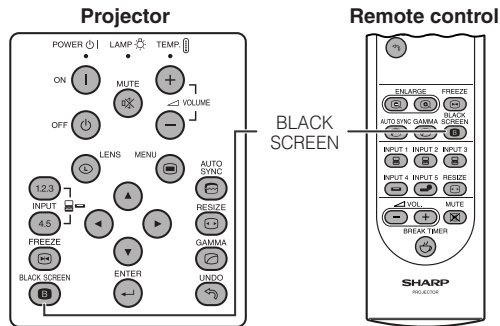

This function can be used to superimpose a black screen over the projected image.

### Blacking out the Projected Image

Press **BLACK SCREEN**. The screen turns black and "BLACK SCREEN" is displayed on the screen. To return to the original projected image, press **BLACK SCREEN** again.

### Projected Image

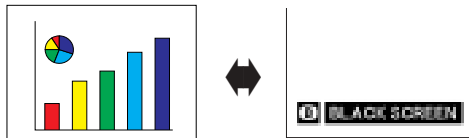

## Displaying a Still Image

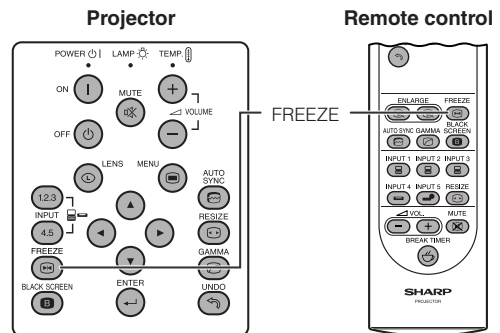

This function allows you to instantly freeze a moving image. This is useful when you want to display a still image from a computer or video, giving you more time to explain the image to the audience. You can also use this function to display a still image from a computer while you make preparations for the next computer images to be presented.

- 1 Press **FREEZE** to freeze the image.
- 2 Press **FREEZE** again to return to the moving image.

### On-screen Display





## Magnifying a Specific Portion of an Image

### Remote control

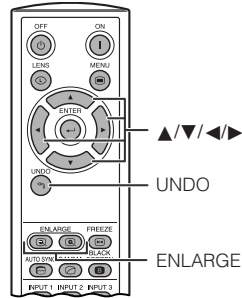

This function allows you to magnify a specific portion of an image. This is useful when you want to display a detailed portion of the image.

**1** Press **ENLARGE** (🔍) to zoom in. (Press **ENLARGE** (🔍) to zoom out.)

× 1 ↔ × 4 ↔ × 9 ↔ × 16 ↔ × 36 ↔ × 64

**2** To return to × 1, press **UNDO**.

### NOTE

- If you press **ENLARGE** (🔍) when the zoom is set to × 1, no change will occur. And if you press **ENLARGE** (🔍) when the zoom is set to × 64, no change will occur.
- If the input signal is changed during digital image magnification, the image will return to × 1. The input signal is changed
  - (a) when **INPUT 1, 2, 3, 4** or **5** is pressed,
  - (b) when the input signal is interrupted, or
  - (c) when the input resolution and refresh rate changes.



### On-screen Display

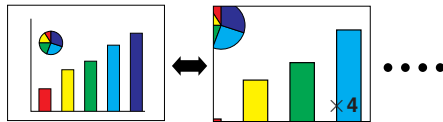

Press **ENLARGE** (🔍) to zoom in.

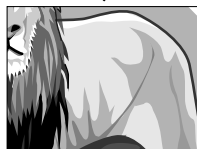

Press ▲/▼/◀/▶.



### Pan Around the Screen

Enlarging the screen image and move it around.

When the image is magnified, press ▲/▼/◀/▶ to pan and scan around the image.



## Displaying and Setting the Break Timer

### Remote control

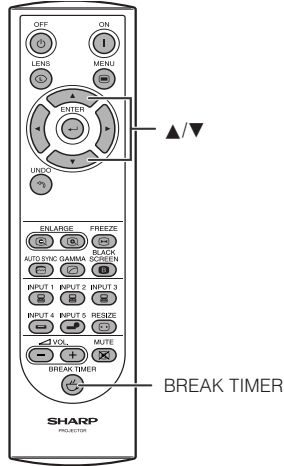

This function can be used to show the remaining time for break during meeting.

**1** Press **BREAK TIMER**. The timer starts to count down from 5 minutes.

- You can set the Break Timer 1 to 60 minutes with ▲/▼. The timer starts to count down as soon as ▲/▼ is pressed.

**2** Press **BREAK TIMER** to cancel the Break Timer.

#### NOTE

- The Break Timer is displayed against the background image selected in "Selecting a Startup Image." (See page 49)

### On-screen Display



## Computer Image Adjustments using AUTO SYNC

### Projector

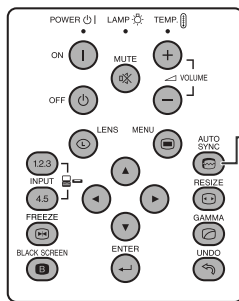

### Remote control

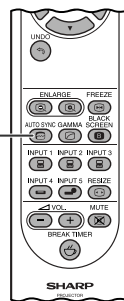

This function can be used to automatically adjust a computer image.

Press **AUTO SYNC**. During Auto Sync adjustment, the On-screen Display changes as shown on the bottom left.

- See page 45 "Auto Sync Adjustment" for setting the Auto Sync.

#### NOTE

- Auto Sync adjustment may take some time to complete, depending on the image of the computer connected to the projector.

### On-screen Display

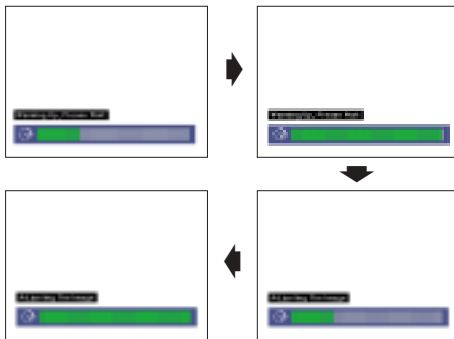



## Adjusting the Picture Aspect Ratio

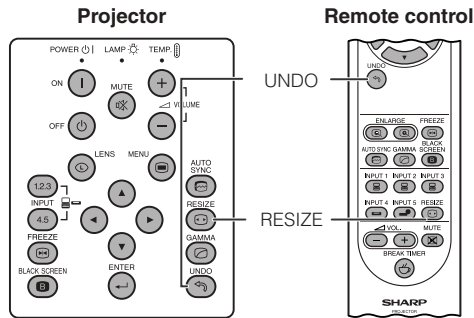

This function allows you to modify or customize the picture display mode to enhance the input image. Depending on the input signal, you can choose NORMAL, FULL, DOT BY DOT, BORDER, STRETCH or SMART STRETCH image.

- 1 Press **RESIZE**. Each time **RESIZE** is pressed, the picture mode changes as shown below.
- 2 To return to the standard image, press **UNDO** while "RESIZE" is displayed on the screen.



### COMPUTER

		NORMAL	FULL	DOT BY DOT
4:3 aspect ratio	SVGA (800 × 600)	1024 × 768	—	800 × 600
	XGA (1024 × 768)	1024 × 768	—	—
	SXGA (1280 × 960)	1024 × 768	—	1280 × 960
	UXGA (1600 × 1200)	1024 × 768	—	1600 × 1200
Other aspect ratios	SXGA (1280 × 1024)	960 × 768	1024 × 768	1280 × 1024

- "NORMAL" is fixed when XGA (1024 × 768) signals are entered.

Input Signal		Output screen image		
		NORMAL	FULL	DOT BY DOT
Resolution lower than XGA	 4:3 aspect ratio	 Projects a full screen image while maintaining the aspect ratio.	 Projects a full screen image while ignoring the aspect ratio.	 Projects the original resolution signal of the image.
		 4:3 aspect ratio	—	—
Resolution higher than XGA	 4:3 aspect ratio	 4:3 aspect ratio	 —	 —
SXGA (1280 × 1024)	 4:3 aspect ratio	 4:3 aspect ratio	 —	 —





## Adjusting the Picture Aspect Ratio

### VIDEO

		NORMAL	BORDER	STRETCH	SMART STRETCH
480I, 480P, 580I, 580P, NTSC, PAL, SECAM	4:3 aspect ratio Letter box, squeeze	1024 × 768	768 × 576*	1024 × 576*	1024 × 576*
	16:9 aspect ratio	—	—		
720P, 1035I, 1080I		—	—	—	—

- "STRETCH" is fixed when 720P, 1035I or 1080I signals are entered.
- \* The Digital Shift function can be used with these images.

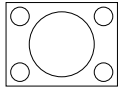
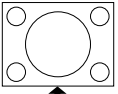
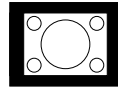
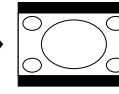
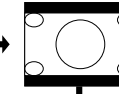
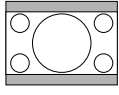
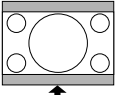
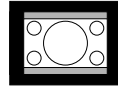
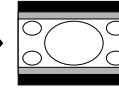
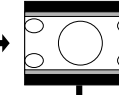
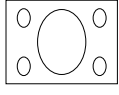
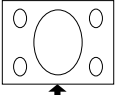
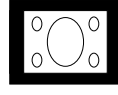
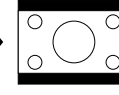
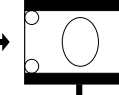
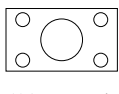
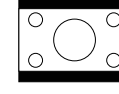
Input Signal		Output screen image			
		<b>NORMAL</b> Projects a full screen image.	<b>BORDER</b> Projects 4:3 image fully in STRETCH (the following column) image.	<b>STRETCH</b> Projects 16:9 image evenly over entire screen (top/bottom black bands).	<b>SMART STRETCH</b> Projects the image fully in a 16:9 screen by enlarging only the surrounding areas while keeping the aspect ratio in the middle part of the image at 4:3.
480I, 480P, 580I, 580P, NTSC, PAL, SECAM	4:3 aspect ratio 				
	Letter box 				
	Squeeze 				
720P, 1035I, 1080I	16:9 aspect ratio 	—	—		—





# Gamma Correction Function

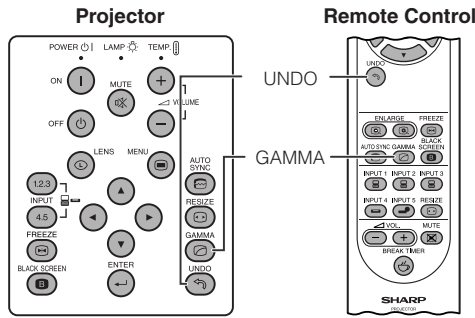

- Gamma is an image quality enhancement function that offers a richer image by brightening the darker portions of the image without altering the brightness of the brighter portions.
- Four gamma settings are available to allow for differences in the images displayed and in the brightness of the room.
- When you are displaying images with frequent, dark scenes, such as a film or concert, or when you are displaying images in a bright room, this feature makes the dark scenes easier to see and gives the impression of greater depth in the image.

## Gamma Modes

Selected Mode	Gamma mode
<b>STANDARD</b>	Standard picture without gamma correction.
<b>PRESENTATION</b>	Brightens darker portions of image for more enhanced presentations.
<b>CINEMA</b>	Gives greater depth to darker portions of image for a more exciting theater experience.
<b>CUSTOM</b>	Allows you to adjust gamma value using Sharp Advanced Presentation Software.



### On-screen Display (Example: RGB mode)

**STANDARD**



**PRESENTATION**



**CINEMA**



**CUSTOM**



- 1 Press **GAMMA**. Each time **GAMMA** is pressed, the gamma level toggles as shown on the left.
- 2 To return to the standard image, press **UNDO** while "GAMMA" is displayed on the screen.

### NOTE

- The **CUSTOM** setting of VIDEO mode optimizes the video source to reproduce the image more beautifully. It darkens bright portions of the image and gives greater depth to darker portions of the image. Select **CUSTOM** as your default setting if you prefer a smooth textured image to a sharply contrasted one.
- **STANDARD** and **CINEMA** settings of VIDEO mode (except **COMPONENT 480P/580P/720P/1035I/1080I**) incorporate a **DYNAMIC GAMMA** function for optimizing **GAMMA** correction frame by frame in real time, thus providing a more beautiful image.
- **PRESENTATION** settings are the same for both **RGB** and **VIDEO** modes.





# Using the GUI (Graphical User Interface) Menu Screen



## Basic Operations

This projector has two sets of menu screens that allow you to adjust the image and various projector settings. These menu screens can be operated from the projector or the remote control with the following procedure.

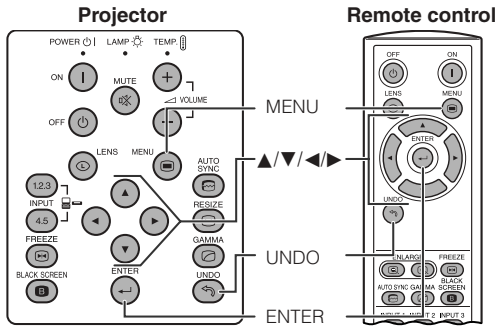

### (GUI) On-screen Display

#### INPUT 1, 2 (RGB) or 3 (DIGITAL) mode (Example)

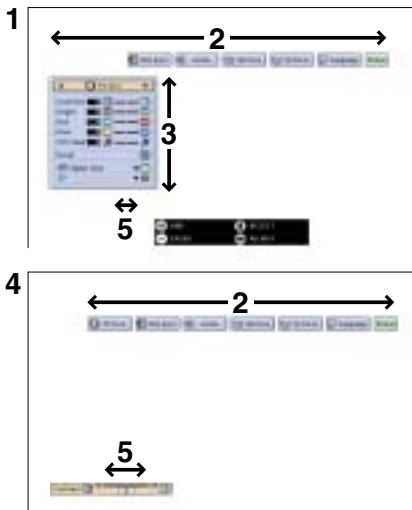

#### INPUT 4, 5 (VIDEO) mode (Example)

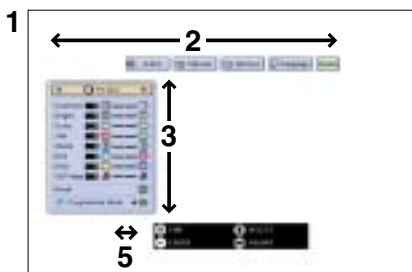

- 1 Press **MENU** to display the INPUT 1, 2, 3, 4 or 5 mode menu bar.
- 2 Press **◀▶** to select an adjustment menu on the menu bar.
- 3 Press **▲▼** to select a specific adjustment item.
- 4 To display a single adjustment item, press **ENTER** after selecting the item. Only the menu bar and the selected adjustment item will appear.
- 5 Press **◀▶** to adjust the item.
- 6 Press **UNDO** to return to the previous screen.
- 7 To exit from the GUI, press **MENU**.

#### NOTE

- For details on items on the menu screen, see the tree charts on pages [39](#) and [40](#).





# Menu Bars

## Items on the INPUT 1, 2 or 3 Mode Menu Bar

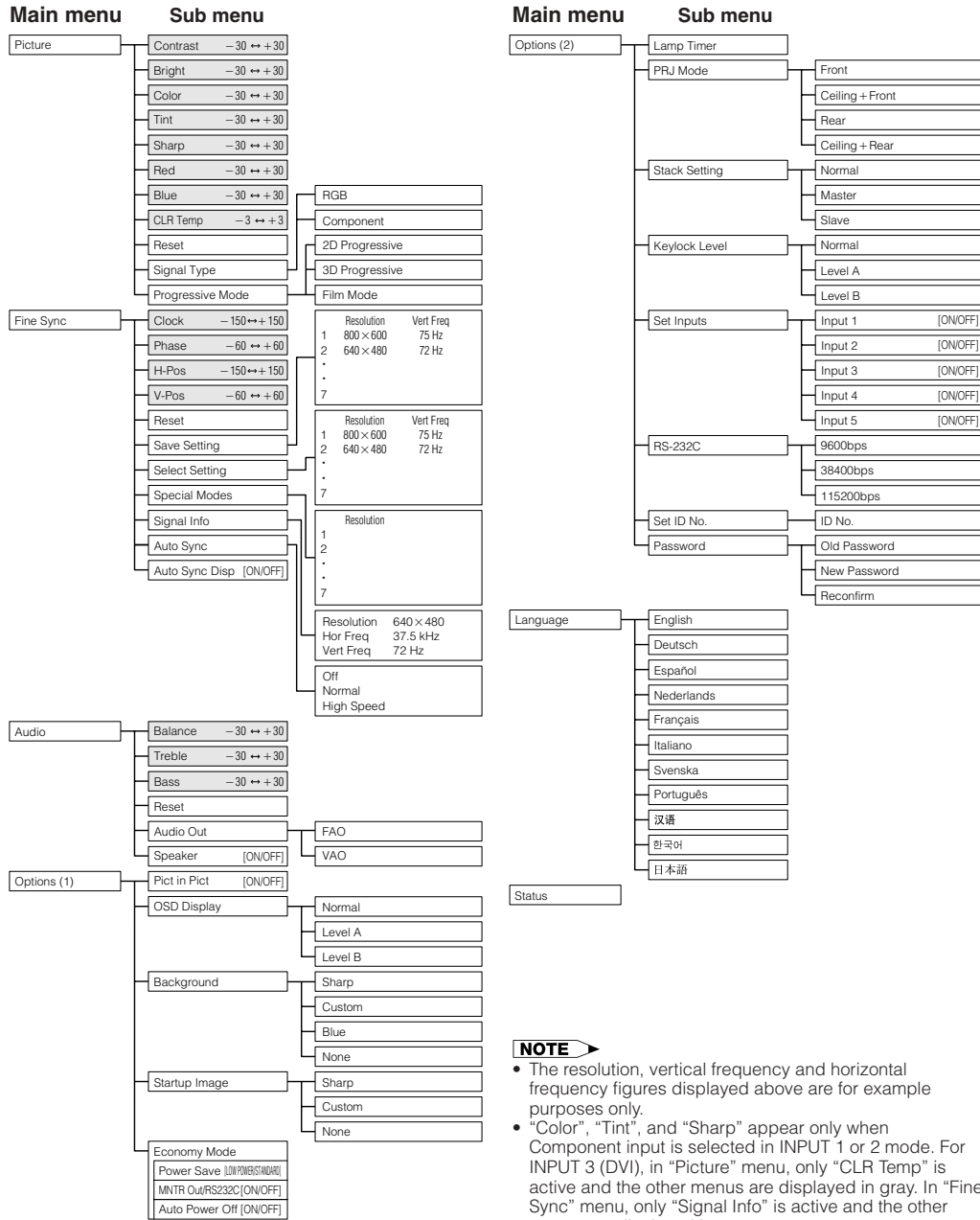

### NOTE

- The resolution, vertical frequency and horizontal frequency figures displayed above are for example purposes only.
- "Color", "Tint", and "Sharp" appear only when Component input is selected in INPUT 1 or 2 mode. For INPUT 3 (DVI), in "Picture" menu, only "CLR Temp" is active and the other menus are displayed in gray. In "Fine Sync" menu, only "Signal Info" is active and the other menus are displayed in gray.
- Only the items highlighted in the tree charts above can be adjusted.
- To adjust the items under the sub menu, press ► after selecting the sub menu.



## Menu Bars

### Items on the INPUT 4 or 5 Mode Menu Bar

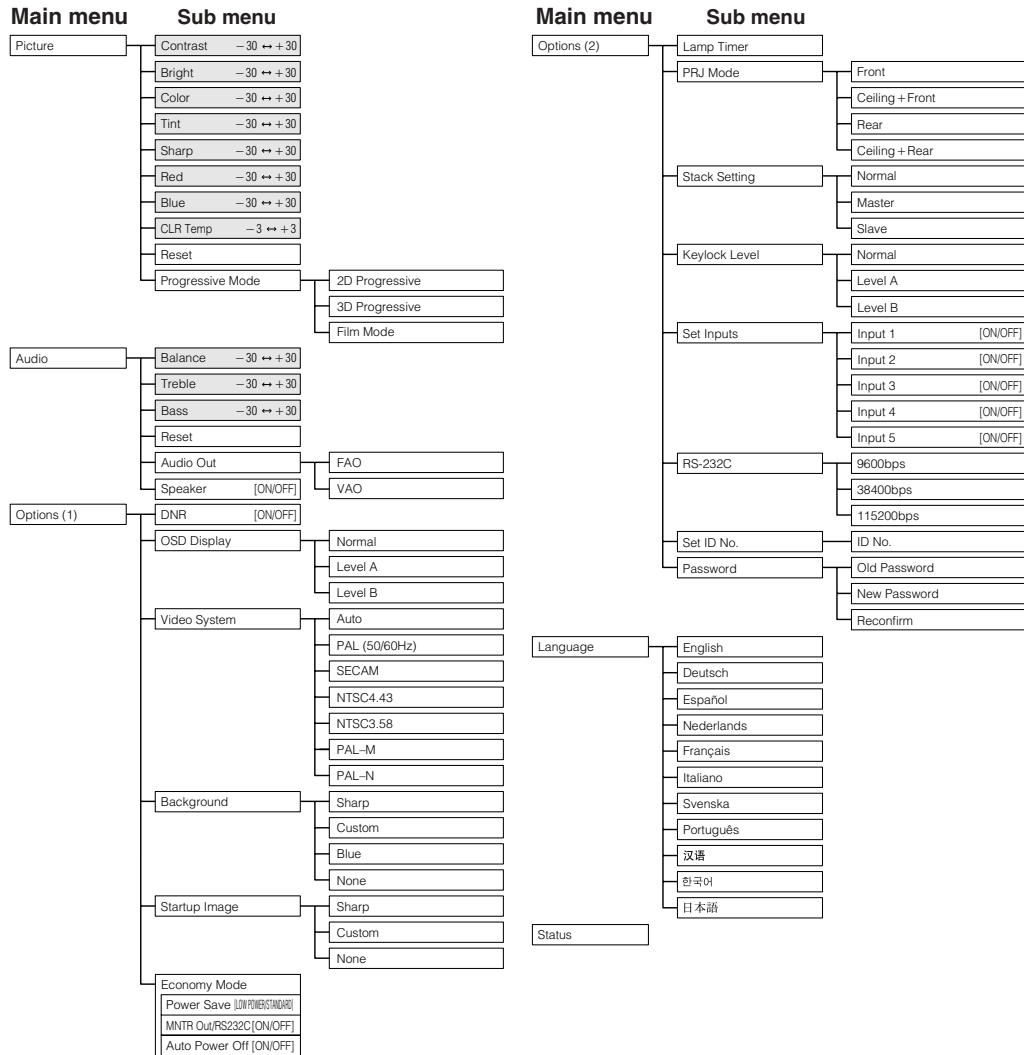

#### NOTE

- Only the items highlighted in the tree charts above can be adjusted.
- To adjust the items under the sub menu, press ► after selecting the sub menu.





## Adjusting the Picture



You can adjust the projector's picture to your preferences with the following picture settings. See page 38 for the procedure details.

e. g. RGB input in INPUT 1 or 2 mode



Selected item	◀ button	▶ button
<b>Contrast</b>	For less contrast	For more contrast
<b>Bright</b>	For less brightness	For more brightness
<b>Color</b>	For less color intensity	For more color intensity
<b>Tint</b>	Skin tones become purplish	Skin tones become greenish
<b>Sharp</b>	For less sharpness	For more sharpness
<b>Red</b>	For weaker red	For stronger red
<b>Blue</b>	For weaker blue	For stronger blue
<b>Reset</b>	All image adjustment items are returned to the factory preset settings.	

### NOTE

- "Color", "Tint" and "Sharp" do not appear for RGB input in INPUT 1 or 2 mode.
- To reset all adjustment items, select "Reset" on the "Picture" menu screen and press **ENTER**.
- The adjustments can be stored separately in the INPUT 1 to 5 modes.
- Depending on the type of signal received, "Sharp" may not be adjustable for COMPONENT input in INPUT 1 or 2 mode.

## Adjusting the Color Temperature

This function can be used to adjust the color temperature to suit the type of image input to the projector (video, computer image, TV broadcast, etc.). Decrease the color temperature to create warmer, reddish images for natural flesh tones, or increase to create cooler, bluish images for a brighter picture.



-3 (Red) ◀ button ▶ button (Blue) +3	
Decreases color temperature for warmer, reddish, incandescent-like images. (Low color temperature)	Increases color temperature for cooler, bluish, florescent-like images. (High color temperature)

## Selecting the Signal Type (RGB menu only)

This function allows you to select the input signal type RGB or COMPONENT for INPUT 1 or 2 port.

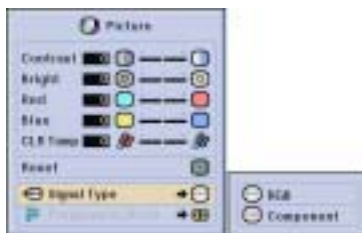



## Adjusting the Picture



### Progressive Mode

This function allows you to select the progressive display of a video signal. The progressive display projects a smoother video image. See page 38 for the procedure details.



Selects the progressive conversion mode.

#### 2D Progressive

This function is useful to display fast-moving images such as sports and action films. This mode optimizes the image in a displayed frame.

#### 3D Progressive

This function is useful to display relatively slow-moving images such as drama and documentary more clearly. This mode optimizes the image by estimating the movement of a number of preceding and succeeding frames.

#### Film Mode

Reproduces the image of film source clearly. Displays the optimized image of film transformed with three-two pull down (NTSC and PAL 60Hz) or two-two pull down (PAL 50Hz and SECAM) enhancement to progressive mode images.

\* The film source is a digital video recording with the original encoded as is at 24 frames/second. The projector can convert this film source to progressive video at 60 frames/second with NTSC and PAL60Hz or at 50 frames/second with PAL50Hz and SECAM to play back a high-definition image.

#### NOTE

- When using progressive inputs, these inputs are directly displayed therefore 2D Progressive, 3D Progressive and Film Mode cannot be selected. These modes can be selected in interlace signals other than 1080I.
- In NTSC or PAL60Hz, even if the 3D Progressive mode has been set, the three-two pull down enhancement will be enabled automatically, when the film source has been entered.
- In PAL50Hz or SECAM, the two-two pull down enhancement will be enabled only in the Film Mode, when the film source has been entered.





## Adjusting the Computer Images (RGB menu only)



When displaying computer patterns which are very detailed (tiling, vertical stripes, etc.), interference may occur between the LCD pixels, causing flickering, vertical stripes, or contrast irregularities in portions of the screen. Should this occur, adjust "Clock", "Phase", "H-Pos" and "V-Pos" for the optimum computer image. See page 38 for the procedure details.

Select the desired computer input mode with **INPUT 1** or **2**.



### Clock

Adjusts vertical noise.

### Phase

Adjusts horizontal noise (similar to tracking on your VCR).

### H-Pos

Centers the on-screen image by moving it to the left or right.

### V-Pos

Centers the on-screen image by moving it up or down.

### NOTE

- Computer image adjustments can be made easily by pressing **AUTO SYNC** (⊞). See page 45 for details.
- To reset all adjustment items, select "Reset" on the "Fine Sync" menu screen and press **ENTER**.

## Saving and Selecting Adjustment Settings

This projector allows you to store up to seven adjustment settings for use with various computers. Once these settings are stored, they can be easily selected each time you connect a computer to the projector.

### Saving the adjustment setting

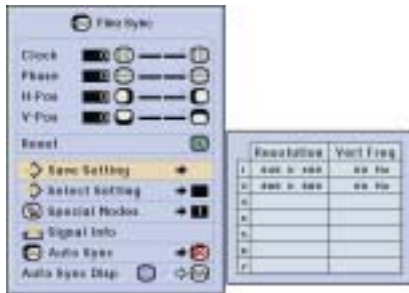

### Selecting a saved setting



### NOTE

- If a memory position has not been set, a resolution and frequency setting will not be displayed.
- When selecting the stored adjustment setting with "Select Setting", the computer system should match the stored setting.





## Adjusting the Computer Images (RGB menu only)



### Special Mode Adjustment

Ordinarily, the type of input signal is detected and the correct resolution mode is automatically selected. However, for some signals, the optimal resolution mode in "Special Modes" on the "Fine Sync" menu screen may need to be selected to match the computer display mode. See page 38 for the procedure details.



#### NOTE

- Avoid displaying computer patterns which repeat every other line (horizontal stripes). (Flickering may occur, making the image hard to see.)
- When inputting DTV 480P or 1080I signals, select the corresponding type of signal.

### Checking the Input Signal

This function allows you to check the current input signal information.

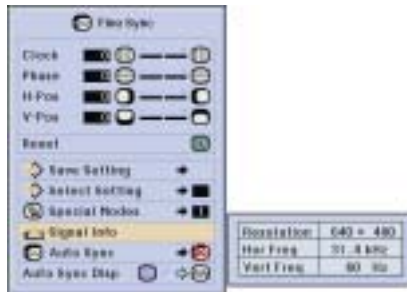



## Adjusting the Computer Images (RGB menu only)



### Auto Sync Adjustment

- Used to automatically adjust a computer image.
- Auto Sync adjustment can be made manually by pressing **AUTO SYNC**, or automatically by setting "Auto Sync" to "Normal" or "High Speed" in the projector's GUI menu. See page 38 for the procedure details.

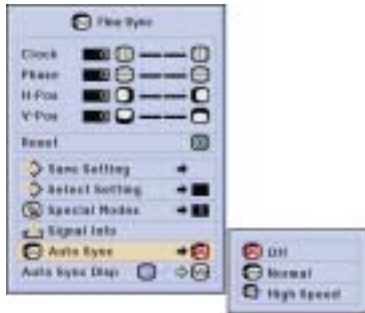

#### Off

- Synchronized adjustment is not automatically performed.
- Press **AUTO SYNC** to perform manual adjustment.

#### Normal

- Synchronized adjustment is automatically performed the same as the "High Speed" setting.
- Adjustment using the "Normal" setting takes longer to perform than using the "High Speed" setting, but it is more accurate.

#### High Speed

- The sync adjustment is automatically made each time the projector is turned on while connected to a computer or the input selection is changed.
- The Auto Sync adjustment setting previously made is cleared when the projector's setting is changed.

#### NOTE

- Automatic adjustments can be made by pressing **AUTO SYNC**.
- When performing AUTO SYNC in Off or High Speed mode, if you press **AUTO SYNC** once, then press it again within one minute, AUTO SYNC will be executed in Normal mode.
- Auto Sync adjustment may take some time to complete, depending on the image of the computer connected to the projector.
- When the optimum image cannot be achieved with Auto Sync adjustment, use manual adjustments. (See page 43.)

### Auto Sync Display Function

Normally, an image is not superimposed during Auto Sync adjustment. You can, however, choose to superimpose a background image during Auto Sync adjustment.







## Adjusting the Sound



This projector's audio is factory preset to standard settings. However, you can adjust it to suit your own preferences by adjusting the following audio settings. See page 38 for the procedure details.



Selected item	◀ button	▶ button
<b>Balance</b>	Increased audio from the left speaker	Increased audio from the right speaker
<b>Treble</b>	For weaker treble	For stronger treble
<b>Bass</b>	For weaker bass	For stronger bass
<b>Reset</b>	All audio adjustment items are returned to the factory preset settings.	

### NOTE

- To reset all adjustment items, select "Reset" on the "Audio" menu screen and press **ENTER**.

### Audio Out

FAO (Fixed audio output): Audio output that does not vary in strength with the volume level of the source projector.

VAO (Variable audio output): Audio output that varies in strength with the volume level of the source projector.

### Speaker

Switching the built-in speakers on the projector ON/OFF.





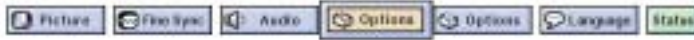

## Displaying Dual Pictures (RGB menu only)

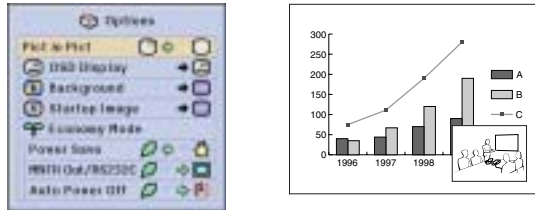

Picture in Picture function allows you to display two pictures on the same screen. You can display the image input from INPUT 4 or 5 as an inset picture overlapping the main picture input from INPUT 1, 2 or 3. See page 38 for the procedure details.



- 1 Press ◀ to select  to display an inset picture (Factory preset to INPUT 4).
- 2 Press ◀/▶/▲/▼ to move the inset picture to one of four preset positions.

### NOTE

- The image from INPUT 1, 2 or 3 is displayed as the main picture and the image from INPUT 4 or 5 is displayed as the inset picture.
- The last displayed image from INPUT 4 or 5 is displayed as the inset picture.  
For example, when you want to display the image from INPUT 4 as the inset picture, select INPUT 4, then select the main picture, and then select "Pict in Pict".
- Inset picture can only be displayed in video signal of NTSC/PAL/SECAM.
- When selecting the image for the inset picture, only the images being input will be displayed.
- The audio of the inset picture will come out of the projector's speakers.
- Picture in Picture does not work in case of the following RGB signals.  
UXGA signal image/Interlaced signal/DTV (480P/580P/720P/1035I/1080I)
- You can only use the following functions while in Picture in Picture mode.  
FREEZE: Works for the inset picture only.



## Reducing Image Noise (VIDEO menu only)

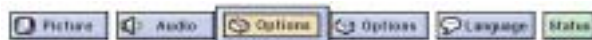

Digital Noise Reduction (DNR) provides high quality images with minimal dot crawl and cross color noise. See page 38 for the procedure details.



### NOTE

- If the image is clear, select  to prevent any blurring.





## Turning On/Off the On-screen Display



This function allows you to turn on or off the on-screen messages that appear during input select. See page 38 for the procedure details.



Selected item	Description
Normal	All On-screen Display are displayed.
Level A	Input/Custom/Freeze/Enlarge/Auto sync/Volume/Mute/Black screen functions are not displayed.
Level B	All On-screen Display are not displayed (except Menu/Lens functions and warning display (Power off/Temp./Lamp function etc.)).

## Setting the Video Signal (VIDEO menu only)

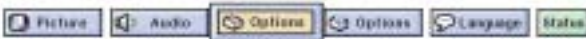

The video input system mode is preset to "Auto"; however, it can be changed to a specific system mode if the selected system mode is not compatible with the connected audiovisual equipment. See page 38 for the procedure details.



### NOTE

- When the system mode is set to "Auto", you may not receive a clear picture due to signal differences. Should this occur, switch to the video system of the source signal.
- AUTO cannot be set for PAL-M and PAL-N input signals. Select "PAL-M" or "PAL-N" in "Video System" menu for PAL-M and PAL-N input signals.





## Selecting a Background Image



This function allows you to select the image displayed when no signal is being sent to the projector. See page 38 for the procedure details.



Selected item	Description
Sharp	SHARP default image
Custom	User customized image (e.g. company logo)
Blue	Blue screen
None	Black screen

### NOTE

- By selecting "Custom", the projector can display a custom image (e.g. your company logo) as the background image. The custom image must be a 256-color BMP file with a picture size no larger than 1,024 × 768 pixels. Please see the Sharp Advanced Presentation Software operation manual on the CD-ROM for how to save (or change) a custom image.

## Selecting a Startup Image

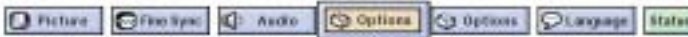

This function allows you to specify the image to be displayed upon the projector's startup. A custom image (e.g. your company logo) can be uploaded to the projector via an RS-232C cable. See page 19 in this operation manual, and also the supplied Sharp Advanced Presentation Software operation manual on the CD-ROM for detailed instructions. See page 38 for the procedure details.



Selected item	Description
Sharp	SHARP default image
Custom	User customized image (e.g. company logo)
None	Black screen

### NOTE

- By selecting "Custom", the projector can display a custom image (e.g. your company logo) as the startup image. The custom image must be a 256-color BMP file with a picture size no larger than 1,024 × 768 pixels. Please see the Sharp Advanced Presentation Software operation manual on the CD-ROM for how to save (or change) a custom image.





## Selecting the Economy Mode



These functions allow you to reduce the power consumption when the projector is in standby mode. See page 38 for the procedure details.

### Power Save Function

Function to control the quantity of projected light. Select "Low Power Mode" or "Standard Mode" to decrease or increase brightness and power consumption.



	Quantity of light is 80%. Power consumption is 330W.
	Quantity of light is 100%. Power consumption is 380W.

#### NOTE

- "Power Save" mode is factory preset to "(Standard Mode)".
- When selecting "(Standard Mode)" in "Power Save Mode", fan noise increases.
- Even when selecting "(Low Power Mode)" in "Power Save Mode", fan noise may increase if internal temperature rises enough to activate the cooling function.

### Monitor Out/RS-232C Off Function

This projector consumes power when using a monitor connected to the OUTPUT port for INPUT 1, 2 and a computer connected to the RS-232C port. When not using these ports, "MNTR Out/RS232C" can be set to "" to reduce standby power consumption.



	Standby power for Monitor Out/RS-232C connection turned off.
	Monitor Out/RS-232C on

#### CAUTION

- Set "MNTR Out/RS232C" to "" when using the Sharp Advanced Presentation Software (supplied).

### Automatic Power Shutoff Function

When no input signal is detected for more than 15 minutes, the projector will automatically shut off. The on-screen message, "Power OFF in 5 min." will appear five minutes before the power is automatically turned off.



	Power automatically shuts off after about 15 minutes of no signal input.
	Automatic Power Shutoff disabled.

#### NOTE

- "MNTR Out/RS232C" is factory preset to "", and "Auto Power Off" is factory preset to "".

Basic Operation



## Confirming the Lamp Usage Time



This function allows you to check the accumulated lamp usage time. See page 38 for the procedure details.



### NOTE

- It is recommended that the lamp be replaced after approximately 1,400 cumulative hours of use. See pages 62 and 63 for lamp replacement.



## Reversing/Inverting Projected Images



This projector is equipped with a reverse/invert image function which allows you to reverse or invert the projected image for various applications. See page 38 for the procedure details.

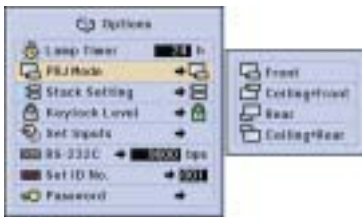

Selected item	Description
Front	Normal image
Ceiling + Front	Inverted image
Rear	Reversed image
Ceiling + Rear	Reversed and inverted image

### NOTE

- This function is used for the reversed image and ceiling-mount setups. See page 30 for these setups.





## Setting the Stacking Mode



You can double the brightness of an image by stacking two projectors and projecting same picture simultaneously. To control two projectors, assign one as the master and one as the slave. The slave projector will duplicate any operational settings made to the master projector. See page 38 for the procedure details.



### NOTE

- When the projector is set to "Master", button operation signals will be transmitted through RS-232C.
- When the projector is set to "Slave", operations follow the button operations sent from the "Master".
- When set to slave, all buttons on the projector along with ▲/▼/◀▶, ENTER, UNDO, POWER ON, POWER OFF, LENS and MENU on the remote control can be used. The slave cannot operate the other buttons on remote control.
- For details on intended purpose, see pages 59 and 60.

## Locking the Operation Buttons on the Projector



This function can be used to lock the use of certain operation buttons on the projector. The user can still operate the projector fully with the remote control. See page 38 for the procedure details.



Selected item	Description
Normal	All operation buttons are functional.
Level A	Only Input/Volume/Mute functions on the projector are available.
Level B	All operation buttons on the projector are unavailable.

### NOTE

- To cancel the Keylock Level, perform the above procedure using the remote control.
- See page 55 for details using the password function.





## Deselecting Inputs



This function allows you to deselect unwanted signal input. See page [38](#) for the procedure details.



### NOTE

- When stack projecting, multi-screen projecting and so on, this function can be used to cancel the RS-232C control.
- Up to two input signals can be blocked for both Input 1, 2, 3 or Input 4, 5.
- For details on intended purpose, see pages [59](#) and [60](#).

## Selecting the Transmission Speed (RS-232C)



This menu allows you to adjust the transmission speed of the RS-232C connection by selecting the baud rate. See page [38](#) for the procedure details.



### NOTE

- Make sure that both the projector and computer are set for the same baud rate. Refer to the computer's operation manual for instructions for setting the baud rate.







## Controlling Multiple Projectors with ID Numbers



This projector can form a network of up to 250 projectors. To identify separately and control specified projector, you need to set ID No.. The ID No. is factory preset to "001". See page 38 for the procedure details.

### Setting the ID No.



Press **▶** to select the first digit and **▲/▼** to select the desired number. Continue this procedure for the remaining two digits.

#### NOTE

- Be sure to set the ID No. in the Option menu and attach a corresponding number seal to the projector.
- The ID No. can be set from 001 to 250.
- For details on intended purpose, see pages 57 to 60.





## Protecting Important Settings with a Password



A password can be set by the user and used with the keylock level to prevent adjustments to certain settings on the GUI. See page [38](#) for the procedure details.

### NOTE

- When password is set, you need to enter the password to use "PRJ Mode", "Stack Setting", "Keylock Level", "Set Inputs", "RS-232C" and "Set ID No." menus.

### Setting the Password



- 1 Enter the new password using  $\blacktriangle/\blacktriangledown$  to select the desired number, and then press  $\blacktriangleright$  to select the next digit. Continue this procedure for the remaining three digits, and then press **ENTER**.
- 2 Enter the password again ("Reconfirm") using  $\blacktriangle/\blacktriangledown/\blacktriangleleft/\blacktriangleright$ , and then press **ENTER**.

### NOTE

- After setting the password, be sure to write it down in a secure location in case you can not remember it.

### Changing the Password



- 1 Enter the old password using  $\blacktriangle/\blacktriangledown/\blacktriangleleft/\blacktriangleright$ , and then press **ENTER**.
- 2 Enter the new password using  $\blacktriangle/\blacktriangledown/\blacktriangleleft/\blacktriangleright$ , and then press **ENTER**.
- 3 Enter the password again ("Reconfirm") using  $\blacktriangle/\blacktriangledown/\blacktriangleleft/\blacktriangleright$ , and then press **ENTER**.



## Selecting the On-screen Display Language



English is the preset language for the On-screen Display; however, this can be changed to German, Spanish, Dutch, French, Italian, Swedish, Portuguese, Chinese, Korean or Japanese. See page [38](#) for the procedure details.

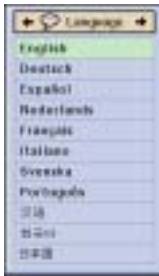

## Displaying the Adjustment Settings

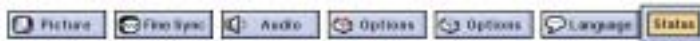

This function can be used to display all the adjusted settings on the screen simultaneously. See page [38](#) for the procedure details.

INPUT 1, 2 (RGB) or 3 (DIGITAL) mode



INPUT 4, 5 (VIDEO) mode





## Using Extended Functionality Features

This projector has outstanding network capability.

- Internet access for self-diagnosis
- Multiple and group projector control
- Simultaneous multiple projector control

### Internet access for self-diagnosis, status information and preventive maintenance

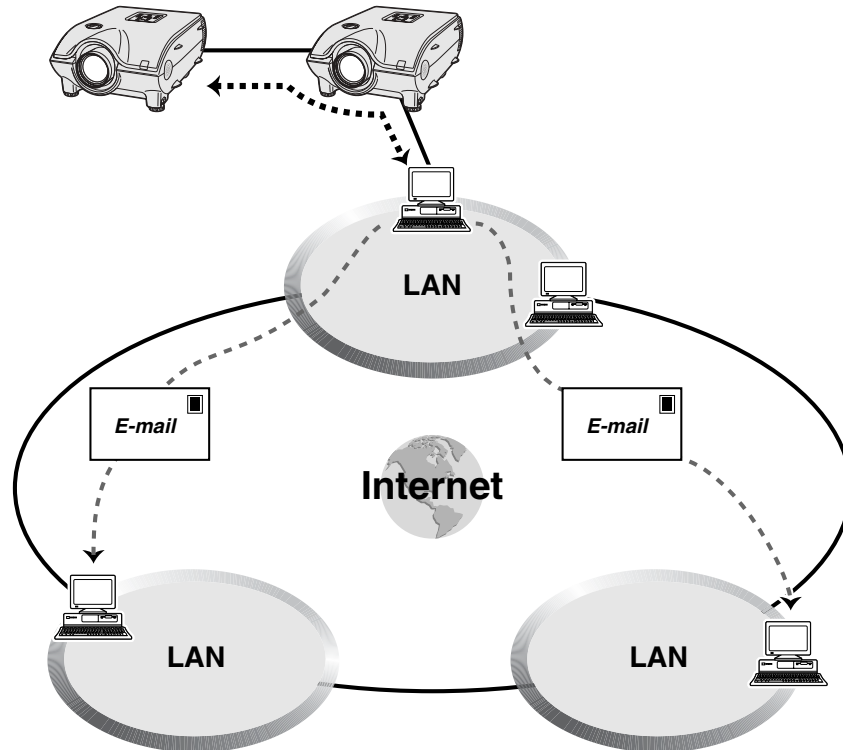

This projector can be used in a network of up to 250 projectors managed from a single PC with the accompanied Sharp Advanced Presentation Software Professional Edition. This projector can be connected to a PC using an RS-232C connection. Output terminals are provided (RS-232C on the projector) enabling a daisy chain configuration and eliminating the need for a distributor.

This projector is also equipped with a function to send status information (lamp usage time, etc.) to a Sharp Service Center or outside contractor for quick and efficient customer service.

#### **NOTE**

- For more information on these features, see the operation manuals accompanying the Sharp Advanced Presentation Software Professional Edition.





## Using Extended Functionality Features

### Multiple and group projector control via computer

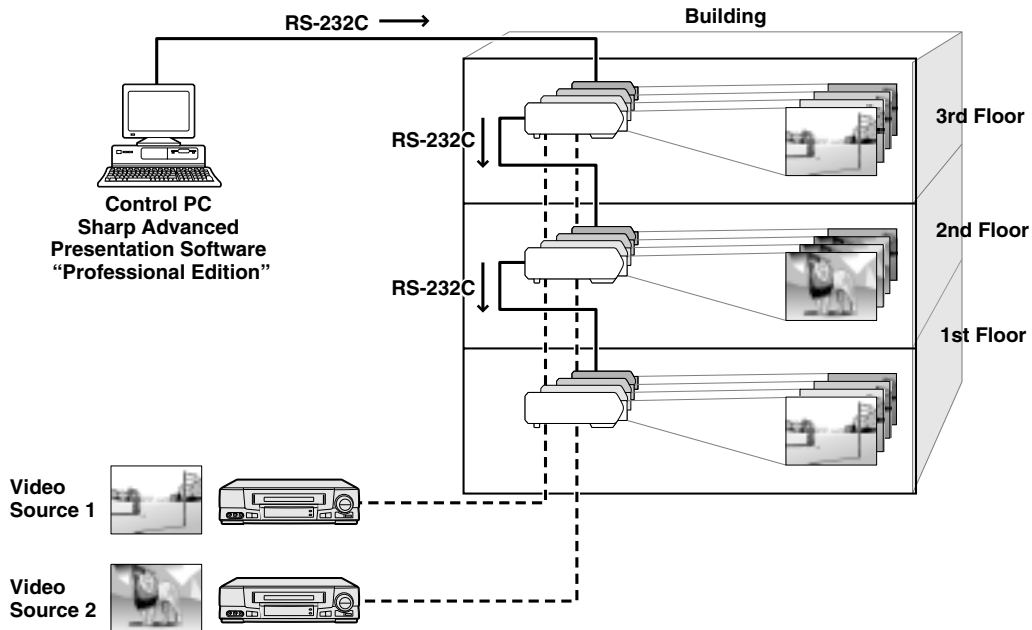

This projector can be used in a network of projectors managed from a single PC with the accompanied Sharp Advanced Presentation Software Professional Edition. Projectors in conference rooms on the first and third floors of a building, for example, can be used for video presentations, while projectors on the second floor can be used for PC-assisted presentations. Projectors can even be powered down at different times (e.g., projectors on the first and second floors are powered down in one hour, while those on the third floor are powered down in two hours).

#### NOTE

- For more information on these features, see the operation manuals accompanying the Sharp Advanced Presentation Software Professional Edition.
- Transmission performance of the RS-232C cable can vary depending on the surrounding conditions. Use the transmission repeater if performance is not up to par.
- We recommend you use an RS-232C cable not longer than 49' 3" (15 m).

Multiple Function





## Using Extended Functionality Features

### Simultaneous multiple projector control for stacking and videowall projection

#### Stack Projection

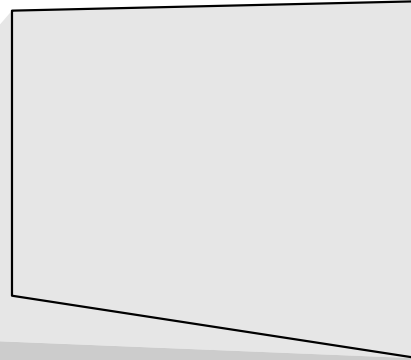
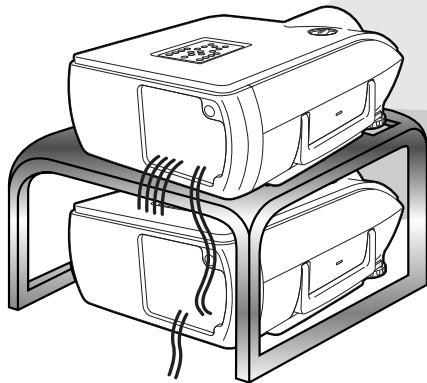

Multiple Function

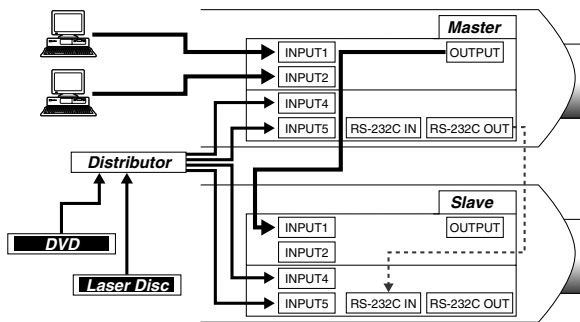

Stack Setting  
**Master**

Set Inputs	
INPUT1	Yes
INPUT2	Yes
INPUT3	No
INPUT4	Yes
INPUT5	Yes

Stack Setting  
**Slave**

Set Inputs	
INPUT1	Yes
INPUT2	No
INPUT3	No
INPUT4	Yes
INPUT5	Yes

For brighter images, two projectors can be stacked using the Stack Setting function, with one projector set as the Master and the other as the Slave. The operations of the Slave projector are controlled by the Master projector during projection through an RS-232C connection. The RS-232C cable (cross type, sold separately) is connected from the RS-232C output on the Master projector to the RS-232C input on the Slave projector.

Projectors can be stacked using an RS-232C cable (cross type, sold separately). See page 67 for recommended connection of an RS-232C serial control cable.

#### NOTE

- See page 52, "Setting the Stacking Mode", and page 53, "Deselecting Inputs".





## Using Extended Functionality Features

### Videowall

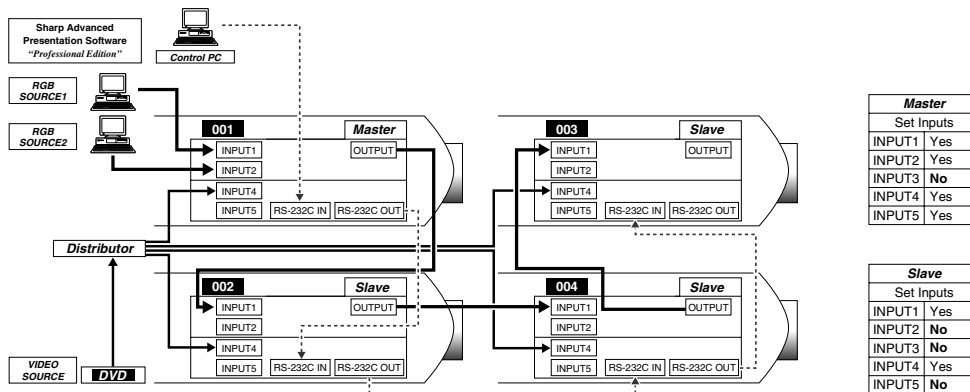
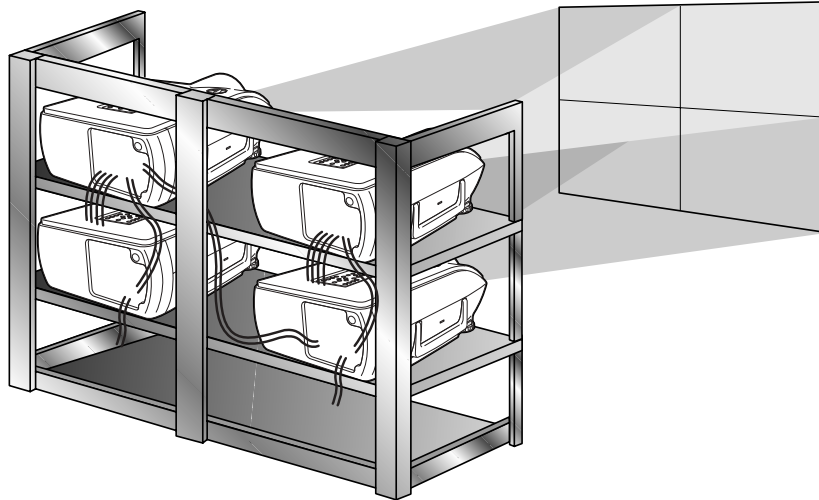

Multiple Function

This projector can be used together with other projectors managed using the accompanied Sharp Advanced Presentation Software Professional Edition to create a videowall projection. Whereas conventional videowall technology required the use of an image distributor, this projector videowall feature enables easy image settings from a PC when inputting a single video source. This function greatly simplifies videowall setup.

RS-232C OUTPUTS also realize the simple daisy chain connection. The master projector directly connected to the computer can make the daisy chain connection with multiple slave projectors. For details on setting master or slave, see page 52.

- Use a videowall projector stand, sold separately, when using this function.
- Image quality may deteriorate when picture signals are input through multiple projectors in a daisy chain connection.

#### NOTE

- For more information on this feature, see the operation manuals accompanying the Sharp Advanced Presentation Software Professional Edition.
- When UXGA signal is displayed, the videowall can not be set by Sharp Advanced Presentation Software Professional Edition.





# Lamp/Maintenance Indicators

## Maintenance Indicators

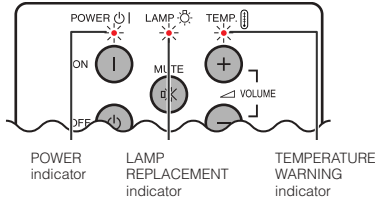

- The warning lights on the projector indicate problems inside the projector.
- There are two warning lights: a TEMPERATURE WARNING indicator which warns that the projector is too hot, and a LAMP REPLACEMENT indicator which lets you know when to change the lamp.
- If a problem occurs, either the TEMPERATURE WARNING indicator or the LAMP REPLACEMENT indicator will light up red. After turning off the power, follow the procedures given below.

Maintenance Indicator	Condition	Problem	Possible Solution
TEMPERATURE WARNING indicator	The internal temperature is abnormally high.	• Blocked air intake.	• Relocate the projector to an area with proper ventilation.
		• Clogged air filter.	• Clean the filter. (See page 64.)
		• Cooling fan breakdown. • Internal circuit failure.	• Take the projector to your nearest Sharp Authorized LCD Projector Dealer or Service Center for repair.
LAMP REPLACEMENT indicator	The lamp does not light up.	• Burnt-out lamp. • Lamp circuit failure.	• Carefully replace the lamp. (See pages 62 and 63.)
	The lamp requires replacement.	• Lamp has been used for over 1,400 hours.	• Take the projector to your nearest Sharp Authorized LCD Projector Dealer or Service Center for repair.
POWER indicator	The POWER indicator flashes in red when the projector is on.	• The filter cover is open.	• Securely install the filter cover. • If the POWER indicator flashes even when the filter cover is securely installed, contact your nearest Sharp Authorized LCD Projector Dealer or Service Center for advice.

### NOTE

- If the TEMPERATURE WARNING indicator lights up, follow the above possible solutions and then wait until the projector has cooled down completely before turning the power back on. (At least 5 minutes.)
- If the power is turned off and then turned on again, as during a brief rest, the LAMP REPLACEMENT indicator may be triggered, preventing the power from going on. Should this occur, take the power cord out of the wall outlet and put it back in again.

## Lamp

The lamp in this projector operates for approximately 1,500 cumulative hours, depending on the usage environment. It is recommended that the lamp be replaced after 1,400 cumulative hours of use or when you notice a significant deterioration of the picture and color quality. The lamp usage time can be checked with the On-screen Display. (see page 51.)

### CAUTION

- Intense light hazard. Do not attempt to look into the aperture and lens while the projector is operating.

### NOTE

- As the usage environment can vary significantly, the projector lamp may not operate for 1,500 hours.

Condition	Problem	Possible Solution
The LAMP REPLACEMENT indicator lights up red, and "LAMP" and "L" will blink in yellow in the lower-left corner of the picture.	• Lamp has been used for over 1,400 hours.	• Purchase a replacement lamp unit (lamp/cage module) of the current type BQC-XGP25X/1 from your nearest Sharp Authorized LCD Projector Dealer or Service Center. • Replace the lamp. (See pages 62 and 63.) If you wish, you may have the lamp replaced at your nearest Sharp Authorized LCD Projector Dealer or Service Center.
A significant deterioration of the picture and color quality occurs.		
The power will automatically turn off and the projector will enter standby mode.	• Lamp has been used for over 1,500 hours.	
"LAMP" and "L" will blink in red in the lower-left corner of the picture, and the power will turn off.		







## Replacing the Lamp

### CAUTION

- Potential hazard of glass particles if lamp ruptures. In case of lamp rupture, contact your nearest Sharp Authorized LCD Projector Dealer or Service Center for a replacement.
- Do not remove the lamp cage directly after operation of the projector. The lamp may be extremely hot. Wait at least one hour after the power cord is disconnected to allow the surface of the lamp cage to fully cool before removing the lamp cage.

It is recommended that the lamp be replaced after approximately 1,400 cumulative hours of use or when you notice a significant deterioration of the picture and color quality. Carefully change the lamp by following the steps below.

If the new lamp does not light after replacement, take your projector to the nearest Sharp Authorized LCD Projector Dealer or Service Center for repair. Purchase a replacement lamp unit (lamp/cage module) of the current type BQC-XGP25X/1 from your nearest Sharp Authorized LCD Projector Dealer or Service Center. Then carefully change the lamp by following the instructions below. If you wish, you may have the lamp replaced at your nearest Sharp Authorized LCD Projector Dealer or Service Center.

### IMPORTANT NOTE TO U.S. CUSTOMERS:

The lamp included with this projector is backed by a 90-day parts and labor limited warranty. All service of this projector under warranty, including lamp replacement, must be obtained through a Sharp Authorized LCD Projector Dealer or Service Center. For the name of the nearest Sharp Authorized LCD Projector Dealer or Service Center, please call toll-free: 1-888-GO-SHARP (1-888-467-4277).

U.S.A. ONLY

### Caution Concerning the Lamp

- This projector utilizes a pressurized mercury lamp. A loud sound may indicate lamp failure. Lamp failure can be attributed to numerous sources such as excessive shock, improper cooling, surface scratches or deterioration of the lamp due to a lapse of usage time. The period of time up to failure largely varies depending on the individual lamp and/or the condition and the frequency of use. It is important to note that failure can often result in the bulb cracking.
- When the LAMP REPLACEMENT indicator and on-screen display icon is illuminated or flashes, it is recommended that the lamp be replaced with a new one immediately, even if the lamp appears to be operating normally.
- Should the lamp break, the glass particles may spread inside the lamp cage or gas contained in the lamp may be vented into the room from the exhaust vent. Because the gas in this lamp includes mercury, ventilate the room well if the lamp breaks and avoid all exposure to the released gas. In case of exposure to the gas, consult with a doctor as soon as possible.
- Should the lamp break, there is also a possibility that glass particles may spread inside of the projector. In such a case, it is recommended you contact your nearest Sharp Authorized LCD Projector Dealer or Service Center to remove the damaged lamp and assure safe operation.

### Removing and installing the lamp unit

#### CAUTION

- Be sure to remove the lamp cage by the handle. Be sure not to touch the glass surface of the lamp cage or the inside of the projector.
- To avoid injury to yourself and damage to the lamp, be sure to carefully follow the steps below.
- Be sure to change the air filter during lamp replacement. The air filter comes packaged with the lamp unit.

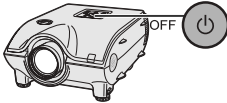
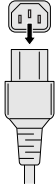
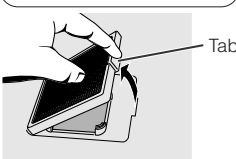
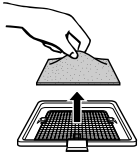
1 Turn off the power.	2 Disconnect the power cord.	3 Remove the bottom filter cover.	4 Remove the air filter.
<p>Press <b>POWER OFF</b>. Wait until the cooling fan stops.</p> 	<p>Unplug the power cord from the AC socket.</p> 	<p>Turn over the projector. Press the tab and lift open the filter cover in the direction of the arrow.</p> 	<p>Grasp the air filter between your fingers and lift it out of the filter cover.</p> 





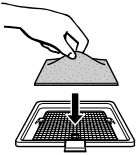
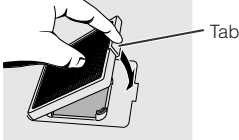
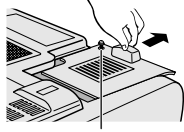
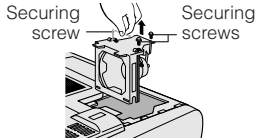
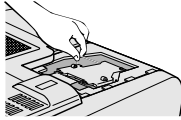
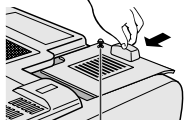

## Replacing the Lamp

<p><b>5 Replace the air filter.</b></p> <p>Place the air filter underneath the tabs on the filter frame.</p> 	<p><b>6 Replace the filter cover.</b></p> <p>Insert the tab on the end of the filter cover into the filter cover opening and press the filter cover into position.</p>  <p>Tab</p>	<p><b>7 Remove the lamp cage cover.</b></p> <p>Turn over the projector and loosen the user service screw that secures the lamp cage cover. Then slide the cover in the direction of the arrow.</p>  <p>User service screw</p>
<p><b>8 Remove the lamp cage.</b></p> <p>Remove the securing screws from the lamp cage. Hold the lamp cage by the handle and pull it towards you.</p>  <p>Securing screw      Securing screws</p>	<p><b>9 Insert the new lamp cage.</b></p> <p>Press the lamp cage firmly into the lamp cage compartment. Fasten the securing screws.</p> 	<p><b>10 Attach the lamp cage cover.</b></p> <p>Slide the lamp cage cover in the direction of the arrow. Then tighten the user service screw.</p>  <p>User service screw</p>

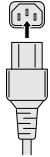
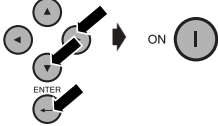
## Resetting the lamp timer

<p><b>1 Connect the power cord.</b></p> <p>Plug the power cord into the AC socket of the projector.</p> 	<p><b>2 Reset the lamp timer.</b></p> <p>While pressing <b>▼</b>, <b>▶</b> and <b>ENTER</b> on the projector, press <b>POWER ON</b> on the projector.</p>  <p>ON</p>	<p>"LAMP 0000H" is displayed, indicating that the lamp timer is reset.</p> 
---	---	--

### NOTE

- Reset the lamp timer only after replacing the lamp.





## Replacing the Air Filter

- This projector is equipped with two air filters to ensure the optimal operating condition of the projector.
- The air filters should be cleaned every 100 hours of use. Clean the filters more often when the projector is used in a dusty or smoky location.
- Have your nearest Sharp Authorized LCD Projector Dealer or Service Center exchange the filter (PFILD0080CEZZ) when it is no longer possible to clean it.

### Bottom View

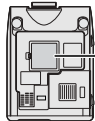

Air filter

### Side and Rear View



Air filter (not removable)

### Cleaning and replacing the bottom air filter

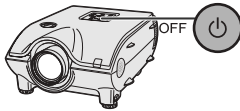
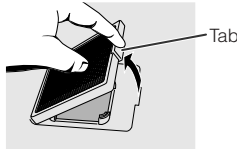
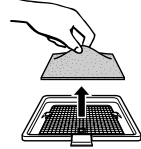
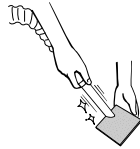
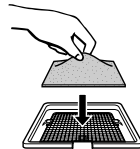
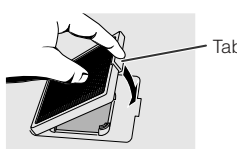
<p><b>1 Turn off the power and disconnect the power cord.</b></p> <p>Press <b>POWER OFF</b>. Wait until the cooling fan stops.</p> 	<p><b>2 Remove the bottom filter cover.</b></p> <p>Turn over the projector. Press the tab and lift open the filter cover in the direction of the arrow.</p> 	<p><b>3 Remove the air filter.</b></p> <p>Grasp the air filter between your fingers and lift it out of the filter cover.</p> 
<p><b>4 Clean the air filter.</b></p> <p>Clean the dust off the air filter and cover with a vacuum cleaner extension hose.</p> 	<p><b>5 Replace the air filter.</b></p> <p>Place the air filter underneath the tabs on the filter frame.</p> 	<p><b>6 Replace the filter cover.</b></p> <p>Insert the tab on the end of the filter cover into the filter cover opening and press the filter cover into position.</p> 

#### NOTE

- Be sure the filter cover is securely installed. The power will not turn on unless it is correctly installed.

### Cleaning the side air filter (not removable)

If dust or dirt has collected inside the air filter, clean the filter with a vacuum cleaner extension hose.

#### NOTE

- The side air filter cannot be removed.





## Troubleshooting

Problem	Check
Power cannot be turned on or off using the POWER buttons (ON/OFF) on the projector.	<ul style="list-style-type: none"> <li>Keylock level is set to "Level A" or "Level B", preventing operation of some or all buttons. (See page 52.)</li> </ul>
Cannot be operated by remote control.	<ul style="list-style-type: none"> <li>Check to see if the batteries are dead. If they are, replace with new ones. (See page 13.)</li> <li>When the projector is set to slave, use the buttons on the master projector or change the setting by RS-232C commands from the computer. (See page 52.)</li> </ul>
Cannot be operated by all buttons of the projector and remote control.	<ul style="list-style-type: none"> <li>When using slave setting in combination with Keylock Level B, all the buttons on the projector and the remote control are disabled. Use the SAPS or RS-232C commands to release slave and Keylock setting and enable buttons to operate. Without a computer, you can release slave and Keylock setting by entering the buttons on the projector as follows. ON → ENTER → ON → ENTER → ON → ENTER → MENU However, this operation also releases the password set.</li> </ul>
No picture and no sound.	<ul style="list-style-type: none"> <li>Projector power cord is not plugged into the wall outlet.</li> <li>The bottom filter cover is not securely installed.</li> <li>Selected input is wrong. (See page 31.)</li> <li>Cables incorrectly connected to rear panel of the projector. (See pages 16 - 21.)</li> <li>Remote control batteries have run down. (See page 13.)</li> </ul>
Sound is heard but no picture appears.	<ul style="list-style-type: none"> <li>Cables incorrectly connected to rear panel of the projector. (See pages 16 - 21.)</li> <li>"Contrast" and "Bright" adjustments are set to minimum position. (See page 41.)</li> <li>On-screen Display ("BLACK SCREEN") is turned off and Black Screen function is turned on, creating a black image. (See page 32.)</li> </ul>
Color is faded or poor.	<ul style="list-style-type: none"> <li>"Color" and "Tint" adjustments are not correct. (See page 41.)</li> </ul>
Picture is blurred.	<ul style="list-style-type: none"> <li>Adjust the focus. (See page 24.)</li> <li>Projection distance is too long or too short to allow for proper focus. (See pages 25 - 29.)</li> </ul>
Picture appears but no sound is heard.	<ul style="list-style-type: none"> <li>Cables incorrectly connected to rear panel of the projector. (See pages 16 - 21.)</li> <li>Volume is set to minimum. (See page 31.)</li> </ul>
No OSD appears.	<ul style="list-style-type: none"> <li>OSD Display is set to "Level A" or "Level B", preventing to display some or all On-screen Displays. (See page 48.)</li> </ul>
An unusual sound is occasionally heard from the cabinet.	<ul style="list-style-type: none"> <li>If the picture is normal, the sound is due to cabinet shrinkage caused by temperature changes. This will not affect operation or performance.</li> </ul>
Maintenance indicator lights up.	<ul style="list-style-type: none"> <li>Refer to "Lamp/Maintenance Indicators" on page 61.</li> </ul>
Picture noise appears.	<ul style="list-style-type: none"> <li>Adjust the "Phase" setting. (See page 43.)</li> <li>Noise may appear when used with certain computers. Set the NOISE FILTER to ON using the RS-232C command. (See pages 68 - 70.)</li> </ul>
480P images do not appear.	<ul style="list-style-type: none"> <li>Set the resolution mode to 480P. (See page 44.)</li> </ul>
Image is green on INPUT 1 or 2 COMPONENT. Image is pink (no green) on INPUT 1, 2 RGB.	<ul style="list-style-type: none"> <li>Change the input signal type. (See page 41.)</li> </ul>





## For SHARP Assistance

If you encounter any problems during setup or operation of this projector, first refer to the "Troubleshooting" section on page 65. If this operation manual does not answer your question, please contact the SHARP Service Department listed below.

<b>U.S.A.</b>	<b>Sharp Electronics Corporation</b> 1-888-GO-SHARP (1-888-467-4277) lcdsupport@sharpsec.com <a href="http://www.sharplcd.com">http://www.sharplcd.com</a>
<b>Canada</b>	<b>Sharp Electronics of Canada Ltd.</b> (905) 568-7140 <a href="http://www.sharp.ca">http://www.sharp.ca</a>
<b>Mexico</b>	<b>Sharp Electronics Corporation Mexico Branch</b> (525) 716-9000 <a href="http://www.sharp.com.mx">http://www.sharp.com.mx</a>
<b>Germany</b>	<b>Sharp Electronics (Europe) GMBH</b> 01805-234675 <a href="http://www.sharp.de">http://www.sharp.de</a>
<b>U.K.</b>	<b>Sharp Electronics (U.K.) Ltd.</b> 0161-205-2333 custinfo@sharp-uk.co.uk <a href="http://www.sharp.co.uk">http://www.sharp.co.uk</a>
<b>Italy</b>	<b>Sharp Electronics (Italy) S.P.A.</b> (39) 02-89595-1 <a href="http://www.sharp.it">http://www.sharp.it</a>
<b>Australia</b>	<b>Sharp Corporation of Australia Pty.Ltd.</b> 1300-135-022 <a href="http://www.sharp.net.au">http://www.sharp.net.au</a>
<b>New Zealand</b>	<b>Sharp Corporation of New Zealand</b> (09) 634-2059, (09) 636-6972 <a href="http://www.sharpnz.co.nz">http://www.sharpnz.co.nz</a>
<b>Singapore</b>	<b>Sharp-Roxy Sales (S) Pte. Ltd.</b> 65-226-6556 ckng@srs.global.sharp.co.jp <a href="http://www.sharp.com.sg">http://www.sharp.com.sg</a>
<b>Hong Kong</b>	<b>Sharp-Roxy (HK) Ltd.</b> (852) 2410-2623 dcmktg@srh.global.sharp.co.jp <a href="http://www.sharp.com.hk">http://www.sharp.com.hk</a>
<b>Malaysia</b>	<b>Sharp-Roxy Sales &amp; Service Co.</b> (60) 3-5125678
<b>U.A.E.</b>	<b>Sharp Middle East Fze</b> 971-4-81-5311 helpdesk@smef.global.sharp.co.jp
<b>Thailand</b>	<b>Sharp Thebnakorn Co. Ltd.</b> 02-236-0170 svc@stcl.global.sharp.co.jp <a href="http://www.sharp-th.com">http://www.sharp-th.com</a>
<b>Korea</b>	<b>Sharp Electronics Incorporated of Korea</b> (82) 2-3660-2002 webmaster@sharp-korea.co.kr <a href="http://www.sharp-korea.co.kr">http://www.sharp-korea.co.kr</a>





# Connecting Pin Assignments

**INPUT 1 RGB and OUTPUT (INPUT 1, 2) Signal Ports:** 15-pin Mini D-sub female connector

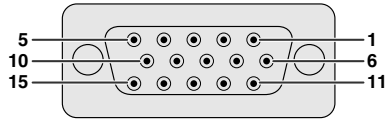

### RGB Input

Analog

- |                                      |                            |
|--------------------------------------|----------------------------|
| 1. Video input (red)                 | 8. Earth (blue)            |
| 2. Video input (green/sync on green) | 9. Not connected           |
| 3. Video input (blue)                | 10. GND                    |
| 4. Reserve input 1                   | 11. GND                    |
| 5. Composite sync                    | 12. Bi-directional data    |
| 6. Earth (red)                       | 13. Horizontal sync signal |
| 7. Earth (green/sync on green)       | 14. Vertical sync signal   |
|                                      | 15. Data clock             |

### Component Input

Analog

- |                                     |                   |
|-------------------------------------|-------------------|
| 1. P <sub>R</sub> (C <sub>R</sub> ) | 9. Not connected  |
| 2. Y                                | 10. Not connected |
| 3. P <sub>B</sub> (C <sub>B</sub> ) | 11. Not connected |
| 4. Not connected                    | 12. Not connected |
| 5. Not connected                    | 13. Not connected |
| 6. Earth (P <sub>R</sub> )          | 14. Not connected |
| 7. Earth (Y)                        | 15. Not connected |
| 8. Earth (P <sub>B</sub> )          |                   |

**RS-232C Port:** 9-pin D-sub male connector

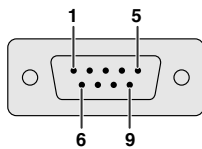

Pin No.	Signal	Name	I/O	Reference
1	CD			Not connected
2	RD	Receive Data	Input	Connected to internal circuit
3	SD	Send Data	Output	Connected to internal circuit
4	ER			Not connected
5	SG	Signal Ground		Connected to internal circuit
6	DR	Data Set Ready		Not connected
7	RS	Request to Send	Output	Connected to internal circuit
8	CS	Clear to Send	Input	Connected to internal circuit
9	CI			Not connected

**RS-232C Cable recommended connection:** 9-pin D-sub female connector

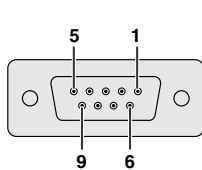

Pin No.	Signal	Pin No.	Signal
1	CD	1	CD
2	RD	2	RD
3	SD	3	SD
4	ER	4	ER
5	SG	5	SG
6	DR	6	DR
7	RS	7	RS
8	CS	8	CS
9	CI	9	CI

**INPUT 3 DVI Port:** 29-pin

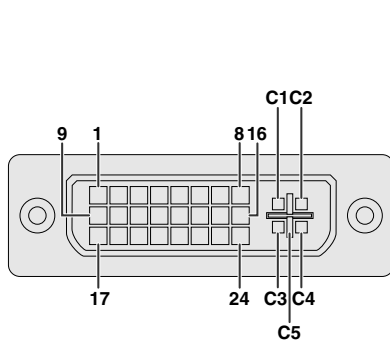

Pin No.	Name	Pin No.	Name
1	T.M.D.S. Data 2 -	16	Hot Plug Detect
2	T.M.D.S. Data 2 +	17	T.M.D.S. Data 0 -
3	T.M.D.S. Data 2/4 Shield	18	T.M.D.S. Data 0 +
4	T.M.D.S. Data 4 - * <sup>3</sup>	19	T.M.D.S. Data 0/5 Shield
5	T.M.D.S. Data 4 + * <sup>3</sup>	20	T.M.D.S. Data 5 - * <sup>3</sup>
6	DDC Clock	21	T.M.D.S. Data 5 + * <sup>3</sup>
7	DDC Data	22	T.M.D.S. Clock Shield
8	Analog Vertical Sync	23	T.M.D.S. Clock +
9	T.M.D.S. Data 1 -	24	T.M.D.S. Clock -
10	T.M.D.S. Data 1 +	C1	Analog Red
11	T.M.D.S. Data 1/3 Shield	C2	Analog Green
12	T.M.D.S. Data 3 - * <sup>3</sup>	C3	Analog Blue
13	T.M.D.S. Data 3 + * <sup>3</sup>	C4	Analog Horizontal sync
14	+5 V Power	C5	Analog Ground* <sup>2</sup>
15	Ground* <sup>1</sup>		

### NOTE

- \*<sup>1</sup> Return for +5 V, Hsync, and Vsync.
- \*<sup>2</sup> Analog R, G and B return
- \*<sup>3</sup> These pins are not used on this equipment.



## (RS-232C) Specifications and Command Settings

### PC control

A computer can be used to control the projector by connecting an RS-232C cable (cross type, sold separately) to the projector. (See page 19 for connection.)

### Communication conditions

Set the serial port settings of the computer to match that of the table.

Signal format: Conforms to RS-232C standard.

Baud rate: 9,600 bps

Data length: 8 bits

Parity bit: None

Stop bit: 1 bit

Flow control: None

### Basic format

Commands from the computer are sent in the following order: command, parameter, and return code. After the projector processes the command from the computer, it sends a response code to the computer.

Command format



Response code format

Normal response



Problem response (communication error or incorrect command)



When more than one code is being sent, send each command only after the OK response code for the previous command from the projector is verified.

#### NOTE

- When using the computer control function of the projector, the projector operating status cannot be read to the computer. Therefore, confirm the status by transmitting the display commands for each adjustment menu and checking the status with the On-screen Display. If the projector receives a command other than a menu display command, it will execute the command without displaying the On-screen Display.
- When the projector is in standby mode, send each command more than 1 minute after the previous command.

### Commands

#### EXAMPLE

- When "BRIGHT" of INPUT 1 (RGB 1) image adjustment is set to -10.

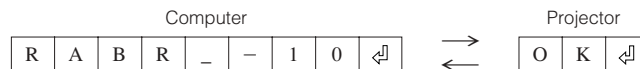

	CONTROL CONTENTS	COMMAND	PARAMETER	RETURN
BUTTONS & REMOTE CONTROL KEY	POWER ON	P O W R	1	OK OR ERR
	POWER OFF	P O W R	0	OK OR ERR
	VOLUME (0 - 60)	V O L A	*	OK OR ERR
	MUTE ON	M U T E	1	OK OR ERR
	MUTE OFF	M U T E	0	OK OR ERR
	LENS FOCUS (-30 - +30)	L N F O	*	OK OR ERR
	LENS ZOOM (-30 - +30)	L N Z O	*	OK OR ERR
	KEYSTONE (-127 - +127)	K E Y S	*	OK OR ERR
	V-SIZE (-30 - +30)	V S I Z	*	OK OR ERR
	DIGITAL SHIFT (-96 - +96)	L N D I S	*	OK OR ERR

	CONTROL CONTENTS	COMMAND	PARAMETER	RETURN
BUTTONS & REMOTE CONTROL KEY	BLACK SCREEN ON	I M B K	1	OK OR ERR
	BLACK SCREEN OFF	I M B K	0	OK OR ERR
	INPUT 1 (RGB 1)	I R G B	1	OK OR ERR
	INPUT 2 (RGB 2)	I R G B	2	OK OR ERR
	INPUT 3 (RGB 3)	I R G B	3	OK OR ERR
	INPUT 4 (VIDEO 1)	I V E D	1	OK OR ERR
	INPUT 5 (VIDEO 2)	I V E D	2	OK OR ERR
	INPUT CHECK	I C H K	0	OK OR ERR
	FREEZE ON	F R E Z	1	OK OR ERR
	FREEZE OFF	F R E Z	0	OK OR ERR
AUTO SYNC START	A D J S	1	OK OR ERR	





# (RS-232C) Specifications and Command Settings

	CONTROL CONTENTS	COMMAND	PARAMETER	RETURN
BUTTONS & REMOTE CONTROL KEY	INPUT 1 (RGB 1) RESIZE : NORMAL	RASR	--	1 OK OR ERR
	INPUT 1 (RGB 1) RESIZE : FULL	RASR	--	5 OK OR ERR
	INPUT 1 (RGB 1) RESIZE : DOT BY DOT	RASR	--	3 OK OR ERR
	INPUT 2 (RGB 2) RESIZE : NORMAL	RBSR	--	1 OK OR ERR
	INPUT 2 (RGB 2) RESIZE : FULL	RBSR	--	5 OK OR ERR
	INPUT 2 (RGB 2) RESIZE : DOT BY DOT	RBSR	--	3 OK OR ERR
	INPUT 3 (RGB 3) RESIZE : NORMAL	RCSR	--	1 OK OR ERR
	INPUT 3 (RGB 3) RESIZE : FULL	RCSR	--	5 OK OR ERR
	INPUT 3 (RGB 3) RESIZE : DOT BY DOT	RCSR	--	3 OK OR ERR
	INPUT 4 (VIDEO 1) RESIZE : NORMAL	RA SV	--	1 OK OR ERR
	INPUT 4 (VIDEO 1) RESIZE : FULL	RA SV	--	5 OK OR ERR
	INPUT 4 (VIDEO 1) RESIZE : BORDER	RA SV	--	3 OK OR ERR
	INPUT 4 (VIDEO 1) RESIZE : STRETCH	RA SV	--	2 OK OR ERR
	INPUT 4 (VIDEO 1) RESIZE : SMART STRETCH	RA SV	--	4 OK OR ERR
	INPUT 5 (VIDEO 2) RESIZE : NORMAL	RBSV	--	1 OK OR ERR
	INPUT 5 (VIDEO 2) RESIZE : FULL	RBSV	--	5 OK OR ERR
	INPUT 5 (VIDEO 2) RESIZE : BORDER	RBSV	--	3 OK OR ERR
	INPUT 5 (VIDEO 2) RESIZE : STRETCH	RBSV	--	2 OK OR ERR
	INPUT 5 (VIDEO 2) RESIZE : SMART STRETCH	RBSV	--	4 OK OR ERR
	RGB GAMMA : STANDARD	GAMR	--	1 OK OR ERR
	RGB GAMMA : PRESENTATION	GAMR	--	2 OK OR ERR
	RGB GAMMA : CINEMA	GAMR	--	3 OK OR ERR
	RGB GAMMA : CUSTOM	GAMR	--	4 OK OR ERR
	VIDEO GAMMA : STANDARD	GAMV	--	1 OK OR ERR
	VIDEO GAMMA : PRESENTATION	GAMV	--	2 OK OR ERR
	VIDEO GAMMA : CINEMA	GAMV	--	3 OK OR ERR
	VIDEO GAMMA : CUSTOM	GAMV	--	4 OK OR ERR
	INPUT 1 (RGB 1) CONTRAST (-30 ~ +30)	RAPI	**	OK OR ERR
	INPUT 1 (RGB 1) BRIGHT (-30 ~ +30)	RABR	**	OK OR ERR
	INPUT 1 (RGB 1) RED (-30 ~ +30)	RARD	**	OK OR ERR
	INPUT 1 (RGB 1) BLUE (-30 ~ +30)	RABE	**	OK OR ERR
	INPUT 1 (RGB 1) COLOR (-30 ~ +30)	RACO	**	OK OR ERR
	INPUT 1 (RGB 1) TINT (-30 ~ +30)	RATI	**	OK OR ERR
	INPUT 1 (RGB 1) SHARP (-30 ~ +30)	RASH	**	OK OR ERR
	INPUT 1 (RGB 1) CLR TEMP (-3 ~ +3)	RACT	**	OK OR ERR
INPUT 1 (RGB 1) DISPLAY	RARE	--	0 OK OR ERR	
INPUT 1 (RGB 1) ADJUSTMENT RESET	RARE	--	1 OK OR ERR	
INPUT 2 (RGB 2) CONTRAST (-30 ~ +30)	RBP I	**	OK OR ERR	
INPUT 2 (RGB 2) BRIGHT (-30 ~ +30)	RBBR	**	OK OR ERR	
INPUT 2 (RGB 2) RED (-30 ~ +30)	RBRD	**	OK OR ERR	
INPUT 2 (RGB 2) BLUE (-30 ~ +30)	RBBE	**	OK OR ERR	
INPUT 2 (RGB 2) COLOR (-30 ~ +30)	RBCO	**	OK OR ERR	
INPUT 2 (RGB 2) TINT (-30 ~ +30)	RBT I	**	OK OR ERR	
INPUT 2 (RGB 2) SHARP (-30 ~ +30)	RBSH	**	OK OR ERR	
INPUT 2 (RGB 2) CLR TEMP (-3 ~ +3)	RBC T	**	OK OR ERR	
INPUT 2 (RGB 2) DISPLAY	RBRE	--	0 OK OR ERR	
INPUT 2 (RGB 2) ADJUSTMENT RESET	RBRE	--	1 OK OR ERR	
INPUT 3 (RGB 3) CONTRAST (-30 ~ +30)	RCP I	**	OK OR ERR	
INPUT 3 (RGB 3) BRIGHT (-30 ~ +30)	RCBR	**	OK OR ERR	
INPUT 3 (RGB 3) RED (-30 ~ +30)	RCRD	**	OK OR ERR	
INPUT 3 (RGB 3) BLUE (-30 ~ +30)	RCE	**	OK OR ERR	
INPUT 3 (RGB 3) COLOR (-30 ~ +30)	RCCO	**	OK OR ERR	
INPUT 3 (RGB 3) TINT (-30 ~ +30)	RCT I	**	OK OR ERR	
INPUT 3 (RGB 3) SHARP (-30 ~ +30)	RCH	**	OK OR ERR	
INPUT 3 (RGB 3) CLR TEMP (-3 ~ +3)	RCC T	**	OK OR ERR	
INPUT 3 (RGB 3) DISPLAY	RCRE	--	0 OK OR ERR	
INPUT 3 (RGB 3) ADJUSTMENT RESET	RCRE	--	1 OK OR ERR	

	CONTROL CONTENTS	COMMAND	PARAMETER	RETURN
PICTURE	INPUT 1 (RGB 1) SIGNAL TYPE : RGB	IASI	--	1 OK OR ERR
	INPUT 1 (RGB 1) SIGNAL TYPE : COMPONENT	IASI	--	2 OK OR ERR
	INPUT 2 (RGB 2) SIGNAL TYPE : RGB	IBSI	--	1 OK OR ERR
	INPUT 2 (RGB 2) SIGNAL TYPE : COMPONENT	IBSI	--	2 OK OR ERR
	INPUT 1 (RGB 1) 2D PROGRESSIVE	RAIP	--	0 OK OR ERR
	INPUT 1 (RGB 1) 3D PROGRESSIVE	RAIP	--	1 OK OR ERR
	INPUT 1 (RGB 1) Film MODE	RAIP	--	2 OK OR ERR
	INPUT 2 (RGB 2) 2D PROGRESSIVE	RBI P	--	0 OK OR ERR
	INPUT 2 (RGB 2) 3D PROGRESSIVE	RBI P	--	1 OK OR ERR
	INPUT 2 (RGB 2) Film MODE	RBI P	--	2 OK OR ERR
	INPUT 3 (RGB 3) 2D PROGRESSIVE	RCI P	--	0 OK OR ERR
	INPUT 3 (RGB 3) 3D PROGRESSIVE	RCI P	--	1 OK OR ERR
	INPUT 3 (RGB 3) Film MODE	RCI P	--	2 OK OR ERR
	INPUT 4 (VIDEO 1) CONTRAST (-30 ~ +30)	VAPI	**	OK OR ERR
	INPUT 4 (VIDEO 1) BRIGHT (-30 ~ +30)	VABR	**	OK OR ERR
	INPUT 4 (VIDEO 1) RED (-30 ~ +30)	VARD	**	OK OR ERR
	INPUT 4 (VIDEO 1) BLUE (-30 ~ +30)	VABE	**	OK OR ERR
	INPUT 4 (VIDEO 1) COLOR (-30 ~ +30)	VACO	**	OK OR ERR
	INPUT 4 (VIDEO 1) TINT (-30 ~ +30)	VATI	**	OK OR ERR
	INPUT 4 (VIDEO 1) SHARP (-30 ~ +30)	VASH	**	OK OR ERR
	INPUT 4 (VIDEO 1) CLR TEMP (-3 ~ +3)	VACT	**	OK OR ERR
	INPUT 4 (VIDEO 1) DISPLAY	VARE	--	0 OK OR ERR
	INPUT 4 (VIDEO 1) ADJUSTMENT RESET	VARE	--	1 OK OR ERR
	INPUT 5 (VIDEO 2) CONTRAST (-30 ~ +30)	VBP I	**	OK OR ERR
	INPUT 5 (VIDEO 2) BRIGHT (-30 ~ +30)	VBBR	**	OK OR ERR
	INPUT 5 (VIDEO 2) RED (-30 ~ +30)	VBRD	**	OK OR ERR
	INPUT 5 (VIDEO 2) BLUE (-30 ~ +30)	VBBE	**	OK OR ERR
	INPUT 5 (VIDEO 2) COLOR (-30 ~ +30)	VBCO	**	OK OR ERR
	INPUT 5 (VIDEO 2) TINT (-30 ~ +30)	VBT I	**	OK OR ERR
	INPUT 5 (VIDEO 2) SHARP (-30 ~ +30)	VBSH	**	OK OR ERR
	INPUT 5 (VIDEO 2) CLR TEMP (-3 ~ +3)	VBC T	**	OK OR ERR
	INPUT 5 (VIDEO 2) DISPLAY	VBRE	--	0 OK OR ERR
	INPUT 5 (VIDEO 2) ADJUSTMENT RESET	VBRE	--	1 OK OR ERR
	INPUT 4 (VIDEO 1) 2D PROGRESSIVE	VAI P	--	0 OK OR ERR
	INPUT 4 (VIDEO 1) 3D PROGRESSIVE	VAI P	--	1 OK OR ERR
INPUT 4 (VIDEO 1) Film MODE	VAI P	--	2 OK OR ERR	
INPUT 5 (VIDEO 2) 2D PROGRESSIVE	VBI P	--	0 OK OR ERR	
INPUT 5 (VIDEO 2) 3D PROGRESSIVE	VBI P	--	1 OK OR ERR	
INPUT 5 (VIDEO 2) Film MODE	VBI P	--	2 OK OR ERR	
(INPUT 1-5) 2D PROGRESSIVE	IMI P	--	0 OK OR ERR	
(INPUT 1-5) 3D PROGRESSIVE	IMI P	--	1 OK OR ERR	
(INPUT 1-5) Film MODE	IMI P	--	2 OK OR ERR	
CLOCK (-150 ~ +150)	INCL	**	OK OR ERR	
PHASE (-60 ~ +60)	INPH	**	OK OR ERR	
H-POSITION (-150 ~ +150)	IAHP	**	OK OR ERR	
V-POSITION (-60 ~ +60)	IAVP	**	OK OR ERR	
RGB INPUT DISPLAY	IARE	--	0 OK OR ERR	
RGB ADJUSTMENT RESET	IARE	--	1 OK OR ERR	
SAVE SETTING (1-7)	MEMS	--	0 OK OR ERR	
SELECT SETTING (1-7)	MEML	--	0 OK OR ERR	
RGB HORIZONTAL FREQUENCY CHECK	TFRO	--	1 kHz (***, * OR _)	
RGB VERTICAL FREQUENCY CHECK	TFRO	--	2 Hz (***, * OR _)	
AUTO SYNC OFF	AADJ	--	0 OK OR ERR	
NORMAL AUTO SYNC	AADJ	--	1 OK OR ERR	
HIGH SPEED AUTO SYNC	AADJ	--	2 OK OR ERR	
AUTO SYNC DISPLAY ON	IMAS	--	1 OK OR ERR	
AUTO SYNC DISPLAY OFF	IMAS	--	0 OK OR ERR	





## (RS-232C) Specifications and Command Settings

	CONTROL CONTENTS	COMMAND	PARAMETER	RETURN
AUDIO	BALANCE (-30 - +30)	AABL	* *	OK OR ERR
	TREBLE (-30 - +30)	ATE	* *	OK OR ERR
	BASS (-30 - +30)	ABA	* *	OK OR ERR
	AUDIO DISPLAY	ARE	-	0 OK OR ERR
	AUDIO ADJUSTMENT RESET	ARE	-	1 OK OR ERR
	FAO	AOUT	-	1 OK OR ERR
	VAD	AOUT	-	2 OK OR ERR
	SPEAKER ON	ASP	-	1 OK OR ERR
	SPEAKER OFF	ASP	-	0 OK OR ERR
	OPTIONS (1)	PICT IN PICT : BOTTOM RIGHT	PIINP	1
PICT IN PICT : BOTTOM LEFT		PIINP	2	OK OR ERR
PICT IN PICT : UPPER RIGHT		PIINP	3	OK OR ERR
PICT IN PICT : UPPER LEFT		PIINP	4	OK OR ERR
PICT IN PICT RESET		PIINP	-	0 OK OR ERR
VIDEO DNR OFF		3DNR	-	0 OK OR ERR
VIDEO DNR ON		3DNR	-	1 OK OR ERR
OSD DISPLAY ON		IMDI	-	1 OK OR ERR
OSD DISPLAY OFF (LEVEL A)		IMDI	-	2 OK OR ERR
OSD DISPLAY OFF (LEVEL B)		IMDI	-	0 OK OR ERR
BLACK SCREEN DISPLAY ON		IMBO	-	1 OK OR ERR
BLACK SCREEN DISPLAY OFF		IMBO	-	0 OK OR ERR
VIDEO SYSTEM SELECTION : AUTO		MESY	-	1 OK OR ERR
VIDEO SYSTEM SELECTION : PAL		MESY	-	2 OK OR ERR
VIDEO SYSTEM SELECTION : SECAM		MESY	-	3 OK OR ERR
VIDEO SYSTEM SELECTION : NTSC4.43		MESY	-	4 OK OR ERR
VIDEO SYSTEM SELECTION : NTSC3.58		MESY	-	5 OK OR ERR
VIDEO SYSTEM SELECTION : PAL_M		MESY	-	6 OK OR ERR
VIDEO SYSTEM SELECTION : PAL_N		MESY	-	7 OK OR ERR
BACKGROUND SELECTION : SHARP		IMBG	-	1 OK OR ERR
BACKGROUND SELECTION : CUSTOM		IMBG	-	2 OK OR ERR
BACKGROUND SELECTION : BLUE		IMBG	-	3 OK OR ERR
BACKGROUND SELECTION : NONE		IMBG	-	4 OK OR ERR
STARTUP IMAGE SELECTION : SHARP		IMSI	-	1 OK OR ERR
STARTUP IMAGE SELECTION : CUSTOM		IMSI	-	2 OK OR ERR
STARTUP IMAGE SELECTION : NONE	IMSI	-	3 OK OR ERR	
POWER SAVE MODE : STANDARD	THMD	-	0 OK OR ERR	
POWER SAVE MODE : LOW POWER	THMD	-	1 OK OR ERR	
MONITOR OUT OFF	MOUT	-	0 OK OR ERR	
MONITOR OUT ON	MOUT	-	1 OK OR ERR	
AUTO POWER OFF : NO USE	APOW	-	0 OK OR ERR	
AUTO POWER OFF : USE	APOW	-	1 OK OR ERR	

	CONTROL CONTENTS	COMMAND	PARAMETER	RETURN
OPTIONS (2)	LAMP USAGE TIME	TLTT	-	1 0-9999 (INTEGER)
	LAMP STATUS	TLPS	-	1 0:OFF, 1:ON, 2:RETRY, 3:WAITING, 4:LAMP ERROR
	PRJ MODE : REVERSE OFF	IMRE	-	0 OK OR ERR
	PRJ MODE : REVERSE ON	IMRE	-	1 OK OR ERR
	PRJ MODE : INVERT OFF	IMIN	-	0 OK OR ERR
	PRJ MODE : INVERT ON	IMIN	-	1 OK OR ERR
	STACK SETTING : NORMAL	STAK	-	0 OK OR ERR
	STACK SETTING : MASTER	STAK	-	1 OK OR ERR
	STACK SETTING : SLAVE	STAK	-	2 OK OR ERR
	KEYLOCK LEVEL : NORMAL	KEYL	-	0 OK OR ERR
KEYLOCK LEVEL : LEVEL A	KEYL	-	1 OK OR ERR	
KEYLOCK LEVEL : LEVEL B	KEYL	-	2 OK OR ERR	
SET INPUTS : INPUT 1 NO USE	RASI	-	0 OK OR ERR	
SET INPUTS : INPUT 1 USE	RASI	-	1 OK OR ERR	
SET INPUTS : INPUT 2 NO USE	RBSI	-	0 OK OR ERR	
SET INPUTS : INPUT 2 USE	RBSI	-	1 OK OR ERR	
SET INPUTS : INPUT 3 NO USE	RCSI	-	0 OK OR ERR	
SET INPUTS : INPUT 3 USE	RCSI	-	1 OK OR ERR	
SET INPUTS : INPUT 4 NO USE	VASI	-	0 OK OR ERR	
SET INPUTS : INPUT 4 USE	VASI	-	1 OK OR ERR	
SET INPUTS : INPUT 5 NO USE	VBSI	-	0 OK OR ERR	
SET INPUTS : INPUT 5 USE	VBSI	-	1 OK OR ERR	
ID NO. CHECK	RDIID	-	1 001-250	
LANGUAGE	LANGUAGE SELECTION : ENGLISH	MELA	-	0 OK OR ERR
	LANGUAGE SELECTION : DEUTSCH	MELA	-	1 OK OR ERR
	LANGUAGE SELECTION : ESPAÑOL	MELA	-	2 OK OR ERR
	LANGUAGE SELECTION : NEDERLANDS	MELA	-	3 OK OR ERR
	LANGUAGE SELECTION : FRANÇAIS	MELA	-	4 OK OR ERR
	LANGUAGE SELECTION : ITALIANO	MELA	-	5 OK OR ERR
	LANGUAGE SELECTION : SVENSKA	MELA	-	6 OK OR ERR
	LANGUAGE SELECTION : 日本語	MELA	-	7 OK OR ERR
	LANGUAGE SELECTION : PORTUGUÊS	MELA	-	8 OK OR ERR
	LANGUAGE SELECTION : 汉语	MELA	-	9 OK OR ERR
LANGUAGE SELECTION : 한국어	MELA	-	10 OK OR ERR	
MODEL NAME CHECK	MNRD	-	1 MODEL NAME	
NOISE FILTER OFF	NFIL	-	0 OK OR ERR	
NOISE FILTER ON <sup>2</sup>	NFIL	-	1 OK OR ERR	
SERIAL NO. CHECK <sup>3</sup>	SNRD	-	1 SERIAL NO.	
PROJECTOR NAME SETTING <sup>4</sup>	PJNA	-	1 OK OR ERR	
PROJECTOR NAME CHECK	PJNA	-	2 PROJECTOR NAME	

### NOTE

- If an underbar ( \_ ) appears in the parameter column, enter a space. If an asterisk ( \* ) appears, enter a value in the range indicated in brackets under CONTROL CONTENTS.
- <sup>1</sup> FINE SYNC can only be set in the displayed RGB mode.
- <sup>2</sup> Noise may appear when used with certain computers. Set the NOISE FILTER to ON using the RS-232C command.
- <sup>3</sup> SERIAL NO. CHECK command is used to read out the 12 digits of serial No.
- <sup>4</sup> After OK is returned, enter PROJECTOR NAME, up to 12-character memory. The PROJECTOR NAME in memory can then be output (confirmed).





# Wired Remote Control Terminal Specifications

## Specifications of wired remote control input

- ø3.5 mm minijack
- External: +5 V (1 A)
- Internal: GND

## Function and transmission codes

CONTROL ITEM	SYSTEM CODE					DATA CODE					EXTERNAL CODE				
	C1	C2	C3	C4	C5	C6	C7	C8	C9	C10	C11	C12	C13	C14	C15
ON	1	0	1	1	0	0	1	1	0	1	0	1	0	1	0
OFF	1	0	1	1	0	0	1	1	0	1	0	0	1	1	0
VOLUME +	1	0	1	1	0	0	0	1	0	1	0	0	0	1	0
VOLUME -	1	0	1	1	0	1	0	1	0	1	0	0	0	1	0
MUTE	1	0	1	1	0	1	1	1	0	1	0	0	0	1	0
MENU	1	0	1	1	0	0	0	1	0	0	0	1	1	1	0
LENS	1	0	1	1	0	1	1	0	1	0	0	0	1	1	0
BLACK SCREEN	1	0	1	1	0	1	0	0	1	0	1	1	0	1	0
ENTER	1	0	1	1	0	1	1	1	0	1	0	1	0	1	0
RESIZE	1	0	1	1	0	0	1	1	1	1	0	1	0	1	0
UNDO	1	0	1	1	0	1	0	0	1	1	0	1	0	1	0
Freeze	1	0	1	1	0	1	0	1	1	0	0	0	1	1	0
Break Timer	1	0	1	1	0	0	0	1	0	1	1	0	1	1	0

CONTROL ITEM	SYSTEM CODE					DATA CODE					EXTERNAL CODE				
	C1	C2	C3	C4	C5	C6	C7	C8	C9	C10	C11	C12	C13	C14	C15
Enlarge+	1	0	1	1	0	1	0	1	1	0	1	1	0	1	0
Enlarge-	1	0	1	1	0	1	0	1	1	0	1	0	1	1	0
AUTO SYNC	1	0	1	1	0	0	1	0	1	1	1	1	1	1	0
▲	1	0	1	1	0	0	0	1	1	1	0	0	1	1	0
▼	1	0	1	1	0	1	0	1	1	1	0	0	1	1	0
◀	1	0	1	1	0	0	0	0	1	0	1	1	0	1	0
▶	1	0	1	1	0	1	1	1	1	0	0	1	0	1	0
GAMMA	1	0	1	1	0	0	0	0	0	0	0	1	0	1	0
INPUT 1	1	0	1	1	0	1	0	1	0	1	1	0	0	1	0
INPUT 2	1	0	1	1	0	0	1	1	0	1	1	0	0	1	0
INPUT 3	1	0	1	1	0	1	0	1	0	1	1	0	1	1	0
INPUT 4	1	0	1	1	0	0	1	0	0	1	1	0	0	1	0
INPUT 5	1	0	1	1	0	1	1	0	0	1	1	0	0	1	0

### NOTE

- To operate the mouse, left-click and right-click functions through the wired remote control input, connect the cable from the WIRED REMOTE control input terminal on the projector to the remote control. The codes for these functions are complex and are, therefore, not listed here.

### Wired remote control function code

LSB										MSB				
C1	C2	C3	C4	C5	C6	C7	C8	C9	C10	C11	C12	C13	C14	C15
1	1	0	1	1	0	.	.	.	.	.	.	.	.	.

- System codes C1 to C5 are fixed at "10110".
- Codes C14 and C15 are reverse confirmation bits, with "10" indicating "Front" and "01" indicating "Rear".

## Sharp remote control signal format

### Transmission format: 15-bit format

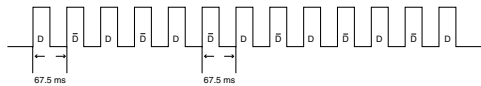

### Wave form of output signal: Output using Pulse Position Modulation

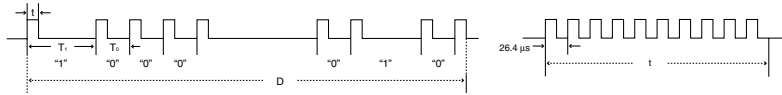

- $t = 264 \mu\text{s}$
- $T_0 = 1.05 \text{ ms}$
- $T_1 = 2.10 \text{ ms}$
- Pulse carrier frequency = 455/12 kHz
- Duty ratio = 1:1

### Transmission control code

15 bit

C1	C2	C3	C4	C5	C6	C7	C8	C9	C10	C11	C12	C13	C14	C15
System Address					Function Key Data Bit					Data Expansion		Mask	Data Determination	
D to $\bar{D}$ Common Data Bit					Reverse in $\bar{D}$									

### Example of Reverse D to $\bar{D}$

D	C1	C2	C3	C4	C5	C6	C7	C8	C9	C10	C11	C12	C13	C14	C15
1	0	1	1	0	1	0	0	0	0	0	0	0	0	1	0
$\bar{D}$	C1	C2	C3	C4	C5	C6	C7	C8	C9	C10	C11	C12	C13	C14	C15
1	0	1	1	0	0	1	1	1	1	1	1	1	1	0	1



# Compatibility Chart

## Computer

Horizontal Frequency: 15–126 kHz / Vertical Frequency: 43–200 Hz / Pixel Clock: 12–230 MHz  
 Compatible with sync on green and composite sync signals  
 UXGA and SXGA compatible in advanced intelligent compression or intelligent compression  
 AICS (Advanced Intelligent Compression and Expansion System) resizing technology

PC/MAC/WS	Resolution	Horizontal Frequency (kHz)	Vertical Frequency (Hz)	VESA Standard	DVI Support	Display									
PC	640 × 350	27.0	60			Upscale									
		31.5	70												
		37.9	85	✓											
		27.0	60												
		720 × 350	31.5	70											
			27.0	60											
	640 × 400	27.0	60												
		31.5	70												
		37.9	85	✓	✓										
		27.0	60		✓										
	720 × 400	31.5	70		✓										
		37.9	85	✓	✓										
		26.2	50												
		31.5	60		✓										
	640 × 480	34.7	70												
		37.9	72	✓	✓										
		37.5	75	✓	✓										
		43.3	85	✓	✓										
		47.9	90												
		53.0	100												
		61.8	120												
		78.5	150												
		80.9	160												
		100.4	200												
	SVGA	800 × 600	31.4	50											
			35.1	56	✓		✓								
			37.9	60	✓		✓								
			44.5	70											
			48.1	72	✓		✓								
			46.9	75	✓		✓								
			53.7	85	✓		✓								
			56.8	90											
			64.0	100											
			77.2	120											
			98.3	150											
			102.1	160											
			125.6	200											
			XGA	1,024 × 768	35.5		43		✓						
	40.3	50													
	48.4	60			✓		✓								
56.5	70	✓			✓										
58.1	72														
60.0	75	✓			✓										
68.7	85	✓			✓										
73.5	90														
77.2	96														
80.6	100														
98.8	120														
113.2	140														
PC	SXGA	1,152 × 864			54.3	60		✓							
					64.0	70									
			64.1	72											
			67.5	75	✓	✓									
			75.7	80											
			77.3	85											
			90.2	100											
		1,152 × 882	54.8	60											
			65.9	72											
			67.4	74											
			64.0	60	✓	✓									
			74.6	70											
			78.1	74											
			80.0	75	✓										
	1,280 × 1,024	91.1	85	✓											
		108.4	100												
		64.0	60												
		SXGA+	1,400 × 1,050	64.0	60										
				74.7	52										
		UXGA	1,600 × 1,200	75.0	60	✓									
				81.3	65	✓									
	87.5			70	✓										
	90.1			72											
	93.8			75	✓										
	106.3			85	✓										
	PC/MAC 13"			VGA	640 × 480	34.9	67								
						48.4	60	✓	✓						
						60.0	75	✓	✓						
PC/MAC 19"						XGA	1,024 × 768	48.4	60	✓	✓				
		60.0	75					✓	✓						
		PC/MAC 21"	SXGA					1,280 × 1,024	80.0	75	✓				
									MAC 16"	SVGA	832 × 624	46.8	75		
												49.6	75		
									MAC 21"	SXGA	1,152 × 870	68.5	75		
									HP (WS)	1,280 × 1,024	78.1	72			
									PC (WS)	1,280 × 960	60.0	60	✓		
											85.9	85			
									SGI (WS)	SXGA	1,280 × 1,024	53.5	50		
												76.8	72		
	SUN (WS)			1,152 × 900	60.9				66						
	71.9			76											

### NOTE

- This projector may not be able to display images from notebook computers in simultaneous (CRT/LCD) mode. Should this occur, turn off the LCD display on the notebook computer and output the display data in "CRT only" mode. Details on how to change display modes can be found in your notebook computer's operation manual.
- This projector can receive 640 × 350 VESA format VGA signals, however, "640 × 400" will appear on the screen.
- When receiving 1,600 × 1,200 VESA format UXGA signals, sampling occurs and the image is displayed with 1,024 lines, causing part of the image to be blocked.

### DTV

Signal	Horizontal Frequency (kHz)	Vertical Frequency (Hz)
480I	15.7	60
480P	31.5	60
580I	15.6	50
580P	31.3	50
720P	45.0	60
1035I	33.8	60
1080I	33.8	60





# Dimensions

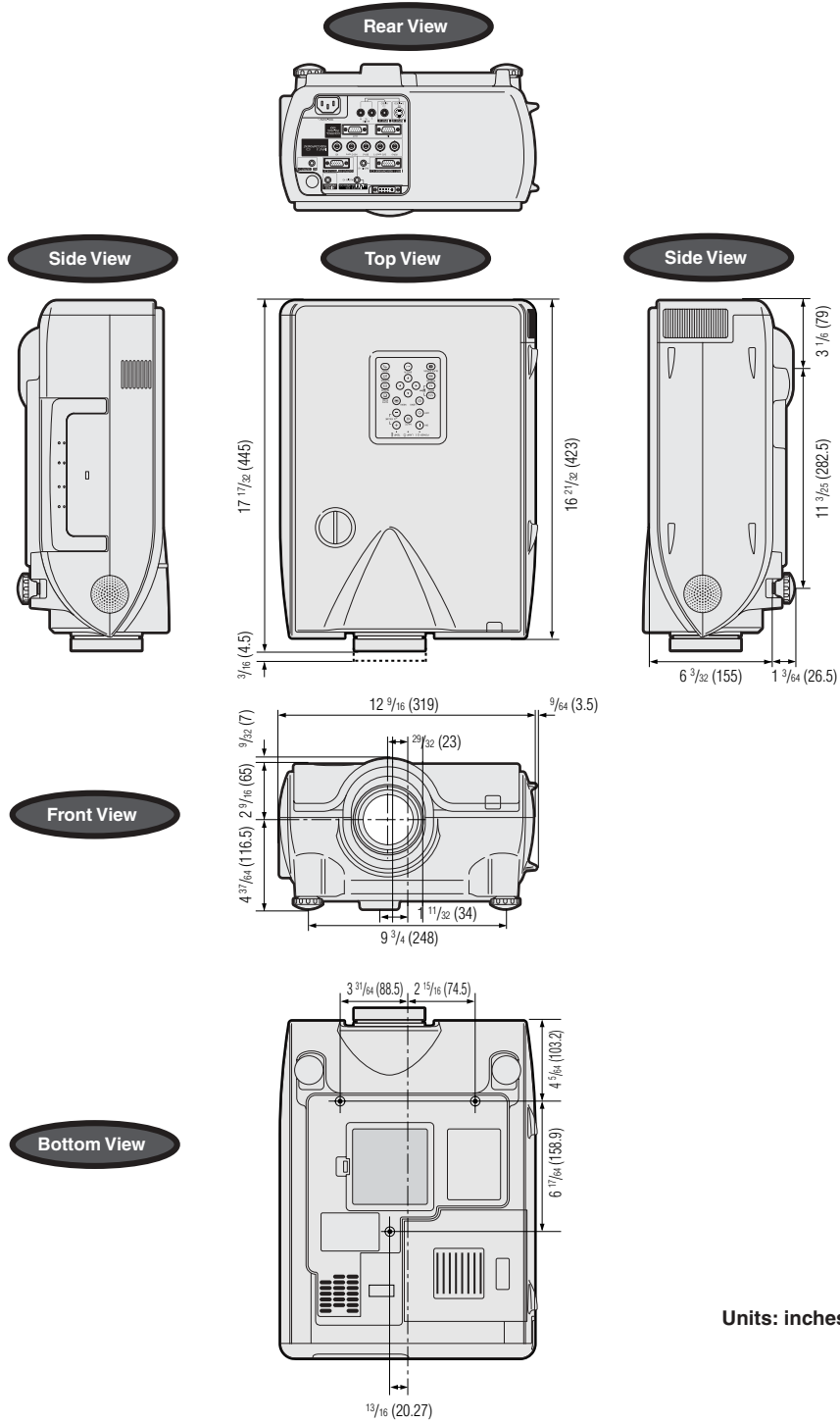

Units: inches (mm)

Appendix



## Specifications

Product type	LCD Projector
Model	XG-P25X
Video system	PAL/PAL 60/PAL-M/PAL-N/SECAM/NTSC 3.58/NTSC 4.43 DTV 480I/480P/580I/580P/720P/1035I/1080I
Display method	LCD panel × 3, RGB optical shutter method
LCD panel	Panel size: 1.3" (33mm) (20.0 [H] × 26.6 [W] mm) Display method: Translucent TN liquid crystal panel Drive method: TFT (Thin Film Transistor) Active Matrix panel No. of dots: 786,432 dots (1,024 [H] × 768 [V])
Standard Lens	1–1.3 × zoom lens, F1.7–2.4, f = 49.2–63.8 mm
Projection lamp	AC 270 W lamp
Video input signal	RCA Connector (INPUT 4): VIDEO, composite video, 1.0 Vp-p, sync negative, 75 Ω terminated RCA Connector: AUDIO, 0.5 Vrms more than 22 kΩ (stereo)
S-video input signal	4-pin Mini DIN connector (INPUT 5) Y (luminance signal): 1.0 Vp-p, sync negative, 75 Ω terminated C (chrominance signal): Burst 0.286 Vp-p, 75 Ω terminated
Component input signal	BNC Connector (INPUT 2) Y: 1.0 Vp-p, sync negative, 75 Ω terminated Pb: 0.7 Vp-p, 75 Ω terminated Pr: 0.7 Vp-p, 75 Ω terminated
Horizontal resolution	520 TV lines (S-video input), 750 TV lines (DTV 720P input, STRETCH mode)
RGB input signal	15-PIN MINI D-SUB CONNECTOR (INPUT 1), 5 BNC CONNECTOR (INPUT 2): RGB separate/composite sync/sync on green type analog input: 0–0.7 Vp-p, positive, 75 Ω terminated DVI CONNECTOR (29-PIN) (INPUT 3), RGB (DIGITAL), 250–1,000 mV, 50 Ω HORIZONTAL SYNC. SIGNAL: TTL level (positive/negative) or composite sync (Apple only) VERTICAL SYNC. SIGNAL: Same as above STEREO MINIJACK: AUDIO, 0.5 Vrms, more than 22 kΩ (stereo)
Pixel clock	12–230 MHz
Vertical frequency	43–200 Hz
Horizontal frequency	15–126 kHz
Computer control signal	9-pin D-sub connector (RS-232C Input Port/Output Port)
Speaker system	1 49/64" (4.5 cm) round × 2 2 W + 2 W (stereo)
Rated voltage	AC 100–240 V
Input current	3.9 A
Rated frequency	50/60 Hz
Power consumption	380 W
Heat dissipation	1,430 BTU/hour
Operating temperature	41°F to 104°F (+5°C to +40°C)
Storage temperature	–4°F to 140°F (–20°C to +60°C)
Cabinet	Plastic
Dimensions (approx.)	12 3/16" (W) × 6 3/32" (H) × 16 21/32" (D) (319.0 × 155.0 × 423.0 mm) (main body only) 12 11/32" (W) × 7 27/64" (H) × 17 17/32" (D) (322.5 × 188.5 × 445.0 mm) (including standard lens, adjustment feet and projecting parts)
Weight (approx.)	21.4 lbs. (9.7 kg)
Supplied accessories	Remote control, Two R-6 batteries, Power cord, RGB cable (9' 10", 3 m), Computer audio cable (9' 10", 3 m), Three BNC-RCA adaptors, Extra air filter, Lens cap, CD-ROM, LCD projector operation manual, Quick reference guides, ID number seal
Replacement parts	Lamp unit (Lamp/cage module) (BQC-XGP25X//1), Remote control (RRMCGA048WJSA), Two R-6 batteries ("AA" size, UM/SUM-3, HP-7 or similar), Power cord for U.S., Canada etc. (QACCDAA010WJPZ), Power cord for Europe, except U.K. (QACCV4002CEZZ), Power cord for U.K., Hong Kong and Singapore (QACCB5024CENA), Power cord for Australia, New Zealand and Oceania (QACCL3022CEZZ), RGB cable (QCNWGA012WJPZ), Computer audio cable (QCNWGA013WJPZ), BNC-RCA adaptors (QLPGJ0107GEZZ), Air filter (PFILD0080CEZZ), Lens cap (PCAPH1056CESA), CD-ROM (UDSKAA004WJZZ, UDSKAA005WJZZ), LCD projector operation manual (TINS-A133WJZZ), Quick reference guides, Sharp Advanced Presentation Software installation guide (TINS-A139WJZZ), ID number seal (TLABZ0781CEZZ)

This SHARP projector uses LCD (Liquid Crystal Display) panels. These very sophisticated panels contain 786,432 pixels (× RGB) TFTs (Thin Film Transistors). As with any high technology electronic equipment such as large screen TVs, video systems and video cameras, there are certain acceptable tolerances that the equipment must conform to.

This unit has some inactive TFTs within acceptable tolerances which may result in illuminated or inactive dots on the picture screen. This will not affect the picture quality or the life expectancy of the unit.

*Specifications are subject to change without notice.*





## Glossary

### **Aspect ratio**

Width and height ratio of an image. The normal aspect ratio of a computer and video image is 4:3. There are also wide images with an aspect ratio of 16:9 and 21:9.

### **Auto Sync**

Optimizes projected computer images by automatically adjusting certain characteristics.

### **Background**

Initial setting image projected when no signal is being input.

### **Border**

Projects a 4:3 image fully within a 16:9 screen by keeping the aspect ratio at 4:3.

### **Clock**

Clock adjustment is used to adjust vertical noise when clock level is incorrect.

### **CLR Temp (Color temperature)**

Function that can be used to adjust the color temperature to suit the type of image input to the projector. Decrease the color temperature to create warmer, reddish images for natural flesh tones, or increase to create cooler, bluish images for a brighter picture.

### **Composite sync**

Signal combining horizontal and vertical sync pulses.

### **Digital shift**

Shifts image up or down easily by ▲/▼ buttons when RESIZE mode of input image is BORDER, STRETCH or SMART STRETCH of COMPUTER (except for SXGA and UXGA), VIDEO and DTV inputs.

### **DNR (Digital Noise Reduction)**

Provides high quality images with minimal dot crawl and cross color noise.

### **Dot by dot**

Mode that projects images in their native resolution.

### **DVI**

Digital Visual Interface that supports both digital and analog displays.

### **GAMMA**

Image quality enhancement function that offers a richer image by brightening the darker portions of the image without altering the brightness of the brighter portions. You can select four different modes : STANDARD, PRESENTATION, CINEMA and CUSTOM.

### **Intelligent compression and expansion**

High quality resizing of lower and higher resolution images to fit the projector's native resolution.

### **Intelligent digital keystone correction**

Function to digitally correct a distorted image when the projector is set up at an angle, smooths out jaggies on keystone images and compresses the image not only horizontally but vertically keeping the 4:3 aspect ratio, and at the same time, calculates the aspect ratio automatically adjusting to the lens shift width.

### **Keylock level**

Mode that can lock the operation of projector buttons to prevent mischief.

### **Lens shift**

The lens can be easily raised and lowered to minimize or eliminate "Keystone" type effect.

### **Magnification (Enlarge)**

Digitally zooms in on a portion of an image.

### **Phase**

Phase shift is a timing shift between isomorphic signals with the same resolution. When phase level is incorrect, the projected image typically displays horizontal flicker.

### **Picture in Picture**

Allows you to add video images onto a data screen image, providing you with even more effective presentations.

### **Progressive Mode**

The progressive display projects a smoother video image. You can select three different modes : 2D Progressive, 3D Progressive and Film Mode.

### **RESIZE**

Allows you to modify or customize the picture display mode to enhance the input image. You can select six different modes: NORMAL, FULL, DOT BY DOT, BORDER, STRETCH and SMART STRETCH.

### **RS-232C**

Function to control the projector from the computer by using the RS-232C ports on the projector and computer.

### **Set Inputs**

Function to limit inputs. For example, when setting Input 2 to "OFF", the input is switchable only between Input 1 and Input 3, skipping Input 2.

### **Smart Stretch**

Projects the image fully in a 16:9 screen by enlarging only the surrounding areas while keeping the aspect ratio in the middle part of the image at 4:3.

### **Stack Setting**

Prevents trouble with adjustment and operation when stack projecting. When setting two projectors, one to master and the other to slave, the slave follows the master's operation.

### **Status function**

Displays the settings of each adjustment item.

### **Stretch**

Mode that stretches the 4:3 image horizontally to display it fully on a 16:9 screen.

### **Sync on green**

Video signal mode of a computer which overlaps horizontal and vertical sync signal to green color signal pin.





# Index

<b>A</b>	
AC socket .....	16
Adjusting the Picture .....	41
Adjustment Feet .....	23
Air filter .....	64
Aspect ratio .....	35
Audio .....	46
Audio cable .....	21
AUDIO INPUT terminal .....	17
AUDIO OUTPUT terminal .....	21
Auto sync adjustment .....	45
AUTO SYNC button .....	34
<b>B</b>	
Background .....	49
BLACK SCREEN button .....	32
BNC-RCA adaptors .....	21
BORDER .....	35
BREAK TIMER button .....	34
<b>C</b>	
Carrying handle .....	6
Ceiling-mount .....	30
Ceiling+Rear .....	51
Clock .....	43
CLR Temp (Color Temperature) .....	41
<b>D</b>	
Digital shift .....	24
DNR (Digital Noise Reduction) .....	47
DOT BY DOT .....	35
DVI INPUT port (INPUT 3) .....	19
<b>E</b>	
Economy Mode .....	50
ENLARGE buttons .....	33
ENTER button .....	38
Exhaust vent .....	5
Extra air filter .....	15
<b>F</b>	
FAO .....	46
FREEZE button .....	32
<b>G</b>	
GAMMA button .....	37
GUI (Graphical User Interface) .....	38
<b>I</b>	
INPUT buttons .....	31
INPUT port .....	17
<b>K</b>	
Keylock Levels .....	52
Keystone correction .....	24
<b>L</b>	
LAMP REPLACEMENT indicator .....	61
LENS button .....	24
Lens shift .....	23
<b>M</b>	
MENU button .....	38
Monitor Out/RS-232C Off Function .....	50
MUTE button .....	31
<b>N</b>	
Network Function .....	57
<b>O</b>	
On-screen display .....	48
On-screen display Language .....	56
OUTPUT port .....	50
<b>P</b>	
Password .....	55
PDF .....	11
Phase .....	43
Picture in Picture .....	47
POWER buttons .....	22
Power cord .....	16
POWER indicator .....	16
Power Save .....	50
Progressive Mode .....	42
<b>R</b>	
Rear projection .....	30
RESIZE button .....	35
RGB cable .....	17
RS-232C port .....	19
<b>S</b>	
Save Setting .....	43
Select Setting .....	43
Set ID No. ....	54
Set Inputs .....	53
Speaker .....	46
Stack Setting .....	52
Startup image .....	49
Status function .....	56
S-VIDEO INPUT terminal .....	20
Sync .....	45
Sync on green .....	67
<b>T</b>	
TEMPERATURE WARNING indicator .....	61
Transmission Speed (RS-232C) .....	53
<b>U</b>	
UNDO button .....	38
<b>V</b>	
VAO .....	46
VIDEO INPUT terminal .....	20
Video System .....	48
Videowall .....	60
VOLUME buttons .....	31
<b>W</b>	
Wired RC jack .....	14
WIRED REMOTE control input terminal .....	14
<b>No.</b>	
1.2.3 button .....	31
4.5 button .....	31





# SHARP CORPORATION



## Free Manuals Download Website

<http://myh66.com>

<http://usermanuals.us>

<http://www.somanuals.com>

<http://www.4manuals.cc>

<http://www.manual-lib.com>

<http://www.404manual.com>

<http://www.luxmanual.com>

<http://aubethermostatmanual.com>

Golf course search by state

<http://golfingnear.com>

Email search by domain

<http://emailbydomain.com>

Auto manuals search

<http://auto.somanuals.com>

TV manuals search

<http://tv.somanuals.com>