

# SHARP®

SOUNDBAR-SYSTEM  
BARRE DE SON  
SISTEMA SOUND BAR  
SOUND BAR SYSTEM  
SISTEMA SOUND BAR  
SOUND BAR SYSTEEM  
SISTEMA SOUND BAR  
ÄÄNIPALKKIJÄRJESTELMÄ  
SOUND BAR SYSTEM

MODELL            MODEL  
MODÈLE          MODELO  
MODELO          MALLI  
MODELL          MODEL  
MODELLO

## HT-SB400

BEDIENUNGSANLEITUNG    GEBRUIKSAANWIJZING  
MODE D'EMPLOI            MANUAL DE OPERAÇÃO  
MANUAL DE MANEJO       KÄYTTÖOPAS  
BRUKSANVISNING          OPERATION MANUAL  
MANUALE DI ISTRUZIONI



**Note:**

This product is recommended for flat panel TV  
(LCD and plasma).



**SRS**  
TruSurround HD

**SRS**  
TruSurround HD

is a trademark of SRS Labs, Inc.

TruSurround HD technology is incorporated under license  
from SRS Labs, Inc.

DEUTSCH	... Siehe Seiten i bis x und D-1 bis D-18.
FRANÇAIS	... Se reporter aux pages i à x et F-1 à F-18.
ESPAÑOL	... Consulte las páginas i a x y S-1 a S-18.
SVENSKA	... Hänvisa till sidorna i tilll x och V-1 till V-18.
ITALIANO	... Leggere le pagine i a x e I-1 a I-18.
NEDERLANDS	... Raadpleeg de bladzijden i t/m x en N-1 t/m N-18.
PORTUGUÊS	... Favor consultar as páginas i a x e P-1 a P-18.
SUOMI	... Katso sivut i - x ja Su-1 - Su-18.
ENGLISH	... Please refer to pages i to x and E-1 to E-18.

... يرجى مراجعة الصفحات ا الى x و ا الى ٢٦.

العربية

**BESONDERE ANMERKUNGEN**  
**REMARQUES SPÉCIALES**  
**NOTAS ESPECIALES**  
**SÄRSKILDA ANMÄRKNINGAR**  
**NOTE PARTICOLARI**  
**BIJZONDERE OPMERKINGEN**  
**NOTAS ESPECIAIS**  
**ERITYISHUOMAUTUS**  
**SPECIAL NOTES**  
**ملاحظات خاصة**

● **Dichiarazione di conformità**

La società SHARP ELECTRONICS EUROPE GmbH dichiara che il prodotto SHARP SISTEMA SOUND BAR HT-SB400 è costruito in conformità alle prescrizioni del D.M.no. 548 del 28/8/95, pubblicato sulla G.U.no. 301 del 28/12/95 ed in particolare è conforme a quanto indicato nell'art. 2, comma 1 dello stesso decreto.

- Bei Einstellung der ON/STAND-BY-Taste auf STAND-BY ist die Netzspannung immer noch im Gerät vorhanden. Wenn die ON/STAND-BY-Taste auf STAND-BY eingestellt wird, kann das Gerät unter Verwendung der Timer-Betriebsart oder Fernbedienung in Betrieb gesetzt werden.

**Warnung:**

In diesem Gerät sind keine vom Benutzer wartbaren Teile vorhanden. Niemals Abdeckungen entfernen, außer wenn Sie dafür qualifiziert sind. In diesem Gerät sind gefährliche Spannungen vorhanden. Vor Ausführung von irgendwelchen Kundendienstarbeiten oder bei längerer Nichtverwendung des Gerätes stets den Netzstecker aus der Netzsteckdose ziehen.

- Lorsque la touche ON/STAND-BY est mise en STAND-BY, l'appareil est toujours sous tension. Lorsque la touche ON/STAND-BY se trouve sur la position STAND-BY, l'appareil est prêt à fonctionner par la minuterie ou la télécommande.

**Avertissement:**

Cet appareil contient des pièces non réparables par l'utilisateur. Personne non qualifiée n'enlèvera jamais les couvercles. L'appareil contenant des organes portés à haute tension, débrancher l'appareil avant toute réparation ou en période de non-utilisation.

- Cuando el botón ON/STAND-BY está puesto en la posición STAND-BY, todavía hay tensión dentro del aparato. Cuando el botón ON/STAND-BY está puesto en la posición STAND-BY, el aparato puede ponerse en funcionamiento utilizando el modo del temporizador o el controlador remoto.

**Advertencia:**

Tenga en cuenta que dentro de este aparato no hay piezas que pueda reparar. No quite nunca las tapas a menos que se esté cualificado para hacerlo. Este aparato tiene en su interior tensiones peligrosas.

Desenchufe siempre la clavija de la red del tomacorriente antes de realizar cualquier servicio de mantenimiento y cuando no se use el aparato durante un largo período de tiempo.

- När ON/STAND-BY knappen är i läge STAND-BY, finns nätspänning i apparaten. Med ON/STAND-BY knappen i läge STAND-BY kan apparaten startas med timerfunktion eller fjärrkontrollen.

**Varning:**

Apparaten innehåller inga delar som kan åtgärdas av kunden. Höljet får endast öppnas av kvalificerad personal. Apparaten innehåller farliga spänningar.

Stickkontakten ska därför dras ut från nätuttaget före reparationsarbeten och bör dras ut om apparaten inte ska användas på mycket länge.

- Quando il tasto ON/STAND-BY si trova in posizione STAND-BY, all'interno dell'apparecchio c'è ancora la corrente. Se il tasto ON/STAND-BY si trova nella posizione STAND-BY, l'unità può essere accesa con il modo timer o con il telecomando.

**Avvertenza:**

L'apparecchio non contiene parti riparabili dall'utente.

Non togliere mai i coperchi, a meno di non essere qualificati per farlo. All'interno dell'apparecchio ci sono tensioni pericolose, per cui si deve sempre staccare la spina del cavo d'alimentazione dalla presa di corrente prima di qualsiasi intervento di manutenzione e quando non si usa l'apparecchio per un lungo periodo di tempo.

- Wanneer de ON/STAND-BY toets in de STAND-BY stand staat, loopt er nog steeds stroom (netspanning) in het toestel. Wanneer de ON/STAND-BY toets in de STAND-BY stand staat, kan het toestel ingeschakeld worden via de timerfunctie of de afstandsbediening.

**Waarschuwing:**

Dit toestel bevat geen door de gebruiker te repareren onderdelen. Verwijder de behuizing nooit tenzij u deskundig bent op dit gebied. In het toestel loopt een gevaarlijke spanning; haal de stekker altijd uit het stopcontact alvorens onderhoud uit te voeren of wanneer het toestel voor langere tijd niet gebruikt wordt.

- Quando o botão ON/STAND-BY estiver ajustado na posição STAND-BY, a voltagem de alimentação ainda se encontra presente dentro do aparelho.  
Quando o botão ON/STAND-BY estiver ajustado na posição STAND-BY, o aparelho pode ser colocado em operação através do controle remoto.

**Advertência:**

Neste aparelho não há partes que podem ser consertadas pelo usuário. Nunca retire a tampa, a menos que você tenha qualificação para tal. Este aparelho contém voltagens perigosas. Remova sempre o cabo de alimentação da tomada antes de efetuar qualquer conserto ou quando deixar o aparelho muito tempo fora de uso.

- Kun ON/STAND-BY -kytkin on STAND-BY-asennossa, laitteessa on yhä virta.  
Kun ON/STAND-BY -kytkin on STAND-BY-asennossa, laite voidaan kytkeä päälle kaukosäätimestä.

**Varoitus:**

Laitteen sisällä ei ole käyttäjän huollettavissa olevia osia. Kotelon saa irrottaa vain siihen pätevytynyt henkilö. Laitteen sisällä on vaarallinen jännite. Laite on aina irrotettava verkkovirrasta ennen huoltotoimenpiteitä ja jos laite on pitkään käyttämättä.

- When the ON/STAND-BY button is set at STAND-BY position, mains voltage is still present inside the unit.  
When the ON/STAND-BY button is set at STAND-BY position, the unit may be brought into operation by the remote control.

**Warning:**

This unit contains no user serviceable parts. Never remove covers unless qualified to do so. This unit contains dangerous voltages always remove mains plug from the socket before any service operation and when not in use for a long period.

- عندما يكون الزر ON/STAND-BY مضبوطاً على وضع الاستعداد STAND-BY، تبقى فولطية التيار سارية داخل الجهاز. عندما يكون الزر ON/STAND-BY مضبوطاً على وضع الاستعداد STAND-BY، يمكن تشغيل الجهاز بواسطة وحدة التحكم عن بعد.

**تحذير:**

لا يوجد في هذا الجهاز أجزاء يمكن صيانتها من قبل الشخص المستعمل. لا تنزع مطلقاً لأغطية إلا إذا كنت مؤهلاً للقيام بذلك. يحتوي هذا الجهاز على فولطيات خطيرة، لهذا انزع أبس سلك توصيل الطاقة الكهربائية قبل أية عملية من عمليات الصيانة وعند عدم استعمال لجهاز لمدة زمنية طويلة.

**Vorsicht:**

Das Gerät weder Tropf- noch Spritzwasser aussetzen. Ansonsten besteht die Gefahr eines Brandes oder elektrischen Schlag. Es dürfen keine mit Flüssigkeiten gefüllten Gegenstände wie Vasen auf dem Gerät abgestellt werden.

**Attention:**

Pour éviter un incendie ou une secousse électrique, mettre l'appareil à l'abri de l'eau (éclaboussure, goutte). Ne pas poser sur l'appareil un récipient contenant du liquide.

**Advertencia:**

Para evitar incendios y descargas eléctricas, no exponga el aparato a goteo o salpicadura de líquidos. No deberán ponerse encima del aparato objetos que estén llenos de líquido, como por ejemplo un florero.

**Varning:**

Utsätt inte enheten för dropp eller stänk för att förhindra brand eller elektriska stötar. Inga vätskefyllda föremål såsom vasor får placeras på enheten.

**Attenzione:**

Per prevenire incendi o scosse elettriche, non fare gocciolare nessun liquido sull'apparecchio e non bagnarlo. Non collocarvi sopra nessun oggetto riempito d'acqua, come per esempio vasi.

**Waarschuwing:**

Stel het toestel niet bloot aan druipend of spattend water om brand en elektrische schokken te voorkomen. Met vloeistoffen gevulde voorwerpen, zoals vazen, mogen niet op het toestel geplaatst worden.

**Cuidado:**

Para evitar incêndio ou choque elétrico, não exponha este aparelho a gotejamento ou salpicamento de água. Não coloque objetos com água como, por exemplo, um vaso de flores, em cima do aparelho.

**Warning:**

To prevent fire or shock hazard, do not expose this appliance to dripping or splashing. No objects filled with liquids, such as vases, shall be placed on the apparatus.

**تحذير:**

لتفادي نشوب حريق أو صدمة كهربائية، لا تعتمد على تعريض هذا الجهاز لسقوط أو رش الماء ولا تضع أي شيء يحتوي على الماء مثل زهرية على الجهاز.

**Advarsel:**

Til at forbygge ild og stød risiko, lad være med at undsaette denne indretning for drypning eller overstaenkning. Der må ikke bringes nogen genstande fyldt med vand, som for eksempel vaser, på dette apparat.

**Advarsel:**

For å unngå brann eller kortslutning, utsett ikke produktet for vann eller fuktighet. Gjenstander som inneholder væske, feks. en blomstervase, må ikke plasseres oppå apparatet.

**Varoitus:**

Älä vie laitetta sateeseen tai kosteisiin tiloihin. Jos laite on kostunut, anna sen kuivua ennen kuin käytät sitä verkkovirralla. Nestettä sisältäviä astioita kuten esim. kukkamaljakoita ei saa asettaa laitteen päälle.

**PŘÍSTROJ NEVYSTAVUJTE KAPAJÍCÍ NEBO STRÍKAJÍCÍ VODĚ.**

**PRÍSTROJ NEVYSTAVUJTE KVAPKAJÚCEJ ALEBO STRIEKAJÚCEJ VODE.**

**Urządzenie należy chronić przed zalaniem i wilgocią.**

- Når ON/STAND-BY-knappen er sat i STAND-BY positionen, er der stadig netspænding til stede i apparatet. Når ON/STAND-BY-knappen er sat i STAND-BY position, kan apparatet startes v.h.j.a. fjernbetjeningen.

**Advarsel:**

Apparatet indeholder ingen dele, der kan repareres af brugeren selv. Fjern aldrig kabinettet med mindre De er kvalificeret hertil. Apparatet indeholder farlig strømspænding. Traek altid stikket ud af stikkontakten før der foretages reparationer, eller hvis apparatet ikke er i brug i længere tid.

**PŘED SEJMUTÍM KRYTU NUTNO VYJMOUT VIDLICI ZE SÍŤOVÉ ZÁSUVKY.**

**PRED ZLOŽENÍM KRYTU JE NUTNÉ ODPOJIŤ PRÍSTROJ ZO SIETE.**

**DENNA APPARAT ÄR ANSLUTEN TILL 230 V VÄXELSTRÖM NÄR STICKPROPPEN ÄR INSKJUTEN I VÄGGUTTAGET. FÖR ATT FULLSTÄNDIGT KOPPLA IFRÅN APPARATEN, V.G. DRAG UT STICKPROPPEN.**

## Entsorgungsinformationen



Achtung: Ihr Produkt trägt dieses Symbol. Es besagt, dass Elektro- und Elektronikgeräte nicht mit dem Haushaltsmüll entsorgt, sondern einem getrennten Rücknahmesystem zugeführt werden sollten.

### A. Entsorgungsinformationen für Benutzer aus Privathaushalten

#### 1. In der Europäischen Union

Achtung: Werfen Sie dieses Gerät zur Entsorgung bitte nicht in den normalen Hausmüll!

Gemäß einer neuen EU-Richtlinie, die die ordnungsgemäße Rücknahme, Behandlung und Verwertung von gebrauchten Elektro- und Elektronikgeräten vorschreibt, müssen elektrische und elektronische Altgeräte getrennt entsorgt werden.

Nach der Einführung der Richtlinie in den EU-Mitgliedstaaten können Privathaushalte ihre gebrauchten Elektro- und Elektronikgeräte nun kostenlos an ausgewiesenen Rücknahmestellen abgeben\*.

In einigen Ländern\* können Sie Altgeräte u.U. auch kostenlos bei Ihrem Fachhändler abgeben, wenn Sie ein vergleichbares neues Gerät kaufen.

\*) Weitere Einzelheiten erhalten Sie von Ihrer Gemeindeverwaltung.

Wenn Ihre gebrauchten Elektro- und Elektronikgeräte Batterien oder Akkus enthalten, sollten diese vorher entnommen und gemäß örtlich geltenden Regelungen getrennt entsorgt werden.

Durch die ordnungsgemäße Entsorgung tragen Sie dazu bei, dass Altgeräte angemessen gesammelt, behandelt und verwertet werden. Dies verhindert mögliche schädliche Auswirkungen auf Umwelt und Gesundheit durch eine unsachgemäße Entsorgung.

#### 2. In anderen Ländern außerhalb der EU

Bitte erkundigen Sie sich bei Ihrer Gemeindeverwaltung nach dem ordnungsgemäßen Verfahren zur Entsorgung dieses Geräts.

Für die Schweiz: Gebrauchte Elektro- und Elektronikgeräte können kostenlos beim Händler abgegeben werden, auch wenn Sie kein neues Produkt kaufen. Weitere Rücknahmesysteme finden Sie auf der Homepage von [www.swico.ch](http://www.swico.ch) oder [www.sens.ch](http://www.sens.ch).

### B. Entsorgungsinformationen für gewerbliche Nutzer

#### 1. In der Europäischen Union

Wenn Sie dieses Produkt für gewerbliche Zwecke genutzt haben und nun entsorgen möchten:

Bitte wenden Sie sich an Ihren SHARP Fachhändler, der Sie über die Rücknahme des Produkts informieren kann. Möglicherweise müssen Sie die Kosten für die Rücknahme und Verwertung tragen. Kleine Produkte (und kleine Mengen) können möglicherweise bei Ihrer örtlichen Rücknahmestelle abgegeben werden.

Für Spanien: Bitte wenden Sie sich an das vorhandene Rücknahmesystem oder Ihre Gemeindeverwaltung, wenn Sie Fragen zur Rücknahme Ihrer Altgeräte haben.

#### 2. In anderen Ländern außerhalb der EU

Bitte erkundigen Sie sich bei Ihrer Gemeindeverwaltung nach dem ordnungsgemäßen Verfahren zur Entsorgung dieses Geräts.

## Informations sur la mise au rebut correcte



Attention : votre produit comporte ce symbole. Il signifie que les produits électriques et électroniques usagés ne doivent pas être mélangés avec les déchets ménagers généraux. Un système de collecte séparé est prévu pour ces produits.

### A. Informations sur la mise au rebut à l'intention des utilisateurs privés (ménages)

#### 1. Au sein de l'Union européenne

Attention : si vous souhaitez mettre cet appareil au rebut, ne le jetez pas dans une poubelle ordinaire!

Les appareils électriques et électroniques usagés doivent être traités séparément et conformément aux lois en vigueur en matière de traitement, de récupération et de recyclage adéquats de ces appareils.

Suivant la mise en oeuvre de ces dispositions dans les Etats membres, les ménages résidant au sein de l'Union européenne peuvent désormais ramener gratuitement\* leurs appareils électriques et électroniques usagés sur des sites de collecte désignés.

Dans certains pays\*, votre détaillant reprendra également gratuitement votre ancien produit si vous achetez un produit neuf similaire.

\*) Veuillez contacter votre administration locale pour plus de renseignements.

Si votre appareil électrique ou électronique usagé comporte des piles ou des accumulateurs, veuillez les mettre séparément et préalablement au rebut conformément à la législation locale en vigueur.

En veillant à la mise au rebut correcte de ce produit, vous contribuerez à assurer le traitement, la récupération et le recyclage nécessaires de ces déchets, et préviendrez ainsi les effets néfastes potentiels de leur mauvaise gestion sur l'environnement et la santé humaine.

#### 2. Pays hors de l'Union européenne

Si vous souhaitez mettre ce produit au rebut, veuillez contacter votre administration locale qui vous renseignera sur la méthode d'élimination correcte de cet appareil.

Suisse : les équipements électriques ou électroniques usagés peuvent être ramenés gratuitement au détaillant, même si vous n'achetez pas un nouvel appareil. Pour obtenir la liste des autres sites de collecte, veuillez vous reporter à la page d'accueil du site [www.swico.ch](http://www.swico.ch) ou [www.sens.ch](http://www.sens.ch).

### B. Informations sur la mise au rebut à l'intention des entreprises

#### 1. Au sein de l'Union européenne

Si ce produit est utilisé dans le cadre des activités de votre entreprise et que vous souhaitez le mettre au rebut : Veuillez contacter votre revendeur SHARP qui vous informera des conditions de reprise du produit. Les frais de reprise et de recyclage pourront vous être facturés. Les produits de petite taille (et en petites quantités) pourront être repris par vos organisations de collecte locales.

Espagne : veuillez contacter l'organisation de collecte existante ou votre administration locale pour les modalités de reprise de vos produits usagés.

#### 2. Pays hors de l'Union européenne

Si vous souhaitez mettre ce produit au rebut, veuillez contacter votre administration locale qui vous renseignera sur la méthode d'élimination correcte de cet appareil.

## Información sobre la eliminación



Atención: su producto está marcado con este símbolo. Significa que los productos eléctricos y electrónicos usados no deberían mezclarse con los residuos domésticos generales. Existe un sistema de recogida independiente para estos productos.

### A. Información sobre eliminación para usuarios particulares

#### 1. En la Unión Europea

Atención: si quiere desechar este equipo, ¡por favor no utilice el cubo de la basura habitual!

Los equipos eléctricos y electrónicos usados deberían tratarse por separado de acuerdo con la legislación que requiere un tratamiento, una recuperación y un reciclaje adecuados de los equipos eléctricos y electrónicos usados. Tras la puesta en práctica por parte de los estados miembros, los hogares de particulares dentro de los estados de la Unión Europea pueden devolver sus equipos eléctricos y electrónicos a los centros de recogida designados sin coste alguno \*.

En algunos países \*\* es posible que también su vendedor local se lleve su viejo producto sin coste alguno si Ud. compra uno nuevo similar.

\*) Por favor, póngase en contacto con su autoridad local para obtener más detalles.

Si sus equipos eléctricos o electrónicos usados tienen pilas o acumuladores, por favor deséchelos por separado con antelación según los requisitos locales.

Al desechar este producto correctamente, ayudará a asegurar que los residuos reciban el tratamiento, la recuperación y el reciclaje necesarios, previniendo de esta forma posibles efectos negativos en el medio ambiente y la salud humana que de otra forma podrían producirse debido a una manipulación de residuos inapropiada.

#### 2. En otros países fuera de la Unión Europea

Si desea desechar este producto, por favor póngase en contacto con las autoridades locales y pregunte por el método de eliminación correcto.

Para Suiza: Los equipos eléctricos o electrónicos pueden devolverse al vendedor sin coste alguno, incluso si no compra ningún nuevo producto. Se puede encontrar una lista de otros centros de recogida en la página principal de [www.swico.ch](http://www.swico.ch) o [www.sens.ch](http://www.sens.ch).

### B. Información sobre Eliminación para empresas usuarias

#### 1. En la Unión Europea

Si el producto se utiliza en una empresa y quiere desecharlo: Por favor póngase en contacto con su distribuidor SHARP, quien le informará sobre la recogida del producto. Puede ser que le cobren los costes de recogida y reciclaje. Puede ser que los productos de tamaño pequeño (y las cantidades pequeñas) sean recogidos por sus centros de recogida locales.

Para España: por favor, póngase en contacto con el sistema de recogida establecido o con las autoridades locales para la recogida de los productos usados.

#### 2. En otros países fuera de la Unión Europea

Si desea desechar este producto, por favor póngase en contacto con sus autoridades locales y pregunte por el método de eliminación correcto.

## Information om återvinning



OBS! Produkten är märkt med symbolen ovan. Denna symbol indikerar att elektroniska produkter inte ska kassas i det vanliga hushållsavfallet eftersom det finns ett separat avfallshanteringssystem för dem.

### A. Information om återvinning av elektrisk utrustning för hushåll

#### 1. EU-länder

OBS! Kasta inte denna produkt i soporna!

Förbrukad elektrisk utrustning måste hanteras i enlighet med gällande miljölagstiftning och återvinningsföreskrifter.

I enlighet med gällande EU-regler ska hushåll ha möjlighet att lämna in elektrisk utrustning till återvinningsstationer utan kostnad.\* I vissa länder\*\* kan det även hända att man gratis kan lämna in gamla produkter till återförsäljaren när man köper en ny liknande enhet.

\*) Kontakta kommunen för vidare information.

Om utrustningen innehåller batterier eller ackumulatörer ska dessa först avlägsnas och hanteras separat i enlighet med gällande miljöföreskrifter.

Genom att hantera produkten i enlighet med dessa föreskrifter kommer den att tas om hand och återvinnas på tillämpligt sätt, vilket förhindrar potentiella negativa hälso- och miljöeffekter.

#### 2. Länder utanför EU

Kontakta de lokala myndigheterna och ta reda på gällande sorterings- och återvinningsföreskrifter om du behöver göra dig av med denna produkt.

### B. Information om återvinning för företag

#### 1. EU-länder

Gör så här om produkten ska kasseras:

Kontakta SHARPs återförsäljare för information om hur man går till väga för att lämna tillbaka produkten. Det kan hända att en avgift för transport och återvinning tillkommer. Mindre skrymmande produkter (om det rör sig om ett fåtal) kan eventuellt återlämnas till lokala återvinningsstationer.

#### 2. Länder utanför EU

Kontakta de lokala myndigheterna och ta reda på gällande sorterings- och återvinningsföreskrifter om du behöver göra dig av med denna produkt.

## Informazioni per un corretto smaltimento



Attenzione: Il dispositivo è contrassegnato da questo simbolo, che segnala di non smaltire le apparecchiature elettriche ed elettroniche insieme ai normali rifiuti domestici. Per tali prodotti è previsto un sistema di raccolta a parte.

### A. Informazioni sullo smaltimento per gli utenti (privati)

#### 1. Nell'Unione europea

Attenzione: Per smaltire il presente dispositivo, non utilizzare il normale bidone della spazzatura! Le apparecchiature elettriche ed elettroniche usate devono essere gestite a parte e in conformità alla legislazione che richiede il trattamento, il recupero e il riciclaggio adeguato dei suddetti prodotti.

In seguito alle disposizioni attuate dagli Stati membri, i privati residenti nella UE possono conferire gratuitamente le apparecchiature elettriche ed elettroniche usate a centri di raccolta designati\*. In alcuni paesi\*, anche il rivenditore locale può ritirare gratuitamente il vecchio prodotto se l'utente acquista un altro nuovo di tipologia simile.

\*) Per maggiori informazioni si prega di contattare l'autorità locale competente.

Se le apparecchiature elettriche o elettroniche usate hanno batterie o accumulatori, l'utente dovrà smaltirli a parte preventivamente in conformità alle disposizioni locali. Lo smaltimento corretto del presente prodotto contribuirà a garantire che i rifiuti siano sottoposti al trattamento, al recupero e al riciclaggio necessari prevenendone il potenziale impatto negativo sull'ambiente e sulla salute umana, che potrebbe derivare da un'adeguata gestione dei rifiuti.

#### 2. In paesi che non fanno parte dell'UE

Se si desidera eliminare il presente prodotto, contattare le autorità locali e informarsi sul metodo di smaltimento corretto.

Per la Svizzera: Le apparecchiature elettriche o elettroniche usate possono essere restituite gratuitamente al rivenditore, anche se non si acquista un prodotto nuovo. Altri centri di raccolta sono elencati sulle homepage di [www.swico.ch](http://www.swico.ch) o di [www.sens.ch](http://www.sens.ch).

### B. Informazioni sullo smaltimento per gli utenti commerciali

#### 1. Nell'Unione europea

Se il prodotto è impiegato a scopi commerciali, procedere come segue per eliminarlo.

Contattare il proprio rivenditore SHARP che fornirà informazioni circa il ritiro del prodotto. Potrebbero essere addebitate le spese di ritiro e riciclaggio. Prodotti piccoli (e quantitativi ridotti) potranno essere ritirati anche dai centri di raccolta locali.

Per la Spagna: Contattare il sistema di raccolta ufficiale o l'ente locale preposto al ritiro dei prodotti usati.

#### 2. In paesi che non fanno parte dell'UE

Se si desidera eliminare il presente prodotto, contattare le autorità locali e informarsi sul metodo di smaltimento corretto.

## Informatie over verantwoorde verwijdering



Let op: Uw product is van dit merkteken voorzien. Dit betekent dat afgedankte elektrische en elektronische apparatuur niet samen met het normale huishoudafval mogen worden weggegooid. Er bestaat een afzonderlijk inzamelingsstelsel voor deze producten.

### A. Informatie over afvalverwijdering voor gebruikers (particuliere huishoudens)

#### 1. In de Europese Unie

Let op: Deze apparatuur niet samen met het normale huishoudafval weggoeien!

Afgedankte elektrische en elektronische apparatuur moet gescheiden worden ingezameld conform de wetgeving inzake de verantwoorde verwerking, terugwinning en recycling van afgedankte elektrische en elektronische apparatuur.

Na de invoering van de wet door de lidstaten van de Europese Unie hun afgedankte elektrische en elektronische apparatuur kosteloos\* naar hiertoe aangewezen inzamelingsinrichtingen brengen\*.

In sommige landen\* kunt u bij de aanschaf van een nieuw apparaat het oude product kosteloos bij uw lokale distributeur inleveren.

\*) Neem contact op met de plaatselijke autoriteiten voor verdere informatie.

Als uw elektrische of elektronische apparatuur batterijen of accumulators bevat dan moet u deze afzonderlijk conform de plaatselijke voorschriften weggoeien.

Door dit product op een verantwoorde manier weg te gooien, zorgt u ervoor dat het afval de juiste verwerking, terugwinning en recycling ondergaat en potentiële negatieve effecten op het milieu en de menselijke gezondheid worden voorkomen die anders zouden ontstaan door het verkeerd verwerken van het afval.

#### 2. In andere landen buiten de Europese Unie

Als u dit product wilt weggoeien, neem dan contact op met de plaatselijke autoriteiten voor informatie omtrent de juiste verwijderingsprocedure.

Voor Zwitserland: U kunt afgedankte elektrische en elektronische apparatuur kosteloos bij de distributeur inleveren, zelfs als u geen nieuw product koopt. Aanvullende inzamelingsinrichtingen zijn vermeld op de startpagina van [www.swico.ch](http://www.swico.ch) of [www.sens.ch](http://www.sens.ch).

### B. Informatie over afvalverwijdering voor bedrijven

#### 1. In de Europese Unie

Als u het product voor zakelijke doeleinden heeft gebruikt en als u dit wilt weggoeien:

Neem contact op met uw SHARP distributeur die u inlichtingen verschaft over de terugname van het product. Het kan zijn dat u een afvalverwijderingsbijdrage voor de terugname en recycling moet betalen. Kleine producten (en kleine hoeveelheden) kunnen door de lokale inzamelingsinrichtingen worden verwerkt.

Voor Spanje: Neem contact op met de inzamelingsinrichting of de lokale autoriteiten voor de terugname van uw afgedankte producten.

#### 2. In andere landen buiten de Europese Unie

Als u dit product wilt weggoeien, neem dan contact op met de plaatselijke autoriteiten voor informatie omtrent de juiste verwijderingsprocedure.



## Informação sobre Eliminação de Produtos



Atenção: O seu produto está identificado com este símbolo. Significa que os produtos eléctricos e electrónicos não devem ser misturados com o lixo doméstico comum. Existe um sistema de recolhas específico para estes produtos.

### A. Informações sobre a Eliminação de Produtos para os Utilizadores (particulares)

#### 1. Na União Europeia

Atenção: Se quiser eliminar este equipamento, não o deve fazer juntamente com o lixo doméstico comum! O equipamento eléctrico e electrónico deve ser tratado separadamente e ao abrigo da legislação aplicável que obriga a um tratamento, recuperação e reciclagem adequados de equipamentos eléctricos e electrónicos usados.

Após a implementação desta legislação por parte dos Estados-membros, todos os cidadãos residentes na União Europeia poderão entregar o seu equipamento eléctrico e electrónico usado em estações de recolha específicas a título gratuito\*.

Em alguns países\* o seu revendedor local também pode recolher o seu equipamento usado a título gratuito na compra de um novo equipamento.

\*) Contacte as entidades locais para mais informações.

Se o seu equipamento eléctrico e electrónico usado funcionar a pilhas ou baterias, deverá eliminá-las em separado, conforme a legislação local, e antes de entregar o seu equipamento.

Ao eliminar este produto correctamente estará a contribuir para que o lixo seja submetido aos processos de tratamento, recuperação e reciclagem adequados. Desta forma é possível evitar os efeitos nocivos que o tratamento inadequado do lixo poderia provocar no ambiente e na saúde.

#### 2. Em outros Países fora da UE

Se quiser eliminar este produto, contacte as entidades locais e informe sobre o método correcto para proceder à sua eliminação.

Na Suíça: O equipamento eléctrico e electrónico é aceite, a título gratuito, em qualquer revendedor, mesmo que não tenha adquirido um novo produto. Poderá encontrar uma lista das estações de recolha destes equipamentos na página da Web [www.swicho.ch](http://www.swicho.ch) ou [www.sens.ch](http://www.sens.ch).

### B. Informações sobre a Eliminação de Produtos para Utilizadores-Empresas

#### 1. Na União Europeia

Se o produto for usado para fins comerciais e quiser eliminá-lo:

Contacte o seu revendedor SHARP que irá informá-lo sobre a melhor forma de eliminar o produto. Poderá ter de pagar as despesas resultantes da recolha e reciclagem do produto. Alguns produtos mais pequenos (e em pequenas quantidades) poderão ser recolhidos pelas estações locais.

Na Espanha: Contacte o sistema de recolhas público ou as entidades locais para mais informações sobre a recolha de produtos usados.

#### 2. Em outros Países fora da UE

Se quiser eliminar este produto, contacte as entidades locais e informe sobre o método correcto para proceder à sua eliminação.

## Tietoja laitteen hävittämisestä



Huomio: Tuote on merkitty tällä symbolilla. Tämä tarkoittaa, että käytettyjä sähkö- ja elektroniikkalaitteita ei saa sekoittaa kotitalouden yleisjätteiden kanssa. Näille tuotteille on olemassa erillinen keräysjärjestelmä.

### A. Hävitysohjeet käyttäjille (yksityiset kotitaloudet)

#### 1. Euroopan unionissa

Huomio: Jos haluat hävittää tämän laitteen, älä käytä tavallista jättesäiliötä.

Käytetyt sähkö- ja elektroniikkalaitteet pitää hävittää erikseen noudattaen lainsäädäntöä, joka takaa käytettyjen sähkö- ja elektroniikkalaitteiden oikean käsittelyn, keräämisen ja kierrättämisen Jäsenvaltioiden täytäntöönpanoa seuraten yksityiset kotitaloudet EU:n jäsenvaltioissa voivat palauttaa käytetyt sähkö- ja elektroniikkalaitteet määrättyihin keräyspaikkoihin ilmaiseksi\*. Joissakin maissa\* paikalliset vähittäismyyjät voivat myös ottaa vastaan vanhan tuotteen ilmaiseksi, jos asiakas ostaa vastaavan uuden tuotteen.

\*) Pyydä lisätietoja paikallisviranomaisilta.

Jos käytetyissä sähkö- tai elektroniikkalaitteissa käytetään paristoja tai akkuja, hävitä nämä tuotteet etukäteen erikseen paikallisten säästösten mukaisesti.

Hävittämällä tuotteen asianmukaisesti, autat varmistamaan, että jätteet käsitellään, kerätään ja kierrätetään asianmukaisella tavalla Näin välttytään haitallisilta ympäristö- ja terveysvaikutuksilta, joita saattaa olla seuraamuksena jätteen epäasianmukaisesta käsittelystä.

#### 2. Muissa maissa EU:n ulkopuolella

Jos haluat hävittää tuotteen, ota yhteys paikallisiin viranomaisiin ja pyydä ohjeita tuotteen asianmukaiseen hävittämiseen.

### B. Hävitysohjeet yrityskäyttäjille

#### 1. Euroopan unionissa

Jos tuotetta on käytetty yrityskäytössä, ja haluat hävittää sen. Ota yhteys SHARP-jälleenmyyjään, joka antaa sinulle lisäohjeita tai ottaa tuotteen vastaan. Sinulta saatetaan veloittaa tuotteen vastaanottamisesta ja kierrätyksestä johtuvat kustannukset Paikalliset keräyspisteet saattavat ottaa vastaan pienet tuotteet (ja pienet määrät).

#### 2. Muissa maissa EU:n ulkopuolella

Jos haluat hävittää tuotteen, ota yhteys paikallisiin viranomaisiin ja pyydä ohjeita tuotteen asianmukaiseen hävittämiseen.

## Information on Proper Disposal



Attention: Your product is marked with this symbol. It means that used electrical and electronic products should not be mixed with general household waste. There is a separate collection system for these products.

### A. Information on Disposal for Users (private households)

#### 1. In the European Union

Attention: If you want to dispose of this equipment, please do not use the ordinary dustbin!

Used electrical and electronic equipment must be treated separately and in accordance with legislation that requires proper treatment, recovery and recycling of used electrical and electronic equipment.

Following the implementation by member states, private households within the EU states may return their used electrical and electronic equipment to designated collection facilities free of charge\*. In some countries\* your local retailer may also take back your old product free of charge if you purchase a similar new one.

\*) Please contact your local authority for further details.

If you used electrical or electronic equipment has batteries or accumulators, please dispose of these separately beforehand according to local requirements.

By disposing of this product correctly you will help ensure that the waste undergoes the necessary treatment, recovery and recycling and thus prevent potential negative effects on the environment and human health which could otherwise arise due to inappropriate waste handling.

#### 2. In other Countries outside the EU

If you wish to discard this product, please contact your local authorities and ask for the correct method of disposal.

For Switzerland: Used electrical or electronic equipment can be returned free of charge to the dealer, even if you don't purchase a new product. Further collection facilities are listed on the homepage of [www.swico.ch](http://www.swico.ch) or [www.sens.ch](http://www.sens.ch).

### B. Information on Disposal for Business Users

#### 1. In the European Union

If the product is used for business purposes and you want to discard it:

Please contact your SHARP dealer who will inform you about the take-back of the product. You might be charged for the costs arising from take-back and recycling. Small products (and small amounts) might be taken back by your local collection facilities.

For Spain: Please contact the established collection system or your local authority for take-back of your used products.

#### 2. In other Countries outside the EU

If you wish to discard of this product, please contact your local authorities and ask for the correct method of disposal.



### Informationen zur Batterieentsorgung

Für die EU: Die durchgestrichene Abfalltonne bedeutet, dass gebrauchte Batterien nicht mit dem Haushaltsmüll entsorgt werden sollten! Es gibt getrennte Sammelsysteme für gebrauchte Batterien, welche eine ordnungsgemäße Behandlung und Verwertung entsprechend gesetzlicher Vorgaben erlauben. Weitere Einzelheiten erhalten Sie von Ihrer Gemeindeverwaltung.

Für die Schweiz: Die gebrauchte Batterie kann an der Verkaufsstelle zurückgegeben werden.

Für andere Nicht-EU Staaten: Bitte erkundigen Sie sich bei Bedarf bei Ihrer Gemeindeverwaltung nach weiteren Informationen zur Entsorgung von gebrauchten Batterien.

### Information sur la mise au rebut de la pile

Au sein de l'Union Européenne : Le symbole de la poubelle sur roues barrée laisse supposer que les piles/accus usagées ne doivent pas être mélangées avec les déchets ménagers! Il existe un mode de collecte séparé pour les piles/accus usagées, ce qui permet d'effectuer un traitement et un recyclage en accord avec la législation. Veuillez contacter une autorité locale pour plus de renseignements sur le système mis en place.

Pour la Suisse : Les piles/accus usagées doivent être retournées chez votre détaillant.

Pour les pays hors Union Européenne : Veuillez contacter une autorité locale afin de connaître la bonne méthode à utiliser pour la collecte de vos piles/accus usagées.

### Información sobre la eliminación de la batería

Para EU: El contenedor de basura con ruedas tachado indica que las baterías usadas no deberían mezclarse con los residuos domésticos generales. Existe un sistema de recogida independiente de baterías usadas, para permitir un correcto tratamiento y reciclado de acuerdo con la legislación vigente. Por favor póngase en contacto con el sistema de recogida establecido o con las autoridades locales para la recogida selectiva de las baterías usadas.

Para Suiza: Las baterías usadas deben ser retomadas al punto de venta.

Para otros países fuera de la Unión Europea: Por favor póngase en contacto con las autoridades locales para un correcto procedimiento de eliminación de las baterías usadas.





### Information om batteriavyttring

För EU: Batteriet är märkt med den överkorsade soptunnan vilket betyder att det inte ska kastas i det vanliga hushållsavfallet. Det finns ett separat insamlingssystem för batterier för att underlätta korrekt behandling och återvinning enligt gällande lagstiftning. Kontakta kommunen för vidare information om insamling och återvinning.

För Schweiz: Använda batterier lämnas till inköpsstället.

För länder utanför EU: Kontakta de lokala myndigheterna för information om gällande sorterings- och återvinningsföreskrifter om du behöver göra dig av med ett använt batteri.



### Informação sobre Eliminação de Pilhas

Para a União Europeia: O conteúdo de rodas traçado significa que as baterias usadas não deverão ser colocadas junto com o lixo doméstico! Existe um sistema de separação próprio para baterias usadas, para permitir um tratamento e reciclagem própria de acordo com a legislação em vigor. Por favor contacte as autoridades locais para mais detalhes nos esquemas de recolha e reciclagem.

Para a Suíça: As baterias usadas deverão ser devolvidas ao ponto de venda.

Para os outros países fora da União Europeia: Por favor contacte a sua autoridade local para o método correcto de disposição das baterias usadas.



### Informazioni sullo smaltimento della batteria

Per EU: Il cassonetto barrato indica che le batterie usate non devono essere gettate assieme ai rifiuti domestici! Vi è un sistema di raccolta differenziata per le batterie usate, che consente il loro corretto trattamento e riciclo secondo quanto previsto dalle leggi vigenti. Vi prego di contattare le locali autorità per i dettagli del sistema di raccolta e riciclaggio.

Per la Svizzera: Le batterie usate devono essere restituite al punto vendita.

Per altri Stati non-EU: Vi prego di contattare le autorità locali per conoscere il metodo corretto di conferimento delle batterie usate.



### Tietoja paristojen hävittämisestä

EU-maat: Paristo/akku on merkitty yliviivatun roskasäiliön symbolilla, mikä tarkoittaa, että sitä ei saa hävittää kotitalouden yleisjätteen kanssa. Paristoille/akuille on olemassa erillinen keräysjärjestelmä, joka helpottaa niiden asianmukaista käsittelyä ja lainmukaista kierrätystä. Ota yhteys kuntaviranomaisiin saadaksesi lisätietoja keräyksestä ja kierrätyksestä.

Sveitsi: Käytetyt paristot/akut palautetaan ostopaikkaan.

EU:n ulkopuoliset maat: Ota yhteys paikallisviranomaisiin saadaksesi lisätietoja voimassa olevista laittelu- ja kierrätyssääöksistä ja ohjeet käytetyn pariston/akun hävittämiseen.



### Informatie over afvalverwerking van batterijen

Voor EU: De doorgestreepte vuilnisbak op wieltjes duidt aan dat de gebruikte batterijen niet mogen terecht komen in het gewone huishoudelijke afval. Er bestaat een gescheiden ophaalsysteem voor deze gebruikte batterijen om eigen behandeling en recyclage volgens de wetgeving toe te laten. Gelieve de lokale autoriteiten te contacteren voor de details van ophaling en recyclage.

Voor Zwitserland: De gebruikte batterij moet bij het verkooppunt teruggebracht worden.

Voor andere niet EU landen: Gelieve contact op te nemen met uw lokale autoriteiten voor de correcte methode van verwerking van de gebruikte batterijen.



### Information on Battery Disposal

For EU: The crossed-out wheeled bin implies that used batteries should not be put to the general household waste! There is a separate collection system for used batteries, to allow proper treatment and recycling in accordance with legislation. Please contact your local authority for details on the collection and recycling schemes.

For Switzerland: The used battery is to be returned to the selling point.









For other non-EU countries: Please contact your local authority for correct method of disposal of the used battery.

## Introduction

Thank you for purchasing this SHARP product.  
To obtain the best performance from this product, please read this manual carefully. It will guide you in operating your SHARP product.

## Accessories

Please confirm that only the following accessories are included.

 Remote control x 1	 RCA cable (2 pins - 2 pins) x 1
 Spike x 4 (length: 25 mm)	 Foot cushion x 4
 AC power lead x 1	
 AC/DC adaptor x 1 (Europe: RADPAA071AWZZ) (Other countries: RADPAA061AWZZ)	 Wall mount angle x 2
 Nut (Spike + Nut) x 4 (length: 30 mm)	 Pattern paper x 1

### Note:

The AC/DC adaptor is not included. Download from [www.SerManuals.com](http://www.SerManuals.com) All Manuals Search And Download.

## Features

SRS TruSurround HD™ creates an immersive, feature-rich surround sound experience from two speakers, complete with rich bass, high frequency detail and clear dialog.

## Contents

	Page
<b>■ General Information</b>	
Precautions .....	2
Controls and indicators .....	3 - 5
<b>■ Preparation for Use</b>	
Speaker preparation .....	6 - 8
Placing the speaker .....	9
Falling prevention .....	10
Speaker connections to TVs .....	10 - 11
AC power connection .....	11
Remote control .....	12
<b>■ Basic Operation</b>	
General control .....	13 - 14
<b>■ References</b>	
Troubleshooting chart .....	15 - 16
Maintenance .....	17
Error indicators and warnings .....	17
Specifications .....	18

# Precautions

## ■ General

- Please ensure that the equipment is positioned in a well-ventilated area and ensure that there is at least 10 cm (4") of free space along the sides and top of the equipment.

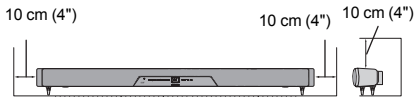

- Use the speaker on a firm, level surface free from vibration.
- Keep the speaker away from direct sunlight, strong magnetic fields, excessive dust, humidity and electronic/electrical equipment (home computers, facsimiles, etc.) which generate electrical noise.
- Do not place anything on top of the speaker.
- Do not expose the speaker to moisture, to temperatures higher than 60°C (140°F) or to extremely low temperatures.
- If your system does not work properly, disconnect the AC power lead from the Wall socket. Plug the AC power lead back in, and then turn on your system.
- In case of an electrical storm, unplug the speaker for safety.
- Hold the AC power plug by the head when removing it from the Wall socket, as pulling the lead can damage internal wires.
- The AC power plug is used as a disconnect device and shall always remain readily operable.
- **Do not remove the outer cover, as this may result in electric shock. Refer internal service to your local SHARP service facility.**
- This speaker should only be used within the range of 5°C - 35°C (41°F - 95°F).
- The ventilation should not be impeded by covering the ventilation openings with items, such as newspapers, tablecloths, curtains, etc.
- No naked flame sources, such as lighted candles, should be placed on the apparatus.

- Attention should be drawn to the environmental aspects of battery disposal.
- The apparatus is designed for use in moderate climate.
- Do not use an external power supply other than the 12V DC supplied with this unit as it may be damaged.
- SHARP is not responsible for damage due to improper use. Refer All servicing to a SHARP authorised service centre.

## Warning:

- The voltage used must be the same as that specified on this speaker. Using this product with a higher voltage other than that which is specified is dangerous and may result in a fire or other type of accident causing damage. SHARP will not be held responsible for any damage resulting from use of this speaker with a voltage other than that which is specified.
- The supplied AC/DC adaptor contains no user serviceable parts. Never remove covers unless qualified to do so. It contains dangerous voltages, always remove mains plug from the main outlet socket before any service operation or when not in use for a long period.
- The AC/DC adaptor supplied with the HT-SB400 must not be used with other equipment.
- Never use an AC/DC adaptor other than the one specified. Otherwise, problem or serious hazards may be created.

## ■ Volume control

The sound level at a given volume setting depends on speaker efficiency, location and various other factors. It is advisable to avoid exposure to high volume levels. Do not turn the volume on to full at switch on. Listen to music at moderate levels.

## ■ Precaution in using on the touch panel

- Do not use rough material to wipe the touch panel.
- Do not press the pad too hard, it can damage the touch sensor.

## Controls and indicators

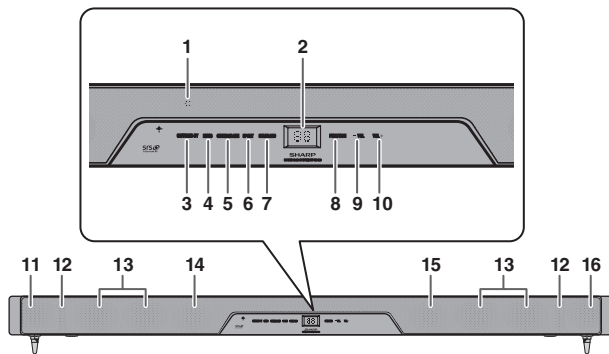

### ■ Front Panel

	Reference page		Reference page
1. Remote Sensor	12	9. Volume Down Pad/Indicator	13
2. Information Display	13	10. Volume Up Pad/Indicator	13
3. On/Stand-by Pad/Indicator	13	11. Left Front Speaker	
4. News Pad/Indicator	13	12. Bass Reflex Duct	
5. Cinema/Game Pad/Indicator	13	13. Subwoofers	
6. Sport Pad/Indicator	13	14. Left Centre Speaker	
7. Standard Pad/Indicator	13	15. Right Centre Speaker	
8. Function Pad/Indicator	14	16. Right Front Speaker	

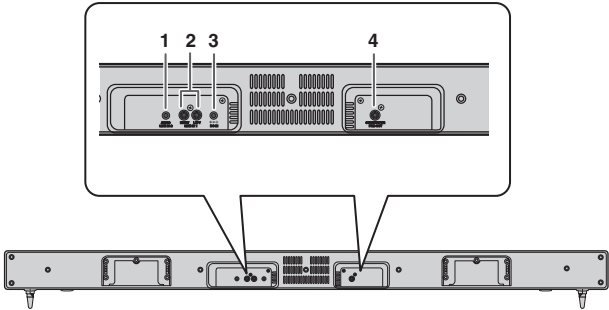

■ Rear Panel

Reference page

- 1. Audio Line In 2 socket ..... 11
- 2. Line In 1 sockets ..... 10
- 3. DC Input sockets ..... 11
- 4. Subwoofer Pre-Out sockets ..... 9

## Controls and indicators (continued)

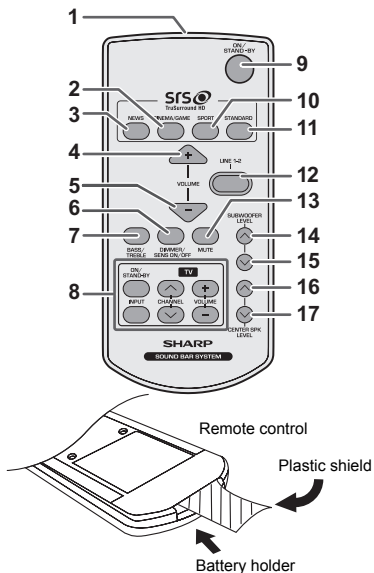





**Note:**  
Before using remote control, please remove plastic shield at battery holder.

## ■ Remote Control

	Reference page
1. Remote Control Transmitter . . . . .	12
2. Cinema/Game Button . . . . .	13
3. News Button . . . . .	13
4. Volume Up Button . . . . .	13
5. Volume Down Button . . . . .	13
6. Dimmer/Sensor On/Off Button . . . . .	13
7. Bass/Treble Button . . . . .	14
8. TV Operation Buttons . . . . .	5
9. On/Stand-by Button . . . . .	13
10. Sport Button . . . . .	13
11. Standard Button . . . . .	13
12. Line 1 - 2 Button . . . . .	14
13. Mute Button . . . . .	13
14. Subwoofer Level Up Button . . . . .	14
15. Subwoofer Level Down Button . . . . .	14
16. Centre Speaker Level Up Button . . . . .	14
17. Centre Speaker Level Down Button . . . . .	14

## TV Operation Buttons (Only SHARP TV):

On/Stand-by Button 	Sets the TV power to "ON" or "STANDBY".	Input Select Button (TV) 	Press the button to switch the input source.
Volume Up and Down Buttons 	Turn up/down the TV volume.	Channel Up and Down Buttons 	Switch up/down the TV channels.

**Notes:**

- Some models of SHARP TV may not be operable.
- SHARP TV remote will not work with HT-SB400 system.



## Speaker preparation

**Make sure to unplug the AC power lead before installing the speaker or changing the position.**

Select from three installation methods according to the preferred position.

### Using spikes

You may choose from the two different spike lengths provided: 25 mm and 30 mm.

Nuts (secured on 30 mm spikes) must be used when installing either the 25 mm or 30 mm spikes.

The speaker can be leveled by adjusting the spikes and nuts.

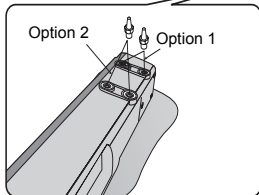

**Tighten all spikes as shown**

### Notes:

- Option 1 or option 2 indicates spike positions based on LCD TV stand.
- When attaching the spikes, place the speaker on a cushion or soft cloth to avoid damage.

### Caution:

When using these spikes on glossy or slippery table such as on glass top, stick foot cushions at the bottom of the spikes to avoid slippage.

### Using foot cushions

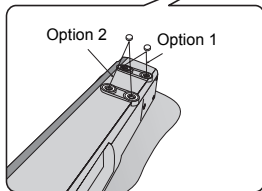

**Attach foot cushions as shown**

### Note:

Option 1 or option 2 foot cushion positions based on LCD TV stand.

## Speaker preparation (continued)

### To mount the speaker on the wall.

#### Caution:

- Be very careful to prevent the speaker [2.15 kg (4.74 lbs.)] from falling when mounting on the wall.
- Before mounting, check the wall strength. (Do not put on the veneer plaster or whitewashed wall. The speaker may fall.) If unsure, consult a qualified service technician.
- Mounting screws are not supplied. Use appropriate ones.
- Check all wall mount angle screws for looseness.
- Select a good location. If not, accidents may occur or the speaker may get damaged.
- **SHARP is not responsible for accidents resulting from improper installation.**

#### ■ Driving screws

SHARP designed the speakers so you may hang them on the wall. Use proper screws (not supplied). See below for size and type.

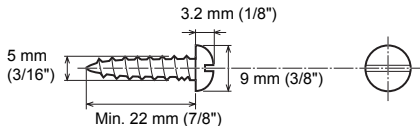

#### ■ Wall mount angle fixed to the wall (Horizontal position)

- 1 Fix the pattern paper to the wall in horizontal position as below.

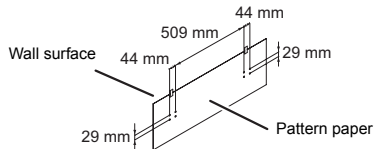

- 2 Make a hole on the wall following the screw point marks on the pattern paper by using a drill.

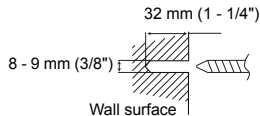

- 3 Fix a wall mount plug into the hole using a hammer, until it is flush with the wall surface.

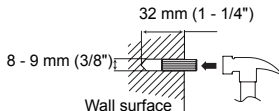

continued to the next page

- 4** Screw the wall mount angle to the wall as shown in the illustration. (Total screw is 8 pieces)

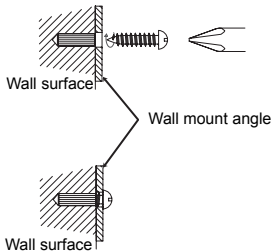
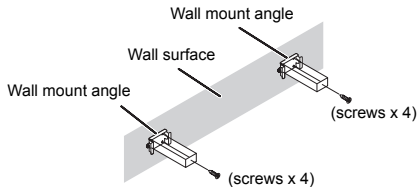

**Note:**  
Make sure all screws are fully tightened. (screws are not supplied)

## ■ Installing the speaker

- 1** Align the wall mount slot at the speaker to the wall mount angle.
- 2** Slot the speaker into the wall mount angle.
- 3** Fix them securely.

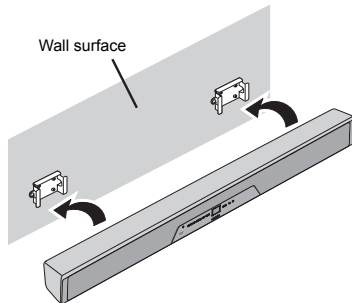

## Placing the speaker

Installation image:

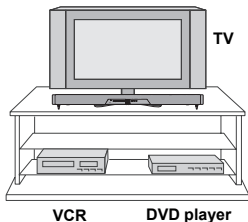

Place the speaker as shown.

### Notes:

- As the sound from the speaker is omni-directional, you can place the speaker anywhere you like. However, it is recommended to place it as close to the TV as possible.
- The front panel of the speaker is not removable.

### Caution:

- Do not change the installation direction when the speaker is turned on.
- Do not stand or sit on the speaker as you may be injured.

### ■ Using other subwoofer

You can connect a subwoofer with an amplifier to the SUBWOOFER PRE-OUT socket.

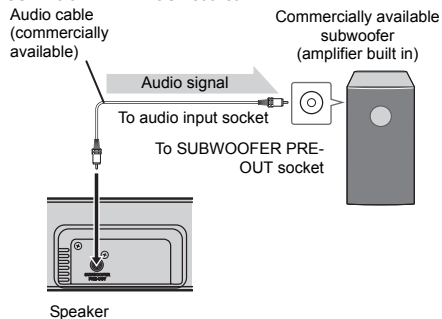

### Note:

No sound is heard from the subwoofer without a built-in amplifier.

## Falling prevention

Safety wires (not supplied) are useful to prevent the speaker from falling off the table.

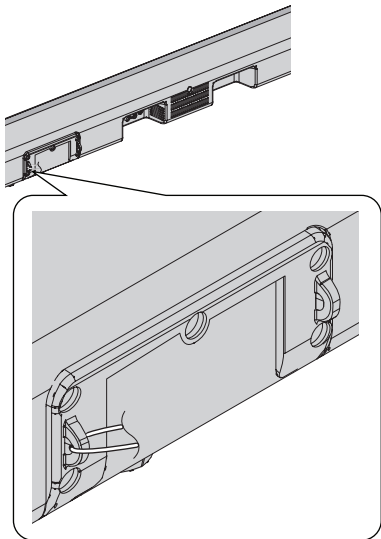

Loop the safety wires (not supplied) into each hole as shown and tie the safety wires to the LCD TV stand.

## Speaker connections to TVs

### Caution:

Turn off all other equipment before making any connections.

### Tuner receiving for other audio system

- Placing the aerial near the speaker AC power lead may cause noise pick up. Place the aerial away from the speaker for better reception.

### Notes:

- To connect to TV, use either LINE IN 1 sockets or AUDIO LINE IN 2 socket only.
- Refer the operation manual of the equipment to be connected.
- Fully insert the plugs to avoid fuzzy pictures or noises.

### ■ Connecting to a TV

If the TV/monitor has an audio output, connect it to the LINE IN 1 sockets on the rear of the speaker.

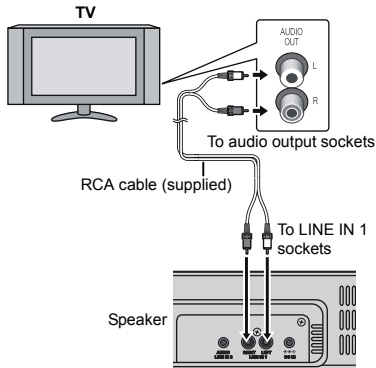

## Speaker connections to TVs (continued)

### ■ Connecting to a TV (with Headphone socket)

If the TV/monitor has headphone socket, connect it to the AUDIO LINE IN 2 socket on the rear of the speaker.

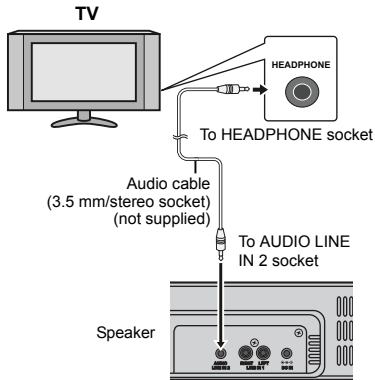

#### Notes:

- If the TV volume is continuously in low level, the speaker will automatically power off. Increase the TV output volume to enjoy the sound from the speaker.
- If the speaker volume is continuously in very high level, the speaker will mute and recover after several seconds.
- The information display on the sound bar system will not display anything when increasing or decreasing the volume level.

## AC power connection

### ■ Using with the AC/DC adaptor

- 1 Plug the AC power lead into the AC/DC adaptor.
- 2 Plug the AC/DC adaptor cable into the DC INPUT socket on the speaker.
- 3 Plug the AC power lead into a wall socket. The on/stand-by indicator will turn ORANGE when AC power is applied. The on/stand-by indicator will turn GREEN when the system in "ON".

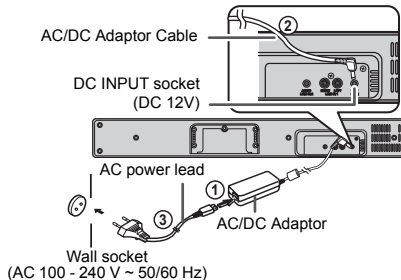

#### Notes:

- Unplug the AC/DC adaptor from the wall socket if the speaker will not be used for a prolonged period of time.
- Use only the supplied AC/DC adaptor. Using other AC/DC adaptor may cause an electric shock or fire.

# Remote control

HT-SB400

ENGLISH

## ■ Battery installation

- 1 Insert pin into the hole as shown and pull to open the battery holder.

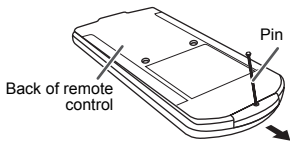

- 2 Remove the old battery from the battery holder, insert the new battery and then slide the battery holder back into the remote control.

Battery holder

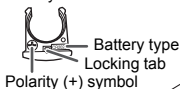

Polarity (+) symbol

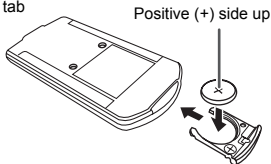

## Precautions for battery use:

- Remove the battery if the speaker will not be used for long periods of time. This will prevent potential damage due to battery leakage.

## Caution:

- Do not use rechargeable battery (nickel-cadmium battery, etc.).
- Danger of explosion if battery is incorrectly replaced.
- Replace only with the same or equivalent type.
- Batteries (battery pack or batteries installed) shall not be exposed to excessive heat such as sunshine, fire or the like.
- Installing the battery incorrectly may cause the speaker to malfunction.

## Notes concerning use:

- Replace the battery if the operating distance is reduced or if the operation becomes erratic. Purchase "CR 2025", coin lithium battery.
- Periodically clean the transmitter on the remote control and the sensor on the speaker with a soft cloth.
- Exposing the sensor on the speaker to strong light may interfere with operation. Change the lighting or the direction of the speaker if this occurs.
- Keep the remote control away from moisture, heat, shock, and vibrations.

## ■ Test of the remote control

Point the remote control directly at the remote sensor on the speaker.

**The remote control can be used within the range shown below:**

Press the ON/STAND-BY button. Does the power turn on? Now, you can enjoy your system.

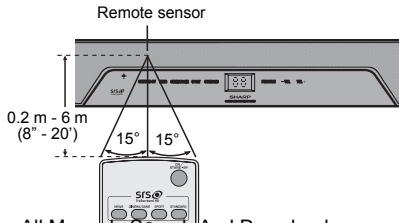

Preparation for Use

## General control

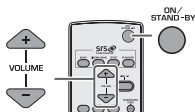
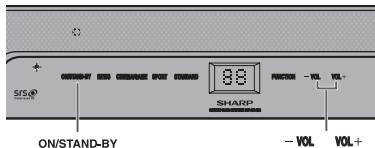

### ■ To turn the power on

Press the ON/STAND-BY button on the remote control or touch anywhere on the display panel. All the indicators will be displayed to indicate pad positions.

- The ON/STAND-BY indicator turns GREEN. If the power does not turn on, check whether the power lead is plugged in properly.

### To set the speaker to stand-by mode:

- Press the ON/STAND-BY button again on the remote control or touch ON/STAND-BY pad on the speaker. The ON/STAND-BY indicator turns ORANGE.

### ■ Display brightness control

Press the DIMMER/SENS ON/OFF button to adjust the brightness of the display and sound mode indicator.

Sound mode indicator and display bright.

Display will off after 5 seconds without any button/pad operation.



Sound mode indicator and display dim.

Display will off after 5 seconds without any button/pad operation.

### ■ Volume auto fade-in

If you turn off and on the speaker with the volume set to 40 or higher, the volume starts at 20 and fades in to the last set level.

### ■ Volume control

#### Speaker operation:

Touch VOL + pad to increase the volume and touch - VOL pad to decrease the volume.

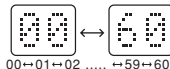

#### Remote control operation:

Press the VOLUME + button to increase the volume and the VOLUME - button to decrease the volume.

### ■ Muting

The volume is muted temporarily when pressing the MUTE button on the remote control. Press again to restore the volume.



### ■ Preset sound mode

#### Speaker operation:

Touch a desired sound mode on the speaker.

#### Remote control operation:

Press a desired sound mode on the remote control.

NEWS	TruSurround HD on for news
CINEMA/GAME	TruSurround HD on for cinema/game sound effect
SPORT	TruSurround HD on for sport broadcasting
STANDARD	TruSurround HD on for standard sound effect



### ■ Subwoofer level control

The subwoofer level can be adjusted.

**To increase** the level, press the SUBWOOFER LEVEL  $\wedge$  button.

**To decrease** the level, press the SUBWOOFER LEVEL  $\vee$  button.

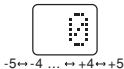

#### Note:

When sound from the speaker is distorted, decrease the subwoofer level.

### ■ Centre speaker level control

The centre speaker level can be adjusted.

**To increase** the level, press the centre SPK LEVEL  $\wedge$  button.

**To decrease** the level, press the centre SPK LEVEL  $\vee$  button.

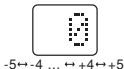

### ■ Bass control

1. Press the BASS/TREBLE button to select "BASS".
2. Within 5 seconds, press the VOLUME (+ or -) button to adjust the bass.

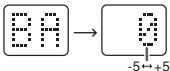

### ■ Treble control

1. Press the BASS/TREBLE button to select "TREBLE".
2. Within 5 seconds, press the VOLUME (+ or -) button to adjust the treble.

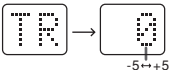

### ■ Touch Sensing Off mode

During Stand-by mode, press the DIMMER/SENS ON/OFF button on the remote control and the on/stand-by indicator will turn from ORANGE to RED.

To turn the power on, press the ON/STAND-BY button on the remote control or touch the ON/STAND-BY pad on the display panel.

### ■ Function

When the FUNCTION pad on speaker is touched or LINE 1 - 2 button on the remote control is pressed, the input source will change. Touch the FUNCTION pad on speaker or LINE button on the remote control repeatedly to select desired input source.

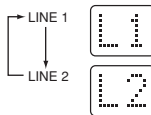

#### Note:

The backup function will protect the memorized function mode for a few hours should there be a power failure or the AC power lead becomes disconnected.

#### Auto power on function:

When you press the LINE button on the remote control, the speaker will turn on at last function.

#### Auto power off and auto detect signal:

The speaker will automatically off after 1 minute of inactivity. The ON/STAND-BY indicator turns orange. At this point, it will automatically power ON if it detects audio signal from connected equipment.

#### Note:

Make sure to turn off any source/signal input to speaker before going to stand-by mode because it will cause the speaker to power ON again.

## Troubleshooting chart

Many potential problems can be resolved by the owner without calling a service technician.

If something is wrong with this product, check the following before calling your authorized SHARP dealer or service centre.

### ■ General

Symptom	Possible cause
No sound is heard.	<ul style="list-style-type: none"> <li>● Is the input signal (selection) set properly?</li> <li>● Is the volume level set to "0"?</li> <li>● Is muting activated?</li> </ul>
Noise is heard during playback.	<ul style="list-style-type: none"> <li>● Move the speaker away from any computers or mobile phones.</li> </ul>
When a button is pressed, the speaker does not respond.	<ul style="list-style-type: none"> <li>● Set this speaker to the stand-by mode and then turn it back on.</li> </ul>
The power is not turned on.	<ul style="list-style-type: none"> <li>● Is the AC/DC adaptor unplugged? (Refer to page 11)</li> <li>● The protection circuit may be activated. Unplug and plug in the power lead again after 5 minutes or more.</li> </ul>

### ■ Remote control

Symptom	Possible cause
The remote control does not operate properly.	<ul style="list-style-type: none"> <li>● Is the battery polarity correct?</li> <li>● Is the battery dead?</li> <li>● Is the distance or angle incorrect?</li> <li>● Are there any obstructions in front of the speaker?</li> <li>● Is there a strong light shining on the remote sensor?</li> <li>● Is the remote control for another equipment used simultaneously?</li> </ul>
The speaker cannot be turned on with the remote control.	<ul style="list-style-type: none"> <li>● Is the AC power lead of the speaker plugged in?</li> <li>● Is the battery inserted?</li> </ul>
TV cannot be operated with the remote control.	<ul style="list-style-type: none"> <li>● Depending on the model, some or all functions may not be operable using the remote control of this speaker. In this case, use the remote control supplied with the TV.</li> </ul>

### ■ Condensation

Sudden temperature changes, storage or operation in an extremely humid environment may cause condensation inside the cabinet or on the transmitter or the remote control.

Condensation can cause the speaker to malfunction. If this happens, leave the power on until normal playback is possible (about 1 hour). Wipe off any condensation on the transmitter with a soft cloth before operating the speaker.

### ■ If problem occurs

When this product is subjected to strong external interference (mechanical shock, excessive static electricity, abnormal supply voltage due to lightning, etc.) or if it is operated incorrectly, it may malfunction.

#### **If such a problem occurs, do the following:**

1. Set the speaker to the stand-by mode and turn the power on again.
2. If the speaker is not restored in the previous operation, unplug and plug in the speaker, and then turn the power on.

### ■ Factory reset, clearing all setting

Make sure to disconnect all audio input cables attached to the speaker before performing the factory reset.  
Can be operated on the remote control only.

1. Press the ON/STAND-BY button to enter the power stand-by mode.
2. Press and hold the ON/STAND-BY button until "CL" appears.



#### **Caution:**

This operation will erase all data stored in memory.

## Maintenance

### ■ Cleaning the cabinet

Periodically wipe the cabinet with a soft cloth.



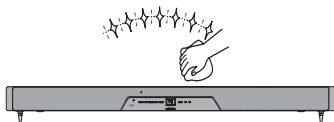

#### Caution:

- Do not use chemicals for cleaning (gasoline, paint thinner, etc.). It may damage the cabinet finish.
- Do not apply oil to the inside of each component. It may cause malfunctions.



## Error indicators and warnings

When you fail to perform operations properly, the following messages are displayed on the speaker.

Display	Meaning
 or  or  or 	<ul style="list-style-type: none"> <li>● Malfunction of the surround circuit. Place the speaker away from noise source and plug the AC power lead into another AC outlet. (*)</li> </ul>
 ON/STAND-BY indicator (blinks red)	<ul style="list-style-type: none"> <li>● When the protection circuit of the amplifier is activated.</li> </ul>

(\*): Should the same message appear even if the speaker is unplugged and plugged in, or is set to the stand-by mode and on again, contact your local dealer where you purchased the speaker.

## Specifications

As part of our policy of continuous improvement, SHARP reserves the right to make design and specification changes for product improvement without prior notice. The performance specification figures indicated are nominal values of production speaker. There may be some deviations from these values in individual speaker.

### ■ General

<b>Power source</b>	DC IN 12V $\overline{\text{---}}$ 4A: AC/DC adaptor (AC 100 - 240 V ~ 50/60 Hz)
<b>Power consumption</b>	Power on: 12 W Power Stand-by: 0.6 W (*)
<b>Output power</b>	Front Speaker: RMS: 10 W (5 W + 5 W) (10% T.H.D.) RMS: 9.6 W (4.8 W + 4.8 W) (0.9% T.H.D.) Centre Speaker: RMS: 7 W (10% T.H.D.) RMS: 6.5W (0.9% T.H.D.) Subwoofer: RMS: 15 W (10% T.H.D.) RMS: 9.8 W (0.9% T.H.D.)

<b>Speaker</b>	3.1-way Speaker System Front Speakers: 40 mm (1-9/16") Full Range (x 2) Impedance: 12 ohms / Channel Centre Speakers: 40 mm (1-9/16") Full Range (x 2) Impedance: 6 ohms (12 ohms x 2 parallel connections) Subwoofer: 57 mm (2-1/4") Woofer (x4) Impedance: 3 ohms (12 ohms x 4 parallel connections)
<b>Audio output terminals</b>	Subwoofer Pre Out: 10 k ohms
<b>Input terminals</b>	Analogue input (LINE 1): RCA type x 1pair (L/R) 500 mV/47 k ohms Analogue input (LINE 2): Stereo mini jack $\varnothing$ 3.5 mm 100 mV/47 k ohms
<b>Dimensions</b>	Width: 985 mm (38-3/4") Height: 96 mm (3-3/4") Depth: 70 mm (2-3/4")
<b>Weight</b>	2.15 kg (4.74 lbs.)

(\*) This power consumption value is obtained when in the touch sensing off mode (RED).

UP

DOWN

HT-SB400



SOUND BAR SYSTEM

**SHARP**

## Free Manuals Download Website

<http://myh66.com>

<http://usermanuals.us>

<http://www.somanuals.com>

<http://www.4manuals.cc>

<http://www.manual-lib.com>

<http://www.404manual.com>

<http://www.luxmanual.com>

<http://aubethermostatmanual.com>

Golf course search by state

<http://golfingnear.com>

Email search by domain

<http://emailbydomain.com>

Auto manuals search

<http://auto.somanuals.com>

TV manuals search

<http://tv.somanuals.com>