

SONY®

Click 

Handycam Handbook HDR-XR100/XR101/XR200/XR200V



Table of Contents

Useful Recording Techniques

Index

HANDYCAM®

Using the Handycam Handbook

You will find information on using your camcorder to its fullest in this Handycam Handbook. Read the Handycam Handbook in addition to the Operating Guide (a separate volume). Information on using your camcorder connected to a computer will be found in the Operating Guide and the PMB Guide that is the Help of the supplied “PMB (Picture Motion Browser)” software.

Searching for information quickly

Click an item on the right edge of each page, and you will jump to the page for that item.

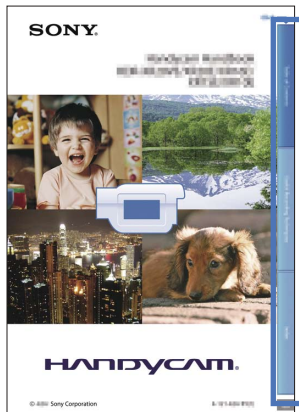

← Click here.

- You can search for an item by keyword using Adobe Reader. Refer to the Help of Adobe Reader for tips on how to use Adobe Reader.
- You can print out the Handycam Handbook.

About this Handycam Handbook

- The example images used in this Handycam Handbook for illustration purposes are captured using a digital still camera, and therefore may appear different from images and screen indicators that actually appear on your camcorder.
- The HDR-XR200V is used for illustrations in this book, unless otherwise mentioned.
- In this Handycam Handbook, the internal hard disk of your camcorder and “Memory Stick PRO Duo” media are called “recording media.”
- “Memory Stick PRO Duo” media and “Memory Stick PRO-HG Duo” media are both referred to as “Memory Stick PRO Duo” media in this manual.
- Design and specifications of your camcorder and accessories are subject to change without notice.

Table of contents

Using the Handycam Handbook.....	2
Searching for information quickly.....	2
Useful recording techniques.....	6
Parts and controls.....	7
Screen indicators.....	10
“HOME” and “OPTION” - Taking advantage of two types of menus.....	12
Using the HOME MENU.....	12
Using the OPTION MENU.....	12
Menu lists.....	13
List of the HOME MENU.....	13
List of the OPTION MENU.....	14
Read this before operating your camcorder.....	15
Notes on using the Hard Disk Drive Handycam.....	16

Getting started

Step 1: Charging the battery pack.....	18
Step 2: Turning the power on, and setting the date and time.....	21
Changing the language setting.....	22

Recording/Playback

Five pieces of advice for successful recording.....	23
Recording and playing movies and photos easily (EASY Easy Handycam Operation)	24
Recording movies.....	24
Shooting photos.....	26
Playing movies.....	27
Viewing photos.....	29
Recording.....	31
Recording movies.....	31
Shooting photos.....	33
Useful functions for recording movies and photos.....	35
Zooming.....	35
Recording sound with more presence (5.1ch surround recording).....	35
Recording high quality photos during movie recording (Dual Rec).....	36
Recording in dark places (NightShot) (HDR-XR200/XR200V).....	36
Recording in mirror mode.....	37
Recording fast action in slow-motion (SMTH SLW REC).....	37
Switching the screen display, or turning the LCD backlight on/off.....	38
Acquiring location information (GPS) (HDR-XR200V).....	38

Playback on the camcorder	40
Playing movies	40
Viewing photos	42
Useful functions for playing movies and photos	43
Searching for a desired scene by recording location (Map Index) (HDR- XR200V).....	43
Searching for desired scene by pinpoint (Film Roll Index)	44
Searching for desired scene by face (Face Index)	45
Playing back a digest of your movies (HIGHLIGHT PLAYBACK) (HDR-XR200/ XR200V).....	46
Searching for desired images by date (Date Index).....	47
Using PB zoom with photos	48
Playing back a series of photos (Slide show)	49
Playing images on a TV	50
Connecting a TV using [TV CONNECT Guide].....	50
Connecting to a high definition TV	51
Connecting to a non-high-definition 16:9 (wide) or 4:3 TV	52
Using "BRAVIA" Sync.....	54

Editing

Deleting movies and photos.....	56
Acquiring the current location information (HDR-XR200V)	58
Capturing a photo from a movie.....	59
Dubbing/copying movies and photos from the internal hard disk to "Memory Stick PRO Duo" media.....	60
Dubbing movies	60
Copying photos	61
Protecting recorded movies and photos (Protect)	62
Dividing a movie	63
Using the Playlist of movies.....	64
Creating the Playlist	64
Playing the Playlist	65
Creating a disc with a DVD writer, recorder.....	66
Creating a high definition image quality (HD) disc with a DVD writer, etc. (USB cable connection)	66
Creating a standard definition image quality (SD) disc with a recorder, etc. (A/V connecting cable connection)	66
Checking the battery information	68

Utilizing recording media

Changing the recording medium.....	69
Selecting the recording media for movies.....	69
Selecting the recording media for photos.....	69

Inserting "Memory Stick PRO Duo" media	69
Checking the media information	71
Deleting all movies and photos (Formatting)	71
Preventing data on the internal hard disk from being recovered	72

Customizing your camcorder

MOVIE SETTINGS (Items for recording movies)	73
PHOTO SETTINGS (Items for recording photos)	80
FACE FUNC. SET (Items to set face function)	84
VIEW IMAGES SET (Items to customize the display)	86
SOUND/DISP SET (Items to adjust the sound and the screen)	89
OUTPUT SETTINGS (Items for when connected to a TV)	91
CLOCK/LANG (Items to set clock and language)	94
GENERAL SET (Other setup items)	96
Functions set in the OPTION MENU	99

Troubleshooting

Troubleshooting	106
Self-diagnosis display/Warning indicators	112

Additional information

Recording time of movies/number of recordable photos	116
Expected time of recording and playback with each battery pack	116
Expected recording time of movies	117
Expected number of recordable photos	118
Using your camcorder abroad	119
File/folder structure on the internal hard disk and "Memory Stick PRO Duo" media	121
Maintenance and precautions	122
About the AVCHD format	122
About GPS (HDR-XR200V)	123
About "Memory Stick" media	124
About the "InfolITHIUM" battery pack	126
About x.v.Color	127
About handling of your camcorder	127
Index	131

Useful recording techniques

Checking your golf swing



- ▶ SMTH SLW REC..... 37

Getting a good shot of a ski slope or beach



- ▶ AUTO BACK LIGHT..... 79
- ▶ BEACH..... 102
- ▶ SNOW..... 102

Compensating for camera shake during movie recording



- ▶  STEADYSHOT..... 76

Capturing smiles automatically



- ▶ SMILE SHUTTER..... 85

A child on the stage under a spot light



- ▶ SPOTLIGHT..... 102

Flowers in close-up



- ▶ PORTRAIT..... 102
- ▶ FOCUS..... 101
- ▶ TELE MACRO..... 100

Fireworks with all its splendor



- ▶ FIREWORKS..... 102
- ▶ FOCUS..... 101

Focusing on the dog on the left side of the screen



- ▶ FOCUS..... 101
- ▶ SPOT FOCUS..... 100
- ▶ SPOT MTR/FCS..... 99

Parts and controls

Figures in () are reference pages.

HDR-XR100/XR101

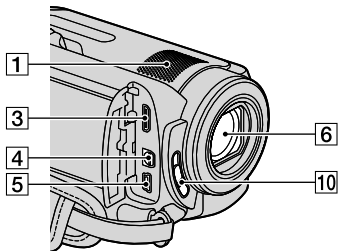

HDR-XR200/XR200V

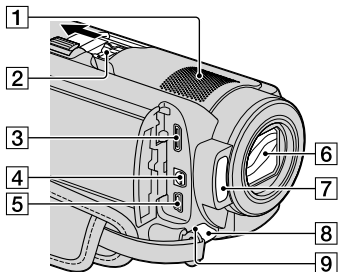

1 Built-in microphone (35)

When an external microphone (sold separately) is connected, it takes precedence over the built-in microphone.

2 Active Interface Shoe



The Active Interface Shoe supplies power to accessories such as a video light, a flash, or a microphone (sold separately). The accessory can be turned on or off as you open or close the LCD screen of your camcorder. Refer to the operating instructions supplied with your accessory for details.

The Active Interface Shoe has a safety device for fixing the installed accessory securely. To connect an accessory, press down and push it to the end, and then tighten the screw. To

remove an accessory, loosen the screw, and then press down and pull out the accessory.

- When you open or close the shoe cover, slide it as indicated by the arrow.
- When you are recording movies with an external flash (sold separately) connected to the accessory shoe, turn off the power of the external flash to prevent charging noise being recorded.
- You cannot use an external flash (sold separately) and the built-in flash at the same time.
- When an external microphone (sold separately) is connected, it takes precedence over the built-in microphone (p. 35).

3 HDMI OUT (mini) jack (50)

4 A/V Remote Connector (50, 67)

5 Ψ (USB) jack (66)

6 Lens (Carl Zeiss lens) (16)

7 Flash (78, 82)

8 Camera recording lamp (96)

The camera recording lamp lights up in red during recording. The lamp flashes when the remaining recording media capacity or battery power is low.

9 Remote sensor/Infrared port

Point the Wireless Remote Commander (p. 9) towards the remote sensor to operate your camcorder.

10 LENS COVER switch (24, 31)

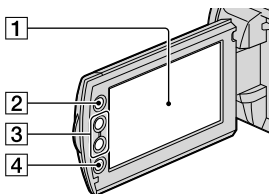

1 LCD screen/Touch panel (12, 37)

If you rotate the LCD panel 180 degrees, you can close the LCD panel with the LCD screen

facing out. This is convenient during playback operations.

- 2 **↑** (HOME) button (12)
- 3 Zoom buttons (35, 48)
- 4 START/STOP button (25, 32)

HDR-XR100/XR101

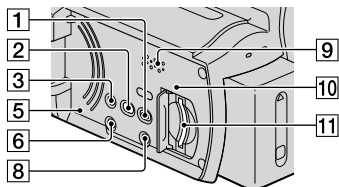

HDR-XR200/XR200V

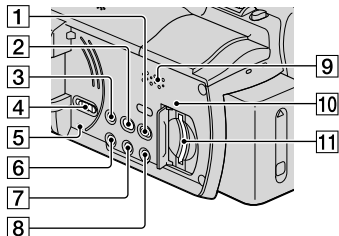

- 1 **▶** (VIEW IMAGES) button (27, 40)
- 2 **Ⓢ** (DISC BURN) button (see Operating Guide)
- 3 EASY button (25, 26)
- 4 GPS switch (HDR-XR200V) (38)
- 5 RESET button
Press RESET to initialize all the settings including the clock setting.
- 6 POWER button (21)
- 7 NIGHTSHOT button (36)
- 8 DISP (display) button (38)
- 9 Speaker
- 10 Access lamp ("Memory Stick PRO Duo" media) (69)
While the lamp is lit or flashing, the camcorder is reading or writing data.
- 11 "Memory Stick Duo" media slot (69)

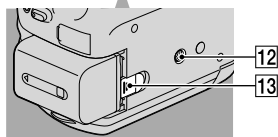
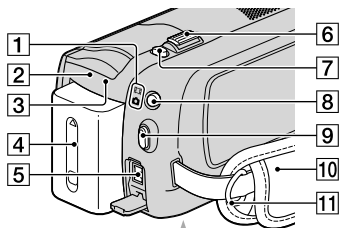

- 1 **Ⓜ** (Movie)/**📷** (Photo) lamps (21)
- 2 CHG lamp (HDR-XR100/XR101)/**⚡**/CHG lamp (HDR-XR200/XR200V) (18)
- 3 ACCESS lamp (Hard disk) (18)
While the lamp is lit or flashing, the camcorder is reading or writing data.
- 4 Battery pack (18)
- 5 DC IN jack (18)
- 6 Power zoom lever (35, 48)
- 7 PHOTO button (27, 34)
- 8 MODE button (26, 33)
- 9 START/STOP button (25, 32)
- 10 Grip belt (24, 31)
- 11 Hook for a shoulder belt
- 12 Tripod receptacle
Attach a tripod (sold separately) to the tripod receptacle using a tripod screw (sold separately: the length of the screw must be less than 5.5 mm (7/32 in.)).
- 13 BATT (battery) release lever (19)

Wireless Remote Commander

Only for HDR-XR200/XR200V

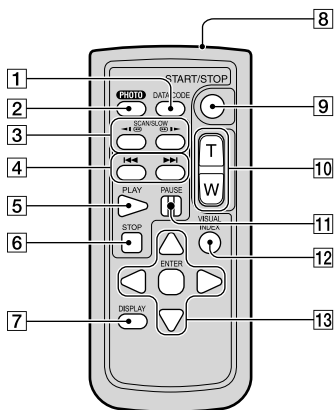

1 DATA CODE button (88)

Displays the date and time, camera setting data, or coordinates (HDR-XR200V) of the recorded images when you press this button during playback.

2 PHOTO button (27, 34)

The on-screen image when you press this button will be recorded as a still image.

3 SCAN/SLOW buttons (29, 42)

4 ◀▶/▶▶ (Previous/Next) buttons (29, 30, 41, 42)

5 PLAY button (29, 41)

6 STOP button (29, 41)

7 DISPLAY button (38)

8 Transmitter

9 START/STOP button (25, 32)

10 Power zoom buttons (35, 48)

11 PAUSE button (29, 41)

12 VISUAL INDEX button (27, 40)

Displays a VISUAL INDEX screen during playback.

13 ◀▶/▶▶/▶▶/ENTER buttons

When you press any of these buttons, the orange frame appears on the LCD screen. Select a desired button or an item with

◀▶/▶▶/▶▶, then press ENTER to enter.

⚡ Notes

- Remove the insulation sheet before using the Wireless Remote Commander.

Insulation sheet

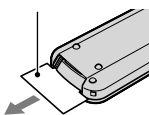

- Point the Wireless Remote Commander towards the remote sensor to operate your camcorder (p. 7).
- When no commands have been sent from the Wireless Remote Commander within a certain period, the orange frame disappears. When you press any of ◀▶/▶▶/▶▶, or ENTER again, the frame appears at the position where it was displayed last.
- You cannot select some buttons on the LCD screen using ◀▶/▶▶/▶▶.

To change the battery of the Wireless Remote Commander

- While pressing on the tab, inset your fingernail into the slit to pull out the battery case.
- Place a new battery with the + side facing up.
- Insert the battery case back into the Wireless Remote Commander until it clicks.

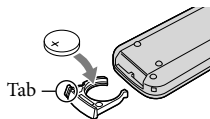

WARNING

Battery may explode if mistreated. Do not recharge, disassemble or dispose of in fire.

- When the lithium battery becomes weak, the operating distance of the Wireless Remote Commander may shorten, or the Wireless Remote Commander may not function properly. In this case, replace the battery with a Sony CR2025 lithium battery. Use of another battery may present a risk of fire or explosion.

Screen indicators

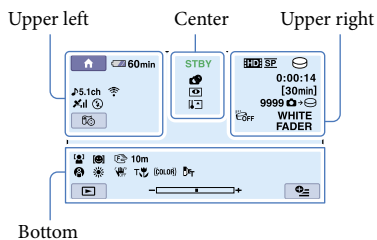

Upper left

Indicator	Meaning
	HOME button (12)
	AUDIO MODE (74)
	Self-timer recording (105)
	GPS tracking status (38)
	YOUR LOCATION (58)
	Flash, REDEYE REDUC (78, 83)
	BLT-IN ZOOM MIC (104)
	MICREF LEVEL low (105)
	WIDE SELECT (74)
	Remaining battery
	Return button (12)

Center

Indicator	Meaning
	Recording status (25, 32)
	Photo size (80)
	Slide show set (49)
	NightShot (36)
	Warning (112)
	Playback mode (27, 40)

Upper right

Indicator	Meaning
	Recording image quality (HD/SD) and recording mode (FH/HQ/SP/LP) (73)

Indicator	Meaning
	Recording/playback media (69)
	Counter (hour:minute:second) (27, 40)
	Estimated recording remaining time (27, 40)
	FADER (104)
	LCD backlight off (38)
	Drop sensor off (98)
	Drop sensor activated (98)
	Approximate number of recordable photos and recording media (26, 33)
	Playback folder (42)
	Current playing movie or photo/Number of total recorded movies or photos (27, 40)

Bottom

Indicator	Meaning
	FACE DETECTION (84)
	DETECTION SET (85)
	Manual focus (101)
	SCENE SELECTION (102)
	White balance (103)
	SteadyShot off (76, 81)
	SPOT MTR/FCS/SPOT METER/EXPOSURE (99, 101)
	TELE MACRO (100)
	X.V.COLOR (76)
	CONVERSION LENS (79, 83)
	OPTION button (12)
	VIEW IMAGES button (27, 40)
	Slide show button (49)
	Data file name (29, 42)
	Protected image (62)
	VISUAL INDEX button (29, 42)

- Indicators and their positions are approximate and may differ from what you actually see.
- Some indicators may not appear depending on the model.

“HOME” and “OPTION” - Taking advantage of two types of menus

Using the HOME MENU

When you press the **HOME** button, the HOME MENU appears. You can change the settings of your camcorder, etc.

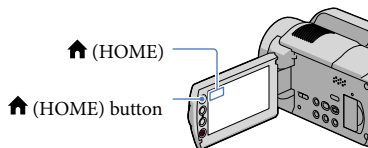

- 1 Touch the desired category → the menu item to be changed.

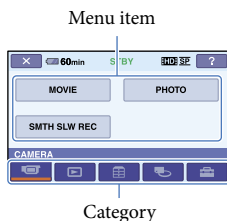

- 2 Follow the instructions on the screen.

- 3 After completing the setting, touch **OK**.

- When the item is not on the screen, touch **▲**/**▼**.
- To return to the previous screen, touch **◀**.
- To hide the HOME MENU screen, touch **X**.
- You cannot select the grayed items or settings.

Using the HELP function

To see the descriptions on the HOME MENU, touch **?** (HELP) on the HOME MENU screen. (The bottom of **?** turns orange.) Then, touch the item you want to know about.

Using the OPTION MENU

The **OPTION** MENU appears just like the pop-up window that appears when you right-click the mouse on a computer. The menu items you can change in the context appears.

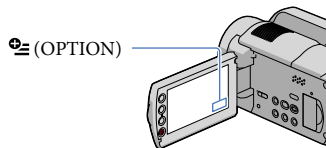

- 1 Touch the desired tab → the item to change the setting.

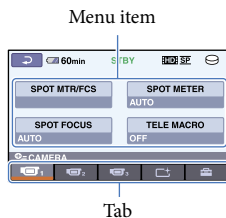

- 2 After completing the setting, touch **OK**.

Notes

- When the item you want is not on the screen, touch another tab. (There may be no tab.)
- You cannot use the OPTION MENU during Easy Handycam operation.
- The tabs and items that appear on the screen depend on the recording/playback status of your camcorder at the time.



Menu lists

List of the HOME MENU























(CAMERA) category



MOVIE* ¹	p. 31
PHOTO* ¹	p. 33
SMTH SLW REC	p. 37

(VIEW IMAGES) category

VISUAL INDEX* ¹	p. 42
 JMAP* ^{1*3}	p. 43
 FILM ROLL* ¹	p. 44
 FACE* ¹	p. 45
PLAYLIST	p. 64

(OTHERS) category







DELETE* ¹	
 DELETE	p. 56
 DELETE	p. 56
 YOUR LOCATION* ^{1*3}	p. 58
PHOTO CAPTURE	p. 59
MOVIE DUB	
  	p. 60
 	p. 60
PHOTO COPY	
COPY by select	p. 61
COPY by date	p. 61
EDIT	
 DELETE	p. 56
 DELETE	p. 56
 PROTECT	p. 62
 PROTECT	p. 62
 DIVIDE	p. 63
PLAYLIST EDIT	
 ADD/  ADD	p. 64
 ADD by date/  ADD by date	p. 64
 ERASE/  ERASE	p. 65
 ERASE ALL/  ERASE ALL	p. 65
 MOVE/  MOVE	p. 65
USB CONNECT	

 USB CONNECT	p. 66
 USB CONNECT	p. 66
DISC BURN	Operating Guide
DOWNLOAD MUSIC* ⁴	p. 46
TV CONNECT Guide* ¹	p. 50
MUSIC TOOL	p. 46
DOWNLOAD MUSIC* ^{1*4}	p. 46
EMPTY MUSIC* ^{1*4}	p. 46
BATTERY INFO	p. 68

(MANAGE MEDIA) category

MOVIE MEDIA SET* ¹	p. 69
PHOTO MEDIA SET* ¹	p. 69
MEDIA INFO	p. 71
MEDIA FORMAT* ¹	p. 71
REPAIR IMG.DB F.	p. 110, 113

(SETTINGS) category

MOVIE SETTINGS	
  SET* ¹	p. 73
REC MODE	p. 73
AUDIO MODE	p. 74
NIGHTSHOT LIGHT* ⁴	p. 74
WIDE SELECT	p. 74
DIGITAL ZOOM	p. 75
 STEADYSHOT	p. 76
AUTO SLW SHUTTR	p. 76
X.V.COLOR	p. 76
GUIDEFAME	p. 77
 REMAINING SET	p. 77
FLASH MODE* ^{1*4}	p. 78
FLASH LEVEL* ⁴	p. 78
REDEYE REDUC* ⁴	p. 78
CONVERSION LENS	p. 79
AUTO BACK LIGHT	p. 79
PHOTO SETTINGS	
 IMAGE SIZE* ¹	p. 80
FILE NO.	p. 80
NIGHTSHOT LIGHT* ⁴	p. 80
 STEADYSHOT* ⁴	p. 81
AUTO SLW SHUTTR	p. 81
GUIDEFAME	p. 81
FLASH MODE* ^{1*4}	p. 82
FLASH LEVEL* ⁴	p. 82
REDEYE REDUC* ⁴	p. 83

CONVERSION LENS	p. 83
AUTO BACK LIGHT	p. 83
FACE FUNC. SET	
FACE DET. SETTING	p. 84
SMILE SHUTTER*2	p. 85
VIEW IMAGES SET	
HDR/HSDB SET	p. 86
DATA CODE	p. 86
SOUND/DISP SET	
VOLUME*1	p. 89
BEEP*1	p. 89
LCD BRIGHT	p. 89
LCD BL LEVEL	p. 89
LCD COLOR	p. 90
OUTPUT SETTINGS	
TV TYPE	p. 91
DISP OUTPUT	p. 92
COMPONENT	p. 92
HDMI RESOLUTION	p. 92
CLOCK/ LANG	
CLOCK SET*1	p. 21
AREA SET	p. 94
AUTO CLOCK ADJ*3	p. 94
AUTO AREA ADJ*3	p. 94
DST SET/SUMMERTIME	p. 95
LANGUAGE SET*1	p. 95
GENERAL SET	
DEMO MODE	p. 96
REC LAMP*4	p. 96
CALIBRATION	p. 128
A.SHUT OFF	p. 97
POWER ON BY LCD	p. 97
REMOTE CTRL*4	p. 97
DROP SENSOR	p. 98
CTRL FOR HDMI	p. 98

List of the OPTION MENU

Following items are available on the OPTION MENU only.

tab

SPOT MTR/FCS	p. 99
SPOT METER	p. 99
SPOT FOCUS	p. 100
TELE MACRO	p. 100
EXPOSURE	p. 101
FOCUS	p. 101
SCENE SELECTION	p. 102
WHITE BAL.	p. 103

tab

FADER	p. 104
-------	--------

tab

BLT-IN ZOOM MIC	p. 104
MICREF LEVEL	p. 105
SELF-TIMER	p. 105
TIMING	p. 38

The tab depends on the situation/no tab

SLIDE SHOW	p. 49
SLIDE SHOW SET	p. 49

• [SOUND/DISP SET] is changed to [SOUND SETTINGS] during Easy Handycam operation.

*1 You can set this item during Easy Handycam operation.

*2 You cannot set [FRAME SETTING] during Easy Handycam operation.

*3 HDR-XR200V

*4 HDR-XR200/XR200V

Read this before operating your camcorder

Supplied items

The numbers in () are the supplied quantity.

- AC Adaptor (1)
- Power cord (Mains lead) (1)
- Component A/V cable (1) **A**
- A/V connecting cable (1) **B**
- USB cable (1) **C**
- Wireless Remote Commander (1)
Only for HDR-XR200/XR200V
 - A button-type lithium battery is already installed.
- Rechargeable battery pack NP-FH60 (1)
- CD-ROM "Handycam Application Software" (1)
 - "PMB" (software, including "PMB Guide")
 - "Handycam Handbook" (PDF)
- "Operating Guide" (1)

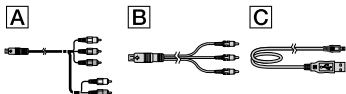

- See page 69 for "Memory Stick" media you can use with this camcorder.

Using the camcorder

- Do not hold the camcorder by the following parts, and also do not hold the camcorder by the jack covers.

LCD screen

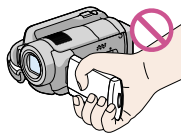

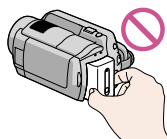

Battery pack

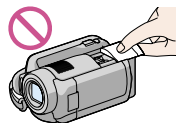

Shoe cover (HDR-XR200/XR200V)



- The camcorder is not dustproofed, dripproofed or waterproofed. See "About handling of your camcorder" (p. 127).
- Do not do any of the following when the  (Movie) or  (Photo) mode lamps (p. 21) or the ACCESS/access lamps (p. 18, 69) are lit or flashing. Otherwise, the recording media may be damaged, recorded images may be lost or other malfunctions could occur.
 - Ejecting the "Memory Stick PRO Duo" media from the camcorder
 - Removing the battery pack or AC Adaptor from the camcorder
 - Applying mechanical shock or vibration to the camcorder
- When connecting your camcorder to another device with a cable, be sure to insert the connector plug in the correct way. Pushing the plug forcibly into the terminal will damage the terminal and may result in a malfunction of your camcorder.
- Disconnect the AC Adaptor from the camcorder, holding both the camcorder and the DC plug.
- Even if the camcorder is turned off, the GPS function is working as long as the GPS switch is set to ON. Make sure that the GPS switch is set to OFF during take off and landing of an airplane (HDR-XR200V).

Menu items, LCD panel, and lens

- A menu item that is grayed out is not available under the current recording or playback conditions.
- The LCD screen are manufactured using extremely high-precision technology, so over

99.99% of the pixels are operational for effective use. However, there may be some tiny black points and/or bright points (white, red, blue, or green in color) that appear constantly in the viewfinder and on the LCD screen. These points are normal results of the manufacturing process and do not affect the recording in any way.

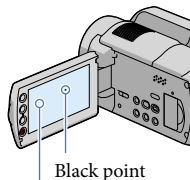

White, red, blue or green point

- Exposing the LCD screen, or the lens to direct sunlight for long periods of time may cause malfunctions.
- Do not aim at the sun. Doing so might cause your camcorder to malfunction. Take images of the sun only in low light conditions, such as at dusk.

About changing the language setting

The on-screen displays in each local language are used for illustrating the operating procedures. Change the screen language before using your camcorder if necessary (p. 22).

Recording

- Before starting to record, test the recording function to make sure that the image and sound are recorded without any problems.
- Compensation for the contents of recordings cannot be provided, even if recording or playback is not possible due to a malfunction of the camcorder, storage media, etc.
- TV color systems differ depending on the country/region. To view your recordings on a TV, you need an NTSC system-based TV.
- Television programs, films, video tapes, and other materials may be copyrighted. Unauthorized recording of such materials may be contrary to the copyright laws.

Playing back recorded images on other devices

- Your camcorder is compatible with MPEG4 AVC/H.264 High Profile for high definition

image quality (HD) recording. Therefore, you cannot play back images recorded with high definition image quality (HD) on your camcorder with the following devices;

- Other AVCHD format compatible devices which are not compatible with High Profile
- Devices which are not compatible with the AVCHD format

Discs recorded with high definition image quality (HD)

- This camcorder captures high definition footage in the AVCHD format. DVD media containing AVCHD footage should not be used with DVD based players or recorders, as the DVD player/recorder may fail to eject the media and may erase its contents without warning. DVD media containing AVCHD footage may be played on a compatible Blu-ray Disc™ player/recorder or other compatible device.

Carl Zeiss lens

Your camcorder is equipped with a Carl Zeiss lens, which was developed jointly by Carl Zeiss, in Germany, and Sony Corporation, and produces superior images. It adopts the MTF measurement system for video cameras and offers a quality typical of a Carl Zeiss lens.

For HDR-XR200/XR200V

The lens for your camcorder is T*^{*}-coated to suppress unwanted reflections and faithfully reproduce colors.

MTF= Modulation Transfer Function. The number value indicates the amount of light from a subject coming into the lens.

Notes on using the Hard Disk Drive Handycam

Save all your recorded image data

- To prevent your image data from being lost, save all your recorded images on external media periodically. It is recommended that you save the image data on a disc such as a DVD-R using your computer (see Operating Guide). Also, you can save your image data using a VCR, or a DVD/HDD recorder (p. 66).

Do not apply shock or vibration to your camcorder

- The hard disk of the camcorder may not be recognized, or recording or playback may not be possible.
- Especially, during recording/playback, do not apply shock. After recording, do not apply vibration or shock to the camcorder, while the ACCESS lamp is lit.
- When using a shoulder belt (sold separately), do not crash the camcorder against an object.
- Do not use your camcorder in very loud areas.

On the drop sensor

- To protect the internal hard disk from shock by dropping, the camcorder has a drop sensor function (p. 98). When a drop occurs, or under a non-gravity condition, the block noise made when this function is activated by the camcorder may also be recorded. If the drop sensor catches a drop repeatedly, recording/playback may be stopped.

Note on battery pack/AC Adaptor

- Be sure to remove the battery pack or the AC Adaptor after turning off the camcorder.

Note on operating temperatures

- When the temperature of the camcorder becomes extremely high or extremely low, you may not be able to record or play back on the camcorder, due to the protection features of the camcorder being activated in such situations. In this case, an indicator appears on the LCD screen (p. 112).

When the camcorder is connected to a computer

- Do not try to format the hard disk or music file storage area (HDR-XR200/XR200V) of the camcorder using a computer. If you do so, your camcorder may not operate correctly.

Note on using the camcorder at high altitudes

- Do not turn on the camcorder in a low-pressure area, where the altitude is more than 5,000 meters (16,000 feet). Doing so may damage the hard disk drive of your camcorder.

Note on disposal/transfer

- Even if you perform [MEDIA FORMAT] (p. 71) or formatting the hard disk of the camcorder, you may not delete data from the hard disk completely. When you transfer the camcorder, it is recommended that you perform [EMPTY] (p. 71) to prevent the recovery of your data. Also, when you dispose of the camcorder, it is recommended that you destroy the actual body of the camcorder.

If you cannot record/play back images, perform [MEDIA FORMAT]

- If you repeat recording/deleting images for a long time, fragmentation of data occurs on the recording media. Images cannot be saved or recorded. In such a case, save your images on some type of external media first (p. 66, see Operating Guide too), and then perform [MEDIA FORMAT] (p. 71).

Step 1: Charging the battery pack

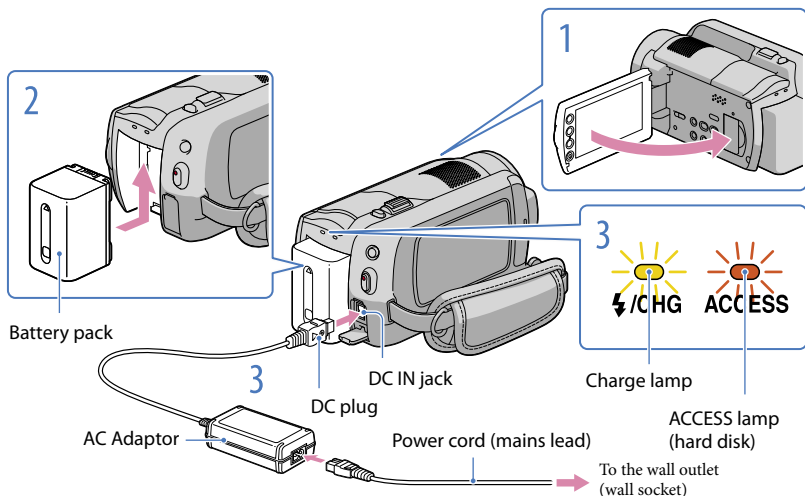

You can charge the “InfoLITHIUM” battery pack (H series) after attaching it to your camcorder.

- You cannot attach any “InfoLITHIUM” battery pack other than the H series to your camcorder.

- 1 Turn off your camcorder by closing the LCD screen.
- 2 Attach the battery pack by sliding it in the direction of the arrow until it clicks.
- 3 Connect the AC Adaptor and the power cord (mains lead) to your camcorder and the wall outlet (wall socket).
 - Be sure that the ▲ mark on the DC plug is facing the right.
 The charge lamp lights up and charging starts. The charge lamp turns off when the battery pack is fully charged.
- 4 When the battery is charged, disconnect the AC Adaptor from the DC IN jack of your camcorder.

- See page 116 on recording and playing time.

- When your camcorder is on, you can check the approximate amount of remaining battery power with the remaining battery indicator at the upper left on the LCD screen.

Charging time

Approximate time (min.) required when you fully charge a fully discharged battery pack.

Battery pack	Charging time
NP-FH50	135
NP-FH60 (supplied)	135
NP-FH70	170
NP-FH100	390

- Time measured with the camcorder at 25 °C (77 °F). 10 °C to 30 °C (50 °F to 86 °F) is recommended.

To remove the battery pack

Close the LCD screen. Slide the BATT (battery) release lever ① and remove the battery pack ②.

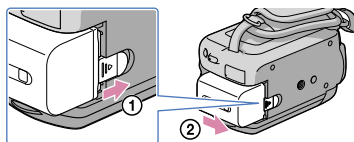

To use a wall outlet (wall socket) as a power source

Make the same connections as “Step 1: Charging the battery pack.” Even if the battery pack is attached, the battery pack is not discharged.

Charging the battery pack abroad

You can charge the battery pack in any countries/regions using the AC Adaptor supplied with your camcorder within the AC 100 V - 240 V, 50 Hz/60 Hz range.

- Do not use an electronic voltage transformer.

Notes on the battery pack

- When you remove the battery pack or disconnect the AC Adaptor, close the LCD screen and make sure that the (Movie) lamp/ (Photo) lamp (p. 21)/ACCESS lamp (p. 18)/access lamp (p. 69) are turned off.
- The charge lamp flashes during charging under the following conditions:
 - The battery pack is not attached correctly.
 - The battery pack is damaged.
- When attaching a video light (sold separately), it is recommended that you use an NP-FH70 or NP-FH100 battery pack (HDR-XR200/XR200V).
- We do not recommend using an NP-FH30, which only allows short recording and playback times, with your camcorder.
- Even if your camcorder is turned off, AC power source (mains) is still supplied to it while connected to the wall outlet (wall socket) via the AC Adaptor.
- In the default setting, the power turns off automatically if you leave your camcorder without any operation for about 5 minutes, to save battery power ([A.SHUT OFF]).

Notes on the AC Adaptor

- Use the nearby wall outlet (wall socket) when using the AC Adaptor. Disconnect the AC Adaptor from the wall outlet (wall socket) immediately if any malfunction occurs while using your camcorder.
- Do not use the AC Adaptor placed in a narrow space, such as between a wall and furniture.
- Do not short-circuit the DC plug of the AC Adaptor or battery terminal with any metallic objects. This may cause a malfunction.

Step 2: Turning the power on, and setting the date and time

1 Open the LCD screen of your camcorder.

Your camcorder is turned on.

- To turn on your camcorder when the LCD screen is open, press POWER.

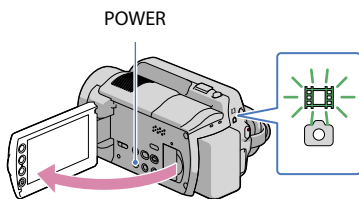

- (Movie): To record movies
- (Photo): To record photos

2 Select the desired geographical area with $\blacktriangle/\blacktriangledown$, then touch [NEXT].

Touch the button on the LCD screen.

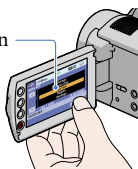

- To set the date and time again, touch \blacktriangle (HOME) \rightarrow (SETTINGS) \rightarrow [CLOCK/ LANG] \rightarrow [CLOCK SET]. When an item is not on the screen, touch $\blacktriangle/\blacktriangledown$ until the item appears.

3 Set [DST SET] or [SUMMERTIME], date and time, then touch $\text{OK} \rightarrow \text{OK} \rightarrow \text{OK} \rightarrow \text{X}$.

The clock starts.

- If you set [DST SET] or [SUMMERTIME] to [ON], the clock advances 1 hour.

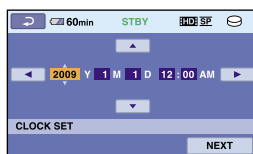

- The date and time do not appear during recording, but they are automatically recorded on the recording media, and can be displayed during playback. To display the date and time, touch \blacktriangle (HOME) \rightarrow (SETTINGS) \rightarrow [VIEW IMAGES SET] \rightarrow [DATA CODE] \rightarrow [DATE/TIME] \rightarrow OK \rightarrow OK \rightarrow X .
- You can turn off the operation beeps by touching \blacktriangle (HOME) \rightarrow (SETTINGS) \rightarrow [SOUND/DISP SET] \rightarrow [BEEP] \rightarrow [OFF] \rightarrow OK \rightarrow OK \rightarrow X .

- If the button you touch does not react correctly, calibrate the touch panel (p. 128).
- Once the clock is set, the clock time is automatically adjusted with [AUTO CLOCK ADJ] and [AUTO AREA ADJ] set to [ON] (p. 94). The clock may not be adjusted to the correct time automatically, depending on the country/region selected for your camcorder. In this case, set [AUTO CLOCK ADJ] and [AUTO AREA ADJ] to [OFF] (HDR-XR200V).

To turn off the power



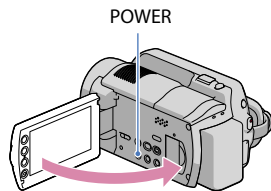



Close the LCD screen. The  (Movie) lamp flashes for a few seconds, and the power is turned off.



- You can turn off your camcorder also by pressing POWER.
- When [POWER ON BY LCD] (p. 97) is set to [OFF], turn off your camcorder by pressing POWER.

Changing the language setting

You can change the on-screen displays to show messages in a specified language.

Touch  (HOME) →  (SETTINGS) → [CLOCK/ LANG] → [ LANGUAGE SET]
→ a desired language →  →  → .



Five pieces of advice for successful recording



★ Stabilizing your camcorder

When you hold the camcorder, keep your upper body upright, and hold your arms close to your body.

The SteadyShot function is effective against camera-shake, however, it is essential that you not move the camcorder.

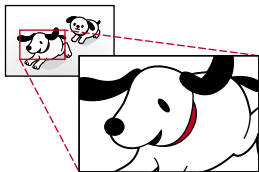

★ Zooming smoothly

Zoom in and out slowly and smoothly. And, use zooming sparingly. Excessive zooming will make movies that may make the viewer feel tired when viewing them.

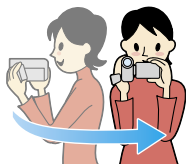

★ Evoking a feeling of spaciousness

Use the panning technique. Stabilize yourself, move your camcorder horizontally as you turn your upper body slowly. Stay still at the end of panning for a while to make the scene look stable.



★ Accentuating movies with narration

Consider the sound to be recorded with your movies. Narrate the subject, or talk to the subject during shooting.

Aim for a balanced volume of voices, since the recording person is closer to the microphone than the recorded person.



★ Using accessories

Make good use of camcorder accessories.

For example, using a tripod, you can make a time-lapse recording or record subjects in dim light, such as scenes of fireworks, or night views. By always carrying spare batteries, you can continue recording without worrying about battery power shortages.

Recording and playing movies and photos easily (**EASY** Easy Handycam Operation)

Simply press EASY. You can record or play movies and photos easily (Easy Handycam operation).

During Easy Handycam operation, you can set basic options, such as changing the image size or deleting images, among the setting and adjustment items. Other items are set automatically.

- When Easy Handycam operation is started, nearly all menu settings are reset to the default settings automatically. (Some menu items retain the settings that were made before Easy Handycam operation.)

Recording movies

In the default setting, movies are recorded with high definition image quality (HD) on the hard disk (p. 69, 73).

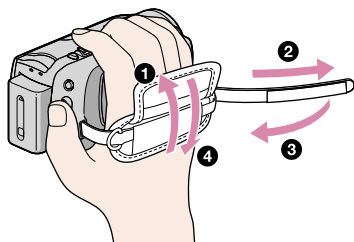

- 1 Fasten the grip belt.

- 2 Open the LCD screen of your camcorder.

Your camcorder is turned on.

- To turn on your camcorder when the LCD screen is already open, press POWER (p. 21).

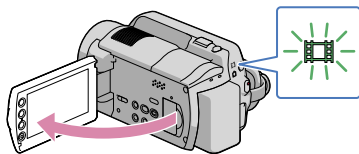

For HDR-XR100/XR101

Open the lens cover.

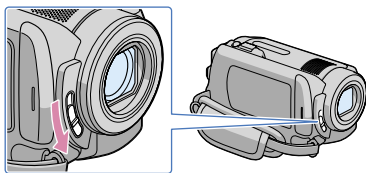

3 Press EASY.

EASY appears on the LCD screen.

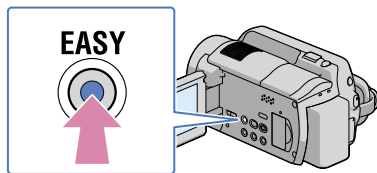

4 Press START/STOP to start recording.

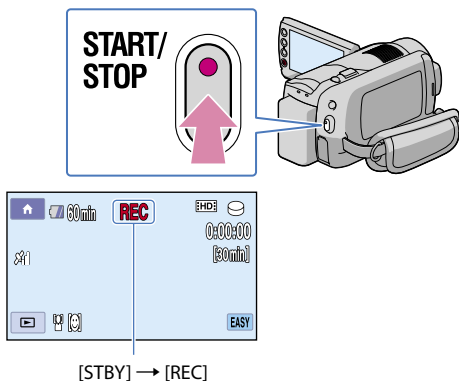

To stop recording, press START/STOP again.

Tips

- The [REC MODE] is fixed to [HD SP] or [SD SP] (p. 73).

1 Open the LCD screen of your camcorder.

Your camcorder is turned on.

- To turn on your camcorder when the LCD screen is already open, press POWER (p. 21).

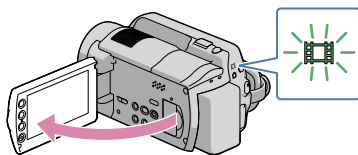

For HDR-XR100/XR101

Open the lens cover.

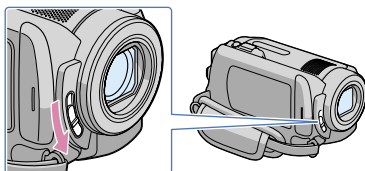

2 Press EASY.

EASY appears on the LCD screen.

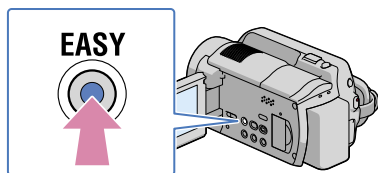

3 Press MODE to turn on the (Photo) lamp.

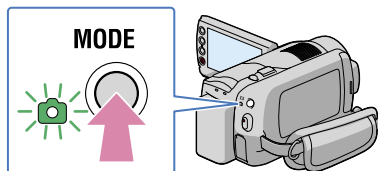

- 4 Press PHOTO lightly to adjust the focus, then press it fully.

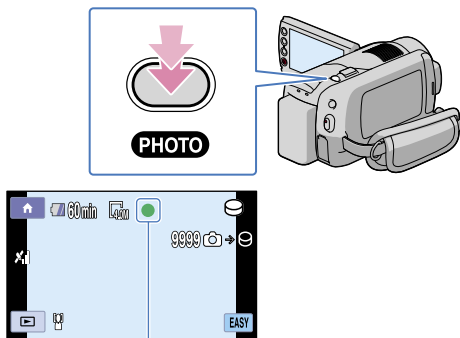

Flashes → Lights up

When  disappears, the photo is recorded on the internal hard disk.

Playing movies

- 1 Open the LCD screen of your camcorder.

Your camcorder is turned on.

- To turn on your camcorder when the LCD screen is already open, press POWER (p. 21).

- 2 Press  (VIEW IMAGES).

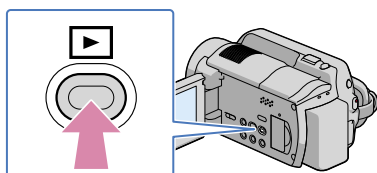

The VISUAL INDEX screen appears after some seconds.

- 3 Touch the **[HD]** (or **[SD]**) tab (①) → a desired movie (②).

HDR-XR100/XR101

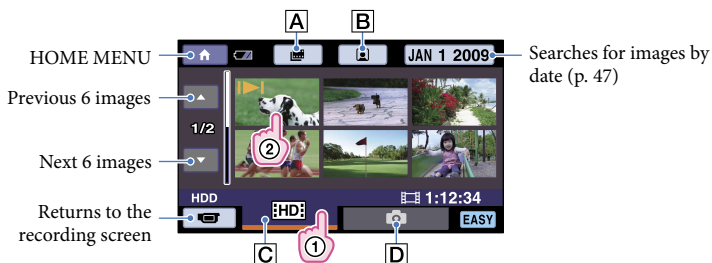

[A] : Displays the Film Roll Index screen (p. 44).

[B] : Displays the Face Index screen (p. 45).

[C] **[HD]** : Displays high definition image quality (HD) movies.*

[D] : Displays photos.

* **[SD]** appears when you select standard definition image quality (SD) movies in **[HD]/[SD]SET** (p. 86).

- appears with the movie or photo that was most recently played or recorded. If you touch the movie or photo with , you can continue playback from the previous time. (appears on the photo recorded on "Memory Stick PRO Duo" media.)

HDR-XR200/XR200V

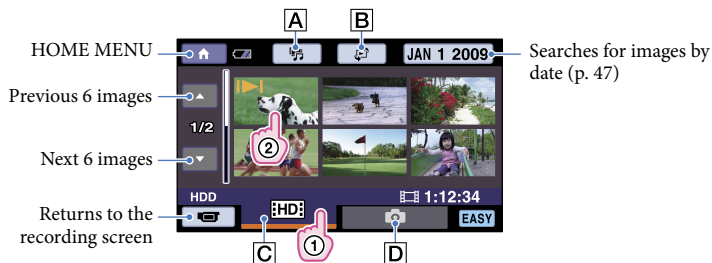

[A] : Displays the Highlight Playback screen (p. 46).

[B] : Displays the screen to select the index type (**[MAP]** (HDR-XR200V)/**[FILM ROLL]**/**[FACE]**) (p. 43, 44, 45).

[C] **[HD]** : Displays high definition image quality (HD) movies.*

[D] : Displays photos.

* **[SD]** appears when you select standard definition image quality (SD) movies in **[HD]/[SD]SET** (p. 86).

- appears with the movie or photo that was most recently played or recorded. If you touch the

movie or photo with **▶**, you can continue playback from the previous time. (**▶** appears on the photo recorded on "Memory Stick PRO Duo" media.)

Your camcorder starts playing the selected movie.

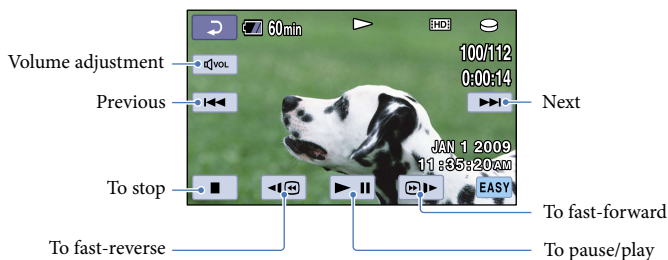

Tips

- When playback from the selected movie reaches the last movie, the screen returns to the VISUAL INDEX screen.
- You can slow down the playback speed by touching **◀|Ⓜ|▶** during pause.
- You can adjust the volume by touching **ⓂVOL** → adjust with **◀-|/|+▶** → **▶** during playback.
- The setting of [DATA CODE] is fixed to [DATE/TIME] (p. 86).
- To change the recording media, select the recording media on [MOVIE MEDIA SET] (p. 69).
- Protected demonstration movie has been provided on your camcorder when you buy it.

Viewing photos

On the VISUAL INDEX screen, touch the **📷** (Photo) tab (①) → a desired photo (②).

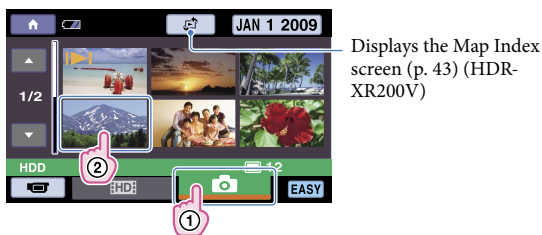

Your camcorder starts playing the selected photo.

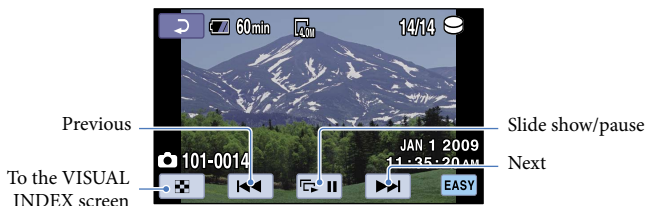

Tips

- The setting of [DATA CODE] is fixed to [DATE/TIME] (p. 86).
- To change the recording media, select the recording media on [PHOTO MEDIA SET] (p. 69).

To cancel Easy Handycam operation

After you finish recording, or close menu setting screen, press EASY again. **EASY** disappears from the LCD screen.

Menu settings during Easy Handycam operation

Press (HOME) to display the menu items available for setup changes. See “Menu lists” (p. 13) on the available menu items.

Notes

- You cannot use the OPTION MENU.
- Cancel Easy Handycam operation if you want to add effects to images or change settings.

Invalid buttons during Easy Handycam operation

You cannot use some buttons/functions during Easy Handycam operation since they are automatically set. If you set an invalid operation, [Invalid during Easy Handycam operation.] may appear.

Recording

Recording movies

In the default setting, movies are recorded with high definition image quality (HD) on the internal hard disk (p. 69, 73).

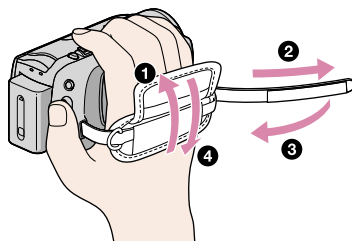

1 Fasten the grip belt.

2 Open the LCD screen of your camcorder.

Your camcorder is turned on.

- To turn on your camcorder when the LCD screen is already open, press POWER (p. 21).

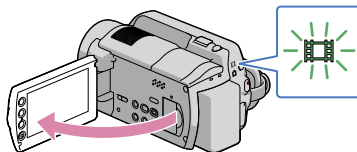

For HDR-XR100/XR101

Open the lens cover.

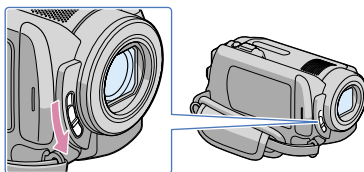

3 Press START/STOP to start recording.

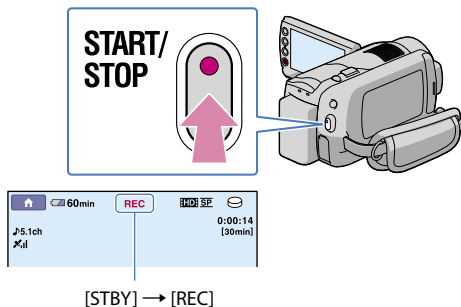

To stop recording, press START/STOP again.

- See page 117 on the recordable time of movies.
- The maximum continuous recordable time of movies is about 13 hours.
- When a movie file exceeds 2 GB, the next movie file is created automatically.
- You can change the recording media and image quality (p. 69, 73).
- [STEADYSHOT] is set as follows in the default setting.
HDR-XR100/XR101: [ON]
HDR-XR200/XR200V: [ACTIVE]
- It will take several seconds until you can start recording after you turn on the camcorder. You cannot operate your camcorder during this time.
- If you close the LCD screen while recording movies, the camcorder stops recording.
- If the ACCESS/access lamp is lit or flashing after recording is finished, it means that data is still being written onto the recording media. Do not apply shock or vibration to your camcorder, and do not remove the battery or AC Adaptor.
- You can check the recordable time and the remaining capacity, etc., by touching (HOME) → (MANAGE MEDIA) → [MEDIA INFO] (p. 71).
- To adjust the angle of the LCD panel, first open the LCD panel 90 degrees to the camcorder (①), and then adjust the angle (②). If you rotate the LCD panel 180 degrees to the lens side (②), you can record movies/photos in mirror mode.

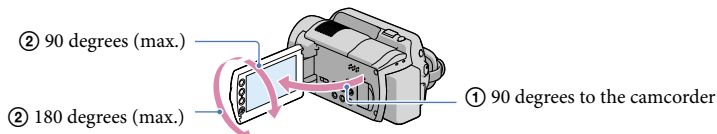

- When you open or close the LCD screen, or adjust the angle, be careful not to press the buttons on the side of the LCD screen by mistake.

Tips

- You can record photos during movie recording by pressing PHOTO ([Dual Rec], p. 36).
- When a face is detected, a white frame appears and the image quality around the face is optimized automatically ([FACE DET. SETTING], p. 84).

- In the default setting, a photo is recorded automatically when the camcorder detects the smile of a person during movie recording ([SMILE SHUTTER], p. 85). An orange frame appears around a face targeted for possible smile detection shot.
- You can capture photos from recorded movies (p. 59).
- You can switch the shooting mode by touching **HOME** → **CAMERA** → [MOVIE].

Data code during recording

The recording date, time and condition are recorded automatically on the recording media. They are not displayed during recording. However, you can check them as [DATA CODE] during playback (p. 86).

Shooting photos

In the default setting, photos are recorded on the internal hard disk (p. 69).

1 Open the LCD screen of your camcorder.

Your camcorder is turned on.

- To turn on your camcorder when the LCD screen is already open, press **POWER** (p. 21).

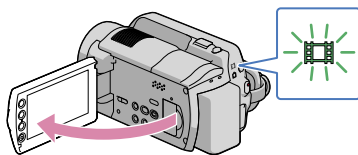

For HDR-XR100/XR101

Open the lens cover.

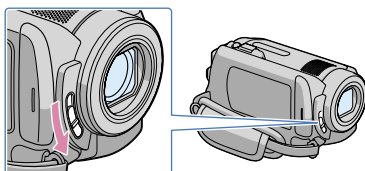



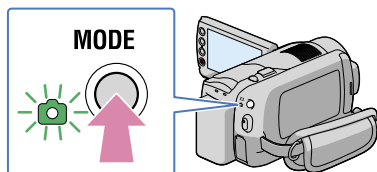

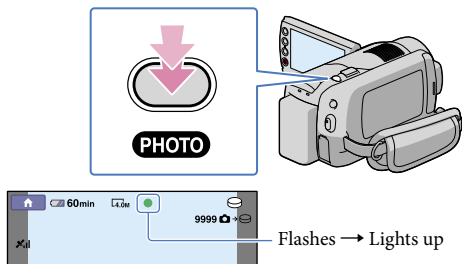

2 Press **MODE** to turn on the **Photo** lamp.



3 Press PHOTO lightly to adjust the focus, then press it fully.



When  disappears, the photo is recorded.

- See page 118 on the recordable number of photos.
- To change the image size, touch  (HOME) →  (SETTINGS) → [PHOTO SETTINGS] → [IMAGE SIZE] → a desired setting →  →  →  (p. 80).
- You can record photos during movie recording by pressing PHOTO ([Dual Rec], p. 36).
- Your camcorder flashes automatically when there is insufficient ambient light. The flash does not work during movie recording. You can change how your camcorder flashes by [FLASH MODE] (p. 82) (HDR-XR200/XR200V).
- You cannot record photos while  is displayed.

Useful functions for recording movies and photos

Zooming

You can magnify images with the power zoom lever or the zoom buttons on the LCD frame.

The magnifying level of your camcorder is as follows:

HDR-XR100/XR101: 10 times the original size

HDR-XR200/XR200V: 15 times the original size

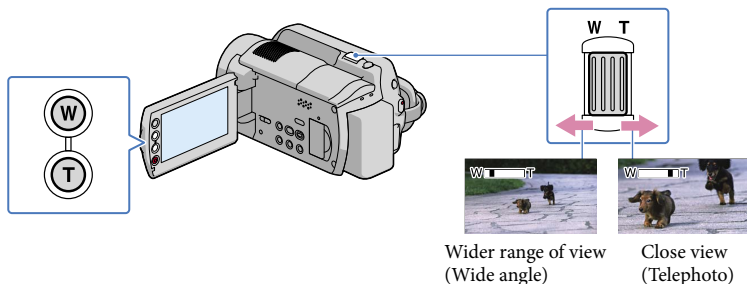

Move the power zoom lever slightly for a slower zoom. Move it further for a faster zoom.

Notes

- Be sure to keep your finger on the power zoom lever. If you move your finger off the power zoom lever, the operation sound of the power zoom lever may also be recorded.
- You cannot change the zoom speed with the zoom buttons on the LCD frame.
- The minimum possible distance between camcorder and subject while maintaining sharp focus is about 1 cm (about 13/32 in.) for wide angle and about 80 cm (about 2 5/8 feet) for telephoto.

Tips

- You can set [DIGITAL ZOOM] (p. 75) if you want to zoom to a greater level.

Recording sound with more presence (5.1ch surround recording)

Dolby Digital 5.1ch surround sound can be recorded with the built-in microphone. You can enjoy realistic sound when playing the movie on devices that support 5.1ch surround sound.



Built-in microphone

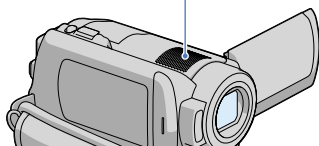

⚡ Notes

- If you play back 5.1ch sound on your camcorder, 5.1ch sound is automatically converted and output in 2ch.
- To enjoy the 5.1ch surround sound of the movies recorded with high definition image quality (HD) in 5.1ch sound, you need an AVCHD format device compatible with 5.1ch surround.
- When you connect your camcorder with an HDMI cable (sold separately), the sound of high definition image quality (HD) movies recorded in 5.1ch sound is automatically output in 5.1ch sound. The sound of standard definition image quality (SD) movies is converted to 2ch.

💡 Tips

- You can select the recording sound from [5.1ch SURROUND] (🔊5.1ch) or [2ch STEREO] (🔊2ch) ([AUDIO MODE], p. 74).
- You can create a disc, which contains the movies recorded on your camcorder, on a computer using the supplied software. If you play the disc on a 5.1ch surround system, you can enjoy realistic sound.

Recording high quality photos during movie recording (Dual Rec)

You can record high quality photos during movie recording by pressing PHOTO.

⚡ Notes

- You cannot use the flash during movie recording (HDR-XR200/XR200V).
- 📷 may appear when the capacity of the recording media is not enough or when you record photos continuously. You cannot record photos while 📷 is displayed.

💡 Tips

- When the MODE lamp is set to 🎬 (Movie), the size of photos becomes as follows:
HDR-XR100/XR101: [📷 2.3M] (16:9 wide) or [1.7M] (4:3)
HDR-XR200/XR200V: [📷 3.0M] (16:9 wide) or [2.2M] (4:3)
- You can record photos during recording standby in the same way as when the 📷 (Photo) lamp is turned on.

Recording in dark places (NightShot) (HDR-XR200/XR200V)

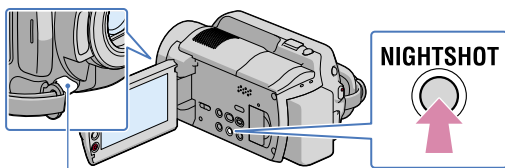

Infrared port

When you press NIGHTSHOT, 📷 appears. You can record images in dark places.

⚡ Notes

- The NightShot function uses infrared light. Therefore, do not cover the infrared port with your fingers or other objects.
- Remove the conversion lens (sold separately).
- Adjust the focus manually ([FOCUS], p. 101) when it is hard to focus automatically.
- Do not use the NightShot function in bright places. This may cause a malfunction.

Recording in mirror mode

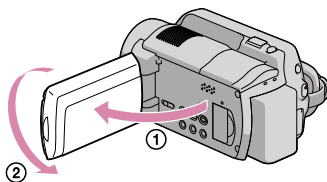

Open the LCD panel 90 degrees to the camcorder ①, then rotate it 180 degrees to the lens side ②.

Tips

- A mirror-image of the subject appears on the LCD screen, but the image will be normal when recorded.

Recording fast action in slow-motion (SMTH SLW REC)

Fast moving subjects and actions, which cannot be captured under the ordinary shooting conditions, can be shot in smooth moving slow-motion for about 3 seconds. This is useful to shoot fast actions such as a golf or tennis swing.

- 1 Touch **HOME** → **CAMERA** → [SMTH SLW REC].

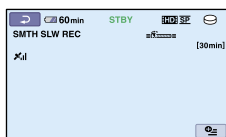

- 2 Press **START/STOP**.

An about-3-second movie is recorded as a 12-second-slow-motion movie.
[Recording...] disappears, when recording is finished.

Touch **STOP** to cancel the smooth slow recording.

To change the setting

Touch **OPTION** → **OPTION** tab, then select the setting you want to change.

[TIMING]

Select the recording start point after START/STOP is pressed. The default setting is [3sec AFTER].

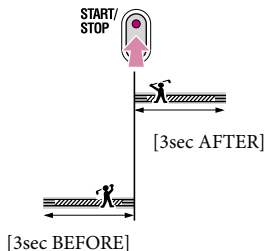



⚡ Notes

- You cannot record sound with [SMTH SLW REC].
- Image quality of [SMTH SLW REC] is not as good as that of normal recording.

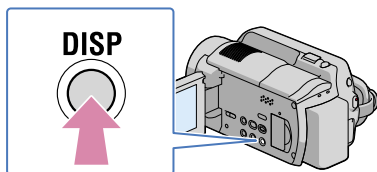
Switching the screen display, or turning the LCD backlight on/off



Each time you press DISP, the screen indicators, such as remaining battery power, etc., turn on or off.

To turn off the LCD backlight, press and hold DISP down for a few seconds until  appears. This setting is practical when you use your camcorder in bright conditions or you want to save battery power. The recorded image will not be affected by the setting. To turn on the LCD backlight, press and hold DISP down for a few seconds until  disappears.

Acquiring location information (GPS) (HDR-XR200V)

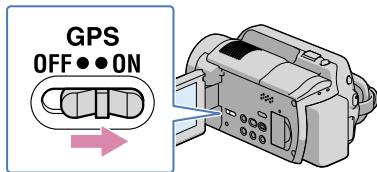

Set the GPS switch to ON ( appears on the LCD screen). Your camcorder starts trying to triangulate. When your camcorder triangulates successfully, it will record the location information at the time movies and photos were recorded.

The movies and photos with location information will appear on a map (p. 43), so that you





can remember where you recorded those movies and photos.

In addition, you can acquire your current location information to check where you are at the moment (p. 58).

- Using the supplied software, “PMB,” you can display the movies and photos where you recorded them on a map. For details, see page 43.

Notes

- The indicator changes according to the strength of GPS signal reception.

Triangulating status	GPS indicators	GPS reception status
Function off	No indicator	The GPS switch is set to OFF, or the GPS receiver is not functioning normally.
Difficult		Your camcorder cannot find a GPS signal, therefore, it cannot triangulate. Use your camcorder in an open area.
Processing		Your camcorder is confirming the GPS signal, and will be able to acquire location information soon. Wait until your camcorder completes the triangulation.
Triangulating		Your camcorder is receiving a GPS signal, and can acquire location information.
Triangulating		Your camcorder is receiving a strong GPS signal, and can acquire location information.

- The GPS switch is set to ON in the default setting. Movies and photos recorded during triangulation by GPS will be recorded with location information. If you do not want to record location information, set the GPS switch to OFF.
- It may take from several seconds to several minutes to acquire the location information when you use the GPS for the first time or use it again after long intervals.
- Even if the camcorder is turned off, the GPS function is working as long as the GPS switch is set to ON. Make sure that the GPS switch is set to OFF during take off and landing of an airplane.
- You may not be able to acquire location information depending on the strength of GPS reception.

Tips

- You can search for movies and photos to be played on the Map Index (p. 43).
- When you play movies and photos with [DATA CODE] set to [COORDINATES], the location information appears on the LCD screen (p. 86).
- You can use [AUTO CLOCK ADJ] and [AUTO AREA ADJ] to adjust the clock and the area.

Playback on the camcorder

In the default setting, movies and photos that are recorded on the internal hard disk are played (p. 69).

Playing movies

1 Open the LCD screen of your camcorder.

Your camcorder is turned on.

- To turn on your camcorder when the LCD screen is already open, press POWER (p. 21).

2 Press (VIEW IMAGES).

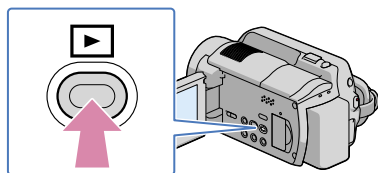

The VISUAL INDEX screen appears after some seconds.

- You can display the VISUAL INDEX screen by pressing  (VIEW IMAGES) on the LCD screen as well.

3 Touch (or) tab (①) → a desired movie (②).

HDR-XR100/XR101

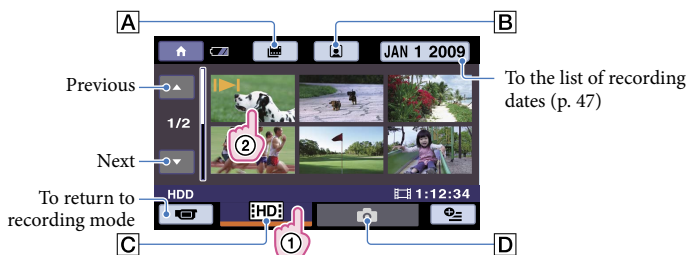



A  : Displays the Film Roll Index screen (p. 44).

B  : Displays the Face Index screen (p. 45).

C  : Displays high definition image quality (HD) movies*.

D  : Displays photos.

*  appears when the standard definition image quality (SD) movie is selected with [/  SET] (p. 86).

- ▶ appears with the movie or photo that was most recently played or recorded. If you touch the movie or photo with ▶, you can continue playback from the previous time. (▶ appears on the photo recorded on “Memory Stick PRO Duo” media.)

HDR-XR200/XR200V

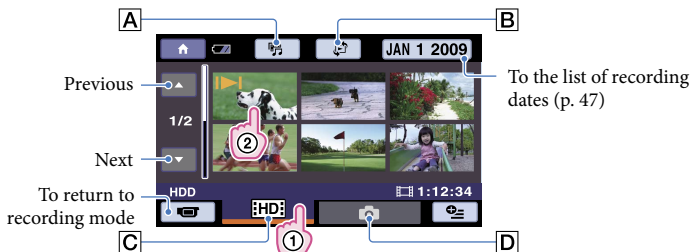

A : Displays the Highlight Playback screen (p. 46).

B : Displays the screen to select the index type ([JMAP] (HDR-XR200V)/ [FILM ROLL]/[FACE]) (p. 43, 44, 45).

C : Displays high definition image quality (HD) movies*.

D : Displays photos.

* appears when the standard definition image quality (SD) movie is selected with [HDD]/ [SD] SET] (p. 86).

- ▶ appears with the movie or photo that was most recently played or recorded. If you touch the movie or photo with ▶, you can continue playback from the previous time. (▶ appears on the photo recorded on “Memory Stick PRO Duo” media.)

Your camcorder starts playing the selected movie.

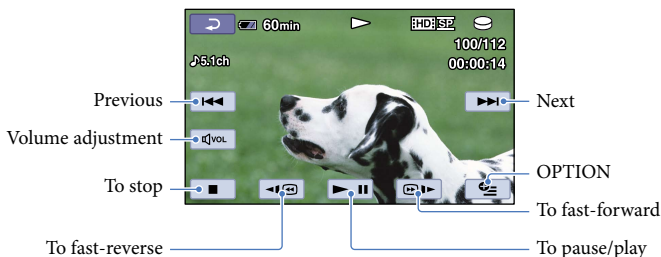

Tips

- When playback from the selected movie reaches the last movie, the screen returns to the VISUAL INDEX screen.

- Touch during pause to play back movies slowly.
- As you repeat touching during playback, movies are played as fast as about 5 times → about 10 times → about 30 times → about 60 times.
- You can display the VISUAL INDEX by touching (HOME) → (VIEW IMAGES) → [VISUAL INDEX].
- The recording date, time, and shooting conditions are recorded automatically during recording. This information is not displayed during recording, but you can display it during playback by touching (HOME) → (SETTINGS) → [VIEW IMAGES SET] → [DATA CODE] → a desired setting → → .
- Protected demonstration movie has been provided on your camcorder when you buy it.

To adjust the sound volume of movies

While playing back movies, touch → adjust with / → .

- You can adjust the sound volume from the OPTION MENU.

Viewing photos

Touch (Photo) tab → a desired photo on the VISUAL INDEX screen.

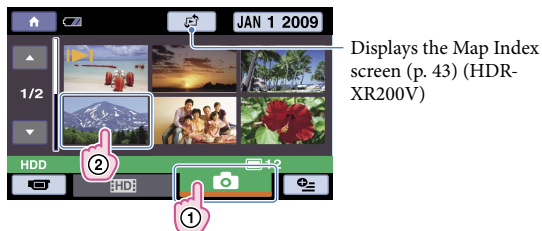

Your camcorder displays the selected photo.

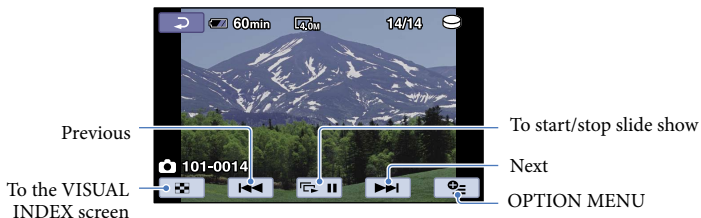

Tips

- When viewing photos recorded on "Memory Stick PRO Duo" media, (playback folder) appears on the screen.

Useful functions for playing movies and photos

Searching for a desired scene by recording location (Map Index) (HDR-XR200V)

Where movies and photos were recorded is marked on a map. You can select a movie or photo by recording location. Select the recording media which contains the movie or photo you want to play back before starting this operation (p. 69).

- You can use the Map Index only with movies and photos having location information that was recorded with the GPS switch set to ON (p. 38).
- You cannot use the Map Index with photos recorded on “Memory Stick PRO Duo” media.

1 Press (VIEW IMAGES).

The VISUAL INDEX screen appears.

2 Touch (VIEW IMAGES) → .

Returns to the VISUAL INDEX screen

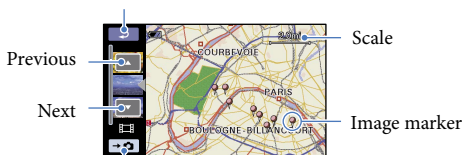

Displays photos

- You can change the scale using the zoom lever or zoom buttons (W: larger, T: smaller).
- The point you touch on the map scrolls to the center automatically. If you hold a certain point, the map keeps scrolling.
-  will appear at the upper right corner of the thumbnail of the movie or photo without location information.

3 Touch the image marker where you recorded the movies and photos to be played back.



The image marker turns red. The movies or photos recorded at that location are displayed on the left of the screen.

4 Touch the desired movie or photo.

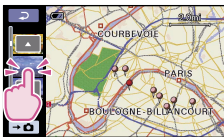

Playback starts from the selected scene.

⚡ Notes

- Make sure that you set the GPS switch to ON prior to recording, to be able to create movies and photos that you can search for on the Map Index (p. 38).
- The map always displays the north at the top.
- When you record several movies and photos at the same location, the movie or photo recorded most recently will be displayed on the LCD screen.
- You can also display the Map Index screen by touching (HOME) → (VIEW IMAGES) → [MAP].
- You can also search for the thumbnail of the movie or photo you want to play by touching in step 3. The recording location of the movie or photo will be displayed at the center of the map.

Searching for desired scene by pinpoint (Film Roll Index)

Movies can be divided by a set time and the first scene of each division is displayed on the index screen. You can start playing back a movie from the selected thumbnail. Select the recording media which contains the movie you want to play back before the operation (p. 69).

1 Press (VIEW IMAGES).

The VISUAL INDEX screen appears.

2 HDR-XR100/XR101: Touch (Film Roll Index).

HDR-XR200/XR200V: Touch (VIEW IMAGES) → [FILM ROLL].

Returns to the VISUAL INDEX screen

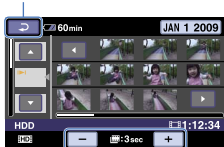

Sets the interval at which to create thumbnails of scenes in a movie.

3 Touch / to select the desired movie.

4 Touch / to search for the desired scene, then touch the scene you want to play back.

Playback starts from the selected scene.

Tips

- You can also display the [Film Roll Index] screen by touching (HOME) → (VIEW IMAGES) → [FILM ROLL].

Searching for desired scene by face (Face Index)

The face images detected during movie recording are displayed on the index screen.

You can play back the movie from the selected face image.

Select the recording media which contains the movie you want to play back before the operation (p. 69).

1 Press (VIEW IMAGES).

The VISUAL INDEX screen appears.

2 HDR-XR100/XR101: Touch (Face Index).

HDR-XR200/XR200V: Touch (VIEW IMAGES) → [FACE].

Returns to the VISUAL INDEX screen



3 Touch / to select the desired movie.



4 Touch / to search for the desired face image, then touch the desired face image to view the scene.

Playback starts from the beginning of the scene with the selected face image.

⚡ Notes

- Faces may not be detected depending on recording conditions.
Example: People wearing glasses or hats, or who do not face towards the camera.
- Make sure that you set [FACE DETECTION] to [ON] (the default setting) prior to recording, to search movies on the Face Index (p. 84).

💡 Tips

- You can also display the [Face Index] screen by touching  (HOME) →  (VIEW IMAGES) →  [FACE].

Playing back a digest of your movies (HIGHLIGHT PLAYBACK) (HDR-XR200/ XR200V)

Your camcorder selects a number of short scenes at random, puts them together, and plays them back as a digest of your high definition image quality (HD) movies with music and visual effects. You cannot record a scene and specify it as a highlight scene. Scenes selected for Highlight Playback differ each time Highlight Playback is selected.

Select the recording media which contains the movie you want to play back before you start the operation (p. 69).

1 Press (VIEW IMAGES).

The VISUAL INDEX screen appears.

2 Touch (HIGHLIGHT PLAYBACK).

The settings for Highlight Playback appear. The Highlight Playback starts after several seconds.

Returns to the VISUAL INDEX screen



To stop Highlight Playback

To pause, touch .

To stop, touch  or .

To change the settings for Highlight Playback

After touching  in step 2, touch [HIGHLIGHT SET] before the Highlight Playback starts. You can set following items.





- [PLAYBACK RANGE]

Set the range of movies to be played by selecting the from and to date, then touch .

If no range is set, your camcorder plays the movies starting from those of the date displayed on the VISUAL INDEX screen until the most recently recorded movie.

- [THEME]
Select one of the following: [SIMPLE], [NOSTALGIC], [STYLISH], [ACTIVE] (the default setting)
The music category is selected automatically according to the theme.
- [MUSIC]
From the music category, you can select one of the following: [MUSIC1], [MUSIC2], [MUSIC3], [MUSIC4] (the default setting), [ORIGINAL SOUND]
- [SHUFFLE]
To play back movies in random order, select [ON].

To change music files

- You can transfer music files from audio CDs or MP3 files to your camcorder, and play them with Highlight Playback. To transfer music files, you need to install the software from the supplied CD-ROM on your computer. Turn on your camcorder and computer, connect them with the supplied USB cable, then touch [DOWNLOAD MUSIC] on the camcorder screen. (If the [USB CONNECT] screen does not appear, touch  (HOME) →  (OTHERS) → [USB CONNECT]). For details, see the “PMB Guide.”
- After the music file is transferred to the camcorder, if you cannot play the music, the music file may be damaged. Delete the music file by touching  (HOME) →  (OTHERS) → [MUSIC TOOL] → [EMPTY MUSIC], then transfer the music file again. If you delete music files using [EMPTY MUSIC], the music data recorded on your camcorder at the factory will be deleted too. In this case, you can restore them using Music Transfer supplied with PMB. Refer to the PMB Guide for details.

Notes

- The [PLAYBACK RANGE] setting is cleared when the Highlight Playback stops.
- You cannot save scenes selected for HIGHLIGHT PLAYBACK.

Tips

- You can change the settings for Highlight Playback during Highlight Playback by touching  (OPTION).
- If you change the settings for Highlight Playback, Highlight Playback scenes are re-selected.
- If you change [MUSIC] after you select [THEME], the music will be selected automatically for the theme from next time.

Searching for desired images by date (Date Index)

You can search for desired images by date efficiently.

Select the recording media which contains the image you want to play back before the operation (p. 69).

Notes

- You cannot use the Date Index function for photos on “Memory Stick PRO Duo” media.

1 Press (VIEW IMAGES).

The VISUAL INDEX screen appears.

2 To search for movies, touch the or tab. To search for photos, touch the tab.

3 Touch date on the screen.

The recording dates of images are displayed on the screen.

Returns to the VISUAL INDEX screen



4 Touch ▲/▼ to select the date of the desired image, then touch [OK].

The images of the selected date are displayed on the VISUAL INDEX screen.

Tips

- On the [Film Roll Index]/[Face Index] screen, you can use the Date Index function by following the steps 3 to 4.

Using PB zoom with photos

You can magnify photos from about 1.1 to 5 times the original size.

Magnification can be adjusted with the power zoom lever or the zoom buttons on the LCD frame.

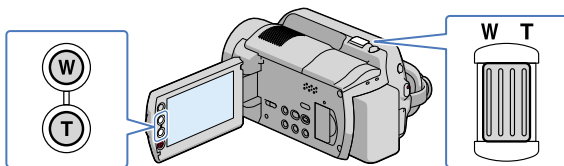

1 Play back the photo you want to magnify.

2 Magnify the photo with T (Telephoto).

The screen is framed.

3 Touch the screen at the point you want to display in the center of the displayed frame.

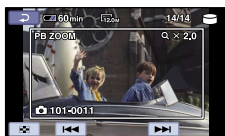

4 Adjust the magnification with W (Wide angle)/T (Telephoto).

To cancel, touch .

Playing back a series of photos (Slide show)

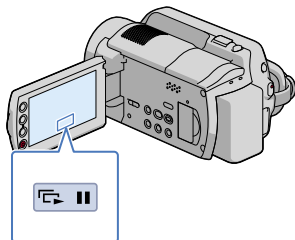

Touch  on the photo playback screen.

The slide show begins from the selected photo.

To stop the slide show

Touch .





To restart the slide show

Touch  again.

Notes

- You cannot operate playback zoom during slide show.

Tips

- You can also play back the slide show by touching  (OPTION) →  tab → [SLIDE SHOW] on the VISUAL INDEX screen.
- You can set continuous slide show playback by selecting  (OPTION) →  tab → [SLIDE SHOW SET] while playing photos. The default setting is [ON] (continuous playback).

Playing images on a TV



Connection methods and the image quality (high definition (HD) or standard definition (SD)) viewed on the TV screen differ depending on what type of TV is connected, and the connectors used. You can connect your camcorder to the TV easily following the instructions displayed on the LCD screen, [TV CONNECT Guide].

Connecting a TV using [TV CONNECT Guide]

1 Switch the input on the TV to the connected jack.

Refer to the instruction manuals of the TV.

2 Turn on your camcorder, and touch (HOME) → (OTHERS) → [TV CONNECT Guide] on the LCD screen.

- When an item is not on the screen, touch  /  until the item appears.
- Use the supplied AC Adaptor as the power source (p. 19).

3 Connect your camcorder and TV referring to [TV CONNECT Guide].

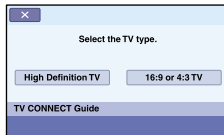

Connectors on your camcorder

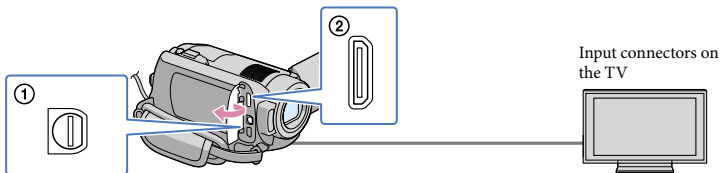

- When the A/V connecting cable is used to output movies, movies are output with standard definition image quality (SD).

4 Play back movies and photos on your camcorder (p. 40).

Connecting to a high definition TV

High definition image quality (HD) movies are played back with high definition image quality (HD). Standard definition image quality (SD) movies are played back with standard definition image quality (SD).

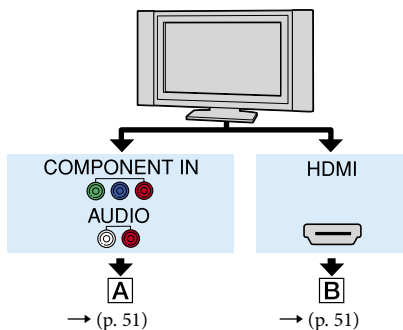

: Signal flow

Type	Camcorder	Cable	TV	HOME MENU setting
------	-----------	-------	----	-------------------

A

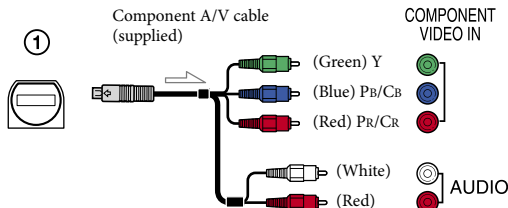

(SETTINGS) →
[OUTPUT SETTINGS]
→ [COMPONENT] →
[1080i/480i] (p. 92)

⚡ Notes

- If you connect only component video plugs, audio signals are not output. Connect the white and red plugs to output audio signals.

B

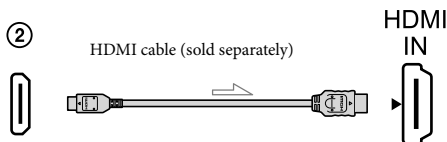

⚡ Notes

- Use an HDMI cable with the HDMI logo.
- Use an HDMI mini connector on one end (for the camcorder), and a plug suitable for connecting your TV on the other end.
- Images are not output from the HDMI OUT jack of your camcorder, if copyright protection signals are recorded in the images.

- Some TVs may not function correctly (e.g., no sound or image) with this connection.
- Do not connect the HDMI OUT jack of your camcorder and HDMI OUT jack of the external device with the HDMI cable. This may cause a malfunction.
- When the connected device is compatible with 5.1ch surround sound, high definition image quality (HD) movies are output in 5.1ch surround sound automatically. Standard definition image quality (SD) movies are converted to 2ch sound.

Connecting to a non-high-definition 16:9 (wide) or 4:3 TV

High definition image quality (HD) movies are converted to standard definition image quality (SD) and played back. Standard definition image quality (SD) movies are played back with standard definition image quality (SD).

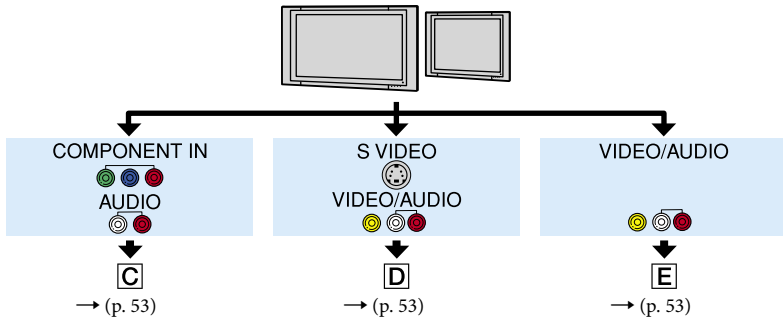

To set the aspect ratio according to the connected TV (16:9/4:3)

Set [TV TYPE] to [16:9] or [4:3] according to your TV (p. 91).

⚡ Notes

- When you play back standard definition image quality (SD) movies on a 4:3 TV that is not compatible with the 16:9 signal, record movies with 4:3 aspect ratio. Touch **HOME** → **SETTINGS** → [MOVIE SETTINGS] → [WIDE SELECT] → [4:3] → **OK** → **EXIT** → **EXIT** (p. 74).

Type	Camcorder	Cable	TV	HOME MENU setting
------	-----------	-------	----	-------------------

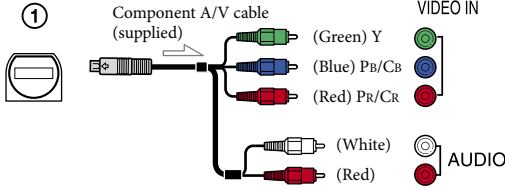
C

(SETTINGS) →
[OUTPUT SETTINGS]
→ [COMPONENT] →
[480i] (p. 92)

(SETTINGS) →
[OUTPUT SETTINGS]
→ [TV TYPE] →
[16:9]/[4:3]* (p. 91)

⚡ Notes

- If you connect only component video plugs, audio signals are not output. Connect the white and red plugs to output audio signals.

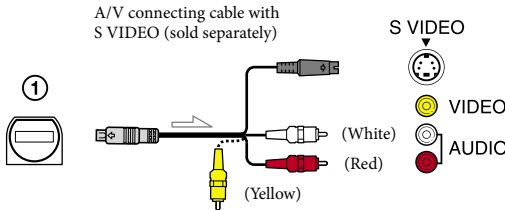
D

(SETTINGS) →
[OUTPUT SETTINGS]
→ [TV TYPE] →
[16:9]/[4:3]* (p. 91)

⚡ Notes

- When the S VIDEO plug (S VIDEO channel) is connected, audio signals are not output. To output audio signals, connect the white and red plugs to the audio input jack of your TV.
- This connection produces higher resolution images compared with the A/V connecting cable (Type **E**).

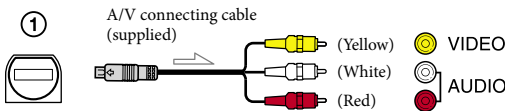
E

(SETTINGS) →
[OUTPUT SETTINGS]
→ [TV TYPE] →
[16:9]/[4:3]* (p. 91)

* Set [TV TYPE] according to your TV.

When connecting to your TV via a VCR

Connect your camcorder to the LINE IN input on the VCR using the A/V connecting cable. Set the input selector on the VCR to LINE (VIDEO 1, VIDEO 2, etc.).

When your TV is monaural (When your TV has only one audio input jack)

Connect the yellow plug of the A/V connecting cable to the video input jack and connect the white (left channel) or red (right channel) plug to the audio input jack of your TV or VCR.

⚡ Notes

- When the A/V connecting cable is used to output images, images are output with standard definition image quality (SD).

💡 Tips

- If you connect your camcorder to the TV using more than one type of cable to output images, the order of priority of the TV input jacks is as follows:
HDMI → component → S VIDEO → video
- HDMI (High-Definition Multimedia Interface) is an interface to send both video/audio signals. The HDMI OUT jack outputs high quality images and digital audio.

Using "BRAVIA" Sync

You can operate your camcorder with the Remote Commander of your TV by connecting your camcorder to a "BRAVIA" Sync compatible TV launched in 2008 or later with the HDMI cable.

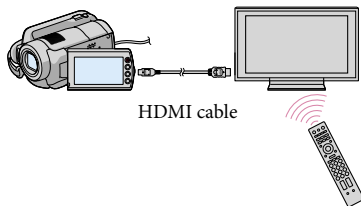



1 Connect your camcorder and a "BRAVIA" Sync compatible TV with the HDMI cable (sold separately).

2 Turn on your camcorder.





The TV input is switched automatically, and the image of your camcorder is displayed on the TV.

3 Operate your camcorder with the Remote Commander of the TV.

You can do the following operations.

- to display  (VIEW IMAGES) or  (HOME) by pressing the SYNC MENU button
- to display an index screen, such as the VISUAL INDEX screen, and play back the desired movies or photos by pressing up/down/left/right/enter buttons on the Remote Commander of your TV

Notes

- There may be some operations you cannot do with the Remote Commander.
- To set your camcorder, touch  (HOME) →  (SETTINGS) → [GENERAL SET] → [CTRL FOR HDMI] → [ON] (the default setting) →  →  → .
- Also set your TV. Refer to the instruction manual of the TV for details.

Tips

- If you turn off the TV, your camcorder is turned off simultaneously.

Deleting movies and photos



You can free media space by deleting movies and photos from recording media. Select the recording medium that contains the movies and photos you want to delete before starting the operation (p. 69). For movies, select the image quality (p. 86).



Notes

- You cannot restore images once they are deleted.
- Do not remove the battery pack or the AC Adaptor from your camcorder while deleting the images. It may damage the recording media.
- Do not eject "Memory Stick PRO Duo" media while deleting images from "Memory Stick PRO Duo" media.
- You cannot delete protected movies and photos. Undo the protection of the movies and photos to delete them, before you try to delete them (p. 62).
- If the deleted movie is included in the Playlist (p. 64), the movie added to the Playlist is deleted also from the Playlist.
- Save important movies and photos in advance (p. 66).



Tips

- You can select up to 100 images at one time.
- You can delete an image on the playback screen from  OPTION MENU.
- To delete all images recorded in the recording media, and recover all the recordable space of the media, format the media (p. 71).
- Reduced-size images which enable you to view many images at the same time on an index screen are called "thumbnails."

1 Touch  (HOME) →  (OTHERS) → [DELETE].

2 To delete movies, touch  [DELETE] →  [DELETE] or

 [DELETE].



- To delete photos, touch  [DELETE] →  [DELETE].

3 Touch and display the  mark on the movies or photos to be deleted.











Tips

- Press and hold the image down on the LCD screen to confirm the image. Touch  to return to the previous screen.

4 Touch  → [YES] →  → .



To delete all movies/photos at one time



In step 2, touch  [DELETE] →  [DELETE ALL]/ [DELETE ALL] → [YES] → [YES] →  → .

- To delete all photos at one time, touch  [DELETE] →  [DELETE ALL] → [YES] → [YES] →  → .



To delete all the movies/photos recorded on the same day at one time

- You can delete photos by selecting recording dates only when photos are recorded on the internal hard disk.

① In step 2, touch  [DELETE] →  [DELETE by date]/ [DELETE by date].

- To delete all photos on the same day at one time, touch  [DELETE] →  [DELETE by date].



- ② Touch / to select the recording date of the desired movies/photos, then touch .

The movies/photos recorded on the selected date are displayed on the screen.

 Tips



- Touch the image down on the LCD screen to confirm the image. Touch  to return to the previous screen.

- ③ Touch  → [YES] →  → .

Acquiring the current location information (HDR-XR200V)

You can display the current location on a map.

Set the GPS switch to ON so that your camcorder can acquire the current location information (p. 38).

Touch  ( YOUR LOCATION) on the recording screen.

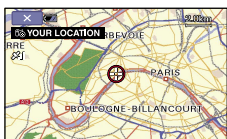

The current location is displayed and marked at the center of the LCD screen.

If you touch a certain point on the screen, the map shows the area with that point at the center.

Touch  (your location) at the bottom left of the LCD screen to move the current location back to the center.

To close the map screen



Touch .

 Notes

- The map always displays the north at the top.

 Tips



- You can change the scale using the zoom lever or zoom buttons (W: larger, T: smaller).
- Your camcorder acquires the current location information every 10 seconds. The displays of the center marker, etc., appear differently according to the status of the current inquiry.

- When your camcorder cannot acquire the current location information, the center marker turns gray and the map shows the last location acquired.
- If you hold a certain point, the map keeps scrolling.
- You can also display the current location by touching  (HOME) →  (OTHERS) →  [YOUR LOCATION].

Capturing a photo from a movie

You can save a selected frame from a recorded movie as a photo.

Select the recording media which contains movies and the image quality, and the recording media where you want to save photos before the operation (p. 69, 86).

1 Touch  (HOME) →  (OTHERS) → [PHOTO CAPTURE].

The [PHOTO CAPTURE] screen appears.

2 Touch the movie to be captured.

The selected movie starts playback.

3 Touch  at the point where you want to capture.

The movie pauses. Play and pause toggles as you press .

Adjust the capturing point with more precision after you selected the point with .

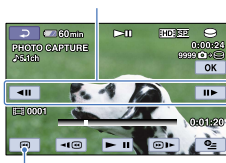



Returns to the beginning of the selected movie

4 Touch .



The captured photo is saved on the recording media selected in [PHOTO MEDIA SET] (p. 69).

When capturing is finished, the screen returns to pause.

- To continue capturing, touch , then repeat steps from step 3.
- To capture a photo from another movie, touch , then repeat steps from step 2.

5 Touch  → .

Notes

- The image size is fixed depending on the image quality of the movie:
 - [ 2.1M] with high definition image quality (HD)
 - [ 0.2M] in 16:9 (wide) with standard definition image quality (SD)
 - [VGA(0.3M)] in 4:3 with standard definition image quality (SD)
- The recording medium where you want to save photos should have enough free space.
- The recording date and time of captured photos is the same as the recording date and time of the movies.
- If the movie you are capturing from has no data code, the recording date and time of the photo will be the date and time you captured from the movie.

Dubbing/copying movies and photos from the internal hard disk to “Memory Stick PRO Duo” media

Dubbing movies

You can dub movies recorded on the internal hard disk of your camcorder to “Memory Stick PRO Duo” media. Insert “Memory Stick PRO Duo” media into your camcorder before the operation.

Notes

- When you record a movie on “Memory Stick PRO Duo” media for the first time, create the image database file by touching **HOME** → **MANAGE MEDIA** → **REPAIR IMG.DB E** → **MEMORY STICK**.
- Connect your camcorder to the wall outlet (wall socket) using the supplied AC Adaptor to prevent your camcorder from running out of power during dubbing.

Tips

- The original movie will not be deleted after dubbing.
- All included images in a Playlist will be dubbed.
- The images recorded by this camcorder and stored onto the recording media are called “original.”

- 1 Touch **HOME** → **OTHERS** → **[MOVIE DUB]**.

The **[MOVIE DUB]** screen appears.

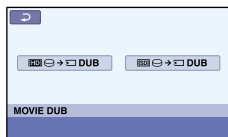

- 2 Touch the image quality of the movie to be dubbed.

[HD] to [DUB]: To dub the high definition image quality (HD) movies
[SD] to [DUB]: To dub the standard definition image quality (SD) movies

- 3 Touch the type of dubbing.

[DUB by select]: To select movies and dub
[DUB by date]: To dub all movies of a specified date
[HD DUB ALL]: To dub the high definition image quality (HD) Playlist
[SD DUB ALL]: To dub the standard definition image quality (SD) Playlist
When you select the Playlist as the source of dubbing, follow the on-screen instructions to dub the Playlist.

- 4 Select the movie to be dubbed.

[DUB by select]: Touch the movie to be dubbed, and mark it with **✓**. You can select multiple movies.



Estimated remaining capacity of “Memory Stick PRO Duo” media

Tips

- Press and hold the image down on the LCD screen to confirm the image. Touch **RETURN** to return to the previous screen.

[DUB by date]: Select the recording date of the movie to be dubbed, then touch **OK**. You cannot select multiple dates.



5 Touch **OK** → **[YES]** → **OK** → **[X]**.

Tips

- To check the dubbed movies after dubbing is finished, select **[MEMORY STICK]** on **[MOVIE MEDIA SET]** and play them back (p. 69).

Copying photos

You can copy photos from the internal hard disk of the camcorder to “Memory Stick PRO Duo” media.

Insert “Memory Stick PRO Duo” media into your camcorder before the operation.

Notes

- Connect your camcorder to the wall outlet (wall socket) using the supplied AC Adaptor to prevent your camcorder from running out of power during copying.

1 Touch **HOME** → **[OTHERS]** → **[PHOTO COPY]**.

The **[PHOTO COPY]** screen appears.

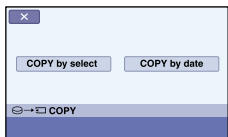

2 Touch the type of copying.

[COPY by select]: To copy selected photos

[COPY by date]: To copy all photos of a specified date

3 Select the photo to be copied.

[COPY by select]: Touch the photo to be copied, and mark with **✓**. You can select multiple photos.



Tips

- Press and hold the image down on the screen to confirm the image. Touch **[RETURN]** to return to the previous screen.

[COPY by date]: Select the recording date of the photo to be copied, then touch **OK**. You cannot select multiple dates.



4 Touch **OK** → **[YES]** → **OK** → **[X]**.

Tips

- To check the copied photos after copying is finished, select **[MEMORY STICK]** on **[PHOTO MEDIA SET]** and play them back (p. 69).



Protecting recorded movies and photos (Protect)



Protect movies and photos to avoid deleting them by mistake.



Select the recording medium that contains the movies and photos you want to protect before starting the operation (p. 69). For movies, select the image quality (p. 86).

Tips

- You can protect movies and photos on the playback screen from  OPTION MENU.

1 Touch  (HOME) →  (OTHERS) → [EDIT].

2 To protect movies, touch  [PROTECT] →  [HD: PROTECT]/ [SD: PROTECT].

- To protect photos, touch  [PROTECT] →  [PROTECT].



3 Touch the movies and photos to be protected.

 is displayed on the selected images.





Tips

- Press and hold the image down on the LCD screen to confirm the image. Touch  to return to the previous screen.
- You can select up to 100 images at one time.

4 Touch  → [YES] →  → .





To undo the protection of movies and photos

Touch the movie or photo marked with  in step 3.



 disappears.

To protect all the movies and photos recorded on the same day at one time

You can protect photos by selecting recording dates only when photos are recorded on the internal hard disk.

- ① In step 2, touch  [PROTECT] →  [HD: PRT. by date]/ [SD: PRT. by date].
- To protect all photos on the same day at one time, touch  [PROTECT] →  [PRT. by date].



- ② Touch /  to select the recording date of the desired movies/photos, then touch .



The movies/photos recorded on the selected date are displayed on the screen.

Tips

- Touch the image down on the LCD screen to confirm the image. Touch  to return to the previous screen.



- ③ Touch  → [ON] →  → .

To undo the protection of movies and photos recorded on the same day at one time

In step ② above, select the recording date of the desired movies/photos, then touch  → [OFF] →  → .

Dividing a movie

Select the recording medium which contains the movie and the image quality you want to divide before the operation (p. 69, 73).

1 Touch  (HOME) →  (OTHERS) → [EDIT] → .

2 Touch the movie to be divided.

The selected movie starts playback.

3 Touch  at the point where you want to divide the movie into scenes.

The movie pauses. Play and pause toggles as you press .

Adjusts the dividing point with more precision after you selected the dividing point with .

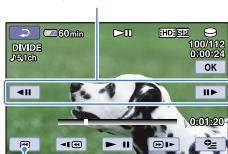

Returns to the beginning of the selected movie

4 Touch [OK] → [YES] → [OK] → [X].

PRO Duo™ media.

- A slight difference may occur from the point where you touch  and the actual dividing point, as your camcorder selects the dividing point based on about half-second increments.
- If you divide the original movie, the movie added to the Playlist will also be divided.

Tips

- You can divide an image on the playback screen from  OPTION MENU.

Notes

- You cannot restore movies once they are divided.
- Do not remove the battery pack or the AC Adaptor from your camcorder while dividing the movie. It may damage the recording media. Also, do not eject “Memory Stick PRO Duo” media while dividing movies on “Memory Stick

Using the Playlist of movies

The Playlist is a list showing thumbnails of the movies that you have selected.

The original movies are not changed even if you edit or delete the movies added to the Playlist.

Select the recording media and the image quality you want to create, play, or edit a Playlist before the operation (p. 69, 86).

Creating the Playlist

⚡ Notes

- High definition image quality (HD) movies and standard definition image quality (SD) movies are added to an individual Playlist.

1 Touch **HOME** → **OTHERS** → **[PLAYLIST EDIT]**.

2 Touch **[HD] ADD** or **[SD] ADD**.

3 Touch the movie to be added to the Playlist.



The selected movie is marked with ✓.

💡 Tips

- Press and hold the image down on the LCD screen to confirm the image. Touch **[]** to return to the previous screen.

4 Touch **[OK]** → **[YES]** → **[OK]** → **[X]**.

To add all the movies recorded on the same day at one time

① In step 2, touch **[HD] ADD by date**/ **[SD] ADD by date**.

The recording dates of movies are displayed on the screen.



② Touch **▲**/**▼** to select the recording date of the desired movie, then touch **[OK]**. The movies recorded on the selected date are displayed on the screen.

💡 Tips

- Touch the image on the LCD screen to confirm the image. Touch **[]** to return to the previous screen.

③ Touch **[OK]** → **[YES]** → **[OK]** → **[X]**.

⚡ Notes

- Do not remove the battery pack or the AC Adaptor from your camcorder while adding movies to the Playlist. It may damage the recording media. Also, do not eject “Memory Stick PRO Duo” media while editing movies on “Memory Stick PRO Duo” media.
- You cannot add photos to the Playlist.
- You cannot create a Playlist which contains both high definition image quality (HD) movies and standard definition image quality (SD) movies.

💡 Tips

- You can add a maximum of 999 high definition image quality (HD) movies, or 99 standard definition image quality (SD) movies to the Playlist.
- You can add a movie on the playback screen or the INDEX screen by touching **[OPTION]**.
- You can copy the Playlist to a disc as it is, by using the supplied software.

Playing the Playlist

Select the recording media and the image quality you want to play a Playlist before the operation (p. 69, 86).

- 1 Touch **HOME** → **VIEW IMAGES** → [PLAYLIST].

Movies added to the Playlist appear.



- 2 Touch the movie you want to play back.

The Playlist is played back from the selected movie to the end, then the screen returns to the Playlist screen.

To erase unnecessary movies from the Playlist

- 1 Touch **HOME** → **(OTHERS)** → [PLAYLIST EDIT].
- 2 Touch [**ERASE**]/[**ERASE**].

To erase all the movies from the Playlist, touch [**ERASE ALL**]/[**ERASE ALL**] → [YES] → [YES] → **OK**.

- 3 Select the movie to be erased from the list.



The selected movie is marked with ✓.

Tips

- Press and hold the image down on the LCD screen to confirm the image. Touch **BACK** to return to the previous screen.

- 4 Touch **OK** → [YES] → **OK** → **X**.

Tips

- Even if you erase a movie from a Playlist, the original movie is not erased.

To change the order within the Playlist

- 1 Touch **HOME** → **(OTHERS)** → [PLAYLIST EDIT].
- 2 Touch [**MOVE**]/[**MOVE**].
- 3 Select the movie to be moved.



The selected movie is marked with ✓.

Tips

- Touch the image on the LCD screen to confirm the image. Touch **BACK** to return to the previous screen.

- 4 Touch **OK**.
- 5 Select the destination with **LEFT**/**RIGHT**.



Destination bar

- 6 Touch **OK** → [YES] → **OK** → **X**.

Tips

- When you select multiple movies, the movies are moved following the order appearing in the Playlist.

Creating a disc with a DVD writer, recorder

Creating a high definition image quality (HD) disc with a DVD writer, etc. (USB cable connection)

You can save high definition image quality (HD) movies on a disc by connecting your camcorder to disc creation devices, such as a Sony DVD writer, with the USB cable. Refer also to the instruction manuals supplied with the devices to be connected.

The method used to create a disc by connecting your camcorder to a Sony DVD writer with the USB cable is described here.

- Connect your camcorder to the wall outlet (wall socket) using the supplied AC Adaptor for this operation (p. 19).
- Sony DVD writer may not be available in some countries/regions.

- 1 Turn on your camcorder, and connect a DVD writer, etc. to the Ψ (USB) jack of your camcorder with the USB cable (supplied).

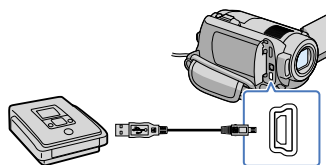

The [USB SELECT] screen appears on the camcorder screen.

- If the [USB SELECT] screen does not appear, touch \uparrow (HOME) \rightarrow ☰ (OTHERS) \rightarrow [USB CONNECT].

- 2 Touch ⊖ [USB CONNECT] when movies are recorded on the internal hard disk, or ⊞ [USB CONNECT] when movies are

recorded on "Memory Stick PRO Duo" media on the camcorder screen.

- 3 Record movies on the connected device.

- For details, refer to the instruction manuals supplied with the device to be connected.

- 4 After the operation is completed, touch [END] \rightarrow [YES] on the camcorder screen.

- 5 Disconnect the USB cable.

⚡ Notes

- The high definition image quality (HD) disc that you created should not be used in DVD players/recorders. Because DVD players/recorders are not compatible with the AVCHD format, DVD players/recorders may fail to eject the disc.

Creating a standard definition image quality (SD) disc with a recorder, etc. (A/V connecting cable connection)

You can dub images played back on your camcorder on a disc or video cassette, by connecting your camcorder to a disc recorder, a Sony DVD writer, etc. with the A/V connecting cable. Connect the device in either way of **1** or **2**. Refer also to the instruction manuals supplied with the devices to be connected. Select the recording medium that contains movies and the image quality you want to dub before starting the operation (p. 69, 73).

- Sony DVD writer may not be available in some countries/regions.

⚡ Notes

- Connect your camcorder to the wall outlet (wall socket) using the supplied AC Adaptor for this operation (p. 19).
- High definition image quality (HD) movies will be dubbed with standard definition image quality (SD).

1 A/V connecting cable (supplied)

Connect the A/V connecting cable to the input jack of another device.

2 A/V connecting cable with S VIDEO (sold separately)

When connecting to another device via the S VIDEO jack, by using an A/V connecting cable with an S VIDEO cable (sold separately), higher quality images can be produced than with an A/V connecting cable. Connect the white and red plug (left/right audio) and the S VIDEO plug (S VIDEO channel) of the A/V connecting cable with an S VIDEO cable. If you connect the S VIDEO plug only, you will hear no sound. The yellow plug (video) connection is not necessary.

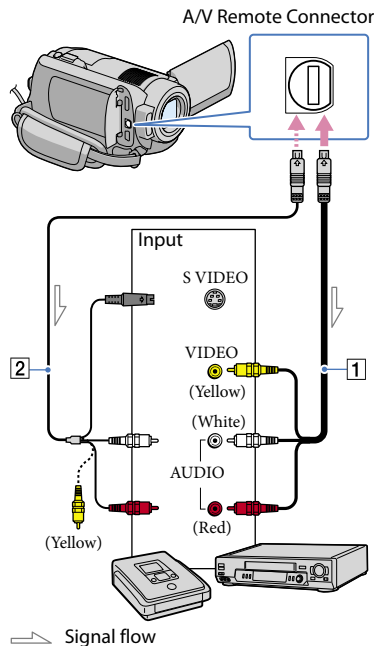

➤ Signal flow

1 Insert the recording media in the recording device.

- If your recording device has an input selector, set it to the input mode.

2 Connect your camcorder to the recording device (a disc recorder, etc.) with the A/V connecting cable 1 (supplied) or an A/V connecting cable with S VIDEO 2 (sold separately).

- Connect your camcorder to the input jacks of the recording device.

3 Start playback on your camcorder, and record it on the recording device.

- Refer to the instruction manuals supplied with your recording device for details.

4 When dubbing is finished, stop the recording device, and then your camcorder.

⚡ Notes

- Since dubbing is performed via analog data transfer, the image quality may deteriorate.
- You cannot dub images to recorders connected with an HDMI cable.
- To hide the screen indicators (such as a counter, etc.) on the screen of the monitor device connected, touch **HOME** → **SETTINGS** → [OUTPUT SETTINGS] → [DISP OUTPUT] → [LCD PANEL] (the default setting) → **OK** → **DISP** → **X**.
- To record the date/time, coordinates (HDR-XR200V), or camera settings data, touch **HOME** → **SETTINGS** → [VIEW IMAGES SET] → [DATA CODE] → a desired setting → **OK** → **DISP** → **X**. In addition, touch **HOME** → **SETTINGS** → [OUTPUT SETTINGS] → [DISP OUTPUT] → [V-OUT/PANEL] → **OK** → **DISP** → **X**.
- When the screen size of display devices (TV, etc.) is 4:3, touch **HOME** → **SETTINGS** → [OUTPUT SETTINGS] → [TV TYPE] → [4:3] → **OK** → **DISP** → **X**.
- When you connect a monaural device, connect the yellow plug of the A/V connecting cable to the video input jack, and the white (left channel) or the red (right channel) plug to the audio input jack on the device.

Checking the battery information

You can check the estimated remaining capacity of the battery.

Touch **HOME** → **OTHERS** → [BATTERY INFO].

The remaining battery capacity is shown.

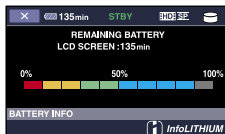

To close the battery information screen

Touch **X**.

Changing the recording medium

You can select the internal hard disk or “Memory Stick PRO Duo” media as the recording, playback, or editing medium on your camcorder. Select the medium to be used for movies and photos separately. In the default setting, both movies and photos are recorded on the internal hard disk.

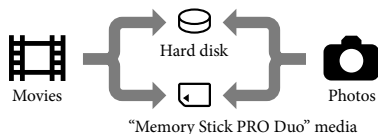

- You can do recording, playback, and editing operations on the selected medium.
- See page 117 for the recordable time of movies.
- See page 118 for the number of recordable photos.

Selecting the recording media for movies

- 1 Touch (HOME) → (MANAGE MEDIA) → [MOVIE MEDIA SET].

The [MOVIE MEDIA SET] screen appears.

- 2 Touch the desired medium.

- 3 Touch [YES] → .

The recording medium is changed.

Selecting the recording media for photos

- 1 Touch (HOME) → (MANAGE MEDIA) → [PHOTO MEDIA SET].

The [PHOTO MEDIA SET] screen appears.

- 2 Touch the desired recording medium.

- 3 Touch [YES] → .

The recording medium is changed.

To check the recording media settings Light up the (Movie) lamp to check the recording medium used for movies, or the (Photo) lamp for photos. The media icon is displayed at the top right corner of the screen.



- : Internal hard disk
- : “Memory Stick PRO Duo” media

Inserting “Memory Stick PRO Duo” media

- Set the recording medium to [MEMORY STICK] to record movies and/or photos on “Memory Stick PRO Duo” media (p. 69).

Types of “Memory Stick” media you can use with your camcorder

- For recording movies, it is recommended that you use “Memory Stick PRO Duo” media of 1 GB or larger marked with:
 - **MEMORY STICK PRO DUO** (“Memory Stick PRO Duo” media)*

– **MEMORY STICK PRO-HG DUO** (“Memory Stick PRO-HG Duo” media)

* Marked with Mark2 or not, either can be used.

- See page 116 for the recordable time of “Memory Stick PRO Duo” media.

“Memory Stick PRO Duo” media/“Memory Stick PRO-HG Duo” media

(This size can be used with your camcorder.)



“Memory Stick” media

(You cannot use it in your camcorder.)



- You cannot use any type of memory card other than those mentioned above.
- “Memory Stick PRO Duo” media can be used only with “Memory Stick PRO” media compatible equipment.
- Do not attach a label or the like on “Memory Stick PRO Duo” media or “Memory Stick Duo” media adaptor.
- Insert the “Memory Stick PRO Duo” media into the “Memory Stick Duo” media adaptor when using “Memory Stick PRO Duo” media with “Memory Stick” media compatible equipment.

1 Open the “Memory Stick Duo” media cover, and insert the “Memory Stick PRO Duo” media into the “Memory Stick Duo” media slot until it clicks.

- Confirm the direction of “Memory Stick PRO Duo” media. If you forcibly insert “Memory Stick PRO Duo” media in the wrong direction, “Memory Stick PRO Duo” media, “Memory Stick Duo” media slot, or image data may be damaged.
- Close the “Memory Stick Duo” media cover after inserting “Memory Stick PRO Duo” media.

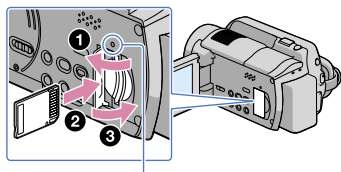

Access lamp
 (“Memory Stick PRO Duo” media)

The [Create a new Image Database File.] screen appears, if you insert new “Memory Stick PRO Duo” media when the  (Movie) lamp is lit.

2 Touch [YES].

- To record only photos on “Memory Stick PRO Duo” media touch [NO].

Notes

- If [Failed to create a new Image Database File. It may be possible that there is not enough free space.] is displayed in step 2, format “Memory Stick PRO Duo” media (p. 71).

To eject “Memory Stick PRO Duo” media

Open the “Memory Stick Duo” media cover and lightly push “Memory Stick PRO Duo” media in once.



- Do not open the “Memory Stick Duo” media cover during recording.
- When inserting or ejecting “Memory Stick PRO Duo” media, be careful so that “Memory Stick PRO Duo” media do not pop out and drop.

Checking the media information

You can check the remaining recordable time for each recording mode of the recording media selected on [MOVIE MEDIA SET] (p. 69), and the approximate free and used media space of the recording media.

⚡ Notes

- During Easy Handycam operation, you cannot check the media information. Cancel Easy Handycam operation.

Touch  (HOME) →  (MANAGE MEDIA) → [MEDIA INFO].

The remaining recordable time for each recording mode is displayed.

💡 Tips

- You can check the recordable free space, etc. by touching  at the lower right on the screen.

To turn off the display

Touch .

⚡ Notes

- The calculation for recording media space is 1 MB = 1,048,576 bytes. The fractions less than MB are discarded when the recording media space is displayed. The displayed size of the whole hard disk space will be slightly smaller than the size shown below despite displaying both free and used hard disk space.
 - HDR-XR100/XR101: 80 000 MB
 - HDR-XR200/XR200V: 120 000 MB
- Since there is a management file area, the used space is not displayed as 0 MB even if you perform [MEDIA FORMAT] (p. 71).

💡 Tips

- Only the information of the medium selected on [MOVIE MEDIA SET] (p. 69) is displayed. Change the medium setting if necessary.



Deleting all movies and photos (Formatting)

Formatting deletes all the movies and photos to recover recordable free space.

⚡ Notes

- Connect your camcorder to the wall outlet (wall socket) using AC Adaptor supplied for this operation (p. 19).
- To avoid the loss of important images, you should save them (p. 66, see Operating Guide too) before formatting the recording media.
- Protected movies and photos will also be deleted.

1

Touch  (HOME) →  (MANAGE MEDIA) → [MEDIA FORMAT].

2

Touch the recording media to be formatted ([HDD] or [MEMORY STICK]).

3

Touch [YES] → [YES] → .

⚡ Notes

- While [Executing...] is displayed, do not close the LCD screen, operate the buttons on the camcorder, disconnect the AC Adaptor, or eject "Memory Stick PRO Duo" media from your camcorder. (The ACCESS/access lamp is lit or flashing while formatting the medium.)

Preventing data on the internal hard disk from being recovered

[⊖EMPTY] allows you to write unintelligible data onto the internal hard disk of the camcorder. In this way, it may become more difficult to recover any original data. When you dispose of or transfer the camcorder, it is recommended that you perform [⊖EMPTY].

⚡ Notes

- If you perform [⊖EMPTY], all the images are deleted. To avoid the loss of important images, they should be saved (p. 66, see Operating Guide too) before performing [⊖EMPTY].
- You cannot perform [⊖EMPTY] unless you connect the AC Adaptor to the wall outlet (wall socket).
- Disconnect all cables except the AC Adaptor. Do not disconnect the AC Adaptor during the operation.
- While performing [⊖EMPTY], do not apply any vibrations or shocks to your camcorder.

1 Connect the AC Adaptor to the DC IN jack on the camcorder and the wall outlet (wall socket).

2 Open the LCD screen to turn on your camcorder.

3 Touch  (HOME) →  (MANAGE MEDIA) → [MEDIA FORMAT] → [HDD].

The [⊖FORMAT] screen appears.

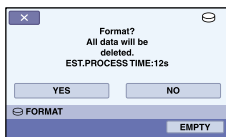

4 Touch [⊖EMPTY].

The [⊖EMPTY] screen appears.

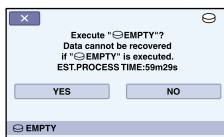

5 Touch [YES] → [YES] → [OK].

⚡ Notes

- The actual performing time for [⊖EMPTY] is as follows:
 - HDR-XR100/XR101: about 80 minutes
 - HDR-XR200/XR200V: about 120 minutes
- If you stop performing [⊖EMPTY] while [Executing...] appears, be sure to complete the operation by performing [MEDIA FORMAT] or [⊖EMPTY] when you use the camcorder next time.





MOVIE SETTINGS (Items for recording movies)



The default settings are marked with ►.

SET

You can select image quality for recording, playback, or editing from high definition image quality (HD) or standard definition image quality (SD).

Steps

🏠 (HOME) →  (SETTINGS) → [MOVIE SETTINGS] → [/ SET] → a desired setting → [YES] → 





►  HD QUALITY	Records, plays, or edits high definition image quality (HD) movies.
 SD QUALITY	Records, plays, or edits standard definition image quality (SD) movies.

Tips





- You can record, play, or edit movies in the selected image quality only. To record, play, or edit movies in another image quality, change this setting.

REC MODE (Recording mode)

Steps

🏠 (HOME) →  (SETTINGS) → [MOVIE SETTINGS] → [REC MODE] → a desired setting →  →  → 



You can select a recording mode to record high definition image quality (HD) movies from 4 levels. When recording fast moving subject, a high image quality, such as [FH], is recommended.

 FH	Records in the highest quality mode (AVC HD 16M (FH))* ¹ .
 HQ	Records in high quality mode (AVC HD 9M (HQ))* ² .
►  SP	Records in standard quality mode (AVC HD 7M (SP))* ² .
 LP	Increases the recording time (Long Play) (AVC HD 5M (LP))* ² .

*¹ Movies are recorded with AVCHD 1920 × 1080/60i format.

*² Movies are recorded with AVCHD 1440 × 1080/60i format.

You can select a recording mode to record standard definition image quality (SD)*³ movies from 3 levels.

 HQ	Records in high quality mode (SD 9M (HQ)).
►  SP	Records in standard quality mode (SD 6M (SP)).
 LP	Increases the recording time (Long Play) (SD 3M (LP)).

*³ Movies are recorded with MPEG2 format.

⚡ Notes

- If you record in the LP mode, the quality of movies may be degraded, or scenes with quick movements may appear with block noise when you play back the image.

💡 Tips

- See page 116 for the expected recording time of each recording mode.
- You can select the [REC MODE] for each recording media separately.
- Figures such as 16M in the table show the average bit rate. M stands for Mbps.

AUDIO MODE

You can change the recording sound format.

Steps

🏠 (HOME) → 📺 (SETTINGS) → [MOVIE SETTINGS] → [AUDIO MODE] → a desired setting → [OK] → [▶] → [X]

▶	5.1ch SURROUND (♫5.1ch)	Records sound in 5.1ch surround.
	2ch STEREO (♫2ch)	Records sound in 2ch stereo.

NIGHTSHOT LIGHT (HDR-XR200/XR200V)

When using the NightShot (p. 36) function, you can record clearer images by activating [NIGHTSHOT LIGHT], which emits infrared light (invisible).

Steps

🏠 (HOME) → 📺 (SETTINGS) → [MOVIE SETTINGS] → [NIGHTSHOT LIGHT] → a desired setting → [OK] → [▶] → [X]

▶	ON	Emits infrared light.
	OFF	Does not emit infrared light.

⚡ Notes

- Do not cover the infrared port (p. 7) with your fingers or other objects.
- Remove the conversion lens (sold separately).
- The maximum shooting distance using [NIGHTSHOT LIGHT] is about 3 m (10 feet).

WIDE SELECT

When recording standard definition image quality (SD) movies, you can select the horizontal to vertical ratio according to the TV connected. Refer also to the instruction manuals supplied with your TV.

Steps

🏠 (HOME) → 📺 (SETTINGS) → [MOVIE SETTINGS] → [WIDE SELECT] → a desired setting → [OK] → [▶] → [X]

▶ 16:9 WIDE	Records movies to the full screen on a 16:9 (wide) TV screen.
4:3 4:3	Records movies to the full screen on a 4:3 TV screen.

⚙ Notes

- Set [TV TYPE] correctly according to the TV connected for playback (p. 91).

DIGITAL ZOOM

You can select the maximum zoom level in case you want to zoom to a level greater than following optical zoom during recording. Note that the image quality decreases when you use the digital zoom.

HDR-XR100/XR101: 10 ×

HDR-XR200/XR200V: 15 ×

Steps

🏠 (HOME) → 📁 (SETTINGS) → [MOVIE SETTINGS] → [DIGITAL ZOOM] → a desired setting → [OK] → [▶] → [X]

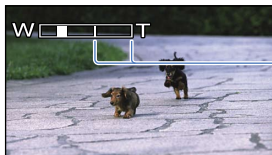

The right side of the bar shows the digital zooming factor. The zooming zone appears when you select the zooming level.

HDR-XR100

▶ OFF	Up to 10 × zoom is performed optically.
20 ×	Up to 10 × zoom is performed optically, and after that, up to 20 × zoom is performed digitally.
120 ×	Up to 10 × zoom is performed optically, and after that, up to 120 × zoom is performed digitally.

HDR-XR101

▶ OFF	Up to 10 × zoom is performed optically.
20 ×	Up to 10 × zoom is performed optically, and after that, up to 20 × zoom is performed digitally.
150 ×	Up to 10 × zoom is performed optically, and after that, up to 150 × zoom is performed digitally.

HDR-XR200/XR200V

▶ OFF	Up to 15 × zoom is performed optically.
30 ×	Up to 15 × zoom is performed optically, and after that, up to 30 × zoom is performed digitally.
180 ×	Up to 15 × zoom is performed optically, and after that, up to 180 × zoom is performed digitally.

STEADYSHOT

You can compensate for camera shake.

Set [STEADYSHOT] to [OFF] (OFF) when using a tripod (sold separately), then the image becomes natural.

Steps

HOME (HOME) → SETTINGS (SETTINGS) → [MOVIE SETTINGS] → [STEADYSHOT] → a desired setting → OK → [] → X

HDR-XR100/XR101

▶ ON	The SteadyShot function is used.
OFF (OFF)	The SteadyShot function is not used.

HDR-XR200/XR200V

▶ ACTIVE	Provides a more powerful SteadyShot effect.
STANDARD	Provides the SteadyShot effect under relatively stable recording conditions.
OFF (OFF)	The SteadyShot function is not used.

AUTO SLW SHUTTR (Auto Slow Shutter)

When recording in dark places, the shutter speed is automatically reduced to 1/30 second.

Steps

HOME (HOME) → SETTINGS (SETTINGS) → [MOVIE SETTINGS] → [AUTO SLW SHUTTR] → a desired setting → OK → [] → X

▶ ON	The Auto Slow Shutter function is used.
OFF	The Auto Slow Shutter function is not used.

X.V.COLOR

You can capture wider range of colors. Various colors such as the brilliant color of flowers and turquoise blue of the sea can be more faithfully reproduced.

Steps

HOME (HOME) → SETTINGS (SETTINGS) → [MOVIE SETTINGS] → [X.V.COLOR] → a desired setting → OK → [] → X

▶ OFF	Records in ordinary color range.
ON ((COLOR))	Records in x.v.Color.

Notes

- Set [X.V.COLOR] to [ON] when the recorded movie will be played back on an x.v.Color-compliant TV. Refer to the instruction manuals of the TV.
- If the movie recorded with this function [ON] is played back on a non-x.v.Color-compliant TV, the color may not be reproduced correctly.

- [X.V.COLOR] cannot be set to [ON]:
 - When recording standard definition image quality (SD) movies
 - While recording a movie.

GUIDEFAME

You can display the frame and check that the subject is horizontal or vertical.
The frame is not recorded. Press DISP to make the frame disappear.

Steps

🏠 (HOME) → 📁 (SETTINGS) → [MOVIE SETTINGS] → [GUIDEFAME] → a desired setting → [OK] → [⏪] → [X]

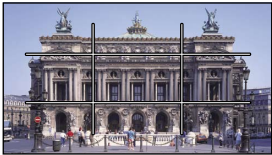
▶ OFF	Does not display the guide frame.	
ON	Displays the guide frame.	

Tips

- Positioning the subject at the cross point of the guide frame makes a balanced composition.

REMAINING SET

Steps

🏠 (HOME) → 📁 (SETTINGS) → [MOVIE SETTINGS] → [REMAINING SET] → a desired setting → [OK] → [⏪] → [X]

▶ ON	Always displays the remaining recording media indicator.
AUTO	<p>Displays the remaining recording time of movies for about 8 seconds in situations such as those described below.</p> <ul style="list-style-type: none"> – When your camcorder recognizes the remaining recording media capacity while the 📺 (Movie) lamp lights up – When you press DISP to switch the indicator from off to on while the 📺 (Movie) lamp lights up – When you select the movie recording mode on the HOME MENU

Notes

- When the remaining recordable time for movies is less than 5 minutes, the indicator stays on the screen.

FLASH MODE (HDR-XR200/XR200V)

You can select the flash setting when you record photos using the built-in flash, or an external flash (sold separately) that is compatible with your camcorder.

Steps

🏠 (HOME) → 📷 (SETTINGS) → [MOVIE SETTINGS] → [FLASH MODE] → a desired setting → [OK] → [↩] → [X]

▶ AUTO	Automatically flashes when there is insufficient ambient light.
ON (🔆)	Always uses the flash regardless of the ambient brightness.
OFF (🔇)	Records without flash.

🔊 Notes

- The recommended distance to the subject when using the built-in flash is about 0.3 to 2.5 m (1 to 8 feet).
- Remove any dust from the surface of the flash before using it. Flash effect may be impaired if heat discoloration or dust obscures the lamp.
- You cannot set this item when a filter or a conversion lens is attached to your camcorder.
- The 🔆/CHG (charge) lamp (p. 8) flickers while charging the flash, and remains lit when the battery charge is complete.
- If you use the flash in bright places such as when shooting a backlit subject, the flash may not be effective.

FLASH LEVEL (HDR-XR200/XR200V)

You can set this function when you record photos using the built-in flash, or an external flash (sold separately) that is compatible with your camcorder.

Steps

🏠 (HOME) → 📷 (SETTINGS) → [MOVIE SETTINGS] → [FLASH LEVEL] → a desired setting → [OK] → [↩] → [X]

HIGH (🔆+)	Makes the flash level higher.
▶ NORMAL (🔆)	
LOW (🔆-)	Makes the flash level lower.

REDEYE REDUC (Redeye reduction) (HDR-XR200/XR200V)

You can set this function when you record photos using the built-in flash, or an external flash (sold separately) that is compatible with your camcorder.

When you set [REDEYE REDUC] to [ON], then set [FLASH MODE] to [AUTO] or [ON], 🗨 appears. You can prevent redeye by activating the pre-flash before the flash flashes.

Steps

🏠 (HOME) → 📷 (SETTINGS) → [MOVIE SETTINGS] → [REDEYE REDUC] → a desired setting → [OK] → [↩] → [X]

▶ OFF	Does not prevent redeye.
ON (👁)	Prevents redeye.

🔔 Notes

- The redeye reduction may not produce the desired effect due to individual differences and other conditions.
- The redeye function does not work with automatic recording using [SMILE SHUTTER].

CONVERSION LENS

When using a conversion lens (sold separately), use this function to record using the optimum compensation for camera shake and focus for each lens.

Steps

🏠 (HOME) → 📷 (SETTINGS) → [MOVIE SETTINGS] → [CONVERSION LENS] → a desired setting → [OK] → [↔] → [X]

▶ WIDE CONVERSION (👁)	Select this when you use a wide-conversion lens.
TELE CONVERSION (👁)	Select this when you use a tele-conversion lens.
▶ OFF	Select this when you do not use a conversion lens.

AUTO BACK LIGHT (Auto Backlight Correction)

Your camcorder adjusts the exposure for backlit subjects automatically.

Steps

🏠 (HOME) → 📷 (SETTINGS) → [MOVIE SETTINGS] → [AUTO BACK LIGHT] → a desired setting → [OK] → [↔] → [X]

▶ ON	Adjusts the exposure for backlit subjects automatically.
OFF	Does not adjust the exposure for backlit subjects.

PHOTO SETTINGS (Items for recording photos)

The default settings are marked with ►.

IMAGE SIZE

You can select a photo size to be shot.

Steps

🏠 (HOME) → 📷 (SETTINGS) → [PHOTO SETTINGS] → [IMAGE SIZE] → a desired setting → [OK] → [▶] → [X]

► 4.0M (L4.0M)	Records photos in the high quality (2,304 × 1,728).
▶ 3.0M (L3.0M)	Records photos in the high quality in the 16:9 (wide) ratio (2,304 × 1,296).
1.9M (L1.9M)	Allows you to record more photos in relatively clear quality (1,600 × 1,200).
VGA(0.3M) (LVGA)	Allows the maximum number of photos to be recorded (640 × 480).

⚡ Notes

- The selected image size is effective when the 📷 (Photo) lamp is lit.
- See page 118 for the number of recordable photos.

FILE NO. (File number)

You can select the way to assign file number of photos.

Steps

🏠 (HOME) → 📷 (SETTINGS) → [PHOTO SETTINGS] → [FILE NO.] → a desired setting → [OK] → [▶] → [X]

► SERIES	Assigns file numbers of photos in sequence. – The file number becomes larger each time you record a photo. – Even if “Memory Stick PRO Duo” media are replaced with another one, the file number is assigned in sequence.
RESET	Assigns file numbers in sequence, following the largest file number existing on the current recording medium. – When “Memory Stick PRO Duo” media are replaced with another one, the file number is assigned for each one of “Memory Stick PRO Duo” media.

NIGHTSHOT LIGHT (HDR-XR200/XR200V)

When using the NightShot (p. 36) function, you can record clearer images by activating [NIGHTSHOT LIGHT], which emits infrared light (invisible).

Steps

🏠 (HOME) → 📷 (SETTINGS) → [PHOTO SETTINGS] → [NIGHTSHOT LIGHT] → a desired setting → [OK] → [▶] → [X]

▶ ON	Emits infrared light.
OFF	Does not emit infrared light.

⚡ Notes

- Do not cover the infrared port (p. 7) with your fingers or other objects.
- Remove the conversion lens (sold separately).
- The maximum shooting distance using [NIGHTSHOT LIGHT] is about 3 m (10 feet).

📷 STEADYSHOT (HDR-XR200/XR200V)

You can compensate for camera shake.

Set [📷STEADYSHOT] to [OFF] (👁️) when using a tripod (sold separately), then the image becomes natural.

Steps

🏠 (HOME) → 🗑️ (SETTINGS) → [PHOTO SETTINGS] → [📷STEADYSHOT] → a desired setting → [OK] → [👁️] → [X]

▶ ON	The SteadyShot function is used.
OFF (👁️)	The SteadyShot function is not used.

AUTO SLW SHUTTR (Auto Slow Shutter)

When recording in dark places, the shutter speed is automatically reduced to 1/30 second.

Steps

🏠 (HOME) → 🗑️ (SETTINGS) → [PHOTO SETTINGS] → [AUTO SLW SHUTTR] → a desired setting → [OK] → [👁️] → [X]

▶ ON	The Auto Slow Shutter function is used.
OFF	The Auto Slow Shutter function is not used.

GUIDEFAME

You can display the frame and check that the subject is horizontal or vertical. The frame is not recorded. Press DISP to make the frame disappear.

Steps

🏠 (HOME) → 🗑️ (SETTINGS) → [PHOTO SETTINGS] → [GUIDEFAME] → a desired setting → [OK] → [👁️] → [X]

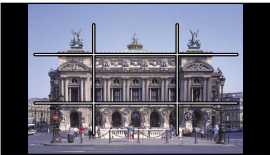
▶ OFF	Does not display the guide frame.	
ON	Displays the guide frame.	

💡 Tips

- Positioning the subject at the cross point of the guide frame makes a balanced composition.

FLASH MODE (HDR-XR200/XR200V)

You can select the flash setting when you record photos using the built-in flash, or an external flash (sold separately) that is compatible with your camcorder.

Steps

🏠 (HOME) → 📷 (SETTINGS) → [PHOTO SETTINGS] → [FLASH MODE] → a desired setting → [OK] → [▶] → [X]

▶ AUTO	Automatically flashes when there is insufficient ambient light.
ON (🔆)	Always uses the flash regardless of the ambient brightness.
OFF (🔆)	Records without flash.

🔊 Notes

- The recommended distance to the subject when using the built-in flash is about 0.3 to 2.5 m (1 to 8 feet).
- Remove any dust from the surface of the flash before using it. Flash effect may be impaired if heat discoloration or dust obscures the lamp.
- You cannot set this item when a filter or a conversion lens is attached to your camcorder.
- The 🔆/CHG (charge) lamp (p. 8) flickers while charging the flash, and remains lit when the battery charge is complete.
- If you use the flash in bright places such as when shooting a backlit subject, the flash may not be effective.

FLASH LEVEL (HDR-XR200/XR200V)

You can set this function when you record photos using the built-in flash, or an external flash (sold separately) that is compatible with your camcorder.

Steps

🏠 (HOME) → 📷 (SETTINGS) → [PHOTO SETTINGS] → [FLASH LEVEL] → a desired setting → [OK] → [▶] → [X]





HIGH (🔆+)	Makes the flash level higher.
▶ NORMAL (🔆)	
LOW (🔆-)	Makes the flash level lower.



REDEYE REDUC (Redeye reduction) (HDR-XR200/XR200V)

You can set this function when you record photos using the built-in flash, or an external flash (sold separately) that is compatible with your camcorder.

When you set [REDEYE REDUC] to [ON], then set [FLASH MODE] to [AUTO] or [ON],  appears. You can prevent redeye by activating the pre-flash before the flash flashes.

Steps

 (HOME) →  (SETTINGS) → [PHOTO SETTINGS] → [REDEYE REDUC] → a desired setting →  →  → 

 OFF	Does not prevent redeye.
ON 	Prevents redeye.





Notes





- The redeye reduction may not produce the desired effect due to individual differences and other conditions.
- The redeye function does not work with automatic recording using [SMILE SHUTTER].

CONVERSION LENS

When using a conversion lens (sold separately), use this function to record using the optimum compensation for camera shake (HDR-XR200/XR200V) and focus for each lens.

Steps





 (HOME) →  (SETTINGS) → [PHOTO SETTINGS] → [CONVERSION LENS] → a desired setting →  →  → 

 WIDE CONVERSION 	Select this when you use a wide-conversion lens.
TELE CONVERSION 	Select this when you use a tele-conversion lens.
 OFF	Select this when you do not use a conversion lens.

AUTO BACK LIGHT (Auto Backlight Correction)

Your camcorder adjusts the exposure for backlit subjects automatically.

Steps

 (HOME) →  (SETTINGS) → [PHOTO SETTINGS] → [AUTO BACK LIGHT] → a desired setting →  →  → 

 ON	Adjusts the exposure for backlit subjects automatically.
OFF	Does not adjust the exposure for backlit subjects.

FACE FUNC. SET (Items to set face function)

The default settings are marked with ►.

FACE DET. SETTING

You can adjust the settings for the FACE DETECTION function.

Steps

🏠 (HOME) → ⚙️ (SETTINGS) → [FACE FUNC. SET] → [FACE DET. SETTING] → [FACE DETECTION]/[FRAME SETTING] → a desired setting → [OK] → [▶] → [▶] → [X]

FACE DETECTION

Detects the faces of your subjects and adjusts the focus/color/exposure automatically. Also, it adjusts the image quality of face parts more finely, in the case of the high definition image quality (HD) movies.

► ON (👤)	Detects faces.
OFF	Does not detect faces.

⚡ Notes

- Faces may not be detected depending on recording conditions, subject conditions, and the setting of your camcorder.
- [FACE DETECTION] may not function properly depending on recording conditions. Set [FACE DETECTION] to [OFF] in this case.

💡 Tips

- The detected faces are recorded in Face Index, however, some faces may not be. Also, there is a limit to the number of faces that can be recorded in Face Index. To play back from the Face Index, see page 45.

FRAME SETTING

Sets whether to display the detection frame or not when a face is detected by [FACE DETECTION] or [DETECTION SET].

Orange frame: A face targeted for possible smile detection shot.

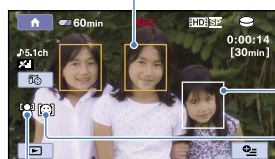

White frame: Detects faces.

DETECTION SET

FACE DETECTION

► ON	Displays the detection frame.
OFF	Does not display the detection frame.

⚡ Notes

- The detection frame does not appear while using mirror mode (p. 37).

SMILE SHUTTER

You can adjust the settings for the SMILE SHUTTER function.

Steps

🏠 (HOME) → 📁 (SETTINGS) → [FACE FUNC. SET] → [SMILE SHUTTER] → [DETECTION SET]/[SMILE SENSITIVITY]/[SMILE PRIORITY]/[FRAME SETTING] → a desired setting
→ [OK] → [⏪] → [⏩] → [X]

DETECTION SET

The shutter is released when the camcorder detects a smile.

▶ DUAL CAPTURE (👤)	Only during movie recording, the shutter is released automatically, when the camcorder detects a smile.
ALWAYS ON (👤)	The shutter is released when the camcorder detects a smile whenever the camcorder is in recording mode.
OFF	Smiles are not detected, so photos are not recorded automatically.

⚡ Notes

- Smiles may not be detected depending on recording conditions, subject conditions, and the setting of your camcorder.
- When [DUAL CAPTURE] is selected, 👤 appears on the screen in movie recording standby, and 👤 changes into 👤 when movie recording starts.

💡 Tips

- If a smile is not detected, set the [SMILE SENSITIVITY] (p. 85).
- You can select the subject that has priority for smile detection with [SMILE PRIORITY] (p. 85).

SMILE SENSITIVITY

Sets the smile detection sensitivity using the SMILE SHUTTER function.

HIGH	Detects even a slight smile.
▶ MEDIUM	Detects a normal smile.
LOW	Detects a big smile.

SMILE PRIORITY

Selects the priority subject for the SMILE SHUTTER function.

▶ AUTO	Detects and shoots smiling faces automatically.
CHILD PRIORITY	Detects and shoots with priority on a child's face.
ADULT PRIORITY	Detects and shoots with priority on an adult's face.

FRAME SETTING

See page 84.

VIEW IMAGES SET (Items to customize the display)

The default settings are marked with ▶.

HD/SD SET

You can select image quality for recording, playback, or editing from high definition image quality (HD) or standard definition image quality (SD).

Steps

HOME (HOME) → SETTINGS (SETTINGS) → [VIEW IMAGES SET] → [HD/SD SET] → a desired setting → [YES] → OK

▶ HD QUALITY	Records, plays, or edits high definition image quality (HD) movies.
SD QUALITY	Records, plays, or edits standard definition image quality (SD) movies.

Tips

- You can record, play, or edit movies in the selected image quality only. To record, play, or edit movies in another image quality, change this setting.

DATA CODE

During playback, your camcorder displays the information (data code) recorded automatically at the time of recording.

Steps

HOME (HOME) → SETTINGS (SETTINGS) → [VIEW IMAGES SET] → [DATA CODE] → a desired setting → OK → [▶] → X

HDR-XR100/XR101/XR200

▶ OFF	Data code is not displayed.
DATE/TIME	Displays the date and time.
CAMERA DATA	Displays camera setting data.

DATE/TIME



- 1 Date
- 2 Time

CAMERA DATA

Movie

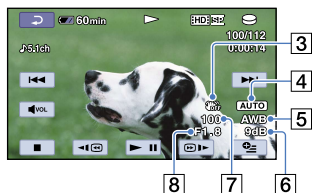

Photo



- 3 SteadyShot off
- 4 Brightness
- 5 White balance
- 6 Gain
- 7 Shutter speed
- 8 Aperture value
- 9 Exposure

Tips

- The data code is displayed on the TV screen if you connect your camcorder to a TV.
- Depending on the recording media condition, bars [---:---] appear.

HDR-XR200V

▶ OFF	Data code is not displayed.
DATE/TIME	Displays the date and time.
CAMERA DATA	Displays camera setting data.
COORDINATES	Displays coordinates.

DATE/TIME



- 1 Date
- 2 Time

CAMERA DATA

Movie

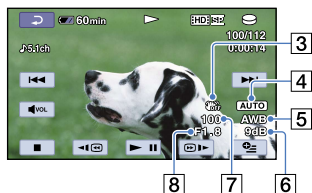

Photo



3 SteadyShot off

4 Brightness

5 White balance

6 Gain

7 Shutter speed

8 Aperture value

9 Exposure

COORDINATES



10 Latitude

11 Longitude

Tips

-  appears for a photo recorded using a flash.
- The data code is displayed on the TV screen if you connect your camcorder to a TV.
- The indicator toggles through the following sequences as you press DATA CODE on the Wireless Remote Commander: [DATE/TIME] → [CAMERA DATA] → [COORDINATES] → [OFF] (no indication).
- Depending on the recording media condition, bars [---:---] appear.

SOUND/DISP SET (Items to adjust the sound and the screen)

The default settings are marked with ▶.

VOLUME

You can adjust the volume of playback sound.

Steps

🏠 (HOME) → ⚙️ (SETTINGS) → [SOUND/DISP SET] → [VOLUME] → (quieter)/
 (louder) → → →

BEEP

Steps

🏠 (HOME) → ⚙️ (SETTINGS) → [SOUND/DISP SET] → [BEEP] → a desired setting →
 → →

▶ ON	A melody sounds when you start/stop recording, or operate the touch panel.
OFF	Cancels the melody.

LCD BRIGHT

You can adjust the brightness of the LCD screen.

Steps

🏠 (HOME) → ⚙️ (SETTINGS) → [SOUND/DISP SET] → [LCD BRIGHT] → (darker)/
 (brighter) → → →

💡 Tips

- This adjustment does not affect the recorded images in any way.

LCD BL LEVEL (LCD backlight level)

You can adjust the brightness of the LCD screen's backlight.

Steps

🏠 (HOME) → ⚙️ (SETTINGS) → [SOUND/DISP SET] → [LCD BL LEVEL] → a desired
setting → → →

▶ NORMAL	Standard brightness.
BRIGHT	Brightens the LCD screen.

🔌 Notes

- When you connect your camcorder to the wall outlet (wall socket) using the supplied AC Adaptor, [BRIGHT] is automatically selected for the setting.

- When you select [BRIGHT], battery life is slightly reduced during recording.
- If you open the LCD panel 180 degrees to face the screen outside and close the LCD panel to the camcorder body, the setting becomes [NORMAL] automatically.







 Tips

- This adjustment does not affect the recorded images in any way.

LCD COLOR

You can adjust the color of the LCD screen.

Steps

 (HOME) →  (SETTINGS) → [SOUND/DISP SET] → [LCD COLOR] →  (lower intensity)/ (higher intensity) →  →  → 

 Tips

- This adjustment does not affect the recorded images in any way.

OUTPUT SETTINGS (Items for when connected to a TV)





The default settings are marked with ▶.

TV TYPE

You need to convert the signal depending on the TV connected when playing back movies and photos. The recorded movies and photos are played back as following illustrations.

Steps

🏠 (HOME) → ⚙️ (SETTINGS) → [OUTPUT SETTINGS] → [TV TYPE] → a desired setting
→ [OK] → [▶] → [X]

▶ 16:9		<p>Select this to view your movies and photos on a 16:9 (wide) TV. The recorded movies and photos are played back as shown below.</p> <p>Movies recorded in 16:9 (wide) mode Movies recorded in 4:3 mode</p> <div data-bbox="296 521 584 681"></div> <div data-bbox="612 521 900 681"></div>
4:3		<p>Select this to view your movies and photos on a 4:3 standard TV. The recorded movies and photos are played back as shown below.</p> <p>Movies recorded in 16:9 (wide) mode Movies recorded in 4:3 mode</p> <div data-bbox="332 787 550 947"></div> <div data-bbox="648 787 866 947"></div>

⚡ Notes

- Horizontal to vertical ratio of high definition image quality (HD) movies is 16:9.
- When you connect your camcorder to a TV compatible with the ID-1/ID-2 system, set [TV TYPE] to [16:9]. The TV switches to full mode automatically. Refer also to the instruction manuals supplied with your TV.

DISP OUTPUT (Display output)

You can set where the screen displays are to be output.

Steps

🏠 (HOME) → ⚙️ (SETTINGS) → [OUTPUT SETTINGS] → [DISP OUTPUT] → a desired setting → **OK** → **⏪** → **X**

▶ LCD PANEL	Shows displays such as the time code on the LCD screen.
V-OUT/PANEL	Shows displays such as the time code on LCD screen, and on the TV screen.

COMPONENT

Select [COMPONENT] when connecting your camcorder to a TV with the component input jack.

Steps

🏠 (HOME) → ⚙️ (SETTINGS) → [OUTPUT SETTINGS] → [COMPONENT] → a desired setting → **OK** → **⏪** → **X**

480i	Select this when connecting your camcorder to a TV with the component input jack.
▶ 1080i/480i	Select this when connecting your camcorder to a TV that has the component input jack and is capable of displaying the 1080i signal.

HDMI RESOLUTION

Select the output image resolution when connecting your camcorder to a TV with an HDMI cable.

Steps

🏠 (HOME) → ⚙️ (SETTINGS) → [OUTPUT SETTINGS] → [HDMI RESOLUTION] → [HD CONTENTS]/[SD CONTENTS] → a desired setting → **OK** → **⏪** → **⏪** → **X**

HD CONTENTS

Set the output image resolution recorded with high definition image quality (HD).

▶ AUTO	Normal setting (outputs the signal according to the TV automatically).
1080i	Outputs the 1080i signal.
720p	Outputs the 720p signal.
480p	Outputs the 480p signal.

SD CONTENTS

Set the output image resolution recorded with standard definition image quality (SD).

▶ AUTO	Normal setting (outputs the signal according to the TV automatically).
480p	Outputs the 480p signal.
480i	Outputs the 480i signal.

CLOCK/ LANG (Items to set clock and language)

The default settings are marked with ►.

CLOCK SET

See page 21.

AREA SET

You can adjust a time difference without stopping the clock. Set your local area when using your camcorder in other time zones. Refer to the world time difference on page 120.

Steps

 (HOME) →  (SETTINGS) → [CLOCK/  LANG] → [AREA SET] → set your local area using /  →  →  → 

AUTO CLOCK ADJ (HDR-XR200V)

Your camcorder will maintain the correct clock time by acquiring the time from GPS. Set the GPS switch to ON in advance.

Steps

 (HOME) →  (SETTINGS) → [CLOCK/  LANG] → [AUTO CLOCK ADJ] → a desired setting →  →  → 

► ON	Adjusts the clock automatically.
OFF	Does not adjust the clock automatically.

Notes

- You must set the date and time on your camcorder before using your camcorder (p. 21).
- There may be discrepancies of a few seconds even if [AUTO CLOCK ADJ] is activated.
- The clock is adjusted automatically by [AUTO CLOCK ADJ] when you turn off your camcorder if the camcorder is receiving a GPS signal while it is being used. The clock is not adjusted until the camcorder is turned off. Also, the clock is not adjusted unless the camcorder is receiving a GPS signal, even if the GPS switch is set to ON.

AUTO AREA ADJ (HDR-XR200V)

Your camcorder will compensate for a time differences with the current area automatically when it detects a time difference, by acquiring the current area information from GPS. Set the GPS switch to ON in advance.

Steps

 (HOME) →  (SETTINGS) → [CLOCK/  LANG] → [AUTO AREA ADJ] → a desired setting →  →  → 

▶ ON	Compensates for the time difference with the current area automatically.
OFF	Does not compensate for the time difference with the current area automatically.

⚡ Notes

- You must set date and time on your camcorder before using your camcorder (p. 21).

DST SET/SUMMERTIME

You can change this setting without stopping the clock. Set to [ON] to move the time forward 1 hour.

Steps

🏠 (HOME) → ⚙️ (SETTINGS) → [CLOCK/🕒 LANG] → [DST SET]/[SUMMERTIME] → a desired setting → [OK] → [↩] → [X]

▶ OFF	Does not set the summertime.
ON	Sets the summertime.

🗨 LANGUAGE SET

You can select the language to be used on the LCD screen.

Steps

🏠 (HOME) → ⚙️ (SETTINGS) → [CLOCK/🕒 LANG] → [🗨 LANGUAGE SET] → a desired setting → [OK] → [↩] → [X]

💡 Tips

- Your camcorder offers [ENG[SIMP]] (simplified English) for when you cannot find your native tongue among the options.



GENERAL SET (Other setup items)

The default settings are marked with ►.

DEMO MODE

When your camcorder is connected to a wall outlet (wall socket), a demonstration movie appear about 10 minutes after you turn on the  (Movie) lamp by pressing MODE.

Steps





 (HOME) →  (SETTINGS) → [GENERAL SET] → [DEMO MODE] → a desired setting → 

► ON	The demonstration appears.
OFF	The demonstration does not appear.

Notes

- You can find the demonstration movie on the VISUAL INDEX screen in the default setting. The demonstration movie will not be restored once it is deleted.
- Meanwhile, a movie you have recorded will be registered as the demonstration movie if the movie satisfies the following conditions.
 - The movie is protected
 - The movie is the first one displayed on the VISUAL INDEX screen
 - The movie is recorded on the internal hard disk
 - The movie is recorded with high definition image quality (HD)





Tips

- When you set this item to [ON] and touch , the demonstration starts playing.
- The demonstration will be suspended:
 - When you press START/STOP or PHOTO
 - When you touch the screen during the demonstration (The demonstration starts again after about 10 minutes)
 - When you turn on the  (Photo) lamp
 - When you press  (HOME) or  (VIEW IMAGES)

REC LAMP (Recording lamp) (HDR-XR200/XR200V)

You can make the camera recording lamp on the front of your camcorder not to turn on.

Steps

 (HOME) →  (SETTINGS) → [GENERAL SET] → [REC LAMP] → a desired setting →  →  → 

► ON	The camera recording lamp lights up.
OFF	The camera recording lamp does not light up.





CALIBRATION

See page 128.

A.SHUT OFF (Auto shut off)

You can set your camcorder to turn off automatically when you do not operate your camcorder for more than about 5 minutes.

Steps

🏠 (HOME) →  (SETTINGS) → [GENERAL SET] → [A.SHUT OFF] → a desired setting →  →  → 

▶ 5min	The camcorder turns off automatically.
NEVER	The camcorder does not turn off automatically.





⚡ Notes

- When you connect your camcorder to a wall outlet (wall socket), [A.SHUT OFF] is automatically set to [NEVER].

POWER ON BY LCD

You can set your camcorder to turn on and off when you open and close the LCD screen.





Steps

🏠 (HOME) →  (SETTINGS) → [GENERAL SET] → [POWER ON BY LCD] → a desired setting →  →  → 

▶ ON	The camcorder turns on and off when the LCD screen opens and closes.
OFF	The camcorder does not turn on and off when the LCD screen opens and closes.

REMOTE CTRL (Remote control) (HDR-XR200/XR200V)

Steps

🏠 (HOME) →  (SETTINGS) → [GENERAL SET] → [REMOTE CTRL] → a desired setting →  →  → 

▶ ON	Select this when you use the supplied Wireless Remote Commander (p. 9).
OFF	Select this when you do not use supplied Wireless Remote Commander.

💡 Tips

- Select [OFF] when you want to prevent your camcorder from responding to a command sent by another remote control unit.

DROP SENSOR

Your camcorder detects that it is dropping, and protects the internal hard disk.

Steps

🏠 (HOME) → ⚙️ (SETTINGS) → [GENERAL SET] → [DROP SENSOR] → a desired setting
→ [OK] → [⏪] → [X]

▶ ON	Activates the drop sensor. When it is detected that the camcorder is dropping, you may not be able to record or play back images correctly, to protect the internal hard disk. When dropping is detected, 📵 appears.
▶ OFF (🔌OFF)	Deactivates the drop sensor.

⚡ Notes

- Set the drop sensor to [ON] when you use the camcorder. Otherwise, if you drop the camcorder, you may damage the internal hard disk.
- In a non-gravity situation, the drop sensor activates. When you record images during an activity such as roller-coasting or skydiving, you can set [DROP SENSOR] to [OFF] so as not to activate the drop sensor.

CTRL FOR HDMI (Control for HDMI)

When connecting your camcorder to a “BRAVIA” Sync compatible TV with the HDMI cable (sold separately), you can play back movies on your camcorder by aiming the TV’s Remote Commander at the TV (p. 54).

Steps

🏠 (HOME) → ⚙️ (SETTINGS) → [GENERAL SET] → [CTRL FOR HDMI] → a desired setting
→ [OK] → [⏪] → [X]

▶ ON	Operates your camcorder using the TV’s Remote Commander.
▶ OFF	Does not operate your camcorder using the TV’s Remote Commander.



Functions set in the OPTION MENU

Items you can set only on the  OPTION MENU will be described below.
The default settings are marked with .

SPOT MTR/FCS

You can adjust the brightness and focus for the selected subject simultaneously. This function enables you to use [SPOT METER] (p. 99) and [SPOT FOCUS] (p. 100) at the same time.

Steps

In recording mode,  (OPTION) →  → [SPOT MTR/FCS] → touch the subject you want to adjust the brightness and focus on → [END] → 

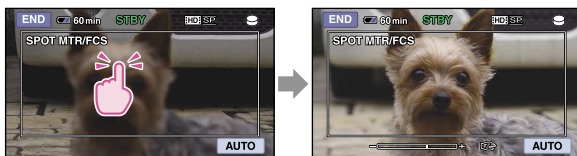

To adjust the brightness and focus automatically, touch [AUTO].



Notes

- [EXPOSURE] and [FOCUS] are automatically set to [MANUAL].

SPOT METER (Flexible spot meter)

You can adjust and fix the exposure to the subject, so that it is recorded in suitable brightness even when there is strong contrast between the subject and the background, such as subjects in the spotlight on stage.

Steps

In recording mode,  (OPTION) →  → [SPOT METER] → touch the point where you want to fix and adjust the exposure on the screen – [END] → 

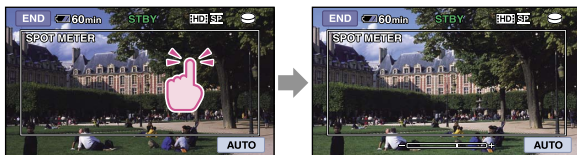

To return the setting to automatic exposure, touch [AUTO].



Notes

- [EXPOSURE] is automatically set to [MANUAL].

SPOT FOCUS

You can select and adjust the focal point to aim it at a subject not located at the center of the screen.

Steps

In recording mode,  (OPTION) →  → [SPOT FOCUS] → touch the point to be focused within the frame on the screen → [END] → 

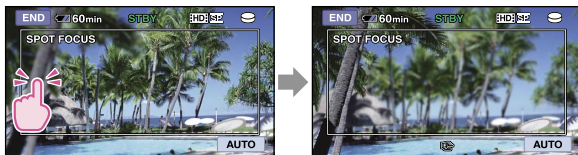

To adjust the focus automatically, touch [AUTO].



Notes

- [FOCUS] is automatically set to [MANUAL].

TELE MACRO

This is useful to shoot small subjects, such as flowers or insects. You can blur out backgrounds and the subject stands out clearer.

Steps

In recording mode,  (OPTION) →  → [TELE MACRO] → a desired setting → [OK] → 

▶ OFF	Cancels TELE MACRO. (TELE MACRO is also canceled when you move the zoom lever to the W side.)
ON (T)	The zoom (p. 35) moves to the top of the T (telephoto) side automatically and allows recording subjects at a close distance down to the followings. HDR-XR100/XR101: about 50 cm (19 3/4 in.) HDR-XR200/XR200V: about 57 cm (22 1/2 in.) 





Notes

- When recording a distant subject, focusing may be difficult and can take some time.
- Adjust the focus manually ([FOCUS], p. 101) when it is hard to focus automatically.

EXPOSURE

You can fix the brightness of a picture manually. Adjust the brightness when the subject is too bright or too dark.

Steps

In recording mode,  (OPTION) →  → [EXPOSURE] → [MANUAL] →  (darker)/
 (brighter) → [OK] → 







To adjust the exposure automatically, touch [AUTO].

FOCUS

You can adjust the focus manually. You can select this function also when you want to focus on a certain subject intentionally.

Steps

In recording mode,  (OPTION) →  → [FOCUS] → [MANUAL] →  (focusing on close subjects)/ (focusing on distant subjects) → [OK] → 





To adjust the focus automatically, touch [AUTO].

Notes

- When you set [FOCUS] to [MANUAL],  appears.
- The minimum possible distance between camcorder and subject while maintaining sharp focus is about 1 cm (about 13/32 in.) for wide angle and about 80 cm (about 2 5/8 feet) for telephoto.



Tips

-  appears when the focus cannot be adjusted any closer, and  appears when the focus cannot be adjusted farther away.
- It is easier to focus on the subject by moving the power zoom lever towards T (telephoto) to adjust the focus, then towards W (wide angle) to adjust the zoom for recording. When you want to record a subject at close range, move the power zoom lever to W (wide angle), then adjust the focus.
- The focal distance information (distance at which the subject is focused on; used as a guide if it is dark and focus adjustment is difficult) appears for a few seconds in the following cases. (This information will not display correctly if a conversion lens (sold separately) is being used.)
 - When the focus mode is switched from automatic to manual
 - When you set focus manually





















SCENE SELECTION

You can record images effectively in various situations.

Steps

In recording mode,  (OPTION) →  → [SCENE SELECTION] → a desired setting →



 → 

▶ AUTO	Automatically records images effectively without the [SCENE SELECTION] function.	
TWILIGHT* ()	Maintains the darkening atmosphere of the distant surroundings in twilight scenes.	
TWILIGHT PORT. ()	Enables to take photos of people and background using a flash. (HDR-XR200/XR200V)	
CANDLE ()	Maintains the dim atmosphere of a candlelit scene.	
SUNRISE&SUNSET* ()	Reproduces the atmosphere of scenes such as sunsets or sunrises.	
FIREWORKS* ()	Takes spectacular shots of fireworks.	
LANDSCAPE* ()	Shoots distant subjects clearly. This setting also prevents your camcorder from focusing on glass or metal mesh in windows between the camcorder and the subject.	
PORTRAIT (Soft portrait) ()	Brings out the subject such as people or flowers while creating a soft background.	
SPOTLIGHT** ()	Prevents people's faces from appearing excessively white when subjects are lit by strong light.	
BEACH** ()	Takes the vivid blue of the ocean or a lake.	
SNOW** ()	Takes bright pictures of a white landscape.	

* Adjusted to focus on subjects farther away only.

** Adjusted not to focus on subjects a short distance away.





⚡ Notes

- If you set [SCENE SELECTION], [WHITE BAL.] setting is canceled.
- Even if you set [TWILIGHT PORT.] while the  (Photo) lamp is lit, the setting changes to [AUTO] once the  (Movie) lamp lights up.





WHITE BAL. (White balance)

You can adjust the color balance to the brightness of the recording environment.





Steps

In recording mode,  (OPTION) →  → [WHITE BAL.] → a desired setting →  → 



▶ AUTO	The white balance is adjusted automatically.
OUTDOOR 	The white balance is appropriately adjusted for the following recording conditions: <ul style="list-style-type: none">– Outdoors– Night views, neon signs and fireworks– Sunrise or sunset– Under daylight fluorescent lamps
INDOOR 	The white balance is appropriately adjusted for the following recording conditions: <ul style="list-style-type: none">– Indoors– At party scenes or studios where the lighting conditions change quickly– Under video lamps in a studio, or under sodium lamps or incandescent-like color lamps
ONE PUSH 	The white balance will be adjusted according to the ambient light. <ol style="list-style-type: none">① Touch [ONE PUSH].② Frame a white object such as a piece of paper, to fill the screen under the same lighting conditions as you will shoot the subject.③ Touch .  flashes quickly. When the white balance has been adjusted and stored in the memory, the indicator stops flashing.

⚡ Notes

- Set [WHITE BAL.] to [AUTO] or adjust the color in [ONE PUSH] under white or cool white fluorescent lamps.
- When you select [ONE PUSH], keep framing white objects while  is flashing quickly.
-  flashes slowly if [ONE PUSH] could not be set.
- When [ONE PUSH] was selected, if  keeps flashing after touching , set [WHITE BAL.] to [AUTO].
- If you set [WHITE BAL.], [SCENE SELECTION] is set to [AUTO].





Tips



- If you have changed the battery pack while [AUTO] was selected, or taken your camcorder outdoors after inside use (or vice versa), select [AUTO] and aim your camcorder at a nearby white object for about 10 seconds for better color balance adjustment.
- When the white balance is set by [ONE PUSH], if the ambient lighting, etc., changes because you moved your camcorder to or from outdoors, etc., you need to redo the [ONE PUSH] procedure to readjust the white balance.

FADER

You can record a transition with the following effects adding to the interval between scenes. Select the desired effect in [STBY] (to fading in) or [REC] (to fading out) mode.

Steps

In recording mode,  (OPTION) →  → [FADER] → a desired setting →  → 

▶ OFF	Does not use an effect.	
WHITE FADER	Fades in/out with the white effect.	
BLACK FADER	Fades in/out with the black effect.	

To cancel the fader before starting the operation, touch [OFF].





Tips



- When you press START/STOP, the setting is cleared.

BLT-IN ZOOM MIC (Built-in zoom microphone)

You can record a movie with directional sound as you zoom in or out.

Steps





In recording mode,  (OPTION) →  → [BLT-IN ZOOM MIC] → a desired setting →  → 

▶ OFF	The microphone does not record sound following zooming in or out.	
ON 	The microphone records sound following zooming in or out.	

MICREF LEVEL (Microphone reference level)

You can select the microphone level for recording sound.

Steps





In recording mode,  (OPTION) →  → [MICREF LEVEL] → a desired setting →  → 

▶ NORMAL	Records various ambient sounds, converting them into the appropriate level.
LOW 	Records ambient sound faithfully. Select [LOW] when you want to record an exciting and powerful sound in a concert hall, etc. (This setting is not suitable for recording conversations.)

SELF-TIMER

Press PHOTO to start the count down. A photo is recorded after about 10 seconds.

Steps

In recording mode,  (OPTION) →  → [SELF-TIMER] → a desired setting →  → 

▶ OFF	Cancels the self-timer.
ON 	Starts the self-timer recording. To cancel the recording, touch [RESET].

Tips

- You can also operate by pressing PHOTO on the Wireless Remote Commander (p. 9) (HDR-XR200/XR200V).

? Troubleshooting

If you run into any problems using your camcorder, use the following list to troubleshoot the problem. If the problem persists, disconnect the power source and contact your Sony dealer.

- Overall operations/Easy Handycam operation/Wireless Remote Commander p. 106
- Batteries/power sources p. 107
- LCD screen p. 108
- “Memory Stick PRO Duo” media p. 108
- Recording..... p. 108
- Playback p. 110
- Playing back images stored on “Memory Stick PRO Duo” media on other devices..... p. 111
- Editing movies/photos on your camcorder p. 111
- Playback on the TV p. 111
- Dubbing/Connecting to other devices..... p. 112
- GPS p. 112
- Functions that cannot be used simultaneously p. 112

Notes before sending your camcorder for repair

- Your camcorder may be required to initialize or change the current hard disk of your camcorder, depending on the problem. In the event of this, the data stored on the hard disk will be deleted. Be sure to save the data on the internal hard disk on other media (backup) before sending your camcorder for repair (p. 66, see Operating Guide too). We will not compensate you for any loss of hard disk data.
- During repair, we may check a minimum amount of data stored on the hard disk in order to investigate the problem. However, your Sony dealer will neither copy nor retain your data.

Overall operations/Easy Handycam operation/Wireless Remote Commander

The power does not turn on.

- Attach a charged battery pack to the camcorder (p. 18).
- The plug of the AC Adaptor has been disconnected from the wall outlet (wall socket). Connect it to the wall outlet (wall socket) (p. 18).

The camcorder does not operate even when the power is set to on.

- It takes a few seconds for your camcorder to be ready to shoot after the power is turned on. This is not a malfunction.
- Disconnect the AC Adaptor from the wall outlet (wall socket) or remove the battery pack, then reconnect it after about 1 minute. If the functions still do not work, press the RESET button (p. 8) using a pointed object. (If you press the RESET button, all settings, including the clock setting, are reset.)
- The temperature of your camcorder is extremely high. Turn off your camcorder and leave it for a while in a cool place.
- The temperature of your camcorder is extremely low. Leave your camcorder with the power of your camcorder on. Turn off your camcorder and take it to a warm place. Leave the camcorder there for a while, then turn on your camcorder.

Buttons do not work.

- During Easy Handycam operation, the following buttons/functions are not available.
 - Playback zoom (p. 48)
 - To turn on and off the LCD backlight (p. 38)

The (OPTION) button is not displayed.

- The OPTION MENU cannot be used during Easy Handycam operation.

The menu settings have changed automatically.

- During Easy Handycam operation, nearly all the menu items will be automatically set to the default settings.
- Some menu items, such as [IMAGE SIZE], retain the settings that were made before Easy Handycam operation.
- During Easy Handycam operation, some menu items are fixed as follows.
 - [REC MODE]: [HD SP] or [SD SP]
 - [FRAME SETTING]: [ON]
 - [DATA CODE]: [DATE/TIME]
- Some menu items retain the setting made during Easy Handycam operation even after Easy Handycam operation is finished.
- The following menu items return to the default settings in more than 12 hours after you close the LCD screen.
 - [AUTO BACK LIGHT]
 - [DROP SENSOR]
 - [SPOT MTR/FCS]
 - [SPOT METER]
 - [SPOT FOCUS]
 - [EXPOSURE]
 - [FOCUS]
 - [SCENE SELECTION]
 - [WHITE BAL.]
 - [BLT-IN ZOOM MIC]
 - [MICREF LEVEL]

The camcorder gets warm.

- Your camcorder may become warm during operation. This is not a malfunction.

The supplied Wireless Remote Commander does not function (HDR-XR200/XR200V).

- Set [REMOTE CTRL] to [ON] (p. 97).
- Insert a battery into the battery holder with the +/- polarities correctly matching the +/- marks (p. 9).
- Remove any obstructions between the Wireless Remote Commander and the remote sensor.
- Point the remote sensor away from strong light sources such as direct sunlight or overhead lighting. Otherwise, the Wireless Remote Commander may not function properly.

Another DVD device malfunctions when you use the supplied Wireless Remote Commander (HDR-XR200/XR200V).

- Select a commander mode other than DVD 2 for your DVD device, or cover the sensor of your DVD device with black paper.

Batteries/power sources

The power abruptly turns off.

- Use the AC Adaptor.
- In the default setting, when about 5 minutes have elapsed while you do not operate your camcorder, the camcorder is automatically turned off (A.SHUT OFF). Change the setting of [A.SHUT OFF] (p. 97), or turn on the power again.
- Charge the battery pack (p. 18).

The charge lamp does not light while the battery pack is being charged.

- Close the LCD screen (p. 18).
- Attach the battery pack to the camcorder correctly (p. 18).
- Connect the power cord (mains lead) to the wall outlet (wall socket) properly.
- The battery charge is completed (p. 18).

The charge lamp flashes while the battery pack is being charged.

- Attach the battery pack to the camcorder correctly (p. 18). If the problem persists, disconnect the AC Adaptor from the wall outlet (wall socket) and contact your Sony dealer. The battery pack may be damaged.

The remaining battery time indicator does not indicate the correct time.

- The ambient temperature is too high or too low. This is not a malfunction.
- The battery pack has not been charged enough. Fully charge the battery again. If the problem persists, replace the battery pack with a new one (p. 127).
- The indicated time may not be correct depending on the environment of use.

The battery pack is quickly discharged.

- The ambient temperature is too high or low. This is not a malfunction.
- The battery pack has not been charged enough. Fully charge the battery again. If the problem persists, replace the battery pack with a new one (p. 127).

LCD screen

Menu items are grayed out.

- You cannot select grayed items in the current recording/playback situation.
- There are some functions you cannot activate simultaneously (p. 112).

The buttons do not appear on the touch panel.

- Touch the LCD screen lightly.
- Press DISP on your camcorder (or DISPLAY on the Wireless Remote Commander (HDR-XR200/XR200V) (p. 38).

The buttons on the touch panel do not work correctly or do not work at all.

- Adjust the touch panel ([CALIBRATION]) (p. 128).

"Memory Stick PRO Duo" media

Operations using the "Memory Stick PRO Duo" media cannot be performed.

- If you use "Memory Stick PRO Duo" media formatted on a computer, format it again on your camcorder (p. 71).

Images stored on the "Memory Stick PRO Duo" media cannot be deleted.

- The maximum number of images that you can delete on the index screen at one time is 100.
- You cannot delete the protected images.



The data file name is not indicated correctly or flashes.

- The file is damaged.
- The file format is not supported by your camcorder (p. 126).

Recording

Refer also to "Memory Stick PRO Duo" media (p. 108).

Pressing START/STOP or PHOTO does not record images.

- The playback screen is displayed. Press MODE to turn on the  (Movie) or  (Photo) lamp (p. 26).
- Your camcorder is recording the image you have just shot on the recording media. You cannot make new recording during this period.
- The recording media is full. Delete unnecessary images (p. 56).
- Total number of movie scenes or photos exceeds the recordable capacity of your camcorder (p. 117). Delete unnecessary images (p. 56).
- While [DROP SENSOR] is activated (p. 98), you may not record images.
- The temperature of your camcorder is extremely high. Turn off your camcorder and leave it for a while in a cool place.
- The temperature of your camcorder is extremely low. Turn off your camcorder and take it to a warm place. Leave the camcorder there for a while, then turn on the camcorder.

Photos cannot be recorded.

- You cannot record photos together with:
 - [SMTH SLW REC]
 - [FADER]

The ACCESS/access lamp remains lit or flashing even if recording was stopped.

- Your camcorder is recording the scene you have just shot on the recording media.

The imaging field looks different.

- The imaging field may look different depending on the condition of your camcorder. This is not a malfunction.
-

The flash does not work (HDR-XR200/XR200V).

- You cannot record with the flash when capturing photos while shooting a movie.
 - Even if auto flash or  (Auto redeye reduction) is selected, you cannot use the flash with:
 - NightShot
 - [SPOT MTR/FCS]
 - [MANUAL] in [EXPOSURE]
 - [SPOT METER]
 - [TWILIGHT], [CANDLE], [SUNRISE&SUNSET], [FIREWORKS], [LANDSCAPE], [SPOTLIGHT], [BEACH] or [SNOW] in [SCENE SELECTION]
-

The actual recording time for movies is less than the expected recording time of the recording media.

- Depending on the recording conditions, the time available for recording may be shorter, for example when recording a fast moving object, etc. (p. 117).
-

The camcorder stops operating.

- The temperature of your camcorder is extremely high. Turn off your camcorder and leave it for a while in a cool place.
 - The temperature of your camcorder is extremely low. Turn off your camcorder and take it to a warm place. Leave the camcorder there for a while, then turn on the camcorder.
 - If you keep applying vibration on the camcorder, recording may stop.
-

There is a time difference between the point when START/STOP is pressed and the point that the recording movie is started or stopped actually.

- On your camcorder, there may be a slight time difference between the point where you press START/STOP and the actual point that

recording movie starts/stops. This is not a malfunction.

The horizontal to vertical ratio of the movie (16:9 (wide)/4:3) cannot be changed.



- The horizontal to vertical ratio of high definition image quality (HD) movies is 16:9 (wide).
-

The auto focus does not function.





- Set [FOCUS] to [AUTO] (p. 101).
 - The recording conditions are not suitable for auto focus. Adjust the focus manually (p. 101).
-

SteadyShot does not function.

For HDR-XR100/XR101

- Set [STEADYSHOT] to [ON] (p. 76).
- Even if [STEADYSHOT] is set to [ON], your camcorder may not be able to compensate for excessive vibrations.

For HDR-XR200/XR200V

- Set [STEADYSHOT] to [ACTIVE] or [STANDARD], [STEADYSHOT] to [ON] (p. 76, 81).
 - Even if [STEADYSHOT] is set to [ACTIVE] or [STANDARD], or [STEADYSHOT] is set to [ON], your camcorder may not be able to compensate for excessive vibrations.
-

The subjects passing by the screen very fast appear crooked.

- This is called the focal plane phenomenon. This is not a malfunction. Because of the way the image device (CMOS sensor) reads out image signals, the subjects passing by the lens rapidly might appear crooked depending on the recording conditions.
-

The color of the image is not correctly displayed (HDR-XR200/XR200V).

- Press NIGHTSHOT (p. 36).
-

The screen image is bright, and the subject does not appear on the screen (HDR-XR200/XR200V).

- Press NIGHTSHOT (p. 36).

The screen image is dark, and the subject does not appear on the screen.

- Press and hold DISP down for a few seconds to turn on the backlight (p. 38).

Horizontal stripes appear on the images.

- This occurs when recording images under a fluorescent lamp, sodium lamp, or mercury lamp. This is not a malfunction.

Black bands appear when you record a TV screen or computer screen.

- Set [STEADYSHOT] to [OFF] (p. 76) (HDR-XR100/XR101).

[LCD BL LEVEL] cannot be adjusted.





- You cannot adjust [LCD BL LEVEL] when:
 - The LCD panel is closed on your camcorder with the LCD screen facing out.
 - The power is supplied from the AC Adaptor.

Sound is not recorded correctly (HDR-XR200/XR200V).

- If you disconnect an external microphone, etc. during recording movies, sound may not be recorded correctly.
- Connect the microphone again in the same way as when you start recording movies.

Playback

Images cannot be played back.

- Select the recording media you want to play back by touching  (HOME) →  (MANAGE MEDIA) → [MOVIE MEDIA SET]/[PHOTO MEDIA SET] (p. 69).
- Select the image quality of a movie you want to play back by touching  (HOME) →  (SETTINGS) → [VIEW IMAGES SET] → [HDMI/SD] SET (p. 86).



Photos cannot be played back.

- Photos cannot be played back if you have modified files or folders, or have edited the data on a computer. (The file name flashes in that case.) This is not a malfunction.
- Photos recorded on other devices may not be played back. This is not a malfunction.

 is indicated on an image on the VISUAL INDEX screen.

- This may appear on an image recorded on other devices, edited on a computer, etc.
- You removed the AC Adaptor or the battery pack before the ACCESS/access lamp is turned off after recording. This may damage your image data and  is displayed.

 is indicated on an image on the VISUAL INDEX screen.

- The image data base file may be damaged. Check the data base file by touching  (HOME) →  (MANAGE MEDIA) → [REPAIR IMG.DB F.] → the recording medium. If it still appears, delete the image with  (p. 56).

No sound or only a quiet sound is heard during playback.

- Turn up the volume (p. 42).
- Sound is not output when the LCD screen is closed. Open the LCD screen.
- When you record sound with [MICREF LEVEL] (p. 105) set to [LOW], the recorded sound may be difficult to hear.
- Sounds cannot be recorded while shooting an about-3-second movie using [SMTH SLW REC].

Left and right sound will be heard unbalanced when playing back movies on computers or other devices.

- This happens when sound recorded in 5.1ch surround is converted to 2ch (normal stereo sound) by a computer or other device. This is not a malfunction.

- Change the sound conversion type (downmix type) when playing back on 2ch stereo devices. Refer to the instruction manual supplied with your playback device for details.
- Change the sound to 2ch when creating a disc using the supplied software “PMB.”
- Record sound with [AUDIO MODE] set to [2ch STEREO] (p. 74).

The demonstration movies cannot be played.

- Select the internal hard disk for the recording media, and the high definition image quality (HD).
- The demonstration movie is deleted.

Playing back images stored on “Memory Stick PRO Duo” media on other devices

Images cannot be played back or “Memory Stick PRO Duo” media are not recognized.

- You cannot play back high definition image quality (HD) movies on “Memory Stick PRO Duo” media on a device that is not compatible with AVCHD format.

Editing movies/photos on your camcorder

Unable to edit.

- Unable to edit because of the condition of the image.

Movies cannot be added in the Playlist.

- There is no free space in the recording media.
- You can add no more than 999 high definition image quality (HD) movies, or 99 standard definition image quality (SD) movies, to a Playlist. Erase unnecessary movies from the Playlist (p. 65).
- You cannot add photos in the Playlist.

A movie cannot be divided.

- A movie that is too short cannot be divided.
- A protected movie cannot be divided.

A photo cannot be captured from a movie.

- The recording media where you want to save photos is full.

Playback on the TV

Neither image nor sound is played on the connected TV.

- When you are using the component A/V cable, set [COMPONENT] according to the requirements of the connected device (p. 92).
- When you are using the component video plug, make sure the red and white plugs of the A/V connecting cable are connected (p. 51, 52).
- Images are not output from the HDMI OUT jack, if copyright protection signals are recorded in the images.
- When you are using the S VIDEO plug, make sure the red and white plugs of the A/V connecting cable are connected (p. 52).

The image appears distorted on the 4:3 TV.

- This happens when viewing an image recorded in the 16:9 (wide) mode on a 4:3 TV. Set [TV TYPE] correctly (p. 91) and play back the image.

Black bands appear at the top and bottom of the screen of the 4:3 TV.

- This happens when viewing an image recorded in the 16:9 (wide) mode on a 4:3 TV. This is not a malfunction.

Dubbing/Connecting to other devices

Images are not dubbed correctly.

- You cannot dub images using the HDMI cable.
- The A/V connecting cable is not connected properly. Make sure to connect the cable to the input jack of another device (p. 66).

GPS

The camcorder is not receiving a GPS signal (HDR-XR200V).

- Your camcorder may not be able to receive radio signals from GPS satellites because of obstructions. Bring your camcorder to an open area, and set the GPS switch to ON again.

The current location on the map of the camcorder is different from the actual current location (HDR-XR200V).

- The margin of error of the radio signal from GPS satellites is large. The margin of error can be as wide as several-hundred meters at the maximum.

Functions that cannot be used simultaneously

The following list shows examples of unworkable combinations of functions and menu items.

Cannot use	Because of following settings
[FACE DETECTION]	[SMTH SLW REC], [DIGITAL ZOOM], [SPOT MTR/FCS], [SPOT METER], [SPOT FOCUS], [EXPOSURE], [FOCUS], [TWILIGHT], [TWILIGHT PORT.] (HDR-XR200/ XR200V), [CANDLE], [SUNRISE&SUNSET], [FIREWORKS], [LANDSCAPE], [SPOTLIGHT], [BEACH], [SNOW], [WHITE BAL.],
[DETECTION SET]	[SMTH SLW REC], [DIGITAL ZOOM], [FADER], [SELF-TIMER]
[SMILE SENSITIVITY]	[SMTH SLW REC], [DIGITAL ZOOM], [FADER], [SELF-TIMER]
[SMILE PRIORITY]	[SMTH SLW REC], [DIGITAL ZOOM], [FADER], [SELF-TIMER]
[FRAME SETTING]	[SMTH SLW REC]
[SCENE SELECTION]	[FADER], [TELE MACRO]

Self-diagnosis display/Warning indicators

If indicators appear on the LCD screen, check the following.

If the problem persists even after you have tried to fix a couple of times, contact your Sony dealer or local authorized Sony service facility.

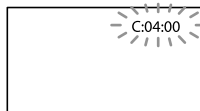

C: (or E:) □□:□□ (Self-diagnosis display)**C:04:□□**

- The battery pack is not an “InfoLITHIUM” battery pack (H series). Use an “InfoLITHIUM” battery pack (H series) (p. 126).
- Connect the DC plug of the AC Adaptor to the DC IN jack of your camcorder securely (p. 18).

C:13:□□ / C:32:□□

- Remove the power source. Reconnect it and operate your camcorder again.

E:20:□□ / E:31:□□ / E:61:□□ / E:62:□□ /**E:91:□□ / E:94:□□ / E:95:□□ / E:96:□□**

- A malfunction that you cannot service has occurred. Contact your Sony dealer or local authorized Sony service facility. Inform them of the 5-digit code, which starts from “E”.

101-0001 (Warning indicator pertaining to files)**Slow flashing**

- The file is damaged.
- The file is unreadable.

⊗ (Warning on the hard disk of the camcorder)**Fast flashing**

- The hard disk of the camcorder is full.
- An error may have occurred with the hard disk drive in your camcorder.

⊖ (Battery level warning)**Slow flashing**

- The battery pack is nearly used up.
- Depending on the operating environment or battery conditions, ⊖ may flash, even if there are about 20 minutes remaining.

⊠ (High temperature warning)**Slow flashing**

- The temperature of your camcorder is getting higher. Turn off your camcorder and leave it for a while in a cool place.

Fast flashing

- The temperature of your camcorder is extremely high. Turn off your camcorder and leave it for a while in a cool place.



⊠ (Low temperature warning)**Fast flashing**

- The temperature of your camcorder is extremely low. Make the camcorder warm.

⊠ (Warning indicator pertaining to “Memory Stick PRO Duo” media)**Slow flashing**

- Free spaces for recording images are running out. For the type of “Memory Stick” media you can use with your camcorder, see page 69.
- No “Memory Stick PRO Duo” media are inserted (p. 69).

Fast flashing



- There are not enough free spaces for recording images. After storing the images on other media (p. 66, see Operating Guide too), delete unnecessary images, or format the “Memory Stick PRO Duo” media (p. 71).
- The image data base file may be damaged. Check the data base file by touching  (HOME) →  (MANAGE MEDIA) → [REPAIR IMG.DB F.] → the recording medium.
- The “Memory Stick PRO Duo” media are damaged.

⊠ (Warning indicators pertaining to “Memory Stick PRO Duo” media formatting)

- The “Memory Stick PRO Duo” media are damaged.
- The “Memory Stick PRO Duo” media are not formatted correctly (p. 71).

⊠ (Warning indicator pertaining to incompatible “Memory Stick PRO Duo” media)

- Incompatible “Memory Stick PRO Duo” media are inserted (p. 69).

  (Warning indicator pertaining to the write-protect of the “Memory Stick PRO Duo” media)

- Access to the “Memory Stick PRO Duo” media was restricted on another device.

 (Warning indicator pertaining to the flash)

Fast flashing

- There is something wrong with the flash.

 (Warning indicator pertaining to camera-shake warning)

- The amount of lights is not sufficient, so camera-shake easily occurs. Use the flash.
- The camcorder is unsteady, so camera-shake easily occurs. Hold the camcorder steady with both hands and record the image. However, note that the camera-shake warning indicator does not disappear.

 (Warning indicator pertaining to drop sensor)

- The drop sensor function (p. 98) is activated, and has detected that the camcorder has been dropped. Therefore, the camcorder is taking steps to protect the hard disk. Recording/playback may be disabled as a result.
- The drop sensor function does not guarantee the protection of the hard disk under all possible situations. Use the camcorder under stable conditions.

 (Warning indicator pertaining to photo recording)

- The recording media is full.
- Photos cannot be recorded during processing. Wait for a while, then record.

 Tips

- You may hear a melody when some warning indicators appear on the screen.

Description of warning messages

If messages appear on the screen, follow the instructions.

Recording media

 HDD format error.

- The internal hard disk of the camcorder is set differently from the default format. Performing [MEDIA FORMAT] (p. 71) may enable you to use your camcorder. This will delete all data in the internal hard disk.

Data error.

- An error occurred during reading or writing the internal hard disk of the camcorder. This may occur when you keep applying shock on the camcorder.
- If the message is preceded by a GPS indicator, there may be some trouble with the GPS receiver. Turn on your camcorder again. (HDR-XR200V)

The Image Database File is damaged. Do you want to create a new file?
HD movie management information is damaged. Create new information?

- The image management file is damaged. When you touch [YES], a new image management file is created. The old recorded images on the media cannot be played back (Image files are not damaged). If you execute [REPAIR IMG. DB F.] after creating new information, playing back the old recorded images may become possible. If it does not work, copy the image using the supplied software.

Inconsistencies found in Image Database File. Do you want to repair the Image Database File?

The Image Database File is damaged. Do you want to repair the Image Database File?

Inconsistencies found in Image Database File. Cannot record or play HD movies. Do you want to repair the Image Database

File?

- The image management file is damaged, and you cannot record movies or photos. Touch [YES] to repair.
- You can record photos on “Memory Stick PRO Duo” media.

Buffer overflow

- You cannot record because the drop sensor senses a drop of the camcorder repeatedly. If you are at risk of dropping the camcorder constantly, set [DROP SENSOR] to [OFF], and you may be able to record the image again (p. 98).

Recovering data.

- Your camcorder tries to recover data automatically if the data writing was not performed properly.

Cannot recover data.

- Writing data onto the internal hard disk of the camcorder has failed. Attempts were made to recover the data, but they were unsuccessful.

Reinsert the Memory Stick.

- Reinsert the “Memory Stick PRO Duo” media a few times. If even then the indicator flashes, the “Memory Stick PRO Duo” media could be damaged. Try with other “Memory Stick PRO Duo” media.

This Memory Stick is not formatted correctly.

- Check the format, then format the “Memory Stick PRO Duo” media with your camcorder if necessary (p. 71).

Still picture folder is full. Cannot record still pictures.

- You cannot create folders exceeding 999MSDCF. You cannot create or delete created folders using your camcorder.
- Format the “Memory Stick PRO Duo” media (p. 71), or delete folders using your computer.

This Memory Stick may not be able to record or play movies.

- Use “Memory Stick” media recommended for your camcorder (p. 69).

This Memory Stick may not be able to record or play images correctly.

- Use the recommended “Memory Stick” media (p. 69).

Do not eject the Memory Stick during writing. Data may be damaged.

- Reinsert the “Memory Stick PRO Duo” media, and follow the instructions on the LCD screen.

Other

No further selection is possible.

- You can add no more than 999 high definition image quality (HD) movies, or 99 standard definition image quality (SD) movies, to a Playlist.
- You can select only 100 images at one time for:
 - Deleting movies/photos
 - Protecting movies/photos, or releasing the protection
 - Dubbing movies
 - Copying photos
 - Editing the playlist of high definition image quality (HD) movies

Data protected.

- You tried to delete protected data. Release the protection of the data.

Recording time of movies/number of recordable photos

“HD” stands for high definition image quality, and “SD” stands for standard image quality.

Expected time of recording and playback with each battery pack

Recording time

Approximate time available when you use a fully charged battery pack.

Internal hard disk

HDR-XR100/XR101

Battery pack	(unit: minute)			
	Continuous recording time		Typical recording time	
Image quality	HD	SD	HD	SD
NP-FH50	80	100	40	50
NP-FH60 (supplied)	105	130	50	65
NP-FH70	175	215	85	105
NP-FH100	395	485	195	240

HDR-XR200/XR200V

Battery pack	(unit: minute)			
	Continuous recording time		Typical recording time	
Image quality	HD	SD	HD	SD
NP-FH50	75	90	35	45
NP-FH60 (supplied)	100	125	50	60
NP-FH70	165	200	80	100
NP-FH100	375	455	185	225

“Memory Stick PRO Duo”

HDR-XR100/XR101

Battery pack	(unit: minute)			
	Continuous recording time		Typical recording time	
Image quality	HD	SD	HD	SD
NP-FH50	85	100	40	50
NP-FH60 (supplied)	115	135	55	65
NP-FH70	190	220	95	110
NP-FH100	430	500	215	250

HDR-XR200/XR200V

Battery pack	(unit: minute)			
	Continuous recording time		Typical recording time	
Image quality	HD	SD	HD	SD
NP-FH50	80	100	40	50
NP-FH60 (supplied)	110	135	55	65
NP-FH70	180	220	90	110
NP-FH100	405	500	200	250

- Each recording time is measured under the following condition:
 - [REC MODE]: SP
 - When the LCD backlight turns on
- Typical recording time shows the time when you repeat recording start/stop, switching the MODE lamp, and zooming.
- Times measured when using the camcorder at 25 °C (77 °F) (10 °C to 30 °C (50 °F to 86 °F) is recommended).
- The recording and playback time will be shorter when you use your camcorder in low temperatures.
- The recording and playback time will be shorter depending on the conditions under which you use your camcorder.

Playing time

Approximate time available when you use a fully charged battery pack.

Battery pack	(unit: minute)			
	HDR-XR100/XR101		HDR-XR200/ XR200V	
Image quality	HD	SD	HD	SD
NP-FH50	115	130	105	115
	130	145	125	145
NP-FH60 (supplied)	150	170	140	150
	170	195	165	195
NP-FH70	245	280	230	245
	280	315	270	315
NP-FH100	555	625	515	555
	625	710	600	710

- Top: Internal hard disk
- Bottom: "Memory Stick PRO Duo" media

Expected recording time of movies

Internal hard disk

High definition image quality (HD)

HDR-XR100/XR101

Recording mode	(unit: hour minute)	
	Recording time	
[HD FH]	9 h 40 m	
[HD HQ]	19 h 40 m	
[HD SP]	24 h 0 m	
[HD LP] (5.1ch)*	32 h 0 m	
[HD LP] (2ch)*	33 h 30 m	

HDR-XR200

Recording mode	(unit: hour minute)	
	Recording time	
[HD FH]	14 h 30 m	
[HD HQ]	29 h 40 m	
[HD SP]	36 h 0 m	
[HD LP] (5.1ch)*	48 h 10 m	
[HD LP] (2ch)*	50 h 30 m	

HDR-XR200V

Recording mode	(unit: hour minute)	
	Recording time	
[HD FH]	14 h 30 m	
[HD HQ]	29 h 30 m	
[HD SP]	35 h 50 m	
[HD LP] (5.1ch)*	47 h 50 m	
[HD LP] (2ch)*	50 h 10 m	

Standard definition image quality (SD)

HDR-XR100/XR101

Recording mode	(unit: hour minute)	
	Recording time	
[SD HQ]	19 h 40 m	
[SD SP]	29 h 10 m	
[SD LP] (5.1ch)*	56 h 0 m	
[SD LP] (2ch)*	61 h 0 m	

HDR-XR200

Recording mode	(unit: hour minute)	
	Recording time	
[SD HQ]	29 h 40 m	
[SD SP]	43 h 50 m	
[SD LP] (5.1ch)*	84 h 10 m	
[SD LP] (2ch)*	91 h 50 m	

HDR-XR200V

Recording mode	(unit: hour minute)	
	Recording time	
[SD HQ]	29 h 30 m	
[SD SP]	43 h 40 m	
[SD LP] (5.1ch)*	83 h 40 m	
[SD LP] (2ch)*	91 h 20 m	

- * You can change the recording sound format with [AUDIO MODE] (p. 74).

Tips

- You can record movies of a maximum of 3,999 scenes with high definition image quality (HD), and 9,999 scenes with standard definition image quality (SD).
- The maximum continuous recording time of movies is approximately 13 hours.

- Your camcorder uses the VBR (Variable Bit Rate) format to automatically adjust image quality to suit the recording scene. This technology causes fluctuations in the recording time of the media. Movies containing quickly moving and complex images are recorded at a higher bit rate, and this reduces the overall recording time.

“Memory Stick PRO Duo” media

High definition image quality (HD)

(unit: minute)

	AVC HD 16M (FH)	AVC HD 9M (HQ)	AVC HD 7M (SP)	AVC HD 5M (LP) 5.1ch*	AVC HD 5M (LP) 2ch*
1GB	6 (6)	10 (9)	15 (10)	20 (15)	20 (15)
2GB	10 (10)	25 (20)	30 (20)	45 (35)	45 (35)
4GB	25 (25)	55 (35)	65 (45)	90 (70)	95 (70)
8GB	55 (55)	115 (80)	140 (100)	185 (145)	195 (150)
16GB	110 (110)	230 (160)	280 (200)	375 (290)	390 (300)

Standard definition image quality (SD)

(unit: minute)

	SD 9M (HQ)	SD 6M (SP)	SD 3M (LP) 5.1ch*	SD 3M (LP) 2ch*
1GB	10 (10)	20 (10)	35 (25)	40 (25)
2GB	25 (25)	40 (25)	80 (50)	85 (55)
4GB	55 (50)	80 (50)	160 (105)	170 (110)
8GB	115 (100)	170 (100)	325 (215)	355 (230)
16GB	230 (205)	340 (205)	655 (435)	715 (460)

- * You can change the recording sound format with [AUDIO MODE] (p. 74).

⚡ Notes

- Numbers in the table are based on using Sony “Memory Stick PRO Duo” media.
- The recordable time may vary depending on the recording and subject conditions, [REC MODE] (p. 73), and the type of “Memory Stick” media.
- The number in () is the minimum recordable time.

Expected number of recordable photos

Internal hard disk

You can record the maximum 9,999 photos.

“Memory Stick PRO Duo” media

	4.0M 2304 × 1728 4.0M
1GB	470
2GB	970
4GB	1850
8GB	3850
16GB	7700

- The selected image size is effective when the  (Photo) lamp is lit.
- The number of recordable photos shown is for the maximum image size of your camcorder. The actual number of recordable photos is displayed on the LCD screen during recording (p. 10).

⚡ Notes

- Numbers in the table are based on using Sony “Memory Stick PRO Duo” media. The number of recordable photos may vary depending on the recording conditions, and the type of “Memory Stick” media.
- The unique pixel array of Sony’s ClearVid and the image processing system (BIONZ) allow still image resolution equivalent to the sizes described.

💡 Tips

- You can also use “Memory Stick Duo” media with a capacity of under 1 GB for recording photos.

Using your camcorder abroad

Power supply

You can use your camcorder in any countries/regions using the AC Adaptor supplied with your camcorder within the AC 100 V to 240 V, 50 Hz/60 Hz range.

Viewing high definition image quality (HD) movies

In countries/regions where 1080/60i is supported, you can view the movies with the same high definition image quality (HD) as that of the recorded movies.

You need an NTSC-system-based and 1080/60i compatible TV (or monitor) with component and AUDIO/VIDEO input jacks. A component A/V cable or an HDMI cable (sold separately) must be connected.

Viewing standard definition image quality (SD) movies

To view standard definition image quality (SD) movies, you need an NTSC-system-based TV with AUDIO/VIDEO input jacks. An A/V connecting cable must be connected.

On TV color systems

Your camcorder is an NTSC-system-based camcorder. If you want to view the playback image on a TV, it must be an NTSC-system-based TV with an AUDIO/VIDEO input jack.

System	Used in
NTSC	Bahama Islands, Bolivia, Canada, Central America, Chile, Colombia, Ecuador, Guyana, Jamaica, Japan, Korea, Mexico, Peru, Surinam, Taiwan, the Philippines, the USA, Venezuela, etc.
PAL	Australia, Austria, Belgium, China, Czech Republic, Denmark, Finland, Germany, Holland, Hong Kong, Hungary, Italy, Kuwait, Malaysia, New Zealand, Norway, Poland, Portugal, Singapore, Slovak Republic, Spain, Sweden, Switzerland, Thailand, United Kingdom, etc.
PAL – M	Brazil
PAL – N	Argentina, Paraguay, Uruguay.
SECAM	Bulgaria, France, Guiana, Iran, Iraq, Monaco, Russia, Ukraine, etc.

File/folder structure on the internal hard disk and “Memory Stick PRO Duo” media

The file/folder structure is shown below. You do not usually need to acknowledge the file/folder structure, when recording/playing back movies and photos on the camcorder. To enjoy movies or photos by connecting your camcorder to a computer, see “PMB Guide” then use the supplied application.

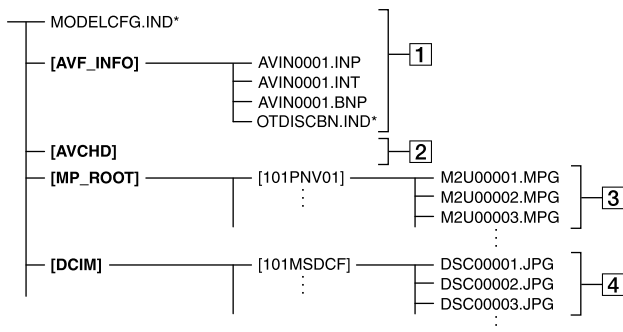

* Only for the internal hard disk

1 Image management files

When you delete the files, you cannot record/play back the images correctly. The files are defaulted as hidden files and not usually displayed.

2 HD movie management information folder

This folder contains recording data of high definition image quality (HD) movies. Do not try to open this folder or access the contents of this folder from a computer. Doing so might damage image files, or prevent image files from being played back.

3 SD movie files (MPEG2 files)

The extension of the files is “.MPG”. The maximum size is 2 GB. When the capacity of a file exceeds 2 GB, the file becomes divided.

The file numbers go up automatically.

When the capacity of a file number exceeds 9999, another folder is created to record new movie files.

The folder name goes up: [101PNV01] → [102PNV01]

4 Photo files (JPEG files)

The extension of the files is “.JPG”. The file numbers go up automatically. When the capacity of a file number exceeds 9999, another folder is created to store new photo files.

The folder name goes up: [101MSDCF] → [102MSDCF]

- By setting (HOME) → (OTHERS) → [USB CONNECT] → [USB CONNECT]/ [USB CONNECT], you can access the recording media from the computer through USB connection.

- Do not modify the files or folders on the camcorder from the computer. The image files may be destroyed or may not be played back.
- Operation is not guaranteed, if you perform the above operation.
- When you delete image files, follow the steps on page 56. Do not delete the image files on the camcorder directly from the computer.
- Do not format the recording media using a computer. The camcorder may not operate correctly.
- Do not copy the files on the recording media from the computer. Operation is not guaranteed.

Maintenance and precautions

About the AVCHD format

What is the AVCHD format?

The AVCHD format is a high definition digital video camera format used to record a high definition (HD) signal of either the 1080i specification*¹ or the 720p specification*² on internal hard disk drive, using efficient data compression coding technology. The MPEG-4 AVC/H.264 format is adopted to compress video data, and the Dolby Digital or Linear PCM system is used to compress audio data. The MPEG-4 AVC/H.264 format is capable of compressing images at higher efficiency than that of the conventional image compressing format. The MPEG-4 AVC/H.264 format enables a high definition video signal shot on a digital video camera recorder to be recorded on 8 cm DVD discs, internal hard disk drive, flash memory, “Memory Stick PRO Duo” media, etc.

Recording and playback on your camcorder

Based on the AVCHD format, your camcorder records with the high definition image quality (HD) mentioned below. In addition to high definition image quality (HD), your camcorder is capable of recording a standard definition (SD) signal in the conventional MPEG2 format.

Video signal*³: MPEG-4 AVC/H.264 1920 × 1080/60i, 1440 × 1080/60i

Audio signal: Dolby Digital 5.1/2ch

Recording media: Internal hard disk drive, “Memory Stick PRO Duo” media

^{*1} 1080i specification

A high definition specification which utilizes 1,080 effective scanning lines and the interlace system.

^{*2} 720p specification

A high definition specification which utilizes 720 effective scanning lines and the progressive system.

^{*3} Data recorded in AVCHD format other than the above mentioned cannot be played on your camcorder.

– Between tall buildings or at narrow streets surrounded by buildings.

– In underground locations, locations surrounded by dense trees, under an elevated bridge, or in locations where magnetic fields are generated, such as near high voltage cables.

– Near devices that generate radio signals of the same frequency band as the camcorder: near 1.5 GHz band mobile telephones, etc.

About GPS (HDR-XR200V)

• The GPS (Global Positioning System) is a system that calculates geographical location from highly accurate US space satellites. This system allows you to pinpoint your exact location on the earth. The GPS satellites are located in 6 orbits, 20,000 km above the earth. The GPS system consists of 24 or more GPS satellites. A GPS receiver receives radio signals from the satellites, and calculates the current location of the receiver based on the orbital information (almanac data) and travel time of the signals, etc.

Determining a location is called “triangulating.” A GPS receiver can determine the location’s latitude and longitude by receiving signals from 3 or more satellites.

- As the positions of GPS satellites vary constantly, it may take longer to determine the location or the receiver may not be able to determine the location at all, depending on the location and time you use the camcorder.
- “GPS” is a system for determining geographic location by triangulating radio signals from GPS satellites. Avoid using the camcorder in places where radio signals are blocked or reflected, such as a shadowy place surrounded by buildings or trees, etc. Use the camcorder in open sky environments.
- You may not be able to record location information at locations or in situations where radio signals from the GPS satellites do not reach the camcorder as follows.
 - In tunnels, indoors or under the shade of buildings.

On triangulating errors

- If you move to another location right after setting the GPS switch to ON, it may take a longer time for the camcorder to start triangulating, compared to when you stay in the same place.
- Error caused by the position of GPS satellites
The camcorder automatically triangulates your current location when the camcorder receives radio signals from 3 or more GPS satellites. The triangulating error allowed by the GPS satellites is about 30 m (98 feet). Depending on the environment of the location, the triangulating error can be greater. In this case, your actual location may not match the location on the map based on the GPS information. Meanwhile, the GPS satellites are controlled by the United States Department of Defense, and the degree of accuracy may be changed intentionally.
- Error during the triangulating process
The camcorder acquires location information every 10 seconds during triangulating. There is a slight time difference between when the location information is acquired and when the location information is recorded on an image, therefore, the actual recording location may not match exactly the location on the map based on the GPS information.

On the restriction of use of GPS on an airplane

- During take off and landing of an airplane, set the GPS switch to OFF and turn off the camcorder, as you will be instructed to do by the on-board announcement. In other cases, use GPS in accordance with the regulations of the place or situation.

On the map data

- The camcorder contains map data for the following countries/regions.
Europe, Japan, North America, Oceania, etc.
- Built-in map is powered by companies as follows; Map of Japan by Zenrin Co., Ltd., other areas by NAVTEQ.
- The map data included is as of the date of production of this manual.
- GPS maps will appear in 2-dimensional graphics except for certain landmarks in Japan, which will appear in 3D.
- You cannot change the language on the map.
- You cannot update the map data.
- The scale of the map is 100 feet to 6,000 miles.

On the geographic coordinate system

- The “WGS-84” geographic coordinate system is used.

On copyright

- The map data of the camcorder is copyrighted. Unauthorized copying or other usage of the map data may be contrary to the copyright laws.

On the navigation function

- The camcorder does not have a navigation function that uses GPS.

Australia

Copyright. Based on data provided under license from PSMA Australia Limited (www.psm.com.au).

Austria

© Bundesamt für Eich- und Vermessungswesen

Croatia, Estonia, Latvia, Lithuania,

Poland and Slovenia

© EuroGeographics

France

source: Géoroute® IGN France & BD Carto®
IGN France

Germany

Die Grundlagendaten wurden mit Genehmigung der zuständigen Behörden entnommen.

Great Britain

Based upon Crown Copyright material.

Greece

© EuroGeographics; Copyright Geomatics Ltd.

Hungary

Copyright © 2003; Top-Map Ltd.

Italy

La Banca Dati Italiana è stata prodotta usando quale riferimento anche cartografia numerica ed al tratto prodotta e fornita dalla Regione Toscana.

Japan

- 日本の地図の作成にあたっては、国土地理院長の承認を得て、同院発行の2万5千分の1地形図を使用しています。(承認番号 平20業使、第204-46号)
- 日本の地図の作成にあたっては、国土地理院長の承認を得て、同院の技術資料H-1-No.3「日本測地系における離島位置の補正量」を使用しています。(承認番号 国地企調発第78号 平成16年4月23日)

Norway

Copyright © 2000; Norwegian Mapping Authority

Portugal

Source: IgeoE – Portugal

Spain

Información geográfica propiedad del CNIG

Sweden

Based upon electronic data © National Land Survey Sweden.

Switzerland

Topografische Grundlage: © Bundesamt für Landestopographie.

About “Memory Stick” media

“Memory Stick” media are compact, portable IC recording media with a large data capacity.

You can use only “Memory Stick Duo” media, which are about the half size of standard “Memory Stick” media, with your camcorder.

However, we do not guarantee the operation of all types of “Memory Stick Duo” media on your camcorder.

Types of “Memory Stick” media	Recording/Playback
“Memory Stick Duo” media (with MagicGate)	—

Types of "Memory Stick" media	Recording/Playback
"Memory Stick PRO Duo" media	○
"Memory Stick PRO-HG Duo" media	○*

- * This product does not support 8-bit parallel data transfer but it supports 4-bit parallel data transfer the same as with "Memory Stick PRO Duo" media.
- This product cannot record or play data that uses "MagicGate" technology. "MagicGate" is a copyright protection technology that records and transfers the contents in an encrypted format.
- "Memory Stick PRO Duo" media formatted by a computer (Windows OS/Mac OS) do not have guaranteed compatibility with your camcorder.
- Data read/write speed may vary depending on the combination of the "Memory Stick PRO Duo" media and "Memory Stick PRO Duo" media compliant product you use.
- Damaged or lost data may occur in the following cases (the data will not be compensated for):
 - If you eject the "Memory Stick PRO Duo" media, or turn off your camcorder while your camcorder is reading or writing image files on the "Memory Stick PRO Duo" media (while the ACCESS/access lamp is lit or flashing)
 - If you use the "Memory Stick PRO Duo" media near magnets or magnetic fields
- It is recommended that you make a back-up of important data on the hard disk of a computer.
- Be careful not to apply excessive force when writing a memo area on "Memory Stick PRO Duo" media.
- Do not attach a label or the like on "Memory Stick PRO Duo" media or a "Memory Stick Duo" media adaptor.
- When you carry or store "Memory Stick PRO Duo" media, put it in its case.
- Do not touch, or allow metallic objects to come into contact with the terminals.
- Do not bend, drop or apply strong force to "Memory Stick PRO Duo" media.
- Do not disassemble or modify "Memory Stick PRO Duo" media.

- Do not let "Memory Stick PRO Duo" media get wet.
- Keep "Memory Stick PRO Duo" media out of the reach of small children. There is danger that a child might swallow it.
- Do not insert anything other than "Memory Stick PRO Duo" media into the "Memory Stick Duo" media slot. Doing so may cause a malfunction.
- Do not use or keep "Memory Stick PRO Duo" media in the following locations:
 - Places subject to extremely high temperature, such as a car parked outside in the summer
 - Places under direct sunlight
 - Places with extremely high humidity or subject to corrosive gases

On the "Memory Stick Duo" media adaptor

- When using "Memory Stick PRO Duo" media with a "Memory Stick" media compliant device, be sure to insert the "Memory Stick PRO Duo" media into a "Memory Stick Duo" media adaptor.
- When inserting "Memory Stick PRO Duo" media into a "Memory Stick Duo" media adaptor, make sure "Memory Stick PRO Duo" media are inserted facing in the correct direction, then insert "Memory Stick PRO Duo" media all the way in. Note that improper use may cause a malfunction.
- When using "Memory Stick PRO Duo" media inserted into a "Memory Stick Duo" media adaptor on a "Memory Stick" media compliant device, make sure the "Memory Stick PRO Duo" media adaptor is inserted into the device in the correct direction. If inserted in the wrong direction, the device may be damaged.
- Do not insert a "Memory Stick Duo" media adaptor without "Memory Stick PRO Duo" media attached into a "Memory Stick" media compliant device. Doing so may result in malfunctions of the device.

On "Memory Stick PRO Duo" media

- The maximum memory capacity of "Memory Stick PRO Duo" media that can be used with your camcorder is 16 GB.

On image data compatibility

- Image data files recorded on “Memory Stick PRO Duo” media by your camcorder conform to the “Design rule for Camera File system” universal standard established by the JEITA (Japan Electronics and Information Technology Industries Association).
- On your camcorder, you cannot play back photos recorded on other devices (DCR-TRV900 or DSC-D700/D770) that do not conform to the universal standard. (These models are not sold in some regions.)
- If you cannot use “Memory Stick PRO Duo” media that have been used with another device, format “Memory Stick PRO Duo” media with your camcorder (p. 71). Note that formatting erases all information on the “Memory Stick PRO Duo” media.
- You may not be able to play back images with your camcorder:
 - When playing back image data modified on your computer
 - When playing back image data recorded with other devices

off. If you charge the battery pack outside of this temperature range, you may not be able to charge it efficiently.

To use the battery pack effectively

- Battery pack performance decreases when the ambient temperature is 10 °C (50 °F) or below, and the length of time you can use the battery pack becomes shorter. In that case, do one of the following to use the battery pack for a longer time.
 - Put the battery pack in a pocket to warm it up, and install it on your camcorder right before you start taking shots.
 - Use a large capacity battery pack: NP-FH70/FH100 (sold separately).
- Frequent use of the LCD screen or a frequent playback, fast forward or reverse operation wears out the battery pack faster. We recommend using a large capacity battery pack: NP-FH70/FH100 (sold separately).
- Be sure to close the LCD screen when not recording or playing back on your camcorder. The battery pack is also consumed when your camcorder is in recording standby or playback pause.
- Have spare battery packs ready for 2 or 3 times the expected recording time, and make trial recordings before making the actual recording.
- Do not expose the battery pack to water. The battery pack is not water resistant.

About the “InfoLITHIUM” battery pack

Your camcorder operates only with an “InfoLITHIUM” battery pack (H series). “InfoLITHIUM” H series battery packs have the  mark.

What is an “InfoLITHIUM” battery pack?

- An “InfoLITHIUM” battery pack is a lithium-ion battery pack that has functions for communicating information related to operating conditions between your camcorder and an AC Adaptor/charger (sold separately).
- The “InfoLITHIUM” battery pack calculates the power consumption according to the operating conditions of your camcorder, and displays the remaining battery time in minutes.



To charge the battery pack

- Be sure to charge the battery pack before you start using your camcorder.
- We recommend charging the battery pack in an ambient temperature of between 10 °C to 30 °C (50 °F to 86 °F) until the charge lamp turns

About the remaining battery time indicator

- When the power goes off even though the remaining battery time indicator indicates that the battery pack has enough power to operate, charge the battery pack fully again. Remaining battery time will be indicated correctly. Note, however, that the battery indication will not be restored if it is used in high temperatures for a long time, or if left in a fully charged state, or when the battery pack is frequently used. Use the remaining battery time indication as a rough guide only.
- The  mark that indicates low battery flashes even if there are still 20 minutes of battery time remaining, depending on the operating conditions or ambient temperature.

About storage of the battery pack

- If the battery pack is not used for a long time, fully charge the battery pack and use it up on your camcorder once a year to maintain proper function. To store the battery pack, remove it from your camcorder and put it in a dry, cool place.
- To discharge the battery pack on your camcorder completely, touch  (HOME) →  (SETTINGS) → [GENERAL SET] → [A.SHUT OFF] → [NEVER], and leave your camcorder in recording standby until the power goes off (p. 97).

About battery life

- Battery capacity decreases over time and through repeated use. If decreased usage time between charges becomes significant, it is probably time to replace it with a new one.
- Each battery's life is governed by storage, operating and environmental conditions.

About x.v.Color

- x.v.Color is a more familiar term for the xvYCC standard proposed by Sony, and is a trademark of Sony.
- xvYCC is an international standard for color space in video. This standard can express a wider color range than the currently used broadcast standard.

About handling of your camcorder

On use and care

- Do not use or store the camcorder and accessories in the following locations:
 - Anywhere extremely hot, cold or humid. Never leave them exposed to temperatures above 60 °C (140 °F), such as under direct sunlight, near heaters or in a car parked in the sun. They may malfunction or become deformed.
 - Near strong magnetic fields or mechanical vibration. The camcorder may malfunction.
 - Near strong radio waves or radiation. The camcorder may not be able to record properly.
 - Near AM receivers and video equipment. Noise may occur.
 - On a sandy beach or anywhere dusty. If sand or dust gets in your camcorder, it may malfunction. Sometimes this malfunction cannot be repaired.
- Near windows or outdoors, where the LCD screen, or the lens may be exposed to direct sunlight. This damages the LCD screen.
- Operate your camcorder on DC 6.8 V/7.2 V (battery pack) or DC 8.4 V (AC Adaptor).
- For DC or AC operation, use the accessories recommended in these operating instructions.
- Do not let your camcorder get wet, for example, from rain or sea water. If your camcorder gets wet, it may malfunction. Sometimes this malfunction cannot be repaired.
- If any solid object or liquid gets inside the casing, unplug your camcorder and have it checked by a Sony dealer before operating it any further.
- Avoid rough handling, disassembling, modifying, physical shock, or impact such as hammering, dropping or stepping on the product. Be particularly careful of the lens.
- Keep the LCD screen closed when you are not using your camcorder.
- Do not wrap your camcorder with a towel, for example, and operate it. Doing so might cause heat to build up inside.
- When disconnecting the power cord (mains lead), pull it by the plug and not the cord (lead) (mains lead).
- Do not damage the power cord (mains lead) such as by placing anything heavy on it.
- Do not use a deformed or damaged battery pack.
- Keep metal contacts clean.
- Keep the Wireless Remote Commander and button-type battery out of children's reach. If the battery is accidentally swallowed, consult a doctor immediately.
- If the battery electrolytic liquid has leaked:
 - Consult your local authorized Sony service facility.
 - Wash off any liquid that may have contacted your skin.
 - If any liquid gets in your eyes, wash with plenty of water and consult a doctor.

When not using your camcorder for a long time

- To keep your camcorder in optimum state for a long time, turn it on and let it run by recording

and playing back images about once a month.

- Use up the battery pack completely before storing it.

Moisture condensation

If your camcorder is brought directly from a cold place to a warm place, moisture may condense inside your camcorder. This may cause a malfunction to your camcorder.

- If moisture condensation has occurred
Leave your camcorder for about 1 hour without turning it on.
- Note on moisture condensation
Moisture may condense when you bring your camcorder from a cold place into a warm place (or vice versa) or when you use your camcorder in a humid place as follows:
 - You bring your camcorder from a ski slope into a place warmed up by a heating device.
 - You bring your camcorder from an air conditioned car or room into a hot place outside.
 - You use your camcorder after a squall or a shower.
 - You use your camcorder in a hot and humid place.
- How to prevent moisture condensation
When you bring your camcorder from a cold place into a warm place, put your camcorder in a plastic bag and seal it tightly. Remove the bag when the air temperature inside the plastic bag has reached the surrounding temperature (after about 1 hour).

LCD screen

- Do not exert excessive pressure on the LCD screen, as it may cause uneven color and other damage.
- If your camcorder is used in a cold place, a residual image may appear on the LCD screen. This is not a malfunction.
- While using your camcorder, the back of the LCD screen may heat up. This is not a malfunction.

To clean the LCD screen

- If fingerprints or dust make the LCD screen dirty, it is recommended that you use a soft cloth to clean it.
- When you use the LCD Cleaning Kit (sold separately), do not apply the cleaning liquid

directly to the LCD screen. Use cleaning paper moistened with the liquid.

On adjustment of the touch panel (CALIBRATION)

The buttons on the touch panel may not work correctly. If this happens, follow the procedure below. It is recommended that you connect your camcorder to the wall outlet (wall socket) using the supplied AC Adaptor during the operation.

- ① Touch **HOME** → **SETTINGS** → [GENERAL SET] → [CALIBRATION].

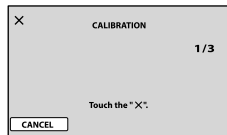

- ② Touch "X" displayed on the screen with the corner of "Memory Stick PRO Duo" media or the like 3 times.
Touch [CANCEL] to cancel calibration.

Notes

- If you did not press the right spot, try the calibration again.
- Do not use a sharp-pointed object for calibration. Doing so may damage the LCD screen.
- You cannot calibrate the LCD screen if it is rotated, or closed with the screen facing out.

On handling the casing

- If the casing is soiled, clean the camcorder body with a soft cloth lightly moistened with water, and then wipe the casing with a dry soft cloth.
- Avoid the following to avoid damage to the finish:
 - Using chemicals such as thinner, benzene, alcohol, chemical cloths, repellent, insecticide and sunscreen
 - Handling the camcorder with above substances on your hands
 - Leaving the casing in contact with rubber or vinyl objects for a long period of time

About care and storage of the lens

- Wipe the surface of the lens clean with a soft cloth in the following instances:
 - When there are fingerprints on the lens surface

- In hot or humid locations
- When the lens is exposed to salty air such as at the seaside
- Store in a well-ventilated location subject to little dirt or dust.
- To prevent mold, periodically clean the lens as described above.

On charging the pre-installed rechargeable battery

Your camcorder has a pre-installed rechargeable battery to retain the date, time, and other settings even when the LCD screen is closed. The pre-installed rechargeable battery is always charged while your camcorder is connected to the wall outlet (wall socket) via the AC Adaptor or while the battery pack is attached. The rechargeable battery will be fully discharged in about 3 months if you do not use your camcorder at all. Use your camcorder after charging the pre-installed rechargeable battery.

However, even if the pre-installed rechargeable battery is not charged, the camcorder operation will not be affected as long as you are not recording the date.

How to charge the pre-installed rechargeable battery

Connect your camcorder to a wall outlet (wall socket) using the supplied AC Adaptor, and leave it with the LCD screen closed for more than 24 hours.

Note on disposal/transfer of “Memory Stick PRO Duo” media

Even if you delete data in “Memory Stick PRO Duo” media or format “Memory Stick PRO Duo” media on your camcorder or a computer, you may not delete data from the “Memory Stick Duo” media completely. When you give “Memory Stick PRO Duo” media to somebody, it is recommended that you delete data completely using data deletion software on a computer. Also, when you dispose of “Memory Stick PRO Duo” media, it is recommended that you destroy the actual body of “Memory Stick PRO Duo” media.

On trademarks

- “Handycam” and **HANDYCAM** are registered trademarks of Sony Corporation.

- “AVCHD” and “AVCHD” logotype are trademarks of Panasonic Corporation and Sony Corporation.
- “Memory Stick,” “” “Memory Stick Duo,” “**MEMORY STICK DUO**,” “Memory Stick PRO Duo,” “**MEMORY STICK PRO DUO**,” “Memory Stick PRO-HG Duo,” “**MEMORY STICK PRO-HG DUO**,” “MagicGate,” “**MAGIC GATE**,” “MagicGate Memory Stick” and “MagicGate Memory Stick Duo” are trademarks or registered trademarks of Sony Corporation.
- “InfoLITHIUM” is a trademark of Sony Corporation.
- “x.v.Color” is a trademark of Sony Corporation.
- “BIONZ” is a trademark of Sony Corporation.
- “BRAVIA” is a trademark of Sony Corporation.
- Dolby and the double-D symbol are trademarks of Dolby Laboratories.
- HDMI, the HDMI logo and HDMI Licensing LLC are trademarks or registered trademarks of HDMI Licensing LLC.
- Microsoft, Windows, Windows Media, Windows Vista, and DirectX are either registered trademarks or trademarks of Microsoft Corporation in the United States and/or other countries.
- Macintosh and Mac OS are registered trademarks of Apple Inc. in the U.S. and other countries.
- Intel, Intel Core, and Pentium are trademarks or registered trademarks of Intel Corporation or its subsidiaries in the United States and other countries.
- Adobe, the Adobe logo, and Adobe Acrobat are either registered trademarks or trademarks of Adobe Systems Incorporated in the United States and/or other countries.
- NAVTEQ and the NAVTEQ Maps logo are trademarks of NAVTEQ in the US and other countries.

All other product names mentioned herein may be the trademarks or registered trademarks of their respective companies. Furthermore, TM and ® are not mentioned in each case in this Handbook.

Notes on the License

ANY USE OF THIS PRODUCT OTHER THAN CONSUMER PERSONAL USE IN ANY MANNER THAT COMPLIES WITH THE MPEG-2 STANDARD FOR ENCODING VIDEO INFORMATION FOR PACKAGED MEDIA IS EXPRESSLY PROHIBITED WITHOUT A LICENSE UNDER APPLICABLE PATENTS IN

THE MPEG-2 PATENT PORTFOLIO, WHICH LICENSE IS AVAILABLE FROM MPEG LA, L.L.C., 250 STEELE STREET, SUITE 300, DENVER, COLORADO 80206.

THIS PRODUCT IS LICENSED UNDER THE AVC PATENT PORTFOLIO LICENSE FOR THE PERSONAL AND NON-COMMERCIAL USE OF A CONSUMER TO

(i) ENCODE VIDEO IN COMPLIANCE WITH THE AVC STANDARD ("AVC VIDEO") AND /OR
(ii) DECODE AVC VIDEO THAT WAS ENCODED BY A CONSUMER ENGAGED IN A PERSONAL AND NON-COMMERCIAL ACTIVITY AND/OR WAS OBTAINED FROM A VIDEO PROVIDER LICENSED TO PROVIDE AVC VIDEO. NO LICENSE IS GRANTED OR SHALL BE IMPLIED FOR ANY OTHER USE. ADDITIONAL INFORMATION MAY BE OBTAINED FROM MPEG LA, L.L.C. SEE <[HTTP://MPEGLA.COM](http://MPEGLA.COM)>

"C Library," "Expat," "zlib," and "libjpeg" software are provided in your camcorder. We provide this software based on license agreements with their owners of copyright. Based on requests by the owners of copyright of these software applications, we have an obligation to inform you of the following. Please read the following sections.

Read "license1.pdf" in the "License" folder on the CD-ROM. You will find licenses (in English) of "C Library," "Expat," "zlib," and "libjpeg" software.

On GNU GPL/LGPL applied software

The software that is eligible for the following GNU General Public License (hereinafter referred to as "GPL") or GNU Lesser General Public License (hereinafter referred to as "LGPL") are included in the camcorder.

This informs you that you have a right to have access to, modify, and redistribute source code for these software programs under the conditions of the supplied GPL/LGPL.

Source code is provided on the web. Use the following URL to download it. When downloading the source code, select DCR-SR87 as the model for your camcorder.

<http://www.sony.net/Products/Linux/>

We would prefer you do not contact us about the contents of source code.

Read "license2.pdf" in the "License" folder on the CD-ROM. You will find licenses (in English) of "GPL," and "LGPL" software.

To view the PDF, Adobe Reader is needed. If it is not installed on your computer, you can download it from the Adobe Systems web page: <http://www.adobe.com/>

Index

Symbols

1080i/480i.....	92
16:9.....	91
4:3.....	91
480i.....	92
5.1ch surround recording.....	35

A

A.SHUT OFF.....	97
Abroad.....	119
Active Interface Shoe.....	7
AREA SET.....	94
AUDIO MODE.....	74
AUTO CLOCK ADJ.....	94
AUTO AREA ADJ.....	94
AUTO BACK LIGHT.....	79, 83
AUTO SLW SHUTTR.....	76, 81
AVCHD format.....	122
A/V connecting cable.....	67

B

BATTERY INFO.....	68
Battery of the Wireless Remote Commander.....	9
Battery pack.....	18
BEACH.....	102
BEEP.....	89
BLACK FADER.....	104
BLT-IN ZOOM MIC.....	104
“BRAVIA” Sync.....	54

C

CALIBRATION.....	128
CAMERA DATA.....	87, 88
CANDLE.....	102
Capturing a photo from a movie	59
Charging the battery pack.....	18
Charging the battery pack abroad	19, 119
CLOCK/LANG.....	94
CLOCK SET.....	21, 94
COMPONENT.....	92
CONVERSION LENS.....	79, 83

COORDINATES.....	88
Copy.....	61
Creating a disc.....	66
Creating a high definition image quality (HD) disc.....	66
Creating a standard definition image quality (SD) disc.....	66
CTRL FOR HDMI.....	98

D

DATA CODE.....	33, 86
Date Index.....	47
DATE/TIME.....	21, 33, 86
DELETE.....	56
Deleting data.....	56, 71
DEMO MODE.....	96
DETECTION SET.....	85
DIGITAL ZOOM.....	75
DISC BURN.....	13
Disc recorder.....	66
DISP OUTPUT.....	92
DIVIDE.....	63
DOWNLOAD MUSIC.....	47
DROP SENSOR.....	98
DST SET.....	95
Dual Rec.....	36
Dubbing.....	60
DVD writer.....	66

E

Easy Handycam Operation.....	24
EDIT.....	62, 63
Empty.....	72
EXPOSURE.....	101

F

FACE DETECTION.....	84
FACE DET. SETTING.....	84
FACE FUNC. SET.....	84
Face Index.....	45
FADER.....	104
FH.....	73
File.....	121
FILE NO.....	80

Film Roll Index.....	44
FIREWORKS.....	102
FLASH LEVEL.....	78, 82
FLASH MODE.....	78, 82
FOCUS.....	101
Folder.....	121
Format.....	71
FRAME SETTING.....	84

G

GENERAL SET.....	96
GPS.....	38
GUIDEFRAAME.....	77, 81

H

HDMI RESOLUTION.....	92
HD/SD SET.....	73, 86
HELP function.....	12
High altitude.....	17
HIGHLIGHT PLAYBACK.....	46
HOME MENU.....	12, 13
HQ.....	73

I

Image quality.....	73, 86
IMAGE SIZE.....	80
INDOOR.....	103
“InfoLITHIUM” battery pack	126
Internal hard disk.....	121

J

JPEG.....	121
-----------	-----

L

LANDSCAPE.....	102
LANGUAGE SET.....	22, 95
LCD BL LEVEL.....	89
LCD BRIGHT.....	89
LCD COLOR.....	90
LP.....	73

M

Maintenance.....	122
------------------	-----

MANAGE MEDIA	69	PROTECT	62
Map Index.....	43		
MEDIA FORMAT	71	R	
MEDIA INFO	71	REC LAMP	96
“Memory Stick” media.....	69, 124	REC MODE.....	73
“Memory Stick PRO Duo” media	69, 70, 121	Recording	24, 31
Menus.....	12	Recording and playback time	116
MICREF LEVEL	105	Recording media.....	69
Mirror mode	37	Recording time of movies/ number of recordable photos	116
Moisture condensation	128	REDEYE REDUC.....	78, 83
MOVIE DUB	60	REMAINING SET.....	77
MOVIE MEDIA SET	69	REMOTE CTRL	97
Movies.....	27, 31, 40	Repair	106
MOVIE SETTINGS	73	REPAIR IMG.DB F.....	110, 113
MPEG2	121	RESET	8
N		S	
NightShot.....	36	SCENE SELECTION	102
NIGHTSHOT LIGHT	74, 80	Screen indicators	10
NTSC.....	119	Self-diagnosis display/Warning indicators	112
		SELF-TIMER.....	105
O		Shooting.....	26, 33
ONE PUSH	103	Slide show	49
OPTION MENU	12, 14, 99	SLIDE SHOW SET	49
Original.....	60	SMILE PRIORITY.....	85
OTHERS	56	SMILE SENSITIVITY.....	85
OUTDOOR.....	103	SMILE SHUTTER.....	85
OUTPUT SETTINGS	91	SMTH SLW REC	37
		SNOW	102
P		SOUND/DISP SET	89
PB zoom.....	48	SP	73
PHOTO CAPTURE	59	SPOT FOCUS	100
PHOTO COPY	61	SPOTLIGHT	102
PHOTO MEDIA SET	69	SPOT METER.....	99
Photos	29, 33, 42	SPOT MTR/FCS	99
PHOTO SETTINGS.....	80	STEADYSHOT	76, 81
Playing.....	27, 40	SUMMERTIME	95
Playlist.....	64	SUNRISE&SUNSET.....	102
PMB Guide.....	2	Supplied items.....	15
PORTRAIT.....	102		
Power on	21	T	
POWER ON BY LCD	97	TELE MACRO.....	100
Precautions.....	122	Telephoto	35
		Thumbnail.....	56
		Tripod.....	8
		Troubleshooting.....	106
		TV.....	50
		TV color systems	119
		TV CONNECT Guide	50
		TV TYPE	91
		TWILIGHT	102
		TWILIGHT PORT	102
		U	
		USB cable.....	66
		USB CONNECT	66
		V	
		VBR.....	118
		VIEW IMAGES SET	86
		Viewing.....	29, 42
		VISUAL INDEX	27, 40, 42
		Volume.....	42, 89
		W	
		Wall outlet (wall socket)	19
		Warning messages	114
		WHITE BAL	103
		WHITE FADER.....	104
		Wide angle.....	35
		WIDE SELECT	74
		Wireless Remote Commander....	9
		X	
		x.v.Color.....	76, 127
		Y	
		YOUR LOCATION.....	58
		Z	
		Zoom.....	35, 48

Additional information on this product and answers to frequently asked questions can be found at our Customer Support Website.

<http://www.sony.net/>

Free Manuals Download Website

<http://myh66.com>

<http://usermanuals.us>

<http://www.somanuals.com>

<http://www.4manuals.cc>

<http://www.manual-lib.com>

<http://www.404manual.com>

<http://www.luxmanual.com>

<http://aubethermostatmanual.com>

Golf course search by state

<http://golfingnear.com>

Email search by domain

<http://emailbydomain.com>

Auto manuals search

<http://auto.somanuals.com>

TV manuals search

<http://tv.somanuals.com>