

# ViewSonic®



---

## VC320

### Digital Video Camcorder

### User Guide

---

**IMPORTANT:** Please read this User Guide to obtain important information on installing and using your product in a safe manner, as well as registering your product for future service. Warranty information contained in this User Guide will describe your limited coverage from ViewSonic Corporation, which is also found on our web site at <http://www.viewsonic.com> in English, or in specific languages using the Regional selection box in the upper right corner of our website. "Antes de operar su equipo lea cuidadosamente las instrucciones en este manual"

---

Model No. VS14315

# Compliance Information

## FCC Statement

This device complies with part 15 of FCC Rules. Operation is subject to the following two conditions: (1) this device may not cause harmful interference, and (2) this device must accept any interference received, including interference that may cause undesired operation.

This equipment has been tested and found to comply with the limits for a Class B digital device, pursuant to part 15 of the FCC Rules. These limits are designed to provide reasonable protection against harmful interference in a residential installation. This equipment generates, uses, and can radiate radio frequency energy, and if not installed and used in accordance with the instructions, may cause harmful interference to radio communications. However, there is no guarantee that interference will not occur in a particular installation. If this equipment does cause harmful interference to radio or television reception, which can be determined by turning the equipment off and on, the user is encouraged to try to correct the interference by one or more of the following measures:

- Reorient or relocate the receiving antenna.
- Increase the separation between the equipment and receiver.
- Connect the equipment into an outlet on a circuit different from that to which the receiver is connected.
- Consult the dealer or an experienced radio/TV technician for help.

**Warning:** You are cautioned that changes or modifications not expressly approved by the party responsible for compliance could void your authority to operate the equipment.

## For Canada

- This Class B digital apparatus complies with Canadian ICES-003.
- Cet appareil numérique de la classe B est conforme à la norme NMB-003 du Canada.

## CE Conformity for European Countries



The device complies with the EMC Directive 2004/108/EC and Low Voltage Directive 2006/95/EC.

## Following information is only for EU-member states:

The mark is in compliance with the Waste Electrical and Electronic Equipment Directive 2002/96/EC (WEEE).

The mark indicates the requirement NOT to dispose the equipment including any spent or discarded batteries or accumulators as unsorted municipal waste, but use the return and collection systems available.

If the batteries, accumulators and button cells included with this equipment, display the chemical symbol Hg, Cd, or Pb, then it means that the battery has a heavy metal content of more than 0.0005% Mercury or more than, 0.002% Cadmium, or more than 0.004% Lead.



# Important Safety Instructions

1. Read these instructions completely before using the equipment.
2. Keep these instructions in a safe place.
3. Heed all warnings.
4. Follow all instructions.
5. Do not use this equipment near water. Warning: To reduce the risk of fire or electric shock, do not expose this apparatus to rain or moisture.
6. Clean with a soft, dry cloth.
7. Do not block any ventilation openings. Install the unit in accordance with the manufacturer's instructions.
8. Do not install near any heat sources such as radiators, heat registers, stoves, or other devices (including amplifiers) that produce heat.
9. Do not defeat the safety purpose of the polarized or grounding-type plug. A polarized plug has two blades with one wider than the other. A grounding type plug has two blades and a third grounding prong. The wide blade and the third prong are provided for your safety. If the provided plug does not fit into your outlet, consult an electrician for replacement of the obsolete outlet.
10. Protect the power cord from being walked on or pinched particularly at plugs. Convenience receptacles and the point where they exit from the unit. Be sure that the power outlet is located near the unit so that it is easily accessible.
11. Only use attachments/accessories specified by the manufacturer.
12. Use only with the cart, stand, tripod, bracket, or table specified by the manufacturer, or sold with the unit. When a cart is used, use caution when moving the cart/unit combination to avoid injury from tipping over.
13. Unplug this unit when unused for long periods of time.
14. Refer all servicing to qualified service personnel. Servicing is required when the unit has been damaged in any way, such as: if the power-supply cord or plug is damaged, if liquid is spilled onto or objects fall into the unit, if the unit is exposed to rain or moisture, or if the unit does not operate normally or has been dropped.
15. Caution: There is a risk of explosion if the battery is replaced by an incorrect type. Dispose of used batteries according to the instructions.
16. Only use battery packs approved by the manufacturer or else damage may occur.



# Declaration of RoHS Compliance

This product has been designed and manufactured in compliance with Directive 2002/95/EC of the European Parliament and the Council on restriction of the use of certain hazardous substances in electrical and electronic equipment (RoHS Directive) and is deemed to comply with the maximum concentration values issued by the European Technical Adaptation Committee (TAC) as shown below:

Substance	Proposed Maximum Concentration	Actual Concentration
Lead (Pb)	0.1%	< 0.1%
Mercury (Hg)	0.1%	< 0.1%
Cadmium (Cd)	0.01%	< 0.01%
Hexavalent Chromium (Cr <sup>6+</sup> )	0.1%	< 0.1%
Polybrominated biphenyls (PBB)	0.1%	< 0.1%
Polybrominated diphenyl ethers (PBDE)	0.1%	< 0.1%

Certain components of products as stated above are exempted under the Annex of the RoHS Directives as noted below:

Examples of exempted components are:

1. Mercury in compact fluorescent lamps not exceeding 5 mg per lamp and in other lamps not specifically mentioned in the Annex of RoHS Directive.
2. Lead in glass of cathode ray tubes, electronic components, fluorescent tubes, and electronic ceramic parts (e.g. piezoelectronic devices).
3. Lead in high temperature type solders (i.e. lead-based alloys containing 85% by weight or more lead).
4. Lead as an alloying element in steel containing up to 0.35% lead by weight, aluminium containing up to 0.4% lead by weight and as a copper alloy containing up to 4% lead by weight.



## Copyright Information

Copyright © ViewSonic® Corporation, 2011. All rights reserved.

ViewSonic, the three birds logo, OnView, ViewMatch, and ViewMeter are registered trademarks of ViewSonic Corporation.

Disclaimer: ViewSonic Corporation shall not be liable for technical or editorial errors or omissions contained herein; nor for incidental or consequential damages resulting from furnishing this material, or the performance or use of this product.

In the interest of continuing product improvement, ViewSonic Corporation reserves the right to change product specifications without notice. Information in this document may change without notice.

No part of this document may be copied, reproduced, or transmitted by any means, for any purpose without prior written permission from ViewSonic Corporation.

## Product Registration

To meet your future needs, and to receive any additional product information as it becomes available, please register your product on the Internet at: [www.viewsonic.com](http://www.viewsonic.com). The ViewSonic® Wizard CD-ROM also provides an opportunity for you to print the registration form, which you may mail or fax to ViewSonic.

### For Your Records

<b>Product Name:</b>	VC320 ViewSonic Digital Video Camcorder
<b>Model Number:</b>	VS14315
<b>Document Number:</b>	VC320_UG_ENG Rev. 1A 07-07-11
<b>Serial Number:</b>	_____
<b>Purchase Date:</b>	_____

### Product disposal at end of product life

ViewSonic respects the environment and is committed to working and living green. Thank you for being part of Smarter, Greener Computing. Please visit ViewSonic website to learn more.

USA & Canada: <http://www.viewsonic.com/company/green/recycle-program/>

Europe: <http://www.viewsoniceurope.com/uk/kbase/article.php?id=639>

Taiwan: <http://recycle.epa.gov.tw/recycle/index2.aspx>

# ViewSonic

## Digital Video Camcorder

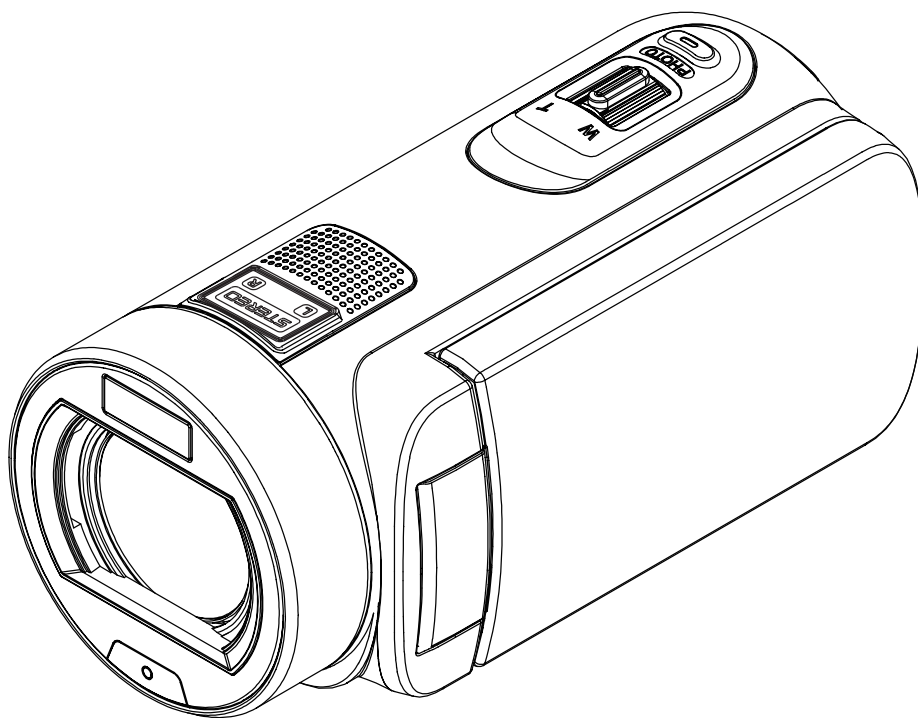

# Read This Before Using the Camcorder

## SAFETY INSTRUCTIONS

- Do not drop, puncture or disassemble the camcorder.
- Use the camcorder with care. Rough handling may damage the internal components.
- Do not expose the camcorder to high temperature. Avoid contact with water.
- Please notice that the camcorder body may become warm when operating it for an extended period.
- Test for proper operation before using the camcorder.
- Only use accessories supplied by the manufacturer.
- Use only the type of battery that came with your camcorder.
- Remove the battery if the camcorder is not going to be used for long periods.

## Product Information

- Designs and specifications of the camcorder are subject to change without notice. This includes primary product specifications, software, and this user's manual.
- This User's Manual is a general reference guide for the camcorder.
- The illustrations in this manual may not be the same as the actual design of your camcorder and those you see on the LCD screen.

# Contents

<b>Read This Before Using the Camcorder .....</b>	<b>2</b>
<b>Section 1 Getting to Know Your Camcorder.....</b>	<b>4</b>
<b>Section 2 Getting Started.....</b>	<b>7</b>
<b>Section 3 Enjoying the Record Mode .....</b>	<b>9</b>
<b>Section 4 Enjoying the Playback Mode.....</b>	<b>21</b>
<b>Section 5 Setting Your Camcorder .....</b>	<b>26</b>
<b>Section 6 Viewing Photos and Videos on TV.....</b>	<b>30</b>
<b>Section 7 Viewing Video &amp; Photo on PC .....</b>	<b>31</b>
<b>Section 8 Uploading Files to Internet .....</b>	<b>32</b>
<b>Section 9 Specifications and System Requirements .....</b>	<b>35</b>
<b>Section 10 Troubleshooting .....</b>	<b>37</b>
<b>Section 11 Using Remote Control.....</b>	<b>38</b>

# Section 1

## Getting to Know Your Camcorder

### Overview

The camcorder equipped a 5 Mega Pixel sensor that can take H.264 format videos. The H.264 technology allows for extended video recording with less memory. High quality images up to 16 mega-pixels can also be delivered smoothly. With a color LCD monitor, you can view and examine the videos and photos easily.

The camcorder features 3" (16:9) LCD touch panel which is an ideal platform for you to operate your camcorder. The menu options are accessible with your finger. With the touch panel, you can select the options directly and quickly.

The camcorder also features video recording at an HD resolution of 1920x1080. You can also connect it to an HDTV via an HDMI cable, and easily playback the recorded high-definition videos on the wide screen HDTV.

Moreover, the camcorder has an advanced uploading feature. With the exclusive built-in **Internet Direct** application, you can upload the videos captured by the camcorder to the web site more effortlessly .

ISO sensitivity and color balance can either be adjusted automatically or changed manually. A 120x digital zoom helps you to control over the videos and photos you take.

The varied effect options, such as Time Lapse and Slow Motion, make recording more fun.

The built-in memory allows you to take photos and to record videos without a memory card. The memory card slot allows users to increase the storage capacity.



#### Note

- *Partial memory of the built-in memory is used for the camcorder's Firmware code and software.*
- *Install the bundled software application on the CD, ArcSoft MediaImpression, for viewing the videos correctly on a PC.*

### Standard Accessories

Unpack the package and make sure all standard accessories listed are included:

- Camcorder
- USB Cable
- AV Cable
- HDMI Cable
- Remote Control
- Adaptor
- Lithium-ion Rechargeable Battery
- Quick Guide
- CD-ROM (Software, User's Manual)
- Pouch
- Lens Cover Set (Lens cover and Strap)

## Front View

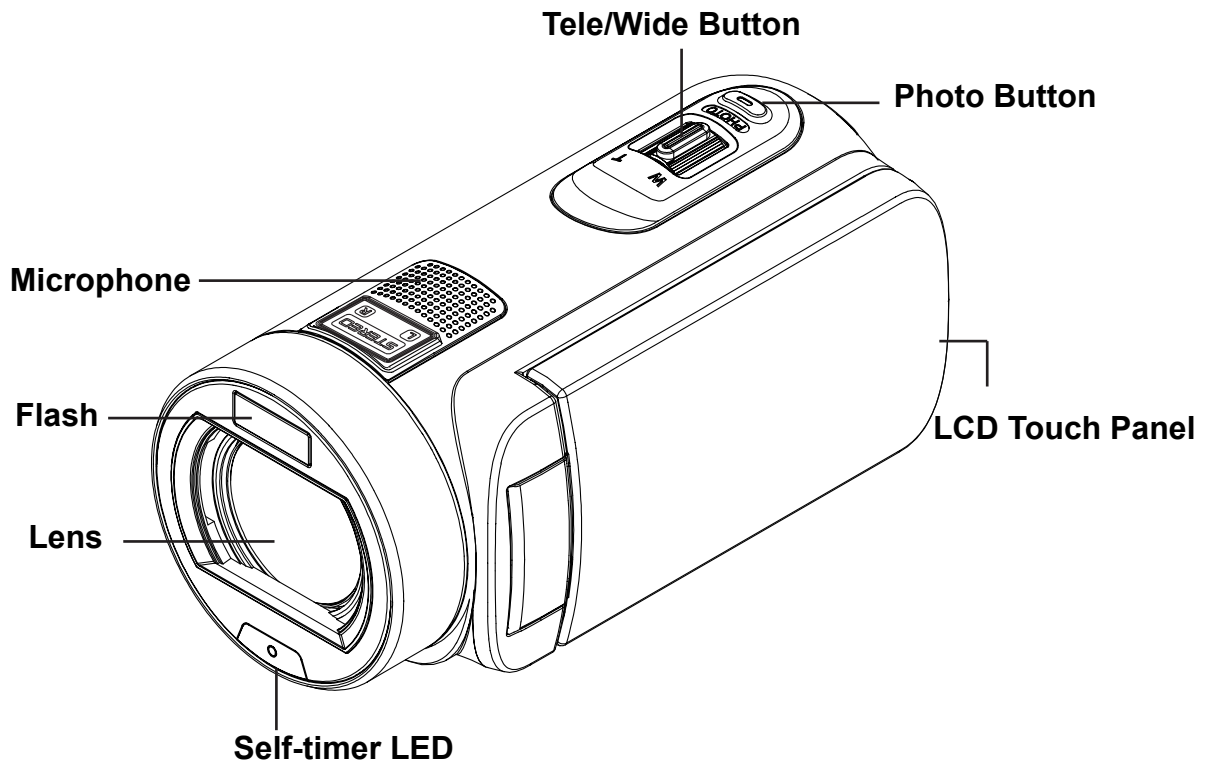

## Rear View

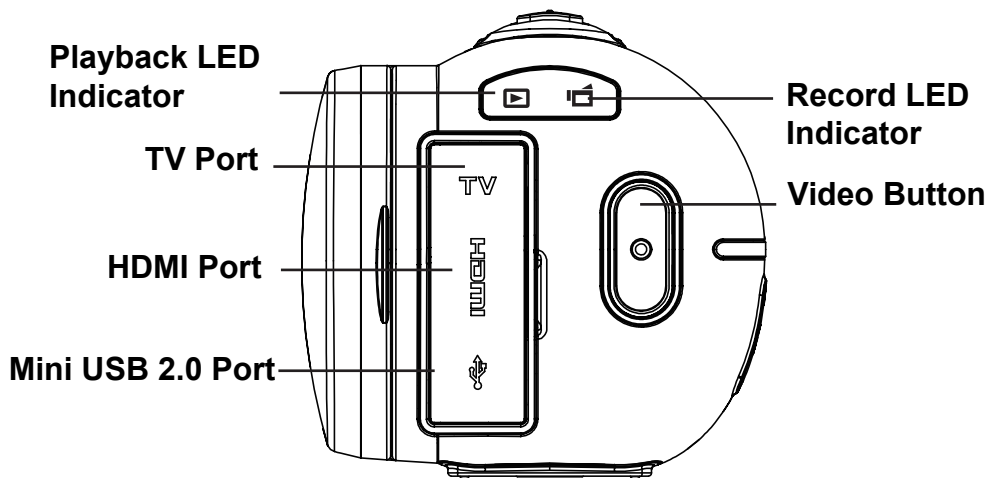

## Side View

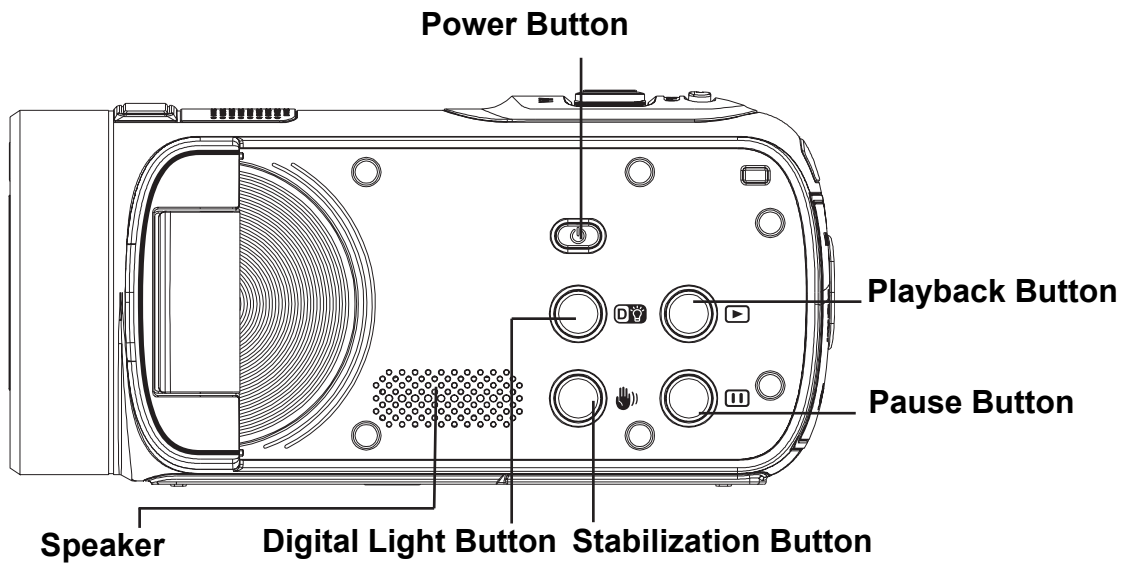

## Bottom View

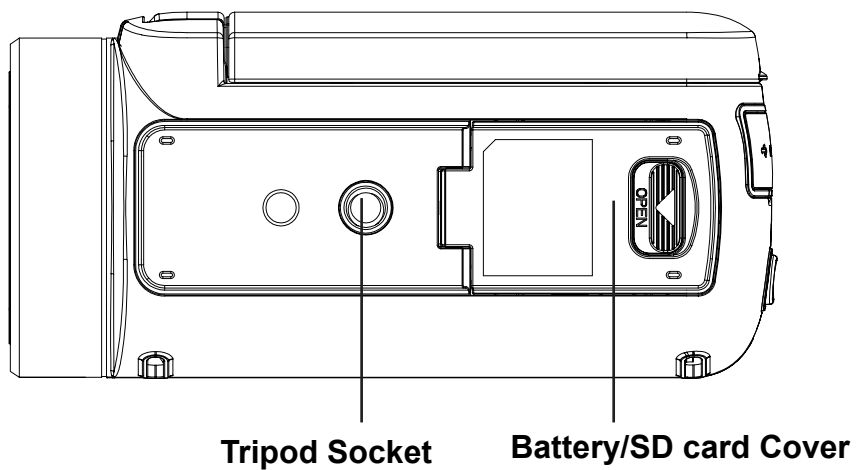

## Section 2

# Getting Started

### Loading the Battery

Before using the camcorder, you must load the Lithium-ion rechargeable battery come within the package.

1. Insert the battery according to the correct polarity marks ( + or -).
2. Close the battery cover firmly.

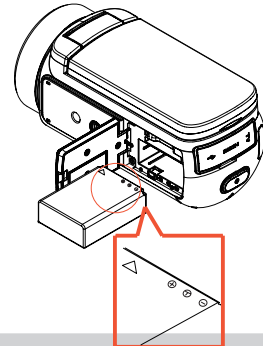

### Charge your battery

You must use the supplied AC charger or the USB cable. The camcorder must be turned OFF. The blinking light confirms the camcorder is currently charging, and the light becomes constant after the charging is completed. In AC charging Mode, the light will turn itself off automatically after 3~5 minutes . The full charge time is about 4 to 5 hours. (Actual charging time may vary. It depends on the battery conditions.)

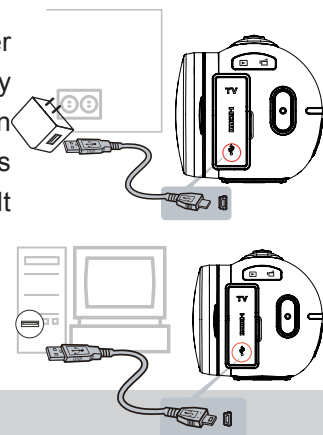

### Inserting and Removing an SD Card (Optional)

The camcorder comes with an internal memory that allows you to store photos and videos. You can expand the memory capacity by using an optional SD memory card.

1. Insert the memory card into the slot. Please refer to the figure on the right side.
2. To remove the installed SD card, press the card inward to release it.
3. When the card pops out, gently remove it from its slot.
4. Recommended memory capacity: 1GB or above.

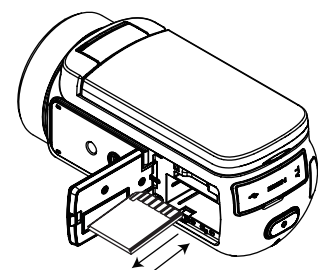

#### Note

- When a memory card is fitted, videos/photos are saved to the card rather than the built-in memory.
- *Protecting Data on an SD Card: SD Card is read-only when it is locked. No photos or videos can be recorded when the SD card is locked. Make sure the lock is on the writeable position before recording any media.*

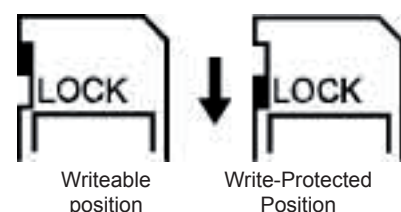







## Turning the Camcorder On

- To turn on the camcorder:
  - Flip out the LCD panel; the camcorder will turn on automatically.
  - Or press [Power Button] for approximately one second to turn it on.



## Configuring the Initial Date and Time Setup

- The time setting screen appears to allow you to setup date and time:

Operation	Display Screen
<ol style="list-style-type: none"> <li>Touch Year, Month, Day, Hour, Minute, and AM/PM to set.</li> <li>Adjust the numeric value by touching  / </li> <li>Touch the [OK] icon to validate the setting.</li> <li>Touch the Exit icon (  ) to exit.</li> </ol>	

## Getting Started

- To record video: Press [Video Button] to record video. To stop recording, press it again.
- To pause recording: Press [Pause Button] to pause recording. To continue the recording, press it again.
- To take a photo during video recording: When recording video, press [Photo Button] to capture the image. The Dual record icon (  ) appears on the LCD monitor.
- To take a photo: Press [Photo Button] halfway down until the focusing frame turns from white to green. Then, press it fully down to take photo.

	
Focusing Frame: White	Focusing Frame: Green

- To view stored videos and photos: Press [Playback Button] or touch  on the screen to switch to the Playback mode.







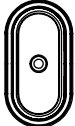

## Turning the Camcorder Off

- To turn off the camcorder: You can either press [Power Button] for one second, or you can place the LCD panel back to its original position.

## Section 3

# Enjoying the Record Mode









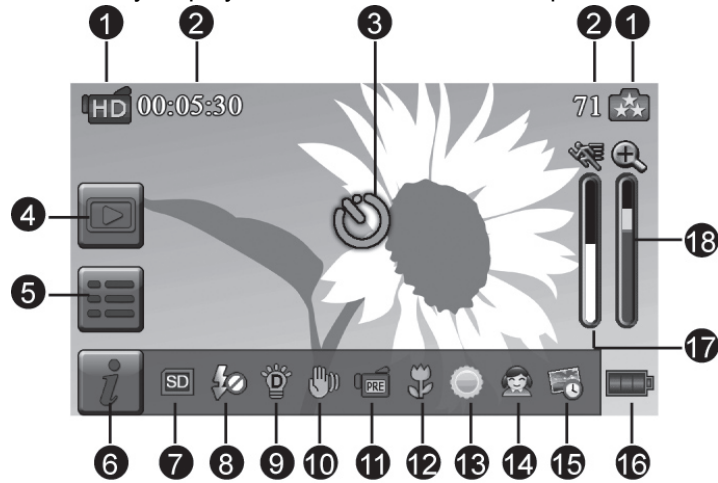





### Button Function



























	<p><b>Video Button:</b></p> <ol style="list-style-type: none"> <li>1. Press to take video.</li> <li>2. To stop recording, press it again.</li> </ol>
	<p><b>Photo Button:</b></p> <ol style="list-style-type: none"> <li>1. Press to take photo.</li> <li>2. When recording video, press to capture the image.</li> </ol>
	<p><b>Tele Button:</b></p> <ol style="list-style-type: none"> <li>1. Zoom In.</li> </ol> <p><b>Wide Button</b></p> <ol style="list-style-type: none"> <li>1. Zoom out.</li> </ol>
	<p><b>Power Button:</b></p> <ol style="list-style-type: none"> <li>1. Press down for one second to turn on or turn off the camcorder.</li> </ol>
	<p><b>Playback Button:</b></p> <ol style="list-style-type: none"> <li>1. Switch between Record / Playback Mode.</li> <li>2. For quick review, press it after recording.</li> </ol>
	<p><b>Pause Button:</b></p> <ol style="list-style-type: none"> <li>1. Press to pause the recording.</li> <li>2. To continue the recording, press it again.</li> </ol>
	<p><b>Digital Light Button:</b></p> <p>Digital Light On/Off.</p>
	<p><b>Stabilization Button:</b></p> <p>Stabilization On/Off.</p>

## LCD Monitor Information

The indicators shown below may display on LCD when videos and photos are recorded:



(1)	Video Resolution	
		Full HD (1080p 30 fps)
		HD (720p 60 fps)
		HD (720p 30 fps)
		VGA (640X480)
		Slow Motion (Record video at 432x240(QVGA) resolution.)
	Photo Resolution	
	16MP	
	5MP	
	3MP	
(2)	<b>00:05:30</b>	Recording time of the video that can still be taken at current resolution
	<b>71</b>	Number of images that can still be taken at current resolution
(3)		Self-timer enabled
		Dual Record
(4)		Playback Mode On
(5)		Menu On
(6)		Information bar On
(7)		SD Card Inserted





(8)		Flash Auto (Photo Recording Only)
		Red Eye Reduction (Photo Recording Only)
		Flash Off
(9)		Digital Light On
(10)		Stabilization
(11)		Pre-Record Mode
		Time Lapse
		Smile Detection
(12)		Macro Focusing On
(13)		Daylight
		Fluorescent
		Tungsten
(14)	Scene	
		Skin
		Night
		Backlight
		Black/White
		Classic
		Negative
(15)		Date Printing On
(16)		Battery: full power
		Battery: medium power
		Battery: low power
		Battery: empty power
		DC power mode
(17)		Motion Detection
(18)		Zoom meter: 1X~2700X (23X Optical zoom and 120X Digital zoom)







### Note

- Stabilization, Time Lapse, and Slow Motion functions can not be used simultaneously.
- Stabilization and Night Mode functions can not be used simultaneously.
- Pre-Record, Motion Detect, Slow Motion, and Time Lapse functions can not be used simultaneously.

## Video Recording

- Press [Video Button] to start recording. When a video is being recorded, a time indicator will display on the LCD monitor (  00:00:25 ). To stop recording, press it again.
- To pause recording: Press [Pause Button] to pause recording (  00:00:36 ). To continue the recording, press it again.
- Dual record: press [Photo Button] to capture the image. The Dual record icon (  ) appears on the LCD monitor.
- Press [Playback Button] or touch  on the screen to view the recorded video.
- Four resolution settings are available:

Video Quality	
	Full HD (1080p 30 fps)
	HD (720p 60 fps)
	HD (720p 30 fps)
	VGA (640X480)



### Note

- The image resolution captured during video recording is the same as the video resolution.
- The flash can not be used when capturing image during movies recording.

## Photo Capturing





- Press [Photo Button] halfway down until the focusing frame turns from white to green. Then, press it fully down to take photo.
- Press [Playback Button] or touch  on the screen to view the photos.
- Three resolution settings are available:

Image Quality	
	16 Mega Pixels
	5 Mega Pixels
	3 Mega Pixels

## Using Zoom Function

- The zoom magnifies images when recording video or taking photo.
  1. To zoom in/out, press the Tele/Wide Button.
  2. It can be set from 1X~2700X (23X Optical zoom and 120X Digital zoom)

## Using Digital Light Function





- The setting allows you to extend the brightness of the objects that are dark or in the shadow. It can extend the dynamic range for backlight and high contrast sense, so that the objects will be brighter and clearer.
- To use the Digital Light function:
  - Press [Digital Light Button] in Record Mode. The Digital Light icon(  ) appears on the LCD monitor.
  - Press [Video Button] to start recording or press [Photo button] to take photo.

## Using Stabilization Function





- To record with an effect of reducing camcorder shake to result in more stable video.
- To use the Stabilization function:
  - Press [Stabilization Button] in Record Mode. The Stabilization icon(  ) appears on the LCD monitor.
  - Press [Video Button] to start recording.

## Showing Information on the screen

- Touch the on-screen button to show or not to show the indicators on the LCD screen.





Operation	Screen
1. Touch  on the screen. The information bar will show on the screen. 2. Touch again to hide all indicators.	
3. Touch  to display the indicators.	 

## Options for Record Menu

Video	Photo	Effect	Setting*
			
<ul style="list-style-type: none"> <li>• Resolution</li> <li>• Pre-record</li> <li>• Motion Detect</li> <li>• Slow Motion</li> <li>• Time Lapse</li> </ul>	<ul style="list-style-type: none"> <li>• Resolution</li> <li>• Flash</li> <li>• Self-Timer</li> <li>• Smile Detect</li> <li>• ISO</li> </ul>	<ul style="list-style-type: none"> <li>• Scene</li> <li>• WB(White Balance)</li> <li>• Macro Mode</li> <li>• Face Tracking</li> </ul>	<ul style="list-style-type: none"> <li>• Sound</li> <li>• TV</li> <li>• Language</li> <li>• Time Setting</li> <li>• Date Printing</li> <li>• Format</li> <li>• Default Setting</li> </ul>

\* Please refer to Section 5 for the detailed information about [Setting].

## Operations for Record Mode

Operation	Display Screen
<p>1. Touch  on the screen in Record Mode. The menu will show on the screen.</p>	
<p>2. Touch the option icons on the screen lightly with your finger. The options are Video, Photo, Effect, and Setting.</p> <p>3. The option submenu will pop up on the screen.</p> <p>4. Touch to select the specific option you want to adjust. (The selected option will be highlighted.)</p> <p>5. Touch the Exit icon (  ) to exit.</p>	

## Video

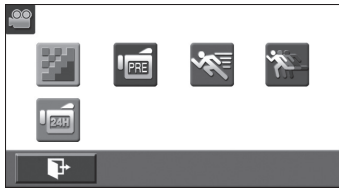
Operation	Display Screen
<ol style="list-style-type: none"> <li>1. Touch  on the screen in Record Mode. The menu will show on the screen.</li> <li>2. Touch the [Video] icon on the screen. Submenu of Video will pop out on the screen.</li> <li>3. The Video submenu contains 5 options-- Resolution, Pre-record, Motion Detect, Slow Motion, and Time Lapse --for you to adjust the camcorder settings.</li> </ol>	

### Video Resolution

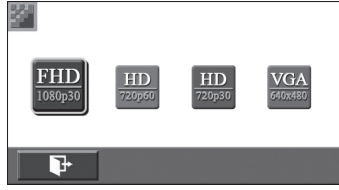

Four resolution settings are available.

- **FHD (1080p 30)**:Record videos at 1920x1080p 30 fps resolution.
- **HD+ (720p 60)**:Record videos at 1280x720p 60 fps resolution.
- **HD (720p 30)**:Record videos at 1280x720p 30 fps resolution.
- **VGA (640X480)**: Record videos at 640x480p 30 fps resolution.

Operation	Display Screen
<ol style="list-style-type: none"> <li>1. In the Video menu, touch the [Resolution] icon on the screen.</li> <li>2. Touch to select the desired option.</li> <li>3. Touch the Exit icon (  ) to exit.</li> </ol>	

### Pre-record

The Pre-record function ensures that you will not miss any critical recording opportunities. The videos are recorded 3 seconds more before the [Video Button] is pressed.

Operation	Display Screen
<ol style="list-style-type: none"> <li>1. In the Video menu, touch the [Pre-record] icon on the screen.</li> <li>2. Touch to select [On] or [Off] ( <input checked="" type="checkbox"/> <input type="checkbox"/> ).</li> <li>3. Touch the Exit icon (  ) to exit.</li> </ol>	





#### Note

- Aim the camcorder at the subject and position it securely.





## Motion Detection

Record videos automatically when the camcorder detects a movement.

Operation	Display Screen
<ol style="list-style-type: none"> <li>In the Video menu, touch the [Motion Detect] icon on the screen.</li> <li>Touch to select [On] or [Off] ( <input type="checkbox"/> <input type="checkbox"/> ).</li> <li>Touch the Exit icon (  ) to exit.</li> <li>Camcorder will start to record video automatically if it detects a movement. Stop recording if it does not detect a movement.</li> </ol>	

## Slow Motion

Record videos with slow motion effect. When the video is played, the playback time will be longer than the actual recording time.

Operation	Display Screen
<ol style="list-style-type: none"> <li>In the Video menu, touch the [Slow Motion] icon on the screen.</li> <li>Touch to select [On] or [Off] ( <input type="checkbox"/> <input type="checkbox"/> ).</li> <li>Touch the Exit icon (  ) to exit.</li> </ol>	



### Note

- Pause function can not be used when Slow Motion function is activated.

## Time Lapse

Record still images at specific intervals you can set and play them as one video file.

- **Off:** Disable Time Lapse.
- **1 Second.:** Record one frame per second.
- **3 Seconds:** Record one frame every 3 seconds.
- **5 Seconds:** Record one frame every 5 seconds.

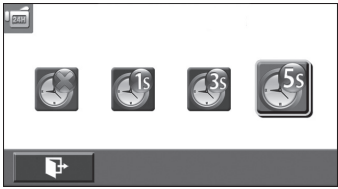
Operation	Display Screen
<ol style="list-style-type: none"> <li>In the Video menu, touch the [Time Lapse] icon on the screen.</li> <li>Touch to select the desired option.</li> <li>Touch the Exit icon (  ) to exit.</li> </ol>	



### Note

- Pause function can not be used when Time Lapse function is activated.

## Photo

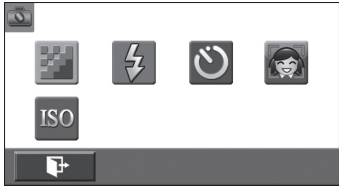
Operation	Display Screen
<ol style="list-style-type: none"> <li>1. Touch  on the screen in Record Mode. The menu will show on the screen.</li> <li>2. Touch the [Photo] icon on the screen. Submenu of Photo will pop out on the screen.</li> <li>3. The Photo submenu contains 5 options-- Resolution, Flash, Self-Timer, Smile Detect, and ISO, --for you to adjust the camcorder settings.</li> </ol>	

## Photo Resolution

Three resolution settings are available.

- **16MP:** Shoot photo at 4608 x 3456, 16MP quality.
- **5MP:** Shoot photo at 2592 x 1944, 5MP quality.
- **3MP:** Shoot photo at 2048 x 1536, 3MP quality.

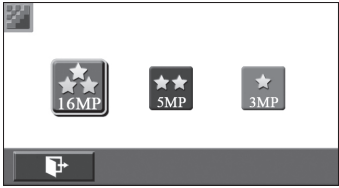
Operation	Display Screen
<ol style="list-style-type: none"> <li>1. In the Photo menu, touch the [Resolution] icon on the screen.</li> <li>2. Touch to select the desired option.</li> <li>3. Touch the Exit icon (  ) to exit.</li> </ol>	

## Flash

This camcorder has three flash settings.

- **Flash Auto:** The flash fires automatically according to light conditions. Use this mode for general photography.
- **Red Eye Reduct.** (Red Eye Reduction) :The pre-flash will fire to reduce the red-eye effect.
- **Flash Off:** The flash will not fire under any circumstances. Use this mode when taking photo in a place where flash photography is prohibited, or when the subject is distant (beyond the range of the flash).

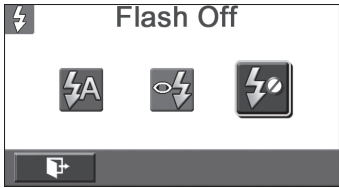
Operation	Display Screen
<ol style="list-style-type: none"> <li>1. In the Photo menu, touch the [Flash] icon on the screen.</li> <li>2. Touch to select the desired option.</li> <li>3. Touch the Exit icon (  ) to exit.</li> </ol>	





### Note

The flash will be disabled automatically when the battery power is low (  ).



## Self-Timer

The self-timer allows you to take photos with a ten-second time delay. The self-timer light on the front of the camcorder will also blink. The speed of blinking will increase just before the photo is taken.

Operation	Display Screen
<ol style="list-style-type: none"> <li>In the Photo menu, touch the [Self-timer] icon on the screen.</li> <li>Touch to select [On] or [Off] ( <input type="checkbox"/> <input checked="" type="checkbox"/> <input type="checkbox"/> ).</li> <li>Touch the Exit icon (  ) to exit.</li> </ol>	

## Smile Detection

Capture image automatically when the camcorder detects a smile.

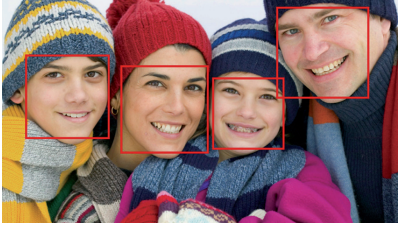
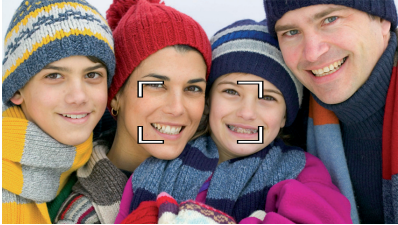
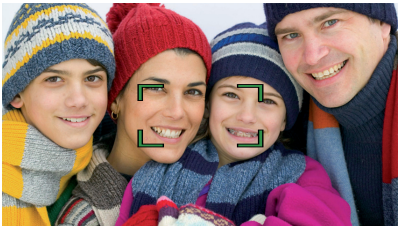
Operation	Display Screen
<ol style="list-style-type: none"> <li>In the Photo menu, touch the [Smile Detect] icon on the screen.</li> <li>Touch to select [On] or [Off] ( <input type="checkbox"/> <input checked="" type="checkbox"/> <input type="checkbox"/> ).</li> <li>Touch the Exit icon (  ) to exit.</li> </ol>	   

## ISO

The camcorder adjusts the ISO sensitivity of its images automatically. Four manual ISO sensitivity settings are available. (800/1600/3200/6400). The larger the number is, the higher the ISO sensitivity is set to. Select a small number to shoot a smoother image. Select a large number to shoot an image in a dark location or to shoot a subject moving at high speed.

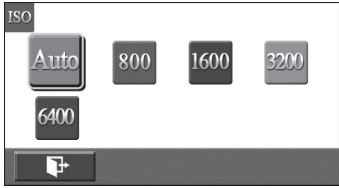
Operation	Display Screen
<ol style="list-style-type: none"> <li>1. In the Photo menu, touch the [ISO] icon on the screen.</li> <li>2. Touch to select the desired option.</li> <li>3. Touch the Exit icon (  ) to exit.</li> </ol>	



### Note

The image may become noisy when the ISO number is large.

## Effect

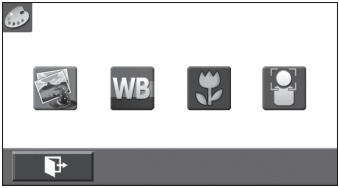
Operation	Display Screen
<ol style="list-style-type: none"> <li>1. Touch  on the screen in Record Mode. The menu will show on the screen.</li> <li>2. Touch the [Effect] icon on the screen. Submenu of Effect will pop out on the screen.</li> <li>3. The Effect submenu contains 4 options--Scene, White Balance, Macro Mode, and Face Tracking --for you to adjust the camcorder settings.</li> </ol>	

## Scene

You can select the mode according to the scene condition.

- **Auto:** Shoot without any special effect on the image.
- **Skin:** Shoot with an effect that makes skin tones more natural.
- **Night:** Use Night Mode for night scenes or low light conditions.
- **Backlight:** You can take shots when the bright light is behind the subject.
- **Black/White:** The image is converted to black-and-white.
- **Classic:** The image is converted to a sepia look.
- **Negative:** The image is converted as the negative of the normal.

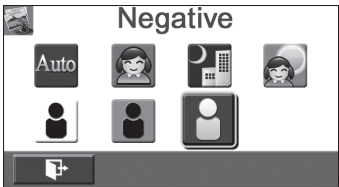
Operation	Display Screen
<ol style="list-style-type: none"> <li>1. In the Effect menu, touch the [Scene] icon on the screen.</li> <li>2. Touch to select the desired option.</li> <li>3. Touch the Exit icon (  ) to exit.</li> </ol>	



### Note

To avoid blurry photos, place the camcorder on a flat, steady surface, or use a tripod when taking shots in the Night Mode.

## White Balance

The camcorder adjusts the color balance of images automatically. Three manual white balance settings are available:

- **Auto:** The camcorder automatically adjusts white balance.
- **Daylight:** Under outdoor condition.
- **Fluorescent:** Under fluorescent light condition.
- **Tungsten:** Under tungsten light condition.

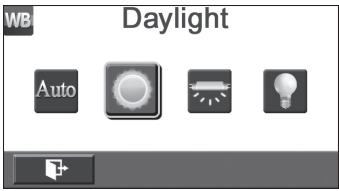
Operation	Display Screen
<ol style="list-style-type: none"> <li>1. In the Effect menu, touch the [White Balance] icon on the screen.</li> <li>2. Touch to select the desired option.</li> <li>3. Touch the Exit icon (  ) to exit.</li> </ol>	

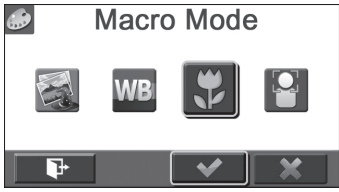

## Macro Mode

You can select the mode for recording close-up video and photo.

Operation	Display Screen
<ol style="list-style-type: none"> <li>1. In the Effect menu, touch the [Macro Mode] icon on the screen.</li> <li>2. Touch to select [On] or [Off] ( <input checked="" type="checkbox"/> <input type="checkbox"/> ).</li> <li>3. Touch the Exit icon (  ) to exit.</li> </ol>	

## Face Tracking

The camcorder can detect human face(s) and focus on the face(s) automatically. This function can work with video recording and photo capturing. It is wonderful for capturing beautiful portraits in backlight situation.

Operation	Display Screen
<ol style="list-style-type: none"> <li>1. In the Effect menu, touch the [Face Tracking] icon on the screen.</li> <li>2. Touch to select [On] or [Off] ( <input checked="" type="checkbox"/> <input type="checkbox"/> ).</li> <li>3. Touch the Exit icon (  ) to exit.</li> </ol>	 



### Note





When Face Tracking is activated, aim the camcorder at the human face(s). The focus frame(s) will show on the LCD before the [Video Button]/[Photo Button] is pressed.

## Section 4

# Enjoying the Playback Mode

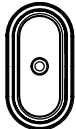
### Button Function

The Buttons have the following functions in Playback Mode.







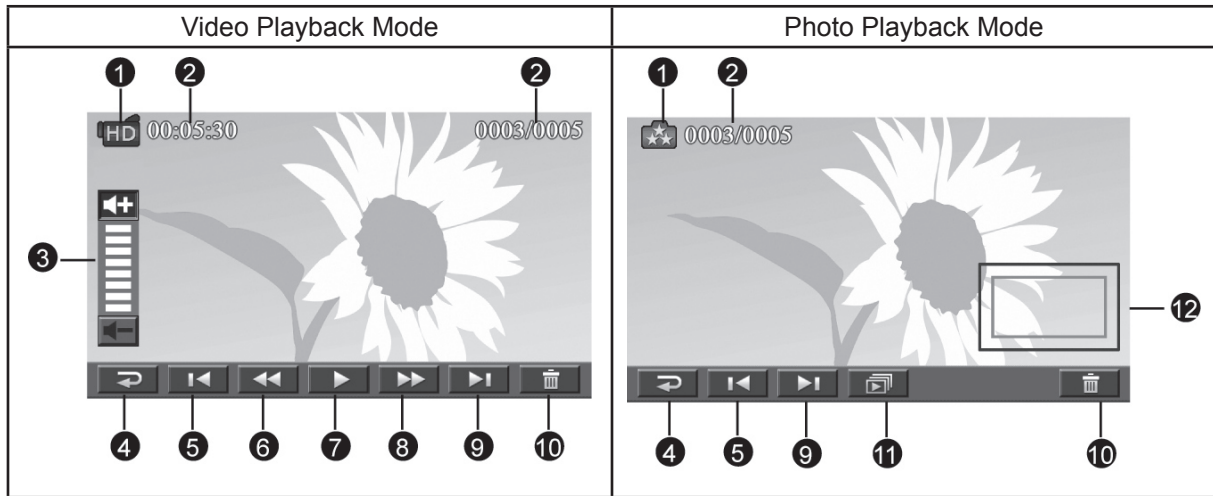

	<b>Video Button:</b> 1. Switch to Record Mode.
	<b>Tele Button:</b> 1. Zoom In. <b>Wide Button</b> 1. Zoom out.
	<b>Playback Button:</b> 1. Switch between Record / Playback Mode. 2. For quick review, press it after recording.
	<b>Pause Button:</b> 1. In Video Playback Mode, press to pause the recorded video.

## LCD Monitor Information

Indicators on the LCD screen while in Playback Mode:







(1)	Video Resolution	
		Full HD (1080p 30 fps)
		HD (720p 60 fps)
		HD (720p 30 fps)
		VGA (640X480)
		Slow Motion (432x240(QVGA))
	Photo Resolution	
		16MP
		5MP
		3MP
	Dual Record (The image resolution captured during videos recording is the same as the video resolution.)	
(2)	<b>00:05:30</b>	Video playback time counter.
	<b>0003/0005</b>	Current number/ Total number of photo/video.
(3)		Volume
(4)		Return
		Video stop
(5)		Previous video/photo
(6)		Video fast rewind

(7)		Video play
		Video pause
(8)		Video fast forward
(9)		Next video/photo
(10)		Delete
(11)		Slideshow
		Slideshow stop
(12)		Magnification Indicator









## Operations for Playback Mode

The Playback Mode is for viewing and managing videos and photos on the built-in memory or on an SD Card.

Operation	Display Screen
1. Press [Playback Button] or touch  on the screen to switch to the Playback mode.	
2. Touch to select the specific option. 3. Touch (  ) to back to Record Mode.	



## Video Playback



Operation	Display Screen
<ol style="list-style-type: none"> <li>1. In the Video Playback mode, touch  to play or pause the videos.</li> <li>2. Sweep to the right or touch  to go to the previous video; sweep to the left or touch  to go to the next video.</li> <li>3. While playing videos, touch  /  to fast rewind/forward.</li> <li>4. Touch  to increase the volume; touch  to reduce the volume.</li> <li>5. Touch (  ) to exit.</li> </ol>	



### Note

- When the LCD is idle for a few seconds, the playback function icons will disappear automatically.

## Delete Videos

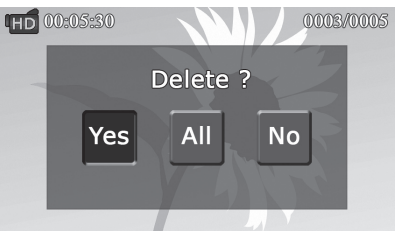
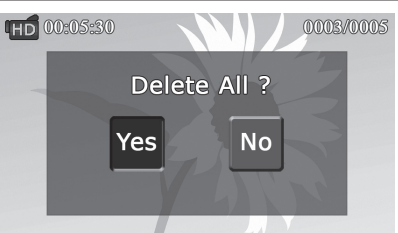





Operation	Display Screen
<ol style="list-style-type: none"> <li>1. Touch  to go to the Delete option screen.</li> </ol>	
<ol style="list-style-type: none"> <li>2. Touch [Yes] to delete the current video or [No] to cancel the operation and to exit; touch [All (Delete All)] to delete all videos.</li> <li>3. Before all videos are about to be deleted, a confirmation screen will appear; touch [Yes] to execute the operation and [No] to cancel the operation.</li> </ol>	
	



### Note

- If a memory card has been inserted, you can only delete those videos stored on the card.
- Videos on a written-protected memory card cannot be deleted.

## Photo Playback





Operation	Display Screen
<ol style="list-style-type: none"> <li>In the Photo Playback mode, sweep to the right or touch  to go to the previous photo; sweep to the left or touch  to go to the next photo.</li> <li>While the photo is selected, press [Tele Button] to magnify. (The magnification Indicator appears on the screen)</li> <li>To navigate the magnified photo, press on the screen and move as well. (The inner Magnification Indicator turns red)</li> <li>Press [Wide Button] to zoom out or exit the magnification mode.</li> <li>Touch  /  to start or to stop the slide show.</li> <li>Touch (  ) to exit.</li> </ol>	



### Note

- When the LCD is idle for a few seconds, the playback function icons will disappear automatically.

## Delete Photo

Operation	Display Screen
<ol style="list-style-type: none"> <li>Touch  to go to the Delete option screen.</li> </ol>	
<ol style="list-style-type: none"> <li>Touch [Yes] to delete the current photo or [No] to cancel the operation and to exit; touch [All (Delete All)] to delete all photos.</li> <li>Before all photos are deleted, a confirmation screen will appear; touch [Yes] to execute the operation and [No] to cancel the operation.</li> </ol>	 





### Note

- If a memory card has been inserted, you can only delete those photos stored on the card.
- Photos on a written-protected memory card cannot be deleted.

# Section 5

## Setting Your Camcorder

### Setting Menu

Operation	Display Screen
<ol style="list-style-type: none"> <li>1. Touch  on the screen in Record Mode. The menu will show on the screen.</li> <li>2. Touch the [Setting] icon on the screen. Submenu of Setting will pop out on the screen.</li> <li>3. The Setting submenu contains 7 options for configuring your camcorder setup. They are Sound (operation sound), TV, Language, Time Setting, Date Printing, Format, and Default Setting.</li> </ol>	

### Sound

Enable or disable the keypad tone and the operation sound.

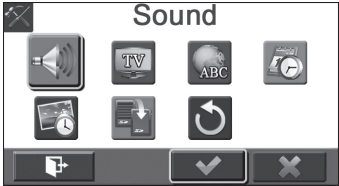
Operation	Display Screen
<ol style="list-style-type: none"> <li>1. In the Setting menu, touch the [Sound] icon on the screen.</li> <li>2. Touch to select [On] or [Off] ( <input type="checkbox"/> <input type="checkbox"/> ).</li> <li>3. Touch the Exit icon (  ) to exit.</li> </ol>	

### TV

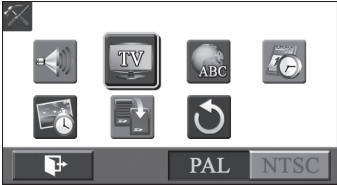

Ensure that the appropriate TV standard of your area is selected – either NTSC or PAL. Wrong TV system setting may cause image flickers.

- **NTSC**(60Hz):USA, Canada, Japan, South Korea and Taiwan, etc.
- **PAL**(50Hz):UK, Europe, China, Australia, Singapore and Hong Kong, etc.



Operation	Display Screen
<ol style="list-style-type: none"> <li>1. In the Setting menu, touch the [TV] icon on the screen.</li> <li>2. Touch to select [PAL] or [NTSC].</li> <li>3. Touch the Exit icon (  ) to exit.</li> </ol>	

## Language

Use this option to select the language of the user interface.

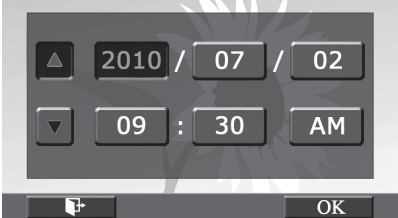

Operation	Display Screen
<ol style="list-style-type: none"> <li>In the Setting menu, touch the [Language] icon on the screen.</li> <li>Touch to select the desired option.</li> <li>Touch the Exit icon (  ) to exit.</li> </ol>	

## Time Setting

Operation	Display Screen
<ol style="list-style-type: none"> <li>In the Setting menu, touch the [Time Setting] icon on the screen to enter the time setting screen.</li> <li>Touch Year, Month, Day, Hour, Minute, and AM/PM to set.</li> <li>Adjust the numeric value by touching  / .</li> <li>Touch the [OK] icon to validate the setting.</li> <li>Touch the Exit icon (  ) to exit.</li> </ol>	

## Date Printing

Imprint the date and time on the video and photo.

Operation	Display Screen
<ol style="list-style-type: none"> <li>In the Setting menu, touch the [Date Printing] icon on the screen.</li> <li>Touch to select [On] or [Off] ( <input checked="" type="checkbox"/> <input type="checkbox"/> ).</li> <li>Touch the Exit icon (  ) to exit.</li> </ol>	



### Note

- Date Printing function can not be used when Slow Motion function is activated.*

## Format

- **Yes:** Format the built-in memory ( When there is no SD card in the camcorder ) / SD Card (When there is an SD card in the camcorder).
- **No:** Do not format the built-in memory ( When there is no SD card in the camcorder ) / SD Card (When there is an SD card in the camcorder).

Operation	Display Screen
1. In the Setting menu, touch the [Format] icon on the screen. 2. Touch to select [Yes] or [No] ( <input type="checkbox"/> <input type="checkbox"/> ). (Touch [Yes] <input checked="" type="checkbox"/> to enter the confirmation screen.)	
3. Touch the [Yes <input checked="" type="checkbox"/> ] icon to execute the operation and the [No <input type="checkbox"/> ] icon to cancel the operation.	



### Note

All the data will be erased if the SD card is formatted. Make sure all the data are copied to your PC before formatting the SD card.

## Default Setting

To restore the default factory setting, select this option.

Operation	Display Screen
1. In the Setting menu, touch the [Default Setting] icon on the screen. 2. Touch to select [Yes] or [No] ( <input type="checkbox"/> <input type="checkbox"/> ). (Touch [Yes] <input checked="" type="checkbox"/> to enter the confirmation screen.)	
3. Touch the [Yes <input checked="" type="checkbox"/> ] icon to execute the operation and the [No <input type="checkbox"/> ] icon to cancel the operation.	

The following table indicates the camcorder's default settings

<b>Setting</b>	<b>Default Factory Setting</b>
<b>Resolution</b>	FHD (1080p 30) for Video 5MP for Photo
<b>Stabilization</b>	Off
<b>Motion Detection</b>	Off
<b>Slow Motion</b>	Off
<b>Time Lapse</b>	Off
<b>Self-Timer</b>	Off
<b>Smile Detection</b>	Off
<b>ISO</b>	Auto
<b>Scene</b>	Auto
<b>White Balance</b>	Auto
<b>Face Tracking</b>	Off
<b>Flash</b>	Off
<b>Sound</b>	On
<b>TV</b>	Depends on shipping area
<b>Language</b>	Depends on shipping area
Date Printing	Off
<b>Volume</b>	Level 6

## Section 6

# Viewing Photos and Videos on TV

### Connecting to a High-Definition 16:9(Wide) TV

1. Connect the HDMI cable to your camcorder's HDMI Out port.
2. Connect the other end of the cable to a television.
3. Set the video input source of your TV to "HDMI."
4. The steps for viewing stored videos and photos on HDTV are exactly the same as for viewing them on the LCD monitor.

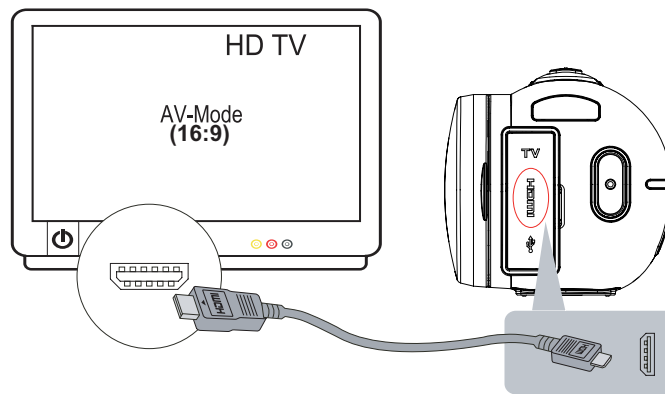

### Connecting to a non-high-definition 4:3 TV

1. Connect one end of the AV cable to your camcorder's AV out port.
2. Connect the other end of the cable to a television.
3. The steps for viewing stored videos and photos on TV are exactly the same as for viewing them on the LCD monitor.

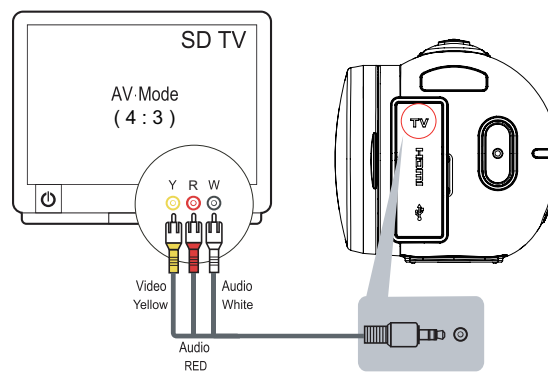

## Section 7

# Viewing Video & Photo on PC

### Installing Bundled Software

The CD-ROM supplied with this camcorder contains 2 pieces of software.

- **ArcSoft MediaImpression** is a user-friendly application that helps you managing your media, burning your video into DVD, and uploading your files to the web sites easily.
- **Adobe Reader** is a popular program that you need to have installed to read the User's Manual. Many computer users will find they already have this software installed on their computer.

To install the bundled software:

1. Insert the CD-ROM into your computer's CD-ROM drive. The autorun screen appears.
2. Click "Install ArcSoft MediaImpression". Follow the on-screen instructions to complete the installation.



#### Note

- *The detailed Instructions for the bundled software can be found within the program once the installation is completed. Click on [Extras] on the title bar and select [Help] to open the instruction manual.*
- *Install the bundled software application, ArcSoft MediaImpression, for viewing the videos correctly on a PC.*

### Transferring Photos or Videos to a Computer

You can transfer photos or videos stored on your camcorder to a computer and send them in e-mails to friends or post them on the web sites.

To do this you should:

1. Connect the computer and camcorder with the supplied mini USB 2.0 cable. .
2. The videos and photos can be found on your computer at "My Computer\Removable Disk\DCIM\100MEDIA". (Under the circumstances of within the SD card in the camcorder)
3. Under this folder, you can view, delete, move, or copy any video/photo you want.



## Section 8

# Uploading Files to Internet

The built-in **Internet Direct** application offers you an easy way to upload your files to Internet instantly. It helps you share them with your family and friends on the web site.

### To upload files to Internet:

1. Connect the camcorder to your computer by using the supplied USB cable.

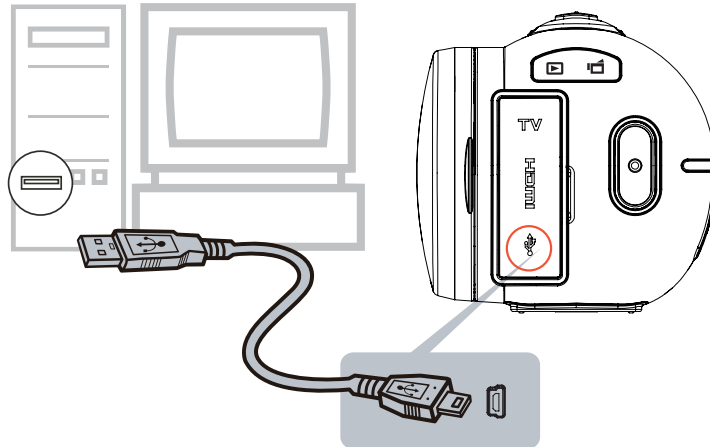

2. After making a USB connection, the AutoPlay window will appear. (It may be different based on OS recognition. If the AutoPlay window does not appear. Please click [My Computer]-->[DVAP]-->[DVAP.exe] to execute the application.)



(In Windows XP)

3. The main screen appears automatically on the desktop. (To view the recorded clips on Internet Direct, it is necessary to install ArcSoft MediaImpression first. )



**Note**

- The web site may be not allowed to access in certain regions.



4. On the thumbnail screen, click on the up/down icon to change the pages. Click on the file(s) you want to upload.
5. Click on "UPLOAD" to start uploading.



6. Click on "CANCEL" to stop uploading.



**To playback the video file:**

1. Double click on the video clip on the thumbnail screen.
2. Click on the Play/Pause icon  to play/pause. Click on the Return icon  to return to the thumbnail preview screen.



**To setup your account information for the website:**

1. Click on  to go to the setup screen.
2. Fill in your account information in the blanks. Then click on "Save".

(If you do not have a account, please sign up on the website first.)

## Section 9

# Specifications and System Requirements

Specification	
Image sensor	5 Mega pixel CMOS sensor
Operation modes	Video record, Photo record
Lens	Auto Focus Lens (F3.5)
Focus range	Macro Mode:1cm~120cm Normal Mode: 1 cm ~ infinite
Zoom	1X~2700X (23X Optical zoom and 120X Digital zoom)
Shutter	Electronic
LCD monitor	3" touch LCD (16:9)
Storage media	Built-in 128MB memory (partial memory is used for firmware code and software); SD/SDHC/SDXC card slot support (up to 64GB)
Image resolution	High 4608 x 3456 (16M pixels) (Interpolated) Standard 2592x1944 (5M pixels) Low 2048x1536 (3M pixels)
Video resolution	FHD (1080p 30) 1920X1080(30fps) HD+ (720p 60) 1280X720(60fps) HD (720p 30) 1280X720(30fps) VGA (640X480) 640X480(30fps)
White balance	Auto/Manual (Daylight, Fluorescent, Tungsten)
ISO	Auto/800/1600/3200/6400
Self-timer	10 seconds delay
Flash	Flash Auto/Red-Eye-Reduction/Flash Off
File format	Photo: JPG Video: AVI
Image play	Single image/Slideshow
PC interface	Mini USB 2.0 port
TV out	NTSC/PAL selectable, HDMI
Battery	Lithium-ion rechargeable battery
Dimension	126mm (L) x 57mm (H) x 60mm (W)
Weight	340g ( without battery)

## System requirements

- Microsoft Windows XP/Vista/7
- Intel Pentium 4, 2.4 GHz or above
- 512 MB RAM
- 1 GB free HDD space
- Available USB port
- CD-ROM Drive
- 16-bit Color Display



### **Note**

*The LCD screen is manufactured using extremely high-precision technology, so over 99.99% of the pixels are operational for effective use. However, some tiny black and/or bright dots (white, red, blue or green) may appear on the LCD screen. These dots are a normal result of the manufacturing process, and do not affect the recording.*

# Section 10

## Troubleshooting

### Troubleshooting

#### 1. The flash is not working.

The battery power is low.

The camcorder is in DC power mode.

In flash auto mode, camcorder flash fires ONLY when necessary (in dark setting as example).

#### 2. The files on the memory card do not display smoothly when the LCD shows the “!” marking.

The “!” means the SD card is low speed or is having wrong content inside. The way to solve this condition is to format SD card by the camcorder instead of a PC (Please refer to the detailed Format instruction in Section 5).

Or please change the SD/SDHC/SDXC card to a high speed one.

#### 3. Why do some of my indoor photos look blurry and dark?

The camcorder extends photo exposure time under low light/ indoor condition. Keep the camcorder (and

the target subject) steady for several seconds when taking photos. The shutter will sound when photos are being taken.

#### 4. How do I charge battery?

You must use the supplied AC charger or the USB cable. The camcorder must be turned OFF. The blinking light confirms the camcorder is currently charging, and the light becomes constant after the charging is completed. In AC charging Mode, the light will turn itself off automatically after 3~5 minutes . The full charge time is about 4 to 5 hours. (Actual charging time may vary. It depends on the battery conditions.)

#### 5. After connecting the USB cable to the computer, .....

1. The disk [DV] indicates the internal memory of the camcorder. (The disk label may be different according to different model and PC OS.)
2. [Removable Disk] indicates the external memory. (Under the circumstances of within the SD/SDHC/SDXC card in the camcorder)
3. The disk [DVAP] indicates the built-in Internet Direct application is saved at this disk. Please DO NOT format this disk or delete the application inside; otherwise, the Internet Direct application can not function.





# Section 11

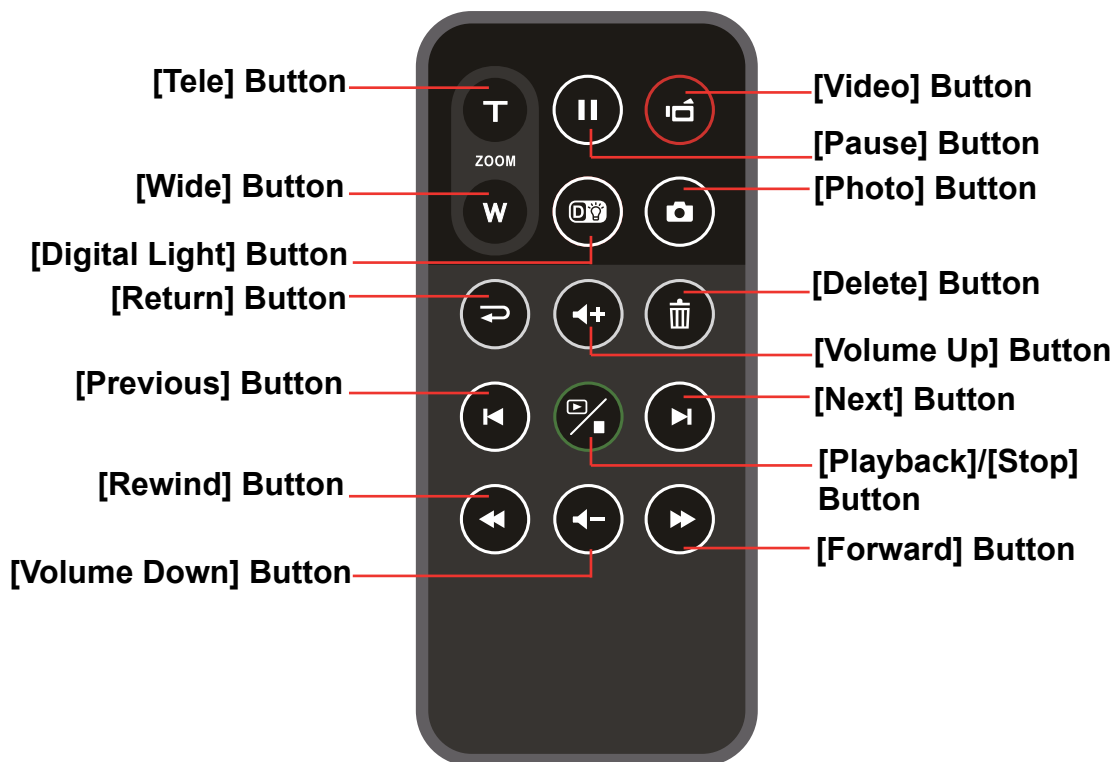





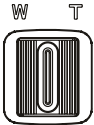



## Using Remote Control

### Remote Control



### Button Functions

	<p><b>Video Button:</b></p> <ol style="list-style-type: none"> <li>1. Press to take video.</li> <li>2. To stop recording, press it again.</li> </ol>
	<p><b>Pause Button:</b></p> <ol style="list-style-type: none"> <li>1. Press to pause the recording.</li> <li>2. To continue the recording, press it again.</li> <li>3. In Video Playback Mode, press to pause the recorded video.</li> </ol>
	<p><b>Tele Button:</b></p> <ol style="list-style-type: none"> <li>1. Zoom In.</li> </ol> <p><b>Wide Button</b></p> <ol style="list-style-type: none"> <li>1. Zoom out.</li> </ol>
	<p><b>Photo Button:</b></p> <ol style="list-style-type: none"> <li>1. Press to take photo.</li> </ol>

	<b>Digital Light Button:</b> 1. Digital Light On/Off.
	<b>Delete Button:</b> 1. Delete the current or all videos/photos.
	<b>Volume Up Button:</b> 1. Volume increase.
	<b>Return Button:</b> 1. Return to the previous screen.
	<b>Next Button:</b> 1. Go to the next video/photo
	<b>Playback/Stop Button:</b> 1. Switch to the Playback Mode. 2. For quick review, press it after recording. 3. In Video Playback Mode, press to stop the recorded video.
	<b>Previous Button:</b> 1. Go to the previous video/photo
	<b>Forward Button:</b> 1. Video fast forward
	<b>Volume Down Button:</b> 1. Volume decrease.
	<b>Rewind Button:</b> 1. Video fast rewind



### Note

- Record menu is not accessible via the remote control.
- When the battery power of the remote control becomes weak, the remote control may not function properly. In this case, please replace the battery.



# Customer Support

For technical support or product service, see the table below or contact your reseller.

**Note :** You will need the product serial number.

Country/Region	Website	T = Telephone F = FAX	Email
Australia/New Zealand	www.viewsonic.com.au	AUS= 1800 880 818 NZ= 0800 008 822	service@au.viewsonic.com
Canada	www.viewsonic.com	T (Toll-Free)= 1-866-463-4775 T (Toll)= 1-424-233-2533 F= 1-909-468-3757	service.ca@viewsonic.com
Europe	www.viewsoniceurope.com	www.viewsoniceurope.com/uk/Support/Calldesk.htm	
Hong Kong	www.hk.viewsonic.com	T= 852 3102 2900	service@hk.viewsonic.com
India	www.in.viewsonic.com	T= 1800 266 0101	service@in.viewsonic.com
Ireland (Eire)	www.viewsoniceurope.com/uk/	www.viewsoniceurope.com/uk/support/call-desk/	service_ie@viewsoniceurope.com
Korea	www.kr.viewsonic.com	T= 080 333 2131	service@kr.viewsonic.com
Latin America (Argentina)	www.viewsonic.com/la/	T= 0800-4441185	soporte@viewsonic.com
Latin America (Chile)	www.viewsonic.com/la/	T= 1230-020-7975	soporte@viewsonic.com
Latin America (Columbia)	www.viewsonic.com/la/	T= 01800-9-157235	soporte@viewsonic.com
Latin America (Mexico)	www.viewsonic.com/la/	T= 001-8882328722	soporte@viewsonic.com
Renta y Datos, 29 SUR 721, COL. LA PAZ, 72160 PUEBLA, PUE. Tel: 01.222.891.55.77 CON 10 LINEAS Electroser, Av Reforma No. 403Gx39 y 41, 97000 Mérida, Yucatán. Tel: 01.999.925.19.16 Other places please refer to <a href="http://www.viewsonic.com/la/soporte/index.htm#Mexico">http://www.viewsonic.com/la/soporte/index.htm#Mexico</a>			
Latin America (Peru)	www.viewsonic.com/la/	T= 0800-54565	soporte@viewsonic.com
Macau	www.hk.viewsonic.com	T= 853 2870 0303	service@hk.viewsonic.com
Middle East	ap.viewsonic.com/me/	Contact your reseller	service@ap.viewsonic.com
Puerto Rico & Virgin Islands	www.viewsonic.com	T= 1-800-688-6688 (English) T= 1-866-379-1304 (Spanish) F= 1-909-468-3757	service.us@viewsonic.com soporte@viewsonic.com
Singapore/Malaysia/Thailand	www.viewsonic.com.sg	T= 65 6461 6044	service@sg.viewsonic.com
South Africa	ap.viewsonic.com/za/	Contact your reseller	service@ap.viewsonic.com
United Kingdom	www.viewsoniceurope.com/uk/	www.viewsoniceurope.com/uk/support/call-desk/	service_gb@viewsoniceurope.com
United States	www.viewsonic.com	T (Toll-Free)= 1-800-688-6688 T (Toll)= 1-424-233-2530 F= 1-909-468-3757	service.us@viewsonic.com

# Limited Warranty

## ViewSonic® Digital Video Camcorder

### What the warranty covers:

ViewSonic warrants its products to be free from defects in material and workmanship, under normal use, during the warranty period. If a product proves to be defective in material or workmanship during the warranty period, ViewSonic will, at its sole option, repair or replace the product with a like product. Replacement product or parts may include remanufactured or refurbished parts or components.

### How long the warranty is effective:

ViewSonic Digital Video Camcorder are warranted for 1 year for labor from the date of the first customer purchase.

### Who the warranty protects:

This warranty is valid only for the first consumer purchaser.

### What the warranty does not cover:

1. Any product on which the serial number has been defaced, modified or removed.
2. Damage, deterioration or malfunction resulting from:
  - a. Accident, misuse, neglect, fire, water, lightning, or other acts of nature, unauthorized product modification, or failure to follow instructions supplied with the product.
  - b. Any damage of the product due to shipment.
  - c. Removal or installation of the product.
  - d. Causes external to the product, such as electrical power fluctuations or failure.
  - e. Use of supplies or parts not meeting ViewSonic's specifications.
  - f. Normal wear and tear.
  - g. Any other cause which does not relate to a product defect.
3. Any product exhibiting a condition commonly known as "image burn-in" which results when a static image is displayed on the product for an extended period of time.
4. Removal, installation, one way transportation, insurance, and set-up service charges.

### How to get service:

1. For information about receiving service under warranty, contact ViewSonic Customer Support (please refer to Customer Support page). You will need to provide your product's serial number.
2. To obtain warranted service, you will be required to provide (a) the original dated sales slip, (b) your name, (c) your address, (d) a description of the problem, and (e) the serial number of the product.
3. Take or ship the product freight prepaid in the original container to an authorized ViewSonic service center or ViewSonic.
4. For additional information or the name of the nearest ViewSonic service center, contact ViewSonic.

**Limitation of implied warranties:**

There are no warranties, express or implied, which extend beyond the description contained herein including the implied warranty of merchantability and fitness for a particular purpose.

**Exclusion of damages:**

ViewSonic's liability is limited to the cost of repair or replacement of the product. ViewSonic shall not be liable for:

1. Damage to other property caused by any defects in the product, damages based upon inconvenience, loss of use of the product, loss of time, loss of profits, loss of business opportunity, loss of goodwill, interference with business relationships, or other commercial loss, even if advised of the possibility of such damages.
2. Any other damages, whether incidental, consequential or otherwise.
3. Any claim against the customer by any other party.
4. Repair or attempted repair by anyone not authorized by ViewSonic.

4.3: ViewSonic Digital Video Camcorder Warranty

3DC\_LW01 Rev. 1A 08-05-08

# Mexico Limited Warranty

## ViewSonic® Digital Video Camcorder

### What the warranty covers:

ViewSonic warrants its products to be free from defects in material and workmanship, under normal use, during the warranty period. If a product proves to be defective in material or workmanship during the warranty period, ViewSonic will, at its sole option, repair or replace the product with a like product. Replacement product or parts may include remanufactured or refurbished parts or components.

### How long the warranty is effective:

ViewSonic Digital Video Camcorder are warranted for 1 year for labor from the date of the first customer purchase.

### Who the warranty protects:

This warranty is valid only for the first consumer purchaser.

### What the warranty does not cover:

1. Any product on which the serial number has been defaced, modified or removed.
2. Damage, deterioration or malfunction resulting from:
  - a. Accident, misuse, neglect, fire, water, lightning, or other acts of nature, unauthorized product modification, or failure to follow instructions supplied with the product.
  - b. Any damage of the product due to shipment.
  - c. Removal or installation of the product.
  - d. Causes external to the product, such as electrical power fluctuations or failure.
  - e. Use of supplies or parts not meeting ViewSonic's specifications.
  - f. Normal wear and tear.
  - g. Any other cause which does not relate to a product defect.
3. Any product exhibiting a condition commonly known as "image burn-in" which results when a static image is displayed on the product for an extended period of time.
4. Removal, installation, one way transportation, insurance, and set-up service charges.

### How to get service:

For information about receiving service under warranty, contact ViewSonic Customer Support (Please refer to the attached Customer Support page). You will need to provide your product's serial number, so please record the product information in the space provided below on your purchase for your future use. Please retain your receipt of proof of purchase to support your warranty claim.

For Your Records

Product Name: \_\_\_\_\_

Model Number: \_\_\_\_\_

Document Number: \_\_\_\_\_

Serial Number: \_\_\_\_\_

Purchase Date: \_\_\_\_\_  
(Y/N)

Extended Warranty Purchase? \_\_\_\_\_

If so, what date does warranty expire? \_\_\_\_\_

1. To obtain warranty service, you will be required to provide (a) the original dated sales slip, (b) your name, (c) your address, (d) a description of the problem, and (e) the serial number of the product.
2. Take or ship the product in the original container packaging to an authorized ViewSonic service center.
3. Round trip transportation costs for in-warranty products will be paid by ViewSonic.

### Limitation of implied warranties:

There are no warranties, express or implied, which extend beyond the description contained herein including the implied warranty of merchantability and fitness for a particular purpose.

### Exclusion of damages:

ViewSonic's liability is limited to the cost of repair or replacement of the product. ViewSonic shall not be liable for:

1. Damage to other property caused by any defects in the product, damages based upon inconvenience, loss of use of the product, loss of time, loss of profits, loss of business opportunity, loss of goodwill, interference with business relationships, or other commercial loss, even if advised of the possibility of such damages.
2. Any other damages, whether incidental, consequential or otherwise.
3. Any claim against the customer by any other party.
4. Repair or attempted repair by anyone not authorized by ViewSonic.

<b>Contact Information for Sales &amp; Authorized Service (Centro Autorizado de Servicio) within Mexico:</b>	
<b>Name, address, of manufacturer and importers:</b> México, Av. de la Palma #8 Piso 2 Despacho 203, Corporativo Interpalmas, Col. San Fernando Huixquilucan, Estado de México Tel: (55) 3605-1099 <a href="http://www.viewsonic.com/la/soporte/index.htm">http://www.viewsonic.com/la/soporte/index.htm</a>	
<b>NÚMERO GRATIS DE ASISTENCIA TÉCNICA PARA TODO MÉXICO: 001.866.823.2004</b>	
<b>Hermosillo:</b> Distribuciones y Servicios Computacionales SA de CV. Calle Juarez 284 local 2 Col. Bugambillas C.P: 83140 Tel: 01-66-22-14-9005 E-Mail: <a href="mailto:disc2@hmo.megared.net.mx">disc2@hmo.megared.net.mx</a>	<b>Villahermosa:</b> Compumantenimientos Garantizados, S.A. de C.V. AV. GREGORIO MENDEZ #1504 COL, FLORIDA C.P. 86040 Tel: 01 (993) 3 52 00 47 / 3522074 / 3 52 20 09 E-Mail: <a href="mailto:compumantenimientos@prodigy.net.mx">compumantenimientos@prodigy.net.mx</a>
<b>Puebla, Pue. (Matriz):</b> RENTA Y DATOS, S.A. DE C.V. Domicilio: 29 SUR 721 COL. LA PAZ 72160 PUEBLA, PUE. Tel: 01(52).222.891.55.77 CON 10 LINEAS E-Mail: <a href="mailto:datos@puebla.megared.net.mx">datos@puebla.megared.net.mx</a>	<b>Veracruz, Ver.:</b> CONEXION Y DESARROLLO, S.A DE C.V. Av. Americas # 419 ENTRE PINZÓN Y ALVARADO Fracc. Reforma C.P. 91919 Tel: 01-22-91-00-31-67 E-Mail: <a href="mailto:gacosta@qplus.com.mx">gacosta@qplus.com.mx</a>
<b>Chihuahua</b> Soluciones Globales en Computación C. Magisterio # 3321 Col. Magisterial Chihuahua, Chih. Tel: 4136954 E-Mail: <a href="mailto:Cefeo@soluglobales.com">Cefeo@soluglobales.com</a>	<b>Cuernavaca</b> Compusupport de Cuernavaca SA de CV Francisco Leyva # 178 Col. Miguel Hidalgo C.P. 62040, Cuernavaca Morelos Tel: 01 777 3180579 / 01 777 3124014 E-Mail: <a href="mailto:aquevedo@compusupportcva.com">aquevedo@compusupportcva.com</a>
<b>Distrito Federal:</b> QPLUS, S.A. de C.V. Av. Coyoacán 931 Col. Del Valle 03100, México, D.F. Tel: 01(52)55-50-00-27-35 E-Mail : <a href="mailto:gacosta@qplus.com.mx">gacosta@qplus.com.mx</a>	<b>Guadalajara, Jal.:</b> SERVICRECE, S.A. de C.V. Av. Niños Héroes # 2281 Col. Arcos Sur, Sector Juárez 44170, Guadalajara, Jalisco Tel: 01(52)33-36-15-15-43 E-Mail: <a href="mailto:mmiranda@servicrece.com">mmiranda@servicrece.com</a>
<b>Guerrero Acapulco</b> GS Computación (Grupo Sesicomp) Progreso #6-A, Colo Centro 39300 Acapulco, Guerrero Tel: 744-48-32627	<b>Monterrey:</b> Global Product Services Mar Caribe # 1987, Esquina con Golfo Pérsico Fracc. Bernardo Reyes, CP 64280 Monterrey N.L. México Tel: 8129-5103 E-Mail: <a href="mailto:aydeem@gps1.com.mx">aydeem@gps1.com.mx</a>
<b>MERIDA:</b> ELECTROSER Av Reforma No. 403Gx39 y 41 Mérida, Yucatán, México CP97000 Tel: (52) 999-925-1916 E-Mail: <a href="mailto:rrrb@sureste.com">rrrb@sureste.com</a>	<b>Oaxaca, Oax.:</b> CENTRO DE DISTRIBUCION Y SERVICIO, S.A. de C.V. Murguía # 708 P.A., Col. Centro, 68000, Oaxaca Tel: 01(52)95-15-15-22-22 Fax: 01(52)95-15-13-67-00 E-Mail: <a href="mailto:gpotai2001@hotmail.com">gpotai2001@hotmail.com</a>
<b>Tijuana:</b> STD Av Ferrocarril Sonora #3780 L-C Col 20 de Noviembre Tijuana, Mexico	<b>FOR USA SUPPORT:</b> ViewSonic Corporation 381 Brea Canyon Road, Walnut, CA. 91789 USA Tel: 800-688-6688 (English); 866-323-8056 (Spanish); Fax: 1-800-685-7276 E-Mail: <a href="http://www.viewsonic.com">http://www.viewsonic.com</a>



**ViewSonic®**

## Free Manuals Download Website

<http://myh66.com>

<http://usermanuals.us>

<http://www.somanuals.com>

<http://www.4manuals.cc>

<http://www.manual-lib.com>

<http://www.404manual.com>

<http://www.luxmanual.com>

<http://aubethermostatmanual.com>

Golf course search by state

<http://golfingnear.com>

Email search by domain

<http://emailbydomain.com>

Auto manuals search

<http://auto.somanuals.com>

TV manuals search

<http://tv.somanuals.com>