

FCC STATEMENT

This device complies with Part 15 of the FCC Rules. Operation is subject to the following two conditions:

- (1) This device may not cause harmful interference, and
- (2) This device must accept any interference received, including interference that may cause undesired operation.

Note:

This equipment has been tested and found to comply with the limits for Class B digital devices, pursuant to Part 15 of the FCC rules. These limits are designed to provide reasonable protection against harmful interference in a residential installation. This equipment generates uses and can radiate radio frequency energy and, if not installed and used in accordance with the instructions, may cause harmful interference to radio communications. However, there is no guarantee that interference will not occur in a particular installation. If this equipment does cause harmful interference to radio or television reception, which can be determined by turning the equipment off and on, the user is encouraged to try to correct the interference by one or more of the following measures:

- Reorient or relocate the receiving antenna.
- Increase the separation between the equipment and receiver.
- Connect the equipment into an outlet on a circuit different from that to which the receiver is connected.
- Consult the dealer or an experienced radio/TV technician for help.

Use of shielded cable is required to comply with Class B limits in Subpart B of Part 15 of the FCC rules.

Do not make any changes or modifications to the equipment unless otherwise specified in the manual. If such changes or modifications should be made, you could be required to stop operation of the equipment.

READ THIS FIRST

Trademark Information

- Microsoft® and Windows® are U.S. registered trademarks of Microsoft Corporation.
- Pentium® is a registered trademark of Intel Corporation.
- Macintosh is a trademark of Apple Computer, Inc.
- SD™ is a trademark.
- Photo Explorer and Photo Express are trademarks.
- Other names and products may be trademarks or registered trademarks of their respective owners.

Product Information

- Product design and specifications are subject to change without notice. This includes primary product specifications, software, software drivers, and user's manual. This User Manual is a general reference guide for the product.
- The product and accessories that come with your ViviCam 8400 may be different from those described in this manual. This is due to the fact that different retailers often specify slightly different product inclusions and accessories to suit their market requirements, customer demographics, and geographical preferences. Products very often vary between retailers especially with accessories such as batteries, chargers, AC adapters, memory cards, cables, carrying cases/pouches, and language support. Occasionally a retailer will specify a unique product color, appearance, and internal memory capacity. Contact your dealer for precise product definition and included accessories.
- The illustrations in this manual are for the purpose of explanation and may differ from the actual design of your ViviCam 8400.
- The manufacturer assumes no liability for any errors or discrepancies in this user manual.
- For user manual and driver updates, refer to the Vivitar website www.vivitar.com, or contact your dealer.

SAFETY INSTRUCTIONS

Read and understand all **Warnings** and **Cautions** before using this product.

Warnings

If foreign objects or water have entered the camera, turn the power OFF and remove the batteries and the AC power adapter.

Continued use in this state might cause fire or electric shock. Consult the store of purchase.



If the camera has fallen or its case has been damaged, turn the power OFF and remove the batteries and the AC power adapter.

Continued use in this state might cause fire or electric shock. Consult the store of purchase.



Do not disassemble, change or repair the camera.

This might cause fire or electric shock. For repair or internal inspection, ask the store of purchase.



Use the AC adapter (Optional Accessory) only with the indicated power supply voltage.

Use with any other power supply voltage might cause fire or electric shock.



Do not use the camera in areas near water.

This might cause fire or electric shock. Take special care during rain, snow, on the beach, or near the shore.



Do not place the camera on inclined or unstable surfaces.

This might cause the camera to fall or tilt over, causing injury.



Keep the batteries out of the reach of children.

Swallowing batteries might cause poisoning. If the battery is accidentally swallowed, immediately consult a physician.



Do not use the camera while you are walking, driving or riding a motorcycle.

This might cause you to fall over or result in traffic accident.



Cautions

Insert the batteries paying careful attention to the polarity (+ or -) of the terminals.

Inserting the batteries with its polarities inverted might cause fire and injury, or damage to the surrounding areas due to the battery rupturing or leaking.



Do not fire the flash close to anyone's eyes.

This might cause damage to the person's eyesight.



Do not subject the LCD monitor to impact.

This might damage the glass on the screen or cause the internal fluid to leak. If the internal fluid enters your eyes or comes into contact with your body or clothes, rinse with fresh water. If the internal fluid has entered your eyes, consult a physician to receive treatment.



A camera is a precision instrument. Do not drop it, strike it or use excessive force when handling the camera.

This might cause damage to the camera.



Do not use the camera in humid, steamy, smoky, or dusty places.

This might cause fire or electric shock.



Do not remove the battery immediately after long period of continuous use.

The battery becomes hot during use. Touching a hot battery might cause burns.



Do not wrap the camera or place it in cloth or blankets.

This might cause heat to build up and deform the case, resulting in fire. Use the camera in a well-ventilated place.



Do not leave the camera in places where the temperature may rise significantly, such as inside a car.

This might adversely affect the case or the parts inside, resulting in fire.



Before you move the camera, disconnect cords and cables.

Failure to do this might damage cords and cables, resulting in fire and electric shock.



WARNING: Handling the USB on this product may expose you to lead, a chemical known to the State of California to cause birth defects or other reproductive harm. ***Wash hands after handling.***

Notes on Battery Usage

- Do not use batteries other than those specified for use with your ViviCam 8400. Use of unsuitable batteries may result in the batteries splitting, or leaking and may cause a fire, injury, or soiling of the battery compartment.
- When placing the batteries into the ViviCam 8400, check the polarity markings on the batteries (- and +) to ensure that the batteries are inserted correctly. Incorrect battery polarity will result in ViviCam inoperability and may result in the batteries splitting or leaking and causing a fire, injury, or soiling of the battery compartment.
- Remove the batteries if the ViviCam 8400 will not be used for an extended period of time. The batteries may leak and cause a fire, injury or soiling of the battery compartment. If the batteries leak, clean and wipe the battery compartment carefully and install new batteries. Wash your hands carefully if you touch the battery fluid.

When using batteries, carefully read and strictly observe the Safety Instructions and the notes described below:

- Ni-MH rechargeable batteries are highly recommended. To maximize performance and lifetime, we recommend that you fully charge the batteries and discharge them for at least one complete cycle before use.
- Avoid using batteries in extremely cold environments as low temperatures can shorten the battery life and reduce ViviCam 8400's performance. Low temperature will adversely affect alkaline battery performance.
- Using new rechargeable batteries or rechargeable batteries that have not been used for an extended period of time will affect the number of images that can be captured.
- If you will not be using the batteries for an extended period of time, remove them from the ViviCam 8400 to prevent leakage or corrosion.
- Never use batteries of different types (together) or mix old and new batteries. Never use manganese batteries.
- More information about batteries is provided in this manual in subsequent sections.

CONTENTS

INTRODUCTION	8	PHOTOGRAPHY MODE.....	23
Package Contents.....	9	Shooting Images - The Basics.....	23
GETTING TO KNOW YOUR VIVICAM 8400.....	10	Setting Image Resolution and Quality	24
Front View.....	10	Using the Zoom Function.....	25
Rear View.....	11	Setting Focus.....	26
Mode Dial	12	Using the Flash.....	27
LCD Monitor Information.....	13	Using the Self-Timer.....	28
PREPARING YOUR VIVICAM 8400.....	15	Adjusting the Exposure (EV Compensation) /	
Installing the Batteries	15	Backlight Correction.....	29
Using the AC Power Adapter		Setting White Balance.....	30
(Optional Accessory).....	16	USING THE MODE DIAL.....	31
Inserting and Removing an SD Memory Card		[A] Auto Mode.....	31
(Optional Accessory)	17	[P] Program Mode	31
Attaching the Camera Strap.....	18	[Tv] Shutter Speed Priority Photography Mode.....	32
LED Indicators.....	18	[A _v] Aperture Priority Mode.....	32
GETTING STARTED.....	19	[M] Manual Mode.....	33
Turning the Power On/Off	19	[SCENE] Scene Mode.....	33
Choosing the Screen Language.....	19	ADVANCED SHOOTING.....	34
Setting the Date and Time	20	Burst.....	34
Formatting an SD Memory Card or Internal		Auto Exposure Bracketing (AEB)	35
Memory.....	21	Selecting the Metering Mode	36
Using the LCD Monitor.....	22		

PLAYBACK MODE - THE BASICS.....	37	EDITING SOFTWARE INSTALLATION.....	55
Viewing Images	37	Installing Photo Explorer.....	55
Magnifying Images	38	Installing Photo Express.....	56
Thumbnail Display	39	INSTALLING ADOBE ACROBAT READER.....	57
Slideshow Display	40	USER MANUAL.....	58
Resizing an Image	41	MENU OPTIONS.....	59
VIDEO MODE.....	42	Camera Menu.....	59
Recording Video Clips	42	Video Menu	63
Playing Back Video Clips	43	Playback Menu.....	64
PLAYBACK MODE – ADVANCED FEATURES...44		Setup Menu.....	66
Playing Back Still Images/Video Clips on TV	44	CONNECTING THE VIVICAM 8400 TO	
Deleting Images/Video Clips.....	45	OTHER DEVICES.....	68
Protecting Images/Video Clips	46	VIVICAM 8400 SPECIFICATIONS.....	69
Connecting to a PictBridge Compliant Printer.....	47	APPENDIX.....	70
TRANSFERRING FILES FROM VIVICAM 8400 TO			
COMPUTER.....	51		
Step 1: Install the USB driver	52		
Step 2: Connect the ViviCam 8400 to your			
computer.....	53		
Step 3: Download images or video clips.....	54		

INTRODUCTION

Thank you for purchasing the new ViviCam 8400!

Equipped with a 8.0 Megapixels CCD sensor, your ViviCam 8400 delivers quality, 3264 x 2448 resolution images. Other features provided by the ViviCam 8400 include the following:

■ 8.0 Megapixels

A high-resolution CCD sensor provides 8.0 megapixels for excellent image quality.

■ Auto flash

An auto flash sensor automatically detects the shooting (lighting) conditions and determines whether the flash should be used.

■ 2.0" LTPS color image LCD monitor

■ Optical zoom : 1x~3x

■ Digital zoom: 1x~4x

■ 32MB internal (built-in) memory

Images can be captured without using a memory card.

■ Support for SD memory card for memory expansion

You may wish to expand the memory capacity (up to 1GB) by using an external memory card.

■ USB connection (USB 2.0 compliant)

Still images, video clips, or voice recording files that you have recorded can be downloaded to your computer using the USB cable (A USB driver is required for Win 98 and Win98SE).

■ PictBridge support

You can connect the ViviCam 8400 directly to a printer that supports PictBridge and perform image selection and printing using the ViviCam 8400 monitor screen and controls.

■ Provided editing software: Photo Explorer / Photo Express

You can enhance and retouch your images on your computer by using the provided editing software.

Package Contents

Carefully unpack your kit box and ensure that you have the following items. In the event that any item is missing or if you find any mismatch or damage, promptly contact your dealer.

Common Product Components:

- ViviCam 8400 Digital Camera
- User's Manual
- USB Cable
- Software CD-ROM
- AV Cable
- Camera Strap
- Camera Pouch

Common (Optional) Accessories:

- SD memory card
- AC power adapter
- Batteries



-
- The product and accessories that come with your ViviCam 8400 may be different from those described in this manual. This is due to the fact that different retailers often specify slightly different product inclusions and accessories to suit their market requirements, customer demographics, and geographical preferences. Products vary between retailers especially with accessories such as batteries, chargers, memory cards, cables, carrying cases/pouches, and language support. Occasionally a retailer will specify a unique product color, appearance, and internal memory capacity. Contact your dealer for precise product definition and included accessories.

GETTING TO KNOW YOUR VIVICAM 8400

Front View

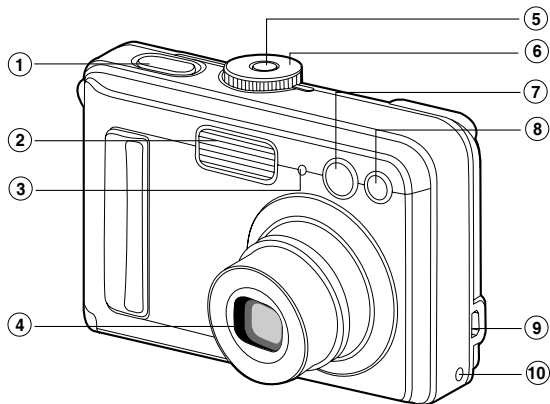

1. Shutter button

2. Flash

3. Microphone

4. Lens

5. Power button

6. Mode dial

7. Viewfinder window

8. Self-timer LED

9. PC (USB) / AV Out terminal

10. DC in 3V terminal

Rear View

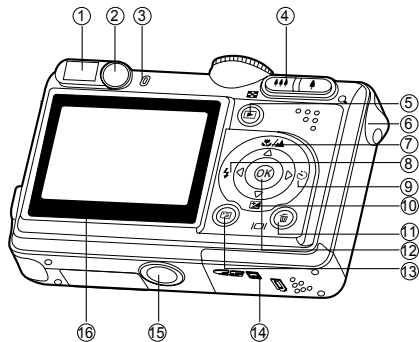

- 1. Viewfinder

- 2. Diopter adjustment dial

- 3. Viewfinder LED

- 4. / Zoom in (telephoto) button
 / Zoom out (wide-angle) button
/ Thumbnail button

- 5. Playback button

- 6. Strap holder

- 7. Arrow button (Up)
 / Focus button

- 8. Arrow button (Left)
 Flash button

- 9. Arrow button (Right)
 Self-timer button

- 10. Arrow button (Down)
 Exposure compensation button

- 11. Delete button
 Display button

- 12. OK button

- 13. Menu button

- 14. Battery / SD card cover

- 15. Tripod socket

- 16. LCD monitor

Mode Dial

You can select from seven modes and setup mode according to conditions to achieve the desired effect.

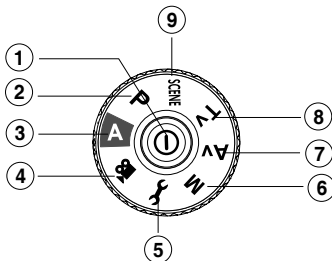

	Mode	Description
1.	⓪	Power button Press to turn on/off the power.
2.	P	Program Select this mode to permit the shutter speed and aperture to be set automatically.
3.	A	Auto Select this mode to adjust point-and-shoot action.
4.	📹	Video Select this mode to record video clips.
5.	🔧	Setup Select this mode to adjust VIVICAM 8400 settings.
6.	M	Manual Select this mode to permit full manual control over exposure, aperture and other settings.
7.	Av	Aperture priority Select this mode to specify the aperture value while the ViviCam 8400 sets the corresponding shutter speed.
8.	Tv	Shutter speed priority Select this mode to specify the shutter speed while the ViviCam 8400 sets the corresponding aperture.
9.	SCENE	SCENE Point-and-shoot simplicity when taking pictures under 4 special conditions.

LCD Monitor Information

■ Camera Mode

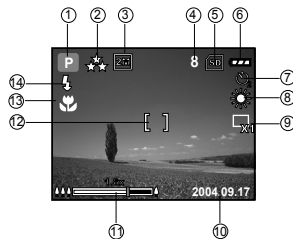

1. Mode indication

[**P**] Program Mode

[**A**] Auto Mode

[] Video Mode

[**M**] Manual Mode

[**Av**] Aperture priority Mode

[**Tv**] Shutter speed priority

[**SCENE**] SCENE Mode

2. Image quality

[] Fine

[] Normal

[] Economy

3. Image size

[] 3264 x 2448

[] 2272 x 1704

[] 1600 x 1200

[] 640 x 480

4. Possible number of shots

5. Internal memory/SD memory card indicator

[] Status of internal memory

[] Status of SD memory card

6. Remaining battery status

[] Full battery power

[] Medium battery power

[] Low battery power

[] No battery power

7. Self-timer mode

[] OFF

[] 2 sec. delay

[] 10 sec. delay

[] 10+2 sec. delay

8. White balance

Auto

[] Daylight

[] Cloudy

[] Tungsten

[] Fluorescent

9. Capture mode indicator

[] Single

[] Burst

[] AEB

10. Date

11. Zoom status

12. Focus area

13. Focus indicator

(no indication for auto focus)

[] Macro

[] Infinity

[**AF**] Auto focus

14. Flash mode

[] Auto Flash (Default)

[] Red Eye

[] Forced flash

[] No Flash

■ Video Mode

1. Video mode
2. Recordable movie time available
3. SD memory card indicator (if present)
4. Battery power indicator
5. Focus area



■ Image Playback

1. Playback mode
2. SD memory card indicator (if present)
3. Battery power indicator
4. Playback information



■ Video Playback

1. Playback mode
2. Video mode
3. SD memory card indicator (if present)
4. Battery power indicator
5. Playback indicator
6. Playback information



PREPARING THE VIVICAM 8400

Installing the Batteries

You can use 2 AA size batteries to power the ViviCam 8400. Make sure that the power of the ViviCam 8400 is off before inserting or removing the batteries.

1. Make sure the ViviCam 8400 is turned off.
2. Open the battery cover.
3. Insert the batteries in the correct orientation as shown in the illustration.
4. Close the battery cover.
 - To remove the batteries, turn the Vivicam 8400 off and hold the camera with the battery compartment facing upward. Then open the battery cover.

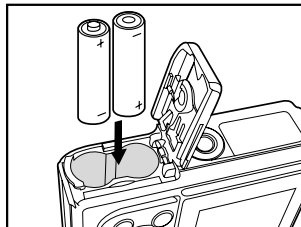

-
- Be careful not to drop the batteries when opening or closing the battery cover.
 - While alkaline batteries offer limited use, Ni-MH rechargeable type AA batteries are strongly recommended for performance and economy.

Using the AC Power Adapter (Optional Accessory)

Use of the AC power adapter is recommended if you intend to use the LCD monitor for a long time or connect the ViviCam 8400 to a PC.

1. Make sure your ViviCam 8400 is turned off.
2. Connect one end of the AC power adapter to the camera jack labeled "DC IN 3.0V".
3. Connect the other end to an electrical outlet.

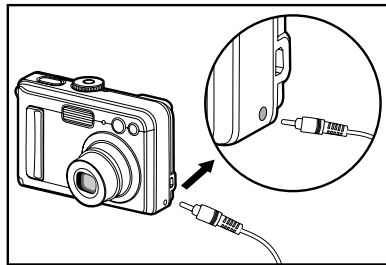

- Make sure to use only the AC power adapter specified for the ViviCam 8400. Damage caused by the use of an incorrect adapter is not covered under the warranty.
- To prevent unexpected auto power off resulting from no battery power left during the process of transferring your images to the computer, use the AC power adapter as a power supply or a freshly-charged pair of Ni-MH batteries.
- The AC power adapter can only be used to power the ViviCam 8400. Batteries cannot be charged inside the ViviCam 8400.

Inserting and Removing an SD Memory Card (Optional Accessory)

The ViviCam 8400 comes with 32MB of internal memory, allowing you to store captured still images or video clips in the ViviCam 8400. You can also expand the memory capacity by using an optional SD (Secure Digital) memory card so that you can store more files.

1. Make sure your ViviCam 8400 is turned off before inserting or removing a memory card.
2. Open the SD memory card cover.
3. Insert an SD memory card in the correct orientation as shown in the illustration and press downward until it clicks into place.
4. Close the battery/SD memory card cover.
 - To remove the SD memory card, make sure the ViviCam 8400 is turned off. Press lightly on the edge of the memory card and it will eject.

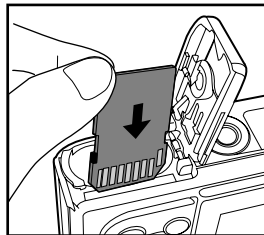

- Be sure to format an SD memory card with this ViviCam 8400 before using it. Refer to section in the manual titled **“Formatting an SD Memory Card or Internal Memory”** for further details.
- To prevent valuable data from being accidentally erased from an SD card, you can slide the write protect tab (on the side of the SD memory card) to “LOCK”.
- To save, edit, or erase data on an SD memory card, you must unlock the card.
- The ViviCam 8400, like most digital cameras will automatically use a memory card if it is inserted into the memory card slot. This is called “card preference”. Data stored in internal memory will not be accessible if a memory card is present. To again access your data stored in internal memory, simply remove the SD card.

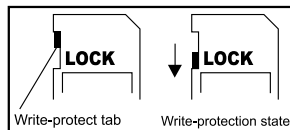

Attaching the Camera Strap

Attach the strap as shown in the illustration.

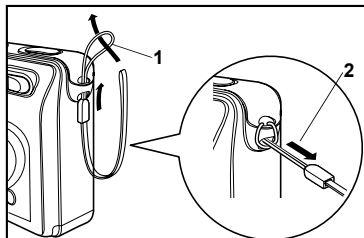



LED Indicators

Indicator	State	Description/Activity
LED indicator	Solid red	The ViviCam 8400 is powering up.
	Solid green	The ViviCam 8400 is ready to record images (or movies).
LED indicator	Solid green	USB communication/transfer in progress
LED indicator	Blinking red	Charging the flash.
Self-timer indicator	Blinking green	The self-timer function is activated.

GETTING STARTED







Turning the Power On/Off

- Press the  button until the ViviCam 8400 turns on.
- To turn the power off, press the  button again.



Choosing the Screen Language

Follow the steps below to choose the desired language.

1. Rotate the mode dial to  and turn your ViviCam 8400 on by pressing the  button.
 - The [Set-up1] menu is displayed.
2. Use  to select [Language], then press the  button.
3. Use  or  to select the language you want.
4. Press the  button to confirm.

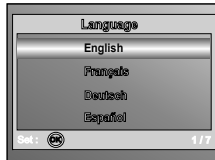

Setting the Date and Time

Follow the steps below to set the date display style, current date and time.

1. Rotate the mode dial to **f** and turn your ViviCam 8400 on by pressing the **⓪** button.
 - The [Set-up1] menu is displayed.
2. Use **▼** to select [Date & Time], then press the **⓪** button.
 - You may press **◀** or **▶** to switch the date types.
3. Press the **◀** / **▶** buttons to select Year, Month, Day and Time fields.
 - To increase a value, press the **▲** button.
 - To decrease a value, press the **▼** button.
 - The time is displayed in 24-hour format.
4. Press the **⓪** button after all fields are set.

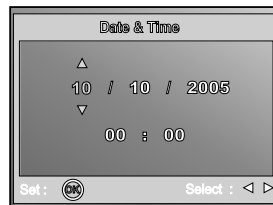
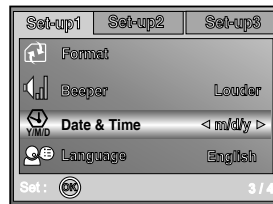

Formatting an SD Memory Card or Internal Memory

The term "Formatting" means preparing an "SD Memory Card" to record images; this process is also called "initialization". This utility formats the internal memory (or memory card) and erases all stored images and data.

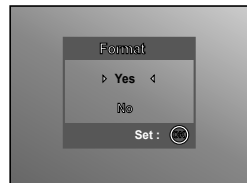
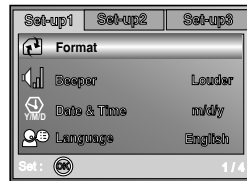

1. Rotate the mode dial to \mathcal{F} and turn your ViviCam 8400 on by pressing the \odot button.
 - The [Set-up1] menu is displayed.
2. Use \blacktriangledown to select [Format], then press the \odot button.
3. Use \blacktriangle or \blacktriangledown to select [Yes], then press the \odot button to confirm.



- When you format an SD memory card, be aware that all data of which will be permanently erased. Protected images are also erased.
- To format the internal memory, do not insert a memory card into the ViviCam 8400. Otherwise, you will format the memory card.
- Formatting is an irreversible action and data cannot be recovered at a later time.
- An SD memory card having any problem cannot be properly formatted.
- If your SD card cannot be formatted, you should use a different card.

Using the LCD Monitor

Your ViviCam 8400 is equipped with a 2.0" full color TFT LCD monitor to help you compose images, replay recorded images/video clips or adjust menu settings. The mode icons, text and numbers displayed on the monitor may vary according to the current settings.

1. Rotate the mode dial to **A** , **P** , **SCENE** , **Tv** , **Av** , **M** or  .
2. Press the  button to turn on the power.
3. Compose your scene on the LCD monitor.
4. Press the shutter button.

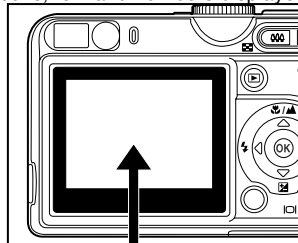

- The LCD monitor darkens in strong sunlight or bright light. This is not a malfunction.
- To prevent your images from being blurred while pressing the shutter button, always hold it carefully. This is especially important when you are shooting under low lighting conditions, when your ViviCam 8400 will select a slower shutter speed to ensure that your images are properly exposed.

PHOTOGRAPHY MODE

Shooting Images - The Basics

1. Rotate the mode dial to **A** , **P** , **SCENE** , **Tv** , **Av** or **M** and turn your ViviCam 8400 on by pressing the **⏻** button.
2. Compose the image on the monitor screen so that the main subject is within the focus frame.
3. Press the shutter button down half way to focus the image.
 - When you press the shutter button down half way, the ViviCam 8400's Auto Focus feature automatically focuses the image and determines the exposure.
4. Press the shutter button the rest of the way down to capture the image.













- The actual image will appear to be larger after being captured than it initially looked on the LCD.
- Pressing the **⏻** / **|** button switches the LCD monitor display mode. Each time you press the **⏻** / **|** button, the display changes in the following order: Focus Frame On → Indicators Off → Composition Line On → LCD Off.

Setting Image Resolution and Quality

As you get to know the ViviCam 8400, you can set the image resolution (number of vertical and horizontal pixels) and image quality (compression ratio) based on the types of images you want to shoot. These settings affect the number of images that can be stored in memory, or on a memory card.

Higher resolution and higher quality images provide finer detail but cause the images' file size to be larger.

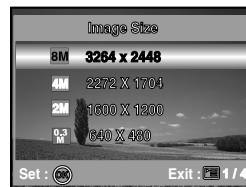

To change image resolution or image quality, perform these steps below:

1. Rotate the mode dial to **A** , **P** , **SCENE** , **Tv** , **Av** or **M** and turn your ViviCam 8400 on by pressing the  button.
2. Press the  button, then use  or  to select the [Mode1] / [Mode2] / [Mode3] menu.
 - In **A** (Auto) Mode, press  to access in menu directly.
3. Use  to select [Image Size], then press the  button.
4. Use  or  to select the desired setting, then press the  button to confirm.
5. Follow the step 3 and 4 above to set the [Quality].







- The possible number of shots and recording time depend on the storage size, resolution and quality settings and the subject of the image to be captured.
- You can resize the images later. (Please refer to section in this manual titled **"Resizing an Image"** for further detail.)

Using the Zoom Function

This ViviCam 8400 is equipped with a 3x optical zoom lens allowing you to capture telephoto or wide-angle shots. By using the optical zoom function, images appear closer by pressing the  button, or smaller by pressing the  button.

You can further enlarge the subjects with 4x digital zoom by continuing to hold the zoom button. This can be a useful feature, however the more the image is magnified with the digital zoom, the grainier the resulting image will be.

To capture a zoomed image, perform the following steps:

1. Press the  button to turn on the power.
2. Adjust the magnification ratio by using the  /  button.
 - To access the optical zoom function, press the  button as far as it can go. Press it again to activate the digital zoom.
 - To exit the zoom photography, press continuously the  button.
 - The status of digital magnification is displayed on the LCD monitor.
3. Compose your scene and press the shutter button.

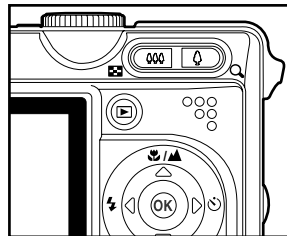

- The digital magnification ranges from 1.0x to 4.0x.
- As you record video clips, the zoom function cannot be activated.



Setting Focus

Images can be captured with the focus determined automatically using auto focus. You may over-ride the auto focus and specify [🌸] macro or [▲] infinity.

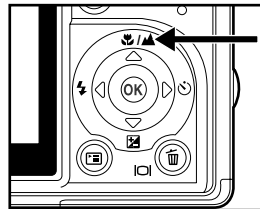
1. Rotate the mode dial to **A** , **P** , **SCENE** , **Tv** , **Av** or **M**.
2. Press ▲ / 🌸 ▲.
3. Use ▲ or ▼ to select the desired focus mode.
4. Compose your scene and press the shutter button.



The table below will help you choose the appropriate focus mode:

Focus mode	Description
 Macro	Select macro to capture close-up images. When the lens is zoomed to its widest position you may focus on objects as close as 5 cm. When the lens is zoomed to its telephoto position (3x zoom) you can focus as close as 30 cm.
 Infinity	The infinity setting is useful for shooting through glass and at other times when you wish to lock on a subject at a long distance.
AF Auto Focus	Select auto focus for most occasions when you want the ViviCam 8400 to automatically determine the focus setting. Using AF, any object at a distance of 50 cm or greater can be in focus.



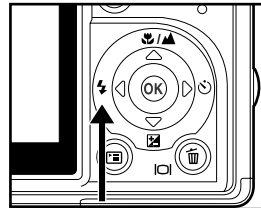

Using the Flash

The flash is designed to function automatically when lighting conditions warrant the use of flash. The ViviCam 8400 has four flash modes: Auto Flash (default), Red Eye Reduction, Forced Flash and No Flash. You can record an image using a flash mode that best suits your requirements.

1. Rotate the mode dial to **A** , **P** , **SCENE** , **Tv** , **Av** or **M**.
2. Press the **OK** button to turn on the power.
3. Toggle **⏪** / **⏩** until your desired flash mode appears on the LCD monitor.
4. Compose your image and press the shutter button.



The table below will help you to choose the appropriate flash mode:

Flash mode	Description
 AUTO FLASH	The flash fires automatically to suit the photographic conditions.
 RED EYE REDUCTION	Use this mode to reduce the red-eye effect when you want to take natural-looking photographs of people and animals in low-light conditions. When taking photographs of people, the red-eye effect can be reduced by increasing the room lighting if possible and having your subject not look directly into the camera. The camera's pre-flash and slight delay in this mode will also help to improve your images.
 FORCED FLASH	The flash will always fire regardless of the surrounding brightness. Select this mode for recording images with high contrast (backlighting) and deep shadows.
 NO FLASH	Use this mode if the use of flash is prohibited or if the distance to the subject is greater than the flash's maximum range. The camera will adjust its exposure and shutter speed to give the best results. A tripod will improve your images.

Using the Self-Timer

The self-timer can be used in situations such as group shots. When using this option, you should either mount the ViviCam 8400 on a tripod (recommended) or rest it on a flat, level surface.

1. Secure the ViviCam 8400 to a tripod or place it on a stable surface.
2. Rotate the mode dial to **A** , **P** , **SCENE** , **Tv** , **Av** or **M**.
3. Press the **⊙** button to turn on the power.
4. Toggle **▶** / **⊙** until your desired self-timer mode appears on the LCD monitor.

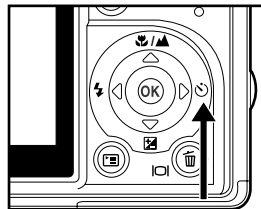
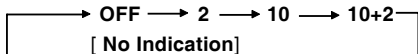

5. Compose your image and press the shutter button.
 - The self-timer function is activated.
 - The image is recorded after the preset interval.
 - To cancel the self-timer at any time, press the **⊙** button, switch the mode dial to another mode or press **▶** to disrupt the sequence.



- After one shot is taken, the self-timer mode is turned off.
- If you wish to take another image using the self-timer, repeat these steps.

Adjusting the Exposure (EV Compensation)

You can manually adjust the exposure determined by the ViviCam 8400. Use this mode when the proper exposure cannot be obtained, for example, when the contrast (difference between light and dark) between the subject and the background is extremely large. The EV compensation can be adjusted over a range of -2.0EV to $+2.0\text{EV}$.

1. Rotate the mode dial to **P**, **SCENE**, **Tv**, **Av** or **M**.
2. Press the \odot button to turn on the power.
3. Press \blacktriangledown / \boxtimes .
4. Use \blacktriangleleft or \blacktriangleright to set the range of EV compensation to a value between -2.0EV and $+2.0\text{EV}$.
5. To exit from the menu, press the \odot button.

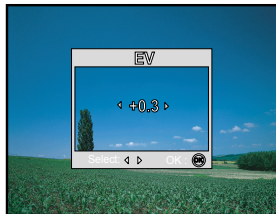

Setting White Balance

This feature lets you make adjustments to compensate for different lighting types according to your shooting conditions.

1. Rotate the mode dial to **P** , **SCENE** , **Tv** , **Av** or **M**.
2. Press the **⏻** button to turn on the power.
3. Press **⏻**, then the [Mode1] menu is displayed.
4. Use **▼** to select [W. Balance], then press the **OK** button.
5. Use **▲** or **▼** to select the desired setting, then press the **OK** button to confirm.
6. To exit from the menu, press the **⏻** button.

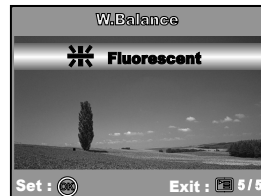
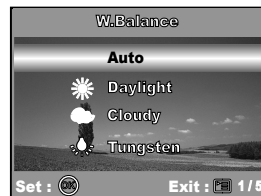
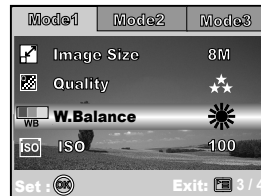

USING THE MODE DIAL

Simple Mode [A]

A (Auto) mode is the simplest way which allows you to take still pictures without having to set special functions or manual adjustments. The ViviCam 8400 sets the optimal focusing and exposure.

1. Rotate the mode dial to **A** and turn your ViviCam 8400 on by pressing the **⏻** button.
2. Compose your image with your main subject in the center of the focus frame.
3. Press the shutter button down halfway to focus the image.
 - When you press the shutter button down half way, the ViviCam 8400's Auto Focus feature automatically focuses the image. Proper exposure is determined and locked at the same time.
 - With the shutter button held, you can reframe your image and the main subject will still be correctly exposed and in focus.
4. Press the shutter button the rest of the way down to capture the image.

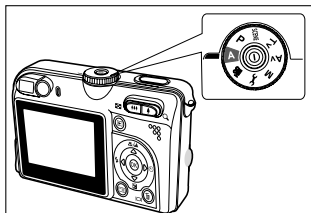

Program Mode [P]

In the **P** (Program) mode, the ViviCam 8400 automatically sets the shutter speed and aperture for taking still images. You can adjust other functions, such as flash mode or continuous shooting mode.

1. Rotate the mode dial to **P** and turn your ViviCam 8400 on by pressing the **⏻** button.
2. Compose your image with your main subject in the center of the focus frame.
3. Press the shutter button to capture the image.

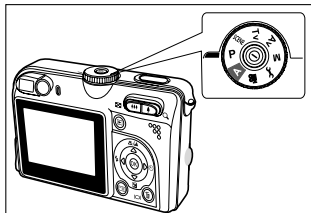

Shutter Speed Priority Mode [Tv]

If you set a fast shutter speed, you can capture images of moving subjects that look as if they are still. If you set a slow shutter speed, you can capture images that give the impression that the subject is in motion.

1. Rotate the mode dial to **Tv** and turn your Vivicam 8400 on by pressing the **Ⓞ** button. A guide appears for a few seconds.
2. Press the **OK** button.
3. Set the shutter speed with **◀** or **▶**, and press the **OK** button.
4. Compose your image on the LCD display.
5. Press the shutter button to capture the image.

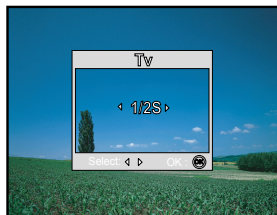

Aperture Priority Mode [Av]

In this mode, images are captured with the priority given to aperture. The shutter speed is automatically set according to the aperture. The aperture will affect the depth-of-field of the picture.

If you set a large aperture (lower F value), you can capture portrait images with an out-of-focus background. Alternatively, if you set a small aperture (higher F value), both close objects and distant objects will be in focus, for example when capturing subjects in the foreground together with landscape images.

1. Rotate the mode dial to **Av** and turn your Vivicam 8400 on by pressing the **Ⓞ** button. A guide appears for a few seconds.
2. Press the **OK** button.
3. Set the aperture value with **◀** or **▶**, and press the **OK** button.
4. Compose your image on the LCD display.
5. Press the shutter button to capture the image.

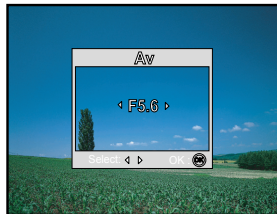

Manual Mode [M]





In manual mode, the aperture value and the shutter speed can be varied individually. This can be useful compensating for tricky lighting conditions, for getting creative results or for capturing night-time scenes.

1. Rotate the mode dial to **M** and turn your ViviCam 8400 on by pressing the **⓪** button. A guide appears for a few seconds.
2. Press the **Ⓞ** button.
3. Use **▲** or **▼** to select aperture/shutter speed item.
4. Adjust the value with **◀** or **▶**, and press the **Ⓞ** button.
5. Compose your image on the LCD display.
6. Press the shutter button to capture the image.



Scene Mode [SCENE]

You can select the Picture mode according to the shooting scene. There are 4 available modes in Picture mode.

- [] Night scene: This mode allows you to take photographs of people against a dusk or night-time background.
- [] Landscape: This mode allows you to take photographs of distant scenery or landscapes.
- [] Portrait: Select this mode to make people stand out with the background out-of-focus.
- [] Sport: This mode allows you to shoot fast moving objects.

1. Rotate the mode dial to **SCENE** and turn your ViviCam 8400 on by pressing the **⓪** button. A guide appears for a few seconds.
2. Press the **Ⓞ** button.
3. Use **◀** or **▶** to select the desired scene mode.
4. Press the **Ⓞ** button to confirm the selection.
5. Compose your image on the LCD display.
6. Press the shutter button to capture the image.

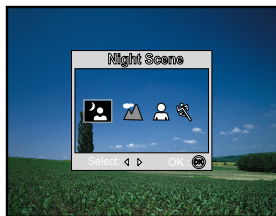











- Press the shutter button halfway to confirm that the exposure is set correctly on the LCD monitor.

ADVANCED SHOOTING

Burst

This mode is used for continuous shooting. Pictures are taken continuously while the shutter release button is pressed.

1. Rotate the mode dial to **A** , **P** , **SCENE** , **Tv** , **Av** or **M** and turn your ViviCam 8400 on by pressing the  button.
 - In **A** (Auto) Mode, press  to access in menu directly.
2. Press , then use  to select the [Mode2] menu.
3. Use  to select [Capture Mode], then press the  button.
4. Use  or  to select [Burst], then press the  button.
5. To exit from the menu, press the  button.
 - The  indicator is displayed on the monitor screen.
6. Press the shutter button halfway to lock the focus.
7. Press the shutter button all the way to shoot.
 - Shooting will stop when the shutter button is released.

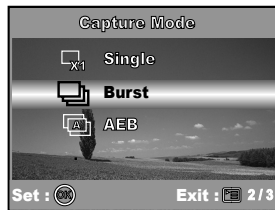
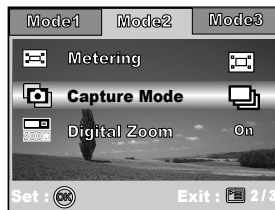

- In Burst mode, the flash mode will be set to **OFF** automatically.

Auto Exposure Bracketing (AEB)

In this mode, the ViviCam 8400 automatically varies the exposure within a set range to take three shots after you press the shutter button once. AEB settings can be combined with exposure compensation settings to extend the adjustment range.



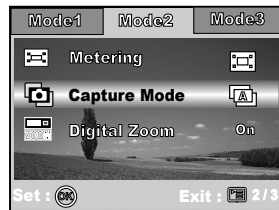







1. Rotate the mode dial to **A**, **P**, **SCENE**, **Tv**, **Av** or **M** and turn your ViviCam 8400 on by pressing the **⏻** button.
 - In **A** (Auto) Mode, press **⏻** to access in menu directly.
2. Press **⏻**, then use **▶** to select the [Mode2] menu.
3. Use **▼** to select [Capture Mode], then press the **OK** button.
4. Use **▲** or **▼** to select [AEB], then press the **OK** button.
5. To exit from the menu, press the **⏻** button.
 - The **A** indicator is displayed on the monitor screen.
6. Press the shutter button to capture the series of 3 images, each with different exposures.



- In AEB mode, the flash mode will be set to **OFF** automatically.

Selecting the Metering Mode

You can select the metering mode that sets which part of the subject to measure to determine the exposure.



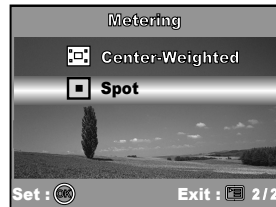
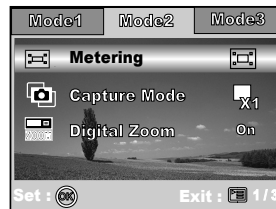



1. Rotate the mode dial to **P** , **SCENE** , **Tv** , **Av** or **M** and turn your ViviCam 8400 on by pressing the  button.
2. Press , then use  to select the [Mode2] menu.
3. Use  to select [Metering], then press the  button.
4. Use  or  to select the desired metering mode, then press the  button.
 - [ Center-Weighted]: Averages the light metered from the entire frame, but gives greater weight to the subject matter at the center.
 - [ Spot]: Meters the area within the spot automatic exposure point frame at the center of the LCD monitor.
5. To exit from the menu, press the  button.
6. Compose your image in the LCD display.
7. Press the shutter button to capture the image.



PLAYBACK MODE - THE BASICS

Viewing Images

You can display the still images you have just captured.











1. Press the  button to turn on the ViviCam 8400.
2. Press the  (Playback) button.
 - The last recorded image appears on the LCD monitor.
3. Use  or  to select the desired images.
 - To view the previous image, press the  button.
 - To view the next image, press the  button.



- The playback information displayed on the LCD monitor will disappear after a few seconds.
- If there is no image stored in the internal memory or on the memory card, a [No Image] message will appear on the monitor.

Magnifying Images

While reviewing your images, you may enlarge a selected portion of an image. This magnification allows you to view fine details. The zoom factor displayed on the screen shows the current magnification ratio.









1. Press the  (Playback) button.
 - The last recorded image appears on the LCD monitor.
 - To view the previous image, press the  button.
 - To view the next image, press the  button.
2. Adjust the zoom ratio by using the Zoom  /  button.
 - To enlarge the selected image, press the  button.
 - To return to the normal image, press the  button.
 - The magnification factor is displayed on the LCD monitor.
3. To view different portion of the images, press the  /  /  /  button to adjust the display area.



-
- The magnification factors range from 1x to 4x (within 7 stages: 1.0x, 1.5x, 2.0x, 2.5x, 3.0x, 3.5x and 4.0x).

Thumbnail Display









This function allows you to view 9 thumbnail images on the LCD monitor simultaneously so you may search for a particular image.

1. Press the  (Playback) button.
 - The last recorded image appears on the LCD monitor.
2. Press the  /  button once.
 - Nine thumbnail images are displayed simultaneously.
 - For recorded video clips, the  video mode icon will be displayed.
3. Use the  /  /  /  button to move the cursor to select the image to be displayed at regular size.
4. Press the  button to display the selected image on full screen.



Slideshow Display

The slide show function enables you to play your images back automatically in sequential order. This is very useful for reviewing recorded images and for presentations.



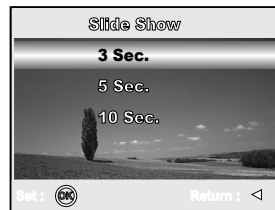











1. Press the  (Playback) button.
 - The last recorded image appears on the LCD monitor.
2. Press . The [Playback1] menu is displayed.
3. Use  to select [Slide Show] and press the  button.
4. Use  or  to set the playback interval, then press the  button.
 - The slide show starts.
 - The video clips display only the first frame image and are not played back.
 - To stop slide show, press the  button.



- You can adjust the slide show display interval within the range of 3 Sec., 5 Sec., 10 Sec.

Resizing an Image

You can change the image size of a captured image to one of the following sizes: 2848 x 2136 pixel, 2272 x 1704 pixel, 1600 x 1200 pixel and 640 x 480 pixel.

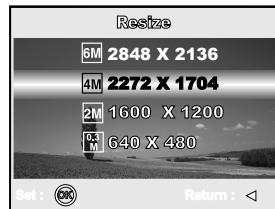

1. Press the  (Playback) button.
 - The last recorded image appears on the LCD monitor.
2. In  (Playback) mode, use  or  to select the desired images.
 - To view the previous image, press the  button.
 - To view the next image, press the  button.
3. Press , then use  to select the [Playback2] menu.
4. Use  or  to select [Resize] and press the  button.
5. Use  or  to select the desired setting, then press the  button to confirm.







VIDEO MODE

Recording Video Clips

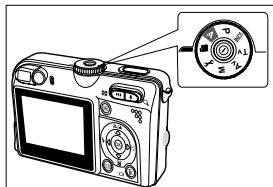
This mode allows you to record video clips with sound using the built-in microphone.







1. Rotate the mode dial to  mode and turn your ViviCam 8400 on by pressing the  button.
2. Press the shutter button to start recording.
3. To stop recording, press the shutter button again.



- The zoom function of optical zoom (3x) can be activated before you start to record video clips.
- Pressing the  /  button switches the LCD monitor display mode. Each time you press the  /  button, the display changes in the following order: Focus Frame On → Indicators Off → Composition Line On → LCD Off.

Playing Back Video Clips

You can play back recorded video clips. A guide to operation appears on the LCD monitor during the video playback.

1. Press the  (Playback) button.
2. Use  or  to go through the images until the video clip you want to play back is displayed.
 - To view the previous image, press the  button.
 - To view the next image, press the  button.
3. Press the  button to start playing back the video clips.
 - To pause or resume video playback, press the  button again.



- The playback information displayed on the LCD monitor will disappear after a few seconds.
- The zoom function cannot be activated while playing the video clips.
- To playback the video clips on the computer, we recommend using Windows Media Player 9.0 (WMP 9.0).
You can download the latest version of Windows Media Player from the Microsoft web site at www.microsoft.com.

PLAYBACK MODE – ADVANCED FEATURES

Playing Back Still Images/Video Clips on TV

You can also playback your images on a TV screen. Before connecting to any device, make sure to select NTSC/PAL system to match the video output system of the video equipment you are going to connect to the ViviCam 8400, then turn all devices off.



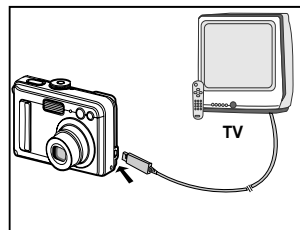









1. Connect one end of the A/V cable to the A/V terminal of the ViviCam 8400.
2. Connect the other end to the A/V input jacks of the TV set.
3. Turn on the TV and ViviCam 8400.
4. Playback the images/video clips.
 - The method of operation is the same as playing back still images and video clips on the ViviCam 8400.



- The sound recorded with video clips can only be played back on TV or computers.

Deleting Images/Video Clips

Use this function to delete one or all images/video clips stored in the internal memory or memory card. Please note that the deleted images or video clips cannot be recovered. Exercise caution before deleting a file.



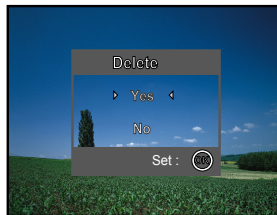















1. Rotate the mode dial to **A**, **P**, **SCENE**, **Tv**, **Av**, **M** or  and turn your ViviCam 8400 on by pressing the  button.
2. Press the  button.
 - The last recorded image appears on the LCD monitor.
3. Use  or  to select the image you want to delete.
4. Press the  button.
5. Use  or  to select [This Image] or [All Images], then press the  button.
6. When the delete message appears, use  or  to select [Yes], then press the  button to confirm the deletion.
 - If you wish to cancel the deletion, select [No].



- Protected images cannot be deleted with the delete function.

Protecting Images/Video Clips

Sets the data to read-only to prevent images from being erased by mistake.

1. Press the  (Playback) button.
 - The last recorded image appears on the LCD monitor.
2. In  (Playback) mode, use  or  to select the desired images.
 - To view the previous image, press the  button.
 - To view the next image, press the  button.
3. Press . The [Playback1] menu is displayed.
4. Use  to select [Protect] and press the  button.
5. Use  or  to choose the desired setting, then press the  button.
 - [Protect One]: Protect one image/movie.
 - [Protect All]: Protect all images/movies (at once).
6. Use  or  to select [Lock], then press the  button to confirm.
 - Press  to return to the  (Playback) mode.
 - The  indicator appears on the selected image.
 - If you wish to cancel the protect function, select [Unlock].



Connecting to a PictBridge Compliant Printer

Even if you do not have a computer, you can connect the camera directly to a printer that supports PictBridge to perform image selection and printing using the camera monitor screen and controls. You may also specify which images you want to print and how many copies of each should be printed.

Connecting the camera to the printer

1. Rotate the mode dial to \mathcal{f} and turn your camera on by pressing the \odot button.
2. Press \blacktriangleright to select the [Set-up2] menu, then use \blacktriangledown to select [USB Mode].
3. Use \blacktriangle or \blacktriangledown to select [PictBridge], then press the OK button.
4. Connect your camera and the printer via a supplied USB cable.
 - The screen turns off automatically and the setting screen will appear on the monitor after a few seconds.











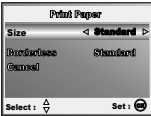



Printing images

When the camera is properly connected to a PictBridge compliant printer, the [Printing Mode Select] screen is displayed on the monitor. Use \blacktriangle or \blacktriangledown to select the print mode.

- In [Print] Mode: Lets you print the specified image with PictBridge.

Step	Figure	Procedure
1		Use \blacktriangle or \blacktriangledown to select the [Print] mode, then press the OK button. * The [Print Paper] screen is displayed.

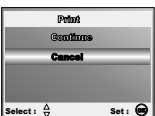
Step	Figure	Procedure
2		<p>Use ▲ or ▼ to access in the selection of paper setting, then press the  button to confirm.</p> <p>[Size]: You may select the desired item depending on the type of printer being used.</p> <p>[Borderless]: You may select the desired item depending on the type of printer being used.</p> <p>[Cancel]: To cancel the setting, use ▲ or ▼ to select [Cancel].</p>
3		<p>Use ◀ or ▶ to select the image you want to print, then press ▼ to go to more detailed settings.</p> <p>* The [Print Info] screen is displayed.</p>
4		<p>Use ▲ or ▼ to select your preference, then press the  button.</p> <p>* After the print settings finished, the printer icon will be displayed as shown in the figure of step 5.</p> <p>[Quantity] : Specifies the number of prints. You can select the number up to 10.</p> <p>[Date]: If you select With, images are printed with the date.</p> <p>[File Name]: If you select With, images are printed with the file name.</p> <p>[Cancel]: To cancel the print settings, use ▲ or ▼ to select [Cancel].</p>
5		<p>After step 4 is completed, you can still use ◀ or ▶ to select other images. Follow the same instructions and print settings as in step 4, then press the  button to print.</p>

Step	Figure	Procedure
6		<p>Use ▲ or ▼ to select [Print], then press the  button to confirm.</p> <p>* The “Transferring” screen is displayed.</p>
7		<p>This starts printing and displays the message “Transferring” on the monitor screen. The message will disappear after the printing is finished.</p>
		<p>* To cancel printing: Pressing the  button during print data transfer displays the screen for selecting whether to [Continue] or [Cancel] printing.</p>

TRANSFERRING FILES FROM YOUR VIVICAM 8400 TO YOUR COMPUTER

After using the USB cable to establish a connection between the ViviCam 8400 and your computer, you can use your computer to share recorded images or video clips with your family or friends via e-mail or post them on the Web. In order to do this, you must install the USB driver onto your computer first. Note that before you begin to install the software, you need to check your system according to the table as shown below.

	System Requirements (Windows)	System Requirements (Macintosh)
CPU	Pentium III 600 MHz processor or higher	PowerPC G3/G4/G5
Operating System	Windows 98/98SE/ME/2000/XP	OS 9.0 or higher
RAM	32MB (64MB RAM recommended)	32MB (64MB RAM recommended)
Hard Disk Space	128MB hard disk space	128MB hard disk space
Required Devices	A CD-ROM drive An available USB port	A CD-ROM drive An available USB port
Display	Color Monitor (800x600, 24-bit or higher recommended)	Color Monitor (800x600, 24-bit or higher recommended)

Step I: Install the USB driver

■ Installation on Windows 98 & 98SE

The USB driver on the supplied CD-ROM is exclusively for Windows 98 and 98SE. Windows 2000/ME/XP users need not install the USB driver.

1. Insert the enclosed CD-ROM into your CD-ROM drive.
2. When the welcome screen appears, click "**Install USB Driver**".
Follow the on-screen instructions to complete the installation.
3. After the USB driver has been installed, restart your computer.



■ Installation on MAC OS 9.0

For Mac OS 9.0 or higher, the computer will automatically recognize the ViviCam 8400 and load its own USB drivers.

Step 2: Connect the ViviCam 8400 to your computer

1. Rotate the mode dial to **f** and turn your ViviCam 8400 on by pressing the **ⓘ** button.
2. Press **▶** to select the [Set-up2] menu, then use **▼** to select [USB Mode].
3. Use **▼** to select [PC], then press the **OK** button.
4. Connect one end of the USB cable to an available USB port on your computer.
5. There will be a new "Removable Disk" icon detected in "My Computer", in which contains your recorded images or video clips.
(For Mac users, double-click [untitled] or [unlabeled] disk drive icon on our desktop.)

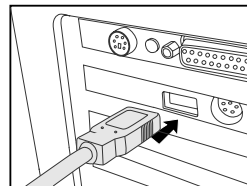
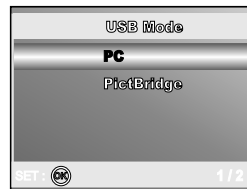
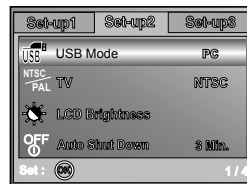

Step 3: Download images or video clips

When the ViviCam 8400 is turned on and connected to your computer, it is considered to be a disk drive, just like a floppy disk or CD. You can download (transfer) images by copying them from the "Removable disk" ("untitled" or "unlabeled" disk on a Macintosh) to your computer hard drive.

■ Windows

Open the "removable disk" and double click on the DCIM / DSCIM folder to open it to find more folders. Your images are inside these folder(s). Select the desired still images or video clips and then choose "Copy" from the "Edit" menu. Open the destination location (folder) and choose "Paste" from the "Edit" menu. You may also drag and drop image files from the ViviCam 8400 to a desired location.

■ Macintosh

Open the "untitled" disk icon, and the destination location on your hard disk. Drag and drop from the ViviCam 8400 to the desired destination.



- Memory card users may prefer to use a memory card reader (highly recommended).
- Video playback application is not included with the package. Make sure that video playback application has been installed in your computer.

EDITING SOFTWARE INSTALLATION

Installing Photo Explorer

Ulead® Photo Explorer provides a simple and efficient way to transfer, browse, modify and distribute digital media. Acquire photos, video or sound clips from various digital device types and easily browse or add personal descriptions; make timely modifications; or distribute the media through the medium of your choice: E-mail, Print, Slideshow Presentations. It is an indispensable all-in-one tool for owners of ViviCam 8400, WebCams, DV camcorders, scanners, or anyone who strives to effectively organize a large collection of digital media.

1. Insert the enclosed CD-ROM into your CD-ROM drive.
2. When the welcome screen appears, click **"Install Ulead® Photo Explorer"**. Follow the on-screen instructions to complete the installation.



- For more information about the operation of Photo Explorer application software, refer to its respective help documentation.
- For Windows 2000/XP users, please make sure to install and use the Photo Explorer in "Administrator" mode.
- Photo Explorer is not supported on the Mac. iPhoto or iPhoto2 is recommended.

Installing Photo Express

Ulead® Photo Express is complete photo project software for digital images. The step-by-step workflow, visual program interface, and in-program help assist users in creating exciting photo projects. Acquire digital photos effortlessly from ViviCam 8400 or scanners. Organize them conveniently with the Visual Browse mode. Use hundreds of ready-to-use templates such as albums, cards, posters, slideshows, and more. Edit and enhance images with photo editing tools, photographic filters, and special effects. Embellish projects by adding creative design elements such as frames, callouts, and stamp objects. Share results with family and friends via e-mail and multiple print options.

1. Insert the enclosed CD-ROM into your CD-ROM drive.
2. When the welcome screen appears, click **“Install Ulead® Photo Express”**. Follow the on-screen instructions to complete the installation.



- For information on how to use Photo Express to edit and retouch your recorded images, please refer to its online help.
- For Windows 2000/XP users, make sure to install and use the Photo Express while logged in as a user with an Administrator account.
- Photo Express is not supported on the Mac.

INSTALLING ADOBE ACROBAT READER

The CD-ROM includes a PDF (portable document format) copy of the user's manual. To view a PDF you must have Adobe Acrobat Reader installed in your computer. Adobe Acrobat Reader is included on the ViviCam 8400 CD ROM. Using Adobe Acrobat Reader, you can read the user's manual and print sections of interest.

1. Insert the CD-ROM that came with the ViviCam 8400 into the CD-ROM drive. The welcome screen appears.
2. Click "**Install Acrobat Reader**".
Follow the on-screen instructions to complete the installation.



USER MANUAL

A copy of the user manual is provided on the CD-ROM in PDF format. It is a backup copy of the printed manual. If you misplace the printed guide, you may print another copy from the CD-ROM. The only requirement for viewing the User Manual on the CD-ROM is that you have Acrobat Reader (Adobe Reader) installed on your computer. Updates to this manual, and versions in other languages may be found on the Vivitar website (www.vivitar.com).

1. Insert the CD-ROM that came with the ViviCam 8400 into the CD-ROM drive. The welcome screen appears.
2. Click **"Install User's Manual"**. Follow the on-screen instructions to complete the installation.
Alternatively, browse the CD-ROM to find the PDF file.











MENU OPTIONS









Camera Menu





This menu is for the basic settings to be used when capturing still images.









1. Rotate the mode dial to **A**, **P**, **SCENE**, **Tv**, **Av** or **M** and turn your ViviCam 8400 on.
2. Press , then use  or  to select the [Mode1] / [Mode2] / [Mode3] menu.
 - In **A** (Auto) Mode, press  to access in menu directly.
3. Press  or  to select the desired setting, then press the  button.
4. To exit from the menu, press the  button.





■ In **A** (Auto) Mode













Item	Functional Description
Image Size 	Sets the size of the image that will be captured. <ul style="list-style-type: none">*  3264 x 2448*  2272 x 1704*  1600 x 1200*  640x480
Quality 	Sets the quality (compression rate) at which the image is captured. <ul style="list-style-type: none">*  Fine*  Normal*  Economy

Item	Functional Description
Capture Mode 	Sets the recording method at the time of taking pictures. <ul style="list-style-type: none"> *  Single *  Burst *  AEB

■ In **P** , **SCENE** , **Tv** , **Av** or **M** Mode

Mode1	Item	Functional Description
	Image Size 	Refer to "Camera Menu - In A (Auto) Mode" in LIST OF MENU OPTIONS.
	Quality 	Refer to "Camera Menu - In A (Auto) Mode" in LIST OF MENU OPTIONS.
	W. Balance 	Sets the white balance photographing under a variety of lighting conditions and permits photographs to be taken that approach the conditions that are seen by the human eye. <ul style="list-style-type: none"> * Auto *  Daylight *  Cloudy *  Tungsten *  Fluorescent

Mode1	Item	Functional Description
	ISO 	Sets the sensitivity for taking pictures. When the sensitivity is raised (and the ISO figure is increased), photography will become possible even in dark locations, but the more pixilated (grainer) the image will appear. *Auto / 50 / 100 / 200
Mode2	Item	Functional Description
	Metering 	Refer to section in this manual titled "Selecting the Metering Mode" for further details.
	Capture Mode 	Refer to "Camera Menu - In A (Auto) Mode" in LIST OF MENU OPTIONS.
	Digital Zoom 	This sets whether or not to use digital zoom at the time of shooting. * On / Off

Mode3	Item	Functional Description
	Color 	Sets the color of the image that will be captured. *  Full Color *  Black & White *  Sepia
	Sharpness 	Sets the level of image sharpness. *  High *  Medium *  Low
	Saturation 	To capture an image, your ViviCam 8400 offers you three different degrees of color to match with your preference. Your images will show different effects by changing the degrees of color. This is called "Saturation". *  High *  Medium *  Low
	Date Imprint 	The date of recording can be printed directly on the still images. This function must be activated before the image is captured. The date appears on the right bottom of the captured picture. When images are shot with date imprint feature, the date cannot be removed later. * On / Off

Video Menu

This menu is for the basic settings to be used when recording video clips.











1. Rotate the mode dial to mode and turn your ViviCam 8400 on.
2. Press , then use or to select the option item, then press the button.
3. Use or to select the desired setting, and press the button.
4. To exit from the playback menu, press the button.

Item	Functional Description
Color 	REFER TO “Camera Menu-In In P , SCENE , Tv , Av or M Mode (Mode3)” of MENU OPTIONS.
Digital Zoom 	REFER TO “Camera Menu-In In P , SCENE , Tv , Av or M Mode (Mode2)” of MENU OPTIONS.



Playback Menu

In the  (Playback) menu, you can choose the settings to be used for playback.













1. Press the  (Playback) button.
 - The last recorded image appears on the LCD monitor.
2. Press , then use  or  to select [Playback1] or [Playback2] menu.
3. Use  or  to select the desired setting and press the  button.
4. To exit from the playback menu, press the  button.

■ [Playback1] settings

Item	Functional Description
Slide Show 	You can play back recorded images in order choosing the time delay between frames. This function is useful for checking your images or for presentations, etc. Refer to the section in this manual titled "Slideshow Display" for further details. * 3 Sec. / 5 Sec. / 10 Sec.
Protect 	Set the data to read-only to prevent images from being erased by mistake. Refer to the section in this manual titled "Protecting Images/Movie clips" for further details.

■ [Playback2] settings

Item	Functional Description
Resize 	<p>Changes the size of a recorded image. Resizing replaces the original image with the changed image. Only resizing to the smaller size is available.</p> <ul style="list-style-type: none"> *  2848 x 2136 *  2272x1704 *  1600x1200 *  640x480
Quality Change 	<p>Change the quality (compression rate) of a recorded image. Compresses images down to half of their size or more, overwrites an old size image with a newly compressed image. Only quality changing to the lower quality level is available.</p> <ul style="list-style-type: none"> *  Fine *  Normal *  Economy
Copy To Card 	<p>Allows you to copy your files from the ViviCam 8400's internal memory to a memory card. Of course, you can only do this if you have a memory card installed and some files in internal memory.</p> <ul style="list-style-type: none"> * Yes / No





Setup Menu

This feature allows you to choose your ViviCam 8400's default settings.







1. Rotate the mode dial to \mathcal{F} (Setup) mode and turn your ViviCam 8400 on.
2. Press \square , then use \blacktriangleleft or \blacktriangleright to select the [Set-up1] / [Set-up2] / [Set-up3] menu.
3. Use \blacktriangleup or \blacktriangledown to select the desired option item, then press the OK button.
4. To exit from the setup menu, turn the dial to any other mode.



■ [Set-up1] settings

Item	Functional Description
	Erases all images and reformats the SD card loaded in your ViviCam 8400. Protected images are also erased. SD card cannot be formatted if it is write-protected. Refer to the section in this manual titled "Formatting an SD Memory Card or Internal Memory" for further details. * Yes / No
	This sets whether or not to mute the startup sound, and the camera sound each time you press a camera button. * Louder / Soft / Off
	This sets the date and the time. Refer to the section in this manual titled "Setting the Date and Time" for further details.
	Sets the language that is displayed on the LCD monitor. Refer to the section in this manual titled "Choosing the Screen Language" for further details. * English / Français / Deutsch / Español / Italiano / 繁體中文 / 简体中文

■ [Set-up2] settings

Item	Functional Description
USB Mode 	Selects to choose one of the following modes for further settings. * PC / PictBridge
TV 	Sets video output of the ViviCam 8400 for matching the video output system of the equipment that you are going to connect to the ViviCam 8400. * PAL / NTSC
LCD Brightness 	This sets the brightness of the LCD monitor. The adjustment range is from -5 to +5.
Auto Shut Down 	If no operation is performed for a specific period of time, the power to the ViviCam 8400 is automatically turned off. This feature is useful to reduce battery wear. * 2 Min. / 3 Min. / 5 Min. / Off

■ [Set-up3] settings

Item	Functional Description
Reset Number 	Sets whether or not to reset the file number when you take photographs. This creates a new folder. The captured images are recorded to the newly created folder from number 0001. If you want to reset the file number, be sure that no images are recorded in the internal memory or the SD memory card. * Yes / No
Set to Default 	Returns all basic settings to the ViviCam 8400's default settings. The time setting will not be reset. * Yes / No
Version 	This displays the current firmware version of the ViviCam 8400.



VIVICAM 8400 SPECIFICATIONS

Item	Description
Image Sensor	CCD
Effective pixels	8.0 Mega pixels
Image size	Still image: 3264 x 2448, 2272 x 1704, 1600 x 1200, 640 x 480 Video clip: 640 x 480
Image quality	Still image: Fine, Normal, Economy Movie image: Economy
Recording media	32MB internal memory SD memory card (Optional, up to 1GB)
File format	Still image: JPEG; Video: ASF
Lens	F-no.: Wide: 2.8 / Tele: 4.8 Focal length: 7.5mm~22.5mm (Equivalent 36~108mm)
Focus range	Normal: 50 cm (20 in.)-infinity Wide: 6 cm (2.5 in.)-infinity Tele: 30 cm (12 in.)-infinity
LCD monitor	2.0" LTPS color LCD High-resolution 130K pixel display
Self-timer	10 sec delay, 2 sec delay, 10+2 sec delay
Exposure compensation	-2.0EV~ +2.0EV (in 0.3EV increments)
White balance	Auto, Daylight, Cloudy, Tungsten, Fluorescent
ISO	Auto, 50, 100, 200
Interface	DC-IN jack, USB connector, A/V terminal
Power	2xAA Alkaline or optional Ni-MH Batteries (2000 mAh or higher suggested) AC-DC Adapter (3V/2.5A) (Optional)
Dimensions	Approx. 91 x 61 x 27 mm (3.6 x 2.4 x 1.1 in.)
Weight	Approx. 150g (5.3oz) (without batteries and the SD card)

* Design and specifications are subject to change without notice.

APPENDIX

■ Troubleshooting Guide

Symptom	Possible causes	Solutions / Corrective Actions
The camera does not power on.	<ul style="list-style-type: none"> * The batteries are depleted. * The batteries are not oriented correctly. * The battery cover is not closed properly. * The AC power adapter (optional) is disconnected. 	<ul style="list-style-type: none"> * Load new or fully charged batteries. * Ensure that the battery polarity is correct. * Close the battery cover correctly. * Properly connect the AC power adapter.
The ViviCam 8400 suddenly powers down.	<ul style="list-style-type: none"> * The function of Auto Shut Down in  (Setup) mode has been activated. * The batteries are depleted. 	<ul style="list-style-type: none"> * Set the option of Auto Shut Down to Off. * Press the power button again or replace the batteries with a new or freshly charged set.
The image is not captured when the shutter button is pressed.	<ul style="list-style-type: none"> * The ViviCam 8400 is in  (Play) mode. * Memory is full. 	<ul style="list-style-type: none"> * Rotate the mode dial to A, P, SCENE, Tv, Av or M. * Transfer the desired files to your computer and then delete unnecessary files, or use a different memory card.
The flash does not fire.	<ul style="list-style-type: none"> * NO FLASH is selected in flash mode. * The ViviCam 8400 is in Burst/AEB/  (Video) mode. 	<ul style="list-style-type: none"> * Select a different flash mode. * Select [Single] in the capture mode .
Continuous shooting is not possible.	<ul style="list-style-type: none"> * The capacity of the built-in memory or SD memory card is full. 	<ul style="list-style-type: none"> * Insert a new SD memory card.
Cannot transfer files over a USB connection.	<ul style="list-style-type: none"> * The USB cable is not connected securely. * The USB driver is not installed. * The ViviCam 8400 is turned off. 	<ul style="list-style-type: none"> * Check all connections. * Install the USB driver on your computer. * Turn on the ViviCam 8400.

■ Possible Number of Recordable Images

The frame counter indicates the approximate number of images that can be stored on the SD memory card. The number of recordable images may vary depending on the recorded subject, the capacity of the memory card, there are files other than images or when the recording is made while switching the picture quality or resolution.

Resolution	Quality (Compression Ratio)	SD Memory Card						
		32MB Internal Memory	32MB	64MB	128MB	256MB	512MB	1GB
3264 x 2448 8M	☆☆ Fine (1/4)	7	7	14	31	63	128	256
	* Normal (1/8)	14	15	29	63	126	256	512
	★ Economy (1/16)	28	30	59	127	253	512	1024
2272 x 1704 4M	☆☆ Fine (1/4)	14	15	30	65	130	264	528
	* Normal (1/8)	29	31	61	131	261	528	1057
	★ Economy (1/16)	58	63	122	262	522	1057	2114
1600 x 1200 2M	☆☆ Fine (1/4)	29	31	61	132	263	533	1065
	* Normal (1/8)	59	63	123	264	527	1066	2131
	★ Economy (1/16)	118	127	246	528	1054	2132	4263
640 x 480 0.3M	☆☆ Fine (1/4)	185	198	385	826	1647	3331	6661
	* Normal (1/8)	371	397	770	1653	3294	6662	13322
	★ Economy (1/16)	743	794	1540	3306	6589	13325	26644

* The above data shows the standard testing results. The actual capacity varies according to the shooting conditions and settings.

■ Approximate Duration of Recording Time

The table below indicates the approximate duration of recording time depending on the capacity of the SD memory card.

Image size	SD Memory Card						
	32MB Internal Memory	32MB	64MB	128MB	256MB	512MB	1GB
640 x 480	1'09"	1'47"	3'28"	7'27"	14'52"	30'04"	01:00:07

* The values for the recording time may vary depending on the shooting conditions and settings.

Free Manuals Download Website

<http://myh66.com>

<http://usermanuals.us>

<http://www.somanuals.com>

<http://www.4manuals.cc>

<http://www.manual-lib.com>

<http://www.404manual.com>

<http://www.luxmanual.com>

<http://aubethermostatmanual.com>

Golf course search by state

<http://golfingnear.com>

Email search by domain

<http://emailbydomain.com>

Auto manuals search

<http://auto.somanuals.com>

TV manuals search

<http://tv.somanuals.com>