



**2008 WaveRunner  
FX SHO  
FX Cruiser SHO**

**OWNER'S/OPERATOR'S MANUAL**

**READ THIS MANUAL  
CAREFULLY BEFORE OPERATION!**

**U.S.A. Edition**  
YAMAHA MOTOR CORPORATION, USA  
**LIT-18626-07-87**  
**F1W-F8199-10**

**⚠ WARNING**

**The engine exhaust from this product contains chemicals known to the State of California to cause cancer, birth defects or other reproductive harm.**

YAMAHA

LIT-CALIF-65-01

# Important manual information

---

EJU30180

## To the owner/operator

Thank you for choosing a Yamaha watercraft. This owner's/operator's manual contains information you will need for proper operation, maintenance, and care. A thorough understanding of these simple instructions will help you to obtain maximum enjoyment from your new Yamaha. If you have any questions about the operation or maintenance of your watercraft, please consult a Yamaha dealer. Because Yamaha has a policy of continuing product improvement, this product may not be exactly as described in this owner's/operator's manual. Specifications are subject to change without notice.

This manual should be considered a permanent part of this watercraft and should remain with it even if the watercraft is subsequently sold.

In this manual, information of particular importance is distinguished in the following ways:



The Safety Alert Symbol means ATTENTION! BECOME ALERT! YOUR SAFETY IS INVOLVED!

EWJ00070



### **WARNING**

**Failure to follow WARNING instructions could result in severe injury or death to the machine operator, passengers, a bystander, or a person inspecting or repairing the watercraft.**

---

ECJ00090

### **CAUTION:**

**A CAUTION indicates special precautions that must be taken to avoid damage to the watercraft.**

---

## NOTE: \_\_\_\_\_

A NOTE provides key information to make procedures easier or clearer.

---

EJU30220

**WaveRunner FX SHO/FX Cruiser SHO  
OWNER'S/OPERATOR'S MANUAL  
©2007 by Yamaha Motor Corporation,  
USA**

**1st Edition, November 2007**

**All rights reserved.**

**Any reprinting or unauthorized use  
without the written permission of  
Yamaha Motor Corporation, USA  
is expressly prohibited.**

**Printed in USA**

**P/N LIT-18626-07-87**

# Table of contents

---

<b>General and important labels</b> .....	<b>1</b>	Cooling water pilot outlets .....	34
Identification numbers .....	1	Steering system .....	35
Primary Identification (PRI-ID)		Tilt lever .....	36
number .....	1	Shift lever .....	36
Hull Identification Number (HIN) .....	1	Quick Shift Trim System (QSTS)	
Engine serial number .....	1	selector .....	37
Emission control information .....	2	Handgrip .....	39
Approval label of emission control		Reboarding step .....	39
certificate .....	2	Bow eye .....	39
Manufactured date label .....	3	Stern eyes .....	40
Star labels .....	3	Pull-up cleats	
Important labels .....	5	(for FX Cruiser SHO) .....	40
Warning labels .....	6	Yamaha Engine Management	
Other labels .....	8	System (YEMS) .....	40
<b>Safety information</b> .....	<b>10</b>	Yamaha Security System .....	40
Limitations on who may operate		No-wake mode .....	42
the watercraft .....	10	Cruise assist .....	44
Cruising limitations .....	11	Multifunction information center .....	45
Operation requirements .....	13	Storage compartments .....	55
Recommended equipment .....	15	<b>Operation</b> .....	<b>59</b>
Hazard information .....	16	Fuel and oil .....	59
Watercraft characteristics .....	16	Gasoline .....	59
Water-skiing .....	18	Engine oil .....	60
Rules of the Road .....	20	Filling the fuel tank .....	60
To get more boating safety		Pre-operation checks .....	61
information .....	24	Pre-operation check list .....	61
Enjoy your watercraft		Pre-operation check points .....	63
responsibly .....	25	Operation .....	71
<b>Features and functions</b> .....	<b>26</b>	Engine break-in .....	71
Location of main components .....	26	Launching the watercraft .....	72
Operation of controls and other		Starting the engine .....	72
functions .....	30	Stopping the engine .....	74
Seats .....	30	Leaving the watercraft .....	74
Hood .....	31	Operating your watercraft .....	74
Fuel tank filler cap .....	31	Getting to know your watercraft .....	74
Remote control transmitter .....	32	Learning to operate your	
Engine stop switch .....	33	watercraft .....	74
Engine shut-off switch .....	33	Riding with passengers .....	75
Start switch .....	34	Starting the watercraft .....	76
Right handlebar switches .....	34	Boarding and starting in	
Throttle lever .....	34	deep water .....	77
		Capsized watercraft .....	80
		Turning the watercraft .....	81

# Table of contents

---

Stopping the watercraft .....	82	Towing the watercraft .....	109
Beaching the watercraft .....	83	Submerged watercraft .....	109
Docking the watercraft .....	83		
Reverse on waterways .....	83	<b>Consumer information .....</b>	<b>110</b>
Rough water operation .....	83	Limited warranty .....	110
Post-operation care .....	84	<b>YAMAHA EXTENDED SERVICE</b>	
Transporting .....	85	(Y.E.S.) .....	112
<b>Maintenance and care.....</b>	<b>86</b>		
Storage .....	86		
Flushing the cooling system .....	86		
Lubrication .....	87		
Fuel system .....	87		
Battery .....	87		
Cleaning the watercraft .....	88		
<b>Maintenance and adjustments .....</b>	<b>89</b>		
Owner's/operator's manual and tool kit .....	89		
Periodic maintenance chart .....	91		
Checking the fuel system .....	93		
Engine oil and oil filter .....	93		
Air filter element .....	94		
Checking the jet thrust nozzle angle .....	94		
Checking the shift cable .....	94		
Checking and adjusting the throttle cable .....	95		
Cleaning and adjusting the spark plugs .....	96		
Lubrication points .....	98		
Checking the battery .....	99		
Fuel injection system .....	101		
<b>Specifications .....</b>	<b>102</b>		
Specifications .....	102		
<b>Trouble recovery .....</b>	<b>103</b>		
Troubleshooting .....	103		
Troubleshooting chart .....	103		
<b>Emergency procedures .....</b>	<b>106</b>		
Cleaning the jet intake and impeller .....	106		
Jumping the battery .....	107		
Replacing the fuses .....	108		



# General and important labels

EJU30350

## Emission control information

This engine conforms to 2008 U.S. Environmental Protection Agency (EPA) and/or California Air Resources Board (CARB) regulations for marine SI engines.

This engine is certified to operate on regular unleaded gasoline.

EJU30400

## Approval label of emission control certificate

This label is attached to the top of the cylinder head and to the inside of the engine compartment.

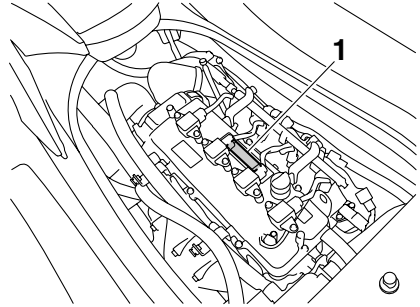

1 Emission control information label location

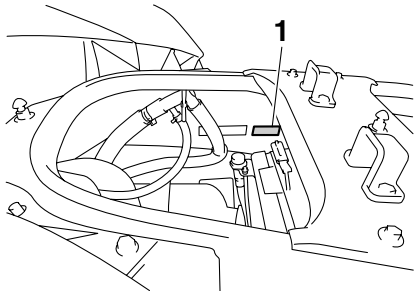

1 Emission control information label location

EMISSION CONTROL INFORMATION		MFI
ENGINE FAMILY: _____		
THIS ENGINE CONFORMS TO _____ CALIFORNIA AND U.S. EPA EMISSION REGULATIONS FOR SI MARINE ENGINES. REFER TO THE OWNER'S MANUAL FOR MAINTENANCE SPECIFICATIONS AND ADJUSTMENTS.		
FUEL: _____	ADVERTISED POWER: _____ hp	FUEL UNLEADED REGULAR GASOLINE
SPARK PLUG: _____	TROTLING SPEED: _____ rpm	VALVE LASH(trim): _____
DISPLACEMENT: _____ cm <sup>3</sup>	SPARK PLUG GAP(trim): _____	
INFORMATION ANTIPOLLUTION		MFI
CATEGORIE DU MOTEUR: _____		
CE MOTEUR EST CONFORME AUX NORMES D'ÉMISSIONS _____ EPA DES É.-U. ET DE LA CALIFORNIE POUR MOTEURS NAUTIQUES SI. POUR CONNAÎTRE LES SPÉCIFICATIONS ET LES RÉGLAGES À EFFECTUER, CONSULTEZ LE MANUEL DU PROPRIÉTAIRE.		
FUEL: _____	PUISANCE AFFICHÉE: _____ hp	CARBURANT: ESSENCE NORMALE SANS PLOMB
BOUGIE: _____	RALENTI: _____ tr/min	JEU DE SOUPAPE(trim) ADM: _____
CYLINDRÉE: _____ cm <sup>3</sup>	BOUGIE-ÉCARTEMENT(trim): _____	ÉCH: _____
YAMAHA MOTOR CO., LTD.		

# General and important labels

EJU30430

## Manufactured date label

This label is attached to the top of the cylinder head.

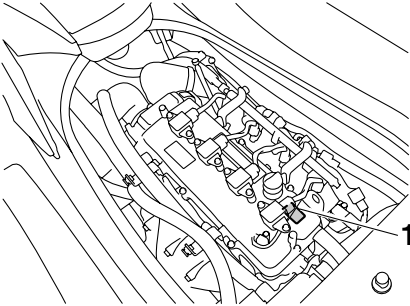

1 Manufactured date label location

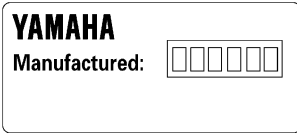

EJU30440

## Star labels

This watercraft is labeled with a California Air Resources Board (CARB) star label. See below for a description of your particular label.

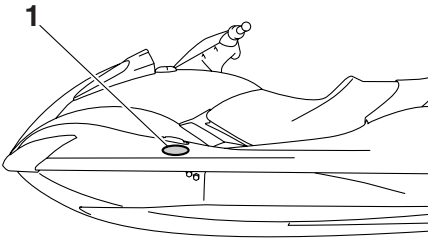

1 Star label location

## One Star - Low Emission

The one-star label identifies engines that meet the Air Resources Board's Personal Watercraft and Outboard marine engine 2001 exhaust emission standards. Engines meeting these standards have 75% lower emissions than conventional carbureted two-stroke engines. These engines are equivalent to the U.S. EPA's 2006 standards for marine engines.



## Two Stars - Very Low Emission

The two-star label identifies engines that meet the Air Resources Board's Personal Watercraft and Outboard marine engine 2004 exhaust emission standards. Engines meeting these standards have 20% lower emissions than One Star-Low Emission engines.



## Three Stars - Ultra Low Emission

The three-star label identifies engines that meet the Air Resources Board's Personal Watercraft and Outboard marine engine 2008



# General and important labels

---

exhaust emission standards or the Sterndrive and Inboard marine engine 2003-2008 exhaust emission standards. Engines meeting these standards have 65% lower emissions than One Star-Low Emission engines.



## **Four Stars - Super Ultra Low Emission**

The four-star label identifies engines that meet the Air Resources Board's Sterndrive and Inboard marine engine 2009 exhaust emission standards. Personal Watercraft and Outboard marine engines may also comply with these standards. Engines meeting these standards have 90% lower emissions than One Star-Low Emission engines.



# General and important labels

EJU30450

## Important labels

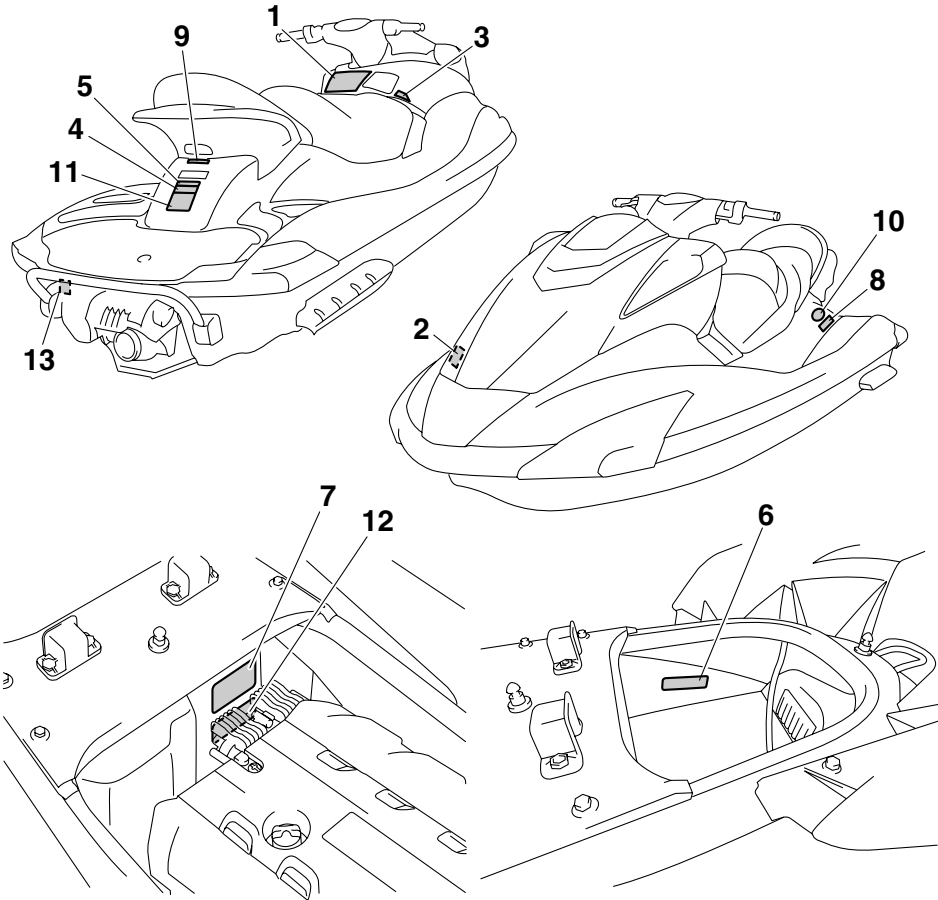

# General and important labels

EJU35910

## Warning labels

1

**⚠ WARNING**

To reduce the risk of **SEVERE INJURY** or **DEATH**:

**WEAR A PERSONAL FLOTATION DEVICE (PFD).**  
All riders must wear a Coast Guard approved PFD that is suitable for personal watercraft (PWC) use.

**WEAR PROTECTIVE CLOTHING.** Severe internal injuries can occur if water is forced into body cavities as a result of falling into water or being near jet thrust nozzle. Normal swimwear does not adequately protect against forceful water entry into rectum or vagina. All riders must wear a wet suit bottom or clothing that provides equivalent protection (See Owner's Manual).

Footwear, gloves, and goggles/glasses are recommended.

**KNOW BOATING LAWS.** Yamaha Motor Co., Ltd. recommends a minimum operator age of 16 years old. Know the operator age and training requirements for your state. A boating safety course is recommended and may be required in your state.

**ATTACH ENGINE SHUT-OFF CORD (LANYARD)** to wrist and keep it free from handlebars so that engine stops if operator falls off. After riding, remove cord from PWC to avoid unauthorized use by children or others.

**RIDE WITHIN YOUR LIMITS AND AVOID AGGRESSIVE MANEUVERS** to reduce the risk of loss of control, ejection, and collision. This is a high performance boat - not a toy. Sharp turns or jumping wakes or waves can increase the risk of back/spinal injury (paralysis), facial injuries, and broken legs, ankles, and other bones.  
Do not jump wakes or waves.

**DO NOT APPLY THROTTLE WHEN ANYONE IS AT REAR OF PWC**-turn engine off or keep engine at idle. Water and/or debris exiting jet thrust nozzle can cause severe injury.

**⚠ WARNING**

**KEEP AWAY FROM INTAKE GRATE** while engine is on. Items such as long hair, loose clothing, or PFD straps can become entangled in moving parts resulting in severe injury or drowning.

**NEVER RIDE AFTER CONSUMING DRUGS OR ALCOHOL**

Collisions result in more **INJURIES AND DEATHS** than any other type of accident for personal watercraft (PWC).  
**TO AVOID COLLISIONS:**  
**SCAN CONSTANTLY** for people, objects, and other watercraft. Be alert for conditions that limit your visibility or block your vision of others.  
**OPERATE DEFENSIVELY** at safe speeds and keep a safe distance away from people, objects, and other watercraft.

- Do not follow directly behind PWCs or other boats.
- Do not go near others to spray or splash them with water.
- Avoid sharp turns or other maneuvers that make it hard for others to avoid you or understand where you are going.
- Avoid areas with submerged objects or shallow water.

**DO NOT RELEASE THROTTLE WHEN TRYING TO STEER** away from objects - you need throttle to steer. Always check throttle and steering controls for proper operation before starting PWC. Follow navigation rules and state/province and local laws that apply to PWCs. See Owner's Manual for more information.

READ AND FOLLOW OWNER'S MANUAL  
**YAMAHA**

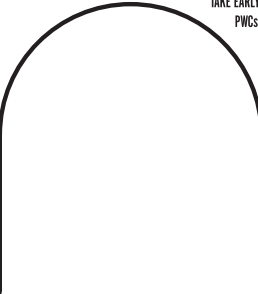

FIW-U41B1-00

2

**⚠ WARNING**

Gasoline is highly flammable and explosive. A fire or explosion could cause severe injury or death. Shut engine off. Refuel in well ventilated area away from flames or sparks. Do not smoke. Avoid spilling gasoline. Wipe up spilled gasoline immediately. Remove all seats to ventilate fuel vapors from engine compartment before starting engine. Do not start engine if there is a fuel leak or a loose electrical connection.

**REGULAR UNLEADED GASOLINE ONLY**

YAMAHA

FI1S-U415B-01

# General and important labels

3

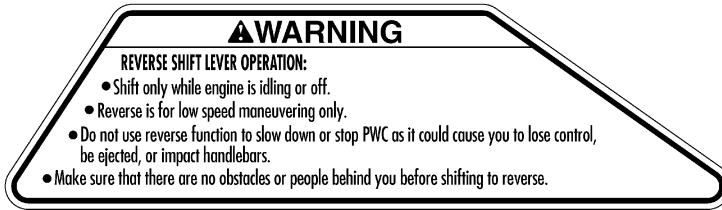

F0V-U41D5-21

4



(F1S-U41E1-01)

5



(F1S-U41E1-01)

6



YAMAHA

F0V-U41DB-02

7

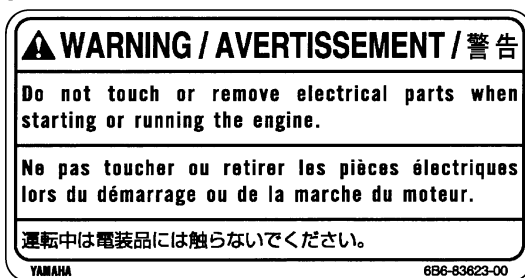

# General and important labels

EJU35923

## Other labels

8



9



10

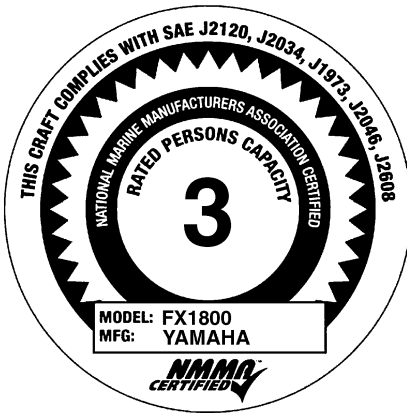

11

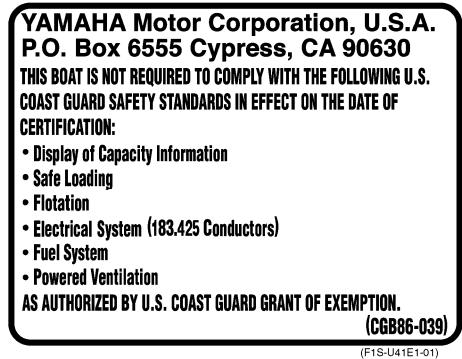

12

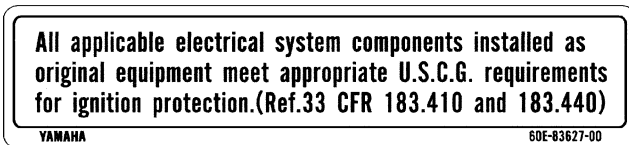

# General and important labels

---

The following label indicates the correct direction to upright a capsized watercraft.

13

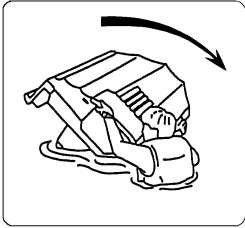

FIG-U418F-00

EJU30670

**The safe use and operation of this watercraft is dependent upon the use of proper riding techniques, as well as upon the common sense, good judgment, and expertise of the operator. Every operator should know the following requirements before riding the watercraft.**

- Before operating the watercraft, read this owner's/operator's manual, the Riding Practice Guide, the Riding Instruction card, and all warning and caution labels on the watercraft. Also, watch the Basic Orientation Video provided with your watercraft. These materials should give you an understanding of the watercraft and its operation.
- Never allow anyone to operate this watercraft until they too have read this owner's/operator's manual, the Riding Practice Guide, the Riding Instruction card, and all warning and caution labels, and, if possible, watched the Basic Orientation Video. Showing them the video may help reinforce the information contained in these materials.

EJU30730

## **Limitations on who may operate the watercraft**

- Yamaha recommends a minimum operator age of 16 years old. Adults must supervise use by minors. Know the operator age and training requirements for your state. A boating safety course is recommended and may be required in your state. You can find local rules by contacting the United States Coast Guard (USCG), the National Association of State Boating Law Administrators, or your local Power Squadron.
- This watercraft is designed to carry the operator and up to 2 passengers. Never exceed the maximum load limit or allow more than 3 persons (or 2 persons if a water-skier is being pulled) to ride the watercraft at any time.



Maximum load: 240 kg (530 lb) Load is the total weight of cargo, operator, and passengers.
--

- Do not operate the watercraft with any passengers on board until you have considerable practice and experience riding alone. Operating the watercraft with passengers requires more skill. Take the time to become accustomed to the handling charac-

# Safety information

---

teristics of the watercraft before trying any difficult maneuvers.

EJU30760

## Cruising limitations

- Scan constantly for people, objects, and other watercraft. Be alert for conditions that limit your visibility or block your vision of others.

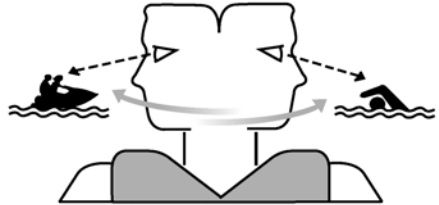

- Operate defensively at safe speeds and keep a safe distance away from people, objects, and other watercraft.
- Do not follow directly behind watercraft or other boats.
- Do not go near others to spray or splash them with water.
- Avoid sharp turns or other maneuvers that make it hard for others to avoid you or understand where you are going.
- Avoid areas with submerged objects or shallow water.
- Take early action to avoid collisions. Remember, watercraft and other boats do not have brakes.
- Do not release the throttle lever when trying to steer away from objects—you need throttle to steer. Always check throttle and steering controls before starting the watercraft.
- Ride within your limits and avoid aggressive maneuvers to reduce the risk of loss of control, ejection, and collision.
- This is a high performance boat—not a toy. Sharp turns or jumping wakes or waves can increase the risk of back/spinal injury (paralysis), facial injuries, and broken legs, an-



## Safety information

kles, and other bones. Do not jump wakes or waves.

- Do not operate the watercraft in rough water, bad weather, or when visibility is poor; this may lead to an accident causing injury or death. Be alert to the possibility of adverse weather. Take note of weather forecasts and the prevailing weather conditions before setting out on your watercraft.
- As with any water sport, you should not operate your watercraft without someone else nearby. If you operate further than swimming distance from shore, you should be accompanied by another boat or watercraft, but make sure you stay a safe distance away. It's good, common sense!
- Never operate in water that is less than 60 cm (2 ft) deep, otherwise you increase your chance of hitting a submerged object, which could result in injury.

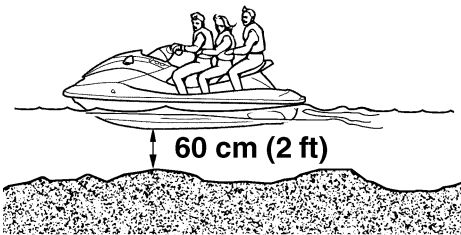

- This watercraft is not equipped with lighting required for night operation. Do not operate the watercraft after sunset or before dawn, otherwise you increase the risk of colliding

with another boat, which could result in severe injury or death.



- Follow navigation rules, and state/provincial and local laws that apply to watercraft.

# Safety information

EJU30811

## Operation requirements

- All riders must wear a U.S. Coast Guard (USCG) approved personal flotation device (PFD) that is suitable for personal watercraft use.
- Wear protective clothing. Severe internal injuries can occur if water is forced into body cavities as a result of falling into the water or being near the jet thrust nozzle. Normal swimwear does not adequately protect against forceful water entry into the rectum or vagina. All riders must wear a wetsuit bottom or clothing that provides equivalent protection. Such clothing includes thick, tightly woven, sturdy and snug-fitting apparel such as denim, but does not include spandex or similar fabrics, like those used in bicycle shorts.

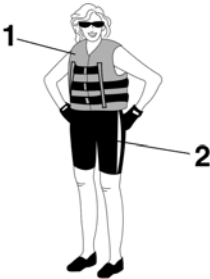

- 1 USCG approved PFD
- 2 Wetsuit bottom

- Eye protection is recommended to keep wind, water, and glare from the sun out of your eyes while you operate your watercraft. Restraining straps for eyewear are made which are designed to float should your eyewear fall in the water. Footwear and gloves are recommended.
- Helmets meeting Snell or DOT standards are required for IJSBA-sanctioned races. You must decide whether to wear a helmet while you ride for recreation. You should

know that a helmet could help protect you in certain kinds of accidents and that it could injure you in others.

A helmet is designed to provide some head protection. Although helmets cannot protect against all foreseeable impacts, a helmet might reduce your injuries in a collision with a boat or other obstacle.

A helmet may have potential safety hazards, as well. Falling into the water could risk the chance of the helmet catching water, commonly known as “bucketing”, and the resulting strain on your neck could cause choking, severe and permanent neck injuries, or death. A helmet could also increase the risk of an accident if it reduces your vision or hearing, or if it distracts you or increases your fatigue.

How should you decide if a helmet’s potential safety benefits outweigh its potential risks for you? Consider your particular riding conditions. Consider factors such as your riding environment and your riding style and ability. Also consider the likelihood of traffic congestion, and the water surface conditions.

If you decide to wear a helmet based upon your riding circumstances, choose one carefully. Look for a helmet designed for personal watercraft use, if possible. Consider a helmet meeting Snell or DOT standards. If you will be engaging in closed-course competition, follow the helmet requirements of the sanctioning organization.

## Safety information

- NEVER operate the watercraft after consuming alcohol or taking other drugs.



- For reasons of safety and proper care of the watercraft, always perform the pre-operation checks listed on page 61 before operating the watercraft.
- The operator and passengers should always keep their feet on the floor of the footwell when the watercraft is in motion. Lifting your feet increases the chances of losing your balance, or hitting objects outside the watercraft with your feet. Do not give a ride to children if their feet cannot reach the floor of the footwell.
- The passengers should hold on firmly, either to the person in front of them or to the handgrip provided.



- Never allow a passenger to ride in front of the operator.

- Always consult your doctor on whether it is safe for you to ride this watercraft if you are pregnant or in poor health.
- Do not attempt to modify this watercraft! Modifications to your watercraft may reduce safety and reliability, and render the watercraft unsafe or illegal for use.
- Attach the engine shut-off cord to your left wrist and keep it free from the handlebars so that the engine stops if you, the operator, fall off. After riding, remove the engine shut-off cord from the watercraft to avoid accidental starting or unauthorized use by children or others.

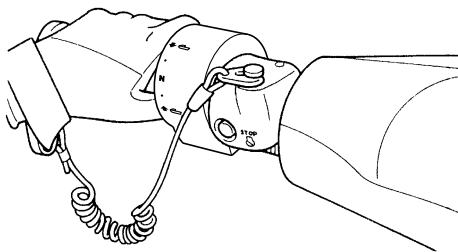

- Scan carefully for swimmers and stay away from swimming areas. Swimmers are hard to see and you could accidentally hit someone in the water.
- Avoid being hit by another boat! You should always take the responsibility to watch for traffic; other boaters may not be watching for you. If they do not see you, or if you maneuver more quickly than other boaters expect, you risk a collision.
- Maintain a safe distance from other boats and watercraft, and also watch for ski ropes or fishing lines. Obey the “Rules of the Road” and be sure to check behind you before making a turn. (See “Rules of the Road” on page 20.)

## Safety information

---

- According to the USCG, boats under 6.1 m (20 ft) in length like your watercraft **MUST** carry a fire extinguisher of a B-1 classification, with a capacity of two pounds or more when navigating in waters under USCG jurisdiction. In addition, most state and local boating laws also require that the fire extinguisher be approved by the USCG.

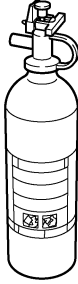

EJU30830

### Recommended equipment

The following items should be carried on board your watercraft:

- Sound-signaling device  
You should carry a whistle or other sound-signaling device that can be used to signal other boats. See “Rules of the Road” for more information.
- Visual distress signals  
It is recommended that a U.S. Coast Guard approved pyrotechnic device be stored in a waterproof container on your watercraft. A mirror can also be used as an emergency signal. Contact a Yamaha dealer or the U.S. Coast Guard for more information.
- Watch  
A watch is helpful so you will know how long you have been operating the watercraft.
- Towline  
A towline can be used to tow a disabled watercraft in an emergency.

EJU36850

## Hazard information

- Never start the engine or let it run for any length of time in an enclosed area. Exhaust fumes contain carbon monoxide, a colorless, odorless gas that may cause loss of consciousness and death within a short time. Always operate the watercraft in an open area.
- Do not touch the hot muffler or engine during or immediately after engine operation; they can cause serious burns.

EJU30920

## Watercraft characteristics

- Jet thrust turns the watercraft. Releasing the throttle lever completely produces only minimum thrust. If you are traveling at speeds above trolling, you will have rapidly decreasing ability to steer without throttle. This model is equipped with the Yamaha Engine Management System (YEMS) that includes an off-throttle steering (OTS) system. It will activate at planing speeds should you attempt to steer the watercraft after releasing the throttle lever. The OTS system assists in turning by continuing to supply some thrust while the watercraft is decelerating, but you can turn more sharply if you apply throttle while turning the handlebars. The OTS system does not function below planing speeds or when the engine is off. Once the engine slows down, the watercraft will no longer turn in response to handlebar input until you apply throttle again or you reach trolling speed. Practice turning in an open area without obstacles until you have a good feel for this maneuver.
- This watercraft is water-jet propelled. The jet pump is directly connected to the engine. This means that jet thrust will produce some movement whenever the engine is running. There is no “neutral” position. You are in either “forward” or “reverse”, depending upon the shift lever position.
- Do not use the reverse function to slow down or stop the watercraft as it could cause you to lose control, be ejected, or impact the handlebars. This could increase the risk of back/spinal injury (paralysis), facial injuries, and broken legs, ankles, and other bones. You could also damage the shift mechanism.

## Safety information

- Reverse can be used to slow down or stop during slow-speed maneuvering, such as when docking. Once the engine is idling, shift into reverse and gradually increase engine speed. Make sure that there are no obstacles or people behind you before shifting into reverse.
- Keep away from the intake grate while the engine is on. Items such as long hair, loose clothing, or PFD straps can become entangled in moving parts, resulting in severe injury or drowning.
- Never insert any object into the jet thrust nozzle while the engine is running. Severe injury or death could result from coming in contact with the rotating parts of the jet pump.

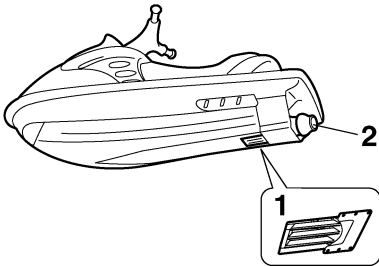

- 1 Intake grate
- 2 Jet thrust nozzle

- Stop the engine and remove the clip from the engine shut-off switch before removing

any debris or weeds, which may have collected around the jet intake.

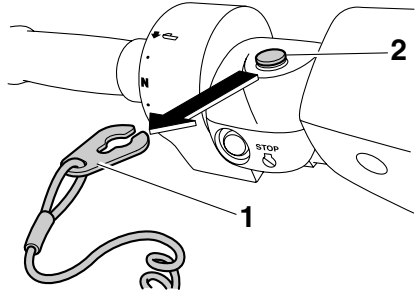

- 1 Clip
- 2 Engine shut-off switch

EJU30940

## Water-skiing

You can use the watercraft for water-skiing if it has the seating capacity to carry the operator, a rearward-facing spotter, and the water-skier when he or she is not skiing.

The watercraft must also have a cleat designed to pull a ski rope; do not attach the rope to any other location.

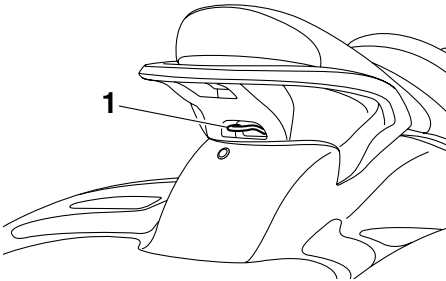

1 Cleat

It is the watercraft operator's responsibility to be alert to the safety of the water-skier and others. Know and follow all state and local water-skiing regulations in effect for the waters in which you will be operating.

The operator should be comfortable carrying passengers before attempting to pull a skier.

The following are some important considerations for minimizing risks while water-skiing.

- The skier should wear an approved PFD, preferably a brightly colored one so boat operators can see the skier.
- The skier should wear protective clothing. Severe internal injuries can occur if water is forced into body cavities as a result of falling into the water. Normal swimwear does not adequately protect against forceful water entry into the rectum or vagina. The skier should wear a wetsuit bottom or clothing that provides equivalent protection.
- A second person should be on board as a spotter to watch the skier; in most states it

is required by law. Let the skier direct the operator's control of speed and direction with hand signals.

The spotter should sit astride the rear of the seat and hold onto the handgrip with both feet firmly on the floor of the footwell for proper balance while facing to the rear to

## Safety information

watch the skier's hand signals and condition.

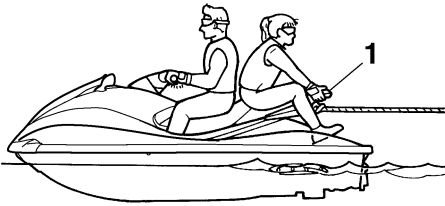

1 Handgrip

### FX SHO

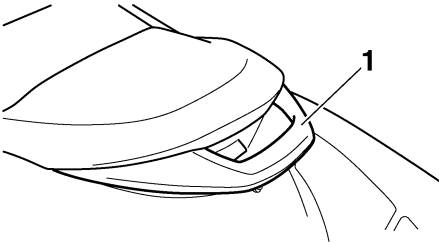

1 Handgrip

### FX Cruiser SHO

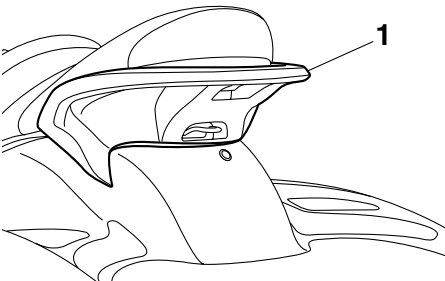

1 Handgrip

- Your control while pulling a water-skier is affected by the skier's ability, as well as water and weather conditions.
- When preparing to pull a skier, operate the watercraft at the slowest possible speed

until the watercraft is well away from the skier and slack in the ski rope is taken up. Make sure that the rope is not looped around anything.

After checking that the skier is ready and that there is no traffic or other obstacles, apply enough throttle to raise the skier.

- Make smooth, wide turns. The watercraft is capable of very sharp turns, which could exceed the abilities of the skier. Keep the skier at least 50 m (150 ft), about twice the distance of a standard ski rope, from any potential hazard.
- Be alert to the hazard of the ski rope handle snapping back at the watercraft when the skier falls or is unable to get up on the skis.
- Towing heavy or bulky objects other than skiers, such as another boat or watercraft, can cause loss of steering control and create a hazardous condition. If you must tow another boat in an emergency situation, operate slowly and cautiously.



EJU30960

## Rules of the Road

**Your Yamaha watercraft is legally considered a powerboat. Operation of the watercraft must be in accordance with the rules and regulations governing the waterway on which it is used.**

Just as there are rules that apply when you are driving on streets and highways, there are waterway rules that apply when you are operating your watercraft. These rules are used internationally, and are also enforced by the United States Coast Guard and local agencies. You should be aware of these rules, and follow them whenever you encounter another vessel on the water.

Several sets of rules prevail according to geographic location, but are all basically the same as the International Rules of the Road. The rules presented here in this owner's/operator's manual are condensed, and have been provided for your convenience only. Consult your local U.S. Coast Guard Auxiliary or Department of Motor Vehicles for a complete set of rules governing the waters in which you will be operating your watercraft.

### Steering and sailing rules

Whenever two vessels on the water meet one another, one vessel has the right-of-way; it is called the "stand-on" vessel. The vessel that does not have the right-of-way is called the "give-way" or "burdened" vessel. These rules determine which vessel has the right-of-way, and what each vessel should do.

#### Stand-on vessel

The vessel with the right-of-way has the duty to continue its course and speed, except to avoid an immediate collision. When you maintain your direction and speed, the other vessel will be able to determine how best to avoid you.

#### Give-way vessel

The vessel which does not have the right-of-way has the duty to take positive and timely action to stay out of the way of the stand-on vessel. Normally, you should not cross in front of the vessel with the right-of-way. You should slow down or change directions briefly and pass behind the other vessel. You should always move in such a way that the operator of the other vessel can see what you are doing. The General Prudential Rule regarding the right-of-way is that if a collision appears unavoidable, neither boat has the right-of-way. Both boats must avoid the collision.

In other words, follow the standard rules except when a collision will occur unless both vessels try to avoid each other. If that is the case, both vessels become give-way vessels.

#### Rules when encountering vessels

There are three main situations that you may encounter with other vessels which could lead to a collision unless the Steering Rules are followed:

Meeting: you are approaching another vessel head-on

Crossing: you are traveling across another vessel's path

Overtaking: you are passing or being passed by another vessel

In the following illustration, your watercraft is in the center. You should give the right-of-way to any vessels shown in the white area (you are the give-way vessel). Any vessels in the shaded area must yield to you (they are the

# ⚠ Safety information

give-way vessels). Both you and the meeting vessel must alter course to avoid each other.

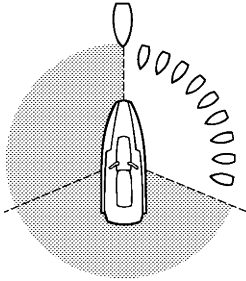

provided the other vessel gives you the right-of-way as it should.

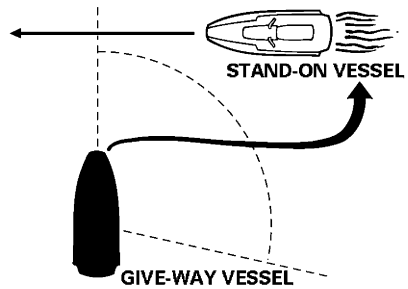

## Meeting

If you are meeting another power-driven vessel head on, and are close enough to run the risk of collision, neither of you has the right-of-way! Both of you should alter course to avoid an accident. You should keep the other vessel on your port (left) side. This rule does not apply if both of you will clear one another if you continue on your set course and speed.

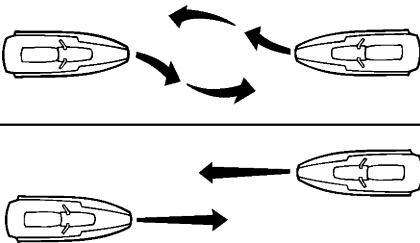

## Overtaking

If you are passing another vessel, you are the give-way vessel. This means that the other vessel is expected to maintain its course and speed. You must stay out of its way until you are clear of it. Likewise, if another vessel is passing you, you should maintain your speed and direction so that the other vessel can steer itself around you.

## Other special situations

There are three other rules you should be aware of when riding your watercraft around other vessels.

## Narrow channels and bends

When navigating in narrow channels, you should keep to the right when it is safe and practical to do so. If the operator of a power-driven vessel is preparing to go around a bend that may obstruct the view of other water vessels, the operator should sound a prolonged blast of four to six seconds on the whistle. If another vessel is around the bend, it too should sound the whistle. Even if no reply is heard, however, the vessel should still proceed around the bend with caution. If you navigate such waters with your watercraft, you will need to carry a portable air horn, available from local marine supply stores.

## Crossing

When two power-driven vessels are crossing each other's path close enough to run the risk of collision, the vessel which has the other on the starboard (right) side must keep out of the way of the other. If the other vessel is on your starboard (right) side, you must keep out of its way; you are the give-way vessel. If the other vessel is on your port (left) side, remember that you should maintain course and direction,

**Fishing vessel right-of-way**

All vessels fishing with nets, lines, or trawls are considered to be “fishing vessels” under the International Rules. Vessels with trolling lines are not considered fishing vessels. Fishing vessels have the right-of-way regardless of position. Fishing vessels cannot, however, impede the passage of other vessels in narrow channels.

**Sailing vessel right-of-way**

Sailing vessels should normally be given the right-of-way. The exceptions to this are:

- (1) When the sailing vessel is overtaking the power-driven vessel, the power-driven vessel has the right-of-way.
- (2) Sailing vessels should keep clear of any fishing vessel.
- (3) In a narrow channel, a sailing vessel should not hamper the safe passage of a power-driven vessel that can navigate only in such a channel.

**Reading buoys and other markers**

The waters of the United States are marked for safe navigation by the lateral system of buoyage. Simply put, buoys and markers have an arrangement of shapes, colors, numbers, and lights to show which side of the buoy a boater should pass on when navigating in a particular direction. The markings on these buoys are oriented from the perspective of being entered from seaward (the boater is going towards the harbor). Red buoys are passed on your starboard (right) side when proceeding from open water into the harbor, and black buoys are to your port (left) side. An easy way to remember the meaning of the colors is the phrase “red right returning”. When navigating out of the harbor, your position with respect to the buoys should be reversed; red buoys should be to port and black buoys to starboard.

Many bodies of water used by boaters are entirely within the boundaries of a particular state. The Uniform State Waterway Marking System has been devised for these waters. This system uses buoys and signs with distinctive shapes and colors to show regulatory or advisory information. These markers are white with black letters and orange borders.

# Safety information

They signify speed zones, restricted areas, danger areas, and general information.

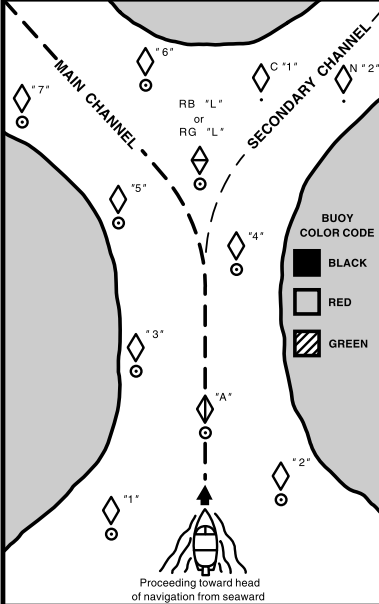
 <p>Proceeding toward head of navigation from seaward</p>	<p><b>MAIN CHANNEL BUOYS</b></p> <p>◇ "1" "3" "5" "7"</p> <p>○ LIGHTED BUOY (Port Hand)</p> <p>Odd number, increasing toward head of navigation, Leave to port (left) proceeding upstream.</p> <p>White Light OR Green Light</p> <p>old new</p>
<p><b>SECONDARY CHANNEL BUOYS</b> STARTS NEW NUMBERING SYSTEM</p>	<p>◇ "2" "4" "6"</p> <p>○ LIGHTED BUOY (Starboard Hand)</p> <p>Even number, increasing toward head of navigation, Leave to starboard (right) proceeding upstream.</p> <p>White Light OR Red Light</p> <p>old new</p>
<p>◇ C "1"</p> <p>CAN BUOY Odd number, Leave to port.</p> <p>old OR new</p>	<p>◇ "A"</p> <p>○ LIGHTED SAFE WATER BUOY</p> <p>No number, Marks midchannel, pass on either side, Letter has no lateral significance, used for identification and location purposes.</p> <p>White Light OR Top Mark White Light</p> <p>old new</p>
<p>◇ N "2"</p> <p>NUN BUOY Even number, Leave to starboard</p> <p>No change</p>	<p>◇ RB "L" ◇ RG "L"</p> <p>○ LIGHTED PREFERRED CHANNEL TO PORT BUOY</p> <p>No number, Topmost band red – preferred channel is to left of buoy, Letter has no lateral significance, used for identification and location purposes.</p> <p>Red or White Light OR Red Light</p> <p>old new</p>

Remember, markings may vary by geographic location. Always consult local boating authorities before riding your watercraft in unfamiliar waters.

EJU30980

## **To get more boating safety information**

Be informed about boating safety. Additional publications and information can be obtained from many organizations, including the following.

### **United States Coast Guard**

Consumer Affairs Staff (G-BC)

Office of Boating, Public, and Consumer Affairs

U.S. Coast Guard Headquarters

Washington, D.C. 20593-0001

Boating Safety Hotline: 1-800-368-5647

### **Other sources**

You can find local rules by contacting the National Association of State Boating Law Administrators, or your local Power Squadron.

### **Watercraft Education and Training**

The Online Boating Safety Course, available through the watercraft section of the yamaha-motor.com website, is a free, 50 question learning course available to the public. Upon successful completion of 80 percent or better, the user can request a certificate of completion by mail or can download one immediately. The Online Boating Safety Course, provided by the Boat/US Foundation, is approved by the National Association of State Boating Law Administrators (NASBLA) and recognized by the United States Coast Guard. This course meets the education requirement for those states that recognize non-proctored, NASBLA-approved courses.

Yamaha is the watercraft industry's leading manufacturer to build awareness and support for boating education. In 1997, Yamaha launched its GET W.E.T. (Watercraft Education and Training) initiative and has since reached out to over one million Americans promoting the benefits of boating education.

The Online Boating Safety Course:  
<http://www.boatus.com/onlinecourse/>

# Safety information

---

EJU30990

## **Enjoy your watercraft responsibly**

You share the areas you enjoy when riding your watercraft with others and with nature. So your enjoyment includes a responsibility to treat these other people, and the lands, waters, and wildlife with respect and courtesy.

Whenever and wherever you ride, think of yourself as the guest of those around you. Remember, for example, that the sound of your watercraft may be music to you, but it could be just noise to others. And the exciting splash of your wake can make waves others won't enjoy.

Avoid riding close to shoreline homes and waterfowl nesting areas or other wildlife areas, and keep a respectful distance from fishermen, other boats, swimmers, and populated beaches. When travel in areas like these is unavoidable, ride slowly and obey all laws.

Proper maintenance is necessary to ensure that the exhaust emission and sound levels of your watercraft will continue to be within regulated limits. You have the responsibility to make sure that the recommended maintenance in this owner's/operator's manual is carried out.

Remember, pollution can be harmful to the environment. Do not refuel or add oil where a spill could cause damage to nature. Remove your watercraft from the water and move it away from the shoreline before refueling. And keep your surroundings pleasant for the people and wildlife that share the waterways: don't litter!

When you ride responsibly, with respect and courtesy for others, you help ensure that our waterways stay open for the enjoyment of a variety of recreational opportunities.

# Features and functions

EJU31010

## Location of main components

### Front view

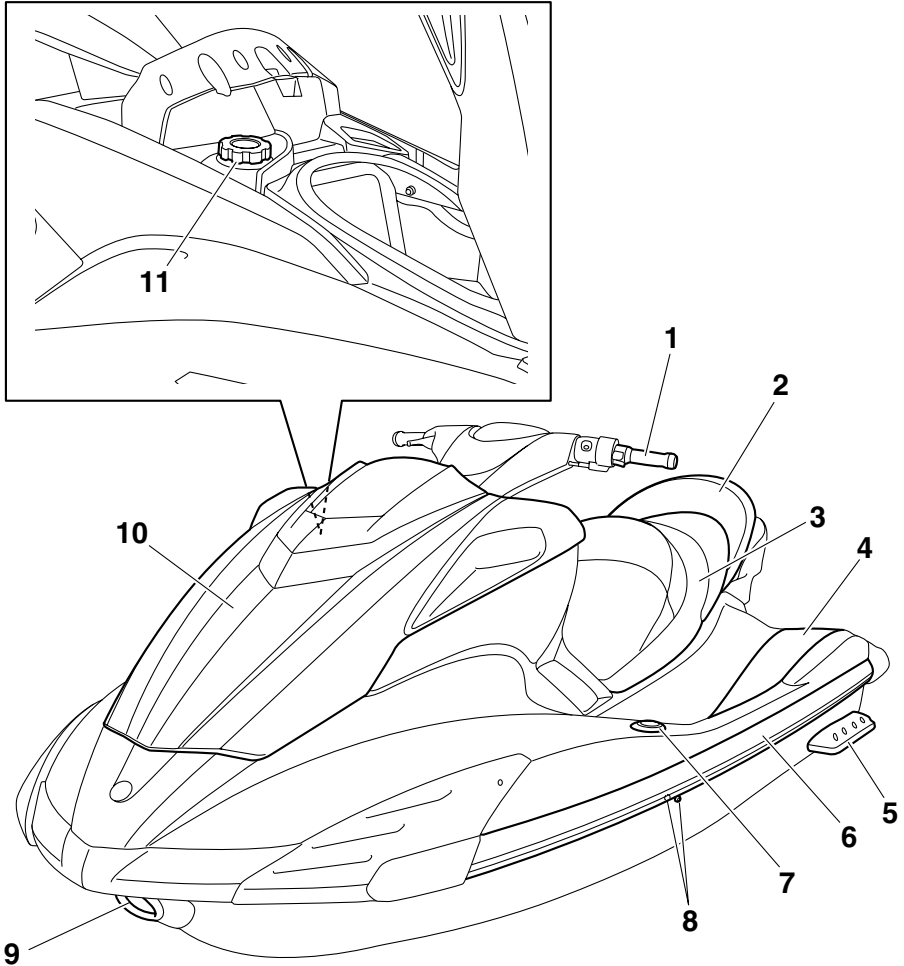

1 Handlebars

2 Rear seat

3 Front seat

4 Footwell

5 Sponsons

6 Gunwale

7 Pull-up cleat (for FX Cruiser SHO)

8 Cooling water pilot outlet

9 Bow eye

10 Hood

11 Fuel tank filler cap

# Features and functions

## Rear view

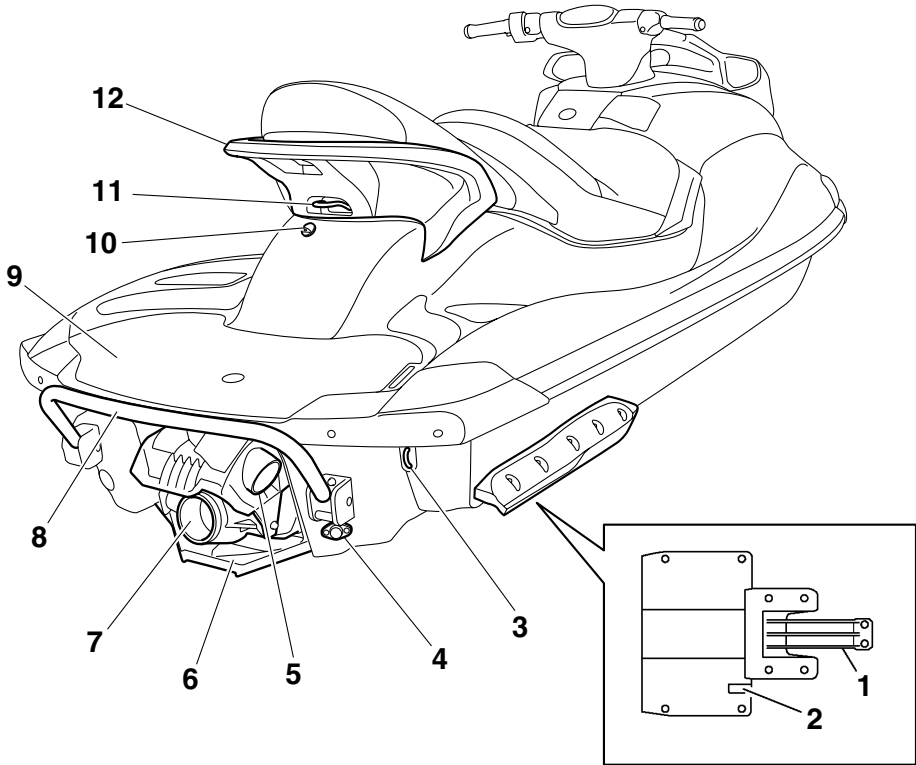

- 1 Intake grate
- 2 Speed sensor
- 3 Stern eyes
- 4 Stern drain plugs
- 5 Reverse gate
- 6 Ride plate
- 7 Jet thrust nozzle
- 8 Reboarding step
- 9 Boarding platform
- 10 Electric bilge pilot outlet
- 11 Cleat
- 12 Handgrip



# Features and functions

## Control system

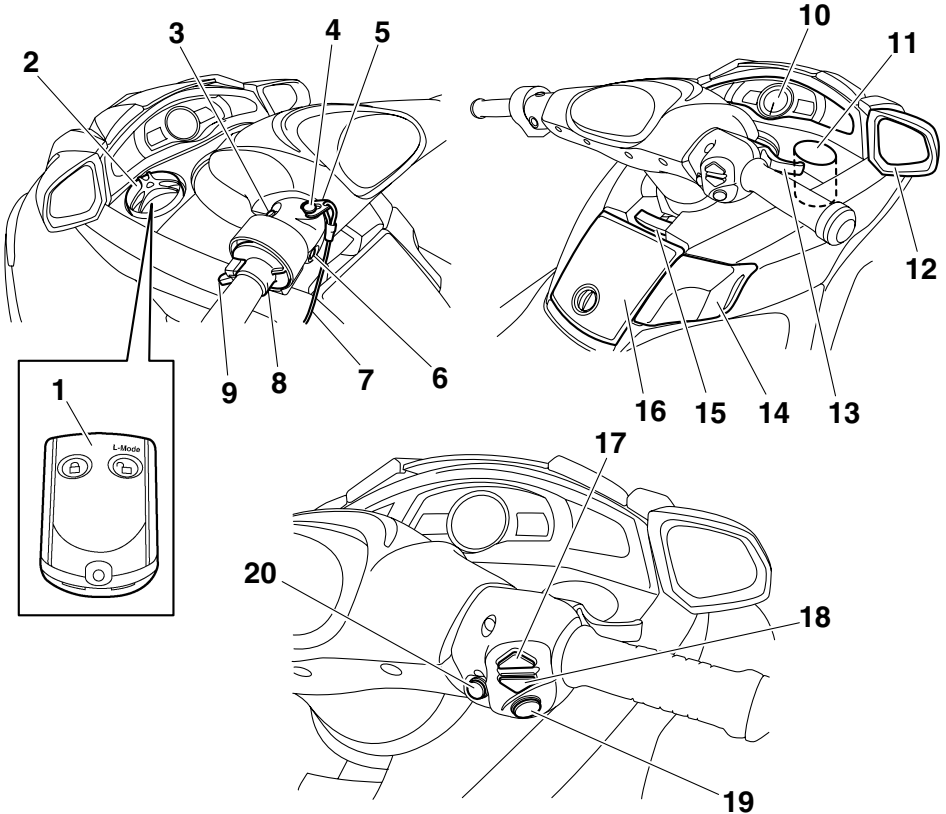

- 1 Remote control transmitter
- 2 Watertight compartment
- 3 Start switch
- 4 Engine shut-off switch
- 5 Clip
- 6 Engine stop switch
- 7 Engine shut-off cord (lanyard)
- 8 Quick Shift Trim System (QSTS) selector
- 9 QSTS selector lock lever
- 10 Multifunction information center
- 11 Beverage holder
- 12 Rearview mirrors
- 13 Throttle lever
- 14 Shift lever
- 15 Tilt lever
- 16 Glove compartment
- 17 Up switch (for cruise assist)
- 18 Down switch (for cruise assist)
- 19 "SET" switch (for cruise assist)
- 20 "NO-WAKE MODE" switch

# Features and functions

## Engine compartment

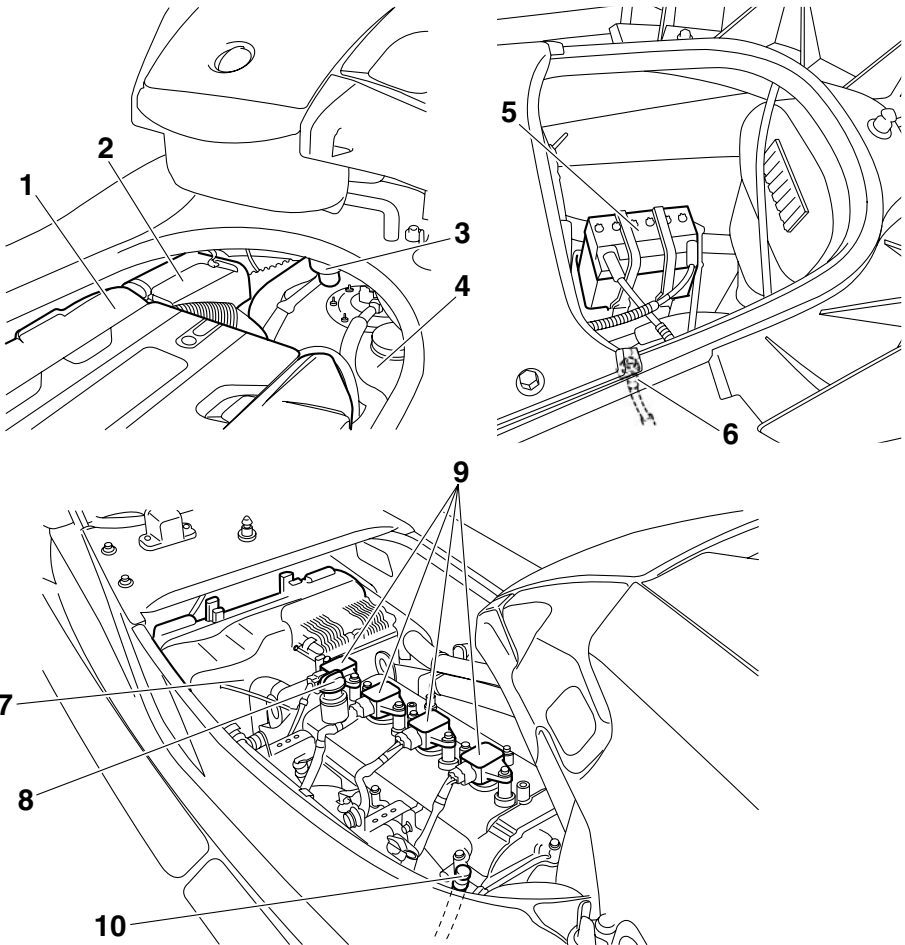

- 1 Engine cover
- 2 Air filter case
- 3 Water separator
- 4 Fuel tank
- 5 Battery
- 6 Flushing hose connector
- 7 Electrical box
- 8 Engine oil filler cap
- 9 Spark plug cap
- 10 Dipstick

# Features and functions

EJU31021

## Operation of controls and other functions

EJU31040

### Seats

To remove the rear seat:

Pull the rear seat latch up, and then pull the seat off.

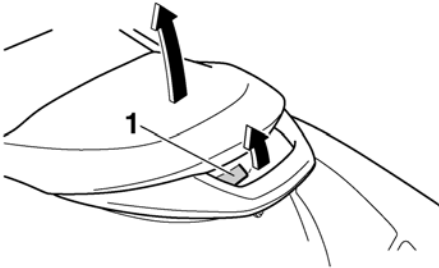

1 Seat latch

To install the rear seat:

Insert the projections on the front of the seat into the stays on the deck, and then push the rear of the seat down to lock it in place.

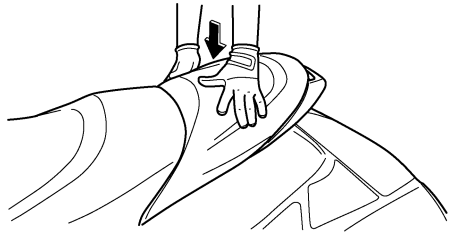
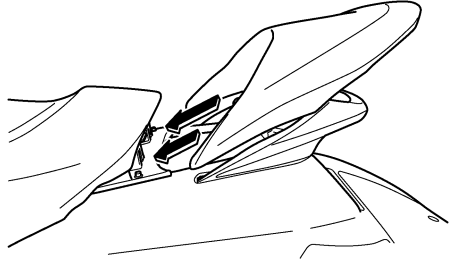

To remove the front seat:

- (1) Remove the rear seat.
- (2) Pull the front seat latch up, and then pull the seat off.

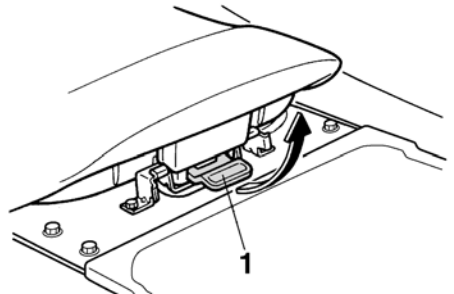

1 Seat latch

# Features and functions

---

## To install the front seat:

- (1) Insert the projections on the front of the seat into the stays on the deck, and then push the rear of the seat down to lock it in place.

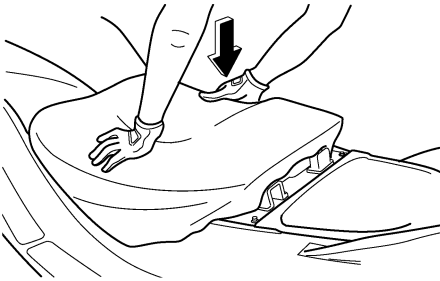
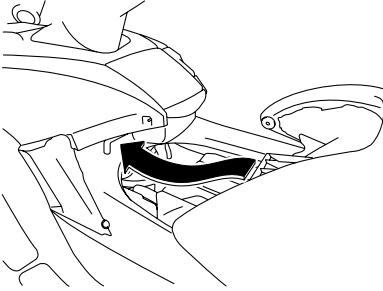

- (2) Install the rear seat.

## **NOTE:**

Make sure that the seats are securely installed before operating the watercraft.

---

EJU36681

## **Hood**

To open the hood, pull the visor up, and then lift up the hood.

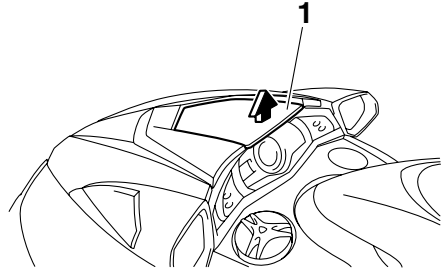

1 Visor

To close the hood, push down on the center of the hood until it latches securely.

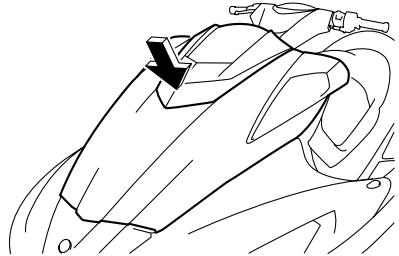

## **NOTE:**

Make sure that the hood is securely closed before operating the watercraft.

---

EJU36690

## **Fuel tank filler cap**

The fuel tank filler cap is located under the hood.

To remove the fuel tank filler cap, open the hood, and then turn the cap counterclockwise.

# Features and functions

(See page 31 for hood opening and closing procedures.)

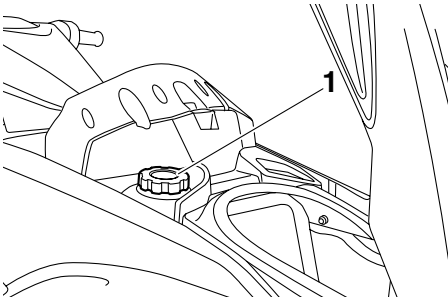

1 Fuel tank filler cap

## NOTE:

Make sure that the fuel tank filler cap and the hood are securely closed before operating the watercraft.

EJU34843

## Remote control transmitter

The Yamaha Security System and low-RPM mode settings are selected using the remote control transmitter. (See “Yamaha Security System” on page 40 for information on using the remote control transmitter.)

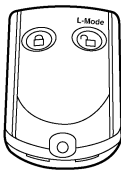

ECJ00750

## CAUTION:

The Yamaha Security System and low-RPM mode settings can only be selected using the remote control transmitter. Observe the following precautions to protect your remote control transmitter:

- Store the remote control transmitter carefully so it will not be lost. When operating the watercraft, use the transmitter holder in the watertight compartment. If you accidentally lose your remote control transmitter, contact a Yamaha dealer.
- While the remote control transmitter has been designed for use in wet environments, it should not be operated underwater or submerged for an extended length of time. If it gets wet, dry it with a soft, dry cloth.
- Keep the remote control transmitter away from high temperatures and do not place it in direct sunlight.
- Do not drop the remote control transmitter, subject it to strong shocks, or place any heavy items on it.
- Use a soft, dry cloth to clean the transmitter. Do not use detergent, alcohol, or other chemicals.
- If the remote control transmitter needs a new battery or is not operating properly, contact a Yamaha dealer. Do not attempt to replace the battery yourself.

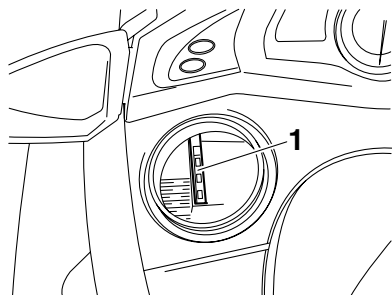

1 Transmitter holder

## NOTE:

- While the engine is running, input from the remote control transmitter is not received.

# Features and functions

- Refer to local hazardous waste regulations when disposing of transmitter batteries.

This device complies with Part 15 of the FCC Rules. Operation is subject to the following two conditions: (1) this device may not cause harmful interference, and (2) this device must accept any interference received, including interference that may cause undesired operation.

ECJ00030

## CAUTION:

**Changes or modifications not expressly approved by the party responsible for compliance could void the user's authority to operate the remote control transmitter.**

EJU31150

### Engine stop switch

Push the engine stop switch (red button) to stop the engine normally.

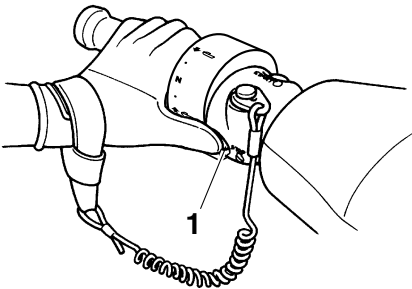

1 Engine stop switch

EJU31160

### Engine shut-off switch

Insert the clip, on the end of the engine shut-off cord, under the engine shut-off switch (black button). The engine will stop automatically when the clip is removed from the

switch, such as if the operator falls off the watercraft.

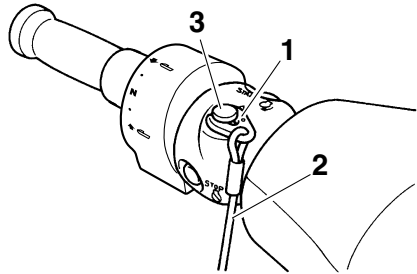

- 1 Clip
- 2 Engine shut-off cord
- 3 Engine shut-off switch

EWJ00010

## WARNING

- Always attach the engine shut-off cord to your left wrist and the clip to the engine shut-off switch **BEFORE** starting the engine.
- To prevent accidental starting of the engine or unauthorized use by children or others, always remove the clip from the engine shut-off switch when the engine is not running.

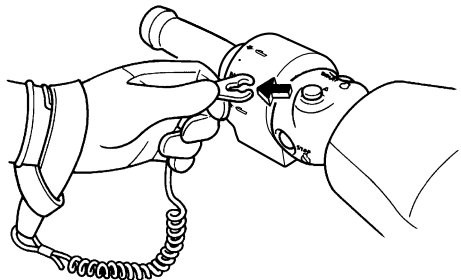

# Features and functions

EJU36280

## Start switch

Push the start switch (green button) to start the engine.

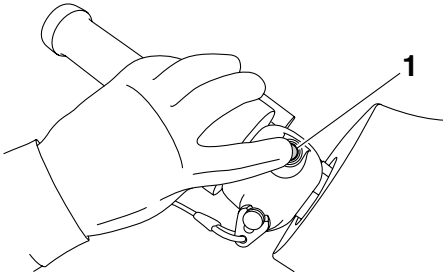

1 Start switch

### NOTE:

The engine will not start when the lock mode of the Yamaha Security System has been selected, the clip is removed from the engine shut-off switch, or the throttle lever is squeezed. (See page 41 for Yamaha Security System lock and unlock mode selection procedures.)

EJU36700

## Right handlebar switches

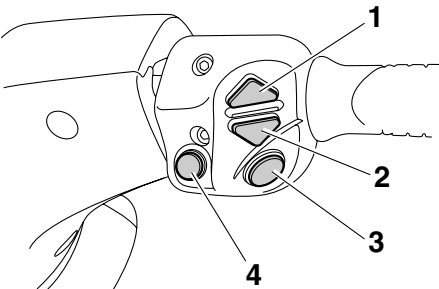

- 1 Up switch
- 2 Down switch
- 3 "SET" switch
- 4 "NO-WAKE MODE" switch

EJU36710

## "SET" switch

Push this switch to activate the cruise assist. (See page 44 for more information.)

EJU36720

## Up and down switches

Push these switches to increase or decrease the engine speed while the cruise assist is operating. (See page 44 for more information.)

EJU36730

## "NO-WAKE MODE" switch

Push this switch to activate or deactivate the no-wake mode. (See page 42 for more information.)

EJU31210

## Throttle lever

Squeeze the throttle lever to increase engine speed.

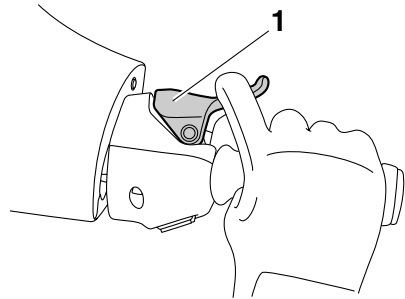

1 Throttle lever

Release the throttle lever to decrease engine speed or to return it to the idle position.

EJU36740

## Cooling water pilot outlets

This watercraft is equipped with cooling water pilot outlets on the port (left) and starboard (right) sides of the watercraft.

# Features and functions

When the engine is running, cooling water is circulated in the engine, and then it is discharged from the pilot outlets.

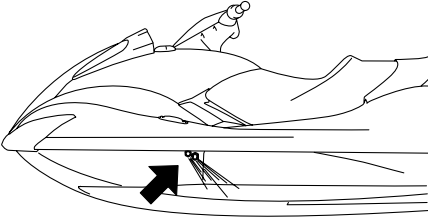

To check for proper operation of the cooling system, check that water is being discharged from the port (left) pilot outlets. If water is not being discharged from these outlets, cooling water may not be circulating in the engine. When this occurs, stop the engine and check for the cause. (See pages 51 and 106 for more information.)

## NOTE:

- If the cooling water passages are dry, it will take about 60 seconds for the water to reach the outlets after the engine is started.
- Water discharge may not be constant at idle, therefore, open the throttle a little to check that water discharges properly.

EJU31260

## Steering system

Your watercraft can be steered by turning the handlebars in the direction you wish to travel.

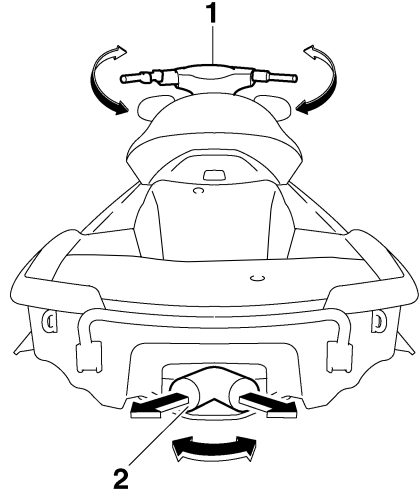

- 1 Handlebar
- 2 Jet thrust nozzle

When the handlebars are turned, the angle of the jet thrust nozzle is changed, and the direction of the watercraft is changed accordingly. Since the strength of the jet thrust determines the speed and degree of a turn, throttle must always be applied when attempting a turn, except at trolling speed.

This model is equipped with the Yamaha Engine Management System (YEMS) that includes an off-throttle steering (OTS) system. It will activate at planing speeds should you attempt to steer the watercraft after releasing the throttle lever. The OTS system assists in turning by continuing to supply some thrust while the watercraft is decelerating, but you can turn more sharply if you apply throttle while turning the handlebars.

The OTS system does not function below planing speeds or when the engine is off.



# Features and functions

Once the engine slows down, the watercraft will no longer turn in response to handlebar input until you apply throttle again or you reach trolling speed.

EJU31290

## Tilt lever

The tilt lever is located in front of the glove compartment and is used to adjust the tilt of the handlebars.

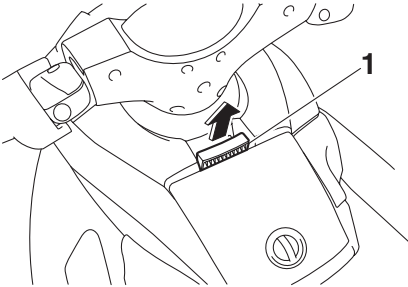

1 Tilt lever

To adjust the tilt, pull the tilt lever up, and then move the handlebars up or down to the desired position.

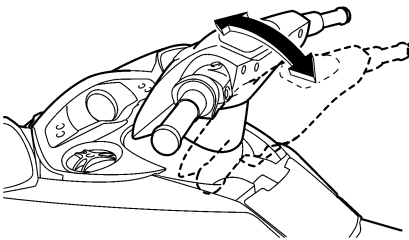

EWJ00040

## WARNING

- Never touch the tilt lever during operation, otherwise the handlebars may suddenly change position, which may lead to an accident.
- Make sure that the tilt lever returns to its original position and that the handlebars are locked in place after adjusting them,

otherwise the handlebars may suddenly change position, which may lead to an accident.

EJU36750

## Shift lever

The shift lever is located on the starboard (right) side of the watercraft and is used to control the reverse gate, which allows the watercraft to move in reverse or forward.

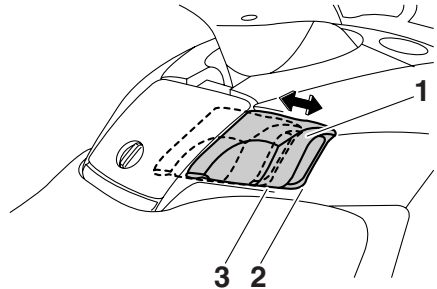

- 1 Shift lever
- 2 Forward position
- 3 Reverse position

When the shift lever is in the reverse position, the watercraft can be launched from a trailer, or backed up out of tight spots where you cannot turn around easily.

### To shift into reverse:

- (1) Release the throttle lever and let the engine speed return to idle.
- (2) Pull the shift lever toward you until it stops.

EWJ00030

## WARNING

- Make sure that the throttle lever is completely released and that the engine is at idle before shifting into reverse.
- Do not use the reverse function to slow down or stop the watercraft as it could cause you to lose control, be ejected, or impact the handlebars.

# Features and functions

- Use reverse for slow-speed maneuvering only.
- Make sure that there are no obstacles or people behind you before shifting into reverse.
- Do not touch the reverse gate while the shift lever is being operated, otherwise you could be pinched.

## NOTE:

This model is equipped with a function which limits the engine speed in reverse.

### To shift into forward:

- (1) Release the throttle lever and let the engine speed return to idle.
- (2) Push the shift lever away from you until it stops.

EJU31311

## Quick Shift Trim System (QSTS) selector

The QSTS selector is located at the left handlebar grip and is used to adjust the trim angle of the watercraft.

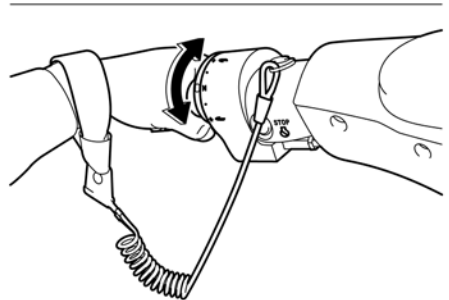
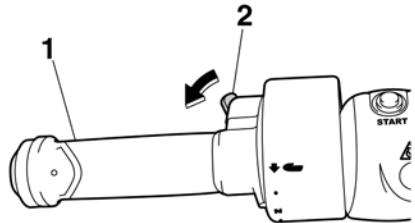

- 1 Quick Shift Trim System (QSTS) selector
- 2 QSTS selector lock lever

Operating the QSTS selector changes the angle of the jet thrust nozzle vertically. This changes the trim angle of the watercraft.

# Features and functions

There are 5 positions: 2 bow-down positions (a) and (b), neutral “N”, and 2 bow-up positions (c) and (d).

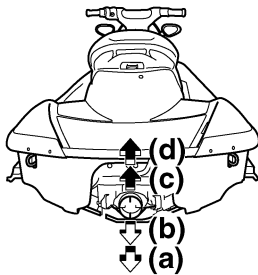
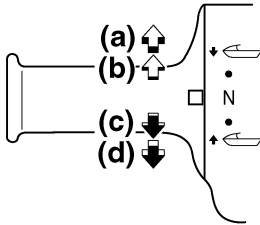

## To change the trim angle:

- (1) Reduce engine speed to less than 3000 r/min.
- (2) Squeeze the QSTS selector lock lever, and then turn the QSTS selector to the desired position.
- (3) Release the lock lever to lock the QSTS selector.

ECJ00011

### **CAUTION:**

**Do not turn the QSTS selector while operating the watercraft at an engine speed of 3000 r/min or more, otherwise damage could occur to the QSTS.**

The neutral “N” position will provide good performance for most operating conditions.

To enhance particular types of performance, select bow down or bow up.

(d) ↑

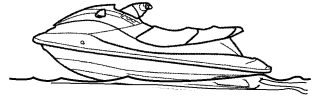

(c) ↑

N

(b) ↓

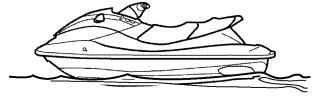

(a) ↓



EJU31330

### **Bow down**

Turn the QSTS selector to (a) or (b) and the bow will go down while the watercraft is on plane.

Bow down puts more of the bow in the water. This gives the watercraft more “hook”, which enhances turning performance. This position will also help the watercraft get up on plane more quickly.

At higher speeds, however, the watercraft will have a greater tendency to “bow steer” and follow waves and wakes in the water. Fuel economy and maximum speed are also reduced.

EJU31340

### **Bow up**

Turn the QSTS selector to (c) or (d) and the bow will go up while the watercraft is on plane. Bow up puts less of the bow in the water. There is less water resistance, so straight-

# Features and functions

ahead acceleration when on plane and top speed are enhanced.

In some conditions, however, the watercraft may tend to “porpoise” (hop in the water). If the watercraft is porpoising, select neutral or bow down.

EJU31360

## Handgrip

The handgrip provides a handhold for boarding the watercraft and for a spotter when facing rearward.

### FX SHO

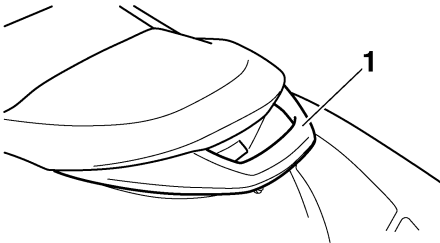

1 Handgrip

### FX Cruiser SHO

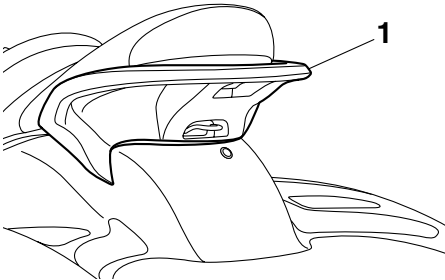

1 Handgrip

EWJ00020

## **WARNING**

**Do not use the handgrip to lift the watercraft. The watercraft could fall, which could result in severe injury.**

EJU34861

## Reboarding step

The reboarding step provides a handhold and footstep for boarding the watercraft.

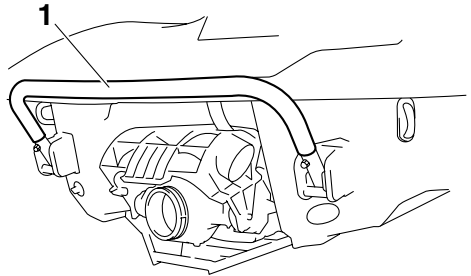

1 Reboarding step

EWJ01210

## **WARNING**

**Do not use the reboarding step to lift the watercraft. The watercraft could fall, which could result in severe injury.**

EGJ00741

## **CAUTION:**

**Use the reboarding step only to board the watercraft in the water. Do not use the reboarding step as a footstep when the watercraft is on land, or for any other purpose. The watercraft can be damaged.**

EJU34870

## Bow eye

The bow eye is located at the bow of the watercraft.

# Features and functions

The bow eye is used to attach a rope to the watercraft when transporting, mooring, or towing it in an emergency.

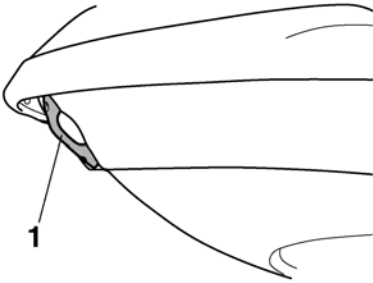

1 Bow eye

EJU34880

## Stern eyes

The stern eyes are located at the stern of the watercraft.

The stern eyes are used to attach a rope to the watercraft when transporting or mooring it.

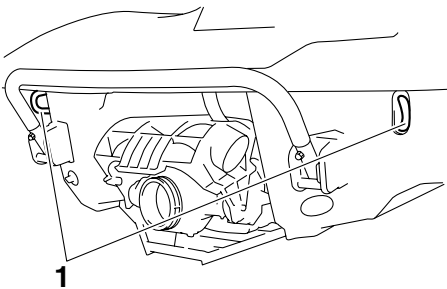

1 Stern eye

EJU34890

## Pull-up cleats (for FX Cruiser SHO)

The pull-up cleats are used to attach a rope to the watercraft when mooring it.

To use a pull-up cleat, pull it up.

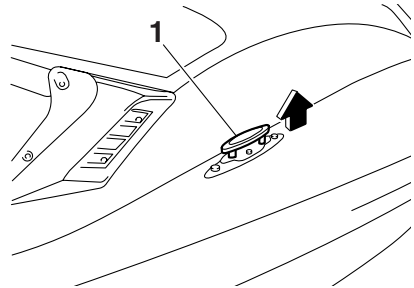

1 Pull-up cleat

EWJ00820

## **! WARNING**

**Do not use the pull-up cleats to lift the watercraft. The watercraft could fall, which could result in severe injury.**

EJU31370

## Yamaha Engine Management System (YEMS)

This model is equipped with an integrated, computerized management system that controls and adjusts ignition timing, fuel injection, engine diagnostics, and the off-throttle steering (OTS) system.

EJU36760

## Yamaha Security System

The Yamaha Security System functions to help prevent unauthorized use or theft of the watercraft. The engine cannot be started if the security system is in the lock mode. The engine can only be started in the unlock mode. The lock and unlock modes of the security system are selected using the remote control transmitter that is included with this watercraft.

## NOTE:

Since the watercraft is programmed to recognize the internal code from this transmitter only, the security system setting can only be changed with this transmitter. If you lose the remote control transmitter or if it does not op-

# Features and functions

operate properly, contact a Yamaha dealer. (See page 32 for operation of the remote control transmitter.)

Depending on the selected Yamaha Security System setting, the “UNLOCK” indicator light will come on or go off.

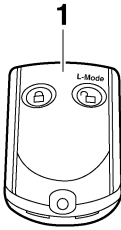

1 Remote control transmitter

EJU36770

## Yamaha Security System settings

The Yamaha Security System settings are selected by pressing the lock or unlock button on the remote control transmitter briefly.

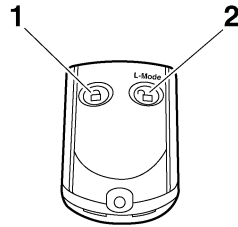

- 1 Lock button
- 2 Unlock button

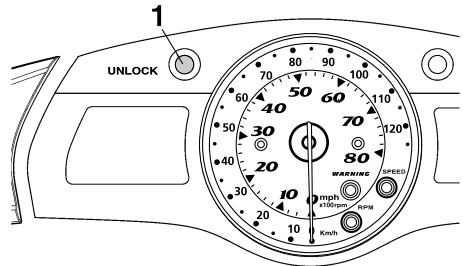

- 1 “UNLOCK” indicator light

### NOTE:

The lock and unlock modes of this system can only be selected while the engine is stopped.

### LOCK

When the lock button on the remote control transmitter is pressed briefly, the beeper sounds once and the “UNLOCK” indicator light goes off. This indicates the lock mode is selected and the engine cannot be started.

### UNLOCK

When the unlock button on the remote control transmitter is pressed briefly, the beeper sounds two or three times and the “UNLOCK” indicator light comes on. This indicates the

# Features and functions

unlock mode is selected and the engine can be started.

## NOTE:

The beeper sounds two times for the normal mode or three times for the low-RPM mode. (See the items in “Selecting the operation mode” for operation mode information.)

Number of beeps	Yamaha Security System mode	Engine can be started
●	Lock	NO
● ●	Unlock (normal mode)	YES
● ● ●	Unlock (low-RPM mode)	YES

EJU36780

## Selecting the operation mode

There are two operation modes in the unlock mode of the Yamaha Security System: the normal mode and the low-RPM mode. The normal mode and low-RPM mode can only be selected when the engine is stopped in the unlock mode. Press the unlock button on the remote control transmitter for more than 4 seconds to switch between the normal mode and the low-RPM mode.

### Normal mode

The watercraft can be ridden normally in this mode.

If the beeper sounds two times, the normal mode is activated.

### Low-RPM mode

Maximum engine speed (r/min) in this mode is limited to approximately 70% of the maximum engine speed in the normal mode.

If the beeper sounds three times, the low-RPM mode is activated and the “L-MODE” indicator light comes on.

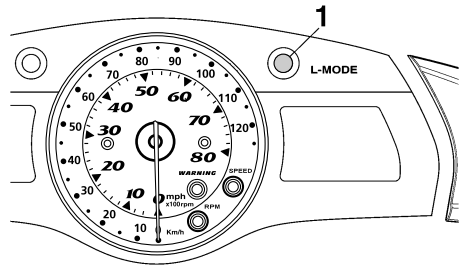

1 “L-MODE” indicator light

## NOTE:

If neither the start switch nor the remote control transmitter is operated within 25 seconds after the unlock button is pressed to select the unlock mode, the multifunction information center will turn off and enter a standby state. If the multifunction information center is in the standby state, start the engine to return the display and the indicator lights to their state before the center turned off.

EJU37011

### No-wake mode

The no-wake mode is a function that maintains the engine speed at a fixed setting for operating the watercraft at low speeds. This function can be used only for forward operation of the watercraft.

### Activating and deactivating the no-wake mode

Activation of the no-wake mode will be confirmed by the beeper and the digital speedometer display.

# Features and functions

Number of beeps	No-wake mode operation	Digital speedometer display
● ● ●	Activated	Starts flashing
● ●	Deactivated	Stops flashing

**NOTE:** \_\_\_\_\_  
 The beeps and the flashing digital speedometer display also indicate the activation of the cruise assist. (See page 44 for more information.)

To activate the no-wake mode:

**NOTE:** \_\_\_\_\_  
 The no-wake mode cannot be activated immediately after starting the engine. After starting the engine, wait for 5 seconds or more before activating the mode.

- (1) Release the throttle lever.
- (2) Check that the shift lever is in the forward position.

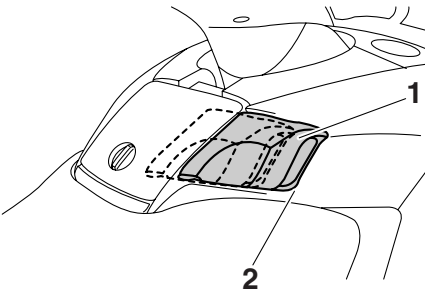

- 1 Shift lever
- 2 Forward position

**NOTE:** \_\_\_\_\_  
 The no-wake mode cannot be activated when the shift lever is in the reverse position.

- (3) Push and hold the “NO-WAKE MODE” switch. When the no-wake mode is acti-

ated, the beeper sounds three times quickly and “5” (when miles are selected) or “8” (when kilometers are selected) starts flashing in the digital speedometer display. Keep the throttle lever in the idle position when the no-wake mode is activated.

**NOTE:** \_\_\_\_\_  
 The digital speedometer display flashes continually while the no-wake mode is activated.

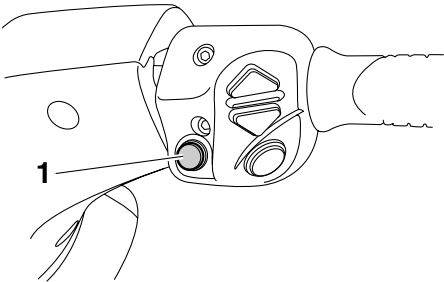

1 “NO-WAKE MODE” switch

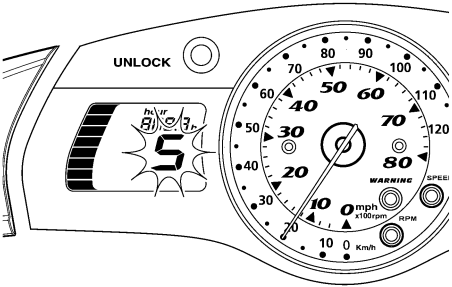

To deactivate the no-wake mode:  
 Perform one of the following procedures. The beeper sounds two times quickly and the digital speedometer display stops flashing when the no-wake mode is deactivated.

- Push the “NO-WAKE MODE” switch.
- Squeeze the throttle lever.



# Features and functions

**NOTE:** \_\_\_\_\_  
The no-wake mode is also deactivated when the engine is stopped.

EJU37021

## Cruise assist

The cruise assist is a function for maintaining a desired engine speed within a fixed range while operating the watercraft.

### Activating and deactivating the cruise assist

Activation of the cruise assist will be confirmed by the beeper and the digital speedometer display.

Number of beeps	Cruise assist operation	Digital speedometer display
● ● ●	Activated	Starts flashing
● ●	Deactivated	Stops flashing
●	Engine speed increases or decreases	Continues flashing

**NOTE:** \_\_\_\_\_  
The beeps and the flashing digital speedometer display also indicate the activation of the no-wake mode. (See page 42 for more information.)

### To activate the cruise assist:

- (1) Operate the throttle lever until the desired engine speed is reached.

### **NOTE:** \_\_\_\_\_

- The cruise assist can only be set between engine speeds of approximately 3000 r/min and approximately 7000 r/min.
- The cruise assist cannot be activated in the low-RPM mode. (See the items in 42 for operation mode information.)

- (2) Once the engine speed reaches the desired cruise assist setting, push the “SET”

switch. When the cruise assist is activated, the beeper sounds three times quickly and the digital speedometer display starts flashing. To keep the cruise assist activated, be sure to keep the throttle lever squeezed further than the position at which the cruise assist was set; releasing the throttle lever will deactivate the cruise assist.

**NOTE:** \_\_\_\_\_  
The digital speedometer display flashes continually while the cruise assist is activated. Make sure that the beeper has sounded and the digital speedometer display is flashing before squeezing the throttle lever to the full throttle position. If the speedometer display is not flashing, the cruise assist is not activated

# Features and functions

and the engine will respond normally to the throttle.

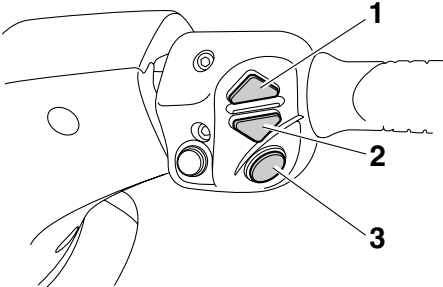

- 1 Up switch
- 2 Down switch
- 3 "SET" switch

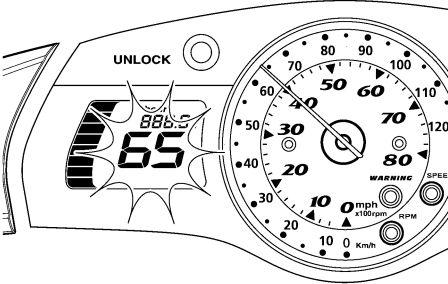

beeper will sound one time quickly and the engine speed will change. However, the adjustment is limited to a maximum of five increments above or below the initial cruise assist setting.

### To deactivate the cruise assist:

Relax your grip on the throttle lever. The beeper sounds two times quickly and the digital speedometer display stops flashing when the cruise assist is deactivated.

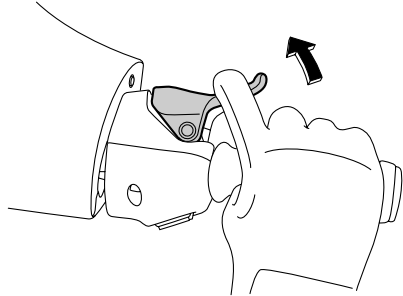

### NOTE:

The cruise assist is also deactivated when the engine is stopped.

EJU34902

### Multifunction information center

The multifunction information center is equipped with the following three main com-

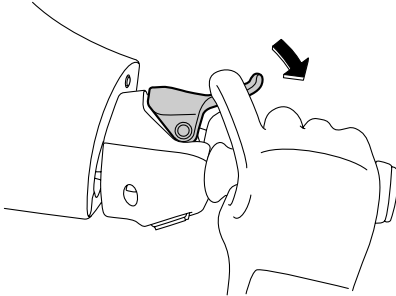

### NOTE:

Once the cruise assist is activated, the engine speed can be increased by pushing the up switch or decreased by pushing the down switch. Each time a switch is pushed, the

# Features and functions

ponents for help and convenience in operating the watercraft.

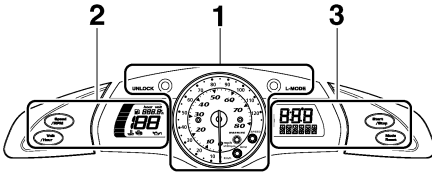

- 1 Analog speedometer/tachometer and indicator lights
- 2 Left multifunction display and operation buttons
- 3 Right multifunction display and operation buttons (for FX Cruiser SHO)

ECJ00072

## CAUTION:

**Do not run the engine for more than 15 seconds without supplying water or over 4000 r/min when checking the operation of the meter on land, otherwise the engine could overheat.**

## NOTE:

- When the multifunction information center starts operating, the analog speedometer/tachometer makes one sweep, all displays light up for 2 seconds, and then the meter starts to operate normally.
- The multifunction information center will continue to operate for 25 seconds after the engine stops.

EJU34930

## Analog speedometer/tachometer and indicator lights

This watercraft is equipped with the following meter and indicator lights.

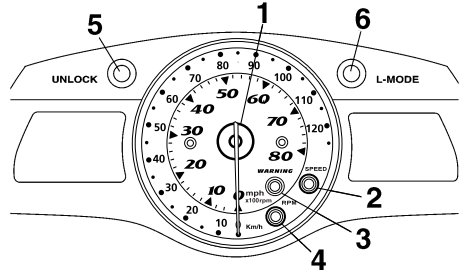

- 1 Analog speedometer/tachometer
- 2 "SPEED" indicator light
- 3 "WARNING" indicator light
- 4 "RPM" indicator light
- 5 "UNLOCK" indicator light
- 6 "L-MODE" indicator light

EJU36790

## Analog speedometer/tachometer

The analog speedometer/tachometer can be used as a speedometer or a tachometer.

To switch between the speedometer and the tachometer functions, push the "Speed/RPM" button for at least 1 second when the multifunction information center is operating.

The "SPEED" indicator light comes on when the analog speedometer is selected. The

# Features and functions

“RPM” indicator light comes on when the analog tachometer is selected.

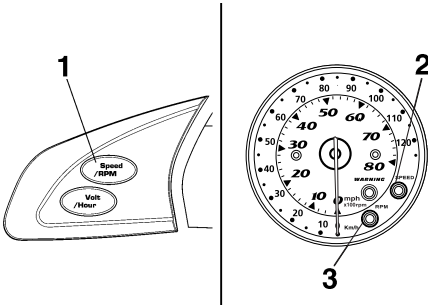

- 1 “Speed/RPM” button
- 2 “SPEED” indicator light
- 3 “RPM” indicator light

## NOTE:

The “SPEED” indicator light blinks three times, then comes on, if miles are selected as the display units when the analog speedometer/tachometer is switched to the speedometer function.

## Analog speedometer

The analog speedometer shows the watercraft speed against water.

The large inner numbers on the meter show the watercraft speed in miles per hour (mph) and the small outer numbers show the speed in kilometers per hour (km/h) when the speedometer function is selected.

## Analog tachometer

The analog tachometer shows the engine speed.

The large inner numbers on the meter show the engine speed ( $\times 100$  r/min) when the tachometer function is selected.

EJU36800

## “SPEED” indicator light

The “SPEED” indicator light comes on when the analog speedometer is selected.

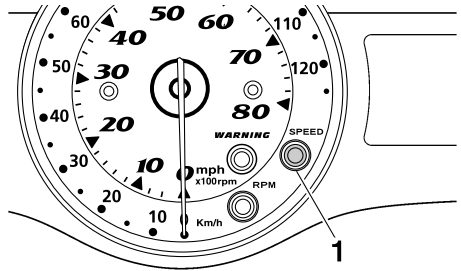

- 1 “SPEED” indicator light

The “SPEED” indicator light blinks three times in the following instances:

- The analog speedometer/tachometer is switched to the speedometer function when miles are selected as the display units.
- The display units of the multifunction information center are switched to miles from kilometers.
- Miles are selected as the display units when the multifunction information center starts operating.

EJU34960

## “RPM” indicator light

The “RPM” indicator light comes on when the analog tachometer is selected.

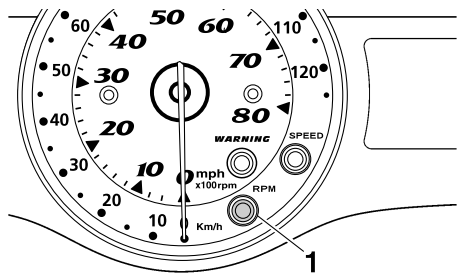

- 1 “RPM” indicator light

# Features and functions

EJU34980

## “WARNING” indicator light

The “WARNING” indicator light blinks or comes on, together with a warning indicator, when a malfunction has occurred.

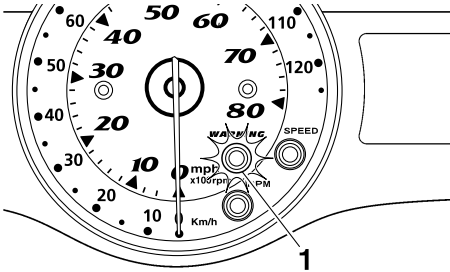

1 “WARNING” indicator light

EJU34990

## “UNLOCK” indicator light

The “UNLOCK” indicator light comes on when the unlock mode of the Yamaha Security System is selected. The watercraft can be ridden normally when this light is on. (See page 41 for more information.)

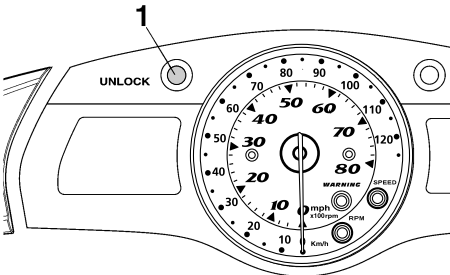

1 “UNLOCK” indicator light

EJU35010

## “L-MODE” indicator light

The “L-MODE” indicator light comes on when the low-RPM mode is selected. (See page 42 for more information.)

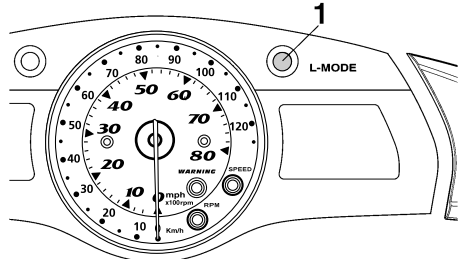

1 “L-MODE” indicator light

EJU35021

## Left multifunction display and operation buttons

The left multifunction display is equipped with the following functions.

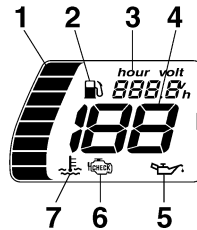

- 1 Fuel level meter
- 2 Fuel level warning indicator
- 3 Hour meter/voltmeter
- 4 Digital speedometer
- 5 Oil pressure warning indicator
- 6 Check engine warning indicator
- 7 Engine overheat warning indicator

# Features and functions

The following operation buttons are on the left side of the multifunction information center.

- Kilometers are selected as the display units at the Yamaha factory.

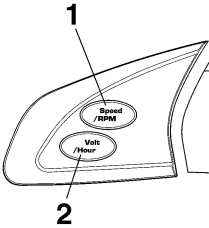

- 1 "Speed/RPM" button
- 2 "Volt/Hour" button

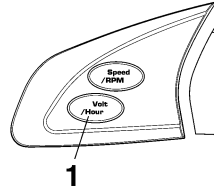

- 1 "Volt/Hour" button

EJU37080

## Digital speedometer

The digital speedometer shows the watercraft speed against water.

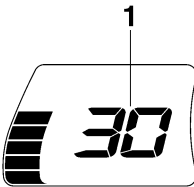

- 1 Digital speedometer

## NOTE:

- To switch the speedometer display between kilometers and miles, push the "Volt/Hour" button for at least 1 second, within 10 seconds after the multifunction information center starts operating.
- The "SPEED" indicator light blinks three times if miles are selected as the display units when the multifunction information center starts operating, or if the display units are switched to miles.

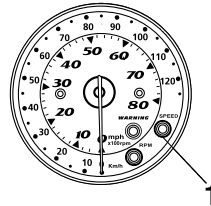

- 1 "SPEED" indicator light

EJU31511

## Fuel level meter

The fuel level meter is provided for convenient fuel level checking while riding.

# Features and functions

The fuel level meter has eight segments which show the amount of fuel remaining in the fuel tank.

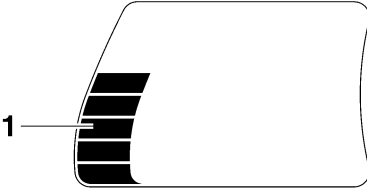

1 Fuel level meter

## NOTE:

The fuel level is most accurate when the watercraft is sitting level on a trailer or in the water.

EJU35060

## Hour meter/voltmeter

## NOTE:

To switch the display between the hour meter and the voltmeter, push the “Volt/Hour” button for at least 1 second after the meter is displayed for more than 10 seconds.

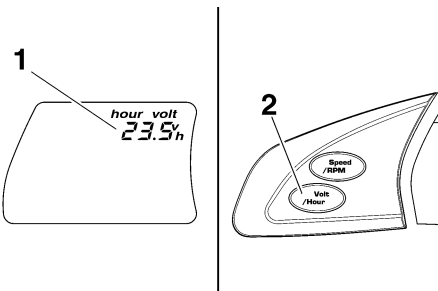

1 Hour meter/voltmeter

2 “Volt/Hour” button

## Hour meter

The hour meter is provided to make it easy to follow the maintenance schedule.

The meter shows the hours of engine operation that have elapsed since the watercraft was new.

## Voltmeter

The voltmeter is provided to display the voltage of the battery.

When the battery voltage is normal, the voltmeter displays approximately 12 volts.

If the battery voltage is less than 8.0 volts, “LO” is displayed on the voltmeter and if the voltage is above 18.1 volts, “HI” is displayed on the voltmeter. If “HI” or “LO” is displayed, return to shore and, if necessary, have a Yamaha dealer check the charging system and the battery.

EJU36810

## Fuel level warning indicator

If the fuel remaining in the fuel tank drops to about 18 L (4.8 US gal, 4.0 Imp.gal), the lowest two fuel level segments, the fuel level warning indicator, and the “WARNING” indicator light begin to blink. The buzzer also starts sounding intermittently.

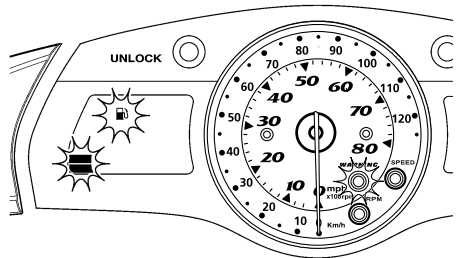

If this occurs, refill the fuel tank as soon as possible.

The warning signals will be cleared when the engine is restarted after the fuel tank is refilled.

## NOTE:

Press any button on the multifunction information center to stop the buzzer.

# Features and functions

EJU35122

## Oil pressure warning indicator

If the oil pressure does not rise to specification, the “WARNING” indicator light and the oil pressure warning indicator begin to blink, and the buzzer sounds intermittently. At the same time, the engine speed is limited to help prevent damage.

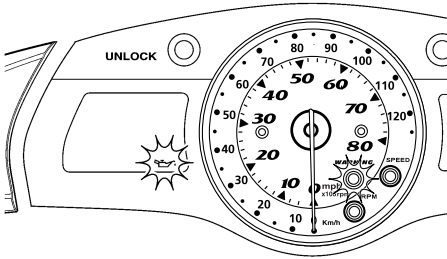

If this occurs, reduce the engine speed, return to shore, and then check the engine oil level. (See page 63 for engine oil level checking procedures.) If the oil level is low, add enough engine oil to raise it to the proper level. If the oil level is sufficient, have a Yamaha dealer check the watercraft.

### NOTE:

Press any button on the multifunction information center to stop the buzzer.

EJU36820

## Engine overheat warning indicator

This model is equipped with an engine overheat warning system.

If the engine starts to overheat, the “WARNING” indicator light and the engine overheat warning indicator blink, and then come on. The buzzer also begins to sound intermittently, and then it sounds continuously. After the light and indicator start to blink and the buzzer

sounds, the engine speed is limited to help prevent damage.

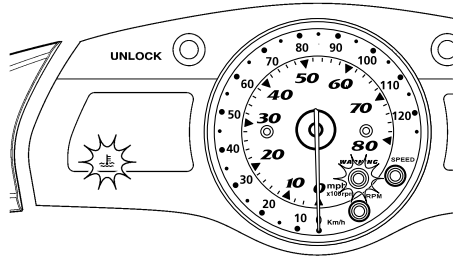

If this occurs, immediately reduce the engine speed, return to shore, and then check for water discharge at the port (left) cooling water pilot outlets while the engine is running. If there is no discharge of water, shut the engine off, and then check the intake grate and impeller for clogging.

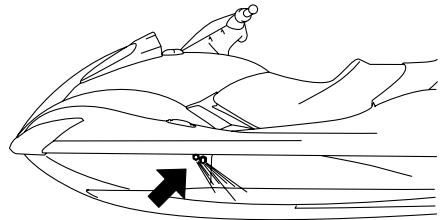

EWJ00050

### ! WARNING

**Before attempting to remove weeds or debris from the intake grate or impeller, shut the engine off and remove the clip from the engine shut-off switch. Severe injury or**



# Features and functions

death could result from coming in contact with the rotating parts of the jet pump.

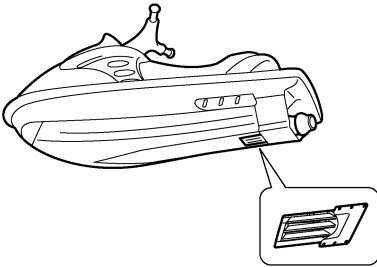
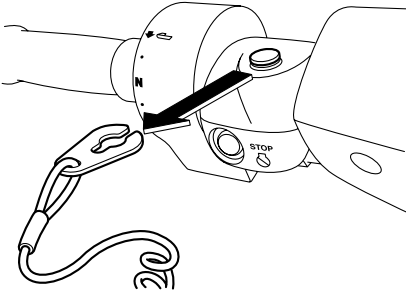

ECJ00040

## CAUTION:

If you cannot locate and correct the cause of the overheating, consult a Yamaha dealer. Continuing to operate at higher speeds could result in severe engine damage.

## NOTE:

Press any button on the multifunction information center to stop the buzzer.

EJU35131

## Check engine warning indicator

If a sensor malfunction or a short circuit is detected, the "WARNING" indicator light and the

check engine warning indicator begin to blink, and the buzzer sounds intermittently.

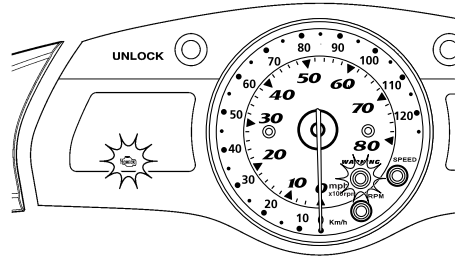

If this occurs, reduce the engine speed, return to shore, and have a Yamaha dealer check the engine.

## NOTE:

Press any button on the multifunction information center to stop the buzzer.

EJU35033

## Right multifunction display and operation buttons (for FX Cruiser SHO)

The right multifunction display shows the following information.

- Compass
- Average speed
- Tripmeter
- Trip timer
- Fuel consumption per hour
- Fuel consumption per kilometer/mile
- Water temperature
- Air temperature

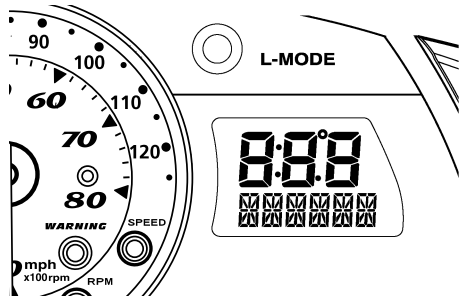

# Features and functions

The following operation buttons are on the right side of the multifunction information center.

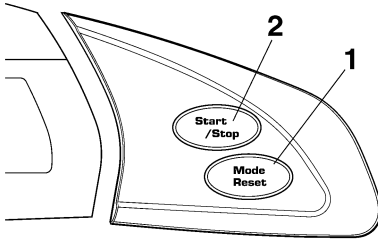

- 1 "Mode/Reset" button
- 2 "Start/Stop" button

To switch the display mode, push the "Mode/Reset" button for less than 1 second. The display mode changes in the following order.

Compass → Average speed → Tripmeter → Trip timer → Fuel consumption per hour → Fuel consumption per kilometer/mile → Water temperature → Air temperature

**NOTE:** \_\_\_\_\_

- To switch the display units between kilometers/liters/degrees Celsius and miles/gallons/degrees Fahrenheit, push the "Volt/Hour" button for at least 1 second, within 10 seconds after the multifunction information center starts operating.
- The "SPEED" indicator light blinks three times if miles/gallons/degrees Fahrenheit are selected as the display units when the multifunction information center starts oper-

ating, or if the display units are switched to miles/gallons/degrees Fahrenheit.

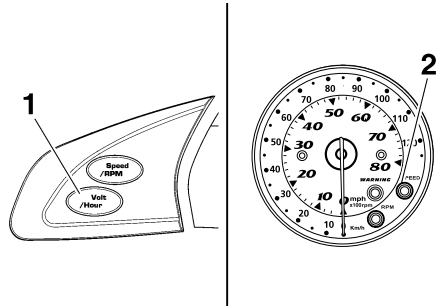

- 1 "Volt/Hour" button
- 2 "SPEED" indicator light

## Compass

This display shows the current direction of the watercraft using the 8 major compass points.

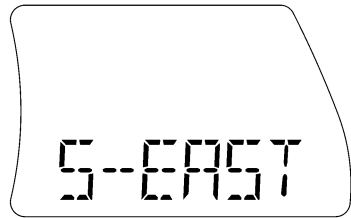

**NOTE:** \_\_\_\_\_

The accuracy of the compass varies depending on the operating conditions. Use this function as a reference only.

# Features and functions

## Average speed

This display shows the average speed in miles per hour "AV MPH" or kilometers per hour "AV KMH" since it was reset.

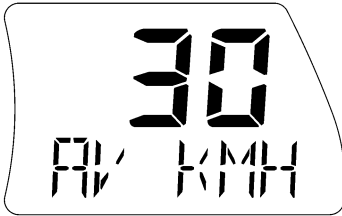

## Fuel consumption per hour

This display shows the current fuel consumption in gallons per hour "G/HR" or liters per hour "L/HR".

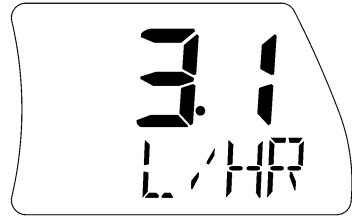

## Tripmeter

This display shows the distance traveled in miles "MILES" or kilometers "KM" since it was reset.

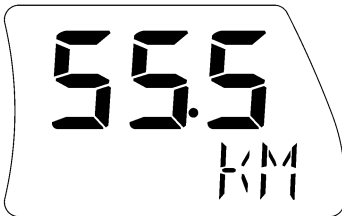

## Fuel consumption per kilometer/mile

This display shows the current fuel consumption in gallons per mile "G/MILE" or liters per kilometer "L/KM".

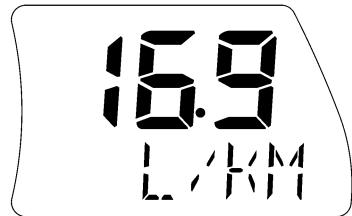

## Trip timer

This display shows the hours of operation "TRIP TM" since it was reset.



## NOTE:

The actual fuel consumption varies depending on the operating conditions. Use this function as a reference only.

# Features and functions

---

## Water temperature

This display shows the ambient water temperature “L TEMP” (lake temperature).

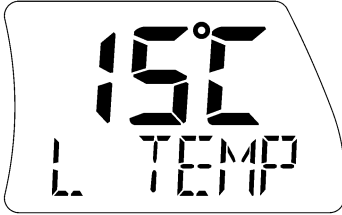

## Air temperature

This display shows the ambient air temperature “E TEMP” (environmental temperature).

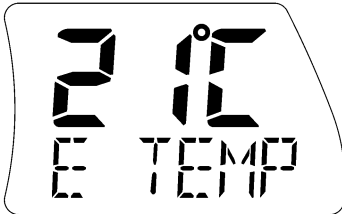

## Average speed/Tripmeter/Trip timer modes

Average speed, distance traveled, and trip time are recorded once measurements have started, regardless of the current display.

To start the measurements, push the “Start/Stop” button for less than 1 second. The beeper sounds once.

To stop the measurements, push the “Start/Stop” button for less than 1 second. The beeper sounds once. To restart the measurements, push the “Start/Stop” button for less than 1 second. The beeper sounds once. To reset the displays, push the “Mode/Reset” button for at least 2 seconds while the mea-

surements are stopped. The beeper sounds twice.

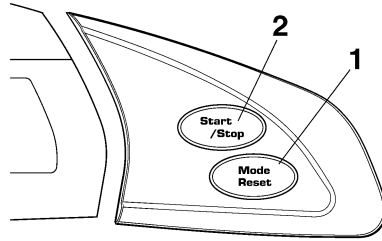

- 1 “Mode/Reset” button
- 2 “Start/Stop” button

## NOTE: \_\_\_\_\_

- The displays can be reset only when the measurements are stopped.
- The measurements are not saved if the engine is stopped. The displays are reset automatically when they go off 25 seconds after the engine stops.

---

EJU35141

## Storage compartments

A front storage compartment, glove compartment, seat storage compartment, watertight compartment, and beverage holder are provided.

## NOTE: \_\_\_\_\_

- Make sure that the storage compartments are closed securely before operating the watercraft.
  - The front storage compartment, glove compartment, and seat storage compartment are not designed to be watertight. If you carry objects that must be kept dry, such as the manuals, put them in a waterproof bag or the watertight compartment.
-

# Features and functions

EJU36831

## Front storage compartment

The front storage compartment is located at the bow.

To open the front storage compartment, pull the visor up, and then lift up the hood.

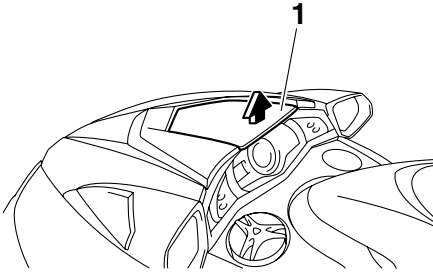

1 Visor



1 Front storage compartment

To close the front storage compartment, push down on the center of the hood until it latches securely.

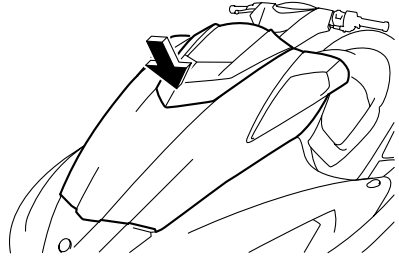

**NOTE:** \_\_\_\_\_  
Make sure that the front storage compartment is securely closed before operating the watercraft.

EJU35161

## Glove compartment

The glove compartment is located in front of the seat.

Front storage compartment:

Capacity:

66.0 L (17.4 US gal) (14.5 Imp.gal)

Load limit:

5.0 kg (11 lb)

# Features and functions

To open the glove compartment, turn the glove compartment knob, and then lift up the lid.

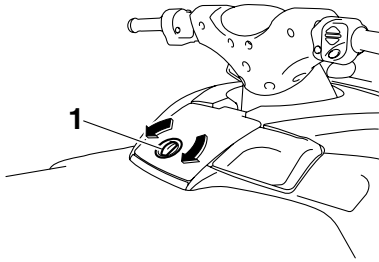

1 Glove compartment knob

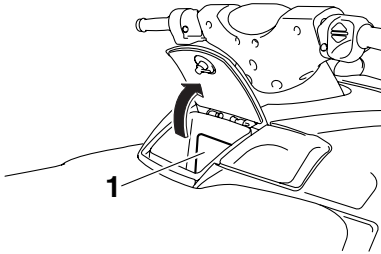

1 Glove compartment

Glove compartment: Capacity: 5.9 L (1.6 US gal) (1.3 Imp.gal) Load limit: 1.0 kg (2 lb)
---

To open the seat storage compartment, remove the rear seat. (See page 30 for rear seat removal and installation procedures.)

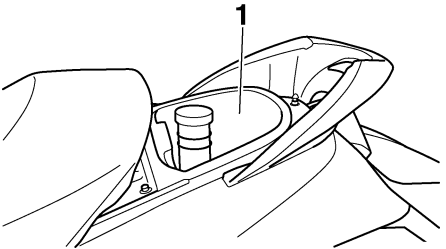
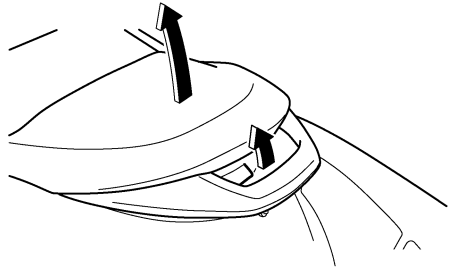

1 Seat storage compartment

Seat storage compartment: Capacity: 15.0 L (4.0 US gal) (3.3 Imp.gal) Load limit: 9.0 kg (20 lb)
--

To close the glove compartment, lower the lid, and then turn the glove compartment knob to lock the lid in place.

EJU31760

## Seat storage compartment

The seat storage compartment is located under the rear seat.

# Features and functions

EJU35170

## Beverage holder

The beverage holder is located on the starboard (right) side of the watercraft.

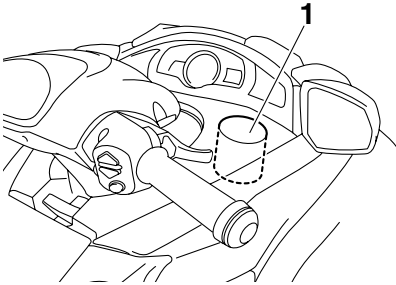

1 Beverage holder

**NOTE:** \_\_\_\_\_

Make sure that the watertight compartment cap is closed securely before operating the watercraft.

\_\_\_\_\_

**NOTE:** \_\_\_\_\_

Do not place beverages in the beverage holder when operating the watercraft.

\_\_\_\_\_

EJU35183

## Watertight compartment

The watertight compartment is located on the port (left) side of the watercraft.

To open the watertight compartment, turn the cap counterclockwise.

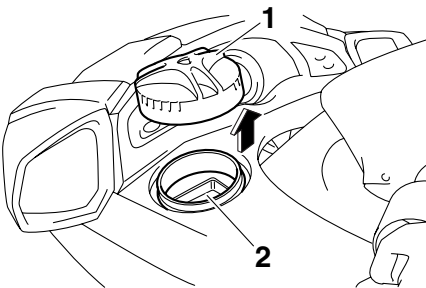

1 Watertight compartment cap

2 Watertight compartment

Watertight compartment:

Capacity:

2.7 L (0.7 US gal, 0.6 Imp.gal)

Load limit:

1.0 kg (2.2 lb)

# Operation

EJU31820

## Fuel and oil

This watercraft is equipped with a 4-stroke engine. Conventional 2-stroke engine oil cannot be used.

The engine utilizes an electronic fuel injection system to deliver the optimal air-fuel ratio required by the engine. By ensuring the optimal combustion conditions, this system is able to increase startability and improve fuel economy.

EJU31842

## Gasoline

EWJ00281



### **GASOLINE AND ITS VAPORS ARE HIGHLY FLAMMABLE AND EXPLOSIVE!**

- Do not smoke when refueling, and keep away from sparks, flames, and other sources of ignition.
- Stop the engine before refueling.
- Refuel in a well-ventilated area with the watercraft in a horizontal position.
- Do not stand or sit on the watercraft while refueling.
- Take care not to spill gasoline. If gasoline spills, wipe it up immediately with dry rags. Always properly dispose of gasoline-soaked rags.
- Avoid overfilling the fuel tank. Stop filling when the fuel level reaches approximately 50 mm (2 in) from the top of the fuel tank. Fuel expands as it warms up and could overflow if the fuel tank has been overfilled. If temporarily leaving the watercraft with a full fuel tank, do not leave it in direct sunlight. Leave it in a well-ventilated area with the watercraft in a horizontal position.
- Tighten the fuel tank filler cap securely after refueling.

- If you should swallow some gasoline, inhale a lot of gasoline vapor, or get gasoline in your eyes, get immediate medical attention.
- If any gasoline spills on your skin or clothing, immediately wash the affected area with soap and water and change your clothes.

ECJ00310

### **CAUTION:**

**Use only fresh gasoline that has been stored in clean containers.**

Recommended gasoline:

Regular unleaded gasoline with a minimum octane rating of  
 $86 \text{ (Pump octane number)} = (R + M)/2$   
90 (Research octane number)

EJU31860

## Gasohol

There are two types of gasohol: gasohol containing ethanol and that containing methanol. Gasohol containing ethanol can be used if ethanol content does not exceed 10% and the fuel meets the minimum octane ratings.

Gasohol containing methanol is not recommended by Yamaha because it can cause fuel system damage and engine performance problems.



EJU35613

## Engine oil

Use a combination of the recommended SAE and API engine oil classifications.

SAE								API
-4	14	32	50	68	86	104	122	F
-20	-10	0	10	20	30	40	50	C
								SE
								SF
								SG
								SH
								SJ
								SL

ECJ00280

### CAUTION:

Use only 4-stroke engine oil.

EJU36860

## Filling the fuel tank

ECJ00290

### CAUTION:

Be careful when refueling. Avoid getting water and other contaminants in the fuel tank. Contaminated fuel can cause poor running and engine damage.

- (1) Remove the seats, and check the fuel level. (See page 30 for seat removal and installation procedures.)
- (2) Open the hood. (See page 31 for hood opening and closing procedures.)
- (3) Remove the fuel tank filler cap, and then slowly add fuel to the fuel tank. Stop filling when the fuel level reaches approximate-

ly 50 mm (2 in) from the top of the fuel tank as indicated in the illustration.

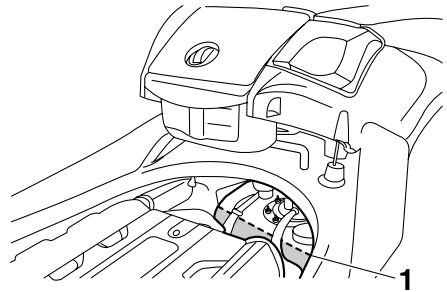

1 Approximately 50 mm (2 in) from top of the fuel tank

- (4) Install the fuel tank filler cap, and then close the hood and install the seats.

Fuel tank capacity:  
70 L (18.5 US gal) (15.4 Imp.gal)

# Operation

EJU31980

## Pre-operation checks

EJU31990

### Pre-operation check list

Before operating this watercraft, perform the checks in the following check list. See the accompanying text in this chapter for details on how to perform the checks.

EWJ00410



**If any item in the pre-operation check list is not working properly, have it inspected and repaired before operating the watercraft, otherwise an accident could occur.**

ITEM	ROUTINE	PAGE
<b>BEFORE LAUNCH OR OPERATION</b>		
<b>Engine compartment</b>	Remove the seats to ventilate the engine compartment. Check for fuel vapors and loose electrical connections.	63
<b>Bilge</b>	Check for water and fuel and drain if necessary.	65
<b>Stern drain plugs</b>	Check for proper installation.	66
<b>Throttle lever</b>	Check that the throttle lever springs back smoothly.	67
<b>Steering system</b>	Check for proper operation. Check that the handlebars are locked in place.	67
<b>Shift lever and reverse gate</b>	Check for proper operation.	68
<b>QSTS</b>	Check for proper operation.	69
<b>Fuel and oil</b>	Check the fuel and oil levels and replenish if necessary. Check the hoses and tanks for leakage.	63, 63
<b>Water separator</b>	Check for water and drain if necessary.	64
<b>Battery</b>	Check the electrolyte level and battery condition.	66
<b>Hood</b>	Check that the hood is securely closed.	31
<b>Front and rear seats</b>	Check that the seats are securely installed.	30
<b>Hull and deck</b>	Check the hull and deck for cracks and other damage.	63
<b>Jet intake</b>	Check for debris and remove if necessary.	69
<b>Fire extinguisher</b>	Check the condition and replace if necessary.	67
<b>Engine shut-off cord</b>	Check the condition and replace if frayed or broken.	70
<b>Switches</b>	Check the start switch, engine stop switch, and engine shut-off switch for proper operation.	70
<b>AFTER LAUNCH</b>		
<b>Cooling water pilot outlet</b>	Check that water is discharged while the engine is running and the watercraft is in the water.	70
<b>Multifunction information center</b>	Check for warning indications and proper operation.	71

**NOTE:**

---

Pre-operation checks should be made each time the watercraft is used. These checks can be completed in a short time. It is worth the time spent to ensure safety and reliability.

---

# Operation

---

EJU32280

## Pre-operation check points

EJU32330

### Engine compartment

Ventilate the engine compartment before each use.

To ventilate the engine compartment, remove the seats. (See page 30 for seat removal and installation procedures.) Leave the engine compartment open for a few minutes to allow any fuel vapors to escape.

While the engine compartment is open, check for loose electrical connections.

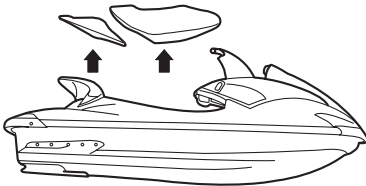

EWJ00460

### **WARNING**

**Failure to ventilate the engine compartment could result in a fire or explosion. Do not start the engine if there is a fuel leak or a loose electrical connection.**

---

EJU32350

### Hull and deck

Check the hull and deck for cracks and other damage. If any damage is found, have a Yamaha dealer repair the watercraft.

EJU36870

### Fuel level

Check the fuel system for leakage, cracks, and malfunctions before each use. (See page 93 for check points and correct procedures.)

- (1) Open the hood and remove the fuel tank filler cap to release any pressure that might have built up in the fuel tank. (See

page 31 for hood opening and closing procedures.)

- (2) Remove the seats. (See page 30 for seat removal and installation procedures.)
- (3) Check the fuel level in the fuel tank and replenish if necessary. (See page 60 for filling procedures.)
- (4) Install the fuel tank filler cap, and then close the hood and install the seats.

EJU36881

### Engine oil level

Check the engine oil level before each use.

ECJ01000

### **CAUTION:**

- **Make sure that the engine has enough oil, but do not overfill it. If there is too little oil, the engine can be damaged. If there is too much oil, the air filter can become saturated with oil, permanently damaging the filter and reducing engine performance. Follow the checking procedure carefully.**
  - **Make sure that debris and water do not enter the oil filler hole. Debris and water in the engine oil can cause serious engine damage.**
- 

To check the engine oil level:

- (1) Place the watercraft in a precisely level position on land with the engine stopped.

### **NOTE:**

If the engine was running, allow the engine oil to settle by waiting 5 minutes or more before checking the oil level.

---

- (2) Remove the seats. (See page 30 for seat removal and installation procedures.)
- (3) Remove the dipstick, wipe it clean, and then insert it back into the dipstick tube completely. Remove the dipstick again and check that the engine oil level is be-

tween the minimum and maximum level marks.

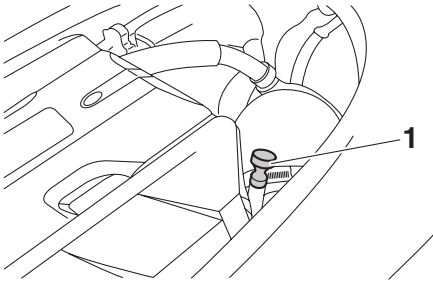

1 Dipstick

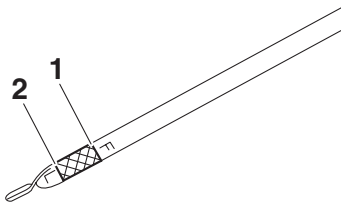

- 1 Maximum level mark
- 2 Minimum level mark

- (4) If the engine oil level is below the minimum level mark, perform steps 5–7 to add enough oil so that the oil level is between the minimum and maximum level marks on the dipstick. If the engine oil level is significantly above the maximum level mark, have a Yamaha dealer service the watercraft.

- (5) Remove the engine oil filler cap.

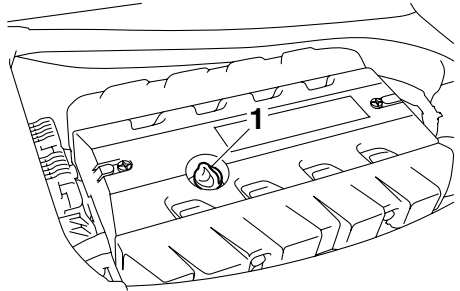

1 Engine oil filler cap

- (6) Pour engine oil into the filler hole. Wait approximately 5 minutes until the engine oil settles.

**NOTE:** \_\_\_\_\_  
The difference between the minimum and maximum level marks on the dipstick is equal to approximately 1 liter of engine oil.  
\_\_\_\_\_

- (7) Repeat steps 3–6 until the engine oil is at the proper level.  
(8) Install the engine oil filler cap, and then install the seats.

EJ-U32420

### Water separator

Check the water separator for water. The water separator retains any water that may have entered through the fuel tank breather hose if

# Operation

the watercraft was capsized. Normally, the water separator is empty.

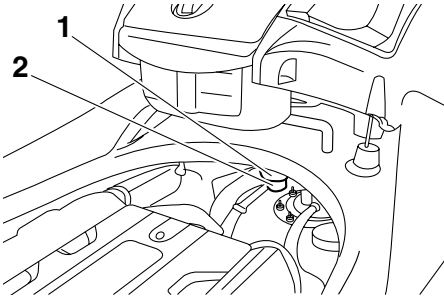

- 1 Water separator
- 2 Drain screw

If water remains in the water separator, drain it by removing the drain screw. Place a drain pan under the water separator to catch the draining water or use a dry cloth to soak up any water that could spill into the watercraft. If any water spills into the watercraft, be sure to wipe it up with a dry cloth. Also, be sure to install the drain screw after draining the water separator.

EJU32450

## Bilge

Check the bilge for moisture and fuel residue. This watercraft is equipped with a conventional jet vacuum bilge draining system and an electric bilge draining system. The electric bilge draining system is operated when the engine is running. When excess water reaches the water inlet of the electric bilge pump,

the water is discharged from the electric bilge pilot outlet at the stern.

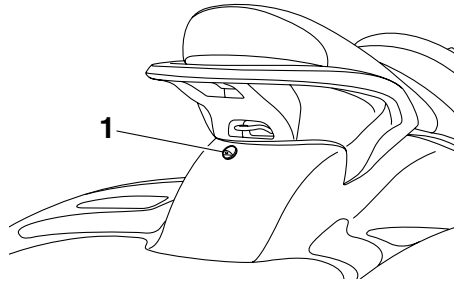

- 1 Electric bilge pilot outlet

A small quantity of water will remain in the bilge and should be drained manually. To drain any residual water, beach the watercraft and perform the following procedure.

EGJ00350

### **CAUTION:**

**If starting the engine after the watercraft has capsized, do not operate the engine at full throttle when water is being discharged from the electric bilge pilot outlet at the stern. Excessive water in the bilge can splash into the engine, which can result in severe damage.**

### To drain water from the bilge:

- (1) Remove the stern drain plugs.
- (2) Raise the bow of the watercraft until the water drains.
- (3) After the water has drained, wipe the bilge with dry rags to make sure that it is thoroughly dry.
- (4) Install the stern drain plugs.

EGJ00360

### **CAUTION:**

- **Before installing the stern drain plugs, clean the drain plug threads to remove any foreign materials, such as dirt or sand. Otherwise, the stern drain plugs**

could be damaged, allowing water to enter the engine compartment.

- **Make sure that the stern drain plugs are tightened securely before launching the watercraft. Otherwise, water may flood the engine compartment and cause the watercraft to submerge.**

EJU32471

## Stern drain plugs

Check the stern drain plugs for proper installation.

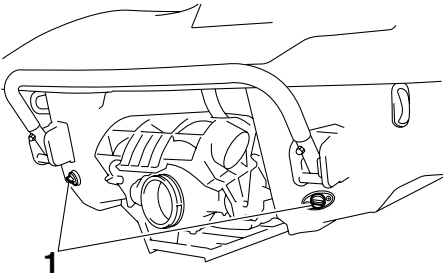

1 Stern drain plugs

ECJ00360

## CAUTION:

- **Before installing the stern drain plugs, clean the drain plug threads to remove any foreign materials, such as dirt or sand. Otherwise, the stern drain plugs could be damaged, allowing water to enter the engine compartment.**
- **Make sure that the stern drain plugs are tightened securely before launching the watercraft. Otherwise, water may flood the engine compartment and cause the watercraft to submerge.**

EJU32481

## Battery

Check the battery electrolyte level and check that the battery has sufficient power to start the engine easily. Recharge the battery or re-

place it if it is not in good condition. (See page 99 for battery recharging procedures.)

Also, check that the battery leads are tightened securely and that there is no corrosion on the battery terminals. Check that the breather hose is securely connected to the battery and that it is not pinched.

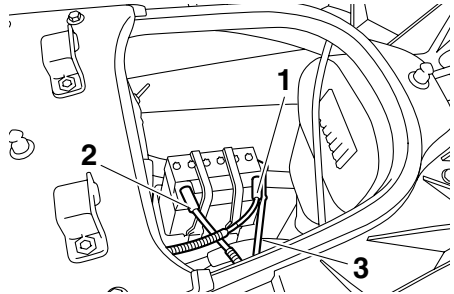

- 1 Positive (+) battery terminal: Red lead
- 2 Negative (-) battery terminal: Black lead
- 3 Breather hose

EWJ00450

## WARNING

- **The battery must always be fully charged and in good condition. Loss of battery power may leave you stranded. Never operate the watercraft if the battery does not have sufficient power to start the engine or if it shows any other signs of decreased power.**
- **Be sure to connect the breather hose to the battery. Fire or explosion could result if the breather hose is damaged, obstructed, or not connected properly.**

Make sure that the battery is securely held in place.

# Operation

EJU32570

## Fire extinguisher

Check that there is a full fire extinguisher on board.

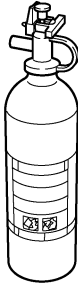

The fire extinguisher container is located in the seat storage compartment.

To open the fire extinguisher container, turn the cap counterclockwise.

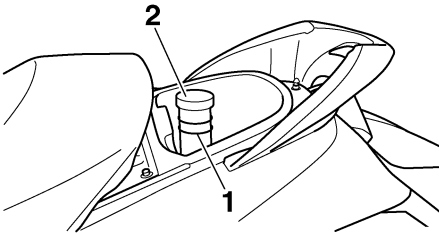

- 1 Fire extinguisher container
- 2 Fire extinguisher container cap

To close the fire extinguisher container, insert the fire extinguisher into the container, and then install the cap and tighten it securely.

### NOTE:

- To check the fire extinguisher, see the instructions supplied by the fire extinguisher manufacturer. Always keep the fire extinguisher in the fire extinguisher container.
- Always carry a fire extinguisher on board. A fire extinguisher is not standard equipment with this watercraft. If you do not have one,

contact a Yamaha dealer or a fire extinguisher dealer to obtain one meeting the proper specifications.

Fire extinguisher:  
Classification:  
B-1  
Capacity:  
2 lb or more

EJU32590

## Throttle lever

Check the throttle lever for proper operation. Squeeze and release the throttle lever several times to make sure that there is no hesitation in its travel. It should be smooth over the complete range and spring back to the idle position when released.

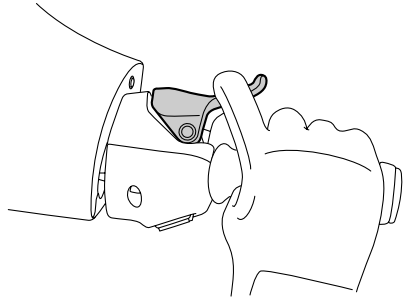

EWJ00490

### WARNING

**Before starting the engine, always check the operation of the throttle lever.**

EJU32610

## Steering system

Check the handlebars for looseness.

Turn the handlebars as far as possible to the right and left to make sure that operation is smooth and unrestricted throughout the whole range. Also, make sure that the jet thrust nozzle moves as the handlebars are



turned, and that there is no free play between the handlebars and the jet thrust nozzle.

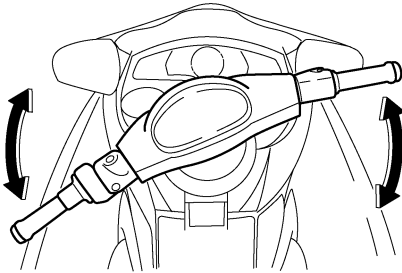

Check that the handlebars are locked in place. (See “Tilt lever” on page 36 for more information.)

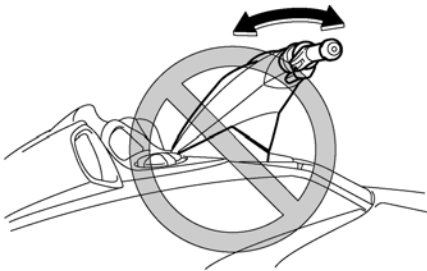

EJU36580

## Shift lever and reverse gate

Check the shift lever and reverse gate for proper operation.

Make sure that the reverse gate goes down completely when the shift lever is pulled up.

Also, make sure that the reverse gate goes up completely when the shift lever is pushed down.

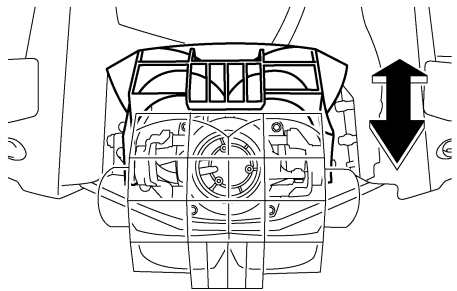
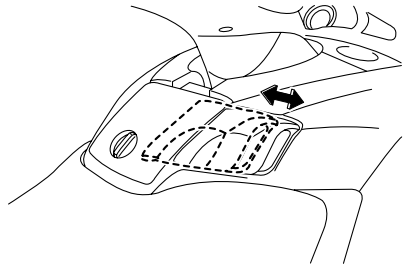

EWJ00030

## WARNING

- Make sure that the throttle lever is completely released and that the engine is at idle before shifting into reverse.
- Do not use the reverse function to slow down or stop the watercraft as it could cause you to lose control, be ejected, or impact the handlebars.
- Use reverse for slow-speed maneuvering only.
- Make sure that there are no obstacles or people behind you before shifting into reverse.
- Do not touch the reverse gate while the shift lever is being operated, otherwise you could be pinched.

# Operation

EJU32641

## Quick Shift Trim System (QSTS)

Operate the QSTS selector lock lever and the QSTS selector several times to check that they operate properly.

- (1) Squeeze the QSTS selector lock lever and check that it returns smoothly to its original position when released.

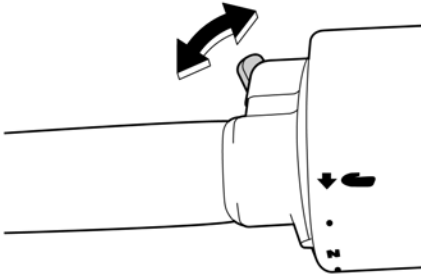

- (2) Check that the QSTS selector turns smoothly when the lever is squeezed and check that the selector locks in place at each position when the lever is released.

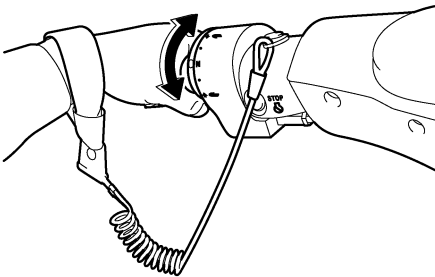

- (3) Check that the angle of the jet thrust nozzle changes when the QSTS selector is

shifted from neutral to bow up or bow down.

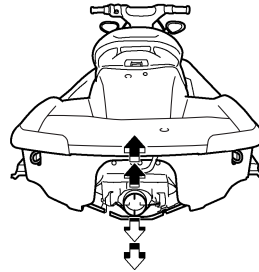
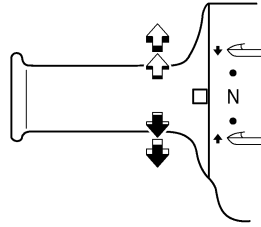

If the mechanism does not work properly, have a Yamaha dealer service it.

EJU32650

## Jet intake

Carefully check the jet intake for weeds, debris, or anything else that might restrict the intake of water. If the jet intake is clogged, cavitation could occur, reducing jet thrust, and possibly damaging the jet pump.

In some cases, the engine may overheat because of lack of cooling water, and damage to the engine could result. Cooling water is fed to the engine by the jet pump. (See page 106 for jet intake cleaning procedures.)

EWJ00470

## WARNING

- Keep away from the intake grate while the engine is on. Items such as long hair, loose clothing, or PFD straps can be

come entangled in moving parts, resulting in severe injury or drowning.

- Stop the engine and remove the clip from the engine shut-off switch before removing any debris or weeds, which may have collected around the jet intake.

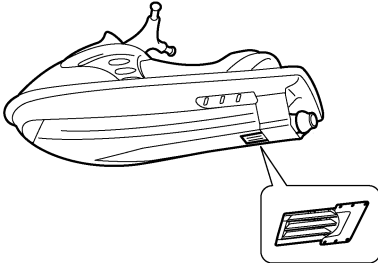
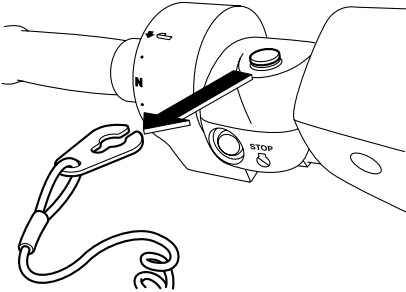

EJU32660

## Engine shut-off cord

Check that the engine shut-off cord is not frayed or broken. If the cord is damaged, replace it; never try to repair it or tie it together.

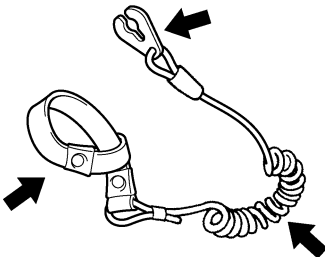

EJU32670

## Switches

ECJ00410

### CAUTION:

Do not run the engine for more than 15 seconds when checking the switches on land without supplying water, otherwise the engine could overheat.

Check the start switch, the engine stop switch, and the engine shut-off switch for proper operation.

Push the start switch to start the engine. As soon as the engine starts running, push the engine stop switch to verify that the engine stops immediately. Restart the engine, and then pull the engine shut-off cord to remove the clip from the engine shut-off switch to verify that the engine stops immediately. (See pages 33 to 34 for information on proper operation of the start switch, the engine stop switch, and the engine shut-off switch.)

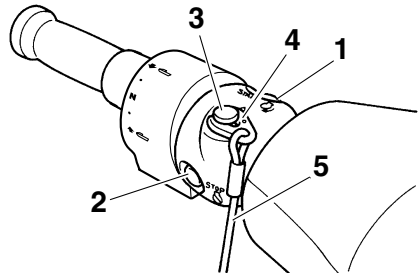

- 1 Start switch
- 2 Engine stop switch
- 3 Engine shut-off switch
- 4 Clip
- 5 Engine shut-off cord

EJU36890

## Cooling water pilot outlets

Check that water comes out from the port (left) cooling water pilot outlets while the en-

# Operation

---

engine is running and the watercraft is in the water. (See page 34 for more information.)

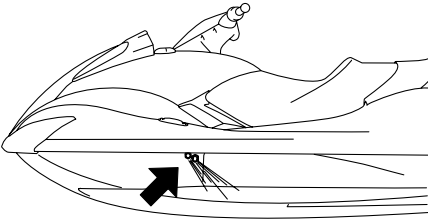

EJU32710

## Multifunction information center

Check the multifunction information center for proper operation. (See page 45 for information on proper operation of the multifunction information center.)



EJU32740

## Operation

EWJ00510

### **WARNING**

**Before operating your watercraft, become familiar with all of the controls. Consult a Yamaha dealer about any control or function that you do not fully understand. Failure to understand how the controls work could cause an accident or prevent you from avoiding an accident.**

---

ECJ00460

### **CAUTION:**

**Make sure that the stern drain plugs are tightened securely before launching the watercraft.**

---

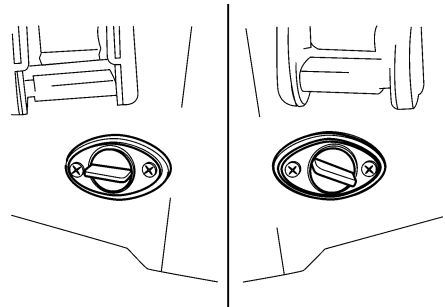

EJU36660

## Engine break-in

The engine break-in period is essential to allow the various components of the engine to wear and polish themselves to the correct operating clearances. This ensures proper performance and promotes longer component life.

ECJ00440

### **CAUTION:**

**Be sure to check the engine oil level before operating the watercraft for the first time. (See page 63 for engine oil checking procedures.)**

---

- (1) Launch the watercraft and start the engine. (See page 72 for engine starting procedures.)
  - (2) For the first 5 minutes, run the engine at trolling speed only. For the 30 minutes of operation after that, keep the engine speed below 5000 r/min. For the 1 hour of operation after that, keep the engine speed below 6000 r/min.
  - (3) Proceed with normal operation.
- (1) If the lock mode of the Yamaha Security System is selected, use the remote control transmitter to select the unlock mode. (See page 41 for Yamaha Security System lock and unlock mode selection procedures.)
  - (2) Launch the watercraft in water free from weeds and debris and at least 60 cm (2 ft) deep.

ECJ00430

## CAUTION:

**Failure to follow the engine break-in procedure could result in reduced engine life or even severe engine damage.**

EJU32801

## Launching the watercraft

When launching the watercraft, make sure that there are no obstacles behind you.

Use the remote control transmitter to select the unlock mode. (See page 41 for Yamaha Security System lock and unlock mode selection procedures.)

After the watercraft is in the water, start the engine. Shift into reverse and move the watercraft back slowly. If there are waves, someone should make sure that the watercraft is not pushed into the trailer before backing away.

EJU36340

## Starting the engine

EWJ00560

## WARNING

**Never start the engine or let it run for any length of time in an enclosed area. Exhaust fumes contain carbon monoxide, a colorless, odorless gas that may cause loss of consciousness and death within a short time. Always operate the watercraft in an open area.**

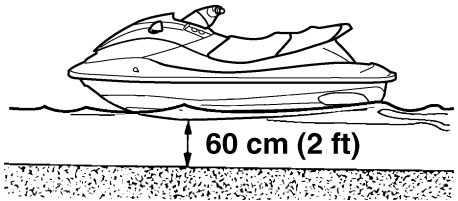

EWJ00570

## WARNING

**Never operate in water that is less than 60 cm (2 ft) deep, otherwise you increase your chance of hitting a submerged object, which could result in injury.**

ECJ00470

## CAUTION:

**Never operate in water that is less than 60 cm (2 ft) deep, otherwise pebbles or sand could be sucked into the jet intake, causing impeller damage and engine overheating.**

# Operation

---

(3) Attach the engine shut-off cord to your left wrist, and then attach the clip to the engine shut-off switch.

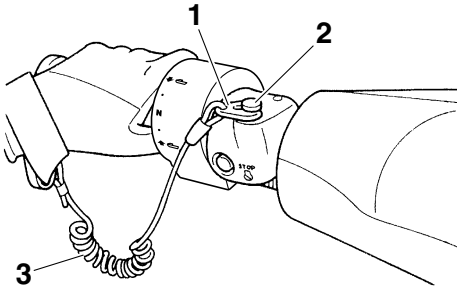

- 1 Clip
- 2 Engine shut-off switch
- 3 Engine shut-off cord

EWJ00580

## **WARNING**

Check that the engine shut-off cord is not frayed or broken, and keep it free from the handlebars so that the engine stops if the operator falls off. The engine shut-off cord may not pull free if wrapped around the handlebars when the operator falls off, allowing the watercraft to continue to run and cause an accident.

---

## **NOTE:**

It is not possible to start the engine with the clip removed from the engine shut-off switch.

---

(4) Push the start switch (green button), and then release it as soon as the engine starts to run.

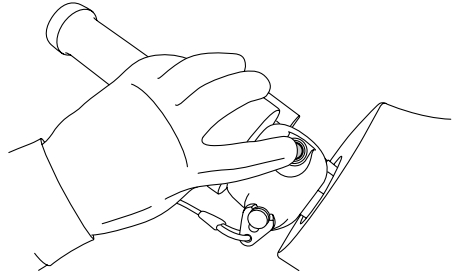

## **NOTE:**

The engine will not start if the throttle lever is squeezed.

---

EGJ00480

## **CAUTION:**

- Never push the start switch while the engine is running.
  - Do not operate the start switch for more than 5 seconds, otherwise the battery will be discharged and the engine will not start. Also, the starter motor could be damaged. If the engine does not start in 5 seconds, release the start switch, wait 15 seconds, and then try again.
-

EJU32860

## Stopping the engine

To stop the engine, release the throttle lever, and then push the engine stop switch (red button).

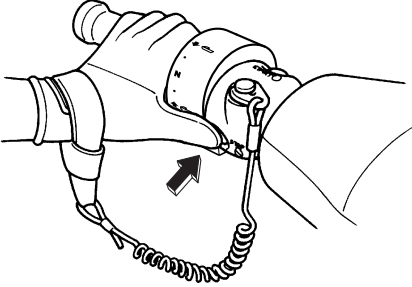

EWJ00600

## **WARNING**

**You need throttle to steer. Shutting the engine off can cause you to hit an obstacle you are attempting to avoid. A collision could result in severe injury or death.**

EJU32881

## Leaving the watercraft

If leaving the watercraft, select the lock mode of the Yamaha Security System and remove the engine shut-off cord to reduce the chance of accidental starting or unauthorized use by children or others. (See page 41 for Yamaha Security System lock and unlock mode selection procedures.)

EJU32900

## Operating your watercraft

EJU32951

### Getting to know your watercraft

Operating your watercraft requires skills acquired through practice over a period of time. Take the time to learn the basic techniques well before attempting more difficult maneuvers.

Operating your new watercraft can be a very enjoyable activity, providing you with hours of pleasure. However, it is essential to familiarize yourself with the operation of the watercraft to achieve the skill level necessary to enjoy riding safely.

Before operating this watercraft, read this owner's/operator's manual, the Riding Practice Guide, the Riding Instruction card, and all warning and caution labels on the watercraft. Pay particular attention to the safety information on page 10. Also, watch the Basic Orientation Video provided with your watercraft. These materials should give you an understanding of the watercraft and its operation. Remember: This watercraft is designed to carry the operator and up to 2 passengers. Never exceed the maximum load limit or allow more than 3 persons (or 2 persons if a water skier is being pulled) to ride the watercraft at any time.

Maximum load: 240 kg (530 lb) Load is the total weight of cargo, operator, and passengers.
--

EJU32990

### Learning to operate your watercraft

Before operating the watercraft, always perform the pre-operation checks listed on page 61. The short time spent checking the watercraft will reward you with added safety and reliability.

# Operation

---

Check state and local laws before operating your watercraft.

Operate defensively at safe speeds and keep a safe distance away from people, objects, and other watercraft. Select a wide area to learn in, where there is good visibility and light boat traffic.

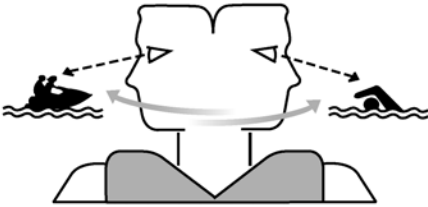

Use the buddy system—operate with someone nearby. Scan constantly for people, objects, and other watercraft. Be alert for conditions that limit your visibility or block your vision of others.

Attach the engine shut-off cord to your left wrist and keep it free from the handlebars so that the engine stops if you, the operator, fall off.

Wear a personal flotation device (PFD). All riders must wear a U.S. Coast Guard approved PFD that is suitable for personal watercraft use.

Wear protective clothing. Severe internal injuries can occur if water is forced into body cavities as a result of falling into the water or being near the jet thrust nozzle. Normal swimwear does not adequately protect against forceful water entry into the rectum and vagina. All riders must wear a wetsuit bottom or clothing that provides equivalent protection.

Such clothing includes thick, tightly woven, sturdy and snug-fitting apparel such as denim, but does not include spandex or similar

fabrics, like those used in bicycle shorts. A full wetsuit can also protect against hypothermia (subnormal body temperature) and abrasions.

Footwear and gloves are recommended.

Eye protection is recommended to keep wind, water, and glare from the sun out of your eyes while you operate your watercraft. Restraining straps for eyewear are made which are designed to float should your eyewear fall in the water.

You should grip the handlebars firmly and keep both feet on the floor of the footwell. Do not attempt to ride with passengers until your operating skills are fully developed.

EJU33050

## Riding with passengers

When 2 or 3 persons (including the operator) are on board, the watercraft handles differently, and is not as easy to maneuver, so operating it requires a higher degree of skill. Before attempting to operate the watercraft with passengers on board, the operator must practice operating the watercraft alone enough to be able to acquire the necessary skills.

The passengers must always wear a U.S. Coast Guard approved PFD and a wetsuit bottom or equivalent.

EWJ00540

## **WARNING**

**Do not apply throttle when anyone is at the rear of the watercraft. Turn the engine off or keep it at idle. Water and/or debris exiting the jet thrust nozzle can cause severe injury. Passengers should not attempt to board the watercraft if the operator is applying throttle.**

---

Do not give a ride to children whose feet cannot reach the floor of the footwell. The passengers should hold on firmly, either to the person in front of them or to the handgrip pro-



vided, and keep their feet on the floor of the footwell. Never allow a passenger to ride in front of the operator.

EWJ00550

## **WARNING**

When passengers are on board, make sure that they are holding on firmly and have their feet on the floor of the footwell before you start to accelerate.

When pulling a water-skier, the spotter should face to the rear while holding the handgrip with both hands. The spotter should always sit astride the seat with both feet placed firmly on the floor of the footwell for proper balance. Follow state laws regarding water-skiing, such as those for skier-down flags, rearward-facing spotter, and other requirements.

EJU33080

## Starting the watercraft

EWJ00710

## **WARNING**

- Scan constantly for people, objects, and other watercraft. Be alert for conditions that limit your visibility or block your vision of others.
- Operate defensively at safe speeds and keep a safe distance away from people, objects, and other watercraft.
- Do not follow directly behind watercraft or other boats. Do not go near others to spray or splash them with water. Avoid sharp turns or other maneuvers that make it hard for others to avoid you or understand where you are going. Avoid areas with submerged objects or shallow water.
- Take early action to avoid collisions. Remember, watercraft and other boats do not have brakes. Do not release the throttle lever when trying to steer away from objects—you need throttle to steer.

- Practice reboarding in shallow water before riding in deep water.

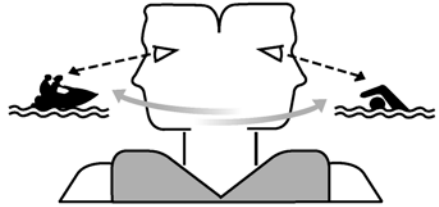

EJU33091

## Boarding and starting in shallow water

- (1) Launch the watercraft in water free from weeds and debris and at least 60 cm (2 ft) deep.

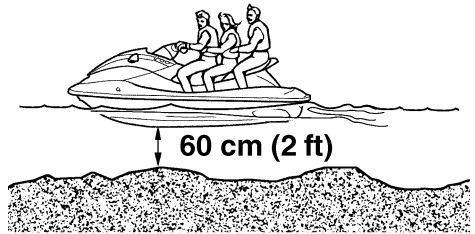

EWJ00570

## **WARNING**

Never operate in water that is less than 60 cm (2 ft) deep, otherwise you increase your chance of hitting a submerged object, which could result in injury.

ECJ00470

## **CAUTION:**

Never operate in water that is less than 60 cm (2 ft) deep, otherwise pebbles or sand could be sucked into the jet intake, causing impeller damage and engine overheating.

# Operation

---

- (2) Board the watercraft from the side or the rear.
- (3) Attach the engine shut-off cord to your left wrist, and then attach the clip to the engine shut-off switch.
- (4) Grip the handlebars with both hands, place both feet on the floor of the footwell, start the engine, and then look in all directions before starting off.

EJU33110

## Boarding and starting from a dock

- (1) Board the watercraft from the side.
- (2) Attach the engine shut-off cord to your left wrist, and then attach the clip to the engine shut-off switch.
- (3) Push the watercraft away from the dock, grip the handlebars with both hands, place both feet on the floor of the footwell, start the engine, and then look in all directions before starting off.

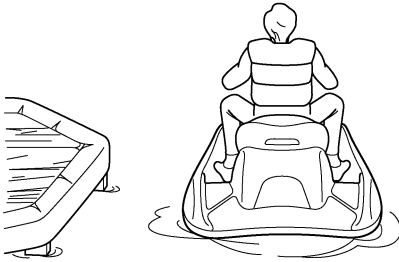

EJU36080

## Boarding and starting in deep water

EWJ01110

### **WARNING**

- The operator and passengers should practice boarding in shallow water before riding in deep water. Boarding in deep water requires more skill.
- The fatigue and exposure that could result after unsuccessful attempts to get back on the watercraft may increase the risk of injuries and drowning.

EJU36350

## Boarding alone

- (1) Swim to the rear of the watercraft and place both hands on the boarding platform, pull yourself up, and then grasp the handgrip with one hand.

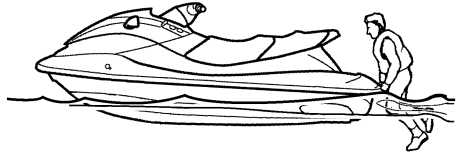

- (2) Pull yourself up to a kneeling position on the platform, and then move to the seat and sit astride.

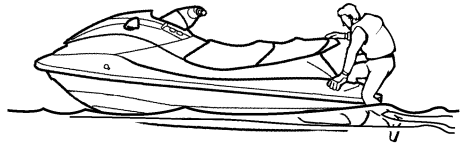

- (3) Attach the engine shut-off cord to your left wrist, and then attach the clip to the engine shut-off switch.
- (4) Grip the handlebars with both hands, place both feet on the floor of the footwell,

start the engine, and then look in all directions before starting off.



## NOTE:

This watercraft is equipped with a reboarding step, which you can lower to make reboarding easier. The step returns automatically to the up position after you have boarded.

EWJ00610

## WARNING

Before starting off, make sure that there are no boats, swimmers, or obstacles around you.

EJU33162

## Boarding with passengers

EWJ00660

## WARNING

Severe internal injuries can occur if water is forced into body cavities as a result of being near the jet thrust nozzle. Do not apply throttle until the passengers are seated with their feet on the floor of the footwell and are securely holding on to the person in front of them or to the handgrip provided.

- (1) Climb on board as noted in the previous section, and sit astride the seat.

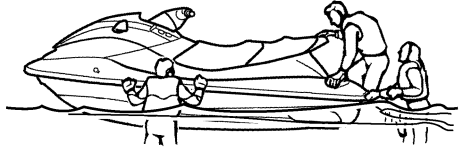

- (2) Attach the engine shut-off cord to your left wrist, and then attach the clip to the engine shut-off switch.
- (3) Have the passengers move to the rear of the watercraft.



- (4) Have a passenger board and sit astride the seat. If a second passenger is boarding, have him or her follow the same procedure.



# Operation

---

## NOTE:

When a passenger is boarding, both the passengers and the operator should try to balance the watercraft.

- (5) Check that the passengers have their feet on the floor of the footwell and are securely holding on to the person in front of them or to the handgrip provided. Never allow a passenger to ride in front of the operator.



- (6) Start the engine, look in all directions, and then accelerate to planing speed.

EWJ00610

## WARNING

**Before starting off, make sure that there are no boats, swimmers, or obstacles around you.**

## NOTE:

The heavier the total weight of the operator and passengers, the more difficult it will be to balance the watercraft. Do not operate the watercraft when the total weight exceeds 240 kg (530 lb) including any cargo. If it is difficult to balance the watercraft at a standstill, proceed as follows:

- (1) While the passengers are steadying the watercraft, pull yourself up onto the boarding platform into a kneeling posi-

tion, and then move to the seat and sit astride to balance the watercraft.

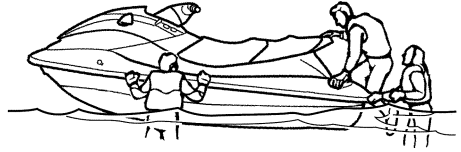

- (2) Have a passenger pull him or herself up onto the boarding platform into a kneeling position, then move to the seat and sit astride to balance the watercraft.
- (3) Attach the engine shut-off cord to your left wrist, and then attach the clip to the engine shut-off switch.
- (4) Start the engine and keep it at idle.
- (5) Have the second passenger pull him or herself up onto the boarding platform into a kneeling position, then crawl onto the seat as the watercraft accelerates.



- (6) Gradually increase the speed to balance the watercraft.



ride plate while pushing down on the gunwale with your right hand or foot.



EJU33230

## Capsized watercraft

If the watercraft capsizes, turn it over immediately.

Be sure to carefully follow the procedures below to prevent injury, or damage to the watercraft.

EWJ00670

### **WARNING**

**IMPROPER UPRIGHTING CAN CAUSE INJURY:**

- Be sure to shut the engine off by pulling on the engine shut-off cord to remove the clip from the engine shut-off switch.
- Do not put your hands in the intake grate.

ECJ00530

### **CAUTION:**

If the watercraft capsizes, release the throttle lever immediately. Oil could flow into the air filter case and the engine could be damaged.

- (1) Remove the clip from the engine shut-off switch.
- (2) Swim to the rear of the watercraft. Pull the watercraft over with your left hand on the

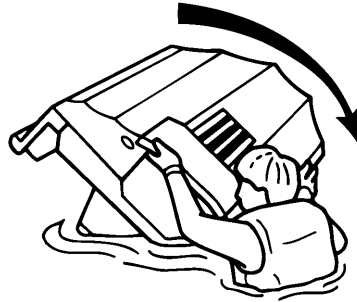

### **NOTE:**

If the port (left) side of the capsized watercraft is tilting up, push down on the gunwale so that the port (left) side is down before turning the watercraft clockwise.

ECJ00540

### **CAUTION:**

**Do not turn the watercraft over counter-clockwise, otherwise water can enter the engine, which can result in severe damage.**

- (3) Start the engine and operate the watercraft to discharge any water remaining in the engine compartment. (If the engine does not start, see "Towing the watercraft" on page 109 or "Submerged watercraft" on page 109.)

# Operation

ECJ00550

## CAUTION:

Do not operate the engine at full throttle for at least 1 minute after the engine has been restarted. Excessive water in the bilge can splash into the engine, which can result in severe damage.

## NOTE:

To efficiently discharge water from the engine compartment, operate the watercraft as straight as possible and above planing speed for at least 2 minutes.

EJU33250

## Turning the watercraft

Steering control depends on the combination of handlebar position and the amount of throttle.

Water sucked in through the intake grate is pressurized by the impeller in the jet pump. As the pressurized water is expelled from the pump through the jet thrust nozzle, it creates thrust to move and steer the watercraft. The higher the engine speed, the more thrust produced.

The amount of jet thrust, in addition to the position of the handlebars, determines how sharply you turn.

A. More throttle produces higher thrust, so the watercraft will turn more sharply.

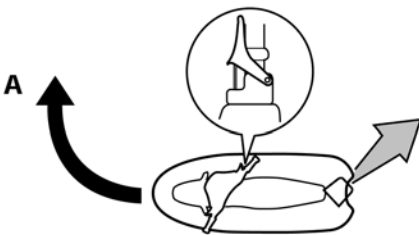

B. Less throttle produces lower thrust, so the watercraft will turn more gradually.

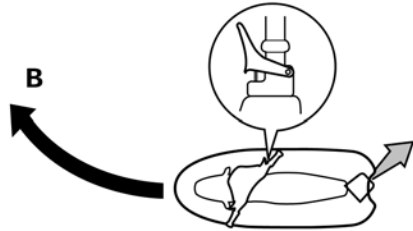

C. Releasing the throttle lever completely produces only minimum thrust. If you are traveling at speeds above trolling, you will have rapidly decreasing ability to steer without throttle. You may still have some turning ability immediately after releasing the throttle lever, but once the engine slows down, the watercraft will no longer respond to handlebar input until you apply throttle again or you reach trolling speed.

At trolling speed, the watercraft can be turned gradually by handlebar position alone using just the amount of thrust available at idle.

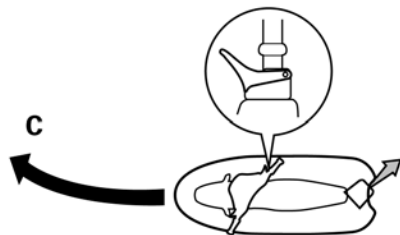

- D. If the engine is stopped while riding, there is no thrust. The watercraft will go straight even though the handlebars are turned.

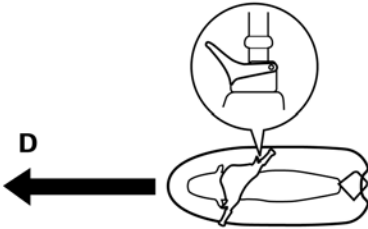

**You need throttle to steer.**

EWJ00770

### **WARNING**

- **Do not release the throttle lever when trying to steer away from objects—you need throttle to steer. A collision could result in severe injury or death.**
- **When operating at higher speeds, make gradual turns or slow down before turning. Sharp high-speed turns may cause the watercraft to slide sideways or spin, throwing the operator and passengers overboard, which could cause an injury.**

This model is equipped with the Yamaha Engine Management System (YEMS) that includes an off-throttle steering (OTS) system. It will activate at planing speeds should you attempt to steer the watercraft after releasing the throttle lever (see condition C above).

The OTS system assists in turning by continuing to supply some thrust while the watercraft is decelerating, but you can turn more sharply if you apply throttle while turning the handlebars. The OTS system does not function below planing speeds or when the engine is off. Once the engine slows down, the watercraft will no longer turn in response to handlebar in-

put until you apply throttle again or you reach trolling speed.

EJU33290

### **Stopping the watercraft**

The watercraft is not equipped with a separate braking system. It is stopped by water resistance when the throttle lever is released. From full speed, the watercraft comes to a complete stop in approximately 100 m (330 ft) after the throttle lever is released or the engine is stopped, although this distance will vary depending on many factors, including gross weight, water surface conditions, and wind direction. The watercraft slows down as soon as the throttle lever is released, but will coast for a distance before fully stopping. If you are not sure you can stop in time before hitting an obstacle, apply throttle and turn in another direction.

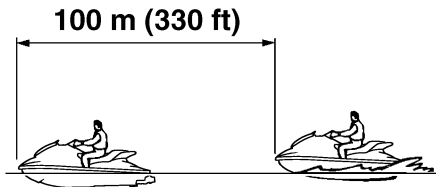

EWJ00740

### **WARNING**

- **Allow adequate stopping distance.**
- **Take early action to avoid collisions. Remember, watercraft and other boats do not have brakes.**
- **Operate defensively at safe speeds and keep a safe distance away from people, objects, and other watercraft to give you time to stop.**
- **Do not shut the engine off when slowing down in case you need engine power to**

# Operation

---

**steer away from a boat or other obstacle that comes into your path.**

- **Do not use the reverse function to slow down or stop the watercraft as it could cause you to lose control, be ejected, or impact the handlebars.**
- 

EJU35960

## Beaching the watercraft

- (1) Make sure that there are no boats, swimmers, or obstacles near the beach. Release the throttle lever about 100 m (330 ft) before you reach the intended beaching area.
- (2) Approach the beach slowly and stop the engine before reaching land. Remember, you need throttle to steer.
- (3) Get off the watercraft and pull it up on the beach.

ECJ00490

### **CAUTION:**

**Small pebbles, sand, seaweed, and other debris can be sucked into the jet intake and impair or damage the impeller. Always stop the engine and get off the watercraft before beaching it.**

---

EJU36060

## Docking the watercraft

- (1) Make sure that there are no boats, swimmers, or obstacles near the watercraft. Reduce speed about 100 m (330 ft) away from the dock.
- (2) Slowly approach the dock and stop the engine just before coming alongside it.

EJU36670

## Reverse on waterways

Reverse can be used for slow-speed maneuvering when it is necessary to back up out of tight spots where you cannot turn around. Reverse can be used to slow down or stop only during slow-speed maneuvering, such as when docking.

Once the engine is idling, shift into reverse and gradually increase engine speed. Make sure that there are no obstacles or people behind you before shifting into reverse.

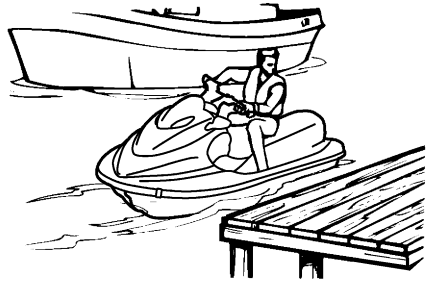

### **NOTE:**

This model is equipped with a function which limits the engine speed in reverse.

---

EJU33350

## Rough water operation

The force of landing after jumping can cause a strong impact on both the watercraft and the operator and passengers. It is possible for the operator to hit his or her chest or jaw on the watercraft or handlebars and be injured. The passengers could also impact the watercraft and be injured.

Do not operate the watercraft with your chin right above the handlebars. In addition, the operator and passengers should keep their feet on the floor of the footwell.

Operating in rough water or jumping waves can also crack the watercraft hull and deck, and damage internal parts. Avoid operating in rough water or bad weather conditions.



EJU37140

## Post-operation care

To keep your watercraft in top shape, always take it out of the water after using it and perform the following procedures. Leaving the watercraft in the water for extended periods will accelerate the rate of normal deterioration of the jet unit components and hull finish. Marine organisms and corrosion are some of the conditions that can adversely affect the life of many watercraft components.

- (1) Remove the watercraft from the water.
- (2) Wash down the hull, handlebars, and jet unit with fresh water.
- (3) Remove the seat and check the engine compartment for water. To drain excess water, remove the stern drain plugs, and then raise the bow of the watercraft enough to allow the water in the bilge to drain out.

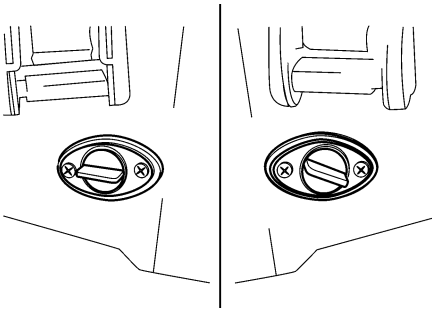

### NOTE:

This watercraft is equipped with a jet vacuum bilge draining system and an electric bilge draining system that remove water from the engine compartment while you are underway. However, some residual water will remain. (See page 65 for bilge draining procedures.)

- (4) Place the watercraft in a horizontal position.

- (5) Flush the cooling system to prevent it from clogging with salt, sand, or dirt. (See page 86 for flushing procedures.)
- (6) Drain residual water from the exhaust system by alternately squeezing and releasing the throttle lever for 10 to 15 seconds while the engine is running.

ECJ00561

### CAUTION:

**Do not run the engine for more than 15 seconds without supplying water, otherwise the engine could overheat.**

- (7) Rinse the engine and engine compartment with a small amount of water.

ECJ00570

### CAUTION:

**Do not use high-pressure water when rinsing the engine or engine compartment as severe engine damage could result.**

- (8) Wipe the engine and engine compartment dry with a clean cloth (repeat step 3, if necessary).
- (9) Wipe the hull, handlebars, and jet unit dry with a clean cloth.
- (10) Spray a rust inhibitor, such as Yamaha Silicone Protectant and Lubricant, on metallic parts to minimize corrosion.
- (11) Allow the engine compartment to air dry completely before installing the seat.

# Operation

---

EJU33461

## Transporting

When transporting the watercraft on a trailer, secure the tie downs to the trailer through the bow eye and stern eyes.

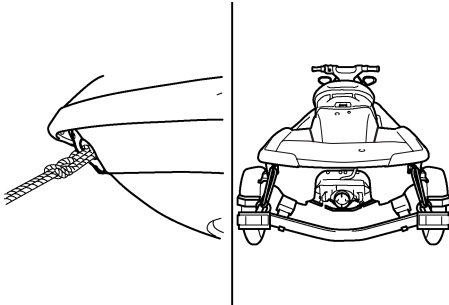

ECJ00641

### **CAUTION:**

- Do not attach ropes or tie downs to any part of the watercraft other than the bow eye and stern eyes to secure the watercraft to the trailer. Otherwise, the watercraft may be damaged.
  - Do not route ropes or tie downs over the seat, as they may leave permanent marks on the seat's surface. Also, wrap the ropes or tie downs with towels or rags where they touch the body of the watercraft to avoid scratches or damage.
  - Before putting the watercraft on the trailer or transporting it, be sure to put the shift lever in the forward position, otherwise the reverse gate may hit an obstacle, which may cause damage.
-

EJU33490

## Storage

EWJ00330

### **WARNING**

Always place the watercraft upright in a horizontal position when storing it, otherwise fuel could leak out into the engine or engine compartment, which could create a fire hazard.

Storage for long periods of time, such as winter storage, requires preventive maintenance to ensure against deterioration. It is advisable to have the watercraft serviced by a Yamaha dealer prior to storage. However, the following procedures can be performed by the owner.

EJU33532

### Flushing the cooling system

Flushing the cooling system is essential to prevent it from clogging with salt, sand, or dirt.

ECJ00121

### **CAUTION:**

- Do not supply water to the cooling water passages when the engine is not running. The water could flow back through the muffler into the crankcase, causing severe engine damage.
- Do not run the engine for more than 15 seconds without supplying water or over 4000 r/min on land, otherwise the engine could overheat.

- (1) Place the watercraft in a horizontal position.
- (2) Remove the rear seat and seat storage compartment. (See page 30 for seat removal and installation procedures.)
- (3) Remove the flushing hose connector cap, and then insert the garden hose

adapter into the flushing hose connector and turn it until it is securely connected.

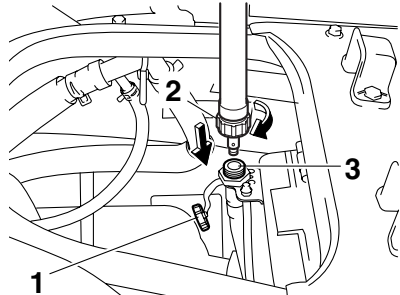

- 1 Flushing hose connector cap
- 2 Garden hose adapter
- 3 Flushing hose connector

- (4) Connect the garden hose adapter to a water tap using a garden hose.

### **NOTE:**

A garden hose is not included and must be purchased separately.

- (5) Start the engine, and then immediately turn the water supply on until water flows out continually from the jet thrust nozzle.

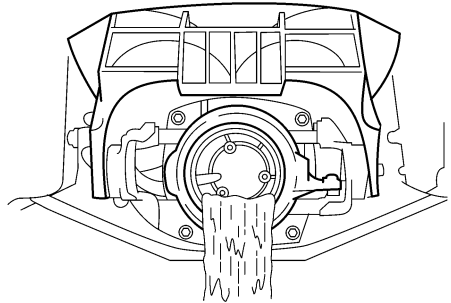

- (6) Run the engine at idling speed for about 3 minutes watching the engine condition. If the engine stops while flushing, turn the water supply off immediately and repeat the above steps.
- (7) Turn the water supply off, and then force the remaining water out of the cooling

# Maintenance and care

---

water passages by alternately squeezing and releasing the throttle lever for 10 to 15 seconds.

- (8) Stop the engine.
- (9) Remove the garden hose adapter and install the flushing hose connector cap.

EJU36901

## Lubrication

EWJ00260

### **WARNING**

**Do not spray flammable rust inhibitor products on engine surfaces while the engine is hot. The sprayed substance or propellants could catch fire.**

---

- (1) Lubricate all cables such as the throttle and steering cables.

### **NOTE:**

Use a Yamaha Power Cable Luber and Yamaha Lube-Zall to pressure-lubricate the cables and purge out any moisture between the inner and outer cables.

---

- (2) Lubricate the areas of the watercraft specified in "Lubrication points" on page 98.

EJU33661

## Fuel system

EWJ00281

### **WARNING**

**GASOLINE AND ITS VAPORS ARE HIGHLY FLAMMABLE AND EXPLOSIVE!**

- **Do not smoke when refueling, and keep away from sparks, flames, and other sources of ignition.**
- **Stop the engine before refueling.**
- **Refuel in a well-ventilated area with the watercraft in a horizontal position.**
- **Do not stand or sit on the watercraft while refueling.**
- **Take care not to spill gasoline. If gasoline spills, wipe it up immediately with**

**dry rags. Always properly dispose of gasoline-soaked rags.**

- **Avoid overfilling the fuel tank. Stop filling when the fuel level reaches approximately 50 mm (2 in) from the top of the fuel tank. Fuel expands as it warms up and could overflow if the fuel tank has been overfilled. If temporarily leaving the watercraft with a full fuel tank, do not leave it in direct sunlight. Leave it in a well-ventilated area with the watercraft in a horizontal position.**
  - **Tighten the fuel tank filler cap securely after refueling.**
  - **If you should swallow some gasoline, inhale a lot of gasoline vapor, or get gasoline in your eyes, get immediate medical attention.**
  - **If any gasoline spills on your skin or clothing, immediately wash the affected area with soap and water and change your clothes.**
- 

Top off the fuel tank with fresh gasoline and add one ounce of Yamaha Fuel Stabilizer and Conditioner per each gallon of fuel.

EJU33680

## Battery

If the watercraft will not be used for more than a month, remove the battery from the watercraft and store it in a cool, dry place.

- (1) Disconnect the negative (-) battery lead first, then the positive (+) battery lead and breather hose, and then remove the battery from the watercraft.
- (2) Clean the battery casing using fresh water.
- (3) If the battery terminals are dirty or corroded, clean them with a wire brush.
- (4) Fully charge the battery.
- (5) Apply Yamaha Marine Grease or Yamaha Grease A to the battery termi-

# Maintenance and care

nals, and then store the battery in a cool, dry place.

- (6) Check the battery at least once every 2 months and fully charge it if necessary.

ECJ00100

## **CAUTION:**

**Always keep the battery charged. Storing a discharged battery can cause permanent battery damage.**

To check the condition of the battery, check the specific gravity of the electrolyte or measure the voltage at both battery terminals. Charge the battery if the voltage is less than 12 volts.

Specific gravity (for reference):  
1.28 at 20 °C (68 °F)

It is recommended to have a Yamaha dealer check the specific gravity and charge the battery. If you maintain the battery yourself, be sure to read and follow the instructions provided with the battery tester and charger you use.

EJU33740

## **Cleaning the watercraft**

Clean the watercraft before storing it for a long period.

- (1) Wash down the hull, handlebars, and jet unit with fresh water.
- (2) Rinse the engine and bilge area with fresh water. Drain all of the water and wipe up any remaining moisture with clean, dry rags.

ECJ00110

## **CAUTION:**

**Do not use high-pressure water when rinsing the engine and bilge area as severe engine damage could result.**

- (3) Spray the engine's exterior with a rust inhibitor and lubricant such as Yamaha Silicone Protectant and Lubricant.

- (4) Wax the hull with a non-abrasive wax such as Yamaha Silicone Wax.
- (5) Wipe all vinyl and rubber components, such as the seat and engine compartment seals, with a vinyl protectant such as Yamaha Protectant.

# Maintenance and care

EJU33751

## Maintenance and adjustments

Periodic inspection, adjustment, and lubrication will keep your watercraft in the safest and most efficient condition possible. Safety is an obligation of the watercraft owner. Proper maintenance must be carried out to keep the exhaust emission and sound levels within the regulated limits. The most important points of watercraft inspection, adjustment, and lubrication are explained on the following pages.

See a Yamaha dealer for genuine Yamaha replacement parts and optional accessories designed for your watercraft.

Remember, failures that are the result of the installation of parts or accessories which are not qualitatively equivalent to genuine Yamaha parts are not covered by the limited warranty.

**Maintenance, replacement, or repair of the emission control devices and system may be performed by any marine SI engine repair establishment or individual. Warranty repair, however, must be performed at an authorized Yamaha marine dealership.**

EWJ00310

### **WARNING**

- Be sure to shut the engine off when you perform maintenance unless otherwise specified, otherwise an accident or injury could result from unexpected operation, moving parts, or electric shock. If the owner is not familiar with watercraft servicing, this work should be done by a Yamaha dealer. Improperly serviced components could fail or stop operating correctly, which could result in an accident.
- Modifications to this watercraft not approved by Yamaha may cause loss of performance or excessive noise and exhaust emissions, or render it unsafe for

**use. Consult a Yamaha dealer before attempting any modifications.**

### **NOTE:**

A service manual is available for purchase through a Yamaha dealer for owners who have the mechanical skills, tools, and other equipment necessary to perform maintenance not covered by this owner's/operator's manual.

EJU33800

## Owner's/operator's manual and tool kit

It is advisable to always carry the owner's/operator's manual and tool kit with you whenever you use the watercraft. For your convenience, a storage compartment is provided on the watercraft for the manual and tool kit.

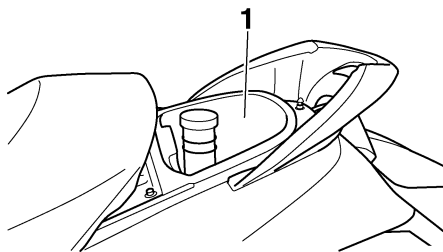

1 Storage compartment

### **NOTE:**

To protect these materials from water damage, it would be a good idea to put them in a waterproof bag. If your owner's/operator's manual is damaged, order a replacement from a Yamaha dealer.

The service information included in this manual is intended to provide you, the owner, with the necessary information for completing your own preventive maintenance and minor re-

# Maintenance and care

---

pairs. The tools provided in the tool kit are sufficient for this purpose, except that a torque wrench may also be necessary to tighten nuts and bolts.

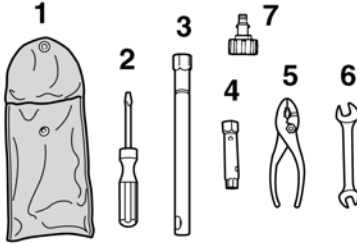

- 1 Tool bag
- 2 Screwdriver
- 3 16 mm box wrench
- 4 10/12 mm box wrench
- 5 Pliers
- 6 Open-end wrench
- 7 Garden hose adapter

# Maintenance and care

EJU37060

## Periodic maintenance chart

The following chart gives general guidelines for periodic maintenance. However, maintenance may need to be performed more frequently depending on your operating conditions.

This “●” mark indicates maintenance that you may do yourself.

This “○” mark indicates work to be done by a Yamaha dealer.

Item	Operation	Initial			Thereafter every		Page
		10 hours	50 hours	100 hours	100 hours	200 hours	
			6 months	12 months	12 months	24 months	
<b>Spark plugs</b>	Check, clean, adjust	●		●	●		96
<b>Lubrication points</b>	Lubricate			●/○	●/○		98
<b>Internal engine components</b>	Lubricate	○*2 50 hours or 12 months					—
<b>QSTS cables</b>	Lubricate			○	○		—
<b>Intermediate housing</b>	Lubricate	○		●	●		98
<b>Fuel system</b>	Check			○	○		93
<b>Fuel tank</b>	Check, clean			●/○	●/○		93
<b>Trolling speed</b>	Check, adjust			●/○	●/○		101
<b>Throttle shaft</b>	Check			○	○		—
<b>Cooling water passages</b>	Flush	●*1					86
<b>Water inlet strainer</b>	Check, clean			○	○		—
<b>Bilge strainer</b>	Clean			○	○		—
<b>Electric bilge pump strainer</b>	Check, clean			○	○		—
<b>Impeller</b>	Check			○	○		—
<b>Jet thrust nozzle angle</b>	Check, adjust			●/○	●/○		94
<b>Steering master</b>	Check	○		○	○		—
<b>QSTS mechanism</b>	Check, adjust	○		○	○		—
<b>Shift cable and reverse gate</b>	Check, adjust			●/○	●/○		94
<b>Throttle cable</b>	Check, adjust	○		●	●		95
<b>Stern drain plugs</b>	Check, replace			○	○		66



# Maintenance and care

Item	Operation	Initial			Thereafter every		Page
		10 hours	50 hours	100 hours	100 hours	200 hours	
			6 months	12 months	12 months	24 months	
<b>Battery</b>	Check, charge			●/○	●/○		99
<b>Rubber coupling</b>	Check					○	—
<b>Engine mount</b>	Check					○	—
<b>Nuts and bolts</b>	Check	○		○	○		—
<b>Air filter element</b>	Check			○	○		94
<b>Engine oil</b>	Replace	○	○ 50 hours or 12 months				93
<b>Oil filter</b>	Replace			○	○		93
<b>Valve clearance</b>	Check, adjust					○	—

\*1 This operation should be performed after every use.

\*2 This operation should be performed before long-term storage.

# Maintenance and care

---

EJU34210

## Checking the fuel system

EWJ00380

### **WARNING**

Gasoline is highly flammable and explosive. Failure to check for and repair any fuel leakage could result in a fire or explosion. A fire or explosion can cause severe injury or death. Shut the engine off. Do not smoke. Avoid spilling gasoline.

Fuel in the fuel lines is pressurized.

Fuel can spray out and cause injury or a fire hazard if a fuel line is disconnected.

Do not run the engine with a fuel line disconnected.

Check the fuel system for leaks, cracks, and malfunctions. If any problem is found, consult a Yamaha dealer.

#### **Check:**

- Fuel tank filler cap and seal for damage.
- Fuel in fuel tank for water and dirt.
- Fuel tank for damage, cracks, and leakage.
- Fuel hoses and joints for damage, cracks, and leakage.
- Air bleeding passages for leakage.

EJU34230

#### **Fuel tank**

Check the fuel tank for leakage and for water in the tank. If water is found in the fuel system, or if the fuel tank needs to be cleaned, have a Yamaha dealer service the watercraft.

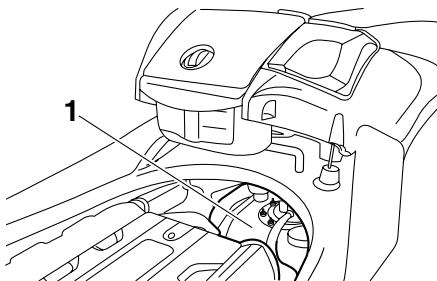

1 Fuel tank

EJU36940

## Engine oil and oil filter

EWJ00340

### **WARNING**

Engine oil is extremely hot immediately after the engine is turned off. Coming in contact with or getting any engine oil on your clothes could result in burns.

ECJ00990

### **CAUTION:**

- Do not run the engine with too much or not enough oil in the oil tank. Oil could spray out and the engine could be damaged.
- Be sure to change the engine oil after the first 10 hours of operation, and every 50 hours thereafter or at the start of a new season, otherwise the engine will wear quickly.

The oil filter should be replaced every year or every 100 hours of operation. Have a Yamaha dealer replace the oil filter if necessary.

It is recommended to have a Yamaha dealer change the engine oil. However, if you choose to change the oil on your own, refer to the service manual for this watercraft.

### **NOTE:**

Dispose of used oil according to local regulations.

# Maintenance and care

Recommended engine oil:  
SAE 10W-30, 10W-40, 20W-40, 20W-50  
Oil grade:  
API SE, SF, SG, SH, SJ, SL  
Oil quantity:  
With oil filter replacement:  
3.1 L (3.28 US qt) (2.73 Imp. qt)  
Without oil filter replacement:  
3.0 L (3.17 US qt) (2.64 Imp. qt)  
Total amount:  
4.3 L (4.55 US qt) (3.78 Imp. qt)

ECJ00190

## CAUTION:

If oil is leaking or the oil pressure warning indicator comes on when the engine is running, immediately shut the engine off and have a Yamaha dealer check the watercraft. Continuing to operate the engine under such conditions could cause severe engine damage.

EJU34310

## Air filter element

Have a Yamaha dealer check and clean or replace the air filter element every 12 months or every 100 hours of operation.

EJU34321

## Checking the jet thrust nozzle angle

Check the handlebars and jet thrust nozzle for smooth operation.

Turn the handlebars as far as possible to the right and left and check that the difference of distances A and B between the jet thrust nozzle and the nozzle is within specification.

Difference of A and B:  
Maximum 5 mm (0.20 in)

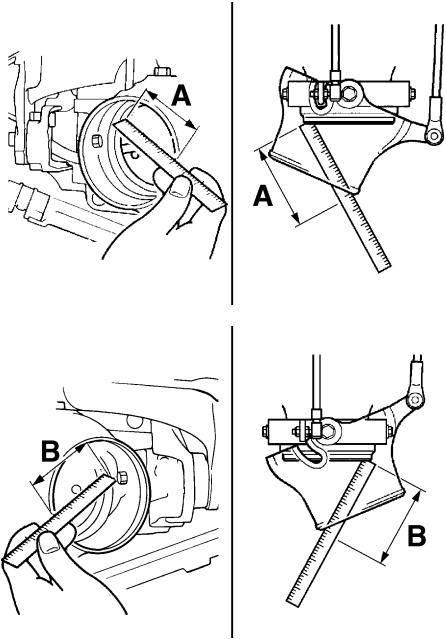

If the steering is stiff or misadjusted, have a Yamaha dealer service it.

EJU36590

## Checking the shift cable

Place the shift lever in the reverse position. Make sure that the reverse gate makes contact with the stopper.

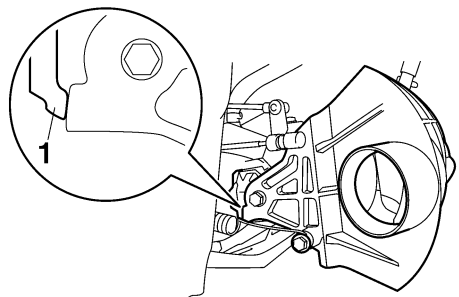

1 Stopper

# Maintenance and care

If the reverse gate does not make contact with the stopper, have a Yamaha dealer service it.

EJU37030

## Checking and adjusting the throttle cable

Face the handlebars straight ahead, and then check that the throttle cable moves back to the set position smoothly and that the throttle lever free play is within specification.

Squeeze and release the throttle lever. If the throttle lever does not return smoothly, have a Yamaha dealer service it.

If the specified throttle lever free play cannot be obtained as described below, have a Yamaha dealer make the adjustment.

### FX SHO

- (1) Remove the eight screws, and then remove the front handlebar cover.

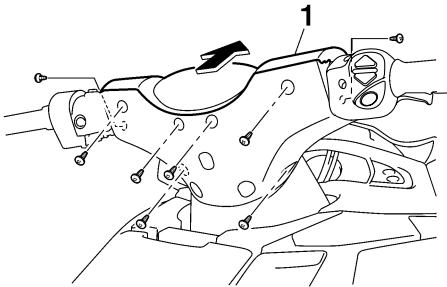

1 Front handlebar cover

- (2) Slide the rubber cover away from the adjuster, and then loosen the locknut.

- (3) Make sure that the handlebars are facing straight ahead, and then adjust the free play by turning the adjuster.

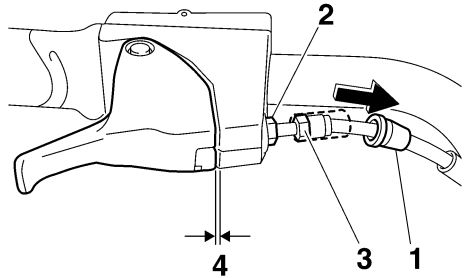

- 1 Rubber cover
- 2 Locknut
- 3 Adjuster
- 4 Throttle lever free play

Throttle lever free play:  
2.0–5.0 mm (0.08–0.20 in)

- (4) Hold the adjuster with one wrench while tightening the locknut with another wrench. Slide the rubber cover to its original position.
- (5) Install the front handlebar cover, and then install the eight screws.

### FX Cruiser SHO

- (1) Remove the ten screws, and then remove the front and rear handlebar covers.

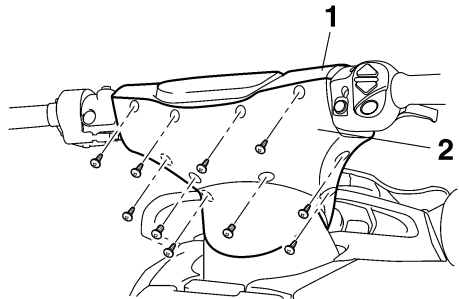

- 1 Front handlebar cover
- 2 Rear handlebar cover

# Maintenance and care

- (2) Slide the rubber cover away from the adjuster, and then loosen the locknut.
- (3) Make sure that the handlebars are facing straight ahead, and then adjust the free play by turning the adjuster.
- (5) Install the front and rear handlebar covers as shown in the illustration, and then install the ten screws.

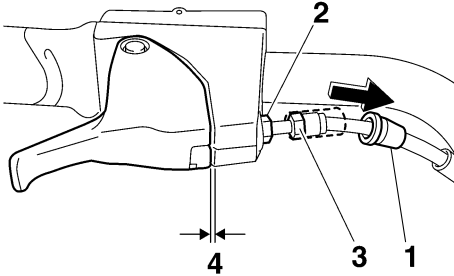

- 1 Rubber cover
- 2 Locknut
- 3 Adjuster
- 4 Throttle lever free play

Throttle lever free play:  
2.0–5.0 mm (0.08–0.20 in)

- (4) Hold the adjuster with one wrench while tightening the locknut with another wrench. Slide the rubber cover to its original position.

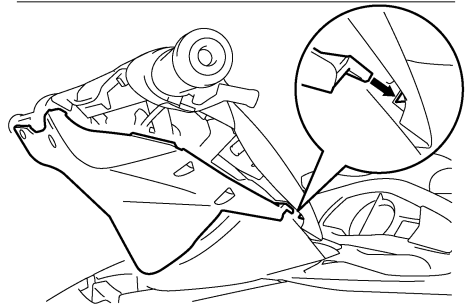
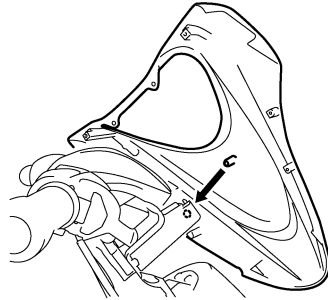

EJUS37040

## Cleaning and adjusting the spark plugs

The spark plug is an important engine component and is easy to inspect. The condition of the spark plug can indicate something about the condition of the engine. For example, if one spark plug has a distinctly different color, the engine could require servicing. Do not attempt to diagnose any problems yourself. Have a Yamaha dealer service the watercraft. Remove and inspect the spark plugs periodically; heat and deposits will cause the spark plugs to slowly break down and erode. If electrode erosion becomes excessive, or if carbon and other deposits are excessive, replace the spark plug with the specified plug.

Specified spark plug:  
LFR6A

# Maintenance and care

## To remove a spark plug:

- (1) Remove the seats. (See page 30 for seat removal and installation procedures.)
- (2) Remove the engine cover screws, and then remove the engine cover.

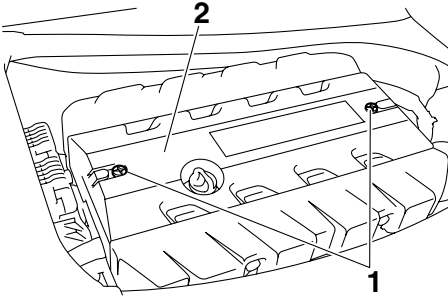

- 1 Engine cover screw
- 2 Engine cover

- (3) Remove the spark plug cap bolts, and then remove the spark plug cap.

## NOTE:

If removing the spark plug cap nearest the stern, remove the plastic tie that is securing the wiring harness before removing the cap.

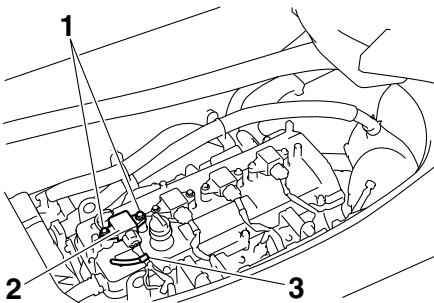

- 1 Spark plug cap bolt
- 2 Spark plug cap
- 3 Plastic tie

ECJ00210

## CAUTION:

**Do not use any tools to remove or install the spark plug cap, otherwise the ignition**

**coil coupler could be damaged. The spark plug cap may be difficult to remove because the rubber seal on the end of the cap fits tightly. To remove the spark plug cap, simply twist it back and forth while pulling it up; to install it, twist it back and forth while pushing it down.**

- (4) Remove the spark plug.  
Measure the spark plug gap with a wire thickness gauge. Replace the spark plug or adjust the gap to specification if necessary.

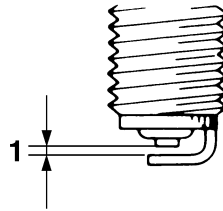

- 1 Spark plug gap

Spark plug gap:  
0.8–0.9 mm (0.031–0.035 in)

## To install a spark plug:

- (1) Clean the gasket surface.
- (2) Wipe any dirt from the threads of the spark plug.
- (3) Install the spark plug, and then tighten it to the specified torque.

Spark plug tightening torque:  
24.5 Nm (18.1 ft-lb) (2.50 kgf-m)

## NOTE:

If a torque wrench is not available when you are installing a spark plug, a good estimate of the correct torque is 1/4 turn to 1/2 turn past finger tight using the spark plug wrench in-

# Maintenance and care

cluded in the tool kit. Have the spark plug adjusted to the correct torque with a torque wrench as soon as possible.

- (4) Install the spark plug cap, and then install the spark plug cap bolts and tighten them to the specified torque.

## NOTE:

- Wipe off any water on the spark plug or inside the spark plug cap before installing the cap. Push the spark plug cap down until it is securely installed.
- If the spark plug cap nearest the stern was removed, secure the wiring harness by installing the plastic tie after installing the cap.

Spark plug cap bolt tightening torque:  
7.6 Nm (5.6 ft-lb) (0.77 kgf-m)

EWJ00350

## WARNING

**Be careful not to damage the insulator when removing or installing a spark plug. A damaged insulator could allow sparks to escape, which could result in a fire or explosion.**

- (5) Install the engine cover and engine cover screws, and then install the seats.

EJU36970

## Lubrication points

To keep moving parts sliding or rotating smoothly, coat them with water-resistant grease.

Recommended water-resistant grease:  
Yamaha Marine Grease/Yamaha Grease A

- Throttle cable (handlebar end)  
Loosen the adjuster and disconnect the outer cable from the bracket. Spray a rust inhibitor into the outer cable. Connect the outer cable, and then adjust the throttle ca-

ble free play. (See page 95 for adjustment procedures.)

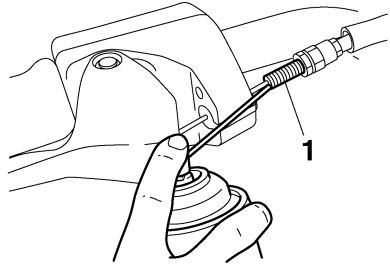

1 Adjuster

- Steering cable (handlebar end)

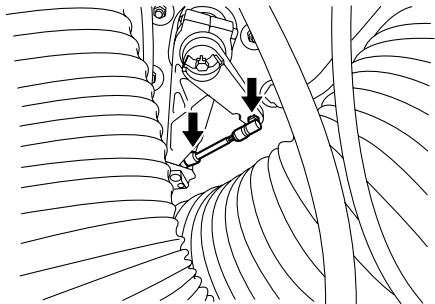

- Steering cable (jet thrust nozzle end)
- QSTS rod (jet thrust nozzle end)

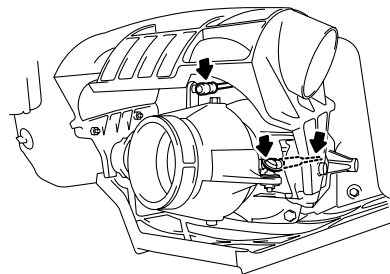

# Maintenance and care

- Shift cable (shift lever end)

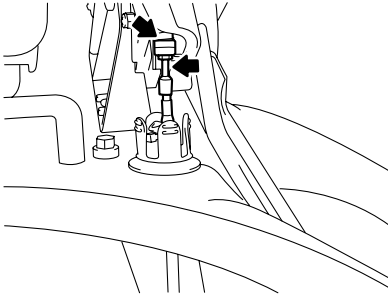

- Shift cable (reverse gate end)

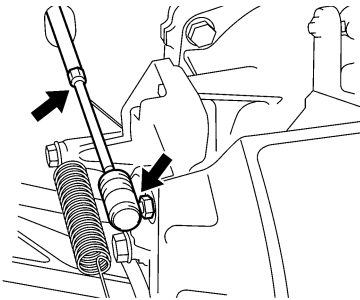

- Intermediate housing

Fill the intermediate housing with water-resistant grease through the grease nipple using a grease gun.

## Grease quantity:

Initial 10 hours or 1 month:

33.0–35.0 cm<sup>3</sup> (1.12–1.18 US oz)  
(1.16–1.23 Imp.oz)

Every 100 hours or 12 months:

6.0–8.0 cm<sup>3</sup> (0.20–0.27 US oz)  
(0.21–0.28 Imp.oz)

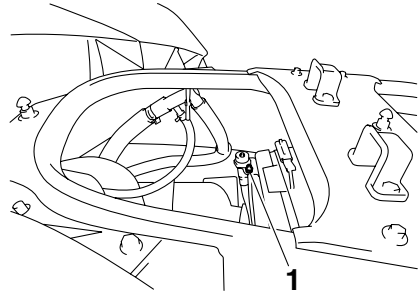

1 Grease nipple

EJU34451

## Checking the battery

Check the level of the battery electrolyte and make sure that the negative (–) and positive (+) battery leads are tightened securely.

EWJ00790

## WARNING

**Battery electrolyte is poisonous and dangerous, causing severe burns, etc. Electrolyte contains sulfuric acid. Avoid contact with skin, eyes, or clothing.**

### Antidotes

**External:** Flush with water.

**Internal:** Drink large quantities of water or milk. Follow with milk of magnesia, beaten egg, or vegetable oil. Call a physician immediately.

**Eyes:** Flush with water for 15 minutes and get prompt medical attention.

**Batteries produce explosive gases. Keep sparks, flames, cigarettes, etc., well away. If using or charging the battery in an enclosed space, make sure that it is well ven-**



# Maintenance and care

tilated. Always shield your eyes when working near batteries.

**KEEP OUT OF THE REACH OF CHILDREN.**

ECJ00230

## CAUTION:

- Be careful not to place the battery on its side.
- Be sure to remove the battery from the battery compartment when adding electrolyte or charging the battery.

### To remove the battery:

Disconnect the negative (-) battery lead first, then the positive (+) battery lead and breather hose, and then remove the battery from the watercraft.

### To replenish the battery:

- (1) Make sure that the electrolyte level is between the maximum and minimum level marks.

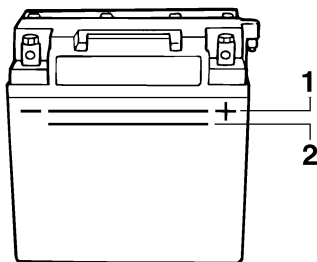

- 1 Maximum level mark
- 2 Minimum level mark

- (2) If the electrolyte level is low, add distilled water to raise it to the specified level.

ECJ00240

## CAUTION:

Normal tap water contains minerals that are harmful to a battery. Use only distilled water for replenishing the battery.

To recharge the battery:

ECJ00250

## CAUTION:

**Do not attempt to charge a battery hastily. Battery life could be shortened.**

It is recommended to have a Yamaha dealer charge the battery. If you charge the battery yourself, be sure to read and follow the instructions provided with the battery tester and charger you use.

### To install the battery:

- (1) Place the battery in the battery compartment and connect the battery leads to the battery terminals.
- (2) Connect the breather hose to the battery.
- (3) Secure the battery in place.

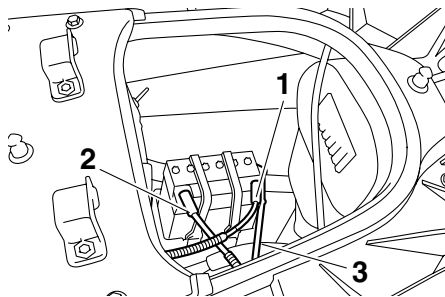

- 1 Positive (+) battery terminal: Red lead
- 2 Negative (-) battery terminal: Black lead
- 3 Breather hose

EWJ00400

## WARNING

**Be sure to connect the breather hose to the battery. Fire or explosion could result if the breather hose is damaged, obstructed, or not connected properly.**

ECJ00260

## CAUTION:

After installation, make sure that the battery leads are properly connected to the battery terminals.

# Maintenance and care

---

EJU34490

## Fuel injection system

The fuel injection system was set at the Yamaha factory. If the fuel injection system needs to be adjusted, have a Yamaha dealer service the watercraft.

ECJ00220

### **CAUTION:**

**Do not attempt to adjust the fuel injection system. If the settings are disturbed by someone who does not have the necessary technical knowledge, poor engine performance and damage may result.**

---

EJU34500

## Checking the trolling speed

- (1) Place the watercraft in the water.
- (2) Start the engine and warm it up. Use the tachometer in the multifunction information center to check the trolling speed.

Trolling speed: 1250 $\pm$ 100 r/min
---

If the trolling speed is out of specification, have a Yamaha dealer service the watercraft.

EJU34542

## Specifications

### Watercraft capacity:

Maximum people on board:

3 person

Maximum load capacity:

240 kg (530 lb)

### Dimensions:

Length:

3370 mm (132.7 in)

Width:

1230 mm (48.4 in)

Height:

FX SHO 1160 mm (45.7 in)

FX Cruiser SHO 1240 mm (48.8 in)

Dry weight:

FX SHO 376 kg (829 lb)

FX Cruiser SHO 381 kg (840 lb)

### Performance:

Maximum fuel consumption:

71.3 L/h (18.8 US gal/h) (15.7 Imp.gal/h)

Cruising range at full throttle:

0.98 hour

Trolling speed:

1250 ±100 r/min

### Engine:

Engine type:

Liquid cooled 4-stroke, DOHC

Number of cylinders:

4

Engine displacement:

1812 cm<sup>3</sup>

Bore & stroke:

86.0 × 78.0 mm (3.39 × 3.07 in)

Compression ratio:

8.6 : 1

Valve clearance-intake (cold):

0.14–0.23 mm (0.0055–0.0091 in)

Valve clearance-exhaust (cold):

0.28–0.37 mm (0.0110–0.0146 in)

Lubrication system:

Wet sump

Cooling system:

Water

Starting system:

Electric

Ignition system:

T.C.I.

Spark plug:

LFR6A

Spark plug gap:

0.8–0.9 mm (0.031–0.035 in)

Battery capacity:

12 V, 19.0 Ah

Charging system:

Flywheel magnet

### Drive unit:

Propulsion system:

Jet pump

Jet pump type:

Axial flow, single stage

Impeller rotation:

Counterclockwise

Jet thrust nozzle angle:

24.0+24.0 °

Jet thrust nozzle trim angle:

-10, -5, 0, 5, 10 °

### Fuel and oil:

Recommended fuel:

Regular unleaded gasoline

Minimum octane rating (PON):

86

Minimum octane rating (RON):

90

Recommended engine oil type SAE:

SAE 10W-30, 10W-40, 20W-40, 20W-50

Recommended engine oil grade API:

API SE,SF,SG,SH,SJ,SL

Fuel tank total capacity:

70 L (18.5 US gal) (15.4 Imp.gal)

Engine oil quantity with oil filter replacement:

3.1 L (3.28 US qt) (2.73 Imp.qt)

Engine oil quantity without oil filter replacement:

3.0 L (3.17 US qt) (2.64 Imp.qt)

Engine oil total quantity:

4.3 L (4.55 US qt) (3.78 Imp.qt)

# Trouble recovery

EJU34560

## Troubleshooting

If you have any trouble with your watercraft, use this section to check for the possible cause. If you cannot find the cause, or if the procedure for replacement or repair is not described in this owner's/operator's manual, have a Yamaha dealer perform the necessary service.

EJU36981

### Troubleshooting chart

TROUBLE	POSSIBLE CAUSE		REMEDY	PAGE
<b>Engine does not start (Starter motor does not turn over)</b>	Yamaha Security System	Lock mode selected	Select unlock mode	41
	Engine shut-off switch	Clip not in place	Install clip	33
	Fuse	Burned out	Replace fuse and check wiring	108
	Battery	Run down	Recharge	99
		Poor terminal connections	Tighten as required	99
		Terminal corroded	Clean	87
	Starter motor	Faulty	Have serviced by Yamaha dealer	—
<b>Engine does not start (Starter motor turns over)</b>	Throttle lever	Squeezed	Release	34
	Fuel	Empty	Refill as soon as possible	60
		Stale or contaminated	Have serviced by Yamaha dealer	93
	Fuel tank	Water or dirt present	Have serviced by Yamaha dealer	93
	Spark plug	Fouled or defective	Clean or replace	96
	Spark plug cap	Not connected or loose	Connect properly	96
		Connected to wrong cylinder	Connect properly	96
Fuel injection system	Fuel pump faulty	Have serviced by Yamaha dealer	—	

# Trouble recovery

TROUBLE	POSSIBLE CAUSE		REMEDY	PAGE
<b>Engine runs irregularly or stalls</b>	Fuel	Empty	Refill as soon as possible	60
		Stale or contaminated	Have serviced by Yamaha dealer	93
	Fuel tank	Water or dirt present	Have serviced by Yamaha dealer	93
	Spark plug	Fouled or defective	Replace	96
		Incorrect heat range	Replace	96
		Gap incorrect	Adjust	96
	Spark plug cap	Loose	Connect properly	96
		Cracked, torn, or damaged	Have serviced by Yamaha dealer	—
	Electrical wiring	Loose connection	Have serviced by Yamaha dealer	—
Fuel injection system	Faulty or clogged injectors	Have serviced by Yamaha dealer	—	
<b>Warning light or indicator blinks</b>	Fuel level	Empty	Refill as soon as possible	60
	Oil pressure warning	Oil pressure dropped	Have serviced by Yamaha dealer	51
	Engine overheated	Jet intake clogged	Clean	106
	Check engine warning	Faulty sensors	Have serviced by Yamaha dealer	52

# Trouble recovery

TROUBLE	POSSIBLE CAUSE		REMEDY	PAGE
<b>Watercraft slow or loses power</b>	Shift lever	Not completely shifted into forward position	Push lever forward until it stops	36
	Yamaha Security System	Low-RPM mode selected	Select normal mode	42
	Cavitation	Jet intake clogged	Clean	106
		Impeller damaged or worn	Have serviced by Yamaha dealer	106
	Engine over-heat warning	Engine speed reduction control activated	Clean jet intake and cool engine	51
	Oil pressure warning	Engine speed reduction control activated	Add oil	51
	Spark plug	Fouled or defective	Replace	96
		Incorrect heat range	Replace	96
		Gap incorrect	Adjust	96
	Spark plug cap	Loose	Connect properly	96
	Electrical wiring	Loose connection	Have serviced by Yamaha dealer	—
	Fuel	Stale or contaminated	Have serviced by Yamaha dealer	93
	Air filter	Clogged	Have serviced by Yamaha dealer	94
Oil buildup		Have serviced by Yamaha dealer	94	

EJU34620

## Emergency procedures

EJU34630

### Cleaning the jet intake and impeller

If weeds or debris get caught in the jet intake or impeller, cavitation can occur, causing jet thrust to decrease even though engine speed rises. If this condition is allowed to continue, the engine will overheat and may seize. If there is any sign that the jet intake or impeller is clogged with weeds or debris, return to shore and check the intake and impeller. Always stop the engine before beaching the watercraft.

EWJ00780

### **WARNING**

Before attempting to remove weeds or debris from the jet intake or impeller area, shut the engine off and remove the clip from the engine shut-off switch. Severe injury or death could result from coming in

contact with the rotating parts of the jet pump.

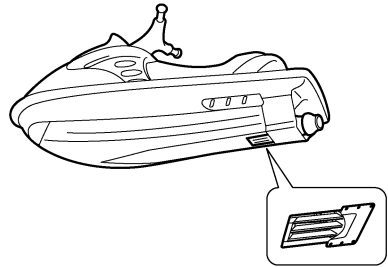
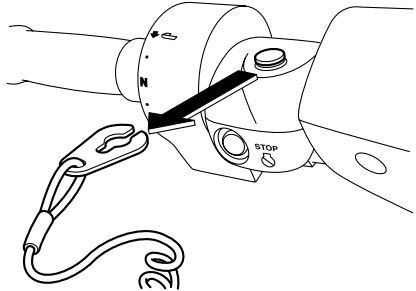

ECJ00650

### **CAUTION:**

If weeds or debris get caught in the jet intake, do not operate the watercraft above trolling speed until they have been removed.

- (1) Turn the watercraft on its side as shown.

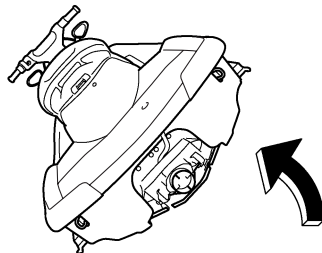

# Trouble recovery

ECJ00660

## CAUTION:

- Place a suitable clean cloth or carpeting underneath the watercraft to protect it from abrasions and scratches.
- Always turn the watercraft over onto its port (left) side.
- When turning the watercraft on its side, support the bow so that the handlebars are not bent or damaged.

(2) Remove any weeds or debris from around the drive shaft, impeller, jet pump housing, and jet thrust nozzle.

If debris is difficult to remove, consult a Yamaha dealer.

ECJ00670

## CAUTION:

Always avoid operating your watercraft in areas where weed growth is thick. If traveling in weeded areas is unavoidable, operate the engine alternately at partial throttle and full throttle. Weeds tend to accumulate more at a steady speed and at trolling speed. If weeds clog the jet intake or impeller area and cause cavitation, follow the cleaning procedure above.

EJU34640

## Jumping the battery

If the watercraft battery has run down, the engine can be started using a 12-volt booster battery and jumper cables.

EWJ00790

## WARNING

Battery electrolyte is poisonous and dangerous, causing severe burns, etc. Electrolyte contains sulfuric acid. Avoid contact with skin, eyes, or clothing.

Antidotes

External: Flush with water.

Internal: Drink large quantities of water or milk. Follow with milk of magnesia, beaten

egg, or vegetable oil. Call a physician immediately.

Eyes: Flush with water for 15 minutes and get prompt medical attention.

Batteries produce explosive gases. Keep sparks, flames, cigarettes, etc., well away. If using or charging the battery in an enclosed space, make sure that it is well ventilated. Always shield your eyes when working near batteries.

**KEEP OUT OF THE REACH OF CHILDREN.**

EJU34661

## Connecting the jumper cables

- (1) Connect the positive (+) jumper cable to the positive (+) battery terminals of both batteries.
- (2) Connect one end of the negative (-) jumper cable to the negative (-) battery terminal of the booster battery.
- (3) Connect the other end of the negative (-) jumper cable to an engine hanger.

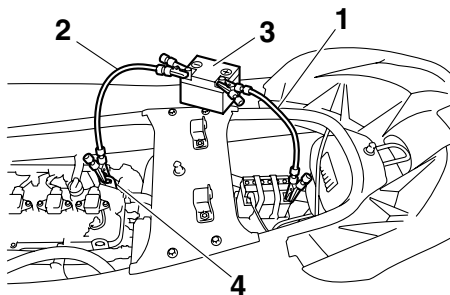

- 1 Positive (+) jumper cable
- 2 Negative (-) jumper cable
- 3 Booster battery
- 4 Engine hanger

ECJ00680

## CAUTION:

Do not connect the end of the negative (-) jumper cable to the negative (-) battery terminal of the watercraft battery! Make sure that all connections are secure and



# Trouble recovery

**correct before attempting to start the engine. Any wrong connection could damage the electrical system.**

- (4) Start the engine, and then disconnect the jumper cables by reversing the steps above.

ECJ00480

## CAUTION:

- Never push the start switch while the engine is running.
- Do not operate the start switch for more than 5 seconds, otherwise the battery will be discharged and the engine will not start. Also, the starter motor could be damaged. If the engine does not start in 5 seconds, release the start switch, wait 15 seconds, and then try again.

- (4) Replace the blown fuse with the spare fuse of the correct amperage by using the fuse puller on the reverse side of the cap.

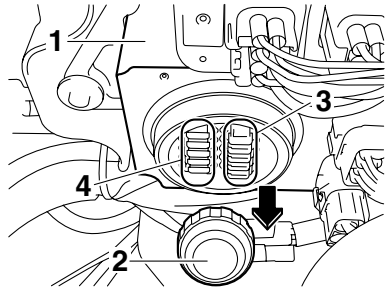

- 1 Electrical box
- 2 Cap
- 3 Fuse
- 4 Spare fuse

EJU36990

## Replacing the fuses

The fuses are located in the electrical box.

### To replace a fuse:

- (1) Remove the seats. (See page 30 for seat removal and installation procedures.)
- (2) Remove the electrical box cover.

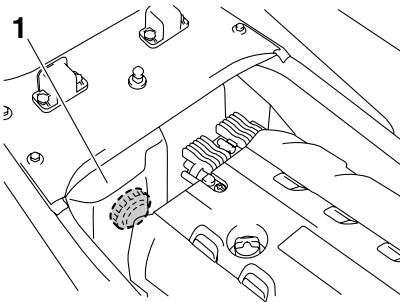

- 1 Electrical box cover

- (3) Remove the cap on the electrical box.

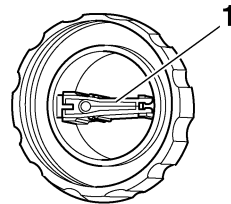

- 1 Fuse puller

### Fuse amperage:

Battery fuse:

30 A

Main relay drive fuse:

10 A

Electronic throttle valve fuse:

10 A

Security system fuse:

3 A

Main fuse:

20 A

# Trouble recovery

---

EWJ00800

## **WARNING**

Do not use fuses of higher amperage than recommended. Substitution with a fuse that has an improper rating can cause extensive electrical system damage and possible fire.

---

- (5) Install the cap.
- (6) Install the electrical box cover.
- (7) Install the seats.

EJU34710

## **Towing the watercraft**

If the watercraft becomes inoperative in the water, it can be towed to shore.

If the watercraft must be towed in an emergency using a towline, the operator should ride the watercraft, holding onto the handlebars.

ECJ00720

## **CAUTION:**

- **Tow the watercraft at 5 mph (8 km/h) or less, otherwise water could enter the engine through the exhaust passages or through the air intake and flood the engine compartment if it is towed too fast.**
  - **Tow the watercraft using the bow eye only.**
  - **The bow must be kept up out of the water during towing to prevent water from entering the engine compartment.**
- 

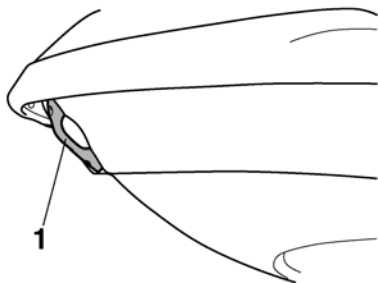

1 Bow eye

EWJ00810

## **WARNING**

- **The watercraft should only be towed in an emergency.**
  - **The towline should be long enough so that the watercraft will not collide with the towing boat when slowing down. A good rule of thumb is a towline that is three times the combined length of the towing boat and the watercraft.**
  - **The operator of the towing boat must keep speed to a minimum and avoid traffic or obstacles which could be a hazard to the rider on the watercraft.**
- 

EJU37000

## **Submerged watercraft**

If the watercraft is submerged or flooded with water, follow the procedure below and consult a Yamaha dealer as soon as possible. Failure to do so could result in serious engine damage!

In an emergency:

- (1) Beach the watercraft and remove the stern drain plugs to drain the water from the engine compartment. (See page 65 for more information.)  
Remove the storage compartment drain plugs to drain the water from each storage compartment.
- (2) Install the stern drain plugs.
- (3) Have the watercraft inspected by a Yamaha dealer as soon as possible.

ECJ00790

## **CAUTION:**

**Be sure to have a Yamaha dealer inspect the watercraft. Otherwise, serious engine damage could result.**

---

## Limited warranty

### YAMAHA MOTOR CORPORATION, U.S.A. WATERCRAFT LIMITED WARRANTY

Yamaha Motor Corporation is proud of its heritage and reputation for producing products with high standards of quality and workmanship. Product excellence provides the cornerstone for our commitment to customer satisfaction. The Yamaha Watercraft Limited Warranty is your assurance of this commitment.

This warranty provides you with protection against the expense of repairs for your watercraft that are required as a result of defects in materials or workmanship. When maintained and utilized in the prescribed manner, you can count on your Yamaha watercraft to provide reliable service.

This warranty provides you with specific coverage and notes your responsibilities in maintaining and operating your watercraft. Please take the time to read and become familiar with this warranty.

**PERIOD OF WARRANTY.** Any new Yamaha watercraft purchased for pleasure use from an authorized Yamaha dealer in the United States, will be warranted against defects in material or workmanship for a period of one (1) year from date of purchase, subject to exclusions noted herein. Any Yamaha Watercraft purchased and utilized for commercial applications will be warranted for a period of ninety [90] days from the date of purchase, subject to exclusions noted herein. Replacement parts used in warranty repairs will be warranted for the balance of the applicable warranty period.

The warranty described here applies to watercrafts purchased and registered for use in the United States only. For warranty provisions outside the United States, contact the particular country's local Yamaha distributor.

**OBTAINING REPAIRS UNDER WARRANTY.** During the period of warranty, any authorized Yamaha dealer will, free of charge, repair or replace, at Yamaha's option, any parts adjudged defective by Yamaha due to faulty workmanship or material from the factory. All parts replaced under warranty will become the property of Yamaha Motor Corporation, U.S.A.

**CUSTOMER'S RESPONSIBILITY.** Under the terms of this warranty, the customer will be responsible for ensuring that the watercraft is properly operated, maintained, and stored as specified in the applicable Owner's/Operator's Manual.

The owner of the watercraft shall give notice to an authorized Yamaha dealer of any and all apparent defects within ten [10] days of discovery and make the watercraft available at that time for inspection and repairs at the dealer's place of business.

**GENERAL EXCLUSIONS FROM WARRANTY.** This warranty will not cover the repair of damage if the damage is a result of abuse or neglect of the product. Examples of abuse and neglect include, but are not limited to:

1. Racing or competition use, modification of original parts abnormal strain.
2. Lack of proper maintenance and off season storage as described in the Owner's/Operator's Manual, installation of parts or accessories that are not equivalent in design and quality to genuine Yamaha parts.
3. Use of lubricants, oils, and fuel/oil mixtures that are not suitable for watercraft or motor use.
4. Damage as a result of accidents, collisions, contact with foreign materials, or submersion.
5. Growth of marine organisms on motor or hull surfaces.
6. Normal deterioration.
7. Gel coat stress cracks.

**SPECIFIC PARTS EXCLUDED FROM WARRANTY.**

Parts replaced due to normal wear or routine maintenance such as oil, spark plugs, fuel filters, impeller and liner, and anodes are not covered by warranty. Charges for transporting the watercraft to and from an authorized Yamaha dealer are excluded from warranty coverage.

**TRANSFER OF WARRANTY.** Transfer of the warranty from the original purchaser to any subsequent purchaser is possible by having the watercraft inspected by an authorized Yamaha dealer and requesting the dealer to submit a change of registration to Yamaha Motor Corporation, U.S.A. within ten [10] days of the transfer.

**YAMAHA MOTOR CORPORATION, U.S.A. MAKES NO OTHER WARRANTY OF ANY KIND, EXPRESSED OR IMPLIED. ALL IMPLIED WARRANTIES OF MERCHANTABILITY AND FITNESS FOR A PARTICULAR PURPOSE WHICH EXCEED THE OBLIGATIONS AND TIME LIMITS STATED IN THIS WARRANTY ARE HEREBY DISCLAIMED BY YAMAHA MOTOR CORPORATION, U.S.A. AND EXCLUDED FROM THIS WARRANTY.**

**SOME STATES DO NOT ALLOW LIMITATIONS ON HOW LONG AN IMPLIED WARRANTY LASTS, SO THE ABOVE LIMITATION MAY NOT APPLY TO YOU. ALSO EXCLUDED FROM THIS WARRANTY ARE ANY INCIDENTAL OR CONSEQUENTIAL DAMAGES INCLUDING LOSS OF USE. SOME STATES DO NOT ALLOW THE EXCLUSION OR LIMITATION OF INCIDENTAL OR CONSEQUENTIAL DAMAGES, SO THE ABOVE EXCLUSION MAY NOT APPLY TO YOU.**

# Consumer information

---

**THIS WARRANTY GIVES YOU SPECIFIC LEGAL RIGHTS, AND YOU MAY ALSO HAVE OTHER RIGHTS WHICH VARY FROM STATE TO STATE.**

**YAMAHA MOTOR CORPORATION, U.S.A.**  
Post Office Box 6555  
Cypress, California 90630

## WARRANTY QUESTIONS AND ANSWERS

- Q. What costs are my responsibility during the warranty period?
- A. The customer's responsibility includes all costs of normal maintenance services, non-warranty repairs, accident and collision damages.
- Q. What are some examples of "abnormal" strain, neglect, or abuse?
- A. These terms are general and overlap each other in areas. Specific examples include:  
Running the watercraft out of oil, operating the machine with a broken or damaged part which causes another part to fail, and so on. If you have any specific questions on operation or maintenance, please contact your Yamaha dealer for advice.
- Q. Does the warranty cover incidental costs such as transportation due to a failure?
- A. No. The warranty is limited to repair of the watercraft itself.
- Q. May I perform any or all of the recommended maintenance shown in the Owner's/Operator's Manual instead of having the dealer do them?
- A. Yes, if you are a qualified mechanic and follow the procedures specified in the Owner's/Operator's and Service Manual. We do recommend, however, that items requiring special or equipment be done by a Yamaha dealer.
- Q. Will the warranty be void or cancelled if I do not operate or maintain my new watercraft exactly as specified in the Owner's/Operator's Manual?
- A. No. The warranty on a new watercraft cannot be "voided" or "cancelled". **However, if a particular failure is caused by operation or maintenance other than as shown in the Owner's/Operator's Manual, that failure may not be covered under warranty.**
- Q. What responsibility does my dealer have under this warranty?
- A. Each Yamaha dealer is expected to:
1. Completely set up each new watercraft before sale.
  2. Explain the operation, maintenance, and warranty requirements to your satisfaction at the time of sale, and upon your request at any later date. In addition, each Yamaha dealer is held responsible for his setup, service and warranty repair work.
- Q. Is the warranty transferable to second owners?
- A. Yes. The remainder of the existing warranty can be transferred upon request. The unit has to be inspected and re-registered by an authorized Yamaha dealer for the policy to remain effective.

## CUSTOMER SERVICE

If your watercraft requires warranty service, you must take it to any authorized Yamaha dealer within the continental United States. Be sure to bring your warranty registration card or other valid proof of the original date of purchase. If a question or problem arises regarding warranty, first contact the owner of the dealership. Since all warranty matters are handled at the dealer level, this person is in the best position to help you. If you are still not satisfied and require additional assistance, please write:

YAMAHA MOTOR CORPORATION U.S.A.  
CUSTOMER RELATIONS DEPARTMENT  
P.O. Box 6555  
Cypress, California 90630

## CHANGE OF ADDRESS

The federal government requires each manufacturer to maintain a complete, up-to-date list of all first purchasers against the possibility of a safety-related defect and recall. This list is compiled from the purchase registrations sent to Yamaha Motor Corporation, U.S.A. by the selling dealer at the time of your purchase.

If you should move after you have purchased your new watercraft, please advise us of your new address by sending a postcard listing your Yamaha model name, engine number, dealer number [or dealer's name] as it is shown on your warranty card, your name and new mailing address.

Mail to:

YAMAHA MOTOR CORPORATION, U.S.A.  
P.O. Box 6555  
Cypress, California 90630  
Attention: Warranty Department

This will ensure that Yamaha Motor Corporation, U.S.A. has an up-to-date registration record in accordance with federal law.

EJU34800

## YAMAHA EXTENDED SERVICE (Y.E.S.)

Keep your Yamaha protected even after your warranty expires with genuine Yamaha Extended Service (Y.E.S.).

- Y.E.S. is designed and administered by Yamaha Motor Corporation to provide maximum owner satisfaction. You get uninterrupted factory-backed coverage for extra peace of mind.
- Y.E.S. is flexible. You choose the plan that is right for you: 12 months, 24 months, 36 months, or (on four-stroke models) 48 months beyond your warranty period.
- Y.E.S. is designed and administered by the same Yamaha people who handle your warranty—and it shows in the comprehensive coverage benefits. There are no mileage limitations. Coverage is not limited to “moving parts” or the “drive train” like many other plans. And Y.E.S. covers manufacturing defects just like the warranty. See the sample contract at your Yamaha dealer to see how comforting uninterrupted factory-backed protection can be.
- You do not have to pay anything for covered repairs. There is no deductible to pay, and repairs are not “pro-rated.” You do not have any “out-of-pocket” expenses for covered repairs.
- In addition, Travel and Recreation Interruption Protection (TRIP) is included at no extra cost. TRIP gives you up to \$150 reimbursement per occurrence for any reasonable expenses you incur because your Yamaha needs covered service: replacement vehicle rental, emergency towing, phone calls, even food and lodging when you are away from home. This superb coverage goes into effect when you purchase Y.E.S., so it applies to any warranty repairs as well as covered repairs during your entire Y.E.S. plan period.
- Y.E.S. coverage is honored at any authorized Yamaha dealer nationwide.
- Y.E.S. coverage is transferable to a new owner if you sell or trade-in. That can make your Yamaha much more valuable!

This excellent Y.E.S. plan coverage is only available to Yamaha owners like you, and only while your Yamaha is still within the Yamaha Limited Warranty period. So visit your authorized Yamaha dealer to get all the facts. He can show you how easy it is to protect your investment with Yamaha Extended Service.

We urge you to act now. You will get the excellent benefits of TRIP coverage right away, and you will rest easy knowing you will have strong factory-backed protection even after your Yamaha Limited Warranty expires.

A special note:

If visiting your dealer is not convenient, contact Yamaha with your Primary ID number (your Owner's Manual shows you where to find this number). We will be happy to help you get the Y.E.S. coverage you need.

Yamaha Service Marketing  
P.O. Box 6555  
Cypress, CA 90630  
1-(866)-YES-EXTD  
(1-866-937-3983)



**YAMAHA EXTENDED SERVICE**

# Index

---

<b>A</b>			
Air filter element .....	94	Enjoy your watercraft responsibly .....	25
Analog speedometer/tachometer .....	46	<b>F</b>	
Analog speedometer/tachometer and indicator lights .....	46	Fire extinguisher .....	67
Approval label of emission control certificate .....	2	Flushing the cooling system .....	86
<b>B</b>		Front storage compartment .....	56
Battery .....	66, 87	Fuel and oil .....	59
Battery, checking .....	99	Fuel injection system .....	101
Battery, jumping .....	107	Fuel level .....	63
Beaching the watercraft .....	83	Fuel level meter .....	49
Beverage holder .....	58	Fuel level warning indicator .....	50
Bilge .....	65	Fuel system .....	87
Boarding alone .....	77	Fuel system, checking .....	93
Boarding and starting from a dock .....	77	Fuel tank .....	93
Boarding and starting in deep water .....	77	Fuel tank filler cap .....	31
Boarding and starting in shallow water .....	76	Fuel tank, filling .....	60
Boarding with passengers .....	78	Fuses, replacing .....	108
Bow down .....	38	<b>G</b>	
Bow eye .....	39	Gasohol .....	59
Bow up .....	38	Gasoline .....	59
<b>C</b>		Getting to know your watercraft .....	74
Capsized watercraft .....	80	Glove compartment .....	56
Check engine warning indicator .....	52	<b>H</b>	
Cleaning the watercraft .....	88	Handgrip .....	39
Cooling water pilot outlets .....	34, 70	Hazard information .....	16
Cruise assist .....	44	Hood .....	31
Cruising limitations .....	11	Hour meter/voltmeter .....	50
<b>D</b>		Hull and deck .....	63
Digital speedometer .....	49	Hull Identification Number (HIN) .....	1
Docking the watercraft .....	83	<b>I</b>	
<b>E</b>		Identification numbers .....	1
Emergency procedures .....	106	Important labels .....	5
Emission control information .....	2	<b>J</b>	
Engine break-in .....	71	Jet intake .....	69
Engine compartment .....	63	Jet intake and impeller, cleaning .....	106
Engine oil .....	60	Jet thrust nozzle angle, checking .....	94
Engine oil and oil filter .....	93	Jumper cables, connecting .....	107
Engine oil level .....	63	<b>L</b>	
Engine overheat warning indicator .....	51	Labels, other .....	8
Engine serial number .....	1	Labels, warning .....	6
Engine shut-off cord .....	70	Launching the watercraft .....	72
Engine shut-off switch .....	33	Learning to operate your watercraft .....	74
Engine stop switch .....	33	Leaving the watercraft .....	74
		Left multifunction display and operation buttons .....	48

Limitations on who may operate the watercraft.....	10	Rules of the Road .....	20
Limited warranty.....	110	<b>S</b>	
“L-MODE” indicator light.....	48	Seat storage compartment.....	57
Lubrication.....	87	Seats .....	30
Lubrication points.....	98	Selecting the operation mode .....	42
<b>M</b>		“SET” switch.....	34
Main components, location of .....	26	Shift cable, checking .....	94
Maintenance and adjustments .....	89	Shift lever .....	36
Manufactured date label.....	3	Shift lever and reverse gate .....	68
Multifunction information center .....	45, 71	Spark plugs, cleaning and adjusting .....	96
<b>N</b>		“SPEED” indicator light .....	47
No-wake mode .....	42	Star labels .....	3
“NO-WAKE MODE” switch.....	34	Start switch.....	34
<b>O</b>		Starting the engine .....	72
Oil pressure warning indicator.....	51	Starting the watercraft .....	76
Operating your watercraft.....	74	Steering system .....	35, 67
Operation .....	71	Stern drain plugs .....	66
Operation of controls and other functions .....	30	Stern eyes .....	40
Operation requirements .....	13	Stopping the engine .....	74
Owner’s/operator’s manual and tool kit....	89	Stopping the watercraft .....	82
<b>P</b>		Storage.....	86
Periodic maintenance chart.....	91	Storage compartments .....	55
Post-operation care.....	84	Submerged watercraft.....	109
Pre-operation check list.....	61	Switches .....	70
Pre-operation check points .....	63	Switches, right handlebar .....	34
Pre-operation checks .....	61	<b>T</b>	
Primary Identification (PRI-ID) number .....	1	Throttle cable, checking and adjusting .....	95
Pull-up cleats (for FX Cruiser SHO) .....	40	Throttle lever .....	34, 67
<b>Q</b>		Tilt lever.....	36
Quick Shift Trim System (QSTS) .....	69	To get more boating safety information....	24
Quick Shift Trim System (QSTS) selector .....	37	Towing the watercraft.....	109
<b>R</b>		Transporting .....	85
Reboarding step.....	39	Trolling speed, checking .....	101
Recommended equipment .....	15	Troubleshooting .....	103
Remote control transmitter.....	32	Troubleshooting chart .....	103
Reverse on waterways.....	83	Turning the watercraft .....	81
Riding with passengers.....	75	<b>U</b>	
Right multifunction display and operation buttons (for FX Cruiser SHO) .....	52	“UNLOCK” indicator light.....	48
Rough water operation.....	83	Up and down switches .....	34
“RPM” indicator light.....	47	<b>W</b>	
		“WARNING” indicator light .....	48
		Water separator .....	64
		Watercraft characteristics.....	16
		Water-skiing .....	18
		Watertight compartment.....	58

# Index

---

## Y

- Yamaha Engine Management System (YEMS) ..... 40
- YAMAHA EXTENDED SERVICE (Y.E.S.) ..... 112
- Yamaha Security System..... 40
- Yamaha Security System settings ..... 41







Printed in USA  
January 2008-4.0 × 1 CR

## Free Manuals Download Website

<http://myh66.com>

<http://usermanuals.us>

<http://www.somanuals.com>

<http://www.4manuals.cc>

<http://www.manual-lib.com>

<http://www.404manual.com>

<http://www.luxmanual.com>

<http://aubethermostatmanual.com>

Golf course search by state

<http://golfingnear.com>

Email search by domain

<http://emailbydomain.com>

Auto manuals search

<http://auto.somanuals.com>

TV manuals search

<http://tv.somanuals.com>