

BELKIN®

OmniView® PR03 KVM Switch



User Manual

F1DA104Z
F1DA108Z
F1DA116Z

Table of Contents

1. Introduction	1
Package Contents	1
2. Overview	2
Feature Overview	2
Equipment Requirements	4
System Requirements	6
Unit Display Diagrams	7
Specifications	9
3. Installation	10
Pre-Configuration	10
Mounting the PRO3 KVM Switch	11
Connecting the Console to the PRO3 KVM Switch	14
Connecting Servers to the PRO3 KVM Switch	16
Connecting Multiple PRO3 KVM Switches (Daisy-Chaining)	20
Powering Up the Systems	25
4. Using your PRO3 KVM Switch	26
Selecting a Server or BANK Using Hot-Key Commands	26
Selecting a Server Using Direct-Access Port Selectors	28
Selecting a BANK Using Scroll Buttons	28
AutoScan Mode	29
On-Screen Display (OSD)	30
Keyboard Hot-Key-Command Shortcuts	34
Sun Combo and Mac Key Mapping	35
Updating Firmware	36
5. Frequently Asked Questions	37
6. Troubleshooting	39
7. Glossary	42
8. Information	43

Congratulations on your purchase of this Belkin OmniView PRO3 KVM Switch (the KVM Switch). Our diverse line of KVM solutions exemplifies the Belkin commitment to delivering high-quality, durable products at an affordable price.

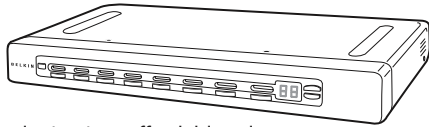

Belkin has designed and developed this KVM Switch with the server administrator in mind. The result is a KVM Switch that surpasses any other switch on the market. The PRO3 KVM Switch is engineered to work with the most advanced server-room and laboratory environments, offering intuitive port indicators, direct-access port selectors, high video resolution support, and flash-upgradeable firmware.

PRO3 KVM Switches can be daisy-chained together easily to enable management of up to 256 PS/2 and/or USB servers from a single console. The PRO3 KVM Switch also comes with an unparalleled Belkin 3-Year Warranty.

This User Manual will provide details about your new PRO3 KVM Switch, from installation and operation to troubleshooting—in the unlikely event of a problem. For quick and easy installation, please refer to the Quick Installation Guide included in your PRO3 KVM Switch packaging.

Thank you for purchasing the Belkin OmniView PRO3 KVM Switch. We appreciate your business and have confidence that you will soon see for yourself why Belkin is the number-one-selling brand in KVM switches worldwide.

Package Contents



OmniView PRO3
KVM Switch



Rack-Mount
Brackets with
Screws (F1DA108Z,
F1DA116Z only)



DB9-to-RJ11
Serial Flash
Cable



User Manual



Quick
Installation Guide



12V DC,
1A Power Supply

Feature Overview

- **Hot Keys**

Hot-key functionality allows you to select a desired port using designated key commands. By using a simple hot-key sequence on your keyboard, you can select one server from as many as 256 servers, instantaneously.

- **AutoScan**

The AutoScan feature allows you to set your PRO3 KVM Switch to scan and monitor the activities of all connected servers, one by one. The time interval allotted for each server can be adjusted through the On-Screen Display (OSD) menu.

- **Video Resolution**

The PRO3 KVM Switch supports video resolutions of up to 1920x1440@75Hz.

- **Security**

Allows you to specify user names and passwords to prevent unauthorized users from accessing the OSD and KVM Switch.

- **Dedicated Daisy-Chain Port**

Up to 16 KVM switches can be daisy-chained together using dedicated ports, so you can easily expand your KVM configuration as your server environment grows.

- **On-Screen Display (OSD)**

The OSD feature simplifies server management by allowing you to assign individual names to each connected server throughout the system. It provides a visual means of switching between servers and assigning the hot-key scheme. The OSD can also be set up to support regional languages.

- **Front-Panel Push Buttons**

Direct-access port selectors, located conveniently on the front panel of the PRO3 KVM Switch, allow for simple, manual port-selection.

- **LED Display**

An LED display on the front panel of the PRO3 KVM Switch serves as a status monitor. An LED above each direct-access port selector illuminates to indicate that the console currently controls the corresponding server. As a port selector is pushed, the LED above it will light up. A flashing port LED indicates that there is no server connected to that port.

- **7-Segment LED Display**

When daisy-chaining multiple PRO3 KVM Switches together, the 7-segment LED display serves as a quick indicator of the selected BANK.

- **Flash Upgrade**

Flash-upgradeable firmware allows you to install the latest firmware on your PRO3 KVM Switch. This enables your KVM Switch to maintain consistent compatibility with the latest devices and servers. Firmware upgrades are free for the life of your PRO3 KVM Switch and can be downloaded from Belkin's support website at www.belkin.com/support.

1	
2	section
3	
4	
5	
6	
7	
8	

Equipment Requirements

Cables:

Connecting the PRO3 KVM Switch to a server requires a Belkin Dual-Port Micro-Cable Kit.

Belkin Dual-Port Micro-Cable Kits:

F1D9400-XX (PS/2-style) F1D9401-XX (USB-style)

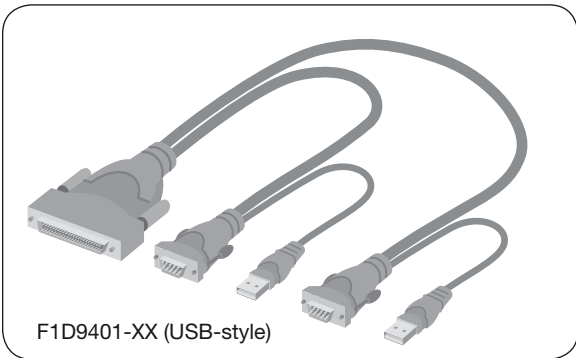
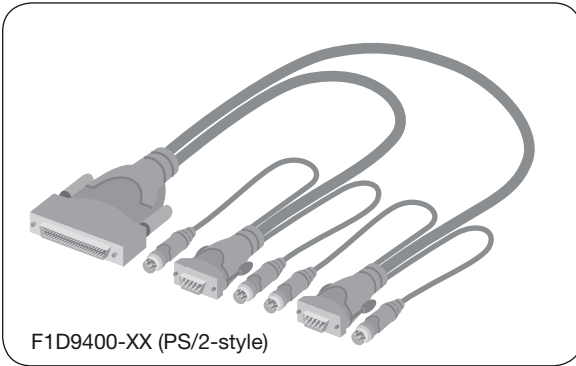

Belkin PRO3 Daisy-Chain Cable: F1D108-CBL-XX
(-XX denotes length in feet)

Note: Product codes and availability may vary.

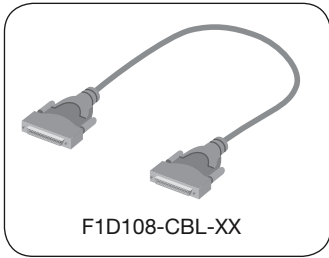

System Requirements

OS Platforms

The PRO3 KVM Switch is compatible with CPUs running on, but not limited to, the following OS platforms

- Windows® NT®, 95, 98, 2000, Me, XP, Server 2003, or Vista™
- Microsoft® DOS 5.x and above
- Red Hat® Linux® 8.x and above
- Novell® NetWare® 5.x
- Mac OS® X and above (with USB support)
- Sun™ Solaris™ 8.x and above

Keyboards

- PS/2-compatible
- USB-compatible
- Supports 101-/102-/104-key keyboards

Mice

- PS/2- and USB-compatible mice (with PS/2 adapter) having 2, 3, 4, or 5 buttons
- PS/2- and USB-compatible wireless or optical mice

Monitors

- CRT
- LCD (with VGA support)

Unit Display Diagrams

Front View of the PR03 KVM Switch:

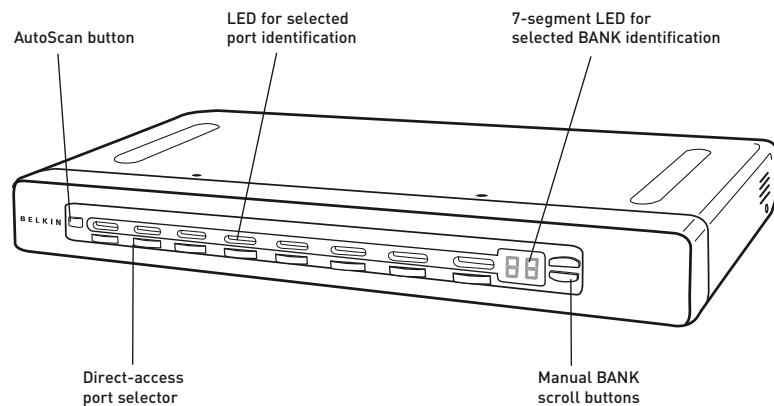

(F1DA108Z)

1	
2	section
3	
4	
5	
6	
7	
8	

Unit Display Diagrams

Back View of the PR03 KVM Switch:

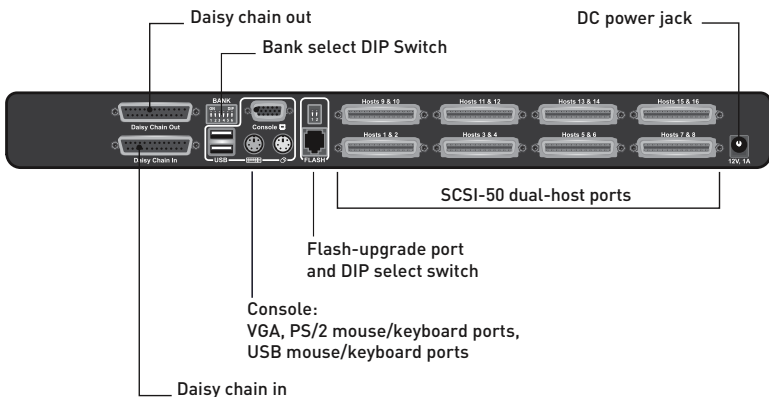

Specifications

Part No.:	F1DA104Z, F1DA108Z, F1DA116Z
Enclosure:	Metal enclosure with high-impact plastic faceplate
Power:	12V DC, 1A power adapter, center-pin-positive polarity
Daisy-Chain:	Maximum of 16 OmniView KVM Switches
No. of Servers Supported:	4, 8, and 16 respectively for 4-, 8-, and 16-port models (256 servers max. via daisy-chaining)
Monitors Supported:	CRT and LCD (with VGA support)
Max. Resolution:	Up to 1920x1440 @ 75Hz
Keyboard Input:	PS/2 (miniDIN6), USB (Type A)
Mouse Input:	PS/2 (miniDIN6), USB (Type A)
Monitor Port:	VGA (HDDDB15 female)
CPU Ports:	SCSI-50
Daisy-Chain Ports:	DB25 female
Flash-Upgrade Port:	RJ11
Direct Port Selectors:	4, 8, and 16 respectively for 4-, 8-, and 16-port models
Operating Temp:	32° to 104° F (0~40° C)
Storage Temp:	-4° to 140° F (20~60° C)
Humidity:	0-80% RH, non-condensing
Warranty:	3 years
Dimensions:	(F1DA104Z) 11 x 1.75 x 6 in. (279mm x 44.5mm x 150mm) (F1DA108Z) 17.25 x 1.75 x 7.5 in. (438mm x 44.5mm x 190mm) (F1DA116Z) 17.25 x 3.5 x 7.5 in. (438mm x 89mm x 190mm)
Weight:	(F1DA104Z) 5.3 lbs. (2.4kg.) (F1DA108Z) 9.2 lbs. (4.2kg.) (F1DA116Z) 12.0 lbs. (5.5kg.)

Note: Specifications are subject to change without notice.

1

2

3

4

5

6

7

8

section

Pre-Configuration

Where to Place the PRO3 KVM Switch

The enclosure of the PRO3 KVM Switch is designed for stand-alone or rack-mount configuration. The 8- and 16-Port PRO3 KVM Switches are natively rack-mountable in standard, 19-inch server racks. Rack-mount hardware is included with these Switches for a sturdy rack installation. An optional OmniView Rack-Mount Kit (F1D005) is available for use with the 4-Port PRO3 KVM Switch.

Consider the following when deciding where to place the PRO3 KVM Switch:

- whether or not you intend to use the direct-access port selectors
- the lengths of the cables attached to your keyboard, monitor, and mouse
- the location of your servers in relation to your console
- the lengths of the cables you use to connect your servers to the PRO3 KVM Switch

Cable-Distance Requirements:

For PS/2 Servers:

VGA signals transmit best up to 25 feet (7.6m). Beyond that length, the probability of video degradation increases. For this reason, Belkin recommends that the length of the cables between the PRO3 KVM Switch and the connected servers does not exceed 25 feet (7.6m).

For USB Servers:

USB signals can be transmitted up to 15 feet (4.5m) between the PRO3 KVM Switch and server. Beyond that length, the probability of USB-signal failure is likely, and may cause the device to fail.

Note: The Belkin OmniView CAT5 Extender (F1D084) may be used to extend your console (keyboard, mouse, and monitor) by up to 300 feet (91m).

Cautions and Warnings!

Avoid placing cables near fluorescent lights, air-conditioning equipment, or machines that create electrical noise (e.g., vacuum cleaners).

Before attempting to connect anything to the PRO3 KVM Switch or your servers, ensure that everything is powered off. Plugging and unplugging cables while servers are powered on may cause irreversible damage of the servers and/or the PRO3 KVM Switches. Belkin is not responsible for damage caused in this way.

You are now ready to begin installation of your PRO3 KVM Switch. The following sections (pages 11-19) provide complete instructions for the hardware setup of a single PRO3 KVM Switch (F1DA104Z, F1DA108Z, F1DA116Z).

Mounting the PRO3 KVM Switch

Bracket Installation (F1DA108Z and F1DA116Z)

Eight- or 16-Port PRO3 KVM Switches include adjustable mounting brackets ideal for installation in 19-inch racks. The mounting brackets feature three adjustment positions to allow you to set the PRO3 KVM Switch's face flush with the ends of the rails or to extend the PRO3 KVM Switch past the front of the rails. Please follow these simple steps to achieve the desired adjustment.

Step 1

Determine how far you would like the PRO3 KVM Switch to protrude from the rack. Select a bracket-hole scheme.

Step 2

Attach the bracket to the side of your PRO3 KVM Switch using the Phillips screws provided. (Refer to diagram below.)

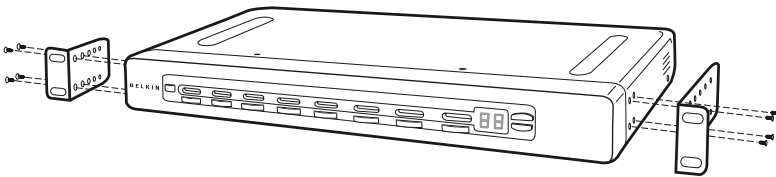

Step 3

Mount the PRO3 KVM Switch to the rack-rail assembly. (Refer to diagram below.)

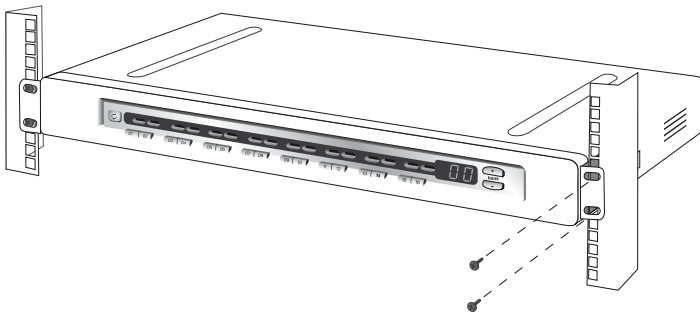

Note: If this PRO3 KVM Switch will be daisy-chained to another KVM switch, set the BANK address prior to installing on a rack. Refer to the section in this User Manual titled “Connecting Multiple PRO3 KVM Switches (Daisy-Chaining)”.

Your PRO3 KVM Switch is now mounted securely into the bracket and you are ready to connect the console.

Optional Bracket Installation (F1DA104Z)

The PRO3 4-Port KVM Switch can be installed into a 19-inch server rack using an optional OmniView Rack-Mount Kit (F1D005).

Step 1

Attach the rack-mount bracket to your 4-Port PRO3 KVM Switch using the Phillips screws provided. (Refer to diagram below.)

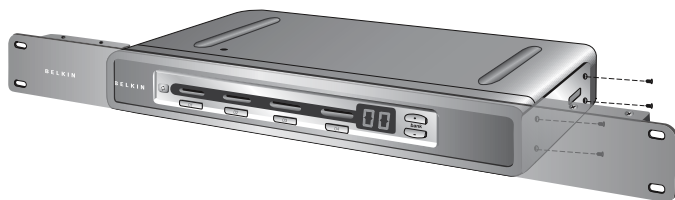

Step 2

Mount the 4-Port PRO3 KVM Switch to the rack-rail assembly. (Refer to diagram below.)



Note: If this PRO3 KVM Switch will be daisy-chained to another KVM switch, set the BANK address prior to installing on a rack. Refer to the section titled “Connecting Multiple PRO3 KVM Switches (Daisy-Chaining)” in this User Manual.

Your PRO3 KVM Switch is now mounted securely to the rack and you are ready to connect the console.

Note for Belkin PRO2 Series Owners (F1DA104T, F1DA108T, and F1DA116T): Installation for the PRO2 KVM Switch has changed. Please follow this installation manual completely to ensure proper installation. Failure to do so may result in keyboard or mouse errors, and/or faulty operation.

1

2

3

4

5

6

7

8

section

Connecting the Console to the PRO3 KVM Switch

You must use the same type of platform for both the keyboard and mouse. For example, if you are using a USB Keyboard, you must also connect a USB mouse to the console.

Step 1

Connect the VGA monitor cable to the HDB15 female port on the back of the PRO3 KVM Switch in the “Console” section. (Refer to diagram below.)



Step 2

Connect the PS/2 or USB keyboard cable to the keyboard port on the back of the PRO3 KVM Switch in the “Console” section. (Refer to diagram below.)

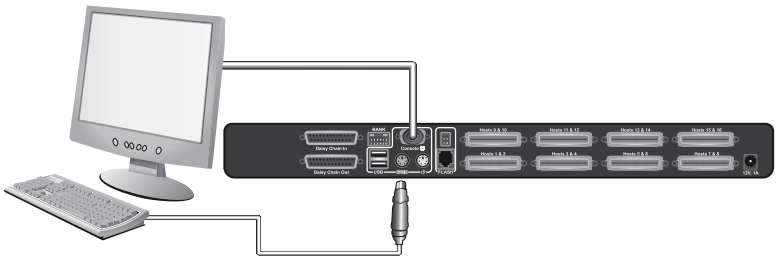

Step 3

Connect the PS/2 or USB mouse cable to the mouse port on the back of the PRO3 KVM Switch in the “Console” section. (Refer to diagram below.)

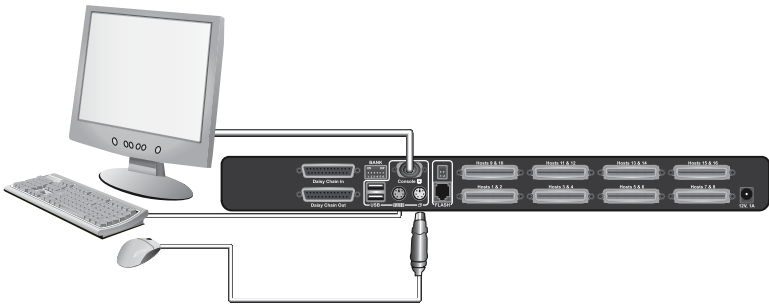

⚠ Note: It is recommended to use all USB input devices or all PS/2 input devices when connecting to the console.

Step 4

Attach the power adapter to the DC power jack labeled “12VDC, 1A” located on the rear panel of the PRO3 KVM Switch. Only use the power adapter supplied with the unit. (Refer to diagram below.)

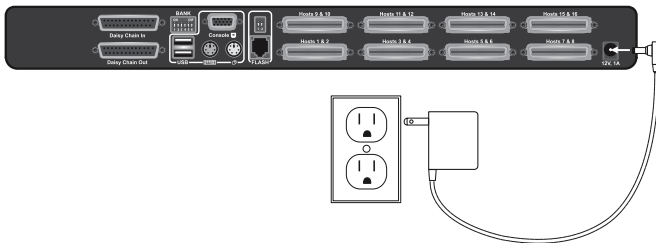

Your PRO3 KVM Switch is now installed and you are ready to connect your servers.

Connecting Servers to the PRO3 KVM Switch (PS/2 Connection):

Step 1

Make sure your server is powered off.

Step 2

Using the Belkin Dual-Port Micro-Cable Kit for PS/2 (F1D9400-XX), connect the VGA connector to the monitor port on your server. (Refer to diagram below.)

Step 3

Connect the PS/2 mouse and keyboard connectors to the mouse and keyboard ports on the server. (Refer to diagram below.)

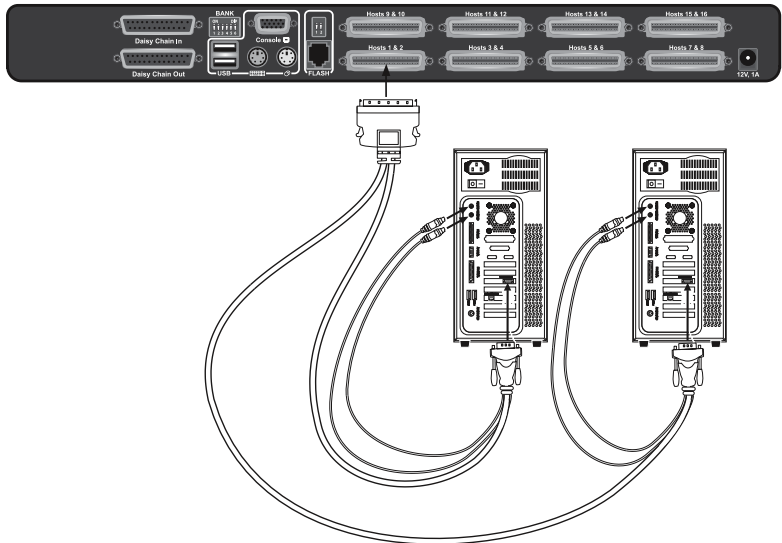

Step 4

Connect the Belkin Dual-Port Micro-Cable Kit for PS/2 to the desired host ports on the PRO3 KVM Switch. (Refer to diagram below.)

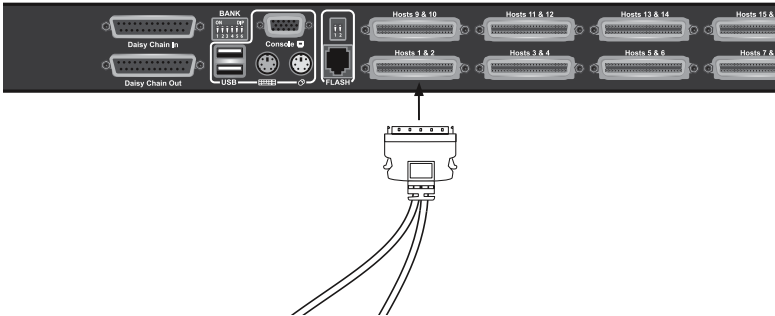

Step 5

Power up your server.

Step 6

Repeat Steps 1 through 5 for each additional PS/2 server you wish to connect.

Connecting Servers to the PR03 KVM Switch (USB Connection):

Step 1

Make sure your server is powered off.

Step 2

Using the Belkin Dual-Port Micro-Cable Kit for USB (F1D9401-XX), connect the VGA connector to the monitor port on your server. (Refer to diagram below.)

Step 3

Connect the USB connector to an available USB port on the server. (Refer to diagram below.)

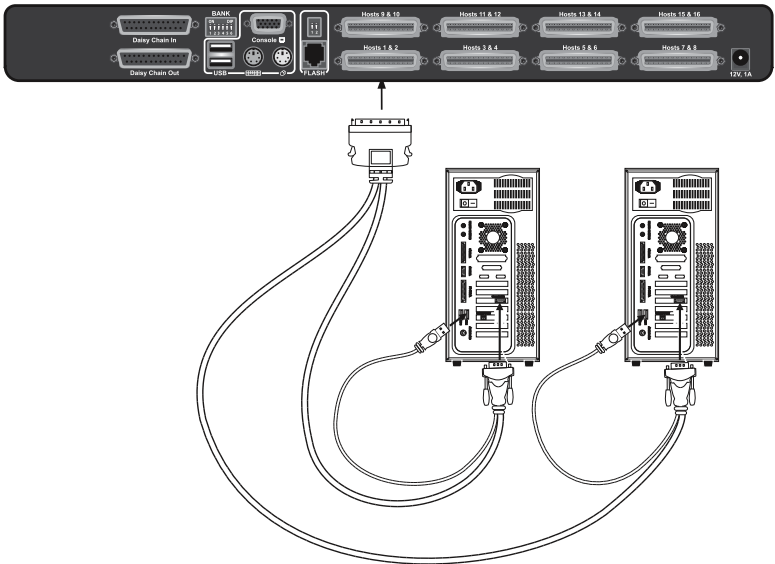

Step 4

Connect the Belkin Dual-Port Micro-Cable Kit for USB to the desired host ports on the PRO3 KVM Switch. (Refer to diagram below.) Your server should recognize the KVM-Switch connection and automatically install the HID USB driver, if necessary.

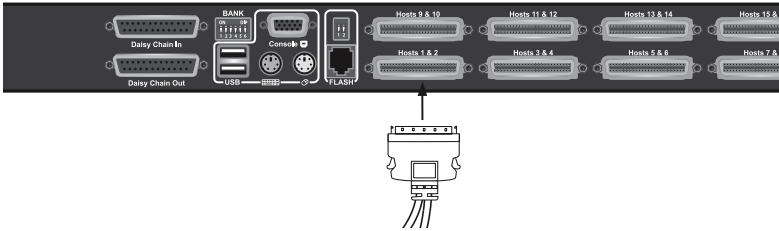

Step 5

Repeat Steps 1 through 4 for each additional USB server you wish to connect.

Note: We recommend that you attach the Belkin Dual-Port Micro-Cable USB Kit directly to a free USB port on your server.

Note: When a USB Cable Kit is connected to a Sun server, the Server Interface Module emulates the Sun keys using a set of key combinations called “combo keys”. Refer to the table on page 35 for a list of Sun functions supported by the PRO3 KVM Switch.

Connecting Multiple PRO3 KVM Switches (Daisy-Chaining)

You can daisy-chain up to 16 PRO3 KVM Switches, allowing a server administrator to manage up to a maximum of 256 servers from one console. Each daisy-chained PRO3 KVM Switch is referred to as a “BANK” and is assigned an address. The PRO3 KVM Switch connected to the console keyboard, mouse, and monitor is BANK 00 and is referred to as the “primary” KVM switch. BANKs 01 through 15 are referred to as “secondary” KVM switches.

Note: Your PRO3 KVM Switch is backward-compatible with Belkin OmniView PRO2 KVM Switches with standard cabling (F1DA104T, F1DA108T, F1DA116T). In a daisy-chain configuration, the PRO3 KVM Switch with micro-cabing (F1DA104Z, F1DA108Z, F1DA116Z) must be designated as the primary KVM switch. (Refer to the diagram below.)

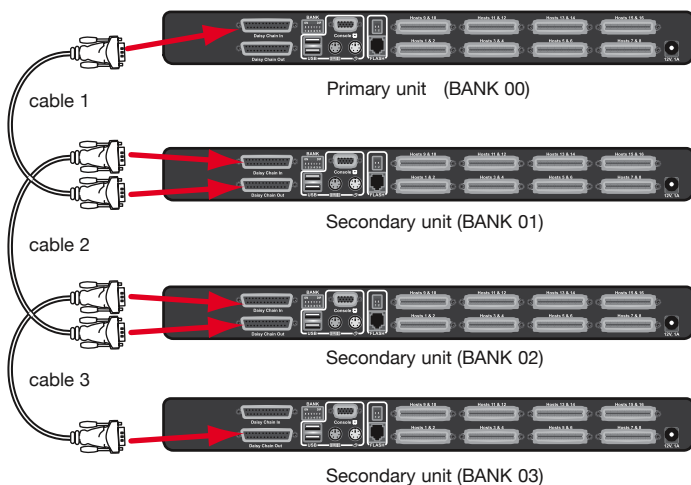

Note: A Daisy-Chain Cable (F1D108-CBL) is **required** to daisy-chain each PRO3 KVM Switch and is available through your Belkin reseller, or online at www.belkin.com.

How to Assign a BANK Address

All PRO3 KVM Switches feature a “BANK DIP” switch. The “BANK DIP” switch is used to assign the proper BANK address to each PRO3 KVM Switch.

- For a single-unit configuration, set the “BANK DIP” switch on the PRO3 KVM Switch to the “primary” (BANK address 00) setting. This is the factory default setting.
- For a multi-unit configuration, the “BANK DIP” switch on the primary KVM switch must be set to “BANK address 00”. Each secondary unit must be set to a unique BANK address (from 01 through 15). Refer to the chart below for “BANK DIP” switch settings.

BANK-DIP-Switch Configuration Chart

DIP SWITCH#						BANK ADDRESS	
1	2	3	4	5	6		
ON	ON	ON	ON	ON	ON	BANK 0	PRIMARY (default)
ON	ON	OFF	ON	ON	ON	BANK 1	SECONDARY
ON	ON	ON	OFF	ON	ON	BANK 2	SECONDARY
ON	ON	OFF	OFF	ON	ON	BANK 3	SECONDARY
ON	ON	ON	ON	OFF	ON	BANK 4	SECONDARY
ON	ON	OFF	ON	OFF	ON	BANK 5	SECONDARY
ON	ON	ON	OFF	OFF	ON	BANK 6	SECONDARY
ON	ON	OFF	OFF	OFF	ON	BANK 7	SECONDARY
ON	ON	ON	ON	ON	OFF	BANK 8	SECONDARY
ON	ON	OFF	ON	ON	OFF	BANK 9	SECONDARY
ON	ON	ON	OFF	ON	OFF	BANK 10	SECONDARY
ON	ON	OFF	OFF	ON	OFF	BANK 11	SECONDARY
ON	ON	ON	ON	OFF	OFF	BANK 12	SECONDARY
ON	ON	OFF	ON	OFF	OFF	BANK 13	SECONDARY
ON	ON	ON	OFF	OFF	OFF	BANK 14	SECONDARY
ON	ON	OFF	OFF	OFF	OFF	BANK 15	SECONDARY

ON = Up Position, OFF = Down Position

Example: Four 8-Port PRO3 KVM Switches (F1DA108Z) are daisy-chained together to manage up to 32 servers. The DIP switch on the primary KVM switch is set to “BANK 00” (factory default) and the secondary units are each set to a unique BANK (between 01 and 03).

Example of Daisy-Chain Configuration

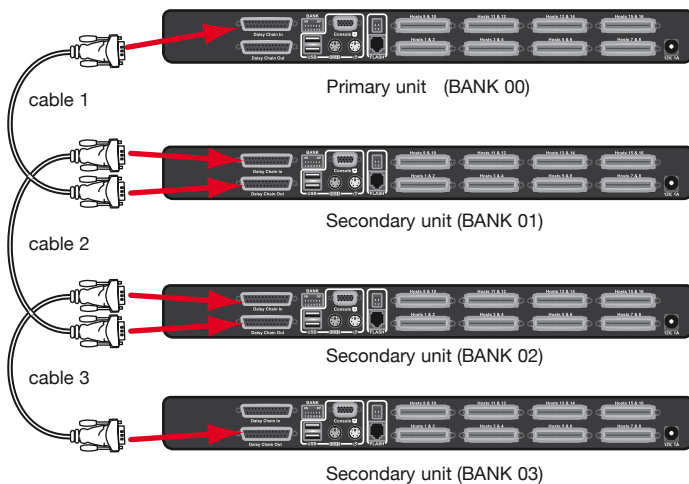

Getting Started:

Step 1: Make sure that all servers and PRO3 KVM Switches are powered off and that each PRO3 KVM Switch has been assigned a unique BANK address.

Step 2: Place all primary and secondary KVM switches in the desired location.

Step 3: Connect the console monitor, keyboard, and mouse to the console ports of the primary switch (BANK 00). Refer to “Connecting the Console to the PRO3 KVM Switch” on page 14.

Connecting the Primary and Secondary KVM Switches:

Step 1

Using the Daisy-Chain Cable (F1D108-CBL), connect one end to the “Daisy-Chain In” port on the primary KVM switch (BANK 00).

Step 2

Connect the other end of the Daisy-Chain Cable (F1D108-CBL) to the “Daisy-Chain Out” port of the first secondary KVM switch (BANK 01).

Step 3

To add secondary units, connect one end of the Daisy-Chain Cable (F1D108-CBL) to the “Daisy-Chain In” port on the first secondary KVM switch and the other end to the “Daisy-Chain Out” port of the next secondary KVM switch(for example, BANK 01).

Step 4

Repeat Step 3 for additional PRO3 KVM Switches you wish to daisy-chain together.

Note: Your PRO3 KVM Switch is backward-compatible with Belkin OmniView PRO2 KVM Switches with standard cabling (F1DA104T, F1DA108T, F1DA116T). In a daisy-chain configuration, the PRO3 KVM Switch with micro-cabling (F1DA104Z, F1DA108Z, F1DA116Z) must be designated as the primary KVM switch.

1

2

3

4

5

6

7

8

section

Connecting the Servers:

Step 1:

Connect all servers to the primary and secondary KVM switches. Refer to the “Connecting Servers to the PRO3 KVM Switch” section on page 16 for instructions.

Step 2:

Power up the secondary KVM switches sequentially, beginning with the highest BANK, by connecting each unit’s power supply. Each KVM switch should display its corresponding BANK-address number as it is powered up.

Step 3:

Power up the primary switch. You should see the primary KVM switch light up and display the digits “00”, indicating its BANK address.

Note: If the PRO3 KVM Switches do not enumerate correctly, reset the primary KVM switch (BANK 00) by simultaneously pressing the “BANK +” and “BANK –” buttons. You can also reset the primary KVM switch to detect newly added secondary KVM switches. If the KVM switches still do not enumerate correctly, check that all KVM switches have the correct BANK address assigned to them and that all daisy-chain cables are connected properly.

Step 4:

Verify that the primary KVM switch has detected all secondary KVM switches by scrolling through the BANKs using the “BANK +” and “BANK –” buttons. If all secondary KVM switches are detected properly, the LED display on the primary KVM switch will register and display the BANK address of the attached secondary KVM switch.

Powering Up the Systems

Verify that all servers connected to the PRO3 KVM Switch are powered on. If any connected servers have not been powered on, it is okay to do so at this time (servers can be powered on simultaneously). The PRO3 KVM Switch emulates both a mouse and keyboard on each port and allows your server to boot normally.

The server connected to Port “1” will be displayed on the monitor. Check that the keyboard, monitor, and mouse are working normally. Check all occupied ports to verify that all servers are connected and responding correctly. If you encounter an error, check your cable connections for that server and reboot. If the problem persists, please refer to the “Troubleshooting” section in this User Manual.

1

2

3

4

5

6

7

8

section

Now that you have connected your console and servers to your PRO3 KVM Switch, it is ready for use. Select connected servers with the direct-access port selectors, located on the front panel of the PRO3 KVM Switch; through the On-Screen Display; or by using hot-key commands through the console keyboard. It takes approximately 1–2 seconds for the video signal to refresh after switching servers. Re-synchronization of the mouse and keyboard signals also occurs. This is normal operation and ensures that proper synchronization is established between the console and the connected servers.

Note: For security reasons and to conserve energy, the PRO3 KVM Switch has been designed to turn off the console monitor after 10 minutes of inactivity. Press any key on the console keyboard to turn on the monitor. If security is enabled in the OSD, you will be prompted to enter a user name and password.

Selecting a Server or BANK Using Hot-Key Commands

Switch to the next or previous port with simple, keyboard hot-key sequences using the “Scroll Lock” key, and either the “Up” or “Down” arrow keys. To send commands to the PRO3 KVM Switch, the “Scroll Lock” key must be pressed twice within two seconds. The PRO3 KVM Switch will beep, confirming that it is in hot-key mode. Next, press the “Up” arrow key and the PRO3 KVM Switch will switch to the previous port. Press the “Down” arrow key to switch to the next port.

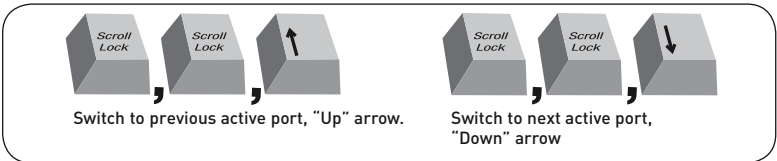

With a single-switch configuration (no daisy-chained KVM switches), you can switch directly to any port by entering the 2-digit number of the port you wish to access. For example, if you press “Scroll Lock”, “Scroll Lock”, “02”, the PRO3 KVM Switch will switch to the server on Port 2 located on BANK 00.

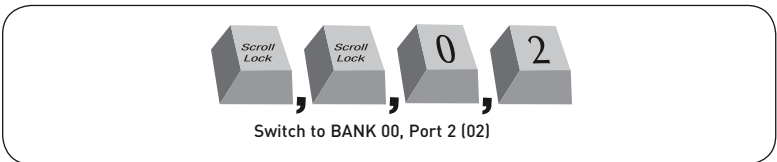

With a daisy-chain switch configuration, you can switch between BANKs (KVM switches) by pressing “Scroll Lock”, “Scroll Lock”, “Page Up”, to switch to the previous BANK. Press “Scroll Lock”, “Scroll Lock”, “Page Down”, to switch to the next BANK.

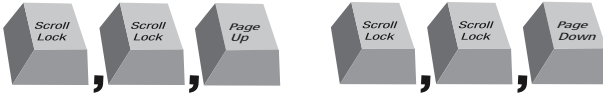

With a daisy-chain switch configuration, you can switch directly to any port on any BANK by pressing “Scroll Lock”, “Scroll Lock”, BANK address, and port number. For example, if you press “Scroll Lock”, “Scroll Lock”, “03”, “05”, the server on BANK 03, Port 5 will become active.

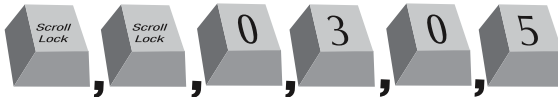

Note: You will have approximately five seconds to complete each hot-key sequence.

See page 33 for instructions on how to change the hot-key-initiator key.

1

2

3

4

5

6

7

8

section

Selecting a Server Using Direct-Access Port Selectors

You can directly select which server you wish to control by pressing the direct-access port selector next to the corresponding port. The LED will illuminate to indicate the port is currently selected. If you are installing multiple PRO3 KVM Switches that are daisy-chained, use the BANK scroll keys located on the front panel of the primary KVM switch to access other servers that are connected to the secondary KVM switches.

Selecting a BANK Using Scroll Buttons

Pressing the “BANK +” and “BANK –” scroll buttons on the primary KVM switch will allow you to switch between the daisy-chained PRO3 KVM Switches. Pressing both buttons simultaneously will reset the PRO3 KVM Switch.

The “BANK +” button will take you to the next BANK. For example, when you are at the primary switch (BANK 00) and want to check servers on BANK 02, pressing the “BANK +” button will take you to BANK 02. As a default, the first active server will be displayed on the console monitor. Use the direct-access port selectors to go to the desired server on BANK 02.

The “BANK –” button will take you to the previous BANK (for example, when you are at BANK 02 and want to check servers in BANK 01). Pressing the “BANK –” button will take you to BANK 01. As a default, the first active server will be displayed on the console monitor. Use the direct-access port selectors to go to the desired server on BANK 01.

AutoScan Mode

The AutoScan feature allows you to set your PRO3 KVM Switch to scan and monitor the activities of all connected servers one by one. The PRO3 KVM Switch remains on one server for a preset number of seconds, before switching to the next server. The time interval allotted for each server can be adjusted through the OSD menu (see the “Scan Time” section).

When the PRO3 KVM Switch is in AutoScan mode, it is also in view-only mode. This means that input from the console (keyboard and mouse) will not be transmitted to the server in focus. Cancel AutoScan to regain control of the server.

To activate the AutoScan function, press the AutoScan button on the PRO3 KVM Switch. You can also activate AutoScan on your keyboard by pressing “Scroll Lock”, “Scroll Lock”, “A”.

To stop AutoScan, press any button on the front panel or any key on the keyboard.

Note: There is no mouse or keyboard control in AutoScan mode. This is necessary to prevent data and synchronization errors. If the user is using the mouse or keyboard when the PRO3 KVM Switch is switching between ports, data flow may become interrupted and could result in erratic mouse movement and/or wrong-character input when using the keyboard.

1

2

3

4

5

6

7

8

section

On-Screen Display (OSD)

The OSD allows you to switch servers, assign names to your servers, start and stop the AutoScan feature, set the desired scan-time interval for AutoScan, enable the password security feature, and program hot keys. To access the OSD menu, press “Scroll Lock”, “Scroll Lock”, and the space bar. Immediately, the OSD screen will appear. The superimposed menu screen is generated by the PRO3 KVM Switch, and does not affect the function of your server, operating system, or software function.

Main OSD Page

P	O	R	T	N	A	M	E	
B	A	N	K	:	1			F 1 : M E N U
0	1	*	S	Y	S	T	E	F 2 : L O G O U T
0	2	*	S	Y	S	T	E	F 3 : P R E V
0	3	*	S	Y	S	T	E	E S C : Q U I T
0	4	*	S	Y	S	T	E	E N T E R : C O M P L E T E
0	5	*	S	Y	S	T	E	T / ↓ : S E L E C T
0	6	*	S	Y	S	T	E	P g U p / P g D n :
0	7	*	S	Y	S	T	E	B A N K S E L E C T
0	8	*	S	Y	S	T	E	U S E R :
								A D M I N I S T R A T O R
								S C A N T I M E :
								T I M E

The main OSD menu displays the current selected BANK and connected servers to that BANK. If you have only one PRO3 KVM Switch in your configuration, the OSD menu will display “BANK 00”. A “*” symbol indicates that the connected server is powered up.

OSD Keyboard Commands

(↑ ↓): Navigate to different servers in the same BANK

(Page Up/Page Down): Select next or previous BANK

(Enter): Switch servers, complete action

(F1): Takes you to options in the Main Menu page

(F2): Session logout

(F3): Takes you to previous screen when navigating through OSD

(Esc): Exits the OSD

To switch servers using the main OSD menu, use the arrow keys on your keyboard to navigate to the desired server, and press the “Enter” key. A “←” symbol indicates which server is currently being accessed on your console. To select a different BANK, press the “Page Up” or “Page Down” key to select the next BANK or the previous BANK.

Main Menu Page

The following “Main Menu” options are available only to the administrator.

M A I N M E N U	
S E L E C T O P T I O N :	
0 1	L A N G U A G E
0 2	P O R T N A M E E D I T
0 3	P O R T S E A R C H
0 4	U S E R S E T T I N G S
0 5	A C C E S S L I S T
0 6	H O T K E Y
0 7	A U T O S C A N T I M E

The “Main Menu” page allows you to:

- 01 - Set the language for the OSD
- 02 - Edit the naming of individual ports
- 03 - Search for a port by its name
- 04 - Assign user names and passwords
- 05 - Access security settings
- 06 - Change the hot-key trigger
- 07 - Set the AutoScan time interval

1

2

3

4

5

6

7

8

section

Main-Menu-Page Keyboard Commands

- (↑↓):: Navigate to the next field
- (Enter): To select an option
- (F3): Return to the main OSD menu
- (Esc): Exit OSD

Language

This allows you to select which language the OSD will display. You have eight languages to choose from:

- English
- French
- German
- Italian
- Spanish
- Simplified Chinese
- Japanese
- Russian

The default language is set to English. To designate a different language, use the arrow keys to navigate to the desired language field, and then press “Enter” to select and save the entry.

Port Name Edit

This option allows you to name each port with up to 10 characters. To name the port, use the arrow keys to navigate to the desired server port, and then press “Enter” to select and name the port. Press “Enter” again to save the entry.

User Setting

This option allows you to specify an administrator/user name and passwords to prevent unauthorized users from accessing the OSD and KVM Switch. One administrator and eight users can be stored. To add the name and password, use the arrow keys to navigate to the desired field, and then press “Enter” to select and edit. Press “Enter” again to save the entry. The maximum characters for the name and password fields are eight characters.

The default administrator name and password are:

Username: admin
Password: belkin

Access List

This feature allows you to discretely specify the user access at a port level. Only the administrator can set up the access list. The column on the left lists the port names. The users are listed by their number (1 to 8). Navigate to the user and port, and press the “Enter” key to enable/deny the access right for each user and port combination. “X” represents access is denied and “O” represents access is enabled.

Note: User name and password fields cannot be left blank. If two identical user names are entered, the first user-name password will apply.

Hot Key

This allows you to select which key will be used to initiate hot-key commands. You have nine key options to choose from:

- Scroll Lock
- Number Lock
- Caps Lock
- Left Ctrl
- Right Ctrl
- Left Alt
- Right Alt
- Left Win
- Right Win

The default key for all hot-key commands is “Scroll Lock” (see “Keyboard Hot-Key-Command Shortcuts” on the next page). To designate a different key to initiate hot-key commands, use the arrow keys to navigate to the “Hot Key” field, and then press “Enter” to select and save the entry.

AutoScan Time

This specifies the amount of time the PRO3 KVM Switch remains on a server before switching to the next server while in AutoScan mode. You can set the scan-time interval to anywhere between 05 and 99 seconds. To change the scan time, use the arrow keys to navigate to the “Scan Time” field and hit “Enter”, and then type the desired time interval (in seconds).

To enable AutoScan, refer to the hot-key section on page 29.

Note: The number keypad will not function in the OSD.

1

2

3

4

5

6

7

8

section

Keyboard Hot-Key-Command Shortcuts

Below is a complete list of hot-key commands that can be used for your PR03 KVM Switch:

Command	Function
Space Bar	Activate OSD
↑	Previous host
↓	Next host
[01,02,...,16] port	Non-daisy-chain KVM switch
[00,01,...,15] BANK	Daisy-Chain Config: First and second digit specifies BANK
[01,02,...,16] port	Daisy-Chain: Third and fourth digit specifies number
PgUP	Previous BANK
PgDown	Next BANK
B	Turn on/off beep while in AutoScan mode
S	Enable/disable OSD security
P	Turns console screen "Off", and prompts for user name and password if security is enabled
A	Administrator activates AutoScan
Delete	Administrator sets the OSD back to factory-default values (except for security settings)

Note: You will have approximately three seconds to complete each hot-key sequence.

Sun Combo and Mac® Key Mapping

The USB keyboard connected to the PRO3 KVM Switch does not support the Sun keypad to perform special functions in the Sun operating-system environment. When the KVM Switch is connected to a Sun server, the KVM Switch emulates the Sun keys using a set of key combinations called “combo keys”. Some Mac keys are also mapped. Please refer to the table below.

Windows USB Keyboard	Sun Micro USB Keyboard	Mac USB Keyboard
Caps Lock & L_Alt	Stop	
Caps Lock & L_Ctrl	Props	
Caps Lock & L_Shift (Application)	Compose	
Caps Lock & 1	Mute	
Caps Lock & 2	Volume down	
Caps Lock & 3	Volume up	
Caps Lock & F3	Find	
Caps Lock & F1	Front	
Caps Lock & F2	Open	
Caps Lock & F4	Again	
Caps Lock & F5	Undo	
Caps Lock & F8	Cut	
Caps Lock & F6	Copy	
Caps Lock & F7	Paste	
Caps Lock & F11	Help	
Caps Lock & F12	Power	Power
Windows key		Apple key
Alt		Option
Print Screen		F13
Scroll Lock		F14
Pause Break		F15

1

2

3

4

5

6

7

8

section

Updating Firmware

The PRO3 KVM Switch features flash-upgradeable firmware to ensure compatibility with the latest devices and servers. Firmware upgrades are free for the life of your PRO3 KVM Switch.

To update your firmware, download the appropriate firmware file and utility from www.belkin.com/support/. The utility will guide you through the process of updating the firmware on your PRO3 KVM Switch.

 **Warning!** We strongly recommend that you update your firmware only if you are experiencing mouse and keyboard problems with your PRO3 KVM Switch, as reconfiguring software may lead to unexpected operational problems. Please contact Belkin Technical Support if you need assistance.

To update the firmware, you will need the following items:

1. A separate server running Windows 2000, XP, or Vista. This server must NOT be connected to the server ports on the PRO3 KVM Switch.
2. An available serial port on the server.
3. A custom Serial Flash Cable (DB9 male-to-RJ11; included with purchase) that connects between the PRO3 KVM Switch and the server.

Q: What operating systems does the PRO3 KVM Switch support?

A: The PRO3 KVM Switch will support any operating system that runs on a PS/2 and USB platform. Operating systems include, but are not limited to, DOS; Windows 95, 98, 2000, Me, NT®, XP, 2003 Server, Vista; Sun; Linux; and Mac OS.

Q: Can I mix PS/2 and USB devices on the KVM console?

A: The PRO3 KVM Switch will support either all PS/2 or all USB devices on the console side at a time. It is recommended that you use a keyboard and mouse of the same platform.

Q: Can I mix PS/2 and USB servers on the host side?

A: Yes, the PRO3 KVM Switch will support any mix of PS/2 and USB host servers at a time.

Q: What does flash-upgradeable mean?

A: With flash-upgrade capability, you can update your PRO3 KVM Switch firmware at any time through a simple serial connection. Upgrade capability ensures that your PRO3 KVM Switch is always the most current version on the market with the latest features and enhancements. See the “Updating Firmware” section in this User Manual.

Q: Does the PRO3 KVM Switch support Microsoft IntelliMouse®?

A: The PRO3 KVM Switch supports USB and PS/2 mice from Microsoft, Logitech®, Kensington®, etc., and Belkin. Please contact Belkin Technical Support for compatibility issues you may experience.

Q: How does the PRO3 KVM Switch allow the user to switch between ports?

A: The PRO3 KVM Switch supports three methods of port selection. The user can select servers using specially designated keyboard hot keys, through the On-Screen Display, or can independently access the desired port by pushing the direct-access port selectors.

Q: How far can the server be from the PRO3 KVM Switch?

A: The PRO3 KVM Switch can be placed up to 25 feet away from your PS/2 server and up to 15 feet away from your USB server.

Q: What is the maximum video resolution that the PRO3 KVM Switch supports?

A: The advanced video circuit in the PRO3 KVM Switch supports a maximum resolution of up to 1920x1440@75Hz.

1

2

3

4

5

6

7

8

section

Q: Do I have to install any software to use the PRO3 KVM Switch?

A: No, the PRO3 KVM Switch does not require any drivers or software to be installed in your servers. Simply connect all your servers to the Belkin KVM Cable Kits, and then attach one keyboard, monitor, and mouse to the console port, and it is ready for use.

Q: Does the PRO3 KVM Switch require an AC adapter?

A: Yes, the PRO3 KVM Switch requires a 12-volt DC, 1-Amp power adapter in order to function properly.

Q: Can I use the PRO3 KVM Switch to switch video signals only?

A: No, the PRO3 KVM Switch must be connected to both the video and keyboard/mouse ports on your servers. The PRO3 KVM Switch detects the power from the PS/2 and USB ports on your servers in order to function.

Q: Can I use the PRO3 KVM Switch on my Sun server that supports USB?

A: Yes, the PRO3 KVM Switch works with any USB-capable server.

Q: Does the PRO3 KVM Switch support Linux?

A: Yes, the PRO3 KVM Switch works with Red Hat and other Linux distributions configured for PS/2 or USB support.

Q: How long is the warranty for the PRO3 KVM Switch?

A: The PRO3 KVM Switch comes with a 3-Year Limited Warranty.

My server does not boot up when connected to the PRO3 KVM Switch, but works fine when I connect the keyboard, video, and mouse directly to the server.

- Make sure that the keyboard and mouse cables are connected tightly between the Server Interface Module and the server.
- Check that the keyboard and mouse cables are not crossed.
- Check the cable connections.

I am getting ghosting, shadowing, or fuzzy images on my monitor.

- Check that all video cables are inserted properly to the Cable Kit.
- Check that the monitor you are using supports the resolution and refresh-rate setting on your server.
- Lower the video resolution of your monitor.
- Check that the cable length does not exceed 25 feet.
- Check that the graphics card you are using supports the resolution and refresh-rate setting on your server.
- Connect the monitor directly into the server you are having trouble with to see if the problem still appears.

I am getting a black screen on my monitor.

- Check that all video cables are inserted properly.
- Check that the keyboard cable is connected and inserted properly between the server the appropriate port on the KVM Switch.
- Move the mouse and see if it is necessary to log in as a user.
- Connect your monitor directly to the server to verify that your monitor is functioning properly.

The server does not detect a keyboard and I get a keyboard error reported at boot up.

- Check that the keyboard cable on the PRO3 KVM Switch is completely connected to your server. Tighten any loose connections.
- Check whether USB-keyboard legacy support is enabled in the system BIOS.
- If you are using the keyboard software that was included with your keyboard, uninstall it and then reinstall the standard Microsoft keyboard driver.

1

2

3

4

5

6

7

8

section

The mouse is lost when I switch to a different port.

- Check that the mouse you are using is connected properly to the console port of the PRO3 KVM Switch.
- Tighten any loose cable connections.
- If you are using a mouse driver that was included with your mouse, uninstall it and install the standard Microsoft mouse driver.
- Make sure the mouse works when directly plugged into the server.
- If the server is coming out of standby mode, allow up to one minute to regain mouse function.
- De-activate power-management schemes on the PC with which you are experiencing problems.
- Try a different mouse.

The mouse is not detected at boot up.

- Check the cables and make sure that they are inserted correctly.

The server boots up, but the mouse does not work.

- Make sure the mouse is plugged in properly.
- Make sure the mouse works when directly plugged into the server. Rebooting may be necessary when trying this.
- Try a different mouse.

When I switch from one port to another, mouse movement is completely erratic.

- Make sure you do not have more than one mouse driver installed. Make sure that the driver is either for a standard PS/2 or USB mouse, or a Microsoft server-compatible PS/2 or USB mouse.
- Make sure you do not have any mouse drivers loaded in your "CONFIG.SYS" or "AUTOEXEC.BAT" files.
- Avoid moving the mouse or pressing the mouse button when switching ports on the PRO3 KVM Switch.

USB

I am connecting the USB Cable Kit to a USB server, and my keyboard and mouse do not work.

- Prior to connecting the PRO3 KVM Switch, make sure that the HID USB driver is installed on each server. (To install the HID USB driver, connect a USB mouse and USB keyboard to the server. A Windows operating system should automatically install the drivers.)

Some of the keys on my keyboard are not functioning properly when I use a Mac server.

- If you are using a PC keyboard on a Mac system, a few of the option keys on your PC keyboard may be reversed. All major keys will function as labeled. Refer to the “Sun Combo and Mac Key Mapping” section in this User Manual.

Apple® startup keys such as C (to boot from CD), N (to boot from network), and F8 (to enter partition boot select menu) do not work.

- Currently these keys are not supported at boot. Connect a keyboard directly to the Apple system to select these options.

1

2

3

4

5

6

7

8

section

The following definitions are used throughout this User Manual.

AutoScan: A mode of operation where the KVM switch scans from one port to another, on an ongoing basis, as configured by the user.

BANK: The address of a daisy-chained KVM switch (00–15), set by the DIP switch.

Console: The all-in-one term for the keyboard, video monitor, and mouse connected to a KVM switch.

Console Port: Receptors for the console to connect to the KVM switch.

Control: When discussing switching between ports, control means that the console is capable of sending input to the server. Control requires that the console also has focus on the port, and is viewing it.

DDC: Short for Display Data Channel, a VESA standard for communication between a monitor and a video adapter. Using DDC, a monitor can inform a computer's video card about its properties, such as maximum resolution and color depth, to ensure that the user is presented with valid options for configuring the display.

Daisy-Chain: A configuration of multiple KVM switches that are connected one to another in a series. A KVM switch daisy-chain uses common settings to allow seamless, complex interactions between multiple consoles for control over many servers.

HID: Human Interface Device, the USB device class that includes keyboards and mice.

KVM: Literally “Keyboard Video Mouse”, this term refers to technology that allows two or more computers to be controlled by one keyboard, video monitor, and mouse; some switches that use KVM technology enable sharing of other peripherals such as audio speakers, microphones, and printers.

KVM Switch: A device that allows a user to access and control multiple servers from a single console. It has at least one console port and multiple server ports.

OSD: On-Screen Display, a Graphical User Interface that can be used to control and configure the KVM switch.

Port: An interface receptor on a server through which you can attach a device or plug in a device cable.

Primary KVM Switch: The KVM switch that is connected to the console and is set to BANK address 00.

Secondary KVM Switch: Any KVM switch that is daisy-chained to the primary KVM switch and is set to BANK address 01–15 (and has no console connected).

FCC Statement

DECLARATION OF CONFORMITY WITH FCC RULES FOR ELECTROMAGNETIC COMPATIBILITY

We, Belkin International, Inc., of 501 West Walnut Street, Compton CA 90220, declare under our sole responsibility that the products:

F1DA104Z, F1DA108Z, F1DA116Z

to which this declaration relates:

Comply with Part 15 of the FCC Rules. Operation is subject to the following two conditions:

- (1) this device may not cause harmful interference, and
- (2) this device must accept any interference received, including interference that may cause undesired operation.

CE Declaration of Conformity

We, Belkin International, Inc., declare under our sole responsibility that the products F1DA104Z, F1DA108Z, F1DA116Z, to which this declaration relates, are in conformity with Emissions Standard EN55022 and with Immunity Standard EN55024, LVP EN61000-3-2, and EN61000-3-3.

ICES

This Class B digital apparatus complies with Canadian ICES-003. Cet appareil numérique de la classe B est conforme à la norme NMB-003 du Canada.

Belkin International, Inc., Limited 3-Year Product Warranty

What this warranty covers.

Belkin International, Inc. ("Belkin") warrants to the original purchaser of this Belkin product that the product shall be free of defects in design, assembly, material, or workmanship.

What the period of coverage is.

Belkin warrants the Belkin product for three years.

What will we do to correct problems?

Product Warranty.

Belkin will repair or replace, at its option, any defective product free of charge (except for shipping charges for the product).

What is not covered by this warranty?

All above warranties are null and void if the Belkin product is not provided to Belkin for inspection upon Belkin's request at the sole expense of the purchaser, or if Belkin determines that the Belkin product has been improperly installed, altered in any way, or tampered with. The Belkin Product Warranty does not protect against acts of God (other than lightning) such as flood, earthquake, war,

1

2

3

4

5

6

7

8

section

vandalism, theft, normal-use wear and tear, erosion, depletion, obsolescence, abuse, damage due to low voltage disturbances (i.e. brownouts or sags), non-authorized program, or system equipment modification or alteration.

How to get service.

To get service for your Belkin product you must take the following steps:

1. Contact Belkin International, Inc., at 501 W. Walnut St., Compton, CA 90220, Attn: Customer Service, or call (800)-223-5546, within 15 days of the Occurrence. Be prepared to provide the following information:
 - a. The part number of the Belkin product.
 - b. Where you purchased the product.
 - c. When you purchased the product.
 - d. Copy of original receipt.
2. Your Belkin Customer Service Representative will then instruct you on how to forward your receipt and Belkin product and how to proceed with your claim.

Belkin reserves the right to review the damaged Belkin product. All costs of shipping the Belkin product to Belkin for inspection shall be borne solely by the purchaser. If Belkin determines, in its sole discretion, that it is impractical to ship the damaged equipment to Belkin, Belkin may designate, in its sole discretion, an equipment repair facility to inspect and estimate the cost to repair such equipment. The cost, if any, of shipping the equipment to and from such repair facility and of such estimate shall be borne solely by the purchaser. Damaged equipment must remain available for inspection until the claim is finalized. Whenever claims are settled, Belkin reserves the right to be subrogated under any existing insurance policies the purchaser may have.

How state law relates to the warranty.

THIS WARRANTY CONTAINS THE SOLE WARRANTY OF BELKIN. THERE ARE NO OTHER WARRANTIES, EXPRESSED OR, EXCEPT AS REQUIRED BY LAW, IMPLIED, INCLUDING THE IMPLIED WARRANTY OR CONDITION OF QUALITY, MERCHANTABILITY OR FITNESS FOR A PARTICULAR PURPOSE, AND SUCH IMPLIED WARRANTIES, IF ANY, ARE LIMITED IN DURATION TO THE TERM OF THIS WARRANTY.

Some states do not allow limitations on how long an implied warranty lasts, so the above limitations may not apply to you.

IN NO EVENT SHALL BELKIN BE LIABLE FOR INCIDENTAL, SPECIAL, DIRECT, INDIRECT, CONSEQUENTIAL OR MULTIPLE DAMAGES SUCH AS, BUT NOT LIMITED TO, LOST BUSINESS OR PROFITS ARISING OUT OF THE SALE OR USE OF ANY BELKIN PRODUCT, EVEN IF ADVISED OF THE POSSIBILITY OF SUCH DAMAGES.

This warranty gives you specific legal rights, and you may also have other rights, which may vary from state to state. Some states do not allow the exclusion or limitation of incidental, consequential, or other damages, so the above limitations may not apply to you.

1

2

3

4

5

6

7

8

section

BELKIN®

OmniView® PR03 KVM Switch

BELKIN®

www.belkin.com

Belkin Tech Support

US: 800-223-5546 ext. 2263

310-898-1100 ext. 2263

UK: 0845 607 77 87

Australia: 1800 235 546

New Zealand: 0800 235 546

Singapore: 65 64857620

Europe: www.belkin.com/support

Belkin International, Inc.

501 West Walnut Street

Los Angeles, CA 90220, USA

310-898-1100

310-898-1111 fax

Belkin Ltd.

Express Business Park, Shipton Way

Rushden, NN10 6GL, United Kingdom

+44 (0) 1933 35 2000

+44 (0) 1933 31 2000 fax

Belkin B.V.

Boeing Avenue 333

1119 PH Schiphol-Rijk, The Netherlands

+31 (0) 20 654 7300

+31 (0) 20 654 7349 fax

Belkin Ltd.

4 Pioneer Avenue

Tuggerah Business Park

Tuggerah, NSW 2259, Australia

+61 (0) 2 4350 4600

+61 (0) 2 4350 4700 fax

Free Manuals Download Website

<http://myh66.com>

<http://usermanuals.us>

<http://www.somanuals.com>

<http://www.4manuals.cc>

<http://www.manual-lib.com>

<http://www.404manual.com>

<http://www.luxmanual.com>

<http://aubethermostatmanual.com>

Golf course search by state

<http://golfingnear.com>

Email search by domain

<http://emailbydomain.com>

Auto manuals search

<http://auto.somanuals.com>

TV manuals search

<http://tv.somanuals.com>