



GDV-870

High Definition DVD-Audio/Video Player

User's Manual



Congratulations

Congratulations on your purchase of the Adcom GDV-870

You have made a wise choice that will reward you with exceptionally accurate video and audio reproduction for years to come. To realize the full potential of your new DVD player, please read these operating and installation instructions thoroughly before attempting to make any connections to it.

The GDV-870 is not only designed to reproduce the highest quality sound and picture but also to deliver the greatest possible value. It is our engineers' passion for perfection that has enabled our components to be judged the equivalent of others costing two, three, or even five times as much. Our engineering team consistently strives to develop and design products that will exceed your expectations. Our goal at Adcom is to let more consumers hear high-end quality sound and see high-end video without paying high-end prices.

All Adcom components are the result of a long-standing dedication to innovation, quality, simplicity, and value. Adcom: We have the power — and now, so do you!

Thank you from the Adcom Team



CAUTION
RISK OF ELECTRIC SHOCK
DO NOT OPEN



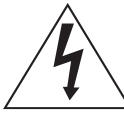

This symbol is intended to alert the user to the presence of uninsulated dangerous voltage within the product's enclosure that may be of sufficient magnitude to constitute risk of fire or electric shock.



This symbol is intended to alert the user to the presence of important operating and maintenance instructions in the literature accompanying this product.

PORTABLE CART WARNING
(Symbol provided by RETAC)

Do not place this unit on an unstable cart, stand, tripod, bracket, or table. The unit may fall, causing serious injury to a child or adult, and serious damage to the unit. Use only with a cart, stand, tripod, bracket, or table recommended by the manufacturer or sold with the unit. Any mounting of the device should follow the manufacturer's instructions, and should use a mounting accessory recommended by the manufacturer.

Copyrights/Trademarks

Published by Adcom
Copyright © 2006 Adcom, LLC
All rights reserved

Adcom and the Adcom logo are registered trademarks of Adcom, LLC.

This unit is manufactured under license from Dolby Laboratories Licensing Corporation. It is additionally licensed under one or more of the following patents: U.S. number 3,959,GTP-880, Canadian numbers 1,004,603 and 1,037,877.

Dolby® Pro Logic®, Dolby ProLogic II®, Dolby Digital EX®, and Dolby Digital® are registered trademarks of Dolby Laboratories Licensing Corporation.

Manufactured under license from Digital Theater Systems, Inc. US Patent Number 5,451,942 and other world-wide patents issued and pending. "DTS®," "dts®," "DTS Digital Surround®," "DTS-ES®," "DTS NEO:6®" are trademarks of Digital Theater Systems, Inc. Copyright 2003 Digital Theater Systems, Inc. All rights reserved.

HDMI, the HDMI logo and High-Definition Multimedia Interface are trademarks or registered trademarks of HDMI Licensing LLC.

No part of this manual may be reproduced or electronically transmitted without the express written consent of Adcom, LLC.

Chapter 1 - Welcome

Introduction	5
Unpacking the GDV-870	5
Key Features.....	5
Placing the GDV-870	6
About the Remote Control	6
Front Panel Overview	7
Remote Control Overview	8
Rear Panel Overview	10

Chapter 2 - Connections

Connections Overview	11
Before You Begin	11
Composite/S-Video Connections	12
Component/Progressive Scan	12
HDMI Connections	13
2-Channel Audio Connections.....	13
Digital Audio Connections	14
5.1-Channel Audio Connections.....	14
Control Connections	15
Power Connections	16

Chapter 3 - Setup

Setup Overview	17
Setup Menu Navigation	18
Language Settings	19
Video Settings.....	20
Audio Settings.....	21
Rating Settings	23
Miscellaneous Settings	24

Chapter 4 - Operations

Operations Overview.....	25
Basic DVD Playback.....	26
Special Playback Features A to Z.....	27
Audio CD Playback	29
MP3 Playback	29
JPEG/Picture CD Playback.....	29
DivX/MPEG4 Playback	29
Program Playback.....	30
Screen Saver.....	30

Chapter 5 - Help

Customer Support	31
Adcom Protection Plan	31
Product Care & Maintenance	31
System Reset	31
Troubleshooting.....	32
Technical Specifications	33
Index	34

Important Safety Instructions

- Read all the safety and operating instructions before connecting or using this unit.
- Retain this notice and the owner's manual for future reference.
- All warnings on the unit and in its operating instructions should be adhered to.
- All operating and use instructions should be followed.
- Do not use this unit near water. For example, near a bathtub, washbowl, kitchen sink, laundry tub, in a wet basement, or near a swimming pool.
- The unit should be installed so that its location or position does not interfere with its proper ventilation. For example, it should not be situated on a bed, sofa, rug, or similar surface that may block the ventilation openings; or placed in a built-in installation, such as bookcase or cabinet, that may impede the flow of air through its ventilation openings.
- The unit should be situated away from heat sources such as radiators, heat registers, stoves, or other devices (including amplifiers) that produce heat.
- The unit should be connected to a power supply outlet only of the voltage and frequency marked on its rear panel.
- This Class I apparatus shall be connected to a MAINS socket outlet with a protective earthing connection.
- As the plug is used as the disconnect device, the disconnect device shall remain readily operable.
- The power supply cord should be routed so that it is not likely to be walked on or pinched, especially near the plug, convenience receptacles, or where the cord exits from the unit.
- Clean unit only as recommended in its instruction manual.
- The power supply cord of the unit should be unplugged from the wall outlet when it is to be unused for a long period of time and during electrical storms.
- Care should be taken so that objects do not fall, and liquids are not spilled, into the enclosure through any openings.
- This unit should be serviced by qualified service personnel when:
 - a. The power cord or the plug has been damaged; or
 - b. Objects have fallen, or liquid has been spilled, into the unit; or
 - c. The unit has been exposed to rain, or liquids of any kind; or
 - d. The unit does not appear to operate normally, or exhibits a marked change in performance; or
 - e. The device has been dropped, or the enclosure damaged.

WARNING

TO REDUCE THE RISK OF FIRE OR ELECTRIC SHOCK, DO NOT EXPOSE THIS UNIT TO RAIN OR MOISTURE.

CAUTION

TO PREVENT ELECTRIC SHOCK DO NOT USE THIS POLARIZED PLUG WITH AN EXTENSION CORD, RECEPTACLE OR OTHER OUTLET UNLESS THE BLADES CAN BE FULLY INSERTED TO PREVENT BLADE EXPOSURE.

THERE ARE NO USER SERVICEABLE PARTS IN THIS PRODUCT. DO NOT ATTEMPT SERVICING OF THIS UNIT YOURSELF. REFER SERVICING TO QUALIFIED SERVICE PERSONNEL.

LASER SAFETY

This compact disc player is classified as a CLASS 1 LASER PRODUCT. Only qualified service personnel should remove the cover or attempt to service this device due to possible eye injury. Invisible laser radiation when open and interlock failed or defeated. Avoid direct exposure to beam.

CAUTION POWER LINES

Any outdoor antenna must be located away from all power lines.

Regulatory Information

FCC Part 15 This product has been tested and found to comply with the limits for a Class B digital device, pursuant to Part 15 of the FCC Rules. These limits are designed to provide reasonable protection against harmful interference when the product is operated in a residential installation. This product generates, uses, and can radiate radio frequency energy and, if not installed and used in accordance with the instruction manual, may cause harmful interference to radio communications. However, there is no guarantee that interference will not occur in a particular installation. If this product does cause harmful interference to radio or television reception, which can be determined by turning the product off and on, the user is encouraged to try to correct the interference by one or more of the following measures:

- Reorient or relocate the receiving antenna.
- Increase the separation between the product and receiver.
- Connect the product into an outlet on a circuit different from that to which the receiver is connected.
- Consult the dealer or an experienced radio/TV technician for help.

OUTDOOR ANTENNA GROUNDING

If an outside antenna is connected to your tuner or tuner/pre-amplifier, be sure the antenna system is grounded so as to provide some protection against voltage surges and built-up static charges. Section 810 of the National Electrical Code, ANSI/NFPA No. 701984, provides information with respect to proper grounding of the mast and supporting structure, grounding of the lead-in wire to an antenna discharge unit, size of grounding conductors, location of antenna discharge unit, connection to grounding electrodes, and requirements for the grounding electrode.

- a. Use No.10 AWG (5.3 mm²) copper, No.8 AWG (8.4 mm²) aluminum, No.17 AWG (1.0 mm²) copper clad steel or bronze wire, or larger, as a ground wire.
- b. Secure antenna lead-in and ground wires to house with standoff insulators spaced from 46 feet (1.221.83 m) apart.
- c. Mount antenna discharge unit as close as possible to where lead-in enters house.
- d. Use jumper wire not smaller than No.6 AWG (13.3 mm²) copper, or the equivalent, when a separate antenna grounding electrode is used. See NEC Section 810-21 (j).

EXAMPLE OF ANTENNA GROUNDING AS PER NATIONAL ELECTRICAL CODE INSTRUCTIONS CONTAINED IN ARTICLE 810. RADIO AND TELEVISION EQUIPMENT.

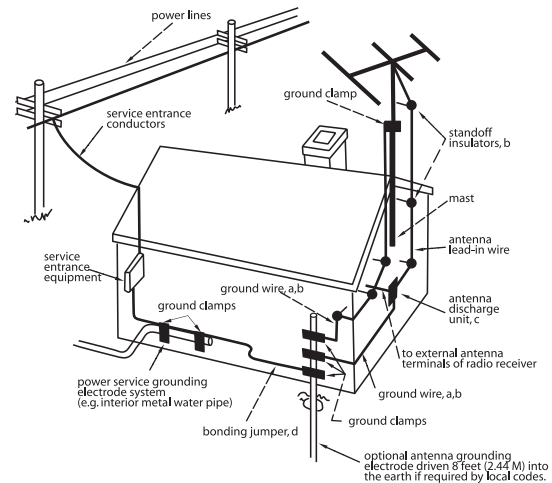

NOTE TO CATV SYSTEM INSTALLER

This reminder is provided to call the CATV system installer's attention to Article 82022 of the National Electrical Code that provides guidelines for proper grounding and, in particular, specifies that the cable ground shall be connected to the grounding system of the building, as close to the point of cable entry as practical.

Chapter 1 - Welcome

Introduction

Congratulations on your decision to purchase the Adcom GDV-870 DVD player. The GDV-870 delivers a multitude of audio/video output options, including:

- Progressive scan 480p video with field-adaptive deinterlacing from the component video output
- Pure, all-digital HD video (up to 1080i) from the HDMI output
- Analog HD video from the component output
- Direct multichannel analog outputs even connect you to high-resolution stereo and multichannel playback for your DVD-Audio material

The front panel of the GDV-870 is designed for ease of operation. All controls are logically grouped for intuitive operation. Basic operations can be performed from the front panel, while additional features can be accessed with the provided remote control.

Familiarize yourself with the diagrams that follow and read the short explanations of each feature below. When you finish, you will be well on your way to enjoying the GDV-870's convenience, performance, and quality.

Unpacking the GDV-870

Before you begin, please take a moment to make



sure the following items were included with your GDV-870:

- GDV-870
- Remote control
- 1.5V AAA batteries (2)
- Audio/video cable
- Power cord
- Warranty card & statement
- User's Guide CD

Key Features

Video Features

- HDMI (High Definition Multimedia Interface) output for full-bandwidth digital audio and video over a single cable
- Compatible with NTSC and PAL video hardware plus standard (4:3) and wide-screen (16:9) aspect ratios
- Progressive scan with reverse 3:2 pulldown for film sources
- Special playback functions such as frame-by-frame, zoom, and variable slow-motion and high-speed play
- DVD-Video features include multi-angle, multi-language subtitles, and multi-language audio

Audio Features

- Supports the following digital audio formats:
 - Dolby Digital®
 - DTS® (Digital Theater Systems)
 - DTS® 96/24
 - DVD-Audio
 - MLP® (Meridian Lossless Packing)
 - MP3 (MPEG 1, Layer 3)
 - MPEG Multichannel
 - Linear PCM
- Supported audio formats include sampling frequencies up to 192 kHz, linear PCM encoding up to 24-bit resolution, and MLP
- DVD-Audio supports up to six channels at sample rates of 48, 88, 96, 176, or 192 kHz and sample sizes of 16, 20, or 24 bits
- DVD Video supports 2 channels at sample rates of 48 and 96 kHz and sample sizes of 16, 20, or 24 bits
- Audio CD/Video CD is limited to 2 channels, 44.1 kHz at 16 bits
- Audio outputs include multichannel (5.1) analog audio outputs, stereo analog outputs and both coaxial and optical digital audio outputs
- Linear Power Supply

Special Features for Custom Installation

- 12V trigger
- Rear panel IR mini jack (3.5mm)
- Discrete power On/Off

Placing the GDV-870

Place the GDV-870 on a stable, vibration-free surface away from moisture and out of direct sunlight. Your Adcom dealer will be pleased to show you many different types of audio/video equipment racks and cabinets.

Be sure to leave sufficient room behind the rear panel to accommodate cables, power cords, etc. We recommend a minimum of 5 inches of free space for maximum flexibility.

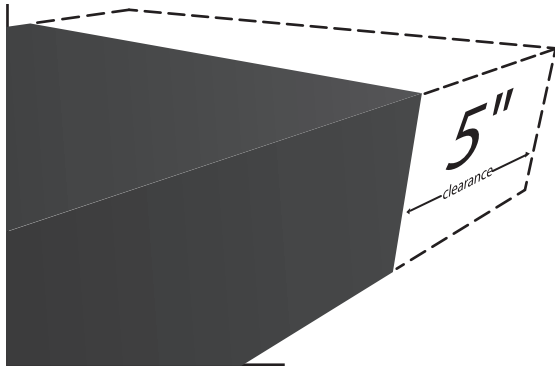

A distance of 1/2" should be maintained around the GDV-870 for ventilation. Keep your GDV-870 in a room where temperatures remain fairly moderate, and never cover it with table cloths, curtains, newspapers, etc., to avoid potential overheating.

About the Remote Control

The GDV-870 comes with a full-featured, preprogrammed, ergonomically designed remote control.

- For an overview of each remote button, see page 8.

Inserting the Remote Batteries

- 1 Remove the cover on the back panel of the remote control.
- 2 Insert two AAA alkaline batteries, paying attention to the correct polarities.
- 3 Replace the cover.

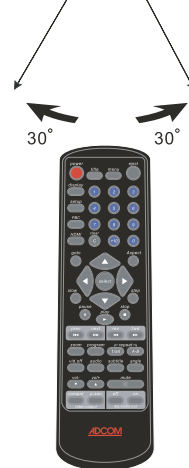
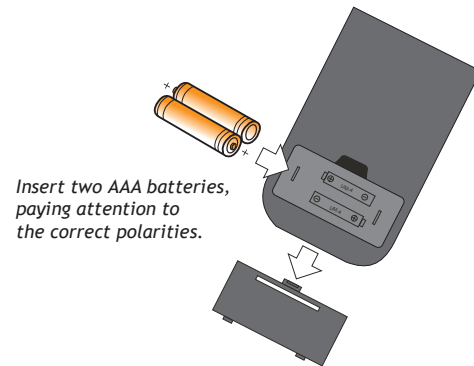

Front Panel Overview

The following is an overview of the GDV-870 front panel.

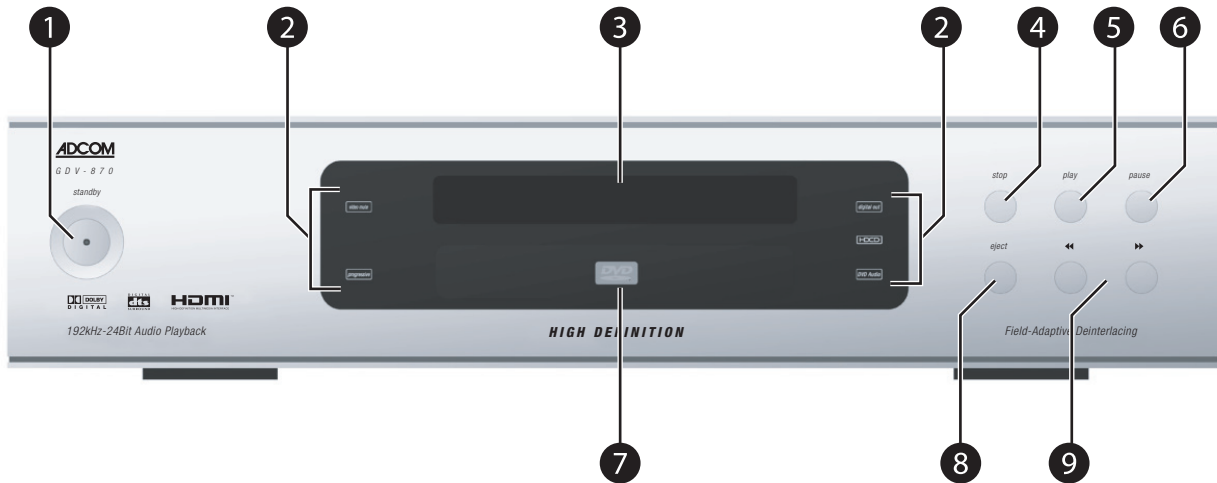

1 Standby button

Powers the GDV-870 on and off (Standby mode).

- The rear panel power switch must be in the on position (I) for this button to function.
- The Power LED is amber when the unit is in Standby mode.
- The Power LED is red when the unit is on.

2 Status Indicators

Provides a quick visual cue that one or more of the following conditions are active:

- **Video Mute** - Activated by pressing the Vid. Off button on the remote control during CD playback.
- **Progressive Scan** - Activated by setting Video Out to P-Scan in the Setup Menu.
- **Digital Out** - Activated by pressing the Dig Audio Out On button on the remote control.
- **HDCD** - Activated by loading an HDCD-encoded disc.
- **DVD Audio** - Activated by loading a DVD Audio disc.

3 Front panel display

Displays GDV-870 status information.

4 Stop button

Stops disc playback.

- Press the Stop button once to stop and hold playback at the current position.
- Press the Stop button twice to reset playback to the beginning of the disc.

5 Play button

Starts disc playback.

- Pressing the Play button in Standby mode powers on the player.

6 Pause button

Pauses disc playback.

- Pressing the Step button in Pause mode advances the picture one frame at a time.

7 Disc Tray

Use to load/unload discs.

- Press the Eject button on the front panel or remote control to open/close the disc tray.

8 Eject button

Opens and closes the disc tray.

9 Skip Prev/Next buttons

Skips to the previous or next chapter (or track) during disc playback.

Remote Control Overview

The following is a brief overview of the GDV-870 remote control buttons and their operations.

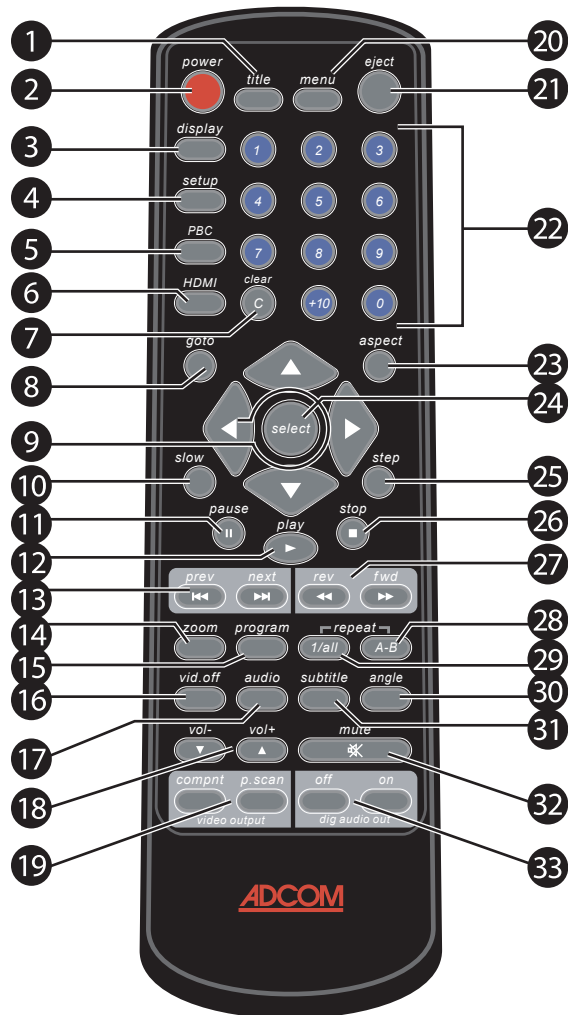

- 1 **Title button**
Displays the DVD title menu (if available).
- 2 **Power button**
Powers the GDV-870 on and off (Standby mode).
 - The rear panel power switch must be in the on position (I) for this button to function.
- 3 **Display button**
Brings up the On-Screen Display.
 - The On-Screen Display shows the disc type, chapter/track number, elapsed/remaining time, and other relevant disc status information.
- 4 **Setup button**
Displays the GDV-870 Setup Menu.
- 5 **PBC button**
Displays the Playback Control (PBC) menu of a Video CD.
- 6 **HDMI button**
Sets the video output resolution. This button is only applicable if:
 - Video Out is set to HD in the Setup Menu.
 - The player is connected to an HD-compatible display device via the HDMI (digital) or Component (analog) outputs.
- 7 **Clear button**
Deletes entries in Setup Menus and on-screen displays.
- 8 **Go To button**
Jumps directly to a specified title, chapter/track, or time on a disc.
- 9 **Arrow buttons**
Use to navigate and make selections within DVD disc menus, Setup Menus, and other on-screen displays.
- 10 **Slow button**
Starts slow-motion playback.
- 11 **Pause button**
Pauses disc playback.
 - Pressing the Step button in Pause mode advances the picture one frame at a time.
- 12 **Play button**
Starts playback.
 - Pressing the Play button in Standby mode powers on the player.

- 13 Skip Prev/Next buttons**
Skips to the previous or next chapter (or track) during disc playback.
- 14 Zoom button**
Zooms in during playback.
- 15 Program button**
Programs a customized chapter or track order.
- 16 Video Off button**
Turns off the video display during CD playback.
- 17 Audio button**
Selects among available audio tracks during DVD playback.
- 18 Volume +/- buttons**
Adjusts the player's volume level.
- 19 Video Output (Component/Progressive Scan) buttons**
Sets the format of the Video signal from the Component Video Outputs to Component or Progressive Scan.
- 20 Menu button**
Displays the DVD disc menu (if available).
- 21 Eject button**
Opens/closes the disc tray to load/unload discs.
- 22 Number (0-9, 10+) buttons**
Use to enter numerical data in Setup Menus and on-screen displays.
 - Also use for direct selection of chapters and tracks during playback.
- 23 Aspect button**
Changes the display view to Fill, Original, Auto Fit, or Pan Scan; see View Mode on page 20 for details.
- 24 Select button**
Makes selections in DVD disc menus, Setup Menus, and other on-screen displays.
- 25 Step button**
Pauses playback and steps forward one frame at a time.
- 26 Stop button**
Stops disc playback.
 - Press the Stop button once to stop and hold playback at the current position.
 - Press the Stop button twice to reset playback to the beginning of the disc.
- 27 Reverse/Forward buttons**
Scans backwards and forwards at variable speeds during playback.
- 28 A-B Repeat button**
Loops playback between two points.
- 29 Repeat 1/All button**
Selects among various repeat modes during disc playback.
- 30 Angle button**
Selects among available playback angles during DVD playback.
- 31 Subtitle button**
Selects among available subtitle languages during DVD playback.
- 32 Mute button**
Mutes and unmutes the audio during playback.
- 33 Digital Audio Out (On/Off) buttons**
Enables/disables the audio signal from the rear panel Digital Audio Outputs.

Notes:

- *If you press a button that is currently unavailable, the Ⓞ symbol appears on screen with an explanatory message, e.g. "Not allowed at the moment."*

Rear Panel Overview

The following is an overview of the GDV-870 rear panel.

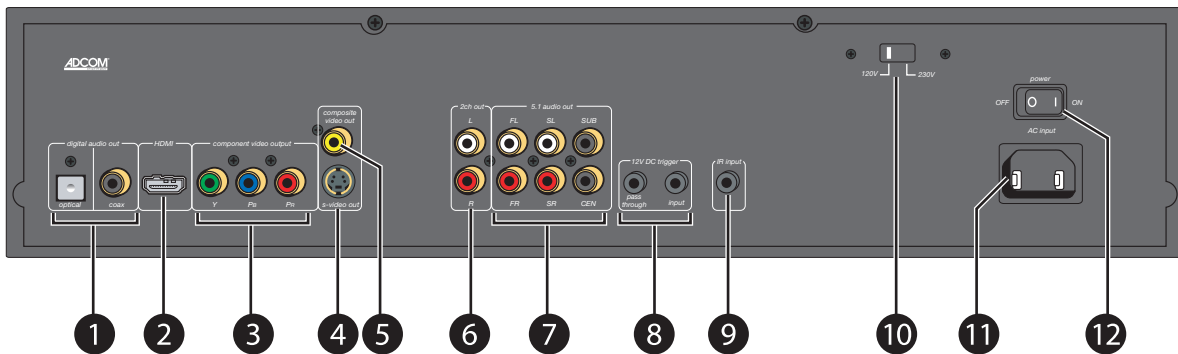

1 Digital audio output

- **Optical** - Connects to the optical digital audio input of your AV preamp.
- **Coaxial** - Connects to the coaxial digital audio input of your AV preamp.

2 HDMI output

- Connects to the HDMI input of an HDMI-compatible AV preamp or display device.

3 Component video output

- **Y/Pb/Pr** - Connects to the Component/Progressive Scan/HD inputs of a TV, AV preamp, or display device.

4 S-Video output

- Connects to the S-Video input of a TV, AV preamp, or display device.

5 Composite video output

- Connects to the Composite video input of a TV, AV preamp, or display device.

6 2-channel audio output

- **L/R** - Connects to the audio inputs of a TV, AV preamp, or stereo receiver/amplifier.

7 5.1 audio output

- **FL/FR/SL/SR/S/C** - Connects to the 5.1-channel input of your AV preamp.

8 12V DC trigger

- **Pass through** - Connects to an external device with a 12V DC trigger input (e.g. to automatically power on a motorized screen).
- **Input** - Connects to an external device with a 12V DC trigger output (e.g. to automatically power on the GDV-870).

9 IR input

Connects to an IR remote sensor (e.g. to control the GDV-870 if the front panel display is obstructed).

10 Voltage switch

Sets the GDV-870 voltage to 120V (U.S. standard) or 230V (international standard).

11 AC input

Connects the GDV-870 to a standard electrical outlet using the supplied power cord.

12 Main power switch

Switches the GDV-870's main power on and off.

Chapter 2 - Connections

Connections Overview

Adcom provides every conceivable connection to integrate the GDV-870 with your home theater system. We recommend that you choose the best video and audio options compatible with your particular display device and sound system.

Video Connections

- Composite video12
- S-Video.....12
- Component video12
- Progressive Scan video12
- HDMI13

Audio Connections

- 2-channel analog audio.....13
- Coaxial digital audio14
- Optical digital audio14
- 5.1-channel analog audio.....14

Power/Control Connections

- 12V DC triggers15
- IR sensor15
- Power connections.....16

Before You Begin

Before you begin connecting the GDV-870, it is recommended that you read all instructions, including the instructions for each device you plan to connect.

- **DO NOT CONNECT THE GDV-870 POWER CORD OR POWER ON THE GDV-870 UNTIL ALL CONNECTIONS ARE COMPLETE. CONNECTING OR DISCONNECTING DEVICES WHILE THE PLAYER AND/OR DEVICES ARE POWERED ON CAN RESULT IN SEVERE DAMAGE TO THE PLAYER AND/OR THE CONNECTED DEVICES.**

About Video Cables

- **Video cable**
Use for composite video connections to standard TVs and display devices. Match yellow to yellow.
- **S-Video cable**
Use for higher quality video connections to standard TVs and display devices.
- **Component video cables**
Use for best quality analog video connections to digital and Progressive Scan TVs and display devices. Match green, blue, and red respectively.
- **HDMI cables**
Use for superior, all-digital audio/video quality to and from HDMI compatible components.

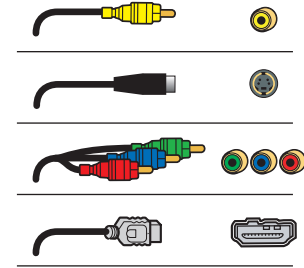

About Audio Cables

- **RCA Cables**
Use for 2-channel and 5.1-channel analog audio connections. Match red to red and white to white.
- **Digital coaxial cable**
Use for high-quality multi-channel digital audio connections.
- **Digital optical cable** (aka "Toslink")
Use as an alternative to coaxial cable for digital audio connections.

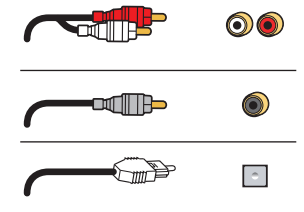

Composite/S-Video Connections

Composite Video Connections

Composite video is used in nearly all consumer video devices. We recommend using this output only when S-Video or Component Video inputs are not available.

- 1 Using a standard video cable, connect the composite video output on the GDV-870 to the composite video input on your display device.

S-Video Connections

S-Video delivers a better picture than composite video connections.

- 1 Using an S-Video cable, connect the S-Video output on the GDV-870 to the S-Video input on your display device.

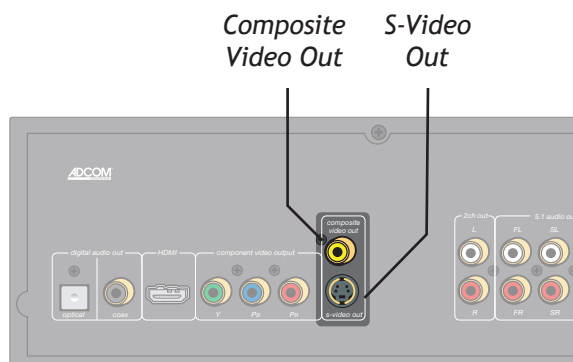

Notes:

- *Composite/S-Video is the default video setting for the GDV-870 – no additional configuration is necessary.*
- *To view the Composite/S-Video output, select the corresponding Video or S-Video input on your display device.*

Component/Progressive Scan

Component/Progressive Scan Connections

Component video is the best available analog connection method to an HDTV display. If your display supports Progressive Scan or HD analog, the picture quality is even more impressive.

- 1 Using a set of Component video cables, connect the Y/Pb/Pr outputs on the GDV-870 to the corresponding Y/Pb/Pr inputs on your display device.
 - Be sure to match the red, green, and blue connectors accordingly.

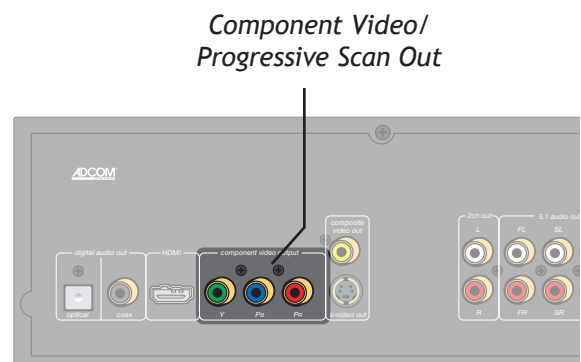

Notes:

- *You must set the Video Output to Component, P-Scan or HD in the GDV-870 Setup Menu; see page 20.*
- *To view the Component/Progressive Scan output, select the corresponding Component Video input on your display device.*

HDMI Connections

About HDMI

HDMI, or High Definition Multimedia Interface, is an advanced audio/video connection method that transfers full-bandwidth digital audio and video signals over a single cable.

As a result, digital signals can pass unfettered from your GDV-870 to an HDMI-compatible display for superior picture and sound quality.

Connecting HDMI Components

- Using an HDMI cable, connect the HDMI output on the GDV-870 to the corresponding HDMI input on your digital display device.

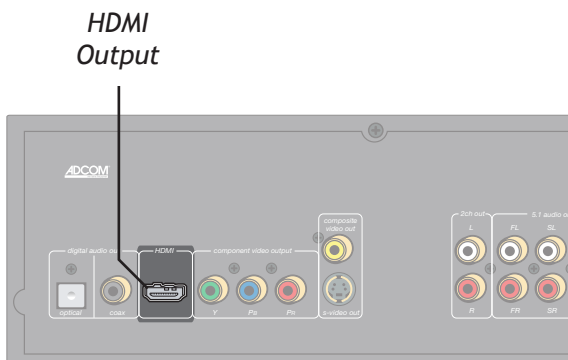

Notes:

- You must have an HDMI display device to view HDMI signals from the DVD player.
- You must set the Video Output to HD in the GDV-870 Setup Menu; see page 20.
- You should also set the HD Resolution to match the native resolution of your display; see page 20.
- To view the HDMI output, select the corresponding HDMI input on your display device.

2-Channel Audio Connections

Connecting Analog Audio

Using the analog audio output allows the internal DSP and DACs to decode and convert the data from the disc to analog signals.

This output is used when connecting the player to an analog stereo preamp, and is necessary for use in many distributed audio setups. This output can also make use of analog direct modes available on many Adcom preamplifiers.

- Using RCA cables, connect the audio outputs on the GDV-870 to the audio inputs on your display device or receiver.
 - Be sure to match the red (right) and white (left) connectors accordingly.

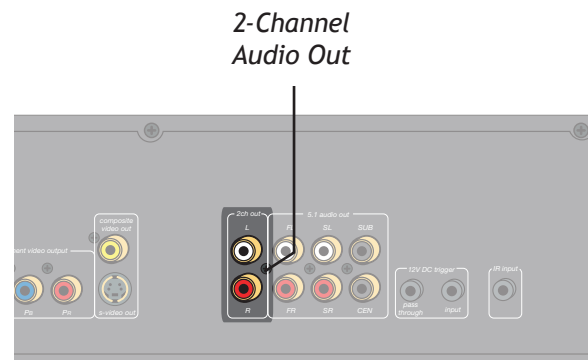

Notes:

- No configuration is necessary for the 2-Channel Audio Out.
- To listen to the 2-Channel Audio Out, select the corresponding input on your display device or receiver.

Digital Audio Connections

Connecting Digital Audio

The GDV-870 features two digital audio outputs—one coaxial and one optical—to send multi-channel Dolby Digital and DTS sound tracks from your DVD player to your AV preamp/surround sound processor.

- 1 Connect digital audio cable(s).
 - Using a digital coaxial audio cable, connect the coaxial output on the GDV-870 to the corresponding coaxial input on your AV preamp.
 - Alternatively, use an optical (Toslink) cable to connect the optical output on the GDV-870 to the corresponding optical input on your AV preamp.

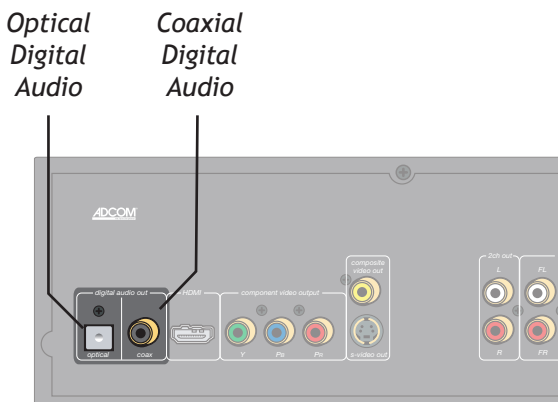

Notes:

- To configure the digital audio output, see pages 21-22.
- To listen to the Digital Audio Out, select the corresponding input on your AV preamp.
- To enjoy surround sound movies, your AV preamp must be able to decode Dolby Digital and/or DTS digital signals.

5.1-Channel Audio Connections

Connections for 5.1-Channel Audio Playback

To enjoy high-resolution, multi-channel audio playback, connect the six RCA jacks on the back of the GDV-870 to the 5.1 analog input on your preamp.

- 1 Using six RCA cables, connect the 5.1-channel audio outputs from the GDV-870 to the corresponding 5.1 inputs on your AV preamp.

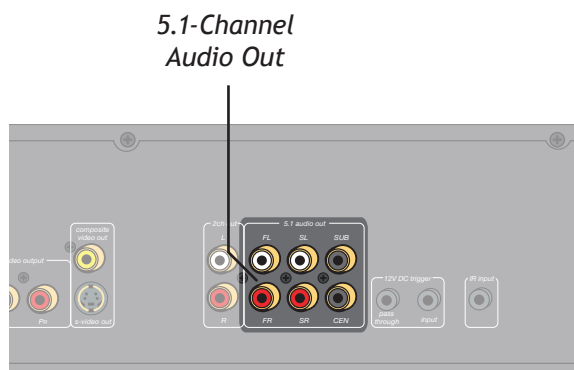

Notes:

- To listen to the 5.1 Channel Audio Out, select the corresponding input on your AV preamp.
- Due to copy protection issues, the digital output may need to be off during playback of DVD-Audio discs.

Control Connections

Trigger Connections

The 12V DC trigger provides a convenient way to power on your player in synch with the rest of your home theater system.

- Use the trigger input with your preamp to turn the GDV-870 on and off automatically.
 - Use the trigger pass through to control an additional device in your system.
- 1 Using a cable with dual 3.5mm mono mini-plugs, connect the 12V DC trigger input on the GDV-870 to the 12V DC trigger output on your preamp.
 - 2 Optionally, use a second cable with dual 3.5mm mono mini-plugs to connect the 12V DC trigger pass through on the GDV-870 to the 12V DC trigger input on a compatible device (e.g., a motorized screen or another AV component).
 - 3 Confirm the triggers are working.
 - Power on your preamp.
 - The GDV-870 and any connected devices should power on automatically.

Remote IR Sensor Connections

Use the IR input jack to connect an external IR sensor to the GDV-870 if the unit is behind cabinet doors or otherwise not visible to the remote.

- 1 Obtain a remote IR sensor.
 - Choose a remote IR sensor from an electronics distributor that suits your particular installation needs.
 - Install the remote IR sensor according to the manufacturer's instructions.
- 2 Connect the remote IR sensor's 3.5mm mono mini-plug to the IR input on the back panel of the GDV-870.
- 3 Confirm the IR sensor is working.
 - Conceal the GDV-870 front panel and attempt to control the unit by pointing the remote at the remote IR sensor.

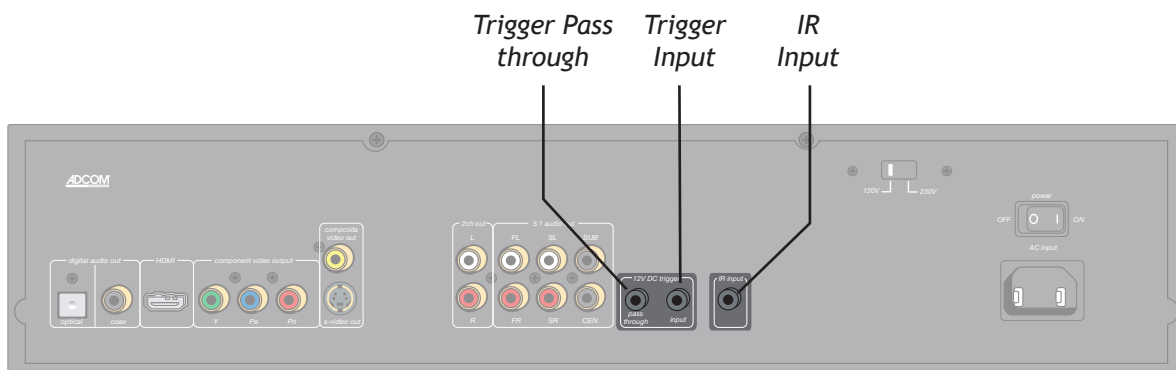

Notes:

- The 12V DC trigger is simply a "trigger" and not a relay driver. Some motorized screens will require an outboard device to be used in association with the 12V DC trigger. See the screen manufacturer's instructions or ask your dealer or distributor.

Power Connections

When all connections are complete, you're ready to check the voltage switch, plug in the power cable, and power on the GDV-870.

Checking the Voltage Switch

Before plugging in the unit, make sure the voltage is set to your country's voltage configuration. The GDV-870 should be unplugged prior to flipping this switch. If you are uncertain, please have your installer or dealer verify before proceeding.

- To prevent damage to your equipment, make sure the rear panel voltage switch is set correctly for your geographic region.
 - Select 120V for U.S. and Canada.
 - Select 230V for EU and Australia operation.
 - For other regions, check with your local authorities.

Connecting the Power Cable

Use to connect the supplied IEC removable AC power cord. Before proceeding, please observe all precautions when connecting devices to your new GDV-870.

- Connect the supplied power cable to the AC input and plug it into an electrical outlet.

Turning on the Power

Setting this button to the on position (I) supplies power to the unit, enabling use of the Standby button on the front panel. When the main power switch is in the off position, current is cut off to the unit.

- Turn on the main power switch.
 - This switch effectively connects or disconnects the GDV-870 from the AC power source.

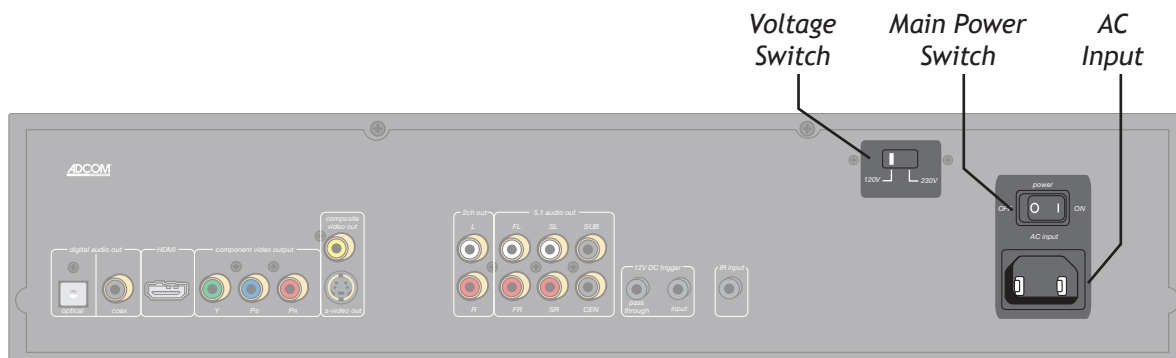
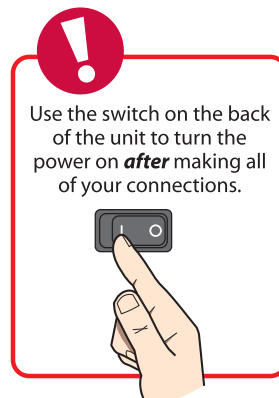

Notes:

- Caution:** Before you plug the power cord into an AC wall outlet, confirm that all connections to the GDV-870 have been made correctly.
- Warning:** Never disconnect the power cord from the GDV-870 while the other end is plugged into an AC outlet. Doing so may cause an electric shock. Always connect power by plugging into the AC outlet last and disconnect by unplugging from the AC outlet first.
- Do not use a power cord other than the one supplied with the GDV-870. It is designed for use with the GDV-870 and should not be used with any other device.

Setup Menu Navigation

Use the following remote control buttons to navigate the Setup Menu.

- **Setup** - Press the Setup button to display and exit the Setup Menu.
- **Arrows** - Press the \blacktriangle / \blacktriangledown buttons to move the highlight up and down the list of menu items. Press the \blacktriangleleft / \blacktriangleright buttons to move the highlight left and right.
- **Select** - Press the Select button to confirm your menu selections.

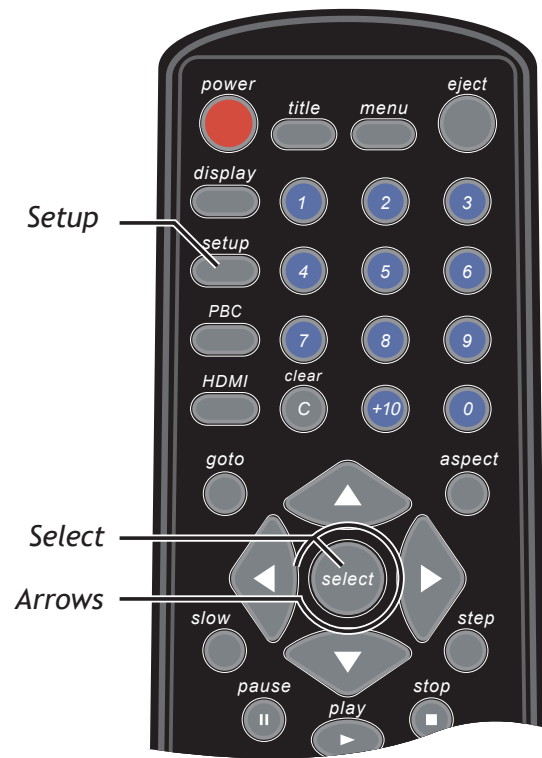

Language Settings

To access the Language Settings menu:

- 1 Press the Setup button.
- 2 Use the ▲/▼ buttons to select Language, then press the ► button.
- 3 Use the ▲/▼ buttons to choose from the following menu items:

OSD Language

Sets the language for the GDV-870 Setup Menu and on-screen displays.

- Use the ▲/▼ buttons to select English, Français, or Español.

Subtitle

Sets the default language for DVD subtitles.

- Use the ▲/▼ buttons to select English, French, Spanish, Auto, or Off.
 - Select “Auto” if you want the player to automatically select the disc’s default subtitle language.
 - Select “Off” if you prefer not to view subtitles.

DivX Subtitles

Sets the default character set for DivX subtitles.

- Use the ▲/▼ buttons to select Unicode (UTF-8), Western European, Turkish, Central European, Cyrillic, Greek, Hebrew, Arabic, Baltic, or Vietnam.

Audio

Sets the default language for DVD audio sound tracks.

- Use the ▲/▼ buttons to select English, French, or Spanish.

DVD Menu

Sets the default language for DVD disc menus.

- Use the ▲/▼ buttons to select English, French, or Spanish.

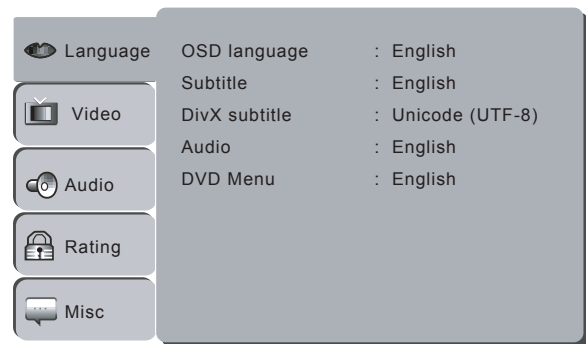

Video Settings

To access the Video Settings menu:

- 1 Press the Setup button.
- 2 Use the ▲/▼ buttons to select Video, then press the ► button.
- 3 Use the ▲/▼ buttons to choose from the following menu items:

Aspect Ratio

Sets the aspect ratio of the GDV-870 to match your display device.

- Use the ▲/▼ buttons to select 4:3 or 16:9.
 - Select “4:3” if you are using a standard 4:3 display device.
 - Select “16:9” if you are using wide-screen 16:9 display device.

View Mode

Sets your preferred method of scaling video content to your display.

- Use the ▲/▼ buttons to select Fill, Original, Auto Fit (default), or Pan Scan.
 - Select “Fill” to expand video content to the full dimensions of the screen.
 - Select “Original” to leave all video content as it is originally presented on the disc.
 - Select “Auto Fit” to automatically detect the optimum presentation of your video content.
 - Select “Pan Scan” to crop widescreen movies to fit on a 4:3 screen.

TV System

Sets the TV system of your display device.

- Use the ▲/▼ buttons to select NTSC, PAL, or Multi.
 - Select “NTSC” if your display is NTSC compatible.
 - Select “PAL” if your display is PAL compatible.
 - Select “Multi” if your display handles both NTSC and PAL signals.

Video Out

Sets the video output signal to match your display device and connection method.

- Use the ▲/▼ buttons to select Component, P-Scan, or HD.
 - Select “Component” if you used the Component video outputs to connect your display device AND your display only accepts a standard definition (NTSC/PAL) video signal.
 - Select “Progressive” if you used the Component video outputs to connect your display device AND your display accepts a progressively scanned video signal.

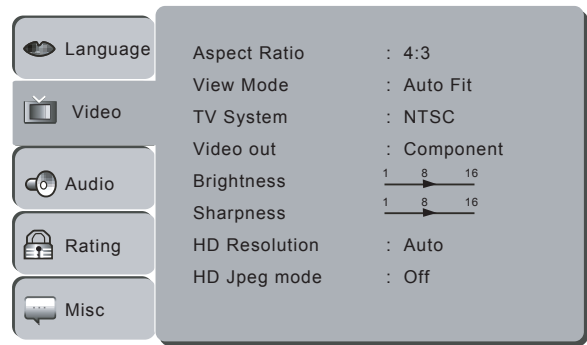

- Select “HD” if you used the Component video outputs and/or the HDMI output to connect your display device AND your display accepts a High Definition video signal.

Brightness

Adjusts picture brightness.

- Use the ◀/▶ buttons to set the brightness from 1-16.

Sharpness

Adjusts picture sharpness.

- Use the ◀/▶ buttons to set the sharpness from 1-16.

HD Resolution

Sets the resolution of the HD video signal to match the capabilities of your display device.

- Use the ▲/▼ buttons to select 480p/576p, 720p, 1080i, 1024x768, or 1360x768.
- HD Resolution is only selectable if Video Out is set to HD.

HD JPEG Mode

Enables or disables high-definition JPEG playback. HD JPEG Mode is only selectable if Video Out is set to “HD.”

- Use the ▲/▼ buttons to select On or Off.

Notes:

- Use the Video Out buttons as a shortcut to switch between Component and Progressive Scan.

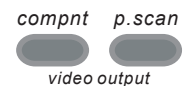

- Use the HDMI button as a shortcut to change the HD Resolution.



Audio Settings

To access the Audio Settings menu:

- 1 Press the Setup button.
- 2 Use the $\blacktriangle/\blacktriangledown$ buttons to select Audio, then press the \blacktriangleright button.
- 3 Use the $\blacktriangle/\blacktriangledown$ buttons to choose from the following menu items:

Bass Management

Enables or disables bass management. Bass management automatically steers low-frequency signals to their optimal speaker depending on your speaker configuration settings.

- Use the $\blacktriangle/\blacktriangledown$ buttons to select On or Off.

Front Speakers

Sets the relative size of your front speakers.

- Use the $\blacktriangle/\blacktriangledown$ buttons to select Small or Large.
 - Select “Small” if you DO have a subwoofer.
 - Select “Large” if you do NOT have a subwoofer.

Center Speakers

Sets the relative size of your center speaker (if applicable).

- Use the $\blacktriangle/\blacktriangledown$ buttons to select Small, Large, or None.
 - Select “Small” if you DO have a subwoofer.
 - Select “Large” if you do NOT have a subwoofer.
 - Select “None” if you do not have a center speaker.

Surround Speakers

Sets the relative size of your surround speakers (if applicable).

- Use the $\blacktriangle/\blacktriangledown$ buttons to select Small, Large, or None.
 - Select “Small” if you DO have a subwoofer.
 - Select “Large” if you do NOT have a subwoofer.
 - Select “None” if you do not have surround speakers.

Subwoofer

Indicates the presence of a subwoofer.

- Use the $\blacktriangle/\blacktriangledown$ buttons to select None or Present.
 - Select “Present” if you DO have a Subwoofer.
 - Select “None” if you do NOT have a Subwoofer.

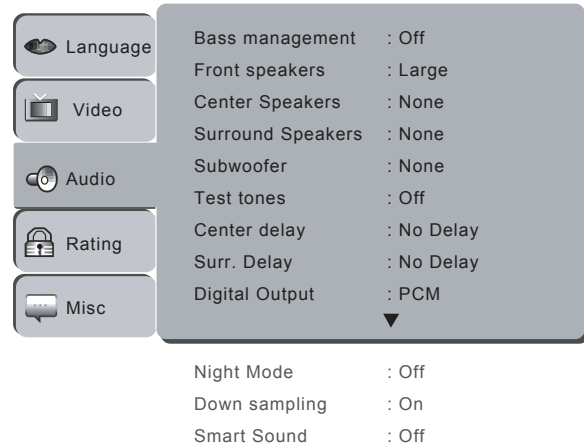

Test Tones

Generates a “pink noise” test tone that you can move manually from speaker to speaker. This neutral tone provides an effective gauge to measure volume levels that is more objective than a movie sound track or other variable signal.

- Use the $\blacktriangle/\blacktriangledown$ buttons to select Off, Left, Right, Center, Left surr., Right surr., or Subwoofer
 - If you select a speaker by name, the test tone will be heard in that speaker.
 - If you select “Off,” the current audio source will be heard instead of the test tone.

Center Delay

Delays the sound from your center speaker if it is closer to your primary listening area than your front speakers.

- Use the $\blacktriangle/\blacktriangledown$ buttons to select 0.3m (1 ft.), 0.5m (2 ft.), 1m (3 ft.), 1.3m (4 ft.), 1.7m (5 ft.).
 - Measure the distance from your primary listening area to your front speakers (A).
 - Measure the distance from your primary listening area to your center speaker (B).
 - Subtract B from A.
 - The GDV-870 will add 1 ms of delay for every foot of difference.

Surround Delay

Delays the sound from your surround speakers if they are closer to your primary listening area than your front speakers.

- Use the $\blacktriangle/\blacktriangledown$ buttons to select 1m (3 ft.), 2m (6 ft.), 3m (9 ft.), 4m (12 ft.), 5.1m (15 ft.).
 - Measure the distance from your primary listening area to your front speakers (A).
 - Measure the distance from your primary listening area to your surround speakers (C).
 - Subtract C from A.
 - The GDV-870 will add 1 ms of delay for every foot of difference.

Audio Settings (cont.)

Digital Audio Output

Sets the audio signal from the coaxial and optical digital audio outputs.

- Use the ▲/▼ buttons to select Off, PCM, or All.
 - Select “Off” if you are not using the digital audio outputs.
 - Select “PCM” (or Pulse Code Modulation) if the digital audio output is connected to a 2-channel digital AV preamp.
 - Select “All” if the digital audio output is connected to an AV preamp with a Dolby Digital or DTS surround sound processor.

Night Mode

Reduces the dynamic range (the difference between the softest and loudest audio portions) of a DVD sound track. This is a convenient feature for watching movies late at night.

- Use the ▲/▼ buttons to select On or Off.

Down Sampling

Down samples high definition audio signals if your AV preamp is not capable of decoding them.

- Use the ▲/▼ buttons to select On or Off.
 - Select “On” if your preamp is NOT capable of handling 96 kHz signals. The DVD Player will automatically down sample any 96 kHz signals to 48 kHz so your system can decode them.
 - Select “Off” if your preamp is capable of handling 96 kHz signals. The DVD Player will pass the signal through without any further processing.

Smart Sound

Provides a variety of preset tone control options by musical genre.

- Use the ▲/▼ buttons to select Off, Classical, Rock, Jazz, or Pop.

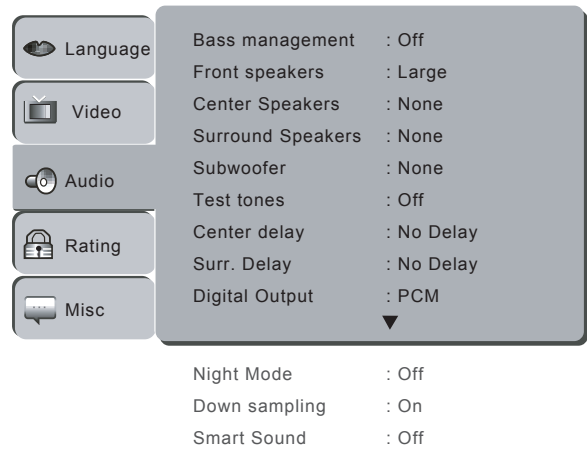

Notes:

- You can use the Digital Audio Out buttons as a shortcut to enable/disable the digital audio signal.



Rating Settings

The GDV-870 includes a password-protected Parental Control feature that prevents playback of discs based on their MPAA ratings.

To access the Rating Settings menu:

- 1 Press the Setup button.
- 2 Use the \blacktriangle / \blacktriangledown buttons to select Rating, then press the \blacktriangleright button.
- 3 Use the \blacktriangle / \blacktriangledown buttons to choose from the following menu items:

Parental Control

Selects the desired rating level.

- Use the \blacktriangle / \blacktriangledown buttons to select Parental Control and press Select.
- Use the number keys (0-9) to enter your 4-digit password and press Select.
- If you have not yet set a password, enter the default password (8-8-8-8) and press Select.
- Press Select again to show the list of Parental Control ratings.
- Use the \blacktriangle / \blacktriangledown buttons to select one of the following ratings and press Select:
 - 1. Kid Safe
 - 2. G
 - 3. PG
 - 4. PG-13
 - 5. PG-R
 - 6. R
 - 7. NC-17
 - 8. Adult
- Playback of movies at or above the selected rating will be blocked.

Set Password

Sets the Parental Control password.

- You must enter the default password (8-8-8-8) before you can set your own password.
- Use the 0-9 buttons to enter a new 4-digit password and press Select.
- Your personal password and the default password will both work to unlock the Parental Control feature.

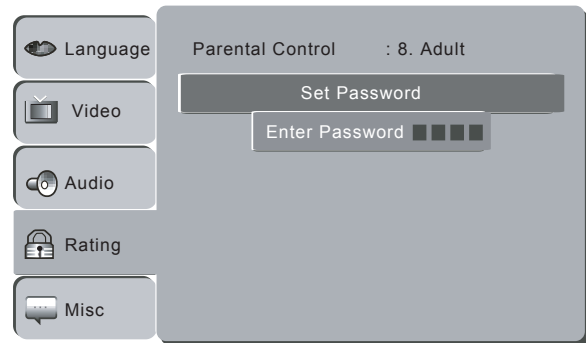

Notes:

- *Not all movies are rated.*
- *Write down your password and keep it in a safe place in case you forget it.*
- *If you forget your password, the factory password is 8888.*

Miscellaneous Settings

To access the Miscellaneous Settings menu:

- 1 Press the Setup button.
- 2 Use the ▲/▼ buttons to select Misc, then press the ► button.
- 3 Use the ▲/▼ buttons to choose from the following menu items:

Use Default Settings

Restores the GDV-870 to its original factory settings (except for the Parental Control password).

- Select “Use Default Settings” and press Select.
- When prompted with the confirmation message “Use Default Settings,” use the ◀/▶ buttons to select “Yes” and press Select.
- The unit will restart with the original factory settings restored.

DVD Priority

Optimizes the player for DVD Audio or DVD Video playback.

- Use the ▲/▼ buttons to select DVD Audio or DVD Video.

DivX Registration

Displays the DivX® Video On Demand registration code for your particular GDV-870 player.

- For more information, log onto:
<http://www.divx.com/vod>

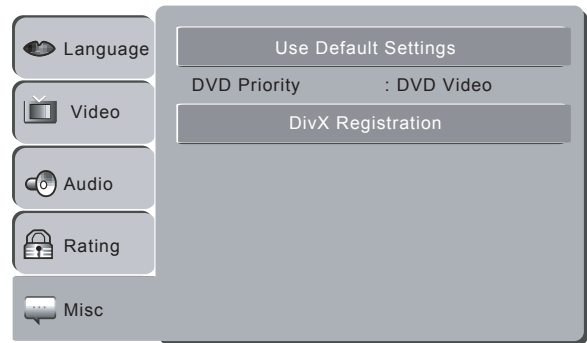

Chapter 4 - Operations

Operations Overview

Now that you've connected and configured your GDV-870, it's time for the fun part—enjoying the full power and performance of your Adcom DVD player. This chapter covers:

- Basic DVD Playback 26
- Special Playback Features A to Z 27
- Audio CD Playback 29
- MP3 Playback 29
- JPEG/Picture CD Playback 29
- Divx/MPEG4 Playback 29
- Program Playback 30
- Screen Saver 30



Basic DVD Playback

Follow these steps to play a DVD.

Playing a DVD

- 1 Before you begin:
 - Power on the GDV-870.
 - Power on your TV or display device.
 - Power on your AV preamp.
 - Select the input on your TV and/or AV pre-amp corresponding to the GDV-870.
- 2 Open the disc tray.
 - Press the Eject button on the remote control (or front panel) to open the disc tray.
- 3 Load your disc.
 - Insert the disc with the label side up.
 - Press the Eject button again to close the disc tray.
- 4 Play the disc.
 - Most discs will begin playback automatically when loaded. The disc type will appear in the top left corner of the screen.
 - If the disc does not play, press the Play button.
 - If the DVD disc menu appears, use the Arrow buttons to highlight the desired option, then press Select.
- 5 Adjust the volume.
 - Use the Volume +/- buttons to adjust the volume level.
 - Press the Mute button to temporarily mute the audio.
- 6 Pause or Stop playback.
 - Press the Pause button to freeze playback. Press Play to resume.
 - Press the Stop button once to stop and hold playback at the current playback position. Press Play to resume.
 - Press the Stop button twice to stop and reset the disc from the beginning.
- 7 Eject the disc.
 - Press the Eject button to open the disc tray and remove your disc.
- 8 Power off the player.
 - Press the Power button to turn off the player. You should always power off the player after use.

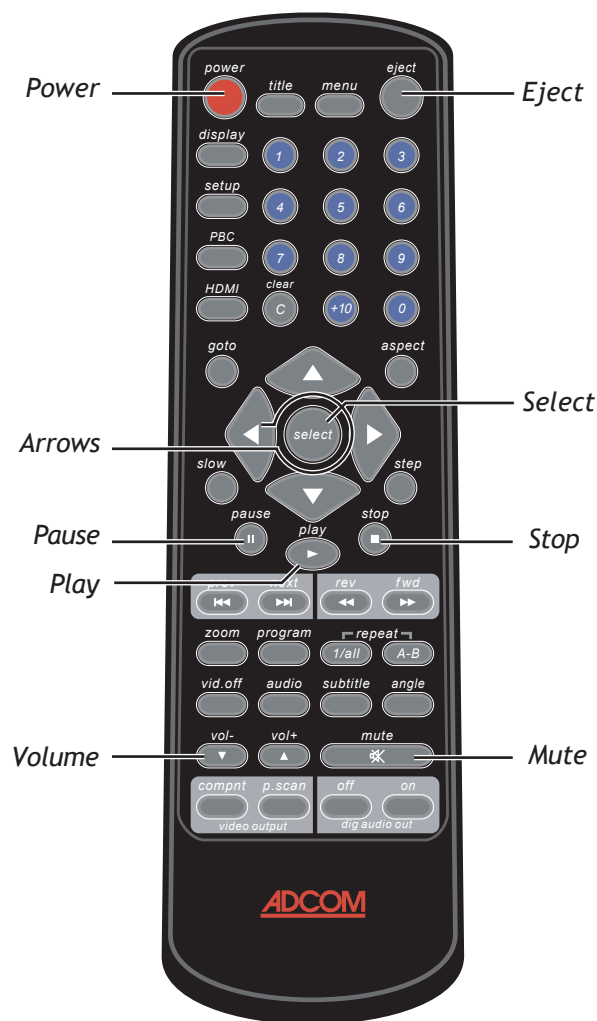

Special Playback Features A to Z

angle

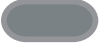

Angle

Press the Angle button repeatedly during DVD playback to view additional viewing angles (if available). A DVD can have up to nine selectable viewing angles.

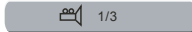

aspect



Aspect

Press the Aspect button during playback to change the display view to Fill, Original, Auto Fit, or Pan Scan; see View Mode on page 20 for details.

audio



Audio

Press the Audio button repeatedly during DVD playback to select alternative audio tracks (if available). A DVD can have up to 8 audio language selections.



goto



Go To

Press the Go To button to display the Search menu. Use the ▲/▼ buttons to choose Title, Chapter, or Time. Use the 0-9 keys to enter the desired destination, then press Select. Press Clear to delete your entry.

display



Display

Press the Display button to view current disc information. For example, during DVD playback, pressing Display will show the disc type, title number, chapter number, elapsed time, remaining time, audio language, subtitle language, angle, and bitrate.

menu



Menu

Press the Menu button to return to the DVD disc menu. Disc menus often include scene selection, set up options, and special bonus features.



Number Buttons

During playback, use the number keys to jump directly to the desired chapter or track. For chapters 10 or higher, use the 10+ button; e.g. for chapter 25, press 10+, 10+, 5.

PBC



PBC

If the disc is in VCD 2.0 format, press the PBC button to view the playback control menu. Then use the 0-9 keys to select the desired track.

program



Program

Press the Program button to display the Program menu and set up a custom playback order. See page 30 for details.

1/all



Repeat (1/All)

Press the Repeat 1/All button to repeat a Title, Chapter/Track, or disc.

Special Playback Features A-Z (cont.)

A-B

Repeat (A-B)

Loops playback between two points. Press the A-B button once to set point A. Press the A-B button a second time to set point B and begin loop playback. Press the A-B button a third time to cancel A-B Repeat. The clip should be at least 3 seconds.

Rep A-B

rev



fwd



Search Buttons

Press repeatedly to search forward/backward at x2, x4, x8, and x16 normal speed. Press Play to resume normal playback. The player is muted in Search mode.

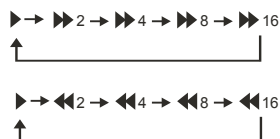

prev



next



Skip Buttons

Press the Prev and Next buttons to skip forward/backward one chapter/track at a time. Note that the player will not skip the WARNING section of a disc.

slow



Slow

Press repeatedly to for slow motion playback at 1/2, 1/4, 1/6, and 1/8 normal speed. Press Play to resume normal playback. The player is muted in Search mode.

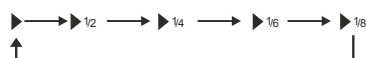

step



Step

Press the Step button to freeze playback. Then press the Step button repeatedly to step forward one frame at a time.

subtitle



Subtitle

Press the Subtitle button repeatedly during DVD playback to select alternative subtitle languages (if available). A DVD can have up to 32 subtitle selections.

1 / 2

title



Title

Press the Title button to return to the DVD title menu (the first track on a DVD disc). Some DVD discs refuse the disc title function.

vid.off



Video Off

During CD playback, press the Vid. Off button to turn off the video display and protect your screen from possible burn-in.

zoom



Zoom

During DVD or JPEG Picture CD playback, press the Zoom button repeatedly to magnify the on-screen image in three levels. While the image is zoomed, you can use the Arrow buttons to move around the image.

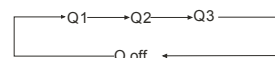

Audio CD Playback

Basic Audio CD Playback

- 1 Load the Audio CD in the disc tray.
 - The disc will begin playback automatically.
- 2 Press the Prev and Next buttons to browse the CD tracks.
- 3 Press the Stop button to stop playback.
- 4 For additional playback options, see the figure below.

MP3 Playback

Basic MP3 Playback

- 1 Load the MP3 disc in the disc tray.
- 2 Use the Arrow keys to select the desired folder/file and press Select to start playback.
- 3 Press the Prev and Next buttons to browse the MP3 tracks.
- 4 Press the Stop button to stop MP3 playback.
- 5 For additional playback options, see the figure below.

JPEG/Picture CD Playback

Basic JPEG/Picture CD Playback

- 1 Load the JPEG disc in the disc tray.
- 2 Use the Arrow keys to select the desired folder/file and press Select to start the slideshow.
- 3 Press the Prev and Next buttons to browse the slideshow.
- 4 During the slideshow, use the Arrow keys to rotate pictures clockwise/counter-clockwise.
- 5 Press the Title button to switch to thumbnail view.
- 6 Press the Stop button to stop the slideshow.
- 7 For additional playback options, see the figure below.

DivX/MPEG4 Playback

DivX/MPEG4 Playback

- 1 Load the DivX/MPEG4 disc in the disc tray.
- 2 Use the Arrow keys to select the desired folder/file and press Select to start playback.
- 3 Press the Prev and Next buttons to browse the video files.
- 4 Press the Stop button to stop playback.
- 5 For additional playback options, see the figure below.

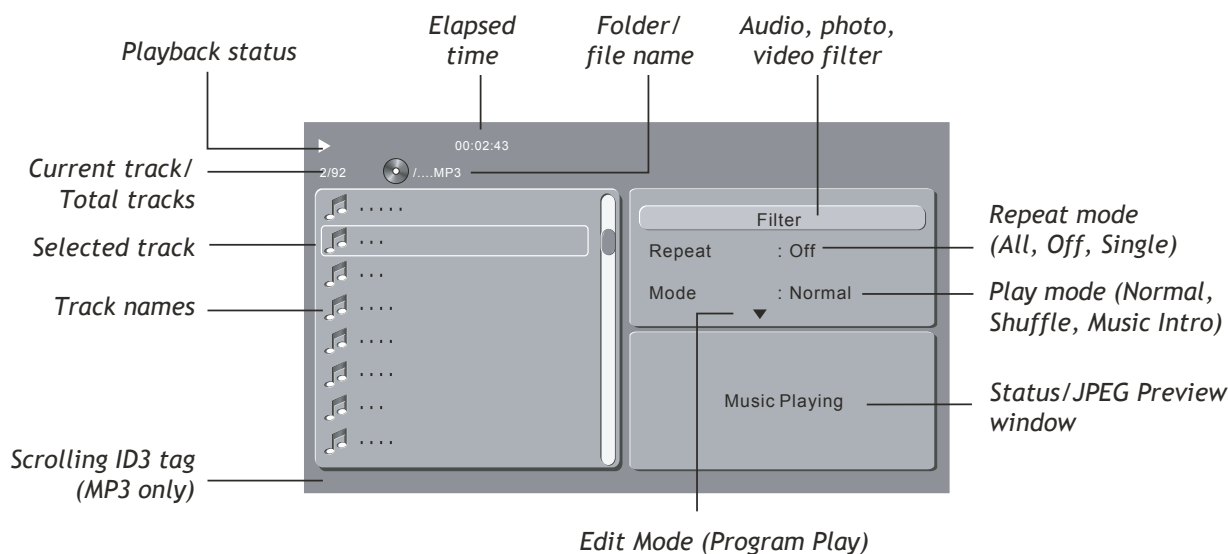

Notes on MP3/JPEG/MPEG4 Playback:

- Discs can have mixed MP3, JPEG, and MPEG4 files. Use the Filter function to view one or more file types.
- It may take several minutes to load a disc, depending on the number of files and/or folders.
- For Program playback, see page 30.

Program Playback

DVD/VCD Program Playback

- 1 Load a DVD or VCD.
- 2 Press the Program button to display the Program menu.
- 3 Highlight the desired title/chapter and press Select to add it to your program.
 - If you make a mistake, press Clear to delete the last programmed title.
- 4 Repeat Step 2 until you have added up to 16 titles to your program.
- 5 Move the cursor to Play and press Select to play your custom program.
 - To delete the program, move the cursor to Clear All and press Select.

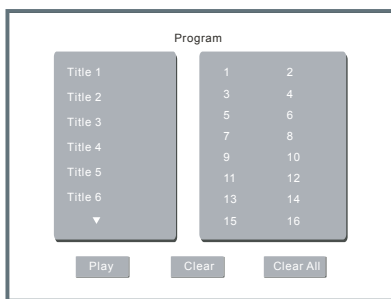

CD/MP3 Program Playback

- 1 Load a CD or MP3 disc.
- 2 Highlight Edit Mode and press Select.
- 3 Highlight the desired track and press Select.
 - A check mark appears to the left of the track name.
 - If you make a mistake, press Select again to uncheck the track.
- 4 Repeat Step 3 until you have checked up to 10 tracks.
- 5 Highlight Add to Program and press Select.
 - The checked tracks will be added to your program.
- 6 To view your program, highlight Program View and press Select.

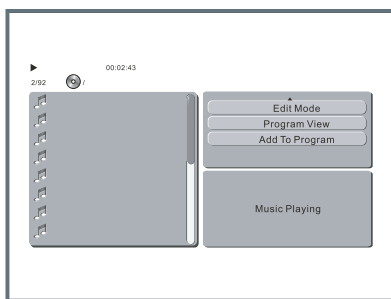

- 7 Move the cursor to the first track in your program list and press Select to play your custom program.
 - To delete the program, move the cursor to Clear Program and press Select.
- 8 To return to normal view, highlight Browser View and press Select.

Screen Saver

Screen Saver

The GDV-870 is equipped with a screen saver which will appear automatically under the following conditions:

- If no disc is loaded for 3 minutes.
- If the player is idle for 3 minutes; i.e., in Stop mode and not in a disc or Setup menu.

Press any button to restore normal operation.

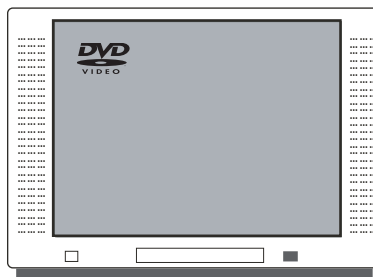

Chapter 5 - Help

Customer Support

Use the Troubleshooting chart on page 32 to resolve common situations that don't require professional attention. If the information provided does not resolve your problem, please contact your Adcom dealer or contact the Adcom customer service department as follows:

- Adcom, LLC
8541 E. Anderson Dr., Suite 101
Scottsdale, Arizona 85255
- Telephone: (480) 607-2277
 - Fax: (480) 348-9876
 - Email: service@adcom.com
 - Web: www.adcom.com

Adcom Protection Plan

Adcom offers the enclosed valuable Limited Warranty. Please read the details on the Warranty Card carefully to understand the extent of the protection offered by the Warranty, its reasonable limitations, and what you should do in order to obtain its benefits. Be sure to verify that the serial number printed on the rear panel matches the serial number on the outer carton. If any number is altered or missing, you should notify us immediately in order to ensure that you have received a genuine Adcom product which has not been opened, mishandled, or tampered with in any way. Always retain your original sales receipt as a proof of purchase.

Product Care & Maintenance

Before your Adcom DVD player left our factory, it was carefully inspected for physical imperfections and tested for all electrical parameters as a routine part of Adcom's systematic quality control. This, along with full operational and mechanical testing, should ensure a product flawless in both appearance and performance.

After you have unpacked the GDV-870, inspect it for physical damage. Save the shipping carton and all packing material as they are intended to reduce the possibility of transportation damage should the unit ever need to be shipped again.

In the unlikely event damage has occurred, notify your dealer immediately and request the name of the carrier so a written claim to cover shipping damages can be initiated. The right to a claim against a public carrier can be forfeited if the carrier is not notified promptly in writing and if the shipping carton and packing materials are not available for inspection by the carrier. Save all packing materials until the claim has been settled.

A Special Note on "Hum"

If there is a low-volume "hum" audible throughout your speakers, even with the main volume turned all the way down, you have a common phenomenon known as a "ground loop." Generally, the cause of a ground loop is the CableTV incoming signal line.

To determine if your cable system is the contributing factor, disconnect the CableTV incoming signal line (round, 75Ω) at the wall, or the first component the cable is connected to (e.g. the cable box or VCR). If the hum is no longer present, you must insert a "75Ω ground loop isolator" before reconnecting the line. Check with your Adcom dealer to obtain one.

System Reset

In rare cases the GDV-870 internal processor may freeze or lock-up causing abnormal operation. This is common to all micro-processor controlled devices when the unit is subject to excessive static discharge, AC line noise, or power spikes. In most cases it is easy to solve this problem by simply turning off the GDV-870 with the rear power switch for about five minutes. After waiting, reconnect the power cord and turn the unit on. If the unit functions normally, no further action is needed.

If the unit still does not operate properly, it may be necessary to manually reset the processor; see "Use Default Settings" on page 24.

If the manual reset does not solve the problem, contact your authorized Adcom dealer, an authorized Adcom service center or contact Adcom's service department directly for further advice.

Troubleshooting

The table below shows possible causes and solutions to common GDV-870 issues. If you do not see the answers you need here, please contact your Adcom dealer or customer service department; see page 31.

Symptom	Cause/Solution
No power	<ul style="list-style-type: none"> • Make sure the power cord is properly connected to the power outlet. • Make sure the main power is switched on.
No playback	<ul style="list-style-type: none"> • Make sure the disc is loaded. • Make sure the disc is loaded with the label side up. • The disc's region code is invalid for this player. • The type of disc is invalid for this player. • The disc is dirty or damaged. Try cleaning the disc or testing another disc. • There may be moisture condensation inside the player. Remove the disc and leave the unit powered on for 1-2 hours.
No picture	<ul style="list-style-type: none"> • Make sure your TV is powered on. • Make sure the correct AV input is selected on your TV to view the DVD player. • Make sure the video cables are securely and properly connected. • Check the video cables for damage. • Clean your disc.
Distorted or noisy picture	<ul style="list-style-type: none"> • The disc is dirty or damaged. Try cleaning the disc or testing another disc. • Reset the color system of the player or your TV. • Try connecting the player directly to your TV instead of via other components, such as a VCR.
Picture not full screen	<ul style="list-style-type: none"> • Select the desired screen format from the player's Setup Menu (see page 20). For full screen on a standard TV, set the View Mode to 4:3.
Player malfunction	<ul style="list-style-type: none"> • Unplug the player for 30 minutes. After 30 minutes, power on the player and the restore function should reset the player.
No sound	<ul style="list-style-type: none"> • Make sure your TV and AV preamp are powered on and correctly set. • Make sure the audio cables are securely and properly connected. • Check the audio cables for damage. • Press the Audio button to select an alternative audio track. • Press the Mute button to make sure the audio is not muted. • No sounds is output during Pause, Step, and Slow playback modes.
No surround sound	<ul style="list-style-type: none"> • Make sure your amplifier and/or powered loudspeakers are on. • Make sure the Digital Audio Output is set to "All" in the player's Setup Menu (refer to page 21).
Cannot skip or search	<ul style="list-style-type: none"> • Some discs are programmed to prohibit skip/search functions during certain sections, especially at the beginning of the disc (e.g. Warning messages and previews). • If the disc only has one chapter, the Skip function will not function.
Distorted or noisy MP3 playback	<ul style="list-style-type: none"> • If PC program files or other data files are mixed in with MP3 files on the same disc, the player may play the non-MP3 files with noise or no sound. • Make sure your disc only includes MP3 files. • Skip to another file.
Remote control does not function	<ul style="list-style-type: none"> • Remove any obstacles between the remote control and the player. • Point the remote control directly at the remote sensor on the player. • Check the polarities (+/-) of the batteries in the remote control. • Replace the batteries. • Place the unit away from direct sun and/or reduce the amount of ambient light.

Technical Specifications

Compatibility

Disc Types	DVD/DVD±R/DVD±RW, CDDA, MP3/MPEG4, Picture CD, CD-R/RW
Video Formats	MPEG2/MPEG4
Audio Formats	MPEG 1, Layer 1, Layer 2, Layer 3

Signal Output

Color System	PAL/NTSC/AUTO
Audio System	DIGITAL down mix stereo, DIGITAL digital output, Audio DAC 24bit/192kHz
Video Output	1 Vp-p at 75 ohm
Audio Output	2 Vrms Stereo
HDMI	480p/576p, 720p, 1080i, 1024x768, 1360x768

Performance

Frequency Response	CD: 4Hz-20kHz (EIA), DVD: 4Hz-22kHz (48k), 4Hz-44kHz (96k)
S/N Ratio	>110dB
THD	<0.008%

Output Terminals

Video (composite) output	1
S-Video output	1
2-CH output	1
5.1-CH output	1
Digital coaxial output	1
Digital optical output	1
YPbPr output	1
HDMI output	1

General

Supply Voltage (Switchable)	120vAC-60Hz/230vAC-50Hz
Power Consumption	20 watts
Dimensions	
• Width	17 inches (431.8mm)
• Rack Height	3.5 inches (88.9mm)
• Full Height	3.95 inches (100.3mm)
• Depth of Chassis	14.5 inches (368.3mm)
• Full Depth	18 inches (457.2mm)
Unit Weight	13.75 lbs. (6.24kg)
Trigger Pass Through	12vDC (3.5mm T/R)
Trigger Input	12vDC (3.5mm T/R)
IR Input	3.5mm T/R

Specifications are subject to change without notice.

A

Angle 27
 Aspect 27
 Aspect Ratio 20
 Audio 19, 27
 Audio Cables 11
 Audio Settings 21

B

Bass Management 21
 Brightness 20

C

CD Playback 29
 Center Delay 21
 Center Speakers 21
 Connections
 2-Channel Audio 13
 5.1-Channel Audio 14
 Component Video 12
 Composite Video 12
 Digital Audio 14
 HDMI 13
 IR Sensor 15
 Overview 11
 Power Cable 16
 Progressive Scan 12
 S-Video 12
 Trigger 15
 Customer Support 31

D

Default Settings 24
 Digital Audio Output 22
 Display 27
 DivX Playback 29
 DivX Registration 24
 DivX Subtitles 19
 Down Sampling 22
 DVD Menu 19
 DVD Playback 26
 DVD Priority 24

F

Features 5
 Front Panel
 Overview 7
 Front Speakers 21

G

Go To 27

H

HD JPEG Mode 20
 HD Resolution 20

I

Important Safety Instructions 4

J

JPEG Playback 29

L

Language Settings 19

M

Menu 27
 MP3 Playback 29
 MPEG4 Playback 29

N

Night Mode 22
 Number Buttons 27

O

OSD Language 19

P

Parental Control 23
 Password 23
 PBC 27
 Placement 6
 Playback Features 27
 Product Care & Maintenance 31
 Program 27
 Program Playback 30

R

Rating Settings 23
 Rear Panel
 Overview 10
 Regulatory Information 4
 Remote Control
 Batteries 6
 Overview 8
 Repeat (1/All) 27
 Repeat (A-B) 28

S

Screen Saver 30
 Search Buttons 28
 Setup
 Navigation 18
 Overview 17
 Sharpness 20
 Skip Buttons 28
 Slow 28
 Smart Sound 22
 Step 28
 Subtitle 19, 28
 Subwoofer 21
 Surround Delay 21
 Surround Speakers 21

T

Technical Specifications 33
 Test Tones 21
 Title 28
 Troubleshooting 32
 TV System 20

U

Unpacking 5

V

Video Cables 11
 Video Off 28
 Video Out 20
 Video Settings 20
 View Mode 20
 Voltage Switch 16

W

Warranty 31

Z

Zoom 28

Adcom shall not be liable for any errors contained herein or for any damages arising out of or related to this document or the information contained herein, even if Adcom has been advised of the possibility of such damages. This document is intended for informational and instructional purposes only. Adcom reserves the right to make changes in the specifications and other information contained in this document without prior notification. Adcom disclaims any obligation to update the information contained herein.



8541 East Anderson Drive, Suite 101
Scottsdale, Arizona 85255
Voice: 480.607.2277
Fax: 480.348.9876
www.adcom.com

Free Manuals Download Website

<http://myh66.com>

<http://usermanuals.us>

<http://www.somanuals.com>

<http://www.4manuals.cc>

<http://www.manual-lib.com>

<http://www.404manual.com>

<http://www.luxmanual.com>

<http://aubethermostatmanual.com>

Golf course search by state

<http://golfingnear.com>

Email search by domain

<http://emailbydomain.com>

Auto manuals search

<http://auto.somanuals.com>

TV manuals search

<http://tv.somanuals.com>