



# **NCL-DS** ***Series***

**NCL-DS**  
**NCL-D**  
**NCL-DR1**

# Motherboard

**E1848**

**First Edition V1  
December 2004**

**Copyright © 2004 ASUSTeK COMPUTER INC. All Rights Reserved.**

No part of this manual, including the products and software described in it, may be reproduced, transmitted, transcribed, stored in a retrieval system, or translated into any language in any form or by any means, except documentation kept by the purchaser for backup purposes, without the express written permission of ASUSTeK COMPUTER INC. ("ASUS").

Product warranty or service will not be extended if: (1) the product is repaired, modified or altered, unless such repair, modification or alteration is authorized in writing by ASUS; or (2) the serial number of the product is defaced or missing.

ASUS PROVIDES THIS MANUAL "AS IS" WITHOUT WARRANTY OF ANY KIND, EITHER EXPRESS OR IMPLIED, INCLUDING BUT NOT LIMITED TO THE IMPLIED WARRANTIES OR CONDITIONS OF MERCHANTABILITY OR FITNESS FOR A PARTICULAR PURPOSE. IN NO EVENT SHALL ASUS, ITS DIRECTORS, OFFICERS, EMPLOYEES OR AGENTS BE LIABLE FOR ANY INDIRECT, SPECIAL, INCIDENTAL, OR CONSEQUENTIAL DAMAGES (INCLUDING DAMAGES FOR LOSS OF PROFITS, LOSS OF BUSINESS, LOSS OF USE OR DATA, INTERRUPTION OF BUSINESS AND THE LIKE), EVEN IF ASUS HAS BEEN ADVISED OF THE POSSIBILITY OF SUCH DAMAGES ARISING FROM ANY DEFECT OR ERROR IN THIS MANUAL OR PRODUCT.

SPECIFICATIONS AND INFORMATION CONTAINED IN THIS MANUAL ARE FURNISHED FOR INFORMATIONAL USE ONLY, AND ARE SUBJECT TO CHANGE AT ANY TIME WITHOUT NOTICE, AND SHOULD NOT BE CONSTRUED AS A COMMITMENT BY ASUS. ASUS ASSUMES NO RESPONSIBILITY OR LIABILITY FOR ANY ERRORS OR INACCURACIES THAT MAY APPEAR IN THIS MANUAL, INCLUDING THE PRODUCTS AND SOFTWARE DESCRIBED IN IT.

Products and corporate names appearing in this manual may or may not be registered trademarks or copyrights of their respective companies, and are used only for identification or explanation and to the owners' benefit, without intent to infringe.

# Contents

|  |      |
|--|------|
| Notices .....                              | vi   |
| Safety information .....                   | vii  |
| About this guide .....                     | viii |
| Typography .....                           | ix   |
| NCL-DS Series specifications summary ..... | x    |

## Chapter 1: Product introduction

|       |                                |     |
|-------|--------------------------------|-----|
| 1.1   | Welcome! .....                 | 1-1 |
| 1.2   | Package contents .....         | 1-1 |
| 1.3   | Special features .....         | 1-2 |
| 1.3.1 | Product highlights .....       | 1-2 |
| 1.3.2 | Innovative ASUS features ..... | 1-4 |

## Chapter 2: Hardware information

|       |   |      |
|-------|---|------|
| 2.1   | Before you proceed .....                  | 2-1  |
| 2.2   | Motherboard overview .....                | 2-2  |
| 2.2.1 | Placement direction .....                 | 2-2  |
| 2.2.2 | Screw holes .....                         | 2-2  |
| 2.2.3 | CEK spring support for motherboard .....  | 2-3  |
| 2.2.4 | Motherboard layouts .....                 | 2-6  |
| 2.2.5 | Layout contents .....                     | 2-9  |
| 2.3   | Central Processing Unit (CPU) .....       | 2-11 |
| 2.3.1 | Installing the CPU .....                  | 2-11 |
| 2.3.2 | Installing the CPU heatsink and fan ..... | 2-13 |
| 2.4   | System memory .....                       | 2-15 |
| 2.4.1 | Overview .....                            | 2-15 |
| 2.4.2 | Memory configurations .....               | 2-15 |
| 2.4.3 | Installing a DIMM .....                   | 2-17 |
| 2.4.4 | Removing a DIMM .....                     | 2-17 |
| 2.5   | Expansion slots .....                     | 2-18 |
| 2.5.1 | Installing an expansion card .....        | 2-18 |
| 2.5.2 | Configuring an expansion card .....       | 2-18 |
| 2.5.3 | Interrupt assignments .....               | 2-19 |
| 2.5.4 | PCI/PCI-X slots .....                     | 2-20 |
| 2.5.5 | PCI Express x8 slot .....                 | 2-20 |
| 2.5.6 | ZCR socket .....                          | 2-20 |
| 2.6   | Jumpers .....                             | 2-21 |
| 2.7   | Connectors .....                          | 2-26 |
| 2.7.1 | Rear panel connectors .....               | 2-26 |
| 2.7.2 | Internal connectors .....                 | 2-27 |

# Contents

## Chapter 3: Powering up

- 3.1 Starting up for the first time ..... 3-1
- 3.2 Powering off the computer ..... 3-2
  - 3.2.1 Using the OS shut down function ..... 3-2
  - 3.2.2 Using the dual function power switch ..... 3-2

## Chapter 4: BIOS setup

- 4.1 Managing and updating your BIOS ..... 4-1
  - 4.1.1 Creating a bootable floppy disk ..... 4-1
  - 4.1.2 AFUDOS utility ..... 4-2
  - 4.1.3 ASUS CrashFree BIOS 2 utility ..... 4-5
  - 4.1.4 ASUS Update utility ..... 4-7
- 4.2 BIOS setup program ..... 4-10
  - 4.2.1 BIOS menu screen ..... 4-11
  - 4.2.2 Menu bar ..... 4-11
  - 4.2.3 Navigation keys ..... 4-11
  - 4.2.4 Menu items ..... 4-12
  - 4.2.5 Sub-menu items ..... 4-12
  - 4.2.6 Configuration fields ..... 4-12
  - 4.2.7 Pop-up window ..... 4-12
  - 4.2.8 Scroll bar ..... 4-12
  - 4.2.9 General help ..... 4-12
- 4.3 Main menu ..... 4-13
  - 4.3.1 System Time ..... 4-13
  - 4.3.2 System Date ..... 4-13
  - 4.3.3 Legacy Diskette A ..... 4-13
  - 4.3.4 Primary, Third and Fourth IDE Master/Slave ..... 4-14
  - 4.3.5 IDE Configuration ..... 4-16
  - 4.3.6 System Information ..... 4-17
  - 4.4.1 USB Configuration ..... 4-18
- 4.4 Advanced menu ..... 4-18
  - 4.4.2 MPS Configuration ..... 4-20
  - 4.4.3 Remote Access Configuration ..... 4-21
  - 4.4.4 CPU Configuration ..... 4-21
  - 4.4.5 Chipset ..... 4-22
  - 4.4.6 Onboard Devices Configuration ..... 4-24
  - 4.4.7 PCI PnP ..... 4-25
  - 4.5.1 ACPI APIC Support [Enabled] ..... 4-27
  - 4.5.2 APM Configuration ..... 4-27

# Contents

|       |                                   |      |
|-------|-----------------------------------|------|
| 4.5   | Power menu .....                  | 4-27 |
| 4.5.3 | Hardware Monitor .....            | 4-30 |
| 4.6.1 | Boot Device Priority .....        | 4-32 |
| 4.6   | Boot menu .....                   | 4-32 |
| 4.6.2 | Boot Settings Configuration ..... | 4-33 |
| 4.6.3 | Security .....                    | 4-35 |
| 4.7   | Exit menu .....                   | 4-38 |

## Appendix: Block diagrams

|     |                             |     |
|-----|-----------------------------|-----|
| A.1 | NCL-DS block diagram .....  | A-1 |
| A.2 | NCL-D block diagram .....   | A-2 |
| A.3 | NCL-DR1 block diagram ..... | A-3 |

# Notices

## Federal Communications Commission Statement

This device complies with Part 15 of the FCC Rules. Operation is subject to the following two conditions:

- This device may not cause harmful interference, and
- This device must accept any interference received including interference that may cause undesired operation.

This equipment has been tested and found to comply with the limits for a Class B digital device, pursuant to Part 15 of the FCC Rules. These limits are designed to provide reasonable protection against harmful interference in a residential installation. This equipment generates, uses and can radiate radio frequency energy and, if not installed and used in accordance with manufacturer's instructions, may cause harmful interference to radio communications. However, there is no guarantee that interference will not occur in a particular installation. If this equipment does cause harmful interference to radio or television reception, which can be determined by turning the equipment off and on, the user is encouraged to try to correct the interference by one or more of the following measures:

- Reorient or relocate the receiving antenna.
- Increase the separation between the equipment and receiver.
- Connect the equipment to an outlet on a circuit different from that to which the receiver is connected.
- Consult the dealer or an experienced radio/TV technician for help.



---

The use of shielded cables for connection of the monitor to the graphics card is required to assure compliance with FCC regulations. Changes or modifications to this unit not expressly approved by the party responsible for compliance could void the user's authority to operate this equipment.

---

## Canadian Department of Communications Statement

This digital apparatus does not exceed the Class B limits for radio noise emissions from digital apparatus set out in the Radio Interference Regulations of the Canadian Department of Communications.

**This class B digital apparatus complies with Canadian ICES-003.**

# Safety information

## Electrical safety

- To prevent electrical shock hazard, disconnect the power cable from the electrical outlet before relocating the system.
- When adding or removing devices to or from the system, ensure that the power cables for the devices are unplugged before the signal cables are connected. If possible, disconnect all power cables from the existing system before you add a device.
- Before connecting or removing signal cables from the motherboard, ensure that all power cables are unplugged.
- Seek professional assistance before using an adapter or extension cord. These devices could interrupt the grounding circuit.
- Make sure that your power supply is set to the correct voltage in your area. If you are not sure about the voltage of the electrical outlet you are using, contact your local power company.
- If the power supply is broken, do not try to fix it by yourself. Contact a qualified service technician or your retailer.

## Operation safety

- Before installing the motherboard and adding devices on it, carefully read all the manuals that came with the package.
- Before using the product, make sure all cables are correctly connected and the power cables are not damaged. If you detect any damage, contact your dealer immediately.
- To avoid short circuits, keep paper clips, screws, and staples away from connectors, slots, sockets and circuitry.
- Avoid dust, humidity, and temperature extremes. Do not place the product in any area where it may become wet.
- Place the product on a stable surface.
- If you encounter technical problems with the product, contact a qualified service technician or your retailer.

# About this guide

This user guide contains the information you need when installing and configuring the motherboard.

## How this guide is organized

This manual contains the following parts:

- **Chapter 1: Product introduction**  
This chapter describes the features of the motherboard and the new technologies it supports.
- **Chapter 2: Hardware information**  
This chapter lists the hardware setup procedures that you have to perform when installing system components. It includes description of the switches, jumpers, and connectors on the motherboard.
- **Chapter 3: Powering up**  
This chapter describes the power up sequence and ways of shutting down the system.
- **Chapter 4: BIOS setup**  
This chapter tells how to change system settings through the BIOS Setup menus. Detailed descriptions of the BIOS parameters are also provided.
- **Appendix: Reference information**  
This appendix includes additional information that you may refer to when configuring the motherboard.

## Where to find more information

Refer to the following sources for additional information and for product and software updates.

### 1. ASUS websites

The ASUS website provides updated information on ASUS hardware and software products. Refer to the ASUS contact information.

### 2. Optional documentation

Your product package may include optional documentation, such as warranty flyers, that may have been added by your dealer. These documents are not part of the standard package.



## Conventions used in this guide

To make sure that you perform certain tasks properly, take note of the following symbols used throughout this manual.



**DANGER/WARNING:** Information to prevent injury to yourself when trying to complete a task.



**CAUTION:** Information to prevent damage to the components when trying to complete a task.



**IMPORTANT:** Instructions that you **MUST** follow to complete a task.



**NOTE:** Tips and additional information to help you complete a task.

## Typography

**Bold text**

Indicates a menu or an item to select.

*Italics*

Used to emphasize a word or a phrase.

<Key>

Keys enclosed in the less-than and greater-than sign means that you must press the enclosed key.

Example: <Enter> means that you must press the Enter or Return key.

<Key1+Key2+Key3>

If you must press two or more keys simultaneously, the key names are linked with a plus sign (+).

Example: <Ctrl+Alt+D>

**Command**

Means that you must type the command exactly as shown, then supply the required item or value enclosed in brackets.

Example: At the DOS prompt, type the command line:

**afudos /i[filename]**

**afudos /iNCL-DS.ROM**

## NCL-DS Series specifications summary

|                         |   |
|-------------------------|---|
| <b>CPU</b>              | Dual 604-pin sockets for Intel® Xeon™ processors with Extended Memory 64-bit Technology (EM64T)<br>Supports Intel® Hyper-Threading Technology   |
| <b>Chipset</b>          | Northbridge : Intel® E7520 Memory Controller Hub (MCH)<br>Southbridge : Intel® ICH5R  |
| <b>Front Side Bus</b>   | 800 MHz   |
| <b>Memory</b>           | Dual-channel memory architecture<br>8 x 240-pin DIMM sockets support registered ECC 400 MHz DDR2 memory modules<br>Supports 256 MB up to 16 GB system memory  |
| <b>Expansion slots</b>  | <i>(NCL-DS and NCL-D models include all slots; NCL-DR1 model includes only one PCI-X 64-bit slot)</i><br>1 x PCI-X 133 MHz/64-bit slot (PCI-X 1.0) (1U/2U riser)<br>1 x PCI-X 133 MHz/64-bit slot (PCI-X 1.0)<br>1 x PCI Express x8 slot (x4 link, PCI Express 1.0a)<br>1 x PCI-X 133 MHz/64-bit slot (PCI-X 1.0)<br>1 x PCI-X 133 MHz/64-bit slot (PCI-X 1.0)<br>1 x PCI 33 MHz/32-bit/5V (PCI 2.3)<br>1 x SO-DIMM Socket for Adaptec AIC-2015 ZCR board |
| <b>Storage</b>          | Intel® ICH5R South Bridge supports: <ul style="list-style-type: none"> <li>- 2 x Ultra DMA 100/66/33</li> <li>- 2 x SATA-150 with RAID 0, RAID 1 configuration and Intel® Matrix Storage Technology</li> </ul> <i>(NCL-DS model only)</i><br>Adaptec AIC-7902 PCI-X U320 SCSI controller supports: <ul style="list-style-type: none"> <li>- 2 x SCSI channels with Host RAID 0/1/10</li> <li>- Zero-Channel RAID (optional)</li> </ul>                    |
| <b>Graphics</b>         | ATI® RAGE-XL PCI-based VGA controller   |
| <b>LAN</b>              | 2 x Broadcom BMC5721 PCI Express Gigabit LAN controllers<br>Supports PCI Express 1.0a interface   |
| <b>USB</b>              | Intel® ICH5R South Bridge supports: <ul style="list-style-type: none"> <li>- 4 USB 2.0/1.1 ports</li> </ul>   |
| <b>Special features</b> | ASUS Q-Fan2<br>ASUS CrashFree BIOS 2<br>ASUS MyLogo2  |
| <b>BIOS features</b>    | AMI BIOS, 8 MB Flash ROM, Green, PnP, DMI2.0a, SMBIOS 2.3, WfM2.0   |

*(continued on the next page)*

# NCL-DS Series specifications summary

|                            |  |
|----------------------------|--|
| <b>Rear panel</b>          | <ul style="list-style-type: none"> <li>1 x PS/2 keyboard port (purple)</li> <li>1 x PS/2 mouse port (green)</li> <li>2 x USB 2.0/1.1 ports</li> <li>1 x Parallel port (<i>NCL-DS and NCL-D only</i>)</li> <li>1 x Serial port</li> <li>1 x VGA port</li> <li>2 x LAN (RJ-45) ports</li> </ul>  |
| <b>Internal connectors</b> | <ul style="list-style-type: none"> <li>Floppy disk drive connector</li> <li>IDE connectors</li> <li>Serial ATA connectors</li> <li>Hard disk activity LED connector</li> <li>Chassis intrusion connector</li> <li>CPU, chassis, and power fan connectors</li> <li>USB 2.0/1.1 connectors</li> <li>SSI 24-pin ATX and 8-pin ATX 12V power connectors</li> <li>Serial port connector</li> <li>SCSI connectors (<i>NCL-DS model only</i>)</li> <li>Backplane SMBus connector</li> <li>System panel connector</li> </ul> |
| <b>Power Requirement</b>   | <ul style="list-style-type: none"> <li>SSI power supply (with 24-pin and 8-pin 12V plugs)</li> <li>ATX 12V 2.0 compliant</li> </ul>  |
| <b>Form Factor</b>         | E-ATX form factor: 12 in x 13 in (30.5 cm x 33 cm)   |
| <b>Support CD contents</b> | <ul style="list-style-type: none"> <li>Device drivers</li> <li>ASUS Live Update Utility</li> <li>Anti-virus software</li> </ul>  |

*\*Specifications are subject to change without notice.*



This chapter describes the motherboard features and the new technologies it supports.

# Product introduction



# Chapter summary



|     |                        |     |
|-----|------------------------|-----|
| 1.1 | Welcome! .....         | 1-1 |
| 1.2 | Package contents ..... | 1-1 |
| 1.3 | Special features ..... | 1-2 |

## 1.1 Welcome!

Thank you for buying an ASUS® NCL-DS Series motherboard!

\* This user guide includes information for the **NCL-DS**, **NCL-D**, and **NCL-DR1** models.

The motherboard delivers a host of new features and latest technologies, making it another standout in the long line of ASUS quality motherboards!

Before you start installing the motherboard, and hardware devices on it, check the items in your package with the list below.

## 1.2 Package contents

Check your motherboard package for the following items.

|                        |   |
|------------------------|---|
| <b>Motherboard</b>     | ASUS NCL-D Series motherboard   |
| <b>Cables</b>          | 2 x Serial ATA signal cables<br>1 x Serial ATA power cable (dual-plug)<br>2 x SCSI Ultra320 cables ( <i>for NCL-DS model only</i> )<br>80-conductor IDE cable<br>3-in-1 floppy disk drive cable |
| <b>Accessories</b>     | 2 x CEK spring (for CPUs)<br>I/O shield   |
| <b>Application CDs</b> | ASUS motherboard support CD   |
| <b>Documentation</b>   | User guide  |



If any of the above items is damaged or missing, contact your retailer.

## 1.3 Special features

### 1.3.1 Product highlights

#### Latest processor technology

The motherboard comes with dual 604-pin surface mount ZIF sockets designed for the Intel® Xeon™ processor with 800 MHz Front Side Bus (FSB) and 1 MB L2 cache. The processor incorporates the Intel® Hyper-Threading Technology, the Intel® NetBurst™ micro-architecture that features hyper-pipelined technology, and Extended Memory 64-bit Technology (EM64T). The EM64T enables the support for 64-bit operation system, such as 64-bit Windows® and Linux. See page 2-9 for details.

#### Intel® E7520 and Intel® ICH5R chipset

The Intel® E7520 Memory Controller Hub (MCH) and the Intel® ICH5R (I/O controller hub) provide the vital interfaces for the motherboard.

The MCH provides the processor, dual-channel DDR2-400 memory, and PCI Express interfaces. The ICH is a new generation server class I/O controller hub that provides the interface for PCI 2.3.

#### DDR2 memory support

The motherboard supports DDR2 memory which features data transfer rates of 400 MHz to meet the higher bandwidth requirements of the latest 3D graphics, multimedia, and Internet applications. The dual-channel DDR2 architecture doubles the bandwidth of your system memory to boost system performance, eliminating bottlenecks with peak bandwidths of up to 6.4 GB/s.

#### PCI Express™ interface

The motherboard fully supports PCI Express, the latest I/O interconnect technology that speeds up the PCI bus. PCI Express features point-to-point serial interconnections between devices and allows higher clocks speeds by carrying data in packets. This high speed interface is software compatible with existing PCI or PCI-X specifications. See page 2-20 for details.

#### Ultra320 SCSI feature (*NCL-DS model only*)

The Adaptec® AIC-7902 PCI-X SCSI controller is onboard to support two 68-pin Ultra320 SCSI connectors, each can connect up to 15 devices. See page 2-29 for details.

#### Zero-Channel RAID (ZCR) solution (*NCL-DS model only*)

The motherboard comes with a ZCR socket for an optional Zero-Channel RAID card, allowing RAID0 (striping), RAID1 (mirroring), RAID10, and RAID5 configurations. The ZCR capability provides a cost-effective high-performance and added reliability. See page 2-20 for details.



## Gigabit LAN solution

The motherboard comes with dual Gigabit LAN controllers to provide a total solution for your networking needs. The onboard Broadcom BCM5721 Gigabit LAN controllers use the PCI Express interface and have network throughput close to Gigabit bandwidth. See page 2-26 for details.

## Serial ATA technology

The motherboard supports the Serial ATA technology through the Serial ATA interfaces controlled by the Intel® ICH5R. The SATA specification allows for thinner, more flexible cables with lower pin count, reduced voltage requirement, and up to 150 MB/s data transfer rate.

## Built-in SATA RAID solution

The Intel® ICH5R allows RAID 0 and RAID 1 configuration for two SATA connectors and supports the Intel® Matrix Storage Technology. See page 2-28 for details.

## USB 2.0 technology

The motherboard implements the Universal Serial Bus (USB) 2.0 specification, dramatically increasing the connection speed from the 12 Mbps bandwidth on USB 1.1 to a fast 480 Mbps on USB 2.0. USB 2.0 is backward compatible with USB 1.1. See pages 2-26 and 2-30 for details.

## Temperature, fan, and voltage monitoring

The CPU temperature is monitored by the ASIC (integrated in the Winbond hardware monitor) to prevent overheating and damage. The system fan rotations per minute (RPM) is monitored for timely failure detection. The ASIC monitors the voltage levels to ensure stable supply of current for critical components. See page 4-31 for details.

## 1.3.2 Innovative ASUS features

### CrashFree BIOS 2

This feature allows you to restore the original BIOS data from the support CD in case when the BIOS codes and data are corrupted. This protection eliminates the need to buy a replacement ROM chip. See page 4-5 for details.

### ASUS Smart Fan technology

The ASUS Smart Fan technology smartly adjusts the fan speeds according to the system loading to ensure quiet, cool, and efficient operation. See page 4-31 for details.

### ASUS MyLogo2™

This new feature present in the motherboard allows you to personalize and add style to your system with customizable boot logos. See page 4-34 for details.

This chapter lists the hardware setup procedures that you have to perform when installing system components. It includes description of the jumpers and connectors on the motherboard.

# Hardware information



## Chapter summary



|     |                                     |      |
|-----|-------------------------------------|------|
| 2.1 | Before you proceed .....            | 2-1  |
| 2.2 | Motherboard overview .....          | 2-2  |
| 2.3 | Central Processing Unit (CPU) ..... | 2-11 |
| 2.4 | System memory .....                 | 2-15 |
| 2.5 | Expansion slots .....               | 2-18 |
| 2.6 | Jumpers .....                       | 2-21 |
| 2.7 | Connectors .....                    | 2-26 |

## 2.1 Before you proceed

Take note of the following precautions before you install motherboard components or change any motherboard settings.



- Unplug the power cord from the wall socket before touching any component.
- Use a grounded wrist strap or touch a safely grounded object or to a metal object, such as the power supply case, before handling components to avoid damaging them due to static electricity.
- Hold components by the edges to avoid touching the ICs on them.
- Whenever you uninstall any component, place it on a grounded antistatic pad or in the bag that came with the component.
- **Before you install or remove any component, ensure that the power supply is switched off or the power cord is detached from the power supply.** Failure to do so may cause severe damage to the motherboard, peripherals, and/or components.

### Onboard LED

The motherboard comes with a standby power LED. The green LED lights up to indicate that the system is ON, in sleep mode, or in soft-off mode. This is a reminder that you should shut down the system and unplug the power cable before removing or plugging in any motherboard component. The illustration below shows the location of the onboard LED.

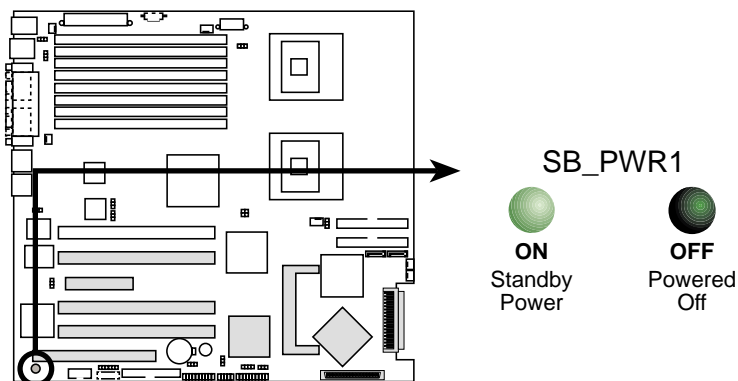

**NCL-DS Series Standby power LED**

## 2.2 Motherboard overview

Before you install the motherboard, study the configuration of your chassis to ensure that the motherboard fits into it.



Make sure to unplug the chassis power cord before installing or removing the motherboard. Failure to do so can cause you physical injury and damage motherboard components.

### 2.2.1 Placement direction

When installing the motherboard, make sure that you place it into the chassis in the correct orientation. The edge with external ports goes to the rear part of the chassis as indicated in the image below.

### 2.2.2 Screw holes

Place nine (9) screws into the holes indicated by circles to secure the motherboard to the chassis.



Do not overtighten the screws! Doing so can damage the motherboard.

Place this side towards  
the rear of the chassis

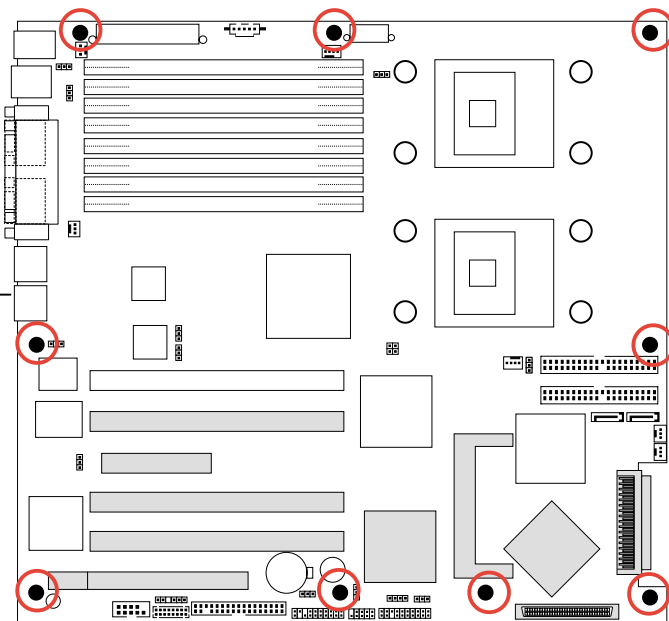

## 2.2.3 CEK spring support for motherboard

For additional protection from motherboard breakage due to the weight of the CPU heatsinks, your motherboard package comes with two CEK springs. Each CEK spring has four hooks to match the designated holes around the CPU area.

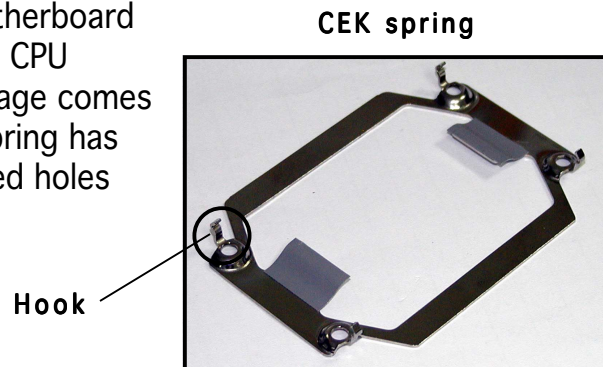

To install the CEK spring:

1. Locate the CPU heatsink holes on the motherboard.

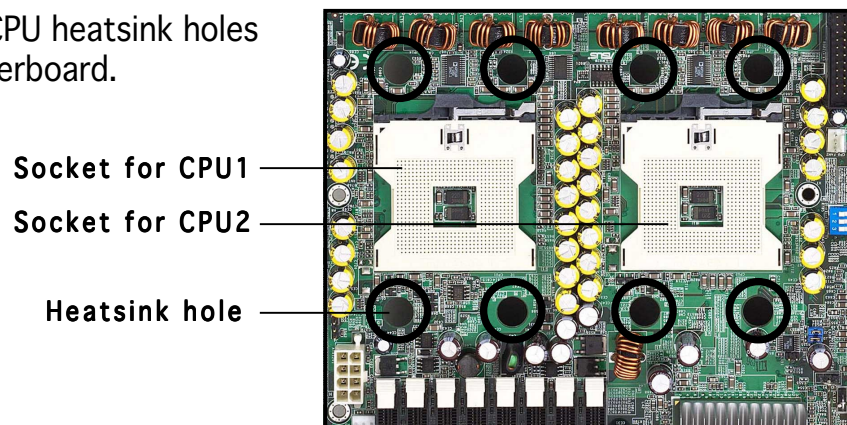

2. Position the CEK spring underneath the motherboard, then match the CEK spring hooks to the CPU1 heatsink holes.

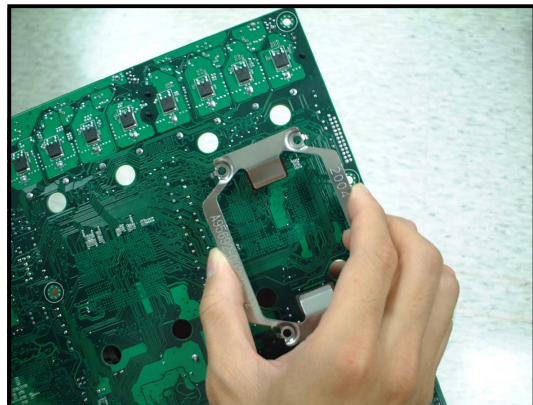

3. Press the upper spring hooks inward, then insert to the upper CPU heatsink holes until they snap in place.

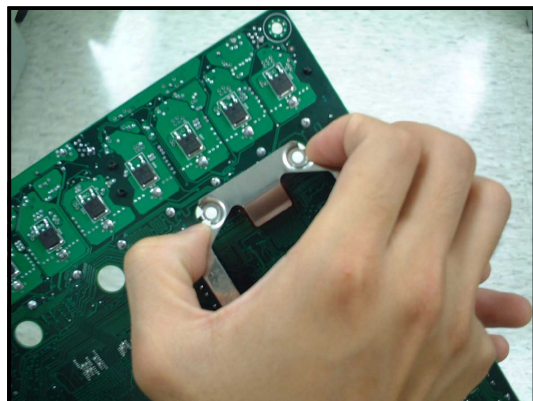



4. Press the lower spring clips inward, then insert to the lower CPU heatsink holes until they snap in place.

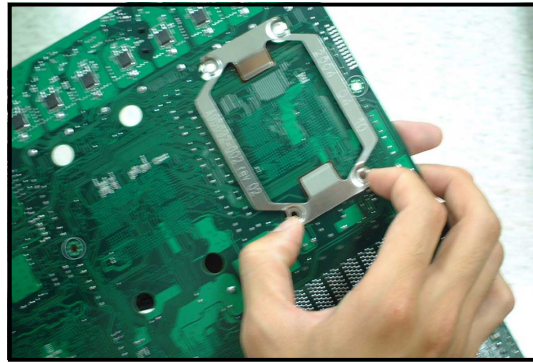

5. If you installed a second CPU, repeat steps 2 to 4 to install the CEK spring to the CPU2 heatsink holes.

The CEK springs appear as shown when installed.

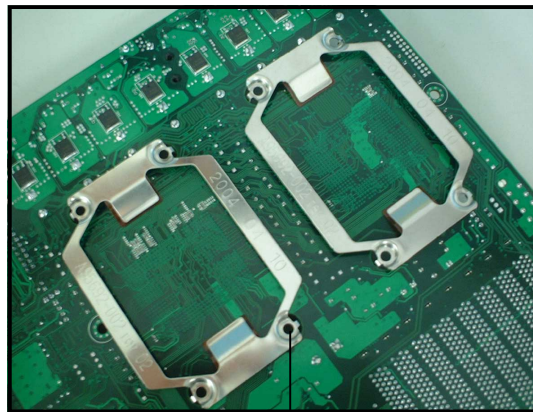

CEK spring screw hole

6. Before installing the motherboard into the chassis, locate the standoffs that should match the eight (8) CEK spring screw holes.

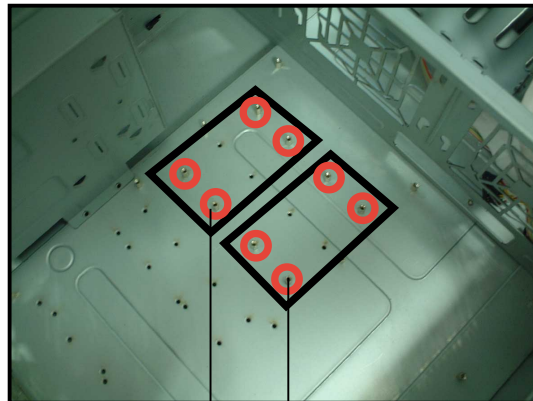

Standoffs for CPU1

Standoffs for CPU2



7. Install the motherboard with the external I/O ports toward the chassis rear panel. The CPU sockets should be right on top of their respective standoffs.

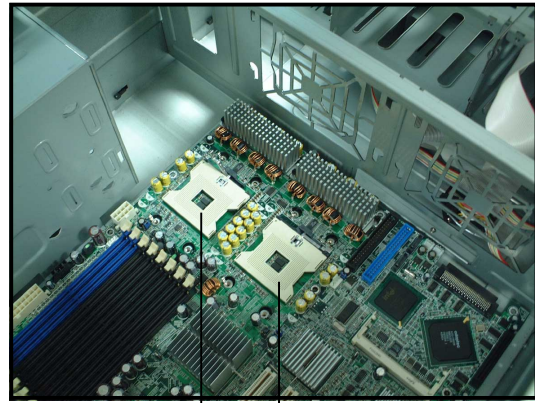

Socket for CPU1

Socket for CPU2



---

Make sure that the standoffs perfectly match the CEK spring screw holes; otherwise, you can not install the CPU heatsinks properly.

---

8. Secure the motherboard with 9 screws. Refer to section “2.2.2 Screw holes” for illustration.

## 2.2.4 Motherboard layouts

### NCL-DS model

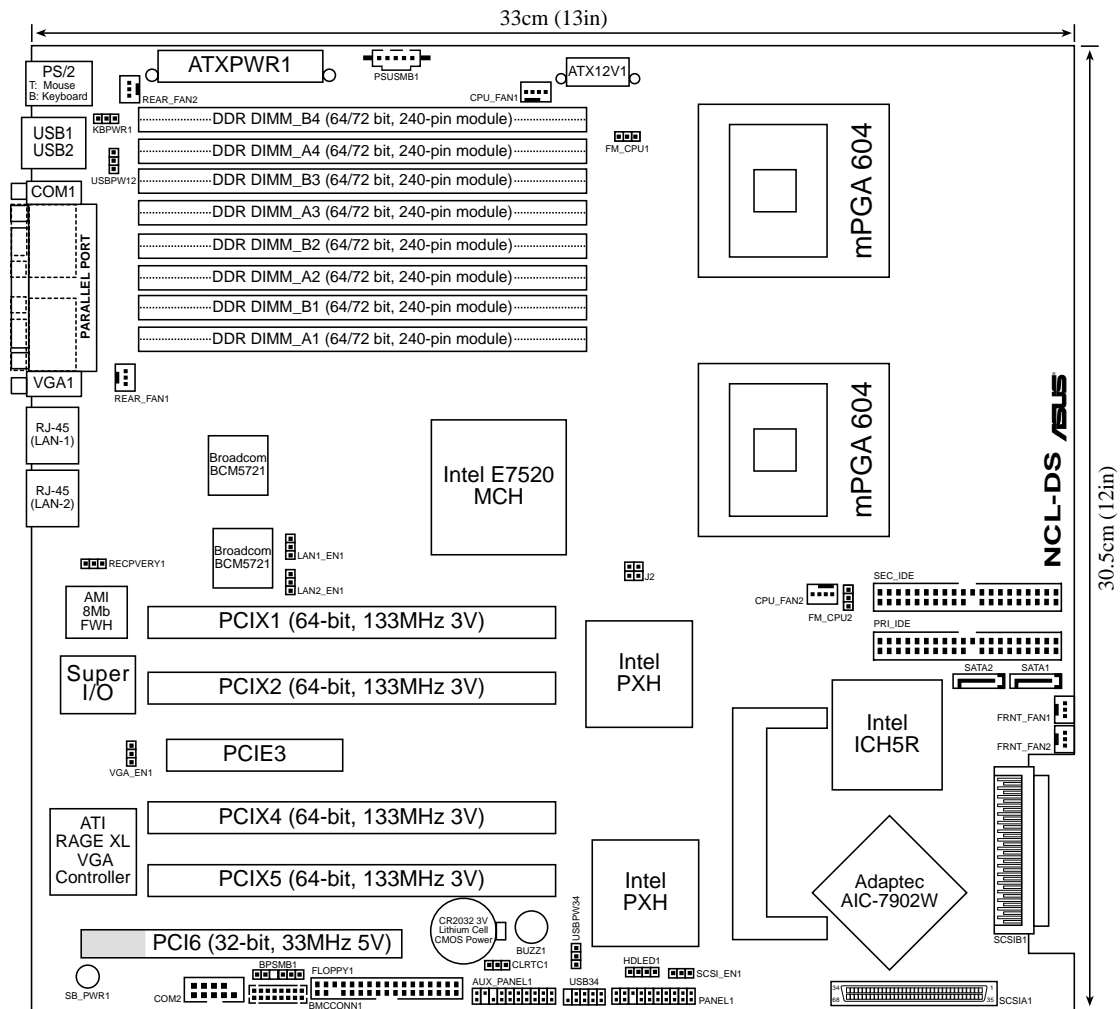

The NCL-DS model includes Adaptec® AIC-7902W SCSI controller, SCSI connectors, and Intel® PXH chipset to support the SCSI RAID feature.

# NCL-D model

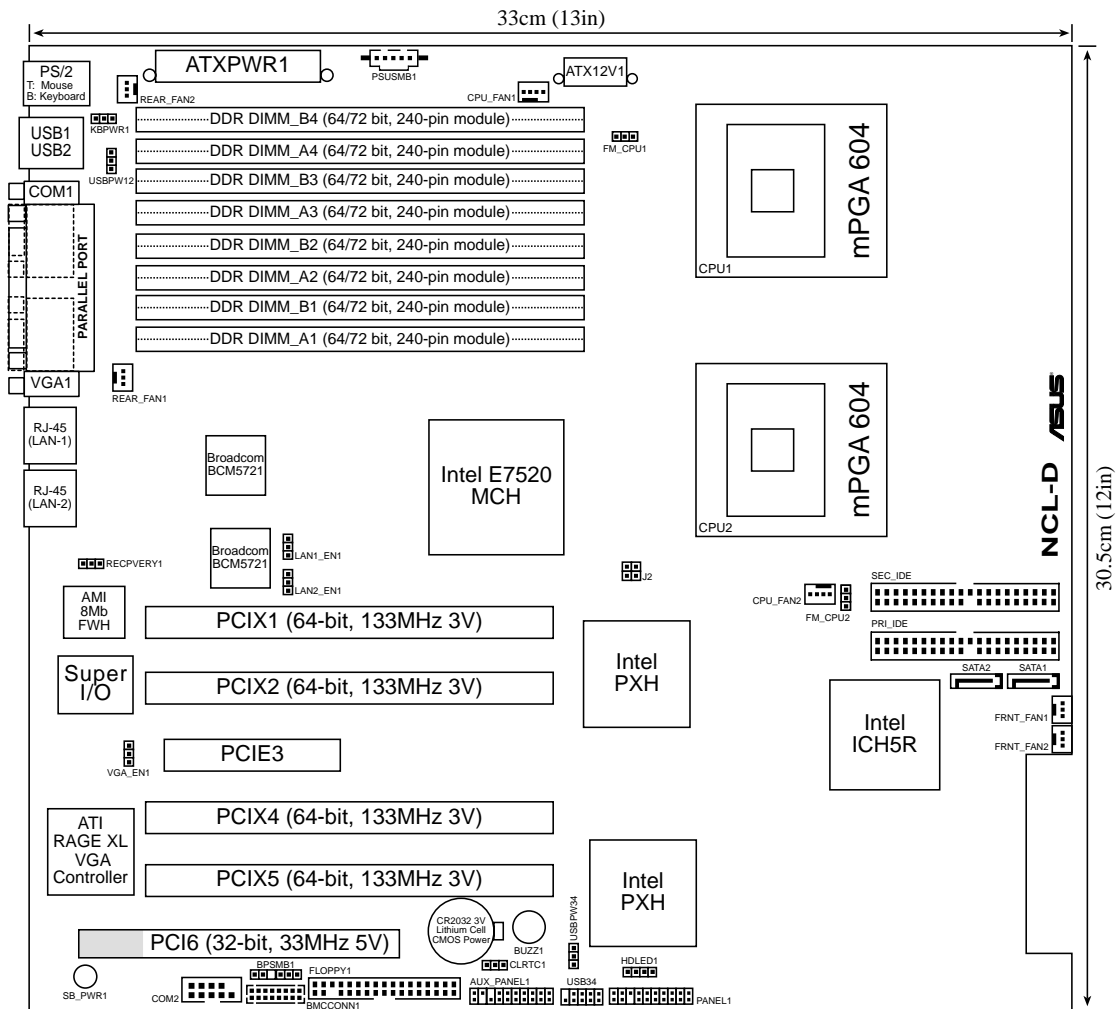

The NCL-D model supports RAID feature through the Intel® ICH5R southbridge and two SATA connectors.

## NCL-DR1 model

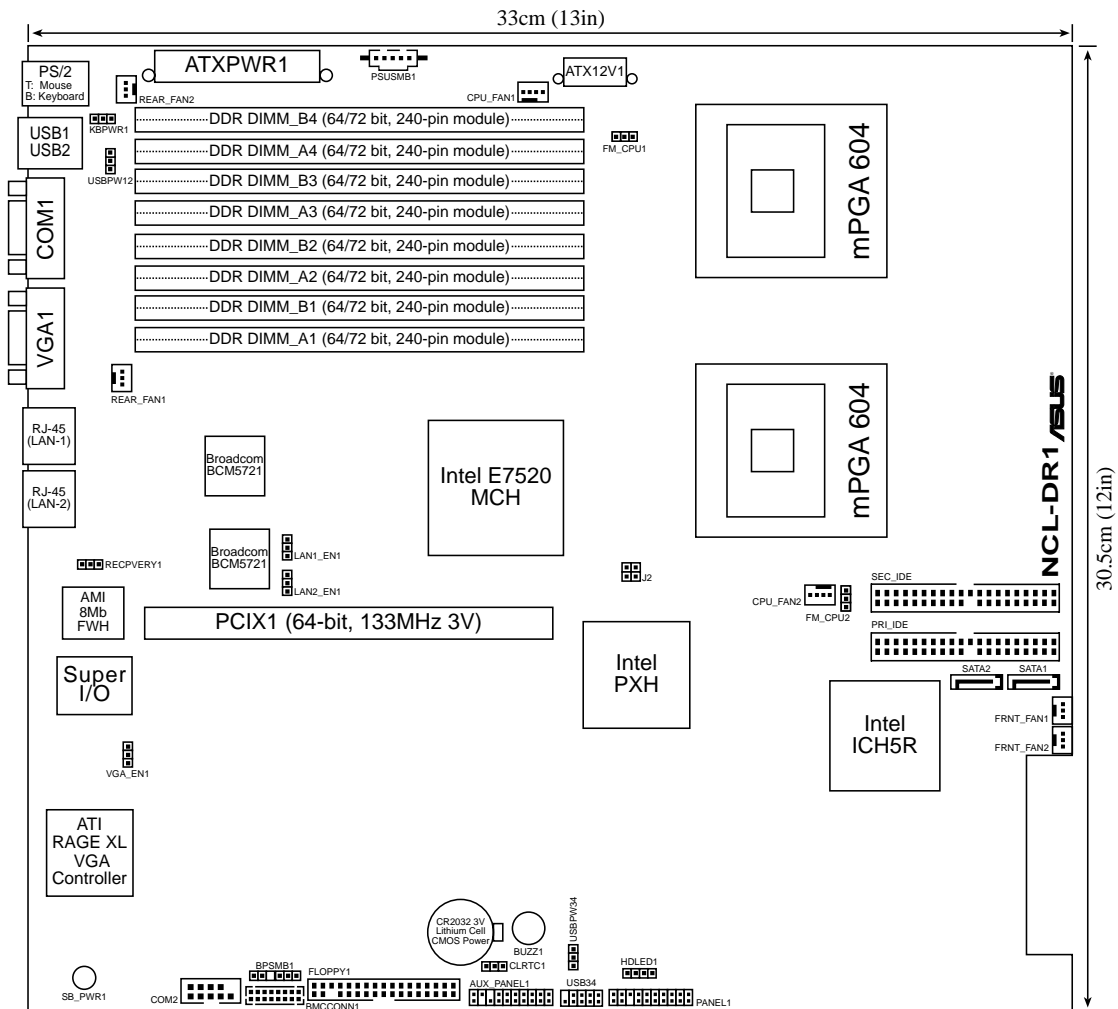

- The NCL-DR1 model supports RAID feature through the Intel® ICH5R southbridge and two SATA connectors.
- This PCI-X slot supports a 64-bit expansion card on a riser card for 1U systems.

## 2.2.5 Layout contents

| Slots/Sockets                  | Page |
|--------------------------------|------|
| 1. CPU sockets                 | 2-9  |
| 2. DDR2 DIMM sockets           | 2-13 |
| 3. PCI/PCI-X/PCI Express slots | 2-18 |
| 4. Zero-Channel RAID socket    | 2-18 |

| Jumpers  | Page |
|--|------|
| 1. Clear RTC RAM (CLRRTC1)                         | 2-21 |
| 2. CPU fan pin selection (3-pin FM_CPU1, FM_CPU2)  | 2-22 |
| 3. USB device wake-up (3-pin USBPW12, USBPW34)     | 2-22 |
| 4. Keyboard power (3-pin KBPWR1)                   | 2-23 |
| 5. VGA controller setting (3-pin VGA_EN1)          | 2-23 |
| 6. Gigabit LAN controller setting (3-pin LAN1_EN1) | 2-24 |
| 7. Gigabit LAN controller setting (3-pin LAN2_EN1) | 2-24 |
| 8. SCSI controller setting (3-pin SCSI_EN1)        | 2-25 |
| 9. Force BIOS recovery setting (3-pin RECOVERY1)   | 2-25 |

| Rear panel connectors          | Page |
|--------------------------------|------|
| 1. PS/2 mouse port (green)     | 2-26 |
| 2. Parallel port               | 2-26 |
| 3. LAN (RJ-45) ports           | 2-26 |
| 4. VGA port                    | 2-26 |
| 5. Serial (COM1) port          | 2-26 |
| 6. USB 2.0 ports 1 and 2       | 2-26 |
| 7. PS/2 keyboard port (purple) | 2-26 |

| Internal connectors  | Page |
|--|------|
| 1. Floppy disk drive connector (34-1 pin FLOPPY1)                                | 2-27 |
| 2. Primary IDE connectors (40-1 pin PRI_IDE, SEC_IDE)                            | 2-27 |
| 3. Serial ATA connectors (7-pin SATA1, SATA2)                                    | 2-28 |
| 4. Ultra320 SCSI connectors (two 68-pin SCSI1, SCSI2)                            | 2-29 |
| 5. Hard disk activity LED connector (4-pin HDLED1)                               | 2-30 |
| 6. USB connector (10-1 pin USB34)  | 2-30 |
| 7. CPU and system fan connectors<br>(3-pin CPU_FAN1/2, REAR_FAN1/2, FRNT_FAN1/2) | 2-31 |
| 8. Power supply SMBus connector (5-pin PSUSMB1)                                  | 2-31 |
| 9. Backplane SMBus connector (6-1 pin BPSMB1)                                    | 2-32 |
| 10. Serial port connector (10-1 pin COM2)  | 2-32 |
| 11. ATX power connectors (24-pin ATXPWR1, 8-pin ATX12V1)                         | 2-33 |
| 12. BMC connector (16-pin BMCCONN1)  | 2-33 |
| 13. System panel connector (20-pin PANEL1)                                       | 2-34 |
| 14. Auxiliary panel connector (20-pin AUX_PANEL1)                                | 2-35 |

## 2.3 Central Processing Unit (CPU)

The motherboard comes with surface mount 604-pin Zero Insertion Force (ZIF) sockets. The sockets are designed for the Intel® Xeon™ processor in the 604-pin package with 1 MB L2 cache. The new generation Xeon™ processor supports 800 MHz system bus and Extended Memory 64-bit Technology (EM64T).

### 2.3.1 Installing the CPU

To install a CPU:

1. Locate the CPU sockets on the motherboard.

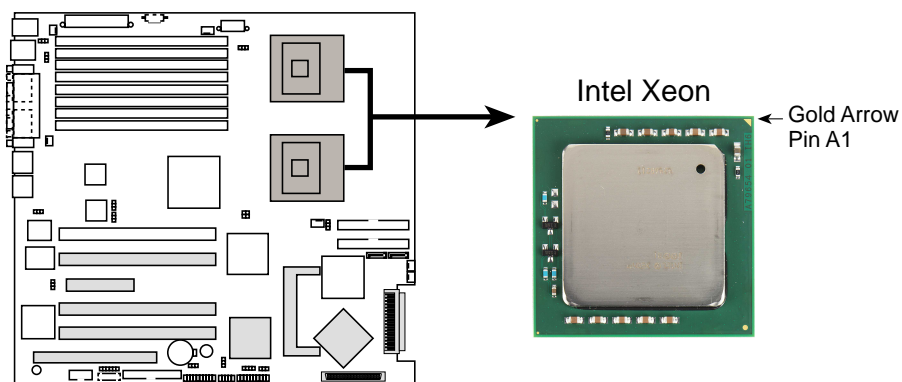

**NCL-DS Series CPU Socket 604**



---

If installing only one CPU, use the socket CPU1.

---

2. Flip up the socket lever and push it all the way to the other side.



---

Make sure that the socket lever is pushed back all the way, otherwise the CPU does not fit in completely.

---

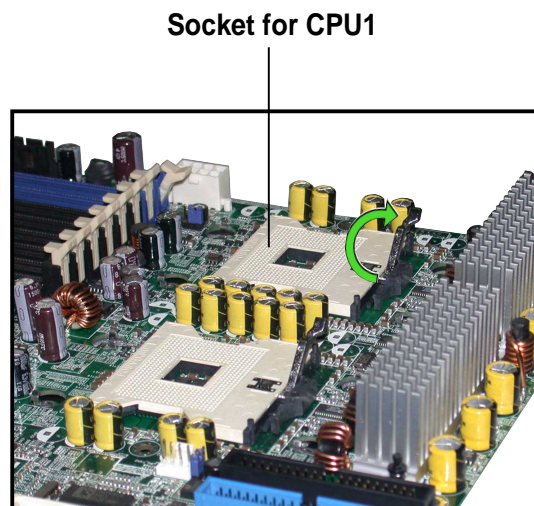

3. Position the CPU above the socket as shown.
4. Carefully insert the CPU into the socket until it fits in place.



The CPU fits only in one correct orientation. DO NOT force the CPU into the socket to prevent bending the pins and damaging the CPU!

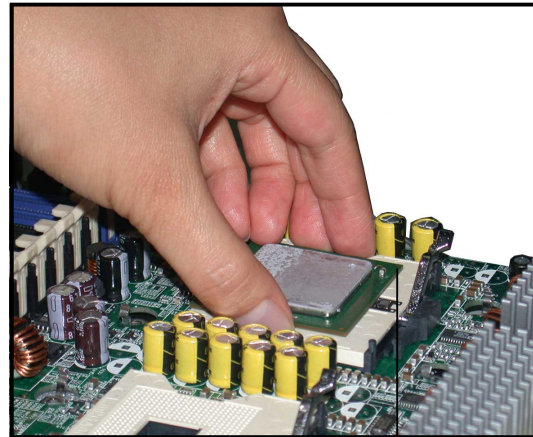

Marked corner  
(gold arrow)

5. Carefully push down the socket lever to secure the CPU. The lever clicks on the side tab to indicate that it is locked.
6. Apply the thermal interface material (thermal grease) to the top of the CPU. This thermal grease should come with the CPU package.
7. Repeat steps 1 to 6 if you wish to install a second CPU.

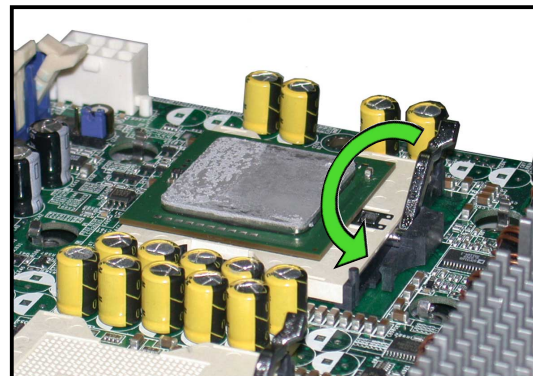



## 2.3.2 Installing the CPU heatsink and fan

The Intel® Xeon™ processors require an Intel certified heatsink and fan assembly to ensure optimum thermal condition and performance.

When you buy a boxed Intel CPU, the package includes the heatsink, fan, retention brackets, screws, thermal grease, installation manual, and other items that are necessary for CPU installation.



- Make sure that you have applied the thermal grease to the top of the CPU before installing the heatsink and fan.
- Refer to the installation manual that came with the CPU package for details on heatsink/fan assembly and installation.

CPU heatsink (top view)

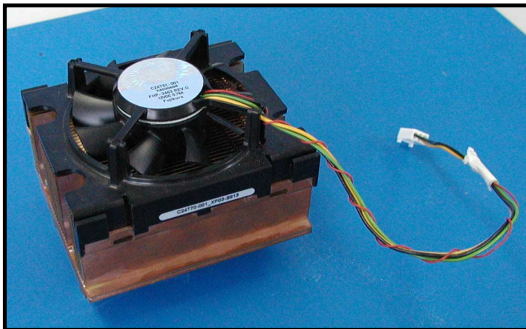

CPU heatsink (bottom view)

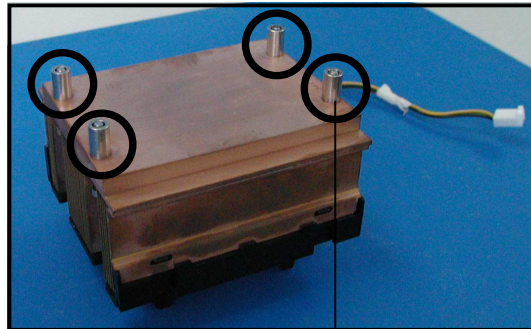

Heatsink screw



Before installing the CPU heatsinks, ensure that the jumpers FM\_CPU1 and FM\_CPU2 are set correctly depending on the pin definition of your CPU fan cables. Refer to page 2-19 for information on these jumpers.

To install the CPU heatsink and fan:

1. Place the heatsink on top of the installed CPU, making sure that the four screws on the heatsink align with the nuts on the support plate.

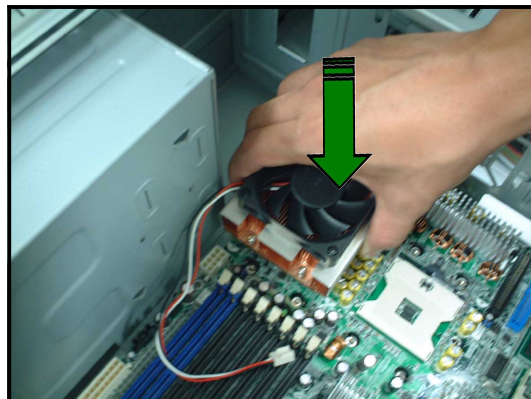

2. Use a Phillips screwdriver to tighten the four heatsink screws in a diagonal sequence.

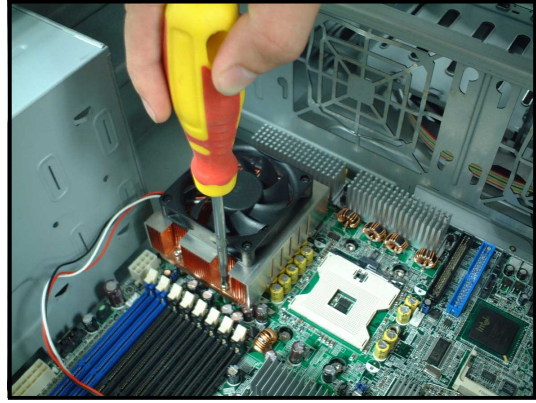

3. Connect the fan cable to the 4-pin connector labeled CPU\_FAN1.



Do not forget to connect the CPU fan connector! Hardware monitoring errors may occur if you fail to plug this connector.

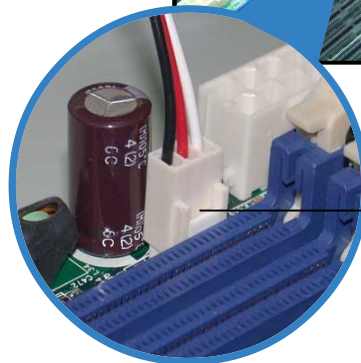
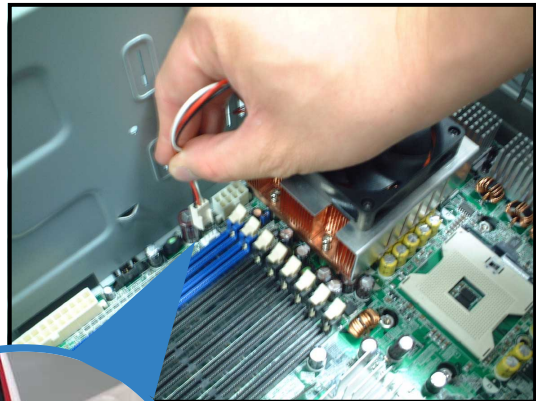

**CPU\_FAN1**  
connector

4. Repeat steps 1 to 3 to install the other heatsink if you have installed a second CPU, then connect the fan cable to the 4-pin connector labeled CPU\_FAN2.

The heatsinks appear as shown when installed.

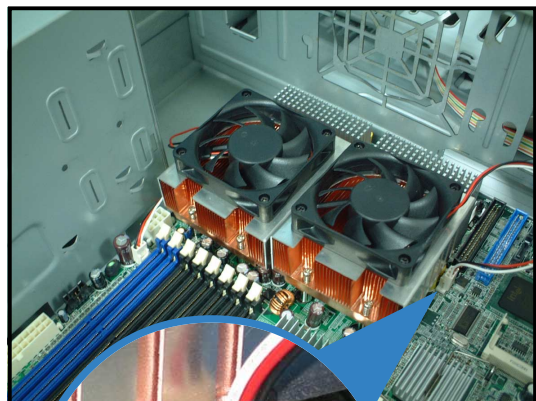

**CPU\_FAN2**  
connector

## 2.4 System memory

### 2.4.1 Overview

The motherboard comes with eight Double Data Rate 2 (DDR2) Dual Inline Memory Modules (DIMM) sockets to support 240-pin DDR2 modules.

The figure illustrates the location of the DDR2 DIMM sockets:

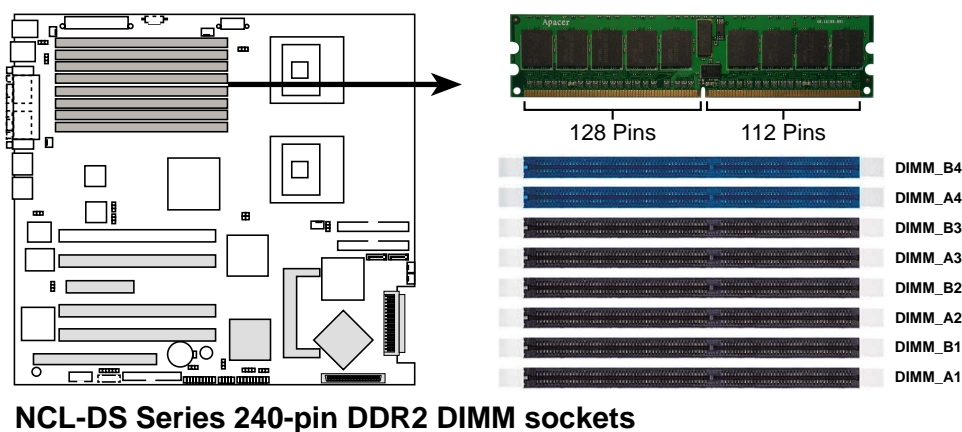

### 2.4.2 Memory configurations

You may install 256 MB, 512 MB and 1 GB registered ECC DDR2 DIMMs into the DIMM sockets.



- Always install DIMMs with the same CAS latency. For optimum compatibility, it is recommended that you obtain memory modules from the same vendor. Refer to the DDR2 Qualified Vendors List at the ASUS web site.
- Due to chipset resource allocation, the system may detect less than 16 GB system memory when you installed eight 2 GB DDR2 memory modules.
- This motherboard does not support memory modules made up of 128 Mb chips or double-rank x16 memory modules.
- If you are installing only one memory module, install into the blue socket labeled DIMM\_B4. Installing into any other socket would not work.

## Single rank population

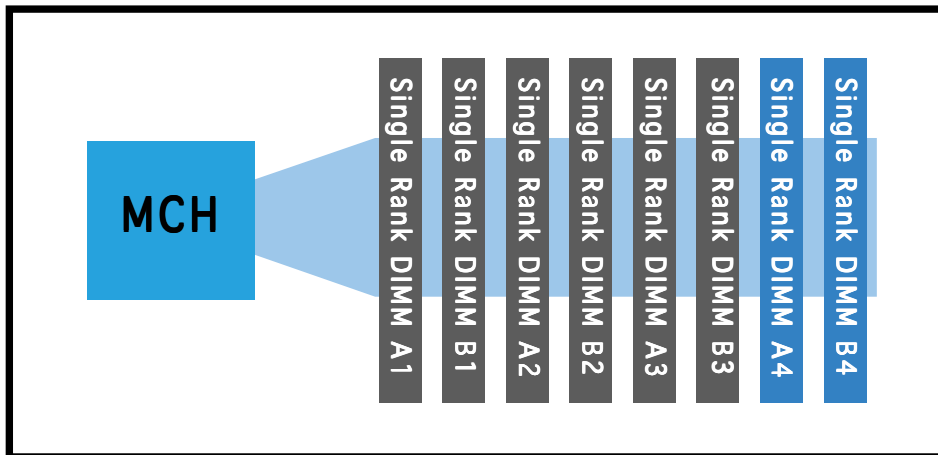

## Single and dual rank mixing

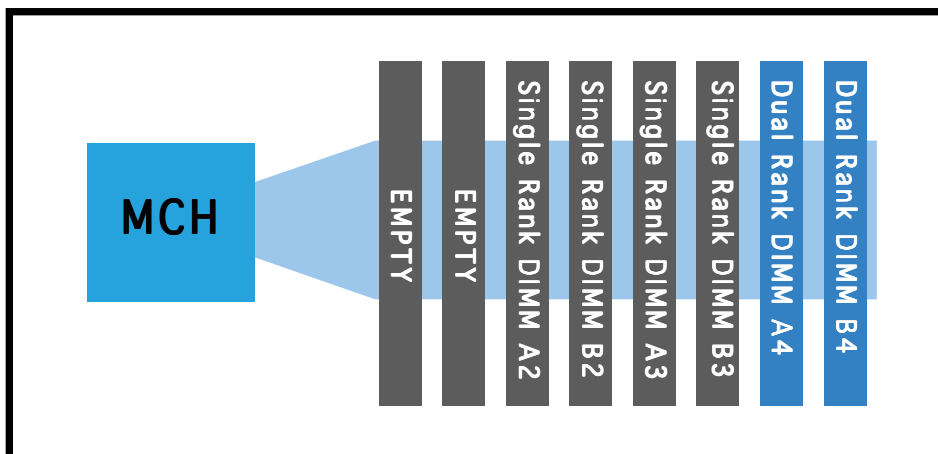

## Dual rank population

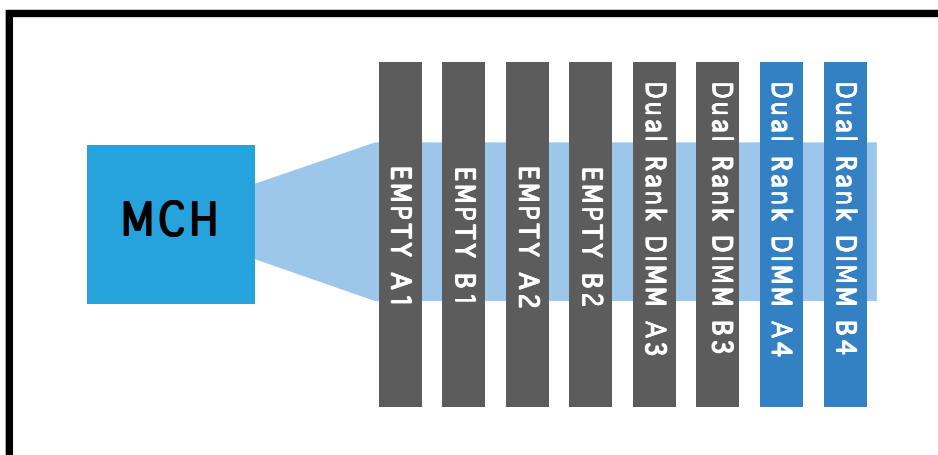

## 2.4.3 Installing a DIMM



Unplug the power supply before adding or removing DIMMs or other system components. Failure to do so can cause severe damage to both the motherboard and the components.

To install a DIMM:

1. Unlock a DIMM socket by pressing the retaining clips outward.
2. Align a DIMM on the socket such that the notch on the DIMM matches the break on the socket.
3. Firmly insert the DIMM into the socket until the retaining clips snap back in place and the DIMM is properly seated.

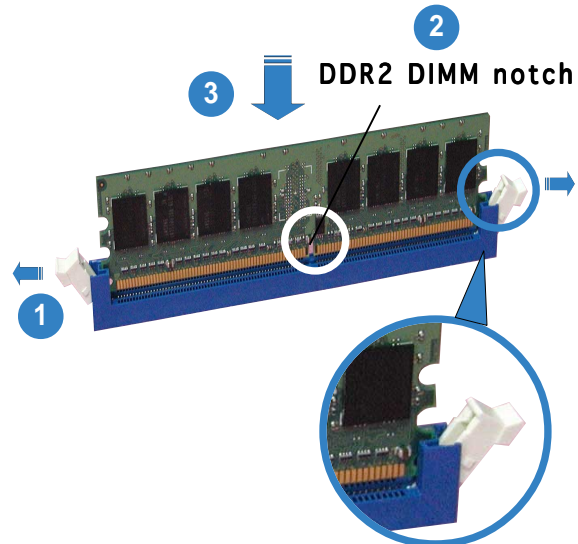

Unlocked retaining clip



- A DDR2 DIMM is keyed with a notch so that it fits in only one direction. Do not force a DIMM into a socket to avoid damaging the DIMM.
- The DDR2 DIMM sockets do not support DDR DIMMs. DO NOT install DDR DIMMs to the DDR2 DIMM sockets.

## 2.4.4 Removing a DIMM

Follow these steps to remove a DIMM.

1. Simultaneously press the retaining clips outward to unlock the DIMM.



Support the DIMM lightly with your fingers when pressing the retaining clips. The DIMM might get damaged when it flips out with extra force.

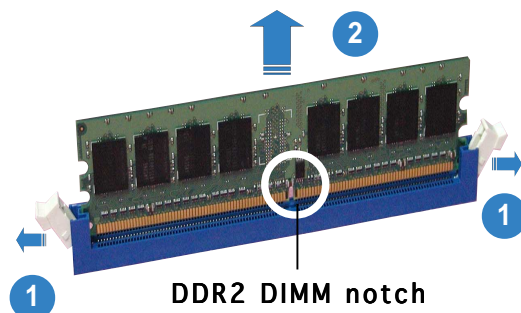

2. Remove the DIMM from the socket.



## 2.5 Expansion slots

In the future, you may need to install expansion cards. The following sub-sections describe the slots and the expansion cards that they support.



---

Make sure to unplug the power cord before adding or removing expansion cards. Failure to do so may cause you physical injury and damage motherboard components.

---

### 2.5.1 Installing an expansion card

To install an expansion card:

1. Before installing the expansion card, read the documentation that came with it and make the necessary hardware settings for the card.
2. Remove the system unit cover (if your motherboard is already installed in a chassis).
3. Remove the bracket opposite the slot that you intend to use. Keep the screw for later use.
4. Align the card connector with the slot and press firmly until the card is completely seated on the slot.
5. Secure the card to the chassis with the screw you removed earlier.
6. Replace the system cover.

### 2.5.2 Configuring an expansion card

After installing the expansion card, configure the it by adjusting the software settings.

1. Turn on the system and change the necessary BIOS settings, if any. See Chapter 4 for information on BIOS setup.
2. Assign an IRQ to the card. Refer to the tables on the next page.
3. Install the software drivers for the expansion card.



---

When using PCI cards on shared slots, ensure that the drivers support “Share IRQ” or that the cards do not need IRQ assignments. Otherwise, conflicts will arise between the two PCI groups, making the system unstable and the card inoperable.

---

## 2.5.3 Interrupt assignments

### Standard interrupt assignments

| IRQ | Priority | Standard Function            |
|-----|----------|------------------------------|
| 0   | 1        | System Timer                 |
| 1   | 2        | Keyboard Controller          |
| 2   | —        | Re-direct to IRQ#9           |
| 3   | 11       | Communications Port (COM2)*  |
| 4   | 12       | Communications Port (COM1)*  |
| 5   | 13       | IRQ holder for PCI steering* |
| 6   | 14       | Floppy Disk Controller       |
| 7   | 15       | Printer Port (LPT1)*         |
| 8   | 3        | System CMOS/Real Time Clock  |
| 9   | 4        | IRQ holder for PCI steering* |
| 10  | 5        | IRQ holder for PCI steering* |
| 11  | 6        | IRQ holder for PCI steering* |
| 12  | 7        | PS/2 Compatible Mouse Port*  |
| 13  | 8        | Numeric Data Processor       |
| 14  | 9        | Primary IDE Channel          |
| 15  | 10       | Secondary IDE Channel        |

\* These IRQs are usually available for ISA or PCI devices.

## 2.5.4 PCI/PCI-X slots

The PCI/PCI-X slots support cards such as a LAN card, SCSI card, USB card, and other cards that comply with PCI 2.3 and PCI-X 1.0 specifications. The figure shows a LAN card installed on a PCI slot.

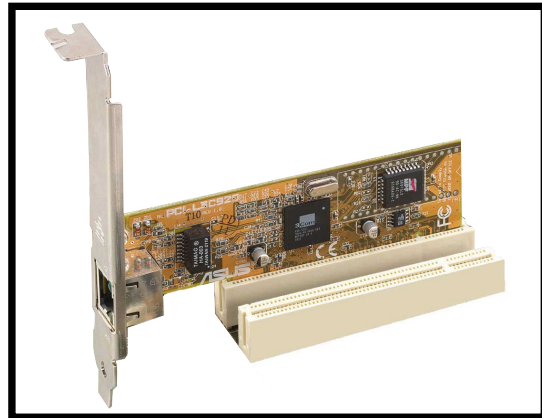

## 2.5.5 PCI Express x8 slot

The onboard PCI Express x8 slot provides x4 link to the MCH. This slot is designed for various server class high performance add-on cards like SCSI RAID card, fiber-channel card, etc.

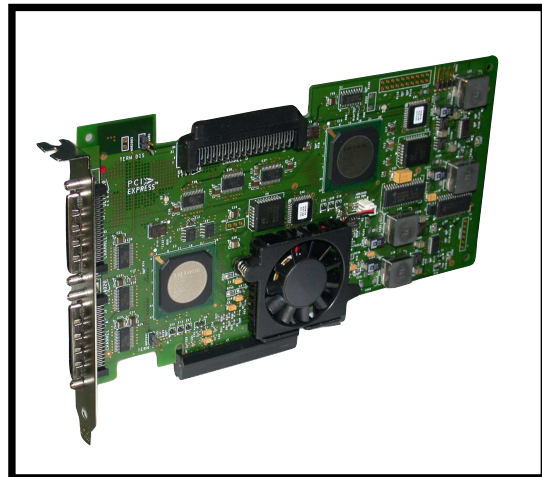

## 2.5.6 ZCR socket

The ZCR socket on the motherboard supports the Adaptec AIC-2015 Zero-Channel RAID card that allows RAID0, RAID1, RAID10, and RAID 5 configurations.

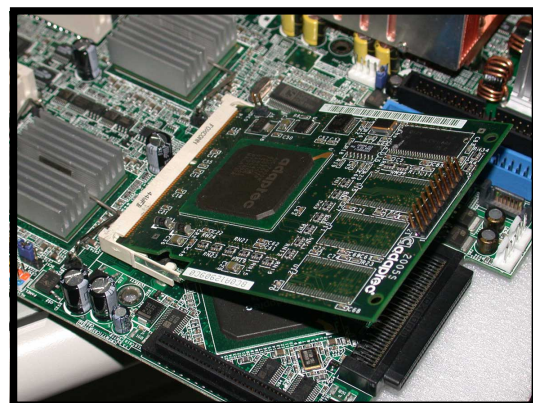

The NCL-DS and NCL-D models include all slots. The NCL-DR1 model includes only one PCI-X 64-bit slot.



## 2.6 Jumpers



The grayed out components in the illustrations may not be present in certain models.

### 1. Clear RTC RAM (CLRTC1)

This jumper allows you to clear the Real Time Clock (RTC) RAM in CMOS. You can clear the CMOS memory of date, time, and system setup parameters by erasing the CMOS RTC RAM data. The onboard button cell battery powers the RAM data in CMOS, which include system setup information such as system passwords.

To erase the RTC RAM:

1. Turn OFF the computer and unplug the power cord.
2. Remove the onboard battery.
3. Move the jumper cap from pins 1-2 (default) to pins 2-3. Keep the cap on pins 2-3 for about 5~10 seconds, then move the cap back to pins 1-2.
4. Re-install the battery.
5. Plug the power cord and turn ON the computer.
6. Hold down the <Del> key during the boot process and enter BIOS setup to re-enter data.



Except when clearing the RTC RAM, never remove the cap on CLRTC1 jumper default position. Removing the cap will cause system boot failure!

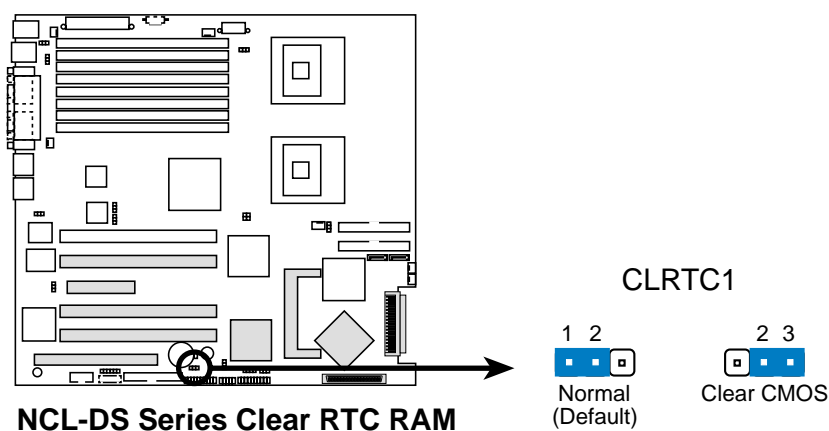

## 2. CPU fan pin selection (3-pin FM\_CPU1, FM\_CPU2)

These jumpers allow you to connect either a 3-pin or a 4-pin fan cable plug to the CPU fan connectors (CPU\_FAN1, CPU\_FAN2). Set these jumpers to pins 1-2 if you are using a 3-pin fan cable plug, or to pins 2-3 if you are using a 4-pin plug.

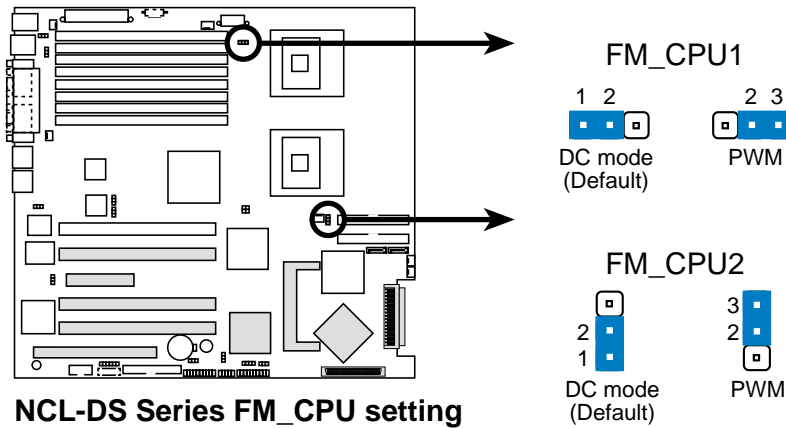

## 3. USB device wake-up (3-pin USBPW12, USBPW34)

Set these jumpers to +5V to wake up the computer from S1 sleep mode (CPU stopped, DRAM refreshed, system running in low power mode) using the connected USB devices. Set to +5VSB to wake up from S4 sleep mode (no power to CPU, DRAM in slow refresh, power supply in reduced power mode).

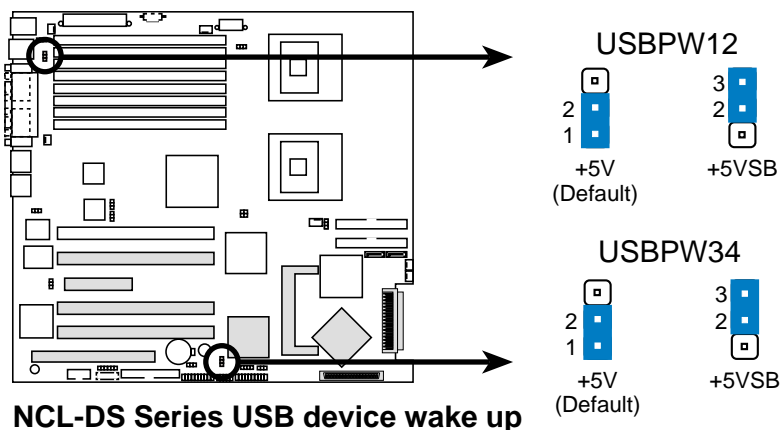

- The USB device wake-up feature requires a power supply that can provide 500mA on the +5VSB lead for each USB port; otherwise, the system would not power up.
- If you are using Windows 2000, you need to install Service Pack 4 to wake up the system from S4 sleep mode.
- The total current consumed must NOT exceed the power supply capability (+5VSB) whether under normal condition or in sleep mode.

#### 4. Keyboard power (3-pin KBPWR1)

This jumper allows you to enable or disable the keyboard wake-up feature. Set this jumper to pins 2-3 (+5VSB) to wake up the computer when you press a key on the keyboard (the default is the Space Bar). This feature requires an ATX power supply that can supply at least 1A on the +5VSB lead, and a corresponding setting in the BIOS.

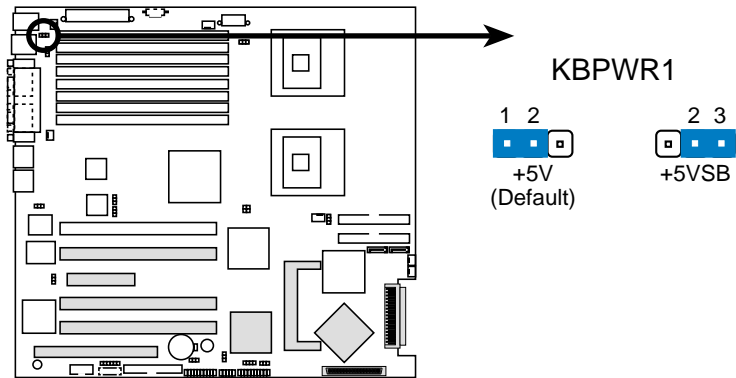

**NCL-DS Series Keyboard power setting**

#### 5. VGA controller setting (3-pin VGA\_EN1)

These jumpers allow you to enable or disable the onboard ATI® RAGE-XL PCI VGA controller. Set to pins 1-2 to activate the VGA feature.

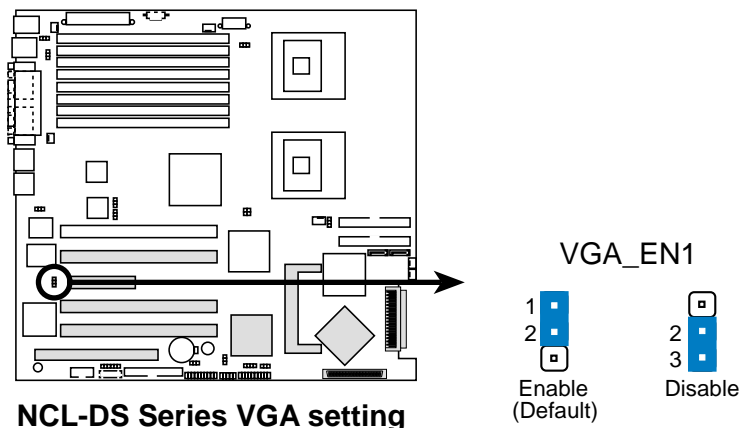

**NCL-DS Series VGA setting**

## 6. Gigabit LAN controller setting (3-pin LAN1\_EN1)

This jumper allows you to enable or disable the onboard Broadcom® BCM5751 Gigabit LAN1 controller. Set to pins 1-2 to activate the Gigabit LAN feature.

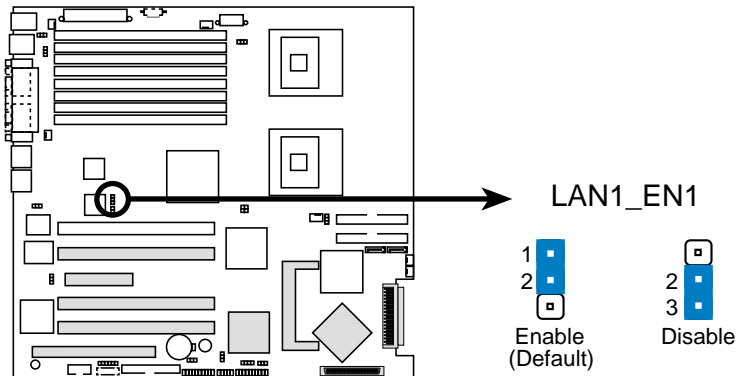

**NCL-DS Series LAN1\_EN setting**

## 7. Gigabit LAN controller setting (3-pin LAN2\_EN1)

These jumpers allow you to enable or disable the onboard Broadcom BCM5751 Gigabit LAN2 controller. Set to pins 1-2 to activate the Gigabit LAN feature.

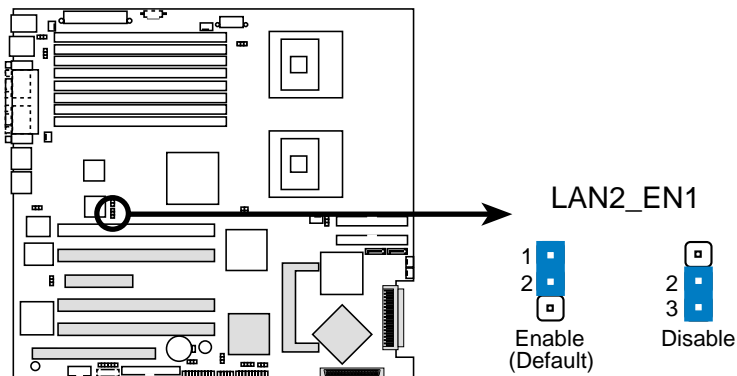

**NCL-DS Series LAN2\_EN setting**

## 8. SCSI controller setting (3-pin SCSI\_EN1) (works in NCL-DS model only)

This jumper allows you to enable or disable the onboard Adaptec® AIC-7902 SCSI U320 controller. Set to pins 1-2 to activate the SCSI feature, and support RAID configurations.

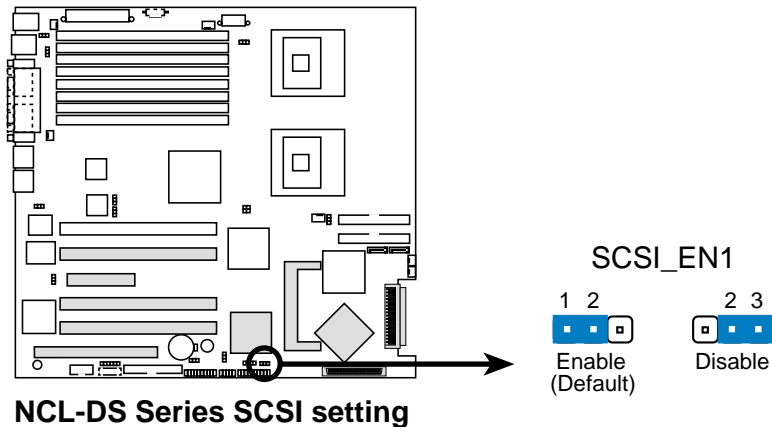

## 9. Force BIOS recovery setting (3-pin RECOVERY1)

This jumper allows you to quickly update or recover the BIOS settings when it becomes corrupted.

To update the BIOS:

1. Prepare a floppy disk that contains the latest BIOS for the motherboard (xxxx-xxx.ROM) and the AFUDOS.EXE utility.
2. Set the jumper to pins 2-3.
3. Insert the floppy disk then turn on the system to update the BIOS.
4. Shut down the system.
5. Set the jumper back to pins 1-2.
6. Turn on the system.

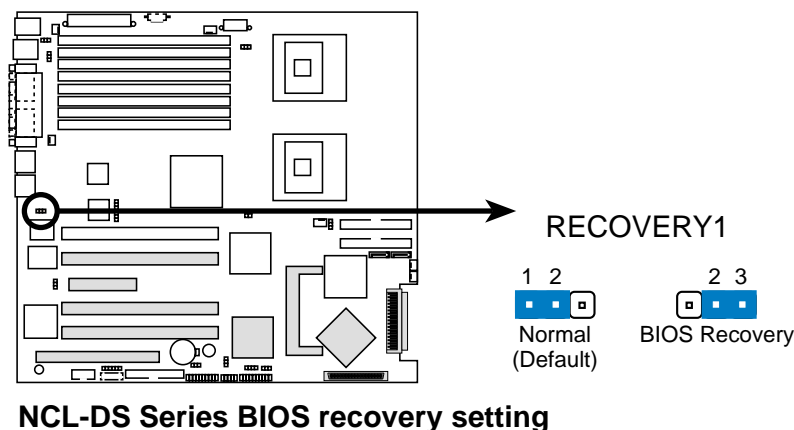

## 2.7 Connectors

### 2.7.1 Rear panel connectors

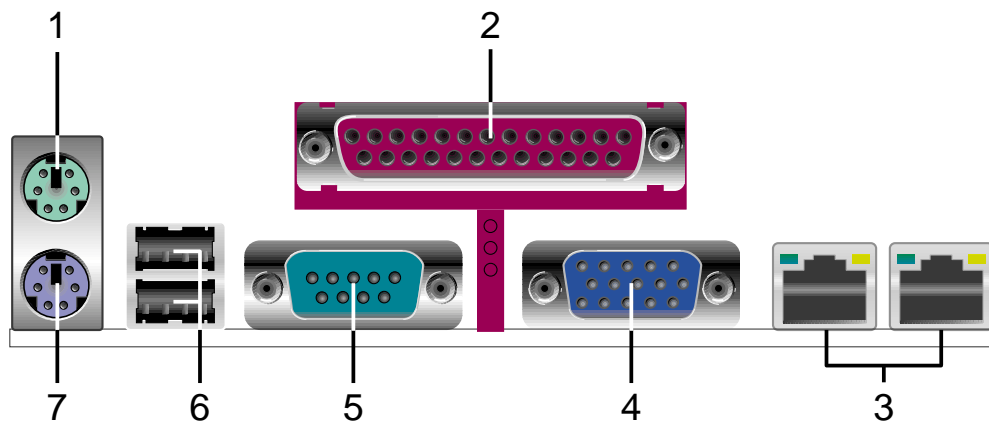

1. **PS/2 mouse port (green).** This port is for a PS/2 mouse.
2. **Parallel port.** This 25-pin port connects a parallel printer, a scanner, or other devices. *(present in NCL-DS and NCL-D models only)*
3. **LAN (RJ-45) ports.** These ports allow Gigabit connection to a Local Area Network (LAN) through a network hub. Refer to the table below for the LAN port LED indications.

#### LAN port LED indications

| ACT/LINK LED |               | SPEED LED |                      |
|--------------|---------------|-----------|----------------------|
| Status       | Description   | Status    | Description          |
| OFF          | No link       | OFF       | 10 Mbps connection   |
| GREEN        | Linked        | ORANGE    | 100 Mbps connection  |
| BLINKING     | Data activity | GREEN     | 1000 Mbps connection |

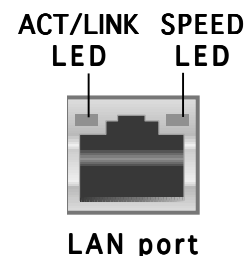

4. **VGA port.** This port is for a VGA monitor or other VGa-compatible devices.
5. **Serial (COM1) port.** This 9-pin communication port is for pointing devices or other serial devices.
6. **USB 2.0 ports 1 and 2.** These two 4-pin Universal Serial Bus (USB) ports are available for connecting USB 2.0 devices.
7. **PS/2 keyboard port (purple).** This port is for a PS/2 keyboard.

## 2.7.2 Internal connectors

### 1. Floppy disk drive connector (34-1 pin FLOPPY1)

This connector is for the provided floppy disk drive (FDD) signal cable. Insert one end of the cable to this connector, then connect the other end to the signal connector at the back of the floppy disk drive.



Pin 5 on the connector is removed to prevent incorrect cable connection when using a FDD cable with a covered Pin 5.

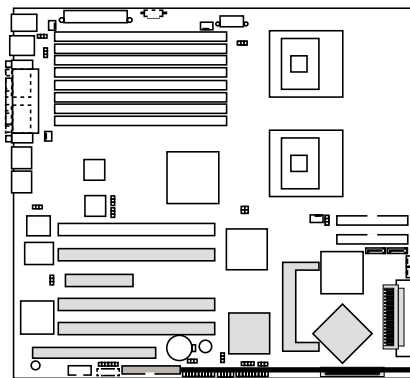

**NOTE:** Orient the red markings on the floppy ribbon cable to PIN 1.

**NCL-DS Series Floppy disk drive connector**

### 2. Primary IDE connectors (40-1 pin PRI\_IDE, SEC\_IDE)

These connectors are for an Ultra DMA 100/66 signal cable. The Ultra DMA 100/66 signal cable has three connectors: a blue connector for the primary IDE connector on the motherboard, a black connector for an Ultra DMA 100/66 IDE slave device (optical drive/hard disk drive), and a gray connector for an Ultra DMA 100/66 IDE master device (hard disk drive). If you install two hard disk drives, you must configure the second drive as a slave device by setting its jumper accordingly. Refer to the hard disk documentation for the jumper settings.



- Pin 20 on the IDE connector is removed to match the covered hole on the Ultra DMA cable connector. This prevents incorrect insertion when you connect the IDE cable.
- Use the 80-conductor IDE cable for Ultra DMA 100/66 IDE devices.

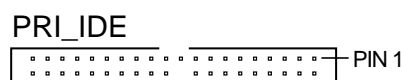
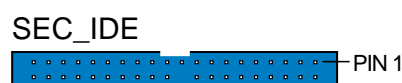
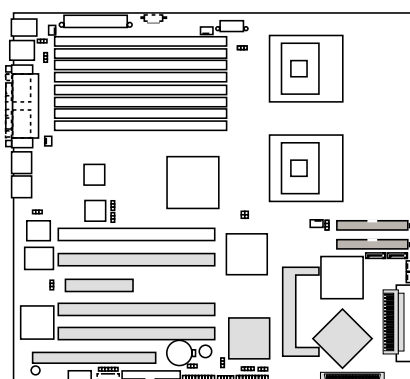

**NOTE:** Orient the red markings (usually zigzag) on the IDE ribbon cable to PIN 1.

**NCL-DS Series IDE connectors**

### 3. Serial ATA connectors (7-pin SATA1, SATA2)

These connectors are for the Serial ATA signal cables for Serial ATA hard disk drives.

If you installed Serial ATA hard disk drives, you can create a RAID 0 or RAID 1 configuration with the Intel® Matrix Storage Technology through the onboard Intel® ICH5R integrated RAID controller.



These connectors are set to **Standard IDE** mode by default. In **Standard IDE** mode, you can connect Serial ATA boot/data hard disk drives to these connectors. If you intend to create a Serial ATA RAID set using these connectors, set the **Configure SATA As** item in the BIOS to [RAID]. See section “4.3.6 IDE Configuration” on page 4-15 for details.

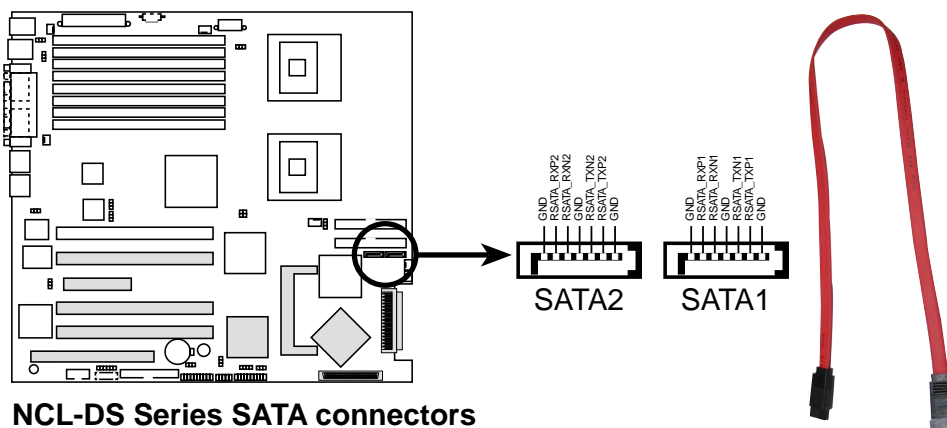

NCL-DS Series SATA connectors



#### Important notes on Serial ATA

- You must install Windows® 2000 Service Pack 4 or the Windows® XP Service Pack 1 before using Serial ATA hard disk drives. The Serial ATA RAID feature (RAID 0/RAID 1) is available only if you are using Windows® 2000/XP.
- Use only two Serial ATA RAID connectors for each RAID 0 or RAID 1 set.
- When using the connectors in **Standard IDE** mode, connect the primary (boot) hard disk drive to the SATA1 or SATA2 connector. Refer to the table below for the recommended SATA hard disk drive connections.

#### Serial ATA hard disk drive connection

| Connector | Setting | Use       |
|-----------|---------|-----------|
| SATA1     | Master  | Boot disk |
| SATA2     | Slave   | Data disk |



#### 4. Ultra320 SCSI connectors (two 68-pin SCSI A1, SCSI B1) (present in NCL-DS model only)

This motherboard comes with the Adaptec® AIC-7902 SCSI U320 controller that support two 68-Pin Ultra320 SCSI connectors, one for each of the two channels. Each channel can support a maximum of 15 devices as specified by Ultra320 standards.

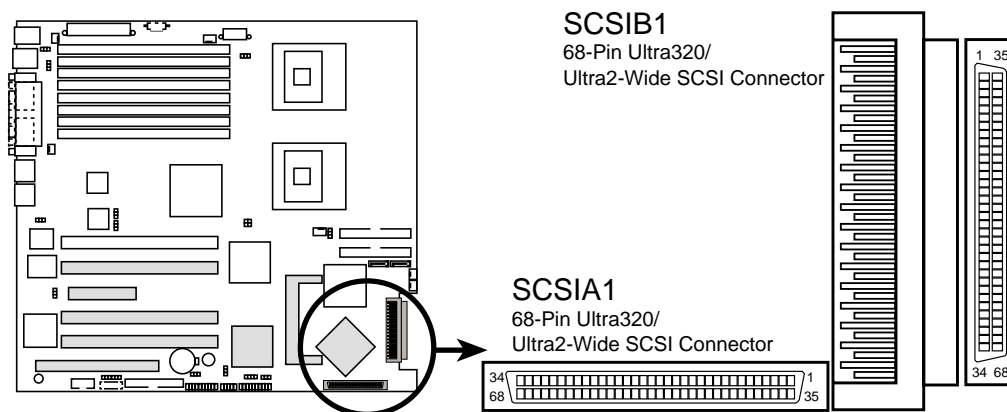

**NCL-DS Series Onboard SCSI connectors**

#### SCSI Connection Notes

This motherboard has two 68-Pin Ultra320 SCSI connectors; one for each of the two channels.

The onboard SCSI chipset incorporates an advanced multimode I/O cell that supports both single-ended (SE), Ultra2, Ultra160, and Ultra320 devices. With Ultra320 devices, the SCSI bus platform performs at full Ultra320 speeds (up to 320MB/s) and extended cabling 12m (or 25m in a point-to-point configuration). When an SE device is attached, the bus defaults to an SE speed and 1.5m cable length.



Connect SCSI devices as shown. Each channel should have only one type of SCSI standard (e.g. Ultra320, Ultra160, Ultra2, Ultra-Wide). Mixing SCSI devices on the same channel decreases performance of the slower device.

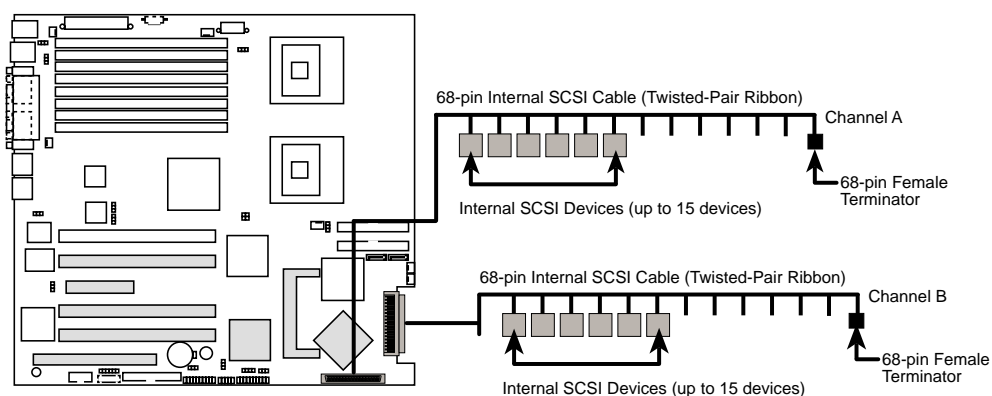

**NCL-DS Series SCSI connection example**

## 5. Hard disk activity LED connector (4-pin HDLED1)

This connector supplies power to the hard disk activity LED. The read or write activities of any device connected to the primary/secondary IDE connectors or the SATA connectors cause this LED to light up.

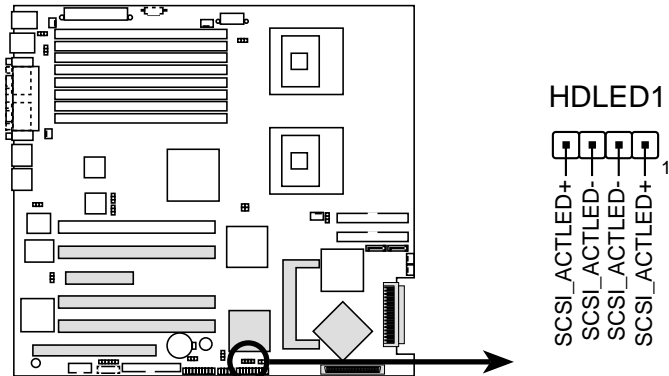

**NCL-DS Series SCSI/SATA card activity LED connector**

## 6. USB connector (10-1 pin USB34)

This connector is for USB 2.0 ports. Connect the USB module cable to this connector, then install the module to a slot opening at the back of the system chassis. This USB connector complies with USB 2.0 specification that supports up to 480 Mbps connection speed.

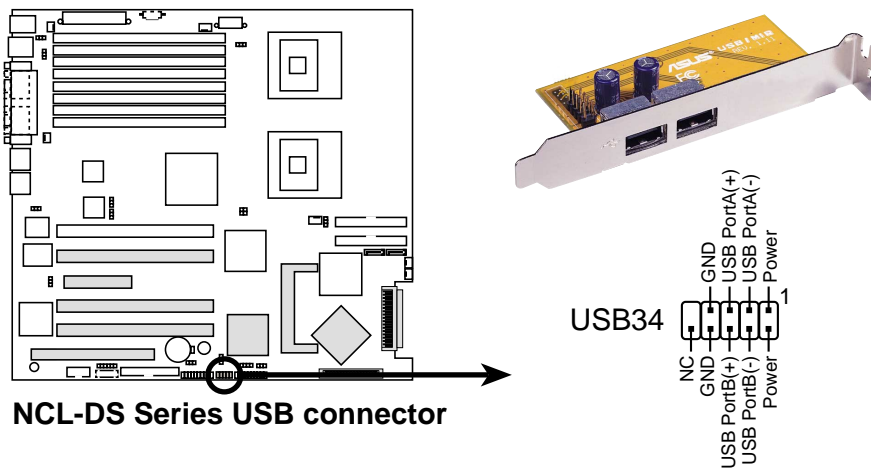

**NCL-DS Series USB connector**

## 7. CPU and system fan connectors (3-pin CPU\_FAN1/2, REAR\_FAN1/2, FRNT\_FAN1/2)

The fan connectors support cooling fans of 350 mA ~ 740 mA (8.88 W max.) or a total of 2.1 A ~ 4.44 A (53.28 W max.) at +12V. Connect the fan cables to the fan connectors on the motherboard, making sure that the black wire of each cable matches the ground pin of the connector.



Do not forget to connect the fan cables to the fan connectors. Insufficient air flow inside the system may damage the motherboard components. These are not jumpers! Do not place jumper caps on the fan connectors!

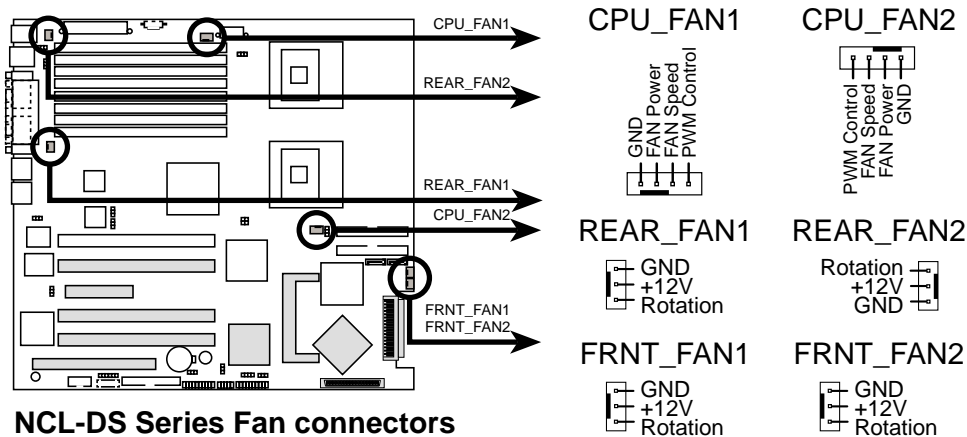

## 8. Power supply SMBus connector (5-pin PSUSMB1)

This connector is for the power supply SMB cable, if your power supply supports the SMBus function.

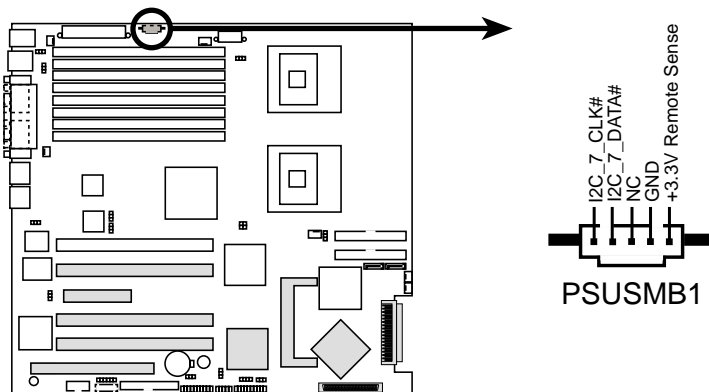

## 9. Backplane SMBus connector (6-1 pin BPSMB1)

This connector allows you to connect SMBus (System Management Bus) devices. Devices communicate with an SMBus host and/or other SMBus devices using the SMBus interface.

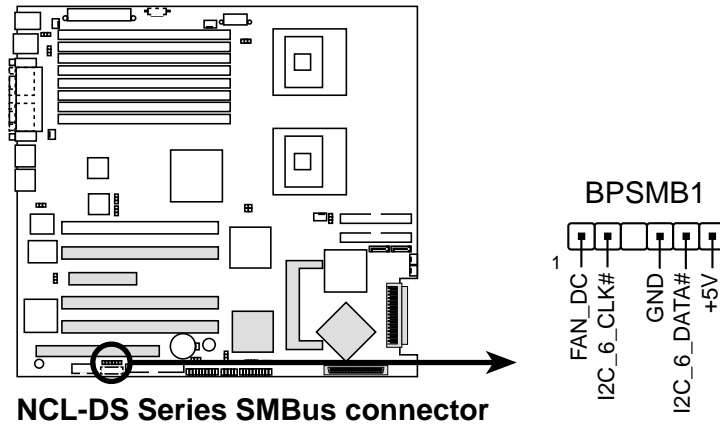

## 10. Serial port connector (10-1 pin COM2)

This connector is for a serial (COM) port. Connect the serial port module cable to this connector, then install the module to a slot opening at the back of the system chassis.

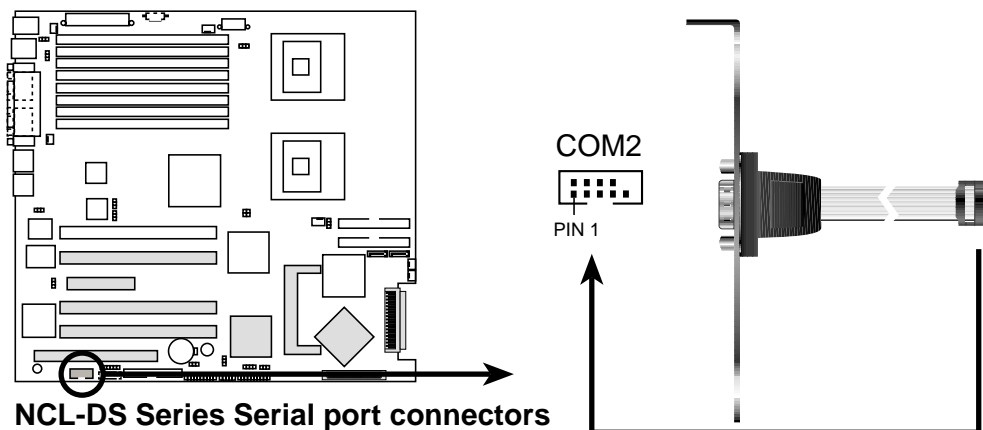

## 11. ATX power connectors (24-pin ATXPWR1, 8-pin ATX12V1)

These connectors are for SSI power supply plugs. The power supply plugs are designed to fit these connectors in only one orientation. Find the proper orientation and push down firmly until the connectors completely fit.



- Use of an SSI 12 V Specification 2.0-compliant power supply unit (PSU) that provides a minimum power of 450 W is recommended for a fully-configured system.
- Do not forget to connect the 8-pin ATX +12 V power plug; otherwise, the system will not boot up.
- Use of a PSU with a higher power output is recommended when configuring a system with more power consuming devices. The system may become unstable or may not boot up if the power is inadequate.
- You must install a PSU with a higher power rating if you intend to install additional devices.

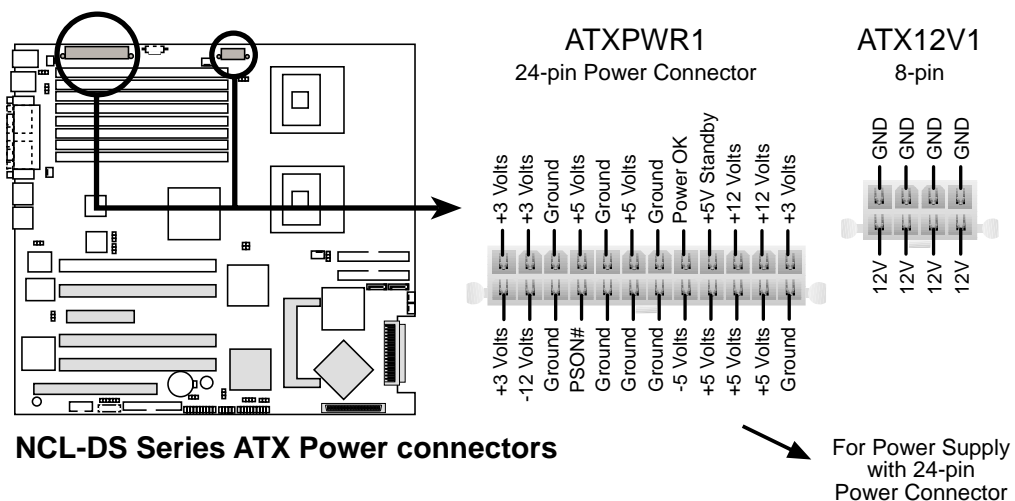

## 12. BMC connector (16-pin BMCCONN1)

This connector is for the ASUS server management card, if available.

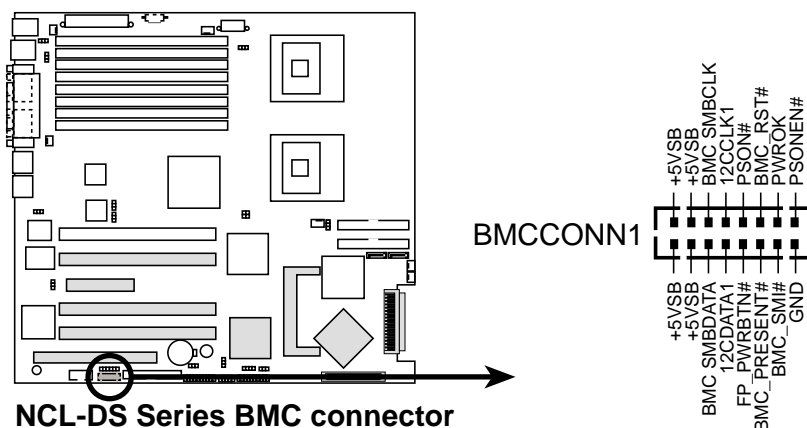

### 13. System panel connector (20-pin PANEL1)

This connector supports several chassis-mounted functions.

- **System power LED (Green 3-pin PLED)**  
This 3-pin connector is for the system power LED. Connect the chassis power LED cable to this connector. The system power LED lights up when you turn on the system power, and blinks when the system is in sleep mode.
- **Hard disk drive activity LED (Red 2-pin IDE\_LED)**  
This 2-pin connector is for the HDD Activity LED. Connect the HDD Activity LED cable to this connector. The IDE LED lights up or flashes when data is read from or written to the HDD.
- **System warning speaker (Orange 4-pin SPEAKER)**  
This 4-pin connector is for the chassis-mounted system warning speaker. The speaker allows you to hear system beeps and warnings.
- **ATX power button/soft-off button (Yellow 2-pin PWRSW)**  
This connector is for the system power button. Pressing the power button turns the system on or puts the system in sleep or soft-off mode depending on the BIOS settings. Pressing the power switch for more than four seconds while the system is ON turns the system OFF.
- **Reset button (Blue 2-pin RESET)**  
This 2-pin connector is for the chassis-mounted reset button for system reboot without turning off the system power.

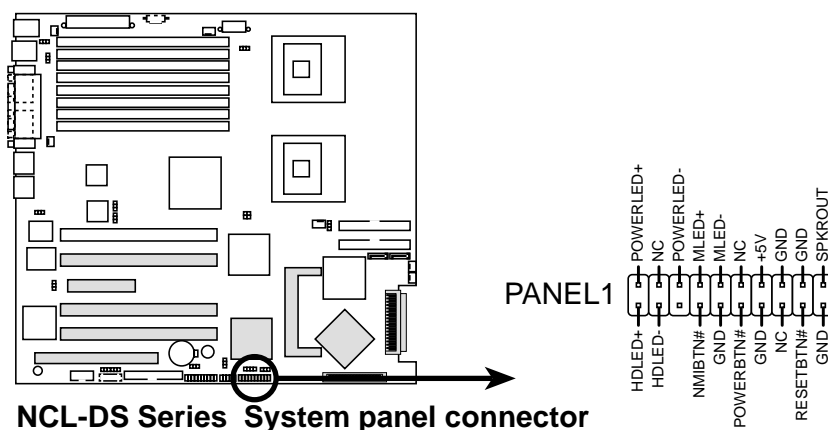

The system panel connector is color-coded for easy connection.

## 14. Auxiliary panel connector (20-pin AUX\_PANEL1)

This connector is for additional front panel features including front panel SMB, locator LED and switch, chassis intrusion, and LAN LEDs.

- **Front panel SMB (6-1 pin FPSMB)**  
These leads connect the front panel SMBus cable.
- **LAN activity LED (2-pin 547\_LED, 541\_LED)**  
These leads are for Gigabit LAN activity LEDs on the front panel.
- **Chassis intrusion (4-1 pin CHASSIS)**  
These leads are for the intrusion detection feature for chassis with intrusion sensor or microswitch. When you remove any chassis component, the sensor triggers and sends a high-level signal to these leads to record a chassis intrusion event.
- **Locator LED (6-pin LOCATOR)**  
These leads are for the locator switch and LED on the front panel.

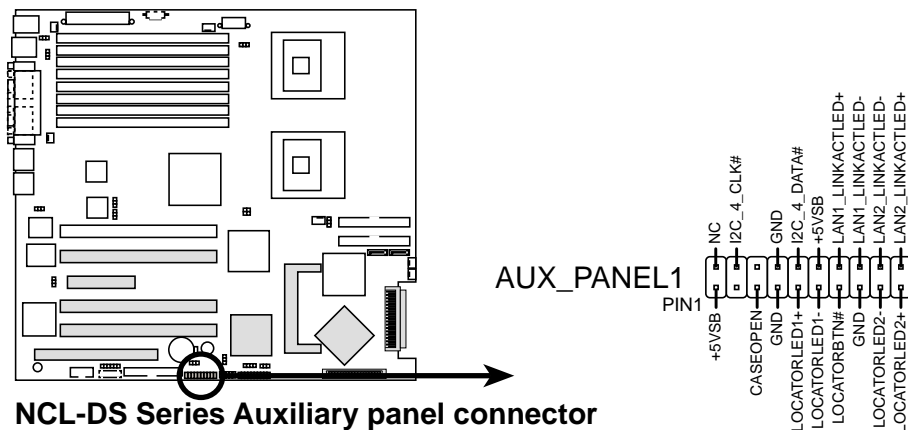





This chapter describes the power up sequence, the vocal POST messages, and ways of shutting down the system.

# Powering up

## Chapter summary

# 3

|     |                                      |     |
|-----|--------------------------------------|-----|
| 3.1 | Starting up for the first time ..... | 3-1 |
| 3.2 | Powering off the computer .....      | 3-2 |

## 3.1 Starting up for the first time

1. After making all the connections, replace the system case cover.
2. Be sure that all switches are off.
3. Connect the power cord to the power connector at the back of the system chassis.
4. Connect the power cord to a power outlet that is equipped with a surge protector.
5. Turn on the devices in the following order:
  - a. Monitor
  - b. External SCSI devices (starting with the last device on the chain)
  - c. System power
6. After applying power, the system power LED on the system front panel case lights up. For systems with ATX power supplies, the system LED lights up when you press the ATX power button. If your monitor complies with “green” standards or if it has a “power standby” feature, the monitor LED may light up or switch between orange and green after the system LED turns on.

The system then runs the power-on self tests or POST. While the tests are running, the BIOS beeps (see BIOS beep codes table below) or additional messages appear on the screen. If you do not see anything within 30 seconds from the time you turned on the power, the system may have failed a power-on test. Check the jumper settings and connections or call your retailer for assistance.

### AMI BIOS beep codes

| Beep Description                                  | Error   |
|---|---|
| One beep  | Keyboard controller error<br>Refresh Time error<br>No master drive detected |
| Two continuous beeps followed by two short beeps  | Floppy controller failure   |
| Two continuous beeps followed by four short beeps | Hardware component failure  |

7. At power on, hold down the <Delete> key to enter the BIOS Setup. Follow the instructions in Chapter 4.

## 3.2 Powering off the computer

### 3.2.1 Using the OS shut down function

If you are using Windows® 2000:

1. Click the **Start** button then click **Shut Down...**
2. Make sure that the **Shut Down** option button is selected, then click the **OK** button to shut down the computer.
3. The power supply should turn off after Windows® shuts down.

If you are using Windows® XP:

1. Click the **Start** button then select **Turn Off Computer.**
2. Click the **Turn Off** button to shut down the computer.
3. The power supply should turn off after Windows® shuts down.

### 3.2.2 Using the dual function power switch

While the system is ON, pressing the power switch for less than four seconds puts the system to sleep mode or to soft-off mode, depending on the BIOS setting. Pressing the power switch for more than four seconds lets the system enter the soft-off mode regardless of the BIOS setting. Refer to section “4.5 Power Menu” in Chapter 4 for details.

This chapter tells how to change the system settings through the BIOS Setup menus. Detailed descriptions of the BIOS parameters are also provided.

# BIOS setup

## Chapter summary

# 4

|     |                                       |      |
|-----|---------------------------------------|------|
| 4.1 | Managing and updating your BIOS ..... | 4-1  |
| 4.2 | BIOS setup program .....              | 4-10 |
| 4.3 | Main menu .....                       | 4-13 |
| 4.4 | Advanced menu .....                   | 4-18 |
| 4.5 | Power menu .....                      | 4-27 |
| 4.6 | Boot menu .....                       | 4-32 |
| 4.7 | Exit menu .....                       | 4-38 |

## 4.1 Managing and updating your BIOS

The following utilities allow you to manage and update the motherboard Basic Input/Output System (BIOS) setup.

1. **ASUS AFUDOS** (Updates the BIOS in DOS mode using a bootable floppy disk.)
2. **ASUS CrashFree BIOS 2** (Updates the BIOS using a bootable floppy disk or the motherboard support CD when the BIOS file fails or gets corrupted.)
3. **ASUS Update** (Updates the BIOS in Windows® environment.)

Refer to the corresponding sections for details on these utilities.



---

Save a copy of the original motherboard BIOS file to a bootable floppy disk in case you need to restore the BIOS in the future. Copy the original motherboard BIOS using the ASUS Update or AFUDOS utilities.

---

### 4.1.1 Creating a bootable floppy disk

1. Do either one of the following to create a bootable floppy disk.

#### DOS environment

- a. Insert a 1.44MB floppy disk into the drive.
- b. At the DOS prompt, type **format A:/S** then press <Enter>.

#### Windows® XP environment

- a. Insert a 1.44 MB floppy disk to the floppy disk drive.
- b. Click **Start** from the Windows® desktop, then select **My Computer**.
- c. Select the 3 1/2 Floppy Drive icon.
- d. Click **File** from the menu, then select **Format**. A **Format 3 1/2 Floppy Disk** window appears.
- e. **Windows® XP users:** Select **Create an MS-DOS startup disk** from the format options field, then click **Start**.

### Windows® 2000 environment

To create a set of boot disks for Windows® 2000:

- a. Insert a formatted, high density 1.44 MB floppy disk into the drive.
  - b. Insert the Windows® 2000 CD to the optical drive.
  - c. Click **Start**, then select **Run**.
  - d. In the **Open** field, type `D:\bootdisk\makeboot a:` assuming that D is your optical drive letter.
  - e. Press <Enter>, then follow screen instructions to continue.
2. Copy the original or the latest motherboard BIOS file to the bootable floppy disk.

## 4.1.2 AFUDOS utility

The AFUDOS utility allows you to update the BIOS file in DOS environment using a bootable floppy disk with the updated BIOS file. This utility also allows you to copy the current BIOS file that you can use as backup when the BIOS fails or gets corrupted during the updating process.

### Copying the current BIOS

To copy the current BIOS file using the AFUDOS utility:



- Make sure that the floppy disk is not write-protected and has at least 600 KB free space to save the file.
- The succeeding BIOS screens are for reference only. The actual BIOS screen displays may not be same as shown.

1. Copy the AFUDOS utility (afudos.exe) from the motherboard support CD to the bootable floppy disk you created earlier.
2. Boot the system in DOS mode, then at the prompt type:

```
afudos /o[filename]
```

where the [filename] is any user-assigned filename not more than eight alphanumeric characters for the main filename and three alphanumeric characters for the extension name.

```
A:\>afudos /oOLDBIOS1.rom
```

Main filename      Extension name



3. Press <Enter>. The utility copies the current BIOS file to the floppy disk.

```
A:\>afudos /oOLDBIOS1.rom
AMI Firmware Update Utility - Version 1.19 (ASUS V2.07 (03.11.24BB))
Copyright (C) 2002 American Megatrends, Inc. All rights reserved.
  Reading flash ..... done
  Write to file..... ok
A:\>
```

The utility returns to the DOS prompt after copying the current BIOS file.

## Updating the BIOS file

To update the BIOS file using the AFUDOS utility:

1. Visit the ASUS website ([www.asus.com](http://www.asus.com)) and download the latest BIOS file for the motherboard. Save the BIOS file to a bootable floppy disk.



---

Write the BIOS filename on a piece of paper. You need to type the exact BIOS filename at the DOS prompt.

---

2. Copy the AFUDOS utility (afudos.exe) from the motherboard support CD to the bootable floppy disk you created earlier.
3. Boot the system in DOS mode, then at the prompt type:

```
afudos /i[filename] /pbnc
```

where [filename] is the latest or the original BIOS file on the bootable floppy disk.

```
A:\>afudos /iNCLDS.rom /pbnc
```



---

Use the appropriate BIOS file depending on your motherboard model (e.g. NCLDS.ROM, NCLD.ROM, or NCLDR1.ROM)

---

4. The utility verifies the file and starts updating the BIOS.

```
A:\>afudos /iNCLDS.ROM /pbnc
AMI Firmware Update Utility - Version 1.19(ASUS V2.07(03.11.24BB))
Copyright (C) 2002 American Megatrends, Inc. All rights reserved.

WARNING!! Do not turn off power during flash BIOS
Reading file ..... done
Reading flash ..... done

Advance Check .....
Erasing flash ..... done
Writing flash ..... 0x0008CC00 (9%)
```



---

Do not shut down or reset the system while updating the BIOS to prevent system boot failure!

---

5. The utility returns to the DOS prompt after the BIOS update process is completed. Reboot the system from the hard disk drive.

```
A:\>afudos /iNCLDS.ROM /pbnc
AMI Firmware Update Utility - Version 1.19(ASUS V2.07(03.11.24BB))
Copyright (C) 2002 American Megatrends, Inc. All rights reserved.

WARNING!! Do not turn off power during flash BIOS
Reading file ..... done
Reading flash ..... done

Advance Check .....
Erasing flash ..... done
Writing flash ..... done
Verifying flash .... done

Please restart your computer

A:\>
```

### 4.1.3 ASUS CrashFree BIOS 2 utility

The ASUS CrashFree BIOS 2 is an auto recovery tool that allows you to restore the BIOS file when it fails or gets corrupted during the updating process. You can update a corrupted BIOS file using the motherboard support CD or the floppy disk that contains the updated BIOS file.



- Prepare the motherboard support CD or the floppy disk containing the updated motherboard BIOS before using this utility.
- Make sure that you rename the original or updated BIOS file in the floppy disk to **NCLDS.ROM**.

### Recovering the BIOS from a floppy disk

To recover the BIOS from a floppy disk:

1. Turn on the system.
2. Insert the floppy disk with the original or updated BIOS file to the floppy disk drive.
3. The utility displays the following message and automatically checks the floppy disk for the original or updated BIOS file.

```
Bad BIOS checksum. Starting BIOS recovery...  
Checking for floppy...
```

When found, the utility reads the BIOS file and starts flashing the corrupted BIOS file.

```
Bad BIOS checksum. Starting BIOS recovery...  
Checking for floppy...  
Floppy found!  
Reading file "NCLDS.ROM". Completed.  
Start flashing...
```



DO NOT shut down or reset the system while updating the BIOS! Doing so can cause system boot failure!

4. Restart the system after the utility completes the updating process.

## Recovering the BIOS from the support CD

To recover the BIOS from the support CD:

1. Remove any floppy disk from the floppy disk drive, then turn on the system.
2. Insert the support CD to the optical drive.
3. The utility displays the following message and automatically checks the floppy disk for the original or updated BIOS file.

```
Bad BIOS checksum. Starting BIOS recovery...  
Checking for floppy...
```

When no floppy disk is found, the utility automatically checks the optical drive for the original or updated BIOS file. The utility then updates the corrupted BIOS file.

```
Bad BIOS checksum. Starting BIOS recovery...  
Checking for floppy...  
Floppy not found!  
Checking for CD-ROM...  
CD-ROM found!  
Reading file "NCLDS.ROM". Completed.  
Start flashing...
```



---

DO NOT shut down or reset the system while updating the BIOS! Doing so can cause system boot failure!

---

4. Restart the system after the utility completes the updating process.



---

The recovered BIOS may not be the latest BIOS version for this motherboard. Visit the ASUS website ([www.asus.com](http://www.asus.com)) to download the latest BIOS file.

---

## 4.1.4 ASUS Update utility

The ASUS Update is a utility that allows you to manage, save, and update the motherboard BIOS in Windows® environment. The ASUS Update utility allows you to:

- Save the current BIOS file
- Download the latest BIOS file from the Internet
- Update the BIOS from an updated BIOS file
- Update the BIOS directly from the Internet, and
- View the BIOS version information.

This utility is available in the support CD that comes with the motherboard package.



---

ASUS Update requires an Internet connection either through a network or an Internet Service Provider (ISP).

---

## Installing ASUS Update

To install ASUS Update:

1. Place the support CD in the optical drive. The **Drivers** menu appears.
2. Click the **Utilities** tab, then click **Install ASUS Update VX.XX.XX**.
3. The ASUS Update utility is copied to your system.



---

Quit all Windows® applications before you update the BIOS using this utility.

---

## Updating the BIOS through the Internet

To update the BIOS through the Internet:

1. Launch the ASUS Update utility from the Windows® desktop by clicking **Start > Programs > ASUS > ASUSUpdate > ASUSUpdate**. The ASUS Update main window appears.

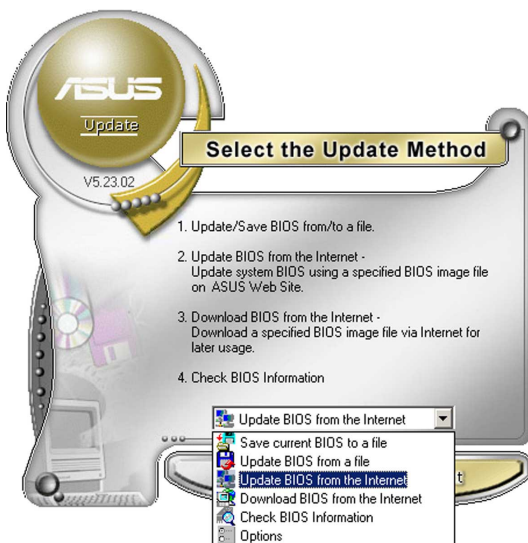
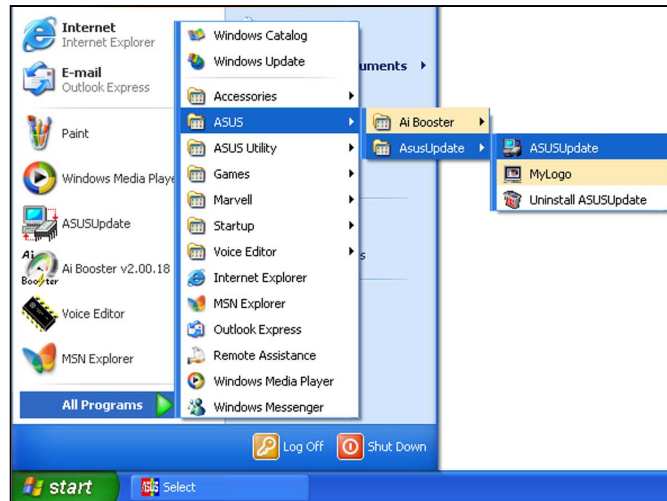

2. Select **Update BIOS from the Internet** option from the drop-down menu, then click **Next**.



3. Select the ASUS FTP site nearest you to avoid network traffic, or click **Auto Select**. Click **Next**.

4. From the FTP site, select the BIOS version that you wish to download. Click Next.
5. Follow the screen instructions to complete the update process.



The ASUS Update utility is capable of updating itself through the Internet. Always update the utility to avail all its features.

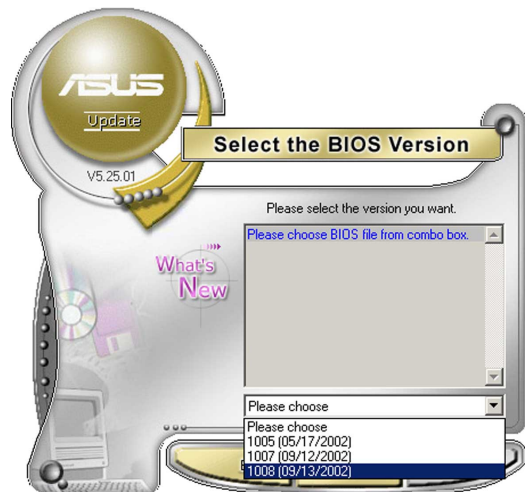

## Updating the BIOS through a BIOS file

To update the BIOS through a BIOS file:

1. Launch the ASUS Update utility from the Windows® desktop by clicking **Start > Programs > ASUS > ASUSUpdate > ASUSUpdate**. The ASUS Update main window appears.
2. Select **Update BIOS from a file** option from the drop-down menu, then click **Next**.

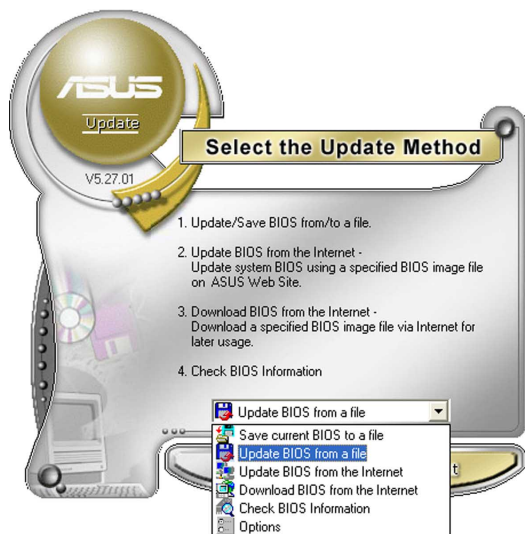

3. Locate the BIOS file from the **Open** window, then click **Save**.
4. Follow the screen instructions to complete the update process.

## 4.2 BIOS setup program

This motherboard supports a programmable firmware chip that you can update using the provided utility described in section “4.1 Managing and updating your BIOS.”

Use the BIOS Setup program when you are installing a motherboard, reconfiguring your system, or prompted to “Run Setup”. This section explains how to configure your system using this utility.

Even if you are not prompted to use the Setup program, you can change the configuration of your computer in the future. For example, you can enable the security password feature or change the power management settings. This requires you to reconfigure your system using the BIOS Setup program so that the computer can recognize these changes and record them in the CMOS RAM of the firmware hub.

The firmware hub on the motherboard stores the Setup utility. When you start up the computer, the system provides you with the opportunity to run this program. Press <Del> during the Power-On-Self-Test (POST) to enter the Setup utility; otherwise, POST continues with its test routines.

If you wish to enter Setup after POST, restart the system by pressing <Ctrl+Alt+Delete>, or by pressing the reset button on the system chassis. You can also restart by turning the system off and then back on. Do this last option only if the first two failed.

The Setup program is designed to make it as easy to use as possible. Being a menu-driven program, it lets you scroll through the various sub-menus and make your selections from the available options using the navigation keys.



- 
- The default BIOS settings for this motherboard apply for most conditions to ensure optimum performance. If the system becomes unstable after changing any BIOS settings, load the default settings to ensure system compatibility and stability. Select the **Load Setup Defaults** item under the Exit Menu. See section “4.7 Exit Menu.”
  - The BIOS setup screens shown in this section are for reference purposes only, and may not exactly match what you see on your screen.
  - Visit the ASUS website ([www.asus.com](http://www.asus.com)) to download the latest BIOS file for this motherboard.
-



## 4.2.1 BIOS menu screen

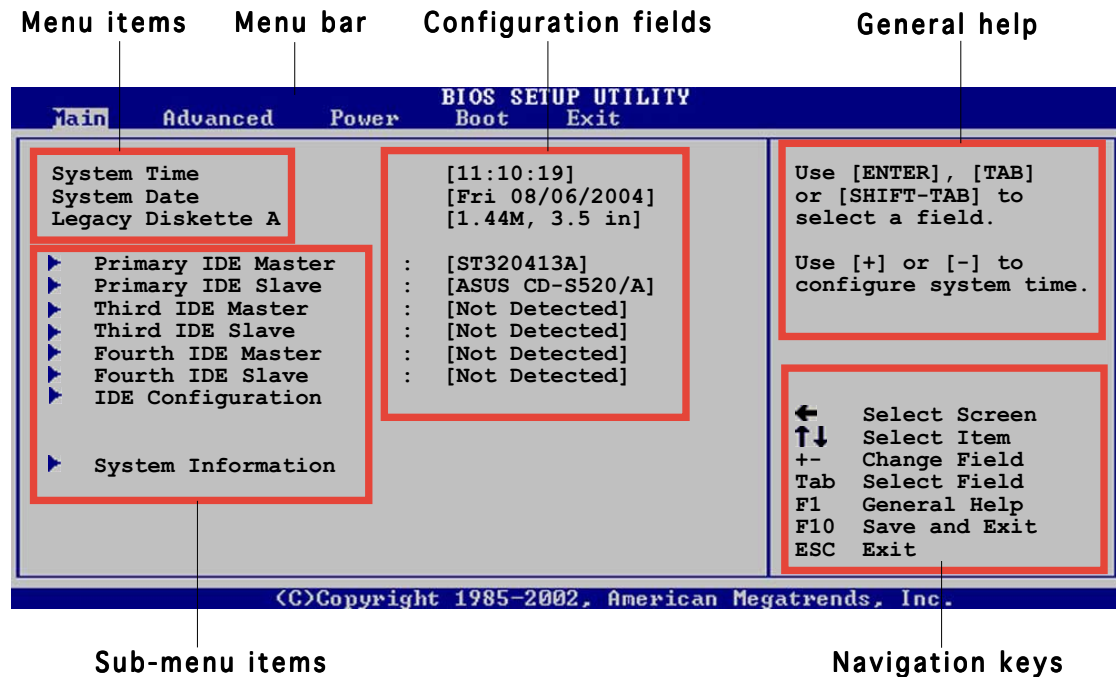

## 4.2.2 Menu bar

The menu bar on top of the screen has the following main items:

- Main** For changing the basic system configuration
- Advanced** For changing the advanced system settings
- Power** For changing the advanced power management (APM) configuration
- Boot** For changing the system boot configuration
- Exit** For selecting the exit options and loading default settings

To select an item on the menu bar, press the right or left arrow key on the keyboard until the desired item is highlighted.

## 4.2.3 Navigation keys

At the bottom right corner of a menu screen are the navigation keys for that particular menu. Use the navigation keys to select items in the menu and change the settings.



Some of the navigation keys differ from one screen to another.

## 4.2.4 Menu items

The highlighted item on the menu bar displays the specific items for that menu. For example, selecting **Main** shows the Main menu items.

The other items (Advanced, Power, Boot, and Exit) on the menu bar have their respective menu items.

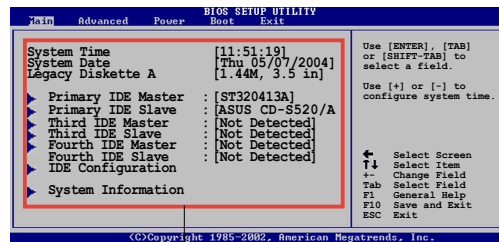

Main menu items

## 4.2.5 Sub-menu items

A solid triangle before each item on any menu screen means that the item has a sub-menu. To display the sub-menu, select the item and press <Enter>.

## 4.2.6 Configuration fields

These fields show the values for the menu items. If an item is user-configurable, you can change the value of the field opposite the item. You cannot select an item that is not user-configurable.

A configurable field is enclosed in brackets, and is highlighted when selected. To change the value of a field, select it then press <Enter> to display a list of options. Refer to “4.2.7 Pop-up window.”

## 4.2.7 Pop-up window

Select a menu item then press <Enter> to display a pop-up window with the configuration options for that item.

## 4.2.8 Scroll bar

A scroll bar appears on the right side of a menu screen when there are items that do not fit on the screen. Press the Up/Down arrow keys or <Page Up> / <Page Down> keys to display the other items on the screen.

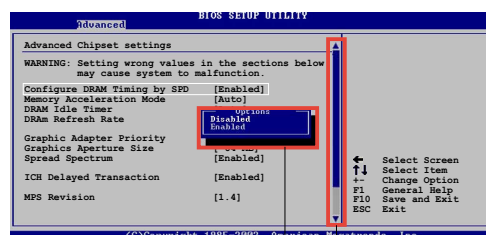

Pop-up window

Scroll bar

## 4.2.9 General help

At the top right corner of the menu screen is a brief description of the selected item.

## 4.3 Main menu

When you enter the BIOS Setup program, the **Main** menu screen appears, giving you an overview of the basic system information.



Refer to section “4.2.1 BIOS menu screen” for information on the menu screen items and how to navigate through them.

```
BIOS SETUP UTILITY
Main  Advanced  Power  Boot  Exit

System Time          [11:10:19]
System Date          [Fri 08/06/2004]
Legacy Diskette A    [1.44M, 3.5 in]

▶ Primary IDE Master  : [ST320413A]
▶ Primary IDE Slave   : [ASUS CD-S520/A]
▶ Third IDE Master    : [Not Detected]
▶ Third IDE Slave     : [Not Detected]
▶ Fourth IDE Master   : [Not Detected]
▶ Fourth IDE Slave    : [Not Detected]
▶ IDE Configuration

▶ System Information

Use [ENTER], [TAB]
or [SHIFT-TAB] to
select a field.

Use [+] or [-] to
configure system time.

← Select Screen
↑↓ Select Item
+- Change Field
Tab Select Field
F1 General Help
F10 Save and Exit
ESC Exit

(C)Copyright 1985-2002, American Megatrends, Inc.
```

### 4.3.1 System Time [xx:xx:xxxx]

Allows you to set the system time.

### 4.3.2 System Date [Day xx/xx/xxxx]

Allows you to set the system date.

### 4.3.3 Legacy Diskette A [1.44M, 3.5 in.]

Sets the type of floppy drive installed. Configuration options: [Disabled]  
[360K, 5.25 in.] [1.2M , 5.25 in.] [720K , 3.5 in.] [1.44M, 3.5 in.]  
[2.88M, 3.5 in.]

### 4.3.4 Primary, Third and Fourth IDE Master/Slave

The BIOS automatically detects the connected IDE devices. There is a separate sub-menu for each IDE device. Select a device item, then press <Enter> to display the IDE device information.

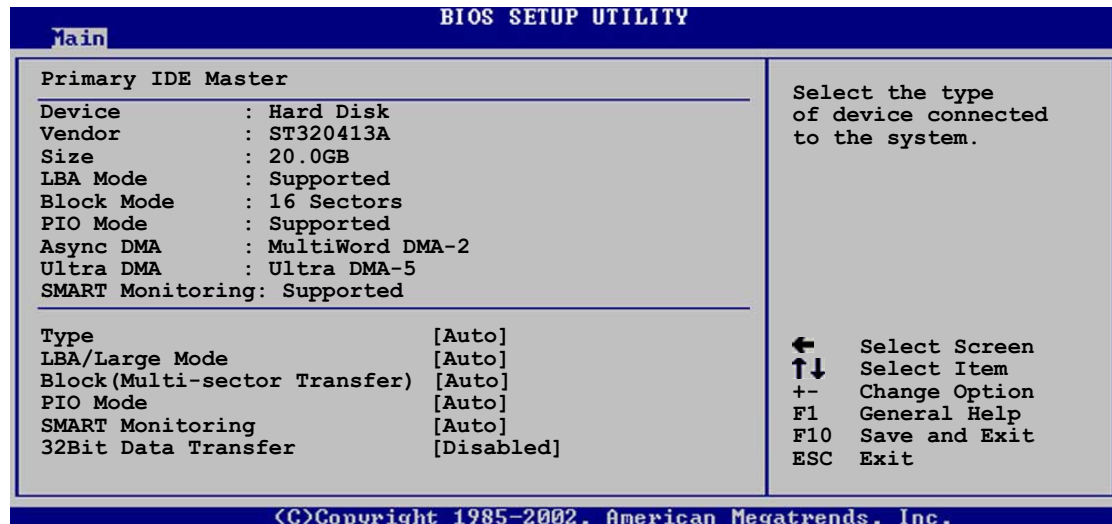

The BIOS automatically detects the values opposite the dimmed items (Device, Vendor, Size, LBA Mode, Block Mode, PIO Mode, Async DMA, Ultra DMA, and SMART monitoring). These values are not user-configurable. These items show N/A if no IDE device is installed in the system.

#### Type [Auto]

Selects the type of IDE drive. Setting to [Auto] allows automatic selection of the appropriate IDE device type. Select [CDROM] if you are specifically configuring a CD-ROM drive. Select [ARMD] (ATAPI Removable Media Device) if your device is either a ZIP, LS-120, or MO drive. Configuration options: [Not Installed] [Auto] [CDROM] [ARMD]

#### LBA/Large Mode [Auto]

Enables or disables the LBA mode. Setting to [Auto] enables the LBA mode if the device supports this mode, and if the device was not previously formatted with LBA mode disabled. Configuration options: [Disabled] [Auto]

#### Block (Multi-sector Transfer) [Auto]

Enables or disables data multi-sectors transfers. When set to [Auto], the data transfer from and to the device occurs multiple sectors at a time if the device supports multi-sector transfer feature. When set to [Disabled], the data transfer from and to the device occurs one sector at a time. Configuration options: [Disabled] [Auto]

### **PIO Mode [Auto]**

Selects the PIO mode.

Configuration options: [Auto] [0] [1] [2] [3] [4]

### **SMART Monitoring [Auto]**

Sets the Smart Monitoring, Analysis, and Reporting Technology.

Configuration options: [Auto] [Disabled] [Enabled]

### **32Bit Data Transfer [Disabled]**

Enables or disables 32-bit data transfer.

Configuration options: [Disabled] [Enabled]

## 4.3.5 IDE Configuration

The items in this menu allow you to set or change the configurations for the IDE devices installed in the system. Select an item then press <Enter> if you wish to configure the item.

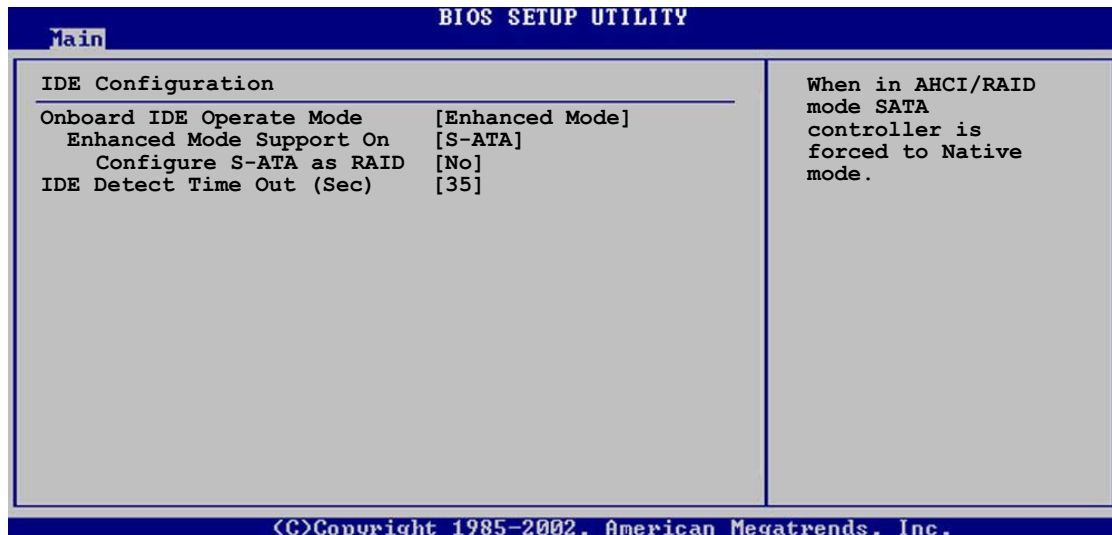

### Onboard IDE Operate Mode [Enhanced Mode]

Allows selection of the IDE operation mode depending on the installed operating system (OS). Set to [Enhanced Mode] if you are using native OS, e.g. Windows® 2000/XP. Set to [Compatible Mode] if you are using legacy OS, e.g. Windows ME/98/NT, MS-DOS.

Configuration options: [Compatible Mode] [Enhanced Mode]



The items **Enhanced Mode Support On** and **Configure S-ATA as RAID** appear only when you set the Onboard IDE Operate Mode to [Enhanced Mode].

#### *Enhanced Mode Support On [S-ATA]*

Allows you to set Serial ATA, Parallel ATA, or both, to native mode.

Configuration options: [P-ATA+S-ATA] [S-ATA] [ P-ATA]

#### **Configure S-ATA as RAID [No]**

Allows you to configure the Serial ATA devices as RAID sets.

Configuration options: [No] [Yes]

### IDE Detect Time Out (Sec) [35]

Selects the time our value (in seconds) for detecting ATA/ATAPI devices.

Configuration options: [0] [5] [10] [15] [20] [25] [30] [35]

## 4.3.6 System Information

This menu gives you an overview of the general system specifications. The BIOS automatically detects the items in this menu.

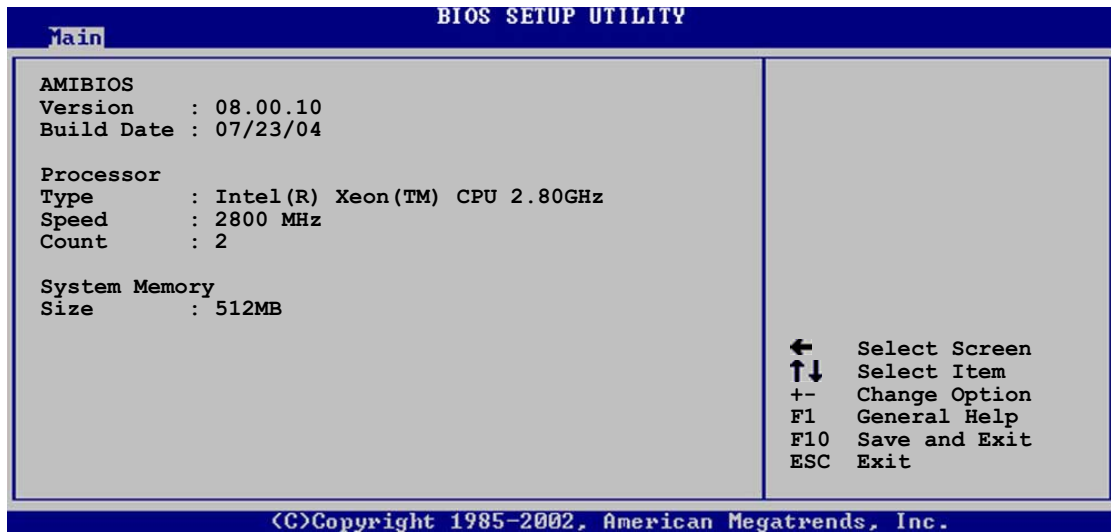

### AMI BIOS

Displays the auto-detected BIOS information

### Processor

Displays the auto-detected CPU specification

### System Memory

Displays the auto-detected system memory

## 4.4 Advanced menu

The Advanced menu items allow you to change the settings for the CPU and other system devices.



Take caution when changing the settings of the Advanced menu items. Incorrect field values can cause the system to malfunction.

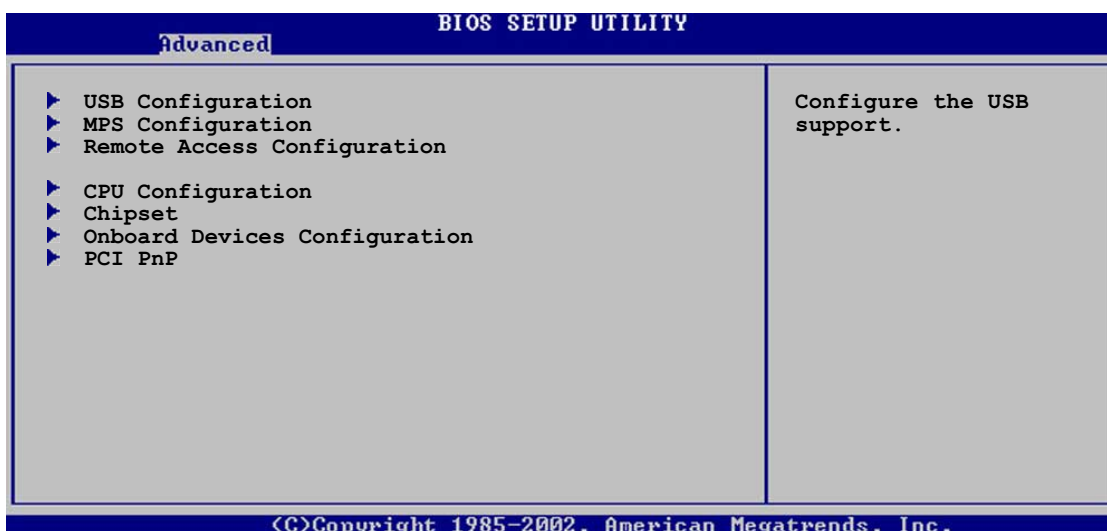

### 4.4.1 USB Configuration

The items in this menu allows you to change the USB-related features. Select an item then press <Enter> to display the configuration options.

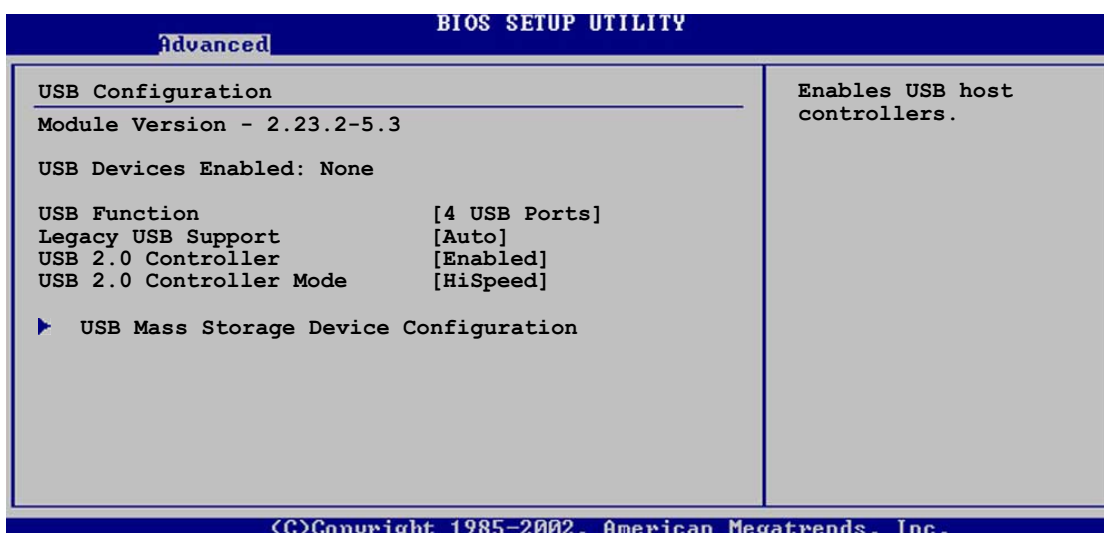

The **Module Version** and **USB Devices Enabled** items show the auto-detected values. If no USB device is detected, the **USB Devices Enabled** item shows **None**.



## USB Function [4 USB Ports]

Allows you to enable a specific number of USB ports, or disable the USB function. Configuration options: [Disabled] [2 USB Ports] [4 USB Ports]

## Legacy USB Support [Auto]

Allows you to enable or disable support for legacy USB devices. Setting to [Auto] allows the system to detect the presence of legacy USB devices at startup. If detected, the USB controller legacy mode is enabled. If no legacy USB device is detected, the legacy USB support is disabled.

Configuration options: [Disabled] [Enabled] [Auto]

## USB 2.0 Controller [Enabled]

Allows you to enable or disable the USB 2.0 controller.

Configuration options: [Enabled] [Disabled]

## USB 2.0 Controller Mode [HiSpeed]

Allows you to set the USB 2.0 controller mode to HiSpeed (480 Mbps) or FullSpeed (12 Mbps). Configuration options: [FullSpeed ] [HiSpeed]

## USB Mass Storage Device Configuration

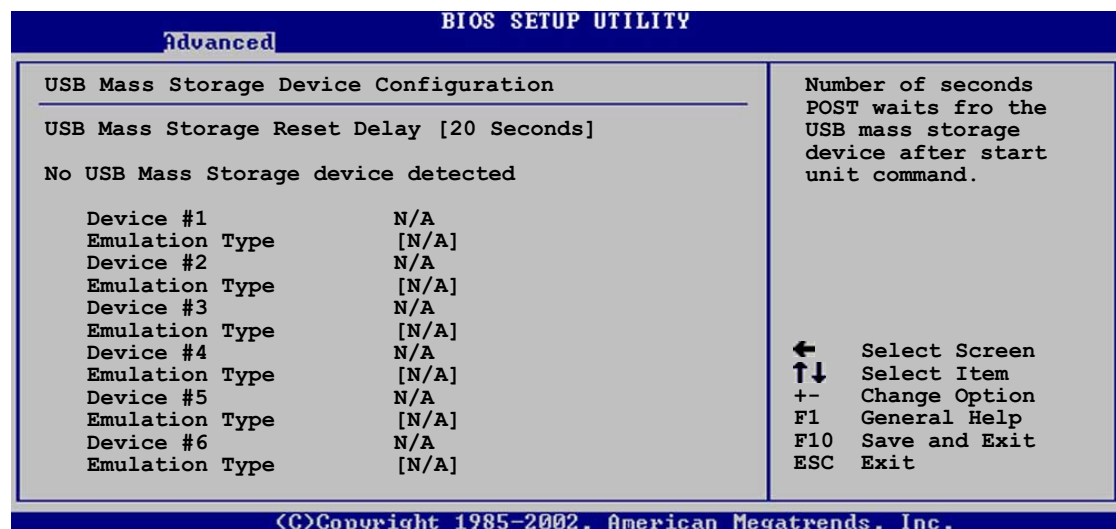

### USB Mass Storage Reset Delay [20 Sec]

Allows you to select the number of seconds POST waits for the USB mass storage device after the start unit command. The message "No USB mass storage device detected" appears if none is installed in the system. Configuration options: [10 Sec ] [20 Sec] [30 Sec] [40 Sec]

### Emulation Type [N/A]

When set to Auto, USB devices less than 530MB will be emulated as floppy drive, and the remaining drives as hard drives. Forced FDD option can be used to force an HDD formatted drive to boot as FDD (for example, ZIP drive).



The Device and Emulation Type items appear only when there are installed USB devices.

## 4.4.2 MPS Configuration

The items in this menu allows you to configure the Multi-Processor Table. Select an item then press <Enter> to display the configuration options.

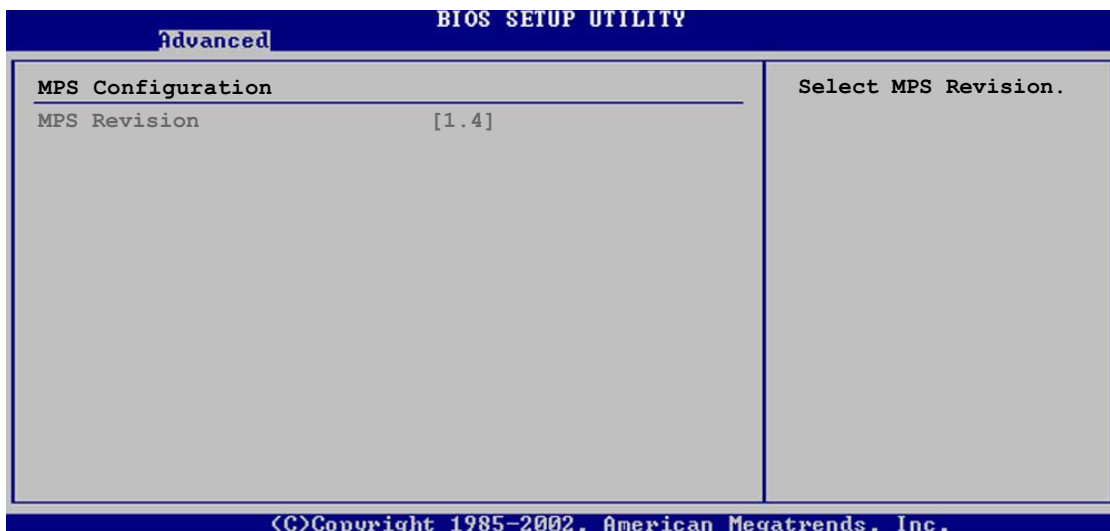

### **MPS Revision [1.4]**

Allows you to select the multi-processor system version.

Configuration options: [1.1] [1.4]

### 4.4.3 Remote Access Configuration

The items in this menu allows you to configure the Remote Access features. Select an item then press <Enter> to display the configuration options.

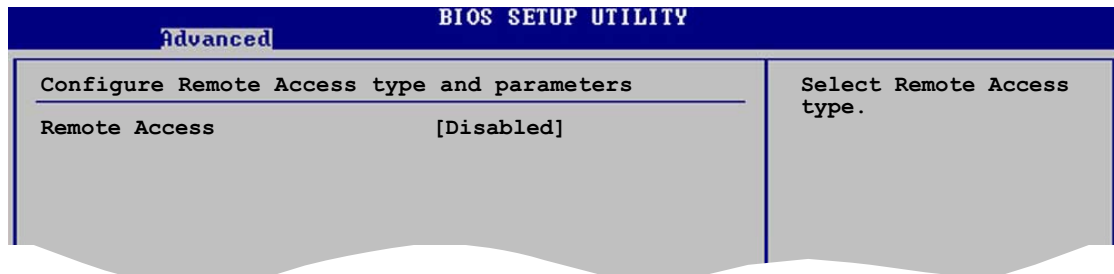

#### Remote Access [Disabled]

Enables or disables the remote access feature.  
Configuration options: [Disabled] [Enabled]

### 4.4.4 CPU Configuration

The items in this menu show the CPU-related information that the BIOS automatically detects.

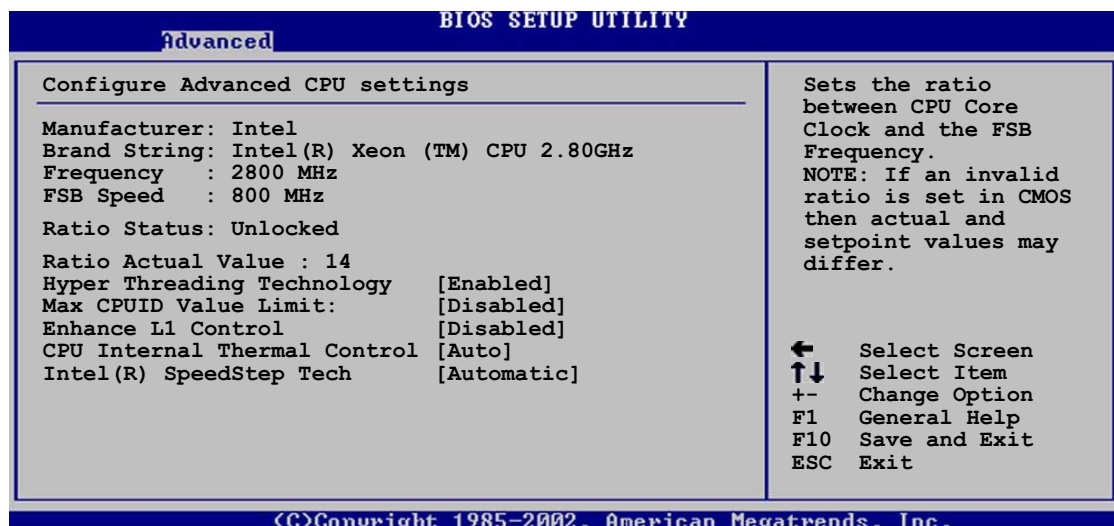

#### Hyper-Threading Technology [Enabled]

Allows you to enable or disable the processor Hyper-Threading Technology.  
Configuration options: [Disabled] [Enabled]

#### Max CPUID Value Limit [Disabled]

Setting this item to [Enabled] allows legacy operating systems to boot even without support for CPUs with extended CPUID functions.  
Configuration options: [Disabled] [Enabled]

## Enhance L1 Control [Auto]

Configuration options: [Auto] [Disabled]

## CPU Internal Thermal Control [Auto]

Configuration options: [Auto] [Disabled]

## Intel(R) SpeedStep Tech [Automatic]

Configuration options: [Automatic] [Maximum Speed] [Minimum Speed] [Disabled]

### 4.4.5 Chipset

The Chipset menu allows you to change the advanced chipset settings. Select an item then press <Enter> to display the sub-menu.

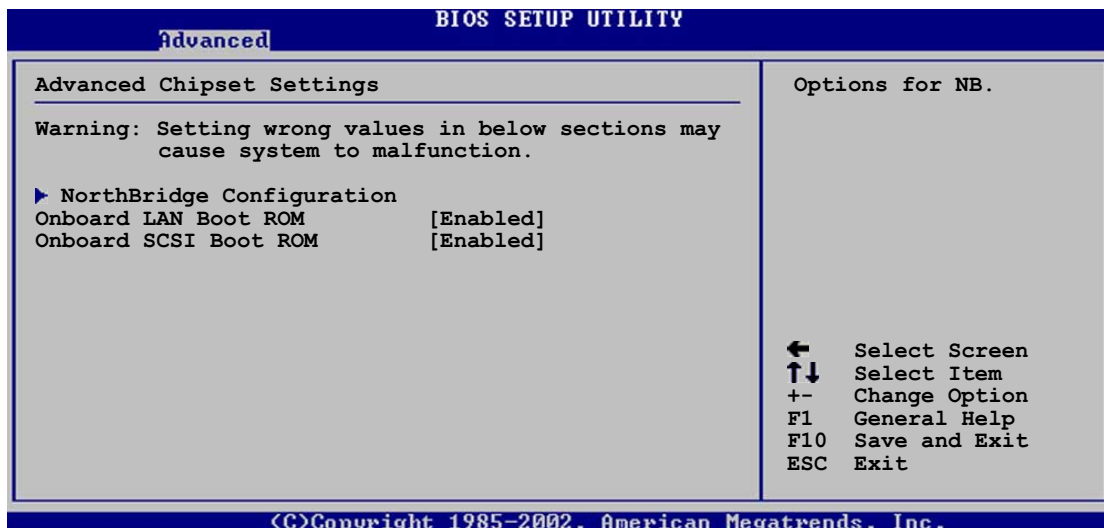

## Onboard LAN Boot ROM [Enabled]

Allows you to enable or disable the option ROM in the onboard LAN controller. Configuration options: [Disabled] [Enabled]

## Onboard SCSI Boot ROM [Enabled]

Allows you to enable or disable the option ROM in the onboard SCSI controller. Configuration options: [Disabled] [Enabled]



This item appears only in NCL-DS model.

## NorthBridge Configuration

The NorthBridge Configuration menu allows you to change the Northbridge settings.

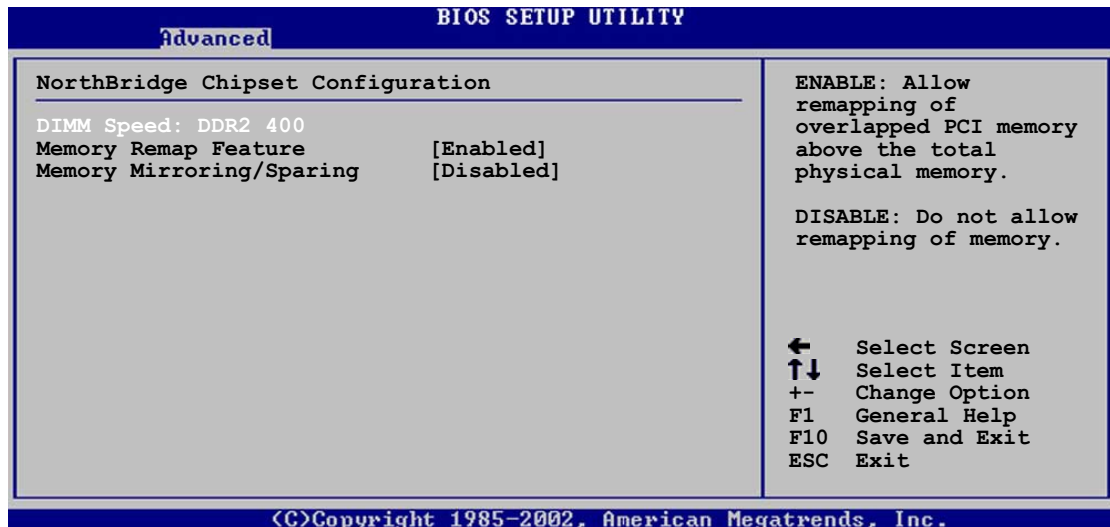

### DIMM Speed

Displays the installed DIMM type and speed. This item is auto-detected and is not configurable.

### Memory Remap Feature [Enabled]

Allows you to remap the overlap PCI memory over the total physical memory. Configuration options: [Disabled] [Enabled]

### Memory Mirroring/Sparing [Disabled]

Configuration options: [Disabled] [Mirroring] [Sparing]

## 4.4.6 Onboard Devices Configuration

| Advanced  |            | BIOS SETUP UTILITY                                 |
|---|------------|--|
| <b>Configure Win627EHF Super IO Chipset</b>       |            | Allows BIOS to Select Serial Port1 Base Addresses. |
| Serial Port1 Address                              | [3F8/IRQ4] |  |
| Serial Port2 Address                              | [2F8/IRQ3] |  |
| Serial Port2 Mode                                 | [Normal]   |  |
| Parallel Port Address                             | [Disabled] |  |
| (C)Copyright 1985-2002, American Megatrends, Inc. |            |  |

### Serial Port1 Address [3F8/IRQ4]

Allows you to select the Serial Port1 base address.

Configuration options: [Disabled] [3F8/IRQ4] [3E8/IRQ4] [2E8/IRQ3]

### Serial Port2 Address [2F8/IRQ3]

Allows you to select the Serial Port2 base address.

Configuration options: [Disabled] [2F8/IRQ3] [3E8/IRQ4] [2E8/IRQ3]

#### *Serial Port2 Mode [Normal]*

Allows you to set the BIOS selection mode for Serial Port2.

Configuration options: [Normal] [IrDA] [ASK IR]

### Parallel Port Address [Disabled]

Allows you to select the Parallel Port base addresses.

Configuration options: [Disabled] [378] [278] [3BC]

#### *Parallel Port Mode [IRQ7]*

Allows you to select the Parallel Port IRQ.

[Configuration options: [IRQ5] [IRQ7]



This item appears only in NCL-DS and NCL-D models.

## 4.4.7 PCI PnP

The PCI PnP menu items allow you to change the advanced settings for PCI/PnP devices. The menu includes setting the IRQ and DMA channel resources for either PCI/PnP or legacy ISA devices, and setting the memory size block for legacy ISA devices.



Take caution when changing the settings of the PCI PnP menu items. Incorrect field values can cause the system to malfunction!

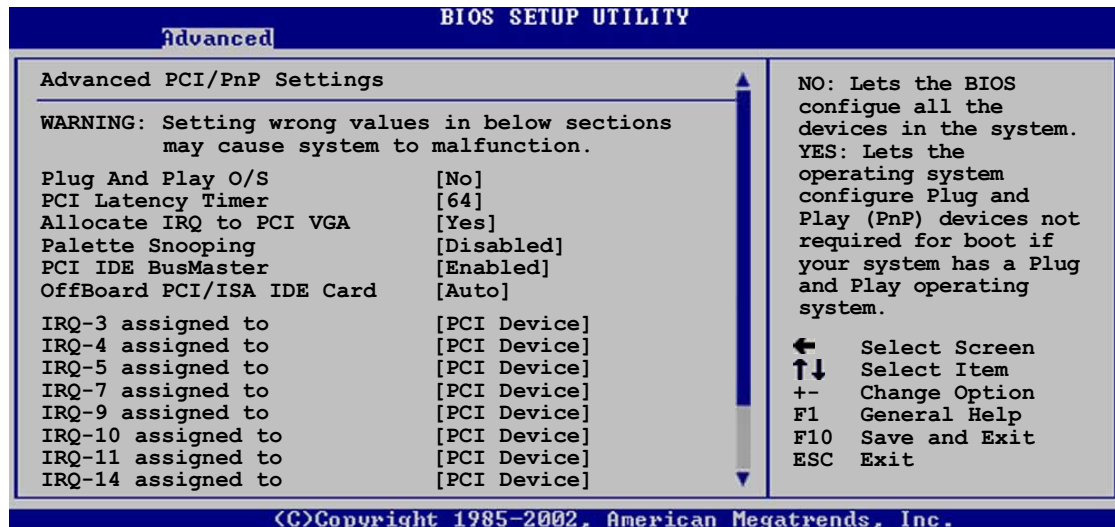

### Plug And Play O/S [No]

When set to [No], BIOS configures all the devices in the system. When set to [Yes] and if you install a Plug and Play operating system, the operating system configures the Plug and Play devices not required for boot.

Configuration options: [No] [Yes]

### PCI Latency Timer [64]

Allows you to select the value in units of PCI clocks for the PCI device latency timer register. Configuration options: [32] [64] [96] [128] [160] [192] [224] [248]

### Allocate IRQ to PCI VGA [Yes]

When set to [Yes], BIOS assigns an IRQ to PCI VGA card if the card requests for an IRQ. When set to [No], BIOS does not assign an IRQ to the PCI VGA card even if requested. Configuration options: [Yes] [No]

### Palette Snooping [Disabled]

When set to [Enabled], the palette snooping feature informs the PCI devices that an ISA graphics device is installed in the system so that the latter can function correctly. Configuration options: [Disabled] [Enabled]

## PCI IDE BusMaster [Enabled]

Allows BIOS to use PCI bus mastering when reading/writing to IDE devices.  
Configuration options: [Disabled] [Enabled]

## Offboard PCI/ISA IDE Card [Auto]

Allows you to assign a PCI slot to a PCI IDE card, when required.  
Configuration options: [Auto] [PCI Slot1] [PCI Slot2] [PCI Slot3] [PCI Slot4]  
[PCI Slot5] [PCI Slot6]

## IRQ-xx assigned to [PCI Device]

When set to [PCI Device], the specific IRQ is free for use of PCI/PnP devices. When set to [Reserved], the IRQ is reserved for legacy ISA devices. Configuration options: [PCI Device] [Reserved]

Use the arrow down key to scroll down the menu.



## DMA Channel X assigned to [PCI Device]

When set to [PCI Device], the specific DMA channel is free for use of PCI/PnP devices. When set to [Reserved], the DMA channel is reserved for legacy ISA devices. Configuration options: [PCI Device] [Reserved]

## Reserved Memory Size [Disabled]

Allows you to set the reserved memory size.  
Configuration options: [Disabled] [16k] [32k] [64k]



## 4.5 Power menu

The Power menu items allow you to change the settings for the ACPI and Advanced Power Management (APM) features. Select an item then press <Enter> to display the configuration options.

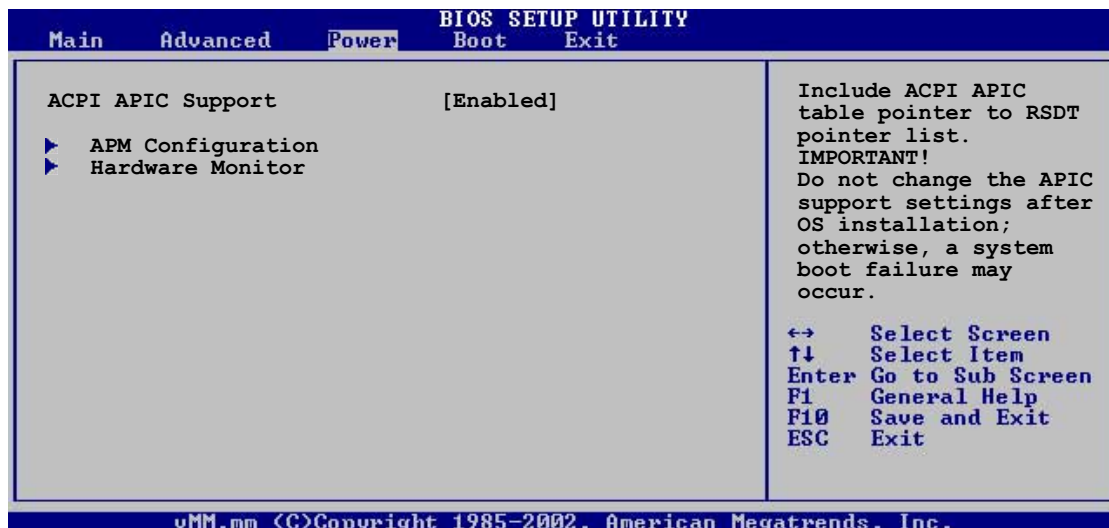

### 4.5.1 ACPI APIC Support [Enabled]

Allows you to enable or disable the Advanced Configuration and Power Interface (ACPI) support in the Application-Specific Integrated Circuit (ASIC). When set to Enabled, the ACPI APIC table pointer is included in the RSDT pointer list. Configuration options: [Disabled] [Enabled]

### 4.5.2 APM Configuration

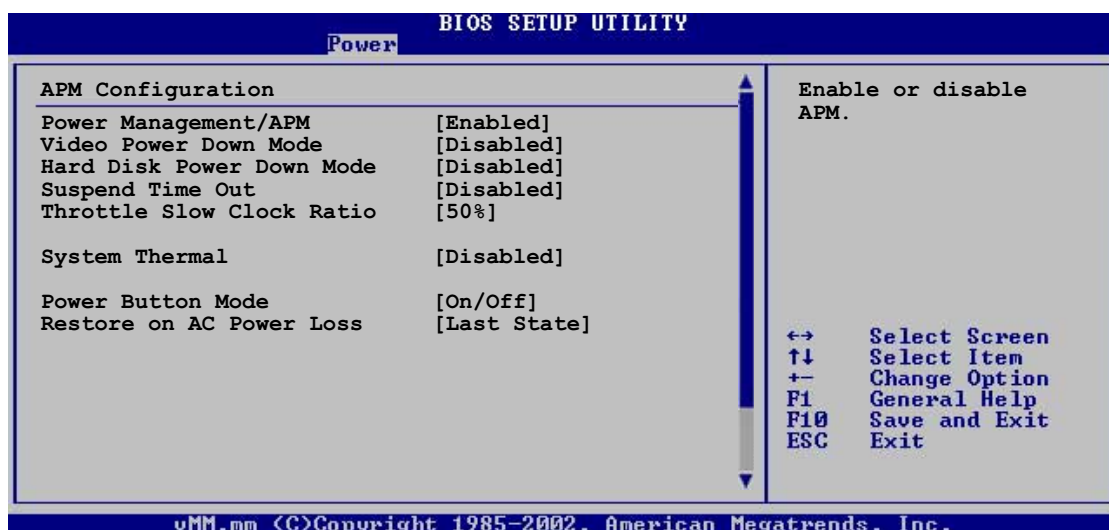

Use the arrow down key to scroll down the menu.

|                           |            |     |               |
|---------------------------|------------|-----|---------------|
| Power On Ring             | [Disabled] | ←→  | Select Screen |
| Power On LAN              | [Disabled] | ↑↓  | Select Item   |
| Power On By PME#          | [Disabled] | + - | Change Option |
| Power On By RTC Alarm     | [Disabled] | F1  | General Help  |
| Power On By PS/2 Keyboard | [Disabled] | F10 | Save and Exit |
| Power On By PS/2 Mouse    | [Disabled] | ESC | Exit          |

oMM.mm <C>Copyright 1985-2002, American Megatrends, Inc.

### **Power Management [Enabled]**

Allows you to enable or disable the motherboard Advance Power Management (APM) feature. Configuration options: [Enabled] [Disabled]

### **Video Power Down Mode [Suspend]**

Allows you to select the video power down mode  
Configuration options: [Disabled] [Standby] [Suspend]

### **Hard Disk Power Down Mode [Suspend]**

Allows you to select the hard disk power down mode  
Configuration options: [Disabled] [Standby] [Suspend]

### **Suspend Time Out [Disabled]**

Allows you to select the specified time at which the system goes on suspend mode. Configuration options: [Disabled] [1 Min] [2 Min] [4 Min] [8 Min] [10 Min] [20 Min] [30 Min] [40 Min] [50 Min] [60 Min]

### **Throttle Slow Clock Ratio [50%]**

Allows you to select duty cycle in throttle mode.  
Configuration options: [87.5%] [75.0%] [62.5%] [50.0%] [37.5%] [25.0%] [12.5%]

### **System Thermal [Disabled]**

Allows you to enable or disable the use of system thermal condition generate a power management event. Configuration options: [Disabled] [Enabled]

### **Power Button Mode [On/Off]**

Allows the system to go into On/Off mode or suspend mode when the power button is pressed. Configuration options: [On/Off] [Suspend]

### **Restore on AC Power Loss [Power Off]**

When set to Power Off, the system goes into off state after an AC power loss. When set to Power On, the system goes on after an AC power loss. When set to Last State, the system goes into either off or on state, whatever the system state was before the AC power loss.  
Configuration options: [Power Off] [Power On] [Last State]

### **Power On Ring [Disabled]**

When set to [Enabled], the system enables the RI to generate a wake event while the computer is in Soft-off mode.

Configuration options: [Disabled] [Enabled]

### **Power On LAN [Disabled]**

When set to [Enabled], this parameter allows you to turn on the system through a PCI LAN or modem card. This feature requires an ATX power supply that provides at least 1A on the +5VSB lead.

Configuration options: [Disabled] [Enabled]

### **Power On By PME# [Disabled]**

When set to [Enabled], the system enables the PME to generate a wake event while the computer is in Soft-off mode.

Configuration options: [Disabled] [Enabled]

### **Power On By RTC Alarm [Disabled]**

Allows you to enable or disable RTC to generate a wake event. When this item is set to [Enabled], the items RTC Alarm Date, RTC Alarm Hour, RTC Alarm Minute, and RTC Alarm Second appear with set values.

Configuration options: [Disabled] [Enabled]

### **Power On By PS/2 Keyboard [Disabled]**

Allows you to use specific keys on the keyboard to turn on the system.

This feature requires an ATX power supply that provides at least 1A on the +5VSB lead. Configuration options: [Disabled] [Enabled]

### **Power On By PS/2 Mouse [Disabled]**

When set to [Enabled], this parameter allows you to use the PS/2 mouse to turn on the system. This feature requires an ATX power supply that provides at least 1A on the +5VSB lead.

Configuration options: [Disabled] [Enabled]

## 4.5.3 Hardware Monitor

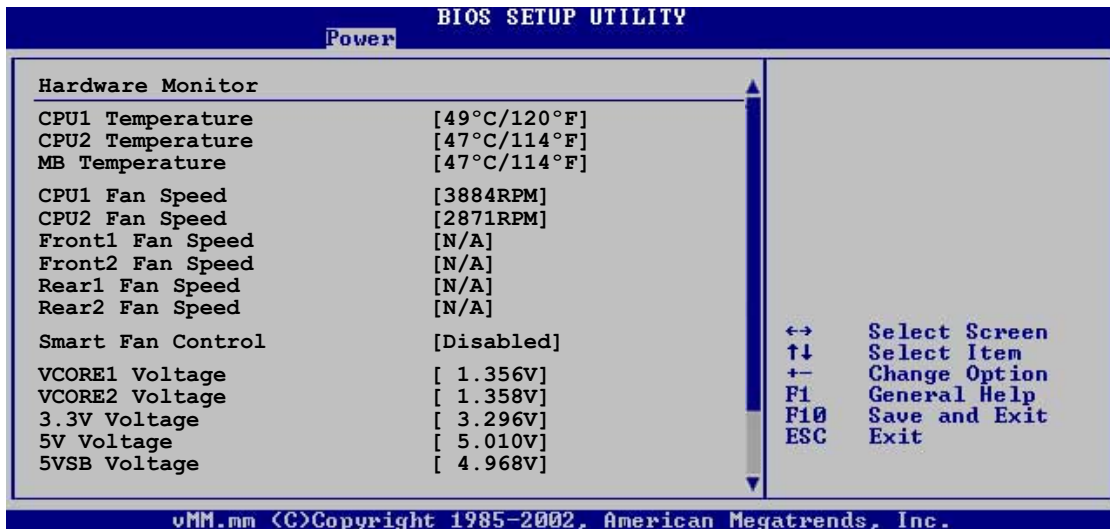

Use the arrow down key to display additional items.

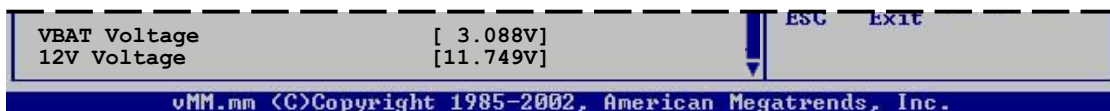

### CPU1/CPU2 Temperature [xxx°C/xxx°F]

### MB Temperature [xxx°C/xxx°F]

The onboard hardware monitor automatically detects and displays the motherboard and CPU temperatures. Select [Disabled] if you do not wish to display the detected temperatures.

### CPU1/CPU2 Fan Speed [xxxxRPM] or [N/A]

### Front1/Front2 Fan Speed [xxxxRPM] or [N/A]

### Rear1/Rear2 Fan Speed [xxxxRPM] or [N/A]

The onboard hardware monitor automatically detects and displays the CPU, front, and rear fan speeds in rotations per minute (RPM). If a fan is not connected to the connector on the motherboard, the field shows N/A.

## Smart Fan Control [Disabled]

Allows you to enable or disable the ASUS Q-Fan feature that smartly adjusts the fan speeds for more efficient system operation. Configuration options: [Disabled] [Enabled]



The **CPU1 Temperature**, **CPU2 Temperature**, and **Front1 Temperature** items appear when you enable the **Smart Fan Control** feature.

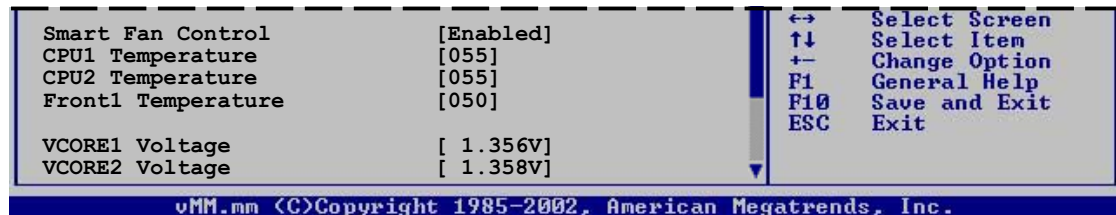

## CPU1/CPU2 Temperature [XXX]

### Front1 Temperature [XXX]

Displays the detected CPU and system threshold temperatures when the Smart Fan Control feature is enabled.

## VCORE1 Voltage, VCORE2 Voltage, 3.3V Voltage, 5V Voltage, 5VSB Voltage, VBAT Voltage, 12V Voltage

The onboard hardware monitor automatically detects the voltage outputs through the onboard voltage regulators.

## 4.6 Boot menu

The Boot menu items allow you to change the system boot options. Select an item then press <Enter> to display the sub-menu.

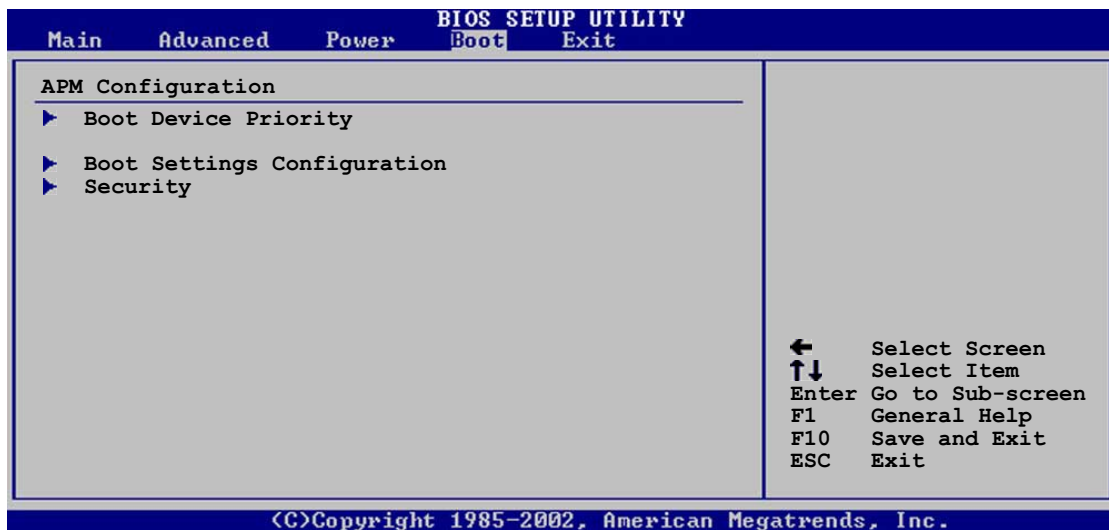

### 4.6.1 Boot Device Priority

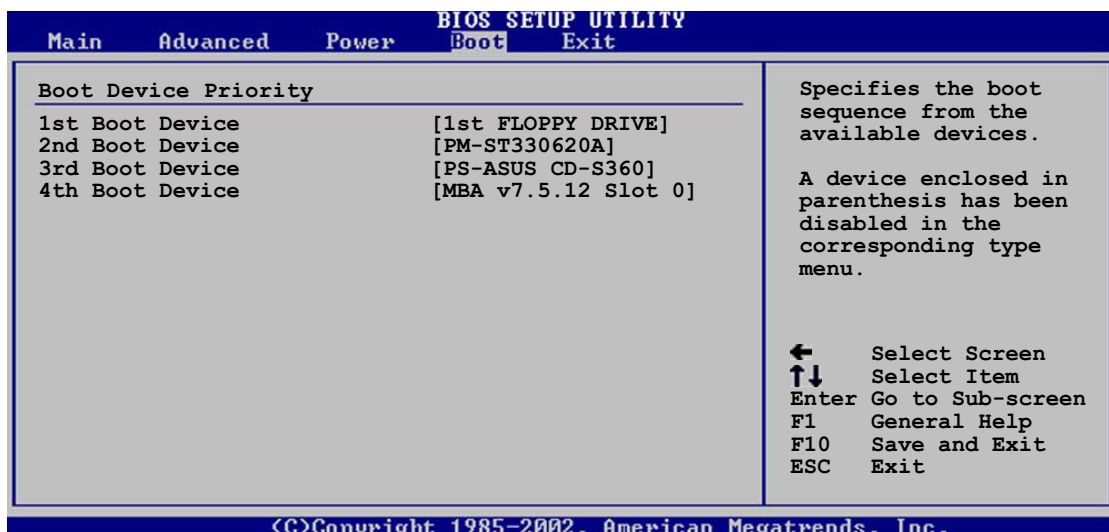

#### 1st ~ xxth Boot Device [1st Floppy Drive]

These items specify the boot device priority sequence from the available devices. The number of device items that appears on the screen depends on the number of devices installed in the system.

Configuration options: [xxxxx Drive] [Disabled]

## 4.6.2 Boot Settings Configuration

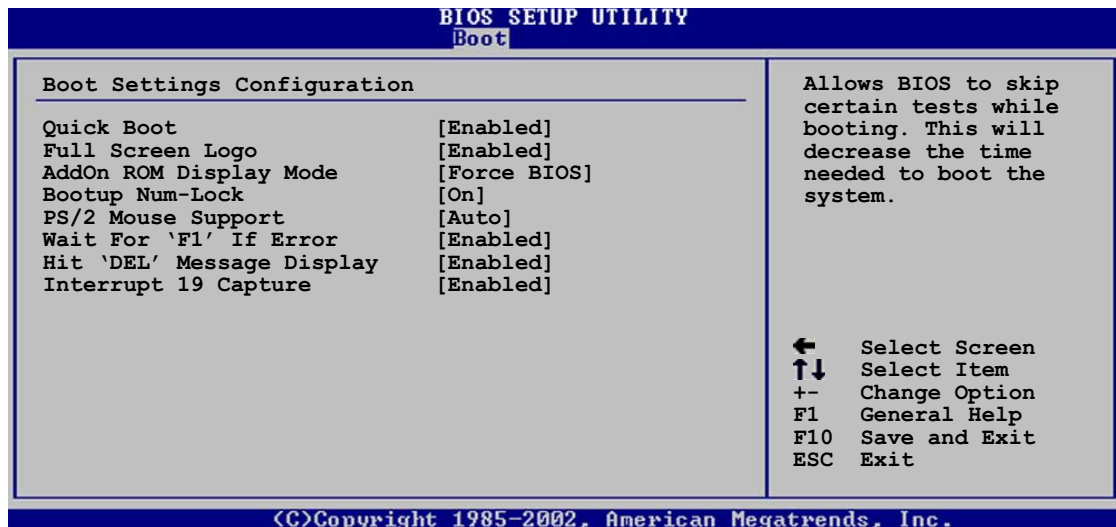

### Quick Boot [Enabled]

Enabling this item allows the BIOS to skip some power on self tests (POST) while booting to decrease the time needed to boot the system. When set to [Disabled], BIOS performs all the POST items.

Configuration options: [Disabled] [Enabled]

### Full Screen Logo [Enabled]

Allows you to enable or disable the full screen logo display feature.

Configuration options: [Disabled] [Enabled]



Set this item to [Enabled] to use the ASUS MyLogo2™ feature.

### Add On ROM Display Mode [Force BIOS]

Sets the display mode for option ROM.

Configuration options: [Force BIOS] [Keep Current]

### Bootup Num-Lock [On]

Allows you to select the power-on state for the NumLock.

Configuration options: [Off] [On]

### PS/2 Mouse Support [Auto]

Allows you to enable or disable support for PS/2 mouse.

Configuration options: [Disabled] [Enabled] [Auto]

### **Wait for 'F1' If Error [Enabled]**

When set to Enabled, the system waits for the F1 key to be pressed when error occurs. Configuration options: [Disabled] [Enabled]

### **Hit 'DEL' Message Display [Enabled]**

When set to Enabled, the system displays the message "Press DEL to run Setup" during POST. Configuration options: [Disabled] [Enabled]

### **Interrupt 19 Capture [Disabled]**

When set to [Enabled], this function allows the option ROMs to trap Interrupt 19. Configuration options: [Disabled] [Enabled]



### 4.6.3 Security

The Security menu items allow you to change the system security settings. Select an item then press <Enter> to display the configuration options.



#### Change Supervisor Password

Select this item to set or change the supervisor password. The Supervisor Password item on top of the screen shows the default **Not Installed**. After you set a password, this item shows **Installed**.

To set or change a supervisor password:

1. Select the **Change Supervisor Password** item, then press <Enter>.
2. From the password box, type a password composed of at least six letters and/or numbers, then press <Enter>.
3. Confirm the password when prompted.

The message “Password Installed” appears after you successfully set your password.

To change the supervisor password, follow the same steps as in setting a user password.

#### To clear the supervisor password:

Select the **Change Supervisor Password** then press <Enter>. The message “Password Uninstalled” appears.



---

If you forget your BIOS password, you can clear it by erasing the CMOS Real Time Clock (RTC) RAM. See section “2.6 Jumpers” for information on how to erase the RTC RAM.

---

After you have set a supervisor password, the other items appear to allow you to change other security settings.

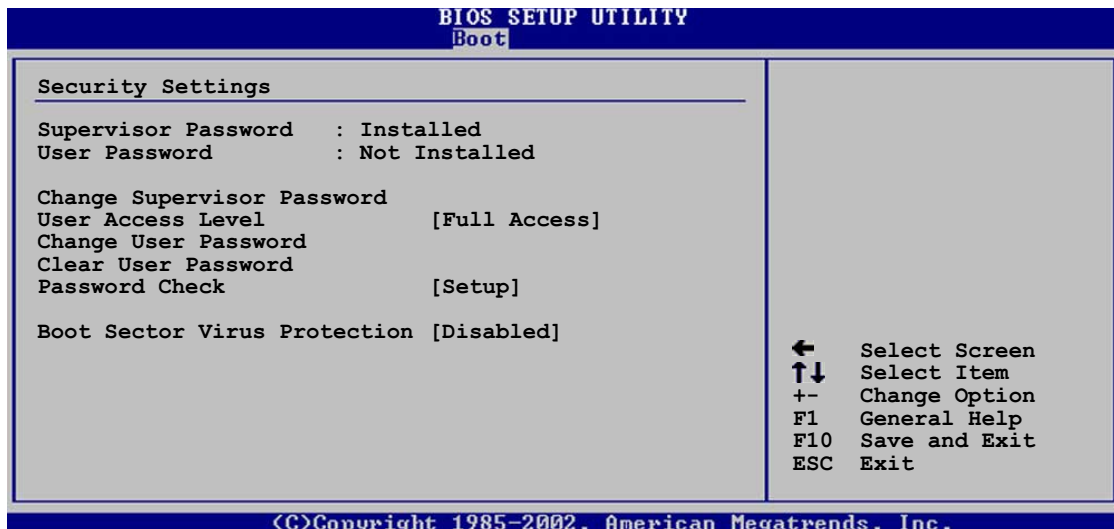

## User Access Level [Full Access]

This item allows you to select the access restriction to the Setup items. Configuration options: [No Access] [View Only] [Limited] [Full Access]

**No Access** prevents user access to the Setup utility.

**View Only** allows access but does not allow change to any field.

**Limited** allows changes only to selected fields, such as Date and Time.

**Full Access** allows viewing and changing all the fields in the Setup utility.

## Change User Password

Select this item to set or change the user password. The **User Password** item on top of the screen shows the default **Not Installed**. After you set a password, this item shows **Installed**.

To set a user password:

1. Select the Change User Password item and press <Enter>.
2. On the password box that appears, type a password composed of at least six letters and/or numbers, then press <Enter>.
3. Confirm the password when prompted.

The message "Password Installed" appears after you set your password successfully.

To change the user password, follow the same steps as in setting a user password.

## **Clear User Password**

Select this item to clear the user password.

## **Password Check [Setup]**

When set to [Setup], BIOS checks for user password when accessing the Setup utility. When set to [Always], BIOS checks for user password both when accessing Setup and booting the system.

Configuration options: [Setup] [Always]

## **Boot Sector Virus Protection [Disabled]**

Allows you to enable or disable the boot sector virus protection.

Configuration options: [Disabled] [Enabled]

## 4.7 Exit menu

The Exit menu items allow you to load the optimal or failsafe default values for the BIOS items, and save or discard your changes to the BIOS items.

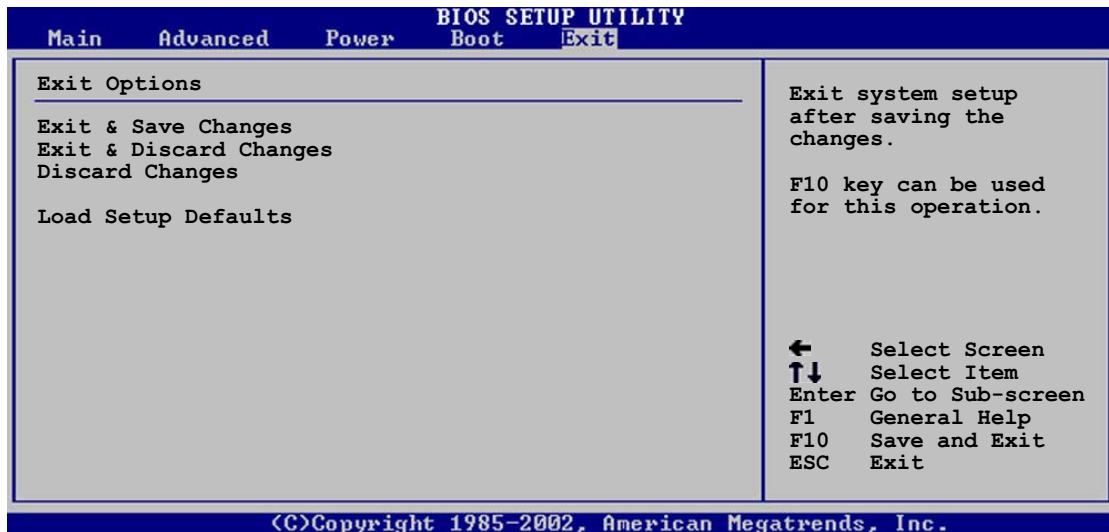

If you made changes to any of the settings in the menus, pressing <Esc> does not immediately exit this menu. A confirmation window appears and prompts you to either save your changes or cancel the command. Select one of the options from this menu to exit.

### Exit & Save Changes

Select this option then press <Enter>, or simply press <F10>, to save your changes to CMOS before exiting the Setup utility.

When a confirmation window appears, select [OK] then press <Enter> to save your changes and exit Setup. If you wish to cancel the command, select [Cancel] then press <Enter> to return to the Exit menu.

### Exit & Discard Changes

Select this option then press <Enter> to exit the Setup utility without saving your changes.

When a confirmation window appears, select [OK] then press <Enter> to discard your changes and exit Setup. If you wish to cancel the command, select [Cancel] then press <Enter> to return to the Exit menu.

### Discard Changes

Select this option then press <Enter> to discard the changes that you made, and restore the previously saved settings.

When a confirmation window appears, select [OK] then press <Enter> to discard the changes, and load the previously saved settings. If you wish to cancel the command, select [Cancel] then press <Enter> to return to the Exit menu.

## **Load Setup Defaults**

Select this option then press <Enter> to load the optimized settings for each of the Setup menu items.

When a confirmation window appears, select [OK] then press <Enter> to load the default settings. If you wish to cancel the command, select [Cancel] then press <Enter> to return to the Exit menu.



This appendix includes additional information that you may refer to when configuring the motherboard.

# Reference information

## Appendix summary



|     |                             |     |
|-----|-----------------------------|-----|
| A.1 | NCL-DS block diagram .....  | A-1 |
| A.2 | NCL-D block diagram .....   | A-2 |
| A.3 | NCL-DR1 block diagram ..... | A-3 |



# A.1 NCL-DS block diagram

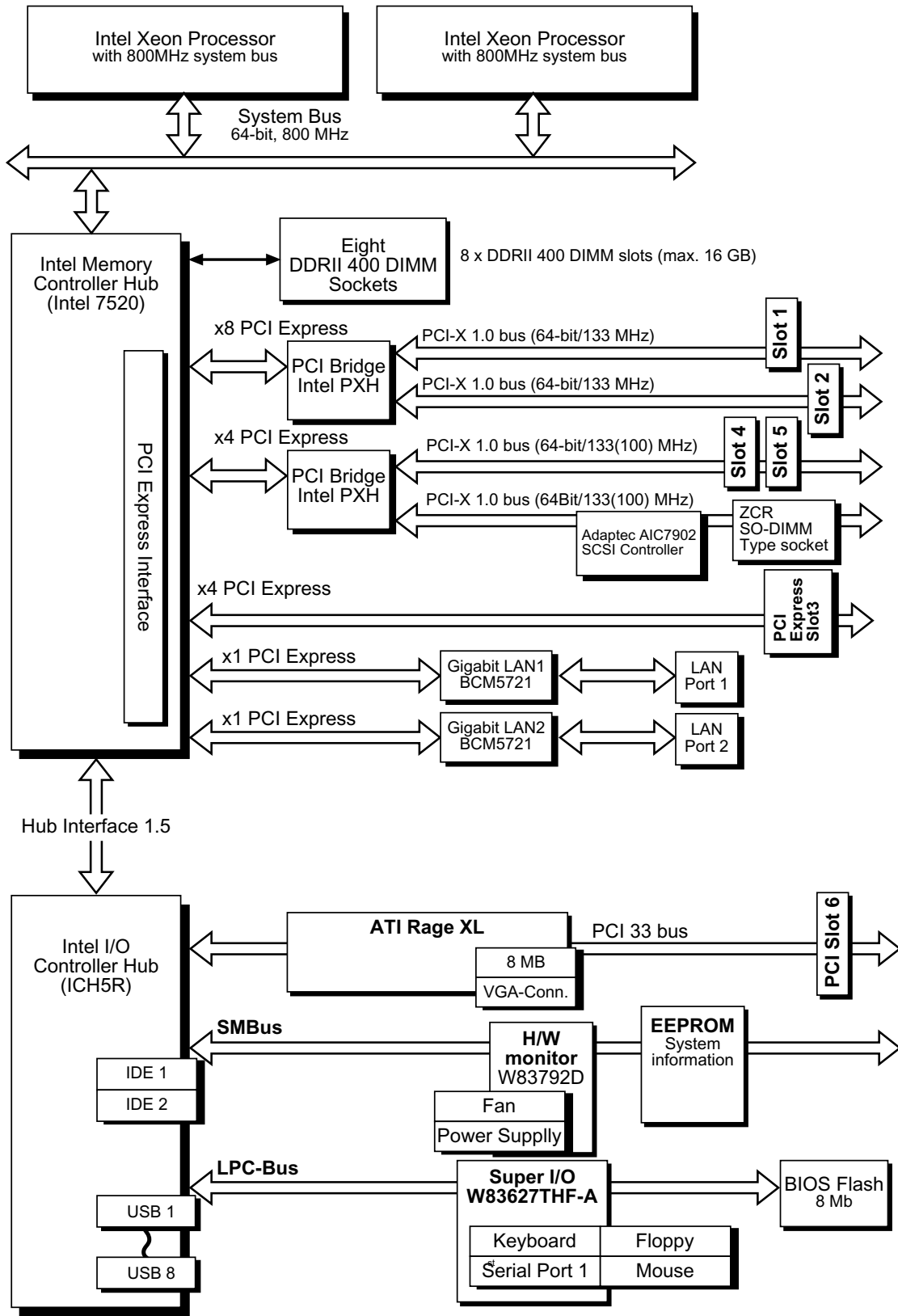

## A.2 NCL-D block diagram

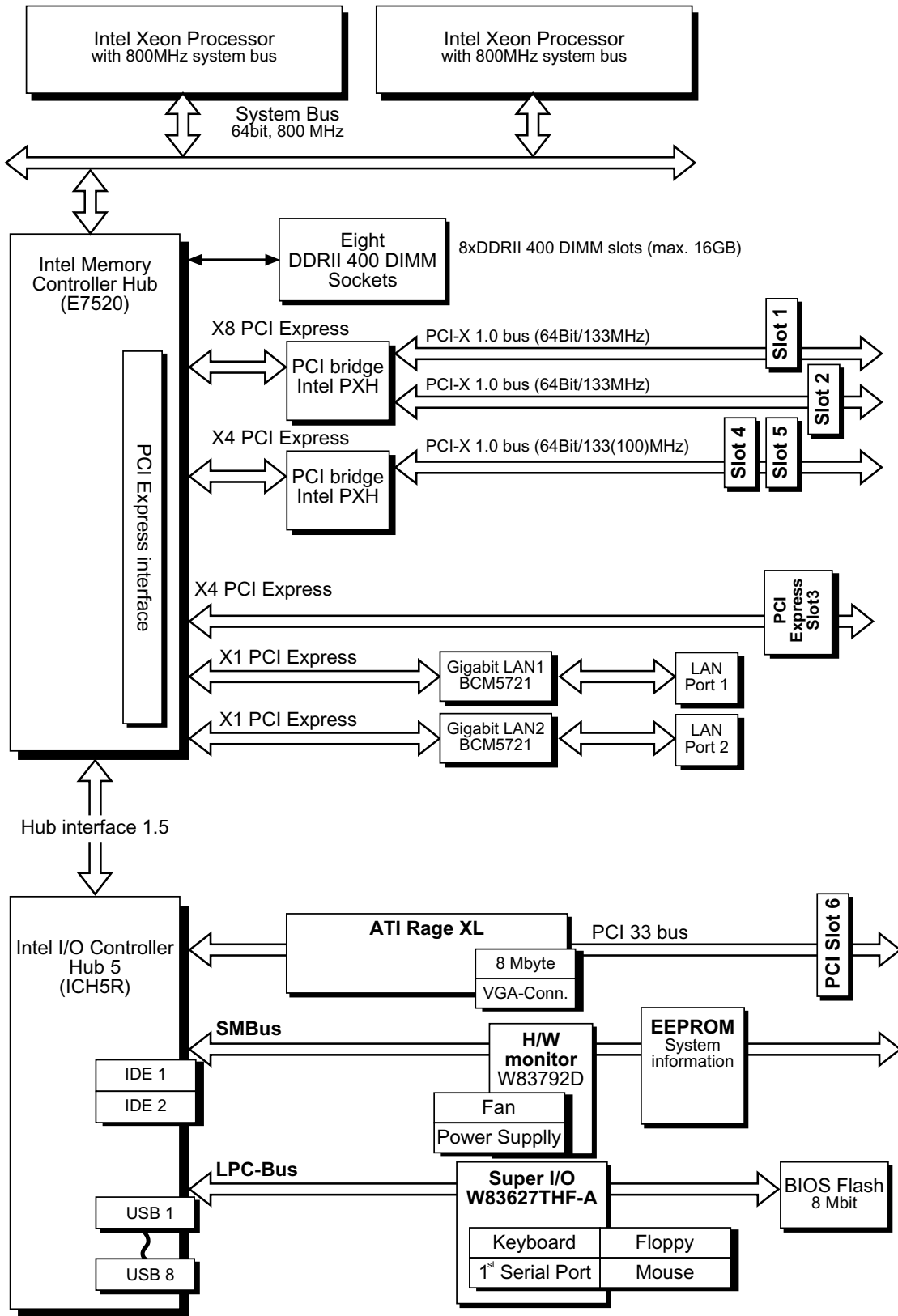

## A.3 NCL-DR1 block diagram

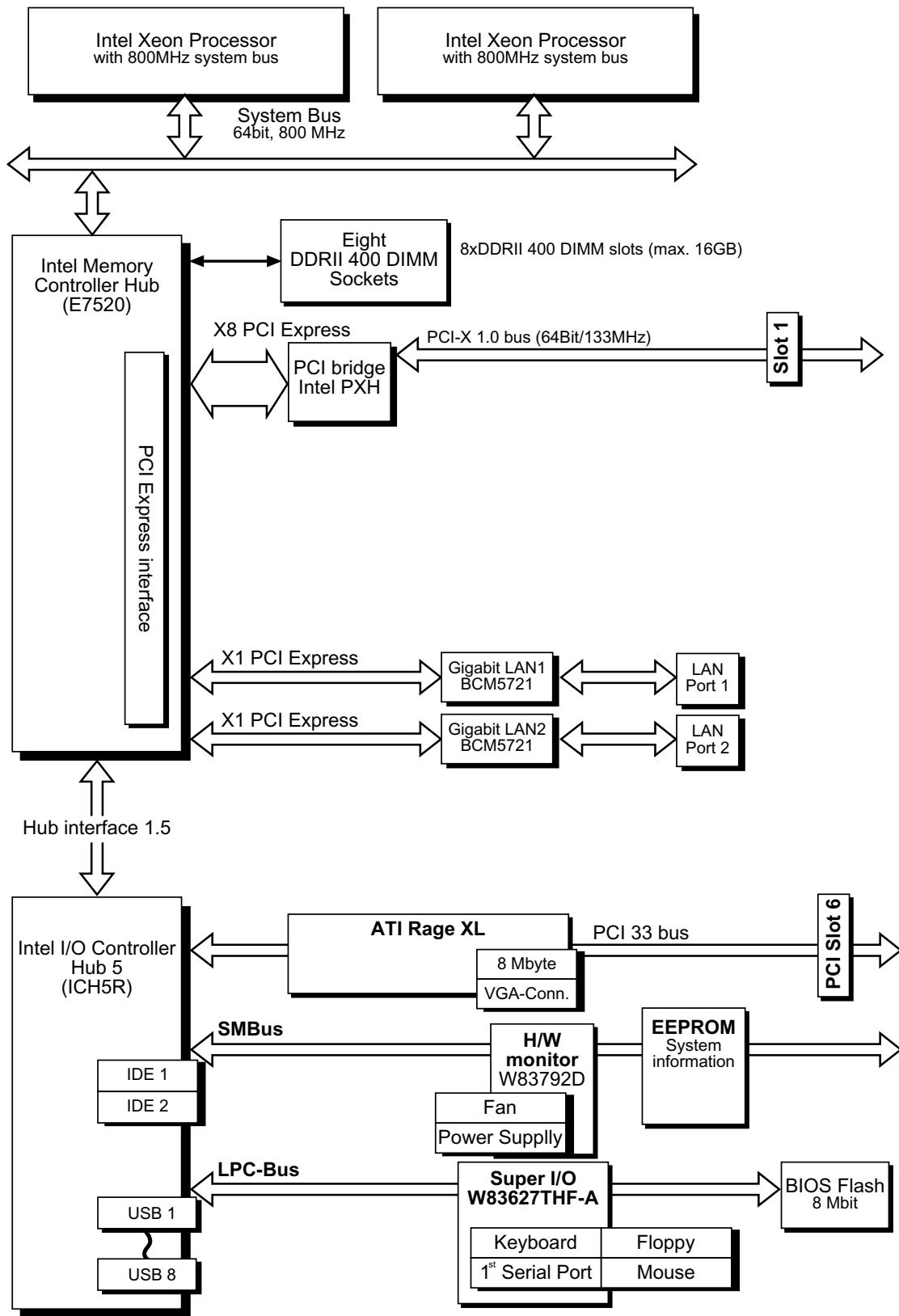



## Free Manuals Download Website

<http://myh66.com>

<http://usermanuals.us>

<http://www.somanuals.com>

<http://www.4manuals.cc>

<http://www.manual-lib.com>

<http://www.404manual.com>

<http://www.luxmanual.com>

<http://aubethermostatmanual.com>

Golf course search by state

<http://golfingnear.com>

Email search by domain

<http://emailbydomain.com>

Auto manuals search

<http://auto.somanuals.com>

TV manuals search

<http://tv.somanuals.com>