



# *P4GE-VM*

User Guide

# Motherboard

**E1166**

**First Edition**

**November 2002**

**Copyright © 2002 ASUSTeK COMPUTER INC. All Rights Reserved.**

No part of this manual, including the products and software described in it, may be reproduced, transmitted, transcribed, stored in a retrieval system, or translated into any language in any form or by any means, except documentation kept by the purchaser for backup purposes, without the express written permission of ASUSTeK COMPUTER INC. ("ASUS").

Product warranty or service will not be extended if: (1) the product is repaired, modified or altered, unless such repair, modification or alteration is authorized in writing by ASUS; or (2) the serial number of the product is defaced or missing.

ASUS PROVIDES THIS MANUAL "AS IS" WITHOUT WARRANTY OF ANY KIND, EITHER EXPRESS OR IMPLIED, INCLUDING BUT NOT LIMITED TO THE IMPLIED WARRANTIES OR CONDITIONS OF MERCHANTABILITY OR FITNESS FOR A PARTICULAR PURPOSE. IN NO EVENT SHALL ASUS, ITS DIRECTORS, OFFICERS, EMPLOYEES OR AGENTS BE LIABLE FOR ANY INDIRECT, SPECIAL, INCIDENTAL, OR CONSEQUENTIAL DAMAGES (INCLUDING DAMAGES FOR LOSS OF PROFITS, LOSS OF BUSINESS, LOSS OF USE OR DATA, INTERRUPTION OF BUSINESS AND THE LIKE), EVEN IF ASUS HAS BEEN ADVISED OF THE POSSIBILITY OF SUCH DAMAGES ARISING FROM ANY DEFECT OR ERROR IN THIS MANUAL OR PRODUCT.

SPECIFICATIONS AND INFORMATION CONTAINED IN THIS MANUAL ARE FURNISHED FOR INFORMATIONAL USE ONLY, AND ARE SUBJECT TO CHANGE AT ANY TIME WITHOUT NOTICE, AND SHOULD NOT BE CONSTRUED AS A COMMITMENT BY ASUS. ASUS ASSUMES NO RESPONSIBILITY OR LIABILITY FOR ANY ERRORS OR INACCURACIES THAT MAY APPEAR IN THIS MANUAL, INCLUDING THE PRODUCTS AND SOFTWARE DESCRIBED IN IT.

Products and corporate names appearing in this manual may or may not be registered trademarks or copyrights of their respective companies, and are used only for identification or explanation and to the owners' benefit, without intent to infringe.

# Contents

Notices .....	v
Safety information .....	vi
About this guide .....	vii
ASUS contact information .....	viii
P4GE-VM specifications summary .....	ix

## Chapter 1: Product introduction

1.1 Welcome! .....	1-2
1.2 Package contents .....	1-2
1.3 Motherboard components .....	1-3
1.4 Motherboard layout .....	1-6
1.5 Before you proceed .....	1-7
1.6.1 Placement direction .....	1-8
1.6.2 Screw holes .....	1-8
1.6 Motherboard installation .....	1-8
1.7 Central Processing Unit (CPU) .....	1-9
1.7.1 Overview .....	1-9
1.7.2 Installing the CPU .....	1-10
1.8 System memory .....	1-11
1.9 Expansion slots .....	1-12
1.9.1 Standard interrupt assignments .....	1-12
1.9.1 IRQ assignments for this motherboard .....	1-12
1.10 Switches and jumpers .....	1-13
1.11 Connectors .....	1-16

## Chapter 2: BIOS information

2.1 Managing and updating your BIOS .....	2-2
2.1.1 Using ASUS EZ Flash to update the BIOS .....	2-2
2.1.2 Using AFLASH to update the BIOS .....	2-4
2.1.3 CrashFree BIOS feature .....	2-7
2.2 BIOS Setup program .....	2-8
2.2.1 BIOS menu bar .....	2-8
2.2.2 Legend bar .....	2-9

# Contents

2.3	Main Menu .....	2-10
2.3.1	Primary and Secondary Master/Slave .....	2-12
2.3.2	Keyboard Features .....	2-14
2.4	Advanced Menu .....	2-15
2.4.1	Chip Configuration .....	2-17
2.4.2	I/O Device Configuration .....	2-19
2.4.3	PCI Configuration .....	2-20
2.5	Power Menu .....	2-22
2.5.1	Power Up Control .....	2-24
2.5.2	Hardware Monitor .....	2-25
2.6	Boot Menu .....	2-26
2.7	Exit Menu .....	2-28

## Chapter 3: Software support

3.1	Install an operating system .....	3-2
3.2	Support CD information .....	3-2
3.2.1	Running the support CD .....	3-2
3.2.2	Drivers menu .....	3-3
3.2.3	Utilities menu .....	3-3
3.2.4	ASUS Contact Information .....	3-4

# Notices

## Federal Communications Commission Statement

This device complies with FCC Rules Part 15. Operation is subject to the following two conditions:

- This device may not cause harmful interference, and
- This device must accept any interference received including interference that may cause undesired operation.

This equipment has been tested and found to comply with the limits for a Class B digital device, pursuant to Part 15 of the FCC Rules. These limits are designed to provide reasonable protection against harmful interference in a residential installation. This equipment generates, uses and can radiate radio frequency energy and, if not installed and used in accordance with manufacturer's instructions, may cause harmful interference to radio communications. However, there is no guarantee that interference will not occur in a particular installation. If this equipment does cause harmful interference to radio or television reception, which can be determined by turning the equipment off and on, the user is encouraged to try to correct the interference by one or more of the following measures:

- Reorient or relocate the receiving antenna.
- Increase the separation between the equipment and receiver.
- Connect the equipment to an outlet on a circuit different from that to which the receiver is connected.
- Consult the dealer or an experienced radio/TV technician for help.



---

The use of shielded cables for connection of the monitor to the graphics card is required to assure compliance with FCC regulations. Changes or modifications to this unit not expressly approved by the party responsible for compliance could void the user's authority to operate this equipment.

---

## Canadian Department of Communications Statement

This digital apparatus does not exceed the Class B limits for radio noise emissions from digital apparatus set out in the Radio Interference Regulations of the Canadian Department of Communications.

**This class B digital apparatus complies with Canadian ICES-003.**

# Safety information

## Electrical safety

- To prevent electrical shock hazard, disconnect the power cable from the electrical outlet before relocating the system.
- When adding or removing devices to or from the system, ensure that the power cables for the devices are unplugged before the signal cables are connected. If possible, disconnect all power cables from the existing system before you add a device.
- Before connecting or removing signal cables from the motherboard, ensure that all power cables are unplugged.
- Seek professional assistance before using an adapter or extension cord. These devices could interrupt the grounding circuit.
- Make sure that your power supply is set to the correct voltage in your area. If you are not sure about the voltage of the electrical outlet you are using, contact your local power company.
- If the power supply is broken, do not try to fix it by yourself. Contact a qualified service technician or your retailer.

## Operation safety

- Before installing the motherboard and adding devices on it, carefully read all the manuals that came with the package.
- Before using the product, make sure all cables are correctly connected and the power cables are not damaged. If you detect any damage, contact your dealer immediately.
- To avoid short circuits, keep paper clips, screws, and staples away from connectors, slots, sockets and circuitry.
- Avoid dust, humidity, and temperature extremes. Do not place the product in any area where it may become wet.
- Place the product on a stable surface.
- If you encounter technical problems with the product, contact a qualified service technician or your retailer.

# About this guide

## Conventions used in this guide

To make sure that you perform certain tasks properly, take note of the following symbols used throughout this manual.



**WARNING:** Information to prevent injury to yourself when trying to complete a task.



**CAUTION:** Information to prevent damage to the components when trying to complete a task.



**IMPORTANT:** Information that you **MUST** follow to complete a task.



**NOTE:** Tips and additional information to aid in completing a task.

## Where to find more information

Refer to the following sources for additional information and for product and software updates.

### 1. ASUS Websites

The ASUS websites worldwide provide updated information on ASUS hardware and software products. The ASUS websites are listed in the ASUS Contact Information on page viii.

### 2. Optional Documentation

Your product package may include optional documentation, such as warranty flyers, that may have been added by your dealer. These documents are not part of the standard package.

# ASUS contact information

## ASUSTeK COMPUTER INC. (Asia-Pacific)

Address: 150 Li-Te Road, Peitou, Taipei, Taiwan 112  
General Tel: +886-2-2894-3447  
General Fax: +886-2-2894-3449  
General Email: info@asus.com.tw

### *Technical Support*

MB/Others (Tel): +886-2-2890-7121 (English)  
Notebook (Tel): +886-2-2890-7122 (English)  
Desktop/Server (Tel): +886-2-2890-7123 (English)  
Support Fax: +886-2-2890-7698  
Support Email: tsd@asus.com.tw  
Web Site: www.asus.com.tw  
Newsgroup: cscnews.asus.com.tw

## ASUS COMPUTER INTERNATIONAL (America)

Address: 6737 Mowry Avenue, Mowry Business Center,  
Building 2, Newark, CA 94560, USA  
General Fax: +1-510-608-4555  
General Email: tmd1@asus.com

### *Technical Support*

Support Fax: +1-510-608-4555  
General Support: +1-502-933-8713  
Web Site: www.asus.com  
Support Email: tsd@asus.com

## ASUS COMPUTER GmbH (Germany and Austria)

Address: Harkortstr. 25, 40880 Ratingen, BRD, Germany  
General Fax: +49-2102-442066  
General Email: sales@asuscom.de (for marketing requests only)

### *Technical Support*

Support Hotline: MB/Others: +49-2102-9599-0  
Notebook: +49-2102-9599-10  
Support Fax: +49-2102-9599-11  
Support (Email): www.asuscom.de/de/support (for online support)  
Web Site: www.asuscom.de



# P4GE-VM specifications summary

<b>CPU</b>	Socket 478 for Intel® Pentium® 4/Celeron On-die 512KB/256KB L2 cache with full speed Intel® Hyper-Threading technology ready New power design for up to 3.06 GHz or faster speed
<b>Chipset</b>	Intel 82845GE GMCH Intel 82801DB ICH4
<b>Front Side Bus (FSB)</b>	533/400 MHz
<b>Memory</b>	2 x 184-pin DDR DIMM sockets for up to 2GB memory Supports PC2700/PC2100 (FSB533) or PC2100/PC1600 (FSB400) unbuffered non-ECC DDR DIMMs
<b>Expansion slots</b>	1 x AGP 4X (1.5V only) 3 x PCI
<b>VGA</b>	Integrated 3D graphics controller in 82845GE chipset Supports ASUS DVI-845 graphics card (purchased separately)
<b>IDE</b>	2 x UltraDMA 100/66/33 connectors
<b>Audio (optional)</b>	RealTek ALC650 6-channel audio CODEC
<b>LAN (optional)</b>	Intel® 82562ET 10/100 Mbps Fast Ethernet controller
<b>Special features</b>	Power Loss Restart Digital audio via an S/PDIF Out interface AGP warning LED ASUS EZ Flash ASUS Q-Fan Technology CrashFree BIOS
<b>Rear panel I/O</b>	1 x Parallel port 1 x Serial port 1 x Video port 1 x PS/2 keyboard port 1 x PS/2 mouse port 4 x USB 2.0/USB 1.1 ports 1 x RJ-45 port (optional) Line In/Line Out/Microphone ports
<b>Internal I/O</b>	1 x USB 2.0/1.1 connector for 2 additional USB ports CPU/Chassis fan connectors 20-pin/4-pin ATX 12V power connectors IDE LED/Power LED connectors Chassis intrusion connector S/PDIF Out connector (optional) CD/AUX audio connectors GAME/MIDI connector Front panel audio connector COM2 connector

*(continued on the next page)*

# P4GE-VM specifications summary

<b>BIOS features</b>	2Mb Flash ROM, Award BIOS, TCAV, PnP, DMI2.0, WfM2.0, SM BIOS2.3, CrashFree BIOS, ASUS EZ Flash
<b>Industry standard</b>	PCI 2.2, USB 2.0
<b>Manageability</b>	WfM 2.0, DMI 2.0, WOL/WOR by PME, chassis intrusion, SMBus
<b>Form Factor</b>	Micro-ATX form factor: 9.6 in x 8.6 in (24.5 cm x 21.9 cm)
<b>Support CD contents</b>	Device drivers ASUS PC Probe ASUS LiveUpdate Trend Micro™ PC-cillin 2002 anti-virus software

*\* Specifications are subject to change without notice.*

# ***Chapter 1***

This chapter describes the features of the P4GE-VM motherboard. It includes brief descriptions of the motherboard components, and illustrations of the layout, jumper settings, and connectors.

## **Product introduction**

# 1.1 Welcome!

**Thank you for buying the ASUS® P4GE-VM motherboard!**

The ASUS P4GE-VM motherboard delivers a host of new features and latest technologies making it another standout in the long line of ASUS quality motherboards!

The motherboard incorporates the Intel® Pentium® 4 Processor in 478-pin package coupled with the Intel® 845GE chipset to set a new benchmark for a cost-effective desktop platform solution.

Supporting up to 2GB of system memory with PC2700/2100/1600 DDR SDRAM, high-resolution graphics via an AGP 4X slot, USB 2.0, and 6-channel audio features, the P4GE-VM is your affordable vehicle to enter the world of computing!

Before you start installing the motherboard, and hardware devices on it, check the items in your package with the list below.

## 1.2 Package contents

Check your P4GE-VM package for the following items.

- ✓ ASUS P4GE-VM motherboard  
Micro-ATX form factor: 9.6 in x 8.6 in (24.5 cm x 21.9 cm)
- ✓ ASUS P4GE-VM series support CD
- ✓ 80-conductor UltraDMA/66/100 IDE cable
- ✓ Ribbon cable for a 3.5-inch floppy drive
- ✓ I/O shield
- ✓ Bag of extra jumper caps
- ✓ User Guide



---

If any of the above items is damaged or missing, contact your retailer.

---

# 1.3 Motherboard components

Before you install the motherboard, learn about its major components and available features to facilitate the installation and future upgrades. Refer to the succeeding pages for the component descriptions.

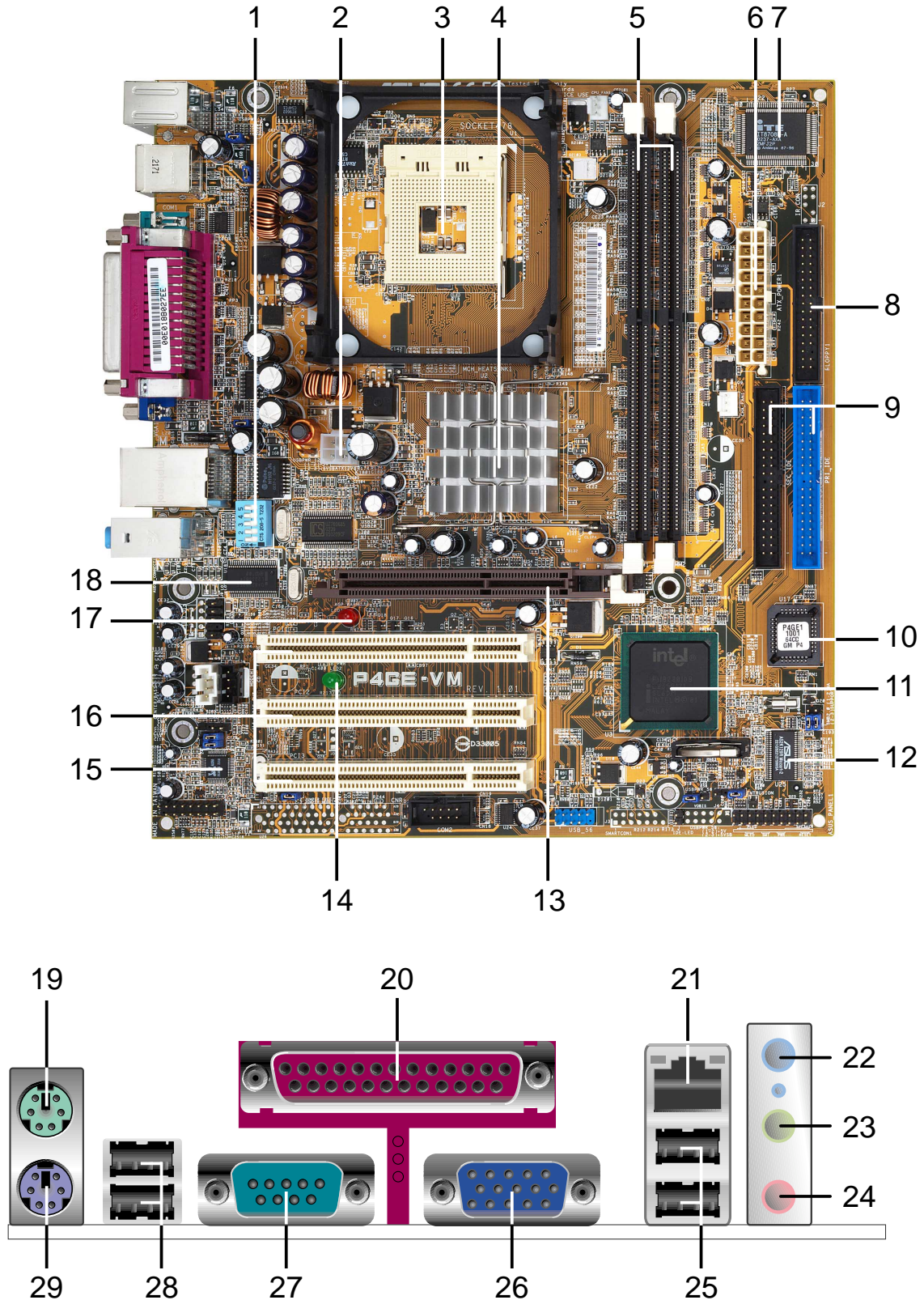

- 1** **DIP switches.** This 5-pin Dual Inline Package (DIP) switches allows you to select the CPU frequency multiple.
- 2** **ATX 12V connector.** This power connector connects the 4-pin 12V plug from the ATX 12V power supply.
- 3** **CPU socket.** A 478-pin surface mount, Zero Insertion Force (ZIF) socket for the Intel® Pentium® 4 Processor, with 533/400 MHz system bus that allows 4.3GB/s and 3.2GB/s data transfer rates, respectively.
- 4** **North bridge controller.** The Intel® 845GE Graphics Memory Controller Hub (GMCH) provides the processor interface with 533/400 MHz frequency, system memory interface at 333/266MHz operation, and 1.5V AGP interface that supports AGP 2.0 specification including 4X Fast Write protocol. The integrated graphics accelerator delivers 3D/2D video capabilities and a high bandwidth access to graphics data in the system memory at 2.2GB/s or 1.6GB/s. The GMCH interconnects to the south bridge ICH4 via the Intel® proprietary Hub Interface.
- 5** **DDR DIMM sockets.** These two 184-pin DIMM sockets support up to 2GB system memory using unbuffered non-ECC PC2700/PC2100/PC1600 DDR DIMMs.
- 6** **ATX power connector.** This 20-pin connector connects to an ATX +12V power supply. The power supply must have at least 1A on the +5V standby lead (+5VSB).
- 7** **Super I/O controller.** This Low Pin Count (LPC) interface provides the commonly used Super I/O functionality. The chipset supports a high-performance floppy disk controller for a 360K/720K/1.44M/2.88M floppy disk drive, a multi-mode parallel port, two standard compatible UARTs, and a Flash ROM interface.
- 8** **Floppy disk connector.** This connector accommodates the provided ribbon cable for the floppy disk drive. One side of the connector is slotted to prevent incorrect insertion of the floppy disk cable.
- 9** **IDE connectors.** These dual-channel bus master IDE connectors support Ultra DMA/100/66, PIO Modes 3 & 4 IDE devices. Both the primary (blue) and secondary (black) connectors are slotted to prevent incorrect insertion of the IDE ribbon cable.
- 10** **Flash ROM.** This 2Mb firmware contains the programmable BIOS program.
- 11** **South bridge controller.** The fourth-generation Intel I/O Controller Hub (ICH4) is a subsystem that integrates various I/O functions including 2-channel ATA/100 bus master IDE controller, up to six USB 2.0/1.1 ports, I/O APIC, SMBus 2.0 controller, LPC interface, AC'97 2.2 interface, and PCI 2.2 interface. The ICH4 also contains the necessary arbitration and buffering for efficient utilization of these interfaces.
- 12** **ASUS ASIC.** This chip performs multiple system functions that include hardware and system voltage monitoring, IRQ routing, among others.
- 13** **AGP slot.** This Accelerated Graphics Port (AGP) slot supports 1.5V AGP4X mode graphics cards for 3D graphical applications.

- 14 Standby power LED.** This LED lights up if there is a standby power on the motherboard. This LED acts as a reminder to turn off the system power before plugging or unplugging devices.
- 15 Audio CODEC.** The RealTek ALC650 is an AC'97 CODEC that allows 6-channel audio playback. The audio CODEC provides six DAC channels for 5.1 surround sound, S/PDIF interface, AUX and Line In stereo inputs, integrated headphone amplifier, greater than 90dB dynamic range, and Mic PREAMP support. *(on audio models only)*
- 16 PCI slots.** These three 32-bit PCI 2.2 expansion slots support bus master PCI cards like SCSI or LAN cards with 133MB/s maximum throughput.
- 17 AGP warning LED.** Serving as a smart burn-out protection for the motherboard, this red LED lights up if you plug in any 3.3V AGP card into the AGP slot. When this LED is lit, there is no way you can turn on the system power even if you press the power button.
- 18 LAN PHY.** This Intel 82562ET LAN PHY works with the integrated MAC in the South Bridge (ICH4) to fully support 10BASE-T/ 100BASE-TX Ethernet networking. *(on LAN models only)*
- 19 PS/2 mouse port.** This green 6-pin connector is for a PS/2 mouse.
- 20 Parallel port.** This 25-pin port connects a parallel printer, a scanner, or other devices.
- 21 RJ-45 port.** This port allows connection to a Local Area Network (LAN) through a network hub. *(on LAN models only)*
- 22 Line In jack.** This Line In (light blue) jack connects a tape player or other audio sources. In 6-channel mode, the function of this jack becomes Bass/Center.
- 23 Line Out jack.** This Line Out (lime) jack connects a headphone or a speaker. In 6-channel mode, the function of this jack becomes Front Speaker Out.
- 24 Microphone jack.** This Mic (pink) jack connects a microphone. In 6-channel mode, the function of this jack becomes Rear Speaker Out.
- 25 USB 2.0 ports 1 and 2.** These two 4-pin Universal Serial Bus (USB) ports are available for connecting USB 2.0 devices.
- 26 Video port.** This port is for a VGA monitor or other VGA-compatible devices.
- 27 Serial port.** This 9-pin COM1 port is for pointing devices or other serial devices.
- 28 USB 2.0 ports 3 and 4.** These two 4-pin Universal Serial Bus (USB) ports are available for connecting USB 2.0 devices.
- 29 PS/2 keyboard port.** This purple connector is for a PS/2 keyboard.

# 1.4 Motherboard layout

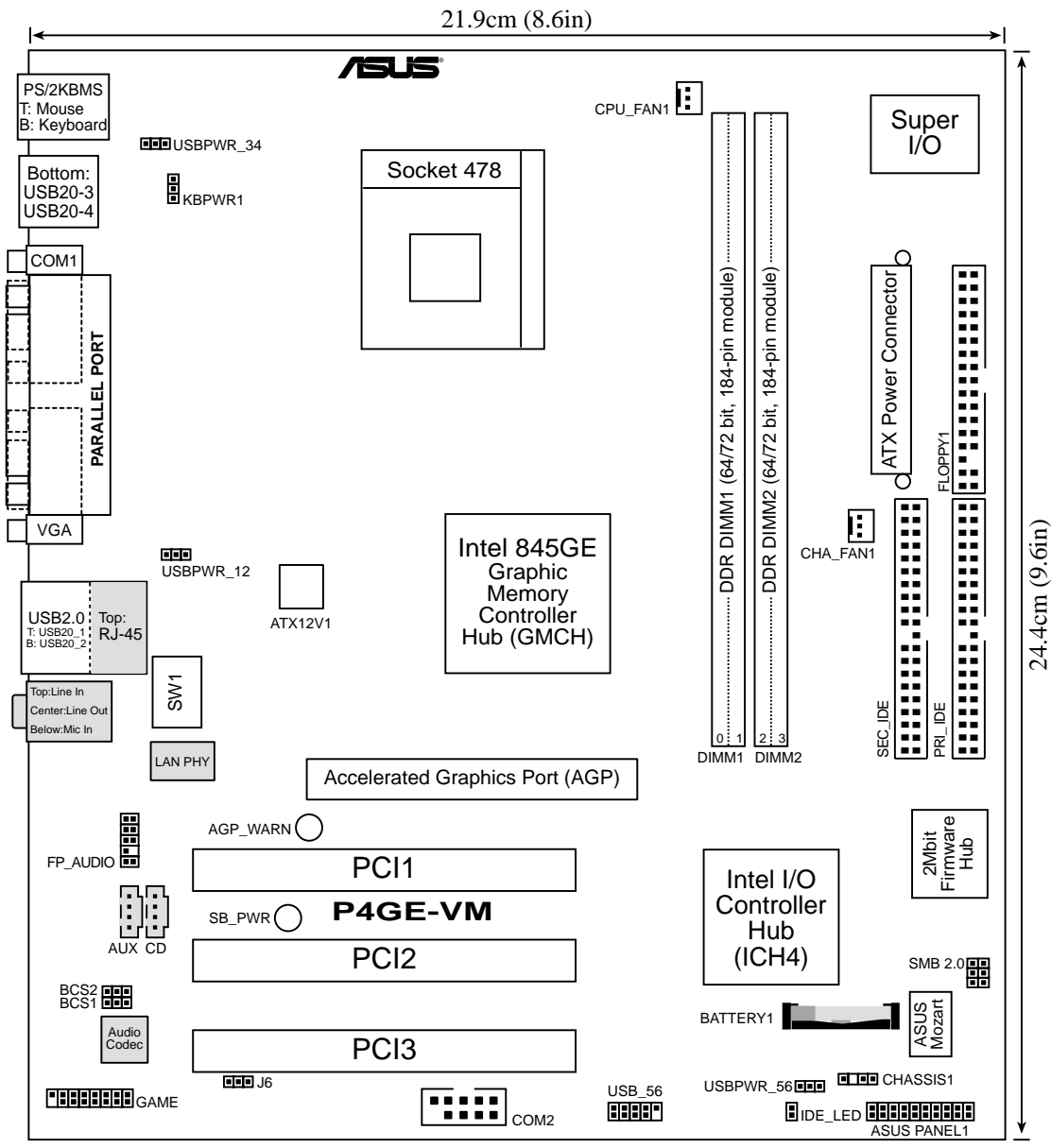



## 1.5 Before you proceed

Take note of the following precautions before you install motherboard components or change any motherboard settings.



1. Unplug the power cord from the wall socket before touching any component.
2. Use a grounded wrist strap or touch a safely grounded object or to a metal object, such as the power supply case, before handling components to avoid damaging them due to static electricity.
3. Hold components by the edges to avoid touching the ICs on them.
4. Whenever you uninstall any component, place it on a grounded antistatic pad or in the bag that came with the component.
5. **Before you install or remove any component, ensure that the ATX power supply is switched off or the power cord is detached from the power supply.** Failure to do so may cause severe damage to the motherboard, peripherals, and/or components.



When lit, the green LED (SB\_PWR1) indicates that the system is ON, in sleep mode, or in soft-off mode, a reminder that you should shut down the system and unplug the power cable before removing or plugging in any motherboard component.

The red LED (AGP\_WARN1) is a smart protection from motherboard burn out caused by an incorrect AGP card. If you plug in any 3.3V AGP card into the 1.5V AGP slot, this LED lights up thus preventing the system to power up. This LED remains off if you plug in a 1.5V AGP card.

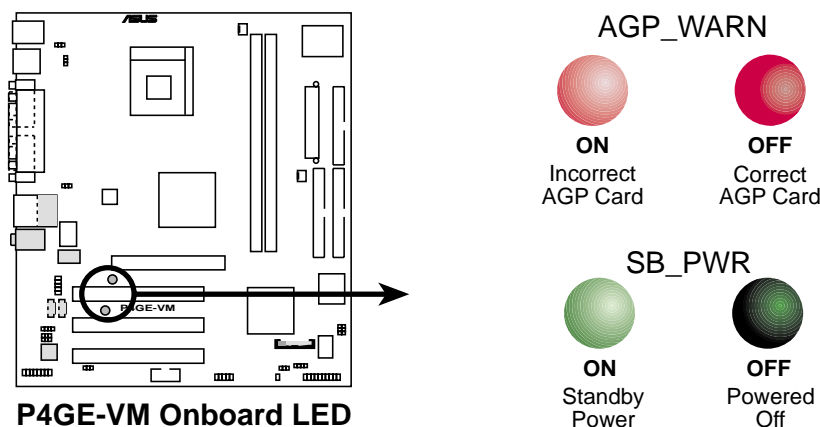

Install only 1.5V AGP cards on this motherboard!

## 1.6 Motherboard installation

Before you install the motherboard, study the configuration of your chassis to ensure that the motherboard fits into it. The motherboard uses the micro-ATX form factor that measures 9.6 inches x 8.6 inches (24.5 cm x 21.9 cm).



Make sure to unplug the power cord before installing or removing the motherboard. Failure to do so may cause you physical injury and damage motherboard components.

### 1.6.1 Placement direction

When installing the motherboard, make sure that you place it into the chassis in the correct orientation. The edge with external ports goes to the rear part of the chassis as indicated in the image below.

### 1.6.2 Screw holes

Place six (6) screws into the holes indicated by circles to secure the motherboard to the chassis.



Do not overtighten the screws! Doing so may damage the motherboard.

Place this side towards  
the rear of the chassis

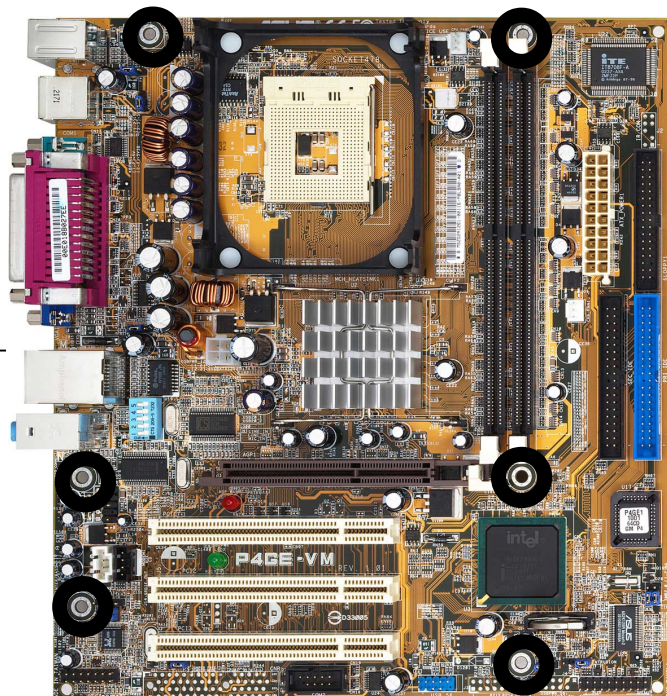

# 1.7 Central Processing Unit (CPU)

## 1.7.1 Overview

The motherboard comes with a surface mount 478-pin Zero Insertion Force (ZIF) socket. The socket is designed for the Intel® Pentium® 4 Processor in the 478-pin package with 512KB L2 cache on 0.13 micron process. This processor supports 533/400MHz front side bus (FSB), and allows data transfer rates of 4.2GB/s and 3.2GB/s.

Note in the illustration that the CPU has a gold triangular mark on one corner. This mark indicates the processor Pin 1 that should match a specific corner of the CPU socket.

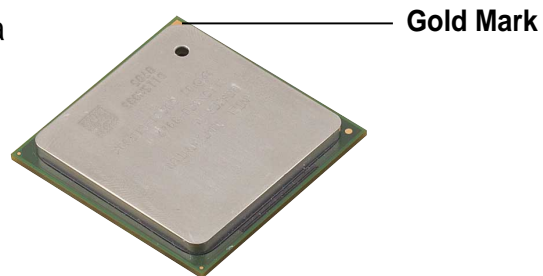

---

Incorrect installation of the CPU into the socket may bend the pins and severely damage the CPU!

---

## Notes on Intel® Hyper-Threading Technology



1. This motherboard supports Intel Pentium 4 CPUs with Hyper-Threading Technology.
  2. Hyper-Threading Technology is supported under **Windows XP** and **Linux 2.4.x (kernel)** and later versions only. Under Linux, use the Hyper-Threading compiler to compile the code. If you are using any other operating systems, disable the Hyper-Threading Technology item in BIOS to ensure system stability and performance.
  3. It is recommended that you install WinXP Service Pack 1.
  4. Make sure to enable the Hyper-Threading Technology item in BIOS before installing a supported operating system.
  5. For more information on Hyper-Threading Technology, visit [www.intel.com/info/hyperthreading](http://www.intel.com/info/hyperthreading).
- 

To use the Hyper-Threading Technology on this motherboard:

1. Buy an Intel Pentium 4 CPU that supports Hyper-Threading Technology. Install the CPU.
2. Power up the system and enter BIOS Setup (see Chapter 2). Under the Advanced Menu, make sure that the item **Hyper-Threading Technology** is set to Enabled. The item appears only if you installed a CPU that supports Hyper-Threading Technology.
3. Reboot the computer.

## 1.7.2 Installing the CPU

Follow these steps to install a CPU.

1. Locate the 478-pin ZIF socket on the motherboard.
2. Unlock the socket by pressing the lever sideways, then lift it up to a 90°-100° angle.



Make sure that the socket lever is lifted up to 90°-100° angle, otherwise the CPU does not fit in completely.

Socket Lever

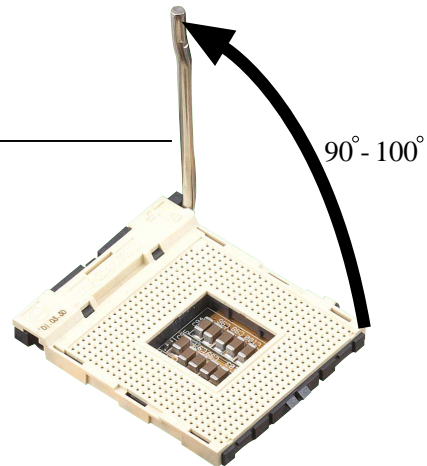

3. Position the CPU above the socket such that its marked corner matches the base of the socket lever.
4. Carefully insert the CPU into the socket until it fits in place.

Gold Mark

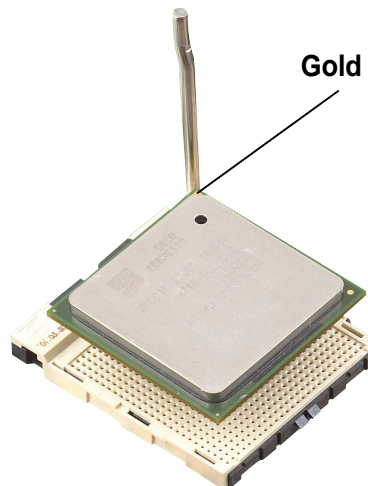

The CPU fits only in one correct orientation. DO NOT force the CPU into the socket to prevent bending the pins and damaging the CPU!

5. When the CPU is in place, push down the socket lever to secure the CPU. The lever clicks on the side tab to indicate that it is locked.
6. Install a CPU heatsink and fan following the instructions that came with the heatsink package.
7. Connect the CPU fan cable to the CPU\_FAN1 connector on the motherboard.

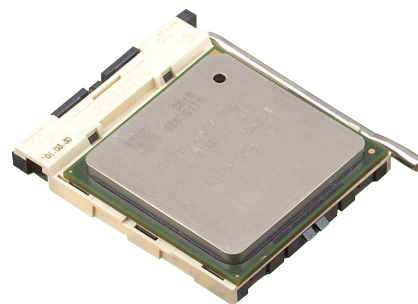

## 1.8 System memory

The motherboard comes with two Double Data Rate (DDR) Dual Inline Memory Module (DIMM) sockets. These sockets support up to 2GB system memory using 184-pin unbuffered non-ECC PC2700/PC2100 (FSB533) or PC2100/PC1600 (FSB400) DDR DIMMs.

The following figure illustrates the location of the DDR DIMM sockets.

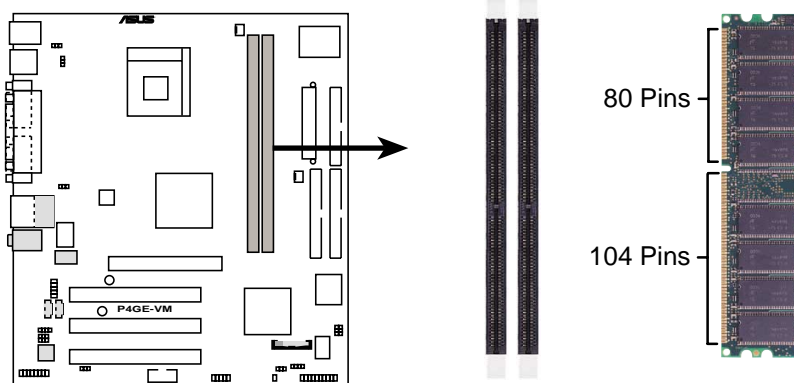

**P4GE-VM 184-Pin DDR DIMM Sockets**

This motherboard supports different memory frequencies depending on the CPU FSB (Front Side Bus) and the type of DDR DIMM.

CPU FSB	DDR DIMM Type	Memory Frequency
533 MHz	PC2700	333 MHz
	PC2100	266 MHz
400 MHz	PC2100	266 MHz
	PC1600	200 MHz



Make sure to unplug the power supply before adding or removing DIMMs or other system components. Failure to do so may cause severe damage to both the motherboard and the components.

Follow these steps to install a DIMM.

1. Unlock a DIMM socket by pressing the retaining clips outward.
2. Align a DIMM on the socket such that the notch on the DIMM matches the break on the socket.
3. Firmly insert the DIMM into the socket until the retaining clips snap back in place and the DIMM is properly seated.

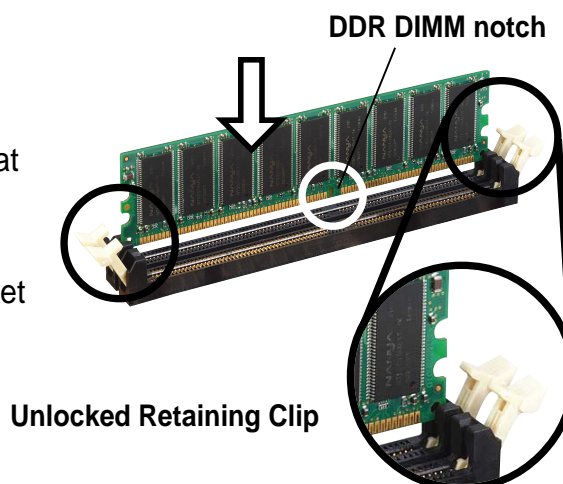

# 1.9 Expansion slots

The motherboard has three PCI slots and one Accelerated Graphics Port (AGP) slot.

To install and configure an expansion card:

1. Install an expansion card following the instructions that came with the chassis.  
NOTE: The AGP slot supports only 1.5V AGP cards.
2. Turn on the system and change the necessary BIOS settings, if any. See Chapter 2 for BIOS information.
3. Assign an IRQ to the card. Refer to the tables below.
4. Install the drivers and/or software applications for the expansion card according to the card documentation.

## 1.9.1 Standard interrupt assignments

IRQ	Priority	Standard Function
0	1	System Timer
1	2	Keyboard Controller
2	N/A	Programmable Interrupt
3*	11	Communications Port (COM2)
4*	12	Communications Port (COM1)
5*	13	IRQ holder for PCI steering
6	14	Floppy Disk Controller
7*	15	Printer Port (LPT1)
8	3	System CMOS/Real Time Clock
9*	4	IRQ holder for PCI steering
10*	5	Advance AC'97 CODEC
11*	6	Standard PCI Graphics Adapter (VGA)
12*	7	PS/2 Compatible Mouse Port
13	8	Numeric Data Processor
14*	9	Primary IDE Channel
15*	10	Secondary IDE Channel

\* These IRQs are usually available for ISA or PCI devices.

## 1.9.2 IRQ assignments for this motherboard

	A	B	C	D	E	F	G	H
PCI slot 1	—	—	—	—	—	used	—	—
PCI slot 2	—	—	—	—	—	—	used	—
PCI slot 3	—	—	—	—	—	—	—	shared
AGP slot	shared	—	—	—	—	—	—	—
Onboard USB controller 1	shared	—	—	—	—	—	—	—
Onboard USB controller 2	—	—	—	used	—	—	—	—
Onboard USB controller 3	—	—	used	—	—	—	—	—
Onboard USB 2.0 controller	—	—	—	—	—	—	—	shared
Onboard LAN (optional)	—	—	—	—	used	—	—	—
Onboard audio	—	used	—	—	—	—	—	—



When using PCI cards on shared slots, ensure that the drivers support “Share IRQ” or that the cards do not need IRQ assignments. Otherwise, conflicts will arise between the two PCI groups, making the system unstable and the card inoperable.

## 1.10 Switches and jumpers

The motherboard frequency is adjusted through the DIP switches. The white block represents the switch position. The illustration below shows the ON and OFF positions of the switches.

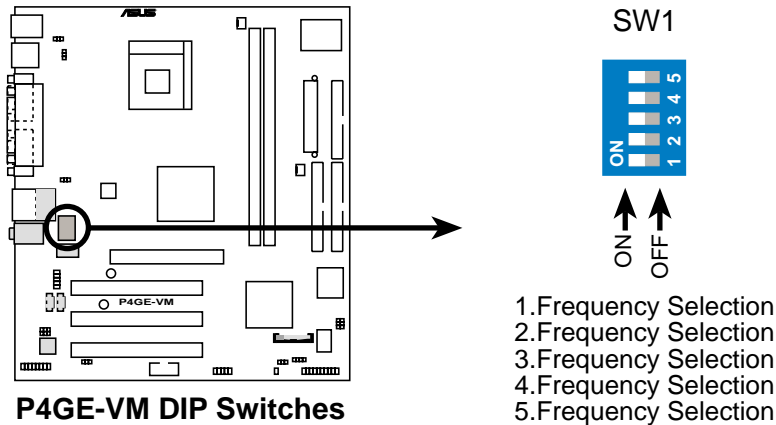

Make sure that the J6 jumper is set to pins 2-3 ( jumper mode) before setting the above switches.

The option to set the CPU core:bus frequency multiple is available only on unlocked CPUs. If you are using a locked CPU, setting the switches does not produce any effect.

### 1. CPU external frequency selection (SW1 Switches 1-5)

This option tells the clock generator what frequency to send the CPU. This allows the selection of the CPU's external frequency (or Bus Clock). The BUS Clock multiplied by the Frequency Multiple equals the CPU's internal frequency (the advertised CPU speed).



To select the CPU external frequency using the DIP switches, ensure that the J6 jumper is set to jumper mode.

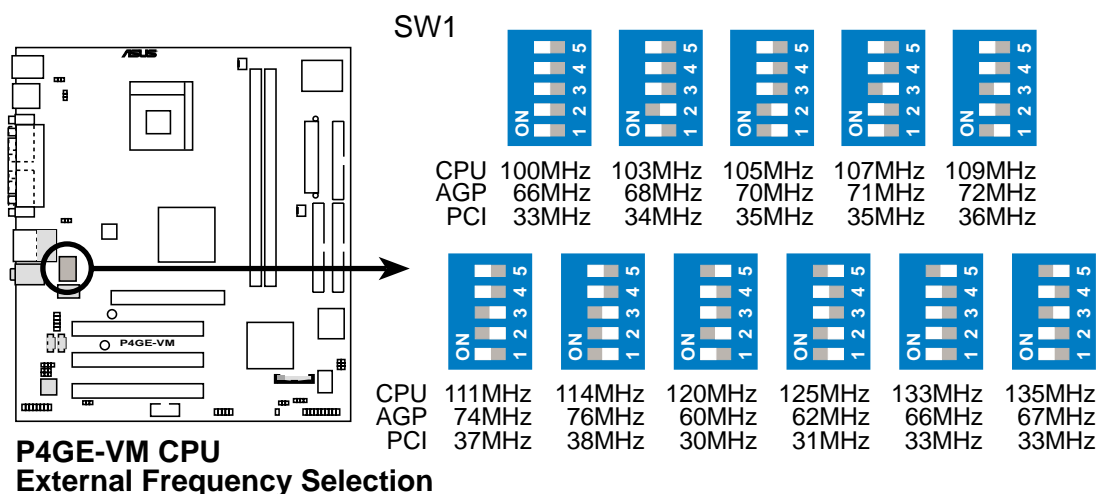

Set the CPU frequency only to the recommended settings. Frequencies other than the recommended CPU bus frequencies are not guaranteed to be stable.

## 2. JumperFree™ mode (J6)

This jumper allows you to enable or disable the JumperFree™ mode. The JumperFree mode allows you to change CPU settings through the BIOS setup instead of using the DIP switches.

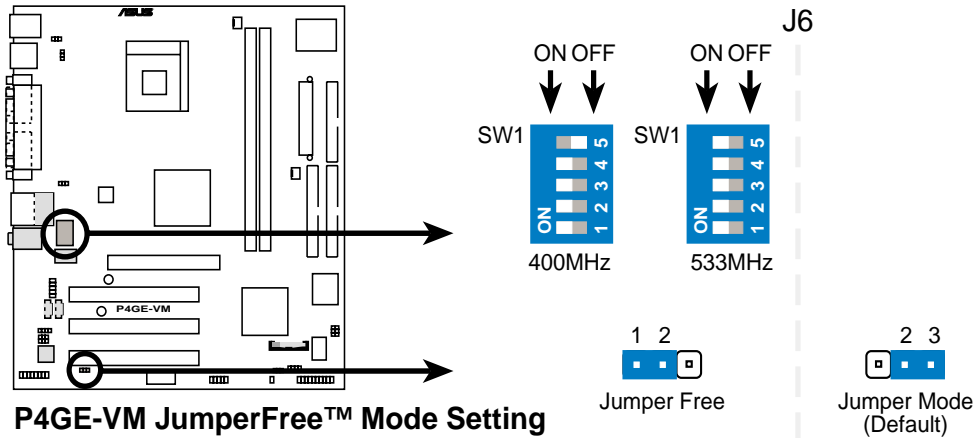

The J6 jumper is set in conjunction with the DIP switches. In JumperFree mode, set the DIP switches as shown above depending on the CPU FSB (Front Side Bus).

In jumper mode, set the switches as shown in item 1 (CPU external frequency selection).

## 3. Keyboard power (3-pin KBPWR1)

This jumper allows you to enable or disable the keyboard wake-up feature. Set this jumper to pins 2-3 (+5VSB) if you wish to wake up the computer when you press a key on the keyboard (the default is the Space Bar). This feature requires an ATX power supply that can supply at least 1A on the +5VSB lead, and a corresponding setting in the BIOS (see section 2.5.1 Power Up Control).

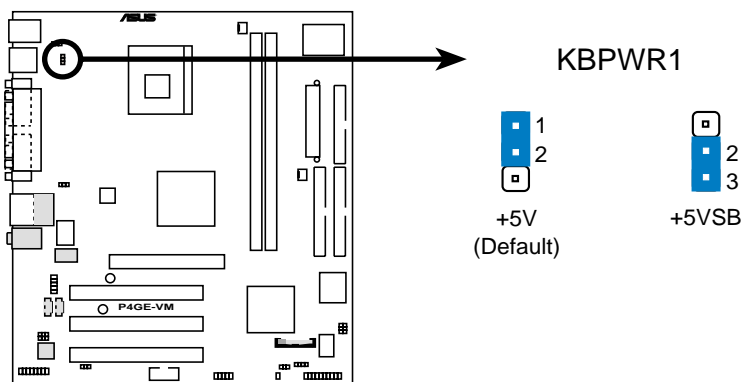

**P4GE-VM Keyboard Power Setting**



#### 4. USB device wake-up (3-pin USBPWR\_12, USBPWR\_34, USBPWR\_56)

Set these jumpers to +5V to wake up the computer from S1 sleep mode (CPU stopped, DRAM refreshed, system running in low power mode) using the connected USB devices. Set to +5VSB to wake up from S3 sleep mode (no power to CPU, DRAM in slow refresh, power supply in reduced power mode). Both jumpers are set to pins 1-2 (+5V) by default because not all computers have the appropriate power supply to support this feature.

The USBPWR\_12 and USBPWR\_34 jumpers are for the rear USB ports. The USBPWR\_56 jumper is for the internal USB header that you can connect to the front USB ports.



1. This feature requires a power supply that can provide at least 1A on the +5VSB lead when these jumpers are set to +5VSB. Otherwise, the system would not power up.
2. The total current consumed must NOT exceed the power supply capability (+5VSB) whether under normal condition or in sleep mode.

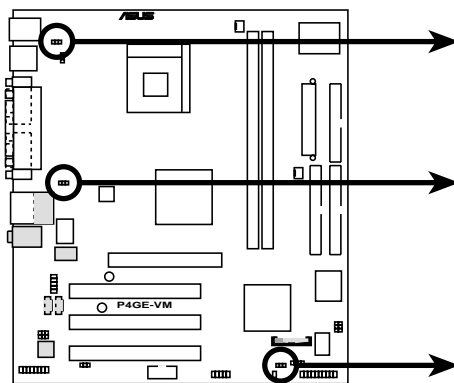

USBPWR\_34  
USBPWR\_12  
USBPWR\_56

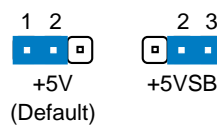

**P4GE-VM USB Device Wake Up**

#### 5. SMBus 2.0 setting (6-pin J12)

This jumper allows you to enable or disable the SMBus 2.0 support on the motherboard. When these jumpers are set to pins 2-3 (Support), you may install PCI devices that comply with SMBus 2.0 specification.

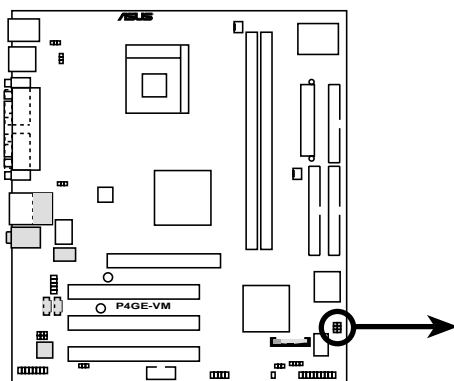

SMB2.0

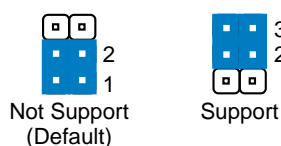

**P4GE-VM SMBus 2.0**

## 6. Bass/Center setting (3-pin BCS1, BCS2) *(on audio models only)*

These jumpers allow you to select the speaker output for a 6-channel audio system. Switch the jumpers from the BASS/CENTER (pins 1-2) position to CENTER/BASS (pins 2-3) position to re-route signals on the internal leads of the Mic port.



Use the audio driver included in the support CD to install the multi-channel audio feature.

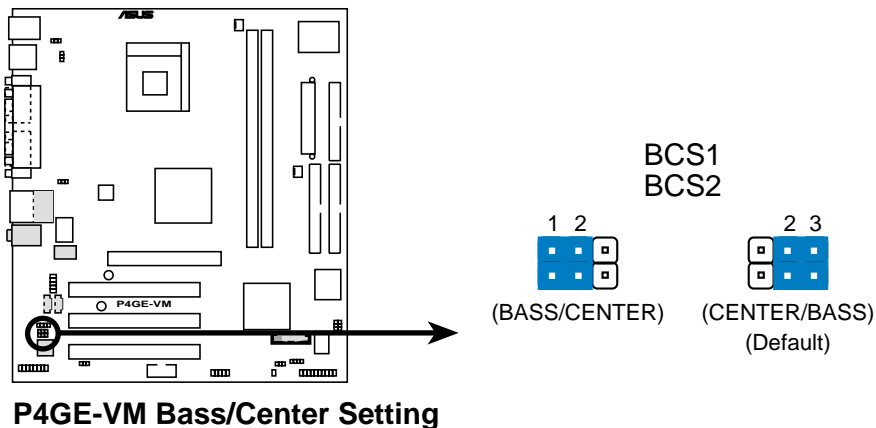

## 1.11 Connectors

This section describes and illustrates the internal connectors on the motherboard.

### 1. Hard disk activity LED (2-pin IDE\_LED)

This connector supplies power to the hard disk activity LED. The read or write activities of any device connected to the primary or secondary IDE connector cause this LED to light up.

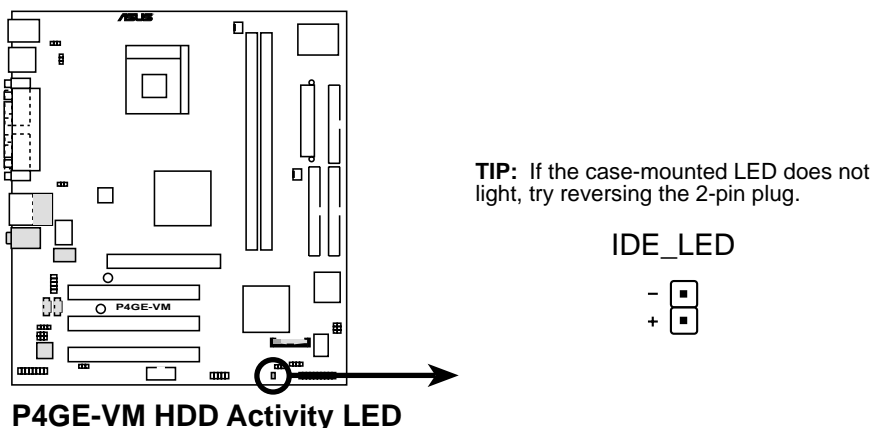

## 2. Floppy disk drive connector (34-1 pin FLOPPY)

This connector supports the provided floppy drive ribbon cable. After connecting one end to the motherboard, connect the other end to the floppy drive. (Pin 5 is removed to prevent incorrect insertion when using ribbon cables with pin 5 plug).

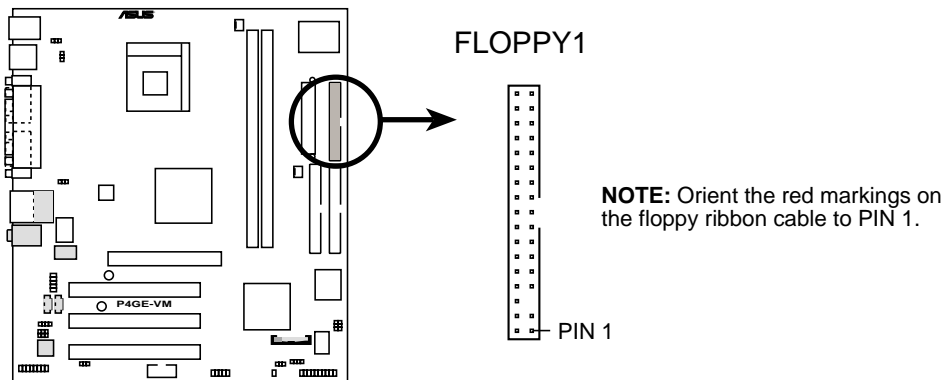

**P4GE-VM Floppy Disk Drive Connector**

## 3. IDE connectors (40-1 pin PRI\_IDE, SEC\_IDE)

This connector supports the provided UltraDMA/100/66 IDE hard disk ribbon cable. Connect the cable's blue connector to the primary (recommended) or secondary IDE connector, then connect the gray connector to the UltraDMA/100/66 slave device (hard disk drive) and the black connector to the UltraDMA/100/66 master device. It is recommended that you connect non-UltraDMA/100/66 devices to the secondary IDE connector. If you install two hard disks, you must configure the second drive as a slave device by setting its jumper accordingly. Refer to the hard disk documentation for the jumper settings. BIOS supports specific device bootup. If you have more than two UltraDMA/100/66 devices, purchase another UltraDMA/100/66 cable. You may configure two hard disks to be both master devices with two ribbon cables – one for the primary IDE connector and another for the secondary IDE connector.



1. Pin 20 on each IDE connector is removed to match the covered hole on the UltraDMA cable connector. This prevents incorrect orientation when you connect the cables.
2. The hole near the blue connector on the UltraDMA/100/66 cable is intentional.

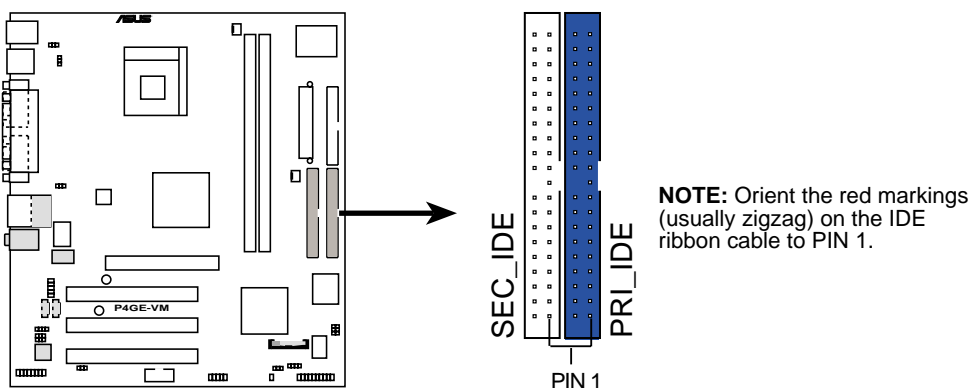

**P4GE-VM IDE Connectors**

#### 4. Serial port 2 connector (10-1 pin COM2)

This connector accommodates a second serial port using an optional serial port bracket. Connect the bracket cable to this connector then install the bracket into a slot opening at the back of the system chassis.



The COM2 Bracket is purchased separately.

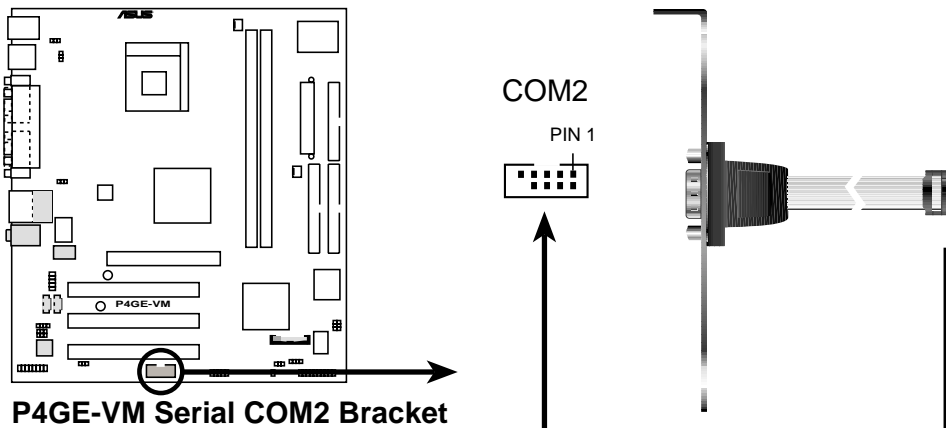

#### 5. ATX power connectors (20-pin ATX\_POWER1, 4-pin ATX12V)

These connectors connect to an ATX 12V power supply. The plugs from the power supply are designed to fit these connectors in only one orientation. Find the proper orientation and push down firmly until the connectors completely fit.

In addition to the 20-pin ATXPWR connector, this motherboard requires that you connect the 4-pin ATX +12V power plug to provide sufficient power to the CPU.



Make sure that your ATX 12V power supply can provide 8A on the +12V lead and at least 1A on the +5-volt standby lead (+5VSB). The minimum recommended wattage is 230W, or 300W for a fully configured system. The system may become unstable and may experience difficulty powering up if the power supply is inadequate.

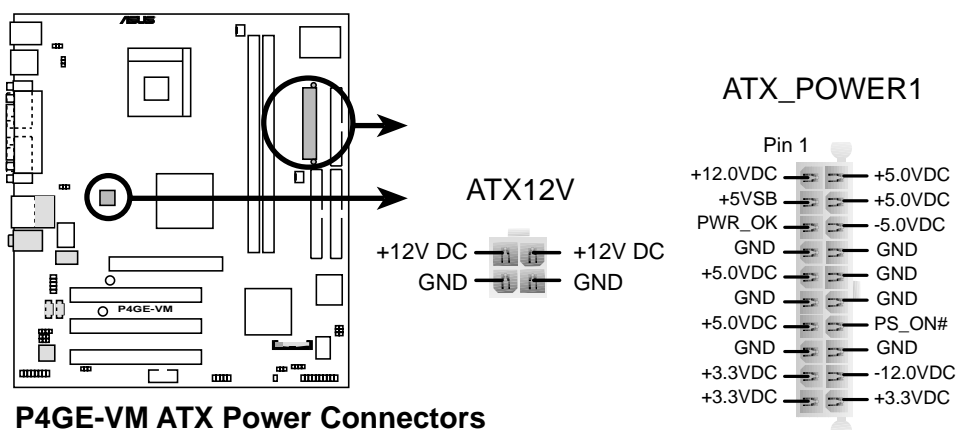

## 6. CPU and Chassis Fan Connectors (3-pin CPU\_FAN1, CHA\_FAN1)

The fan connectors support cooling fans of 350mA~740mA (8.88W max.) or a total of 1A~2.22A (26.64W max.) at +12V. Connect the fan cables to the fan connectors on the motherboard, making sure that the black wire of each cable matches the ground pin of the connector.



Do not forget to connect the fan cables to the fan connectors. Lack of sufficient air flow within the system may damage the motherboard components. These are not jumpers! DO NOT place jumper caps on the fan connectors!

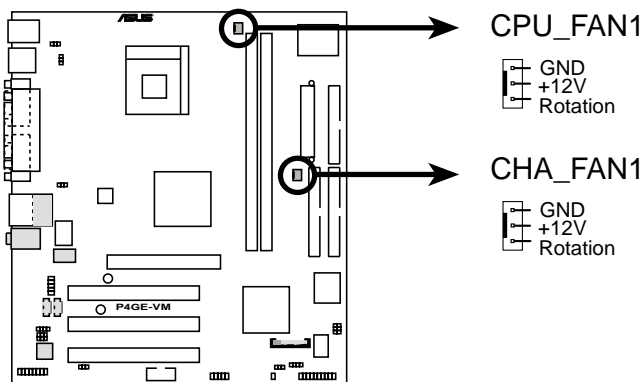

**P4GE-VM 12-Volt Cooling Fan Power**

## 7. Chassis intrusion connector (4-1 pin CHASSIS)

This lead is for a chassis designed with intrusion detection feature. This requires an external detection mechanism such as a chassis intrusion sensor or microswitch. When you remove any chassis component, the sensor triggers and sends a high-level signal to this lead to record a chassis intrusion event.

By default, the pins labeled “Chassis Signal” and “Ground” are shorted with a jumper cap. If you wish to use the chassis intrusion detection feature, remove the jumper cap from the pins.

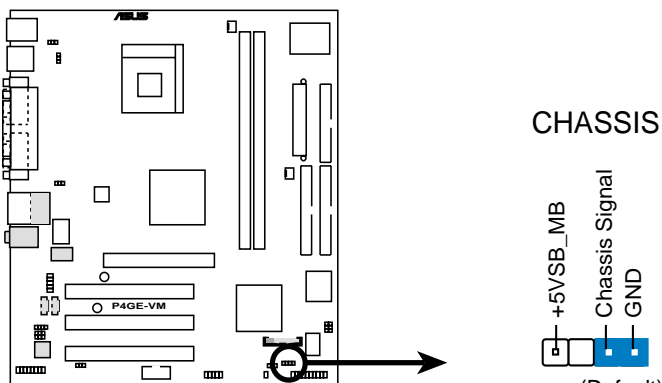

**P4GE-VM Chassis Alarm Lead**

## 8. GAME/MIDI connector (16-1 pin GAME1)

This connector supports a GAME/MIDI module. Connect an optional GAME/MIDI cable to this connector. The GAME/MIDI port on the module connects a joystick or a game pad for playing games, and MIDI devices for playing or editing audio files.



The USB/GAME module is purchased separately.

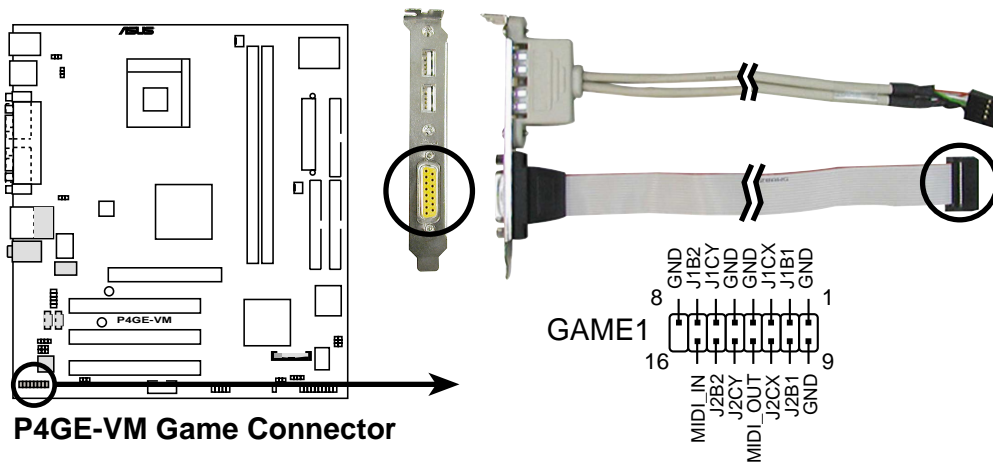

## 9. USB header (10-1 pin USB\_56)

If the USB ports on the rear panel are inadequate, a USB header is available for additional USB ports. The USB header complies with USB 2.0 specification that supports up to 480 Mbps connection speed. This speed advantage over the conventional 12 Mbps on USB 1.1 allows faster Internet connection, interactive gaming, and simultaneous running of high-speed peripherals.

You may connect an optional USB 2.0/GAME module, connect the USB cable to this header. The module has two USB 2.0 ports that support the next generation USB peripherals such as high resolution cameras, scanners, and printers.



The USB/GAME module is purchased separately.

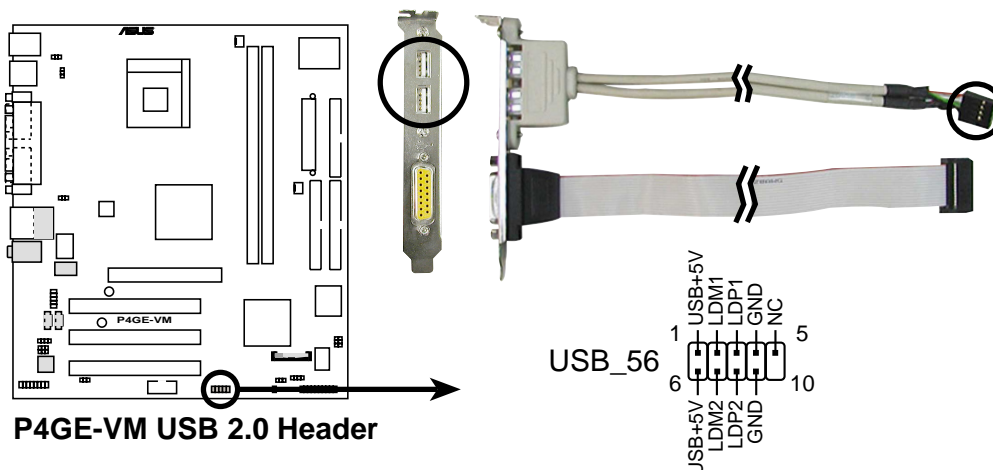

## 10. Digital audio connector (4-1 pin SPDIF\_OUT) *(on audio models only)*

This connector is for a S/PDIF audio module that allows digital instead of analog sound output. Connect one end of the audio cable to the S/PDIF Out connector on the motherboard, and the other end to the S/PDIF module.



The S/PDIF module is purchased separately.

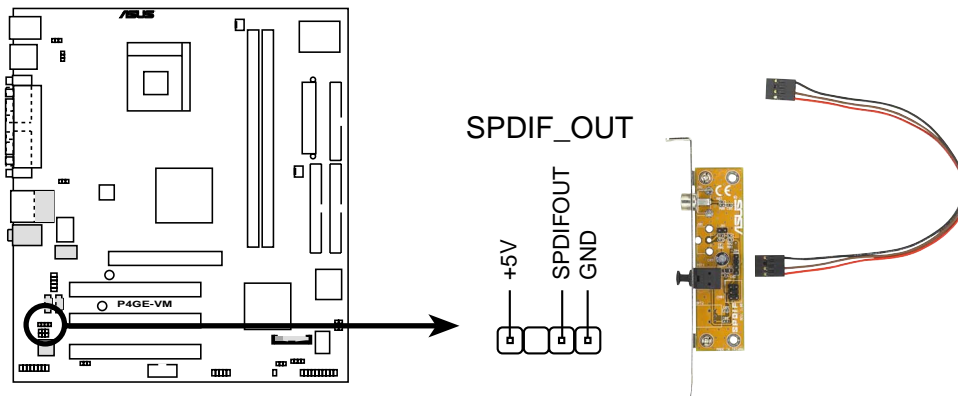

**P4GE-VM Digital Audio Connector**

## 11. Front panel audio connector (10-1 pin FP\_AUDIO) *(on audio models only)*

*(on audio models only)*

This is an interface for the Intel front panel audio cable that allow convenient connection and control of audio devices.

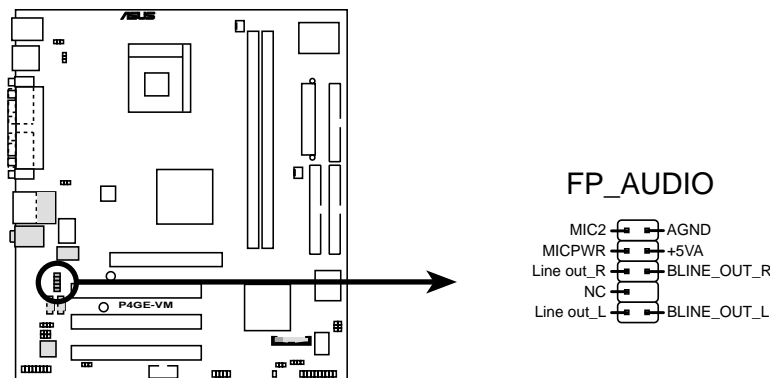

**P4GE-VM Front Panel Audio Connector**

## 12. Internal audio connectors (4-pin CD1, AUX1) *(on audio models only)*

These connectors allow you to receive stereo audio input from sound sources such as a CD-ROM, TV tuner, or MPEG card.

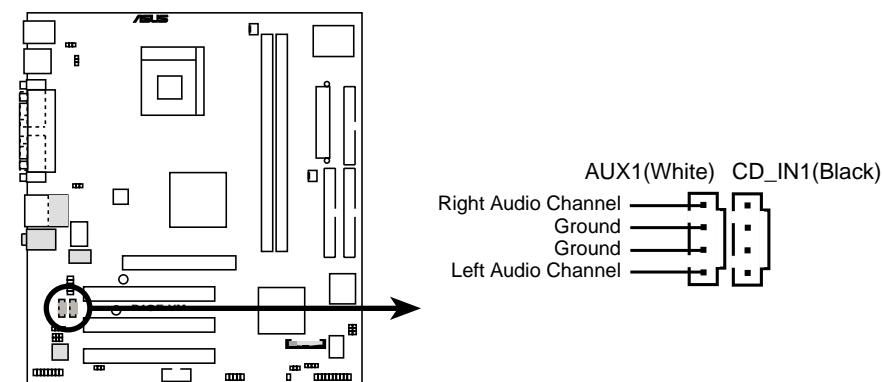

**P4GE-VM Internal Audio Connectors**

### 13. System panel connector (20-pin PANEL1)

This connector accommodates several system front panel functions.

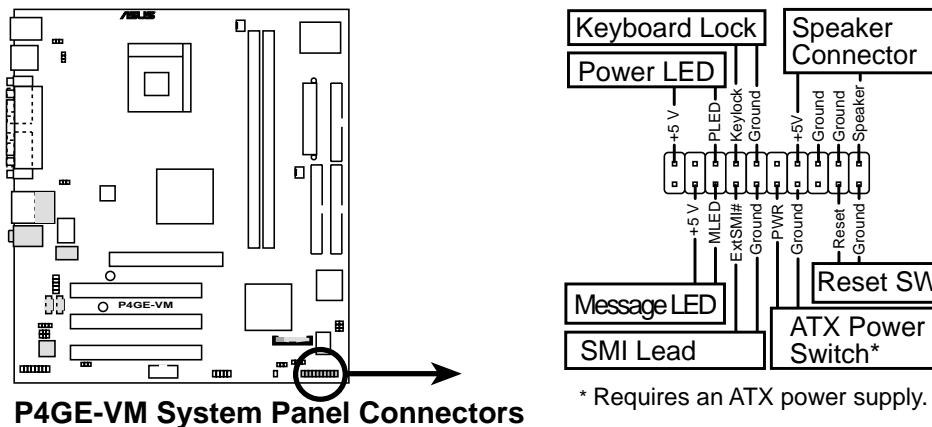

- **System Power LED Lead (3-1 pin PLED)**

This 3-1 pin connector connects to the system power LED. The LED lights up when you turn on the system power, and blinks when the system is in sleep mode.

- **Keyboard Lock Lead (2-pin KEYLOCK)**

This 2-pin connector connects to a chassis-mounted switch to allow the use of the keyboard lock feature.

- **System Warning Speaker Lead (4-pin SPKR)**

This 4-pin connector connects to the case-mounted speaker and allows you to hear system beeps and warnings.

- **System Management Interrupt Lead (2-pin SMI)**

This 2-pin connector allows you to manually place the system into a suspend mode, or “green” mode, where system activity is instantly decreased to save power and to expand the life of certain system components. Attach the case-mounted suspend switch to this 2-pin connector.

- **ATX Power Switch / Soft-Off Switch Lead (2-pin PWRBTN)**

This connector connects a switch that controls the system power. Pressing the power switch turns the system between ON and SLEEP, or ON and SOFT OFF, depending on the BIOS or OS settings. Pressing the power switch while in the ON mode for more than 4 seconds turns the system OFF.

- **Reset Switch Lead (2-pin RESET)**

This 2-pin connector connects to the case-mounted reset switch for rebooting the system without turning off the system power.



# ***Chapter 2***

This chapter tells how to change system settings through the BIOS Setup menus. Detailed descriptions of the BIOS parameters are also provided.

## **BIOS information**

## 2.1 Managing and updating your BIOS



---

It is recommended that you save a copy of the motherboard's **original BIOS** to a bootable floppy disk in case you need to reinstall the original BIOS later.

---

### 2.1.1 Using ASUS EZ Flash to update the BIOS

The ASUS EZ Flash feature allows you to easily update the BIOS without having to go through the long process of booting from a diskette and using a DOS-based utility. The EZ Flash is built-in the BIOS firmware so it is accessible by simply pressing <Alt> + <F2> during the Power-On Self Tests (POST).

Follow these steps to update the BIOS using ASUS EZ Flash.

1. Download the latest BIOS file from the ASUS website (see ASUS contact information on page viii). Save the file to a floppy disk.



---

Write down the BIOS file name on a piece of paper. You need to type the **exact BIOS file name** at the EZ Flash screen.

---

2. Reboot the computer.
3. To use EZ Flash, press <Alt> + <F2> during POST to display the following screen.

```
ASUS EZ Flash V1.00
Copyright (C) 2002, ASUSTeK COMPUTER INC.

[Onboard BIOS Information]
BIOS Version      : ASUS P4GE-VM ACPI BIOS Revision 1002
BIOS Model       : P4GE-VM
BIOS Built Date  : 04/16/02

Please Enter File Name for NEW BIOS: _
*Note: EZ Flash will copy file from A:\, Press [ESC] to reboot
```



---

The BIOS information in the above screen is for reference only. What you see on your screen may not be exactly the same as shown.

---

4. Insert the disk that contains the new BIOS file into the floppy drive. You will receive the error message, "**WARNING! Device not ready.**" if you proceed to step 5 without the disk in the drive.

- At the prompt, “**Please Enter File Name for NEW BIOS: \_**”, type in the BIOS file name that you downloaded from the ASUS website, then press <Enter>. EZ Flash will automatically access drive A to look for the file name that you typed. When found, the following message appears on screen.

```
[BIOS Information in File]
BIOS Version: P4GE-VM Boot Block

WARNING! Continue to update the BIOS (Y/N)? _
```

If you accidentally typed in a wrong BIOS file name, the error message, “**WARNING! File not found.**” appears. Press <Enter> to remove the message, then type in the correct file name. Press <Enter>.

- At the above prompt, type **Y** to continue with the update process. Pressing **N** exits the EZ Flash screen and reboots the system without updating the BIOS. The following prompts appear if you typed **Y**.

```
Flash Memory: SST 49LF004

Update Main BIOS area (Y/N)? _
```

- Press **Y** to update the main BIOS area.



---

DO NOT shutdown or reset the system while updating the BIOS area! Doing so may cause system boot failure.

---

- When the update process is done, the message, “**Press a key to reboot**” appears. Press any key to reboot the system with the new BIOS.

## 2.1.2 Using AFLASH to update the BIOS

### Creating a bootable disk

AFLASH.EXE is a Flash Memory Writer utility that updates the BIOS by uploading a new BIOS file to the programmable flash ROM on the motherboard. This file works only in DOS mode. To determine the BIOS version of your motherboard, check the last four numbers of the code displayed on the upper left-hand corner of your screen during bootup. Larger numbers represent a newer BIOS file.

1. Type `FORMAT A:/S` at the DOS prompt to create a bootable system disk. DO NOT copy `AUTOEXEC.BAT` and `CONFIG.SYS` to the disk.
2. Type `COPY D:\AFLASH\AFLASH.EXE A:\` (assuming D is your CD-ROM drive) to copy `AFLASH.EXE` to the boot disk you created.



---

AFLASH works only in DOS mode. It does not work in the DOS prompt within Windows, and does not work with certain memory drivers that may be loaded when you boot from the hard drive. It is recommended that you reboot using a floppy disk.

---

3. Reboot the computer from the floppy disk.



---

BIOS setup must specify “Floppy” as the first item in the boot sequence.

---

4. In DOS mode, type `A:\AFLASH <Enter>` to run AFLASH.

```
ASUS ACPI BIOS
FLASH MEMORY WRITER V2.0
Copyright (C) 1994-2001 ASUSTeK COMPUTER INC.

Flash Memory: Winbond W29C020 or SST 29EE020 or Intel 82802AB

Current BIOS Version: ASUS XXX-XX ACPI BIOS Revision 100X
BIOS Model          : XXX-XX
BIOS Built Date     : 12/25/01

Choose one of the followings:

1. Save Current BIOS To File
2. Update BIOS Including Boot Block and ESCD

Enter choice: [1]

Press ESC To Exit
```



---

If the word “unknown” appears after Flash Memory:, the memory chip is either not programmable or is not supported by the ACPI BIOS and therefore, cannot be programmed by the Flash Memory Writer utility.

---

5. Select 1. Save Current BIOS to File from the Main menu and press <Enter>. The Save Current BIOS To File screen appears.

```
Save Current BIOS To File

Flash Memory: Winbond W29C020 or SST 29EE020 or Intel 82802AB

Current BIOS Version: ASUS XXX-XX ACPI BIOS Revision 100X
BIOS Model           : XXX-XX
BIOS Built Date      : 12/25/01

Please Enter File Name to Save: XXX-XX.XXX

BIOS Saved Successfully
Press ESC To Continue
```

6. Type a filename and the path, for example, A:\XXX-XX.XXX, then press <Enter>.

## Updating the BIOS



Update the BIOS only if you have problems with the motherboard and you are sure that the new BIOS revision will solve your problems. Careless updating may result to more problems with the motherboard!

1. Download an updated ASUS BIOS file from the Internet (WWW or FTP) (see ASUS CONTACT INFORMATION on page viii for details) and save to the boot floppy disk you created earlier.
2. Boot from the floppy disk.
3. At the “A:” prompt, type AFLASH and then press <Enter>.
4. At the Main Menu, type 2 then press <Enter>. The Update BIOS Including Boot Block and ESCD screen appears.
5. Type the filename of your new BIOS and the path, for example, A:\XXX-XX.XXX, then press <Enter>.

To cancel this operation, press <Enter>.

```
Update BIOS Including Boot Block and ESCD

Flash Memory: Winbond W29C020 or SST 29EE020 or Intel 82802AB

Current BIOS Version: ASUS XXX-XX ACPI BIOS Revision 100X
BIOS Model           : XXX-XX
BIOS Built Date      : 12/25/01

Please Enter File Name for NEW BIOS: A:\XXX-XX.XXX
```

6. When prompted to confirm the BIOS update, press **Y** to start the update.

```
Update BIOS Including Boot Block and ESCD
Flash Memory: Winbond W29C020 or SST 29EE020 or Intel 82802AB

BIOS Version
[CURRENT] ASUS XXX-XX ACPI BIOS Revision 100X
[Test.awd] ASUS XXX-XX ACPI BIOS Revision 100X

BIOS Model
[CURRENT] XXX-XX
[Test.awd] XXX-XX

Date of BIOS Built
[CURRENT] 09/25/99
[XXXX.XXX] 05/29/00

Check sum of 1001.010 is F266.

Are you sure (Y/N) ? [Y]

Press ESC To Return to Main Menu
```

7. The utility starts to program the new BIOS information into the Flash ROM. The boot block is updated automatically only when necessary. This minimizes the possibility of boot problems in case of update failures. When the programming is done, the message *"Flashed Successfully"* appears.

```
Update BIOS Including Boot Block and ESCD
Flash Memory: Winbond W29C020 or SST 29EE020 or Intel 82802AB

BIOS Version
[CURRENT] ASUS XXX-XX ACPI BIOS Revision 100X
[Test.awd] ASUS XXX-XX ACPI BIOS Revision 100X

BIOS Model
[CURRENT] XXX-XX
[Test.awd] XXX-XX

Date of BIOS Built
[CURRENT] 12/25/01
[XXXX.XXX] 05/29/00

Check sum of 1001.010 is F266.

Are you sure (Y/N) ? [Y]
Block Erasing -- Done
Programming -- 3FFFF
Flashed Successfully

Press ESC To Continue
```

8. Follow the onscreen instructions to continue.

```
ASUS ACPI BIOS
FLASH MEMORY WRITER V2.0
Copyright (C) 1994-2001 ASUSTeK COMPUTER INC.

Flash Memory: Winbond W29C020 or SST 29EE020 or Intel 82802AB

Current BIOS Version: ASUS XXX-XX ACPI BIOS Revision 100X
BIOS Model : XXX-XX
BIOS Built Date : 12/25/01

Choose one of the followings:
1. Save Current BIOS To File
2. Update BIOS Including Boot Block and ESCD

Enter choice: [1]

You have flashed the EPROM: It is recommended that you turn off
the power, enter SETUP and LOAD Setup Defaults to have CMOS
updated with new BIOS when exits.

Press ESC To Exit
```



If you encounter problems while updating the new BIOS, **DO NOT** turn off the system because this may cause boot problems. Just repeat the process, and if the problem persists, load the original BIOS file you saved to the boot disk. If the Flash Memory Writer utility is not able to successfully update a complete BIOS file, the system may not boot. If this happens, call the ASUS service center for support.

## 2.1.3 CrashFree BIOS feature

The CrashFree BIOS feature allows you to boot the computer from a floppy disk and update the BIOS in case the original BIOS fails or gets corrupted.



- 
1. You must have a bootable floppy disk ready before updating the BIOS.
  2. The bootable floppy disk could be the one that you created following the procedure in section 2.1.2, and should contain the AFLASH.EXE utility.
  3. If the BIOS fails (ROM data or codes are corrupted), a message appears during POST indicating the failure.
- 

To update the BIOS:

1. Turn on the computer, and when prompted, place the bootable floppy disk into the floppy drive, so that the computer boots from the floppy disk.
2. Follow the BIOS update procedure in section “2.1.2 Using AFLASH to update the BIOS.”



---

To use the CrashFree BIOS feature on this motherboard, install a VGA card into one of the expansion slots before rebooting the computer. On motherboards with onboard VGA, such as the P4GE-VM, you will not see the screen display when the BIOS crashes even if you reboot the computer.

---

## 2.2 BIOS Setup program

This motherboard supports a programmable Flash ROM that you can update using the provided utility described in section “2.1 Managing and updating your BIOS.”

Use the BIOS Setup program when you are installing a motherboard, reconfiguring your system, or prompted to “Run Setup”. This section explains how to configure your system using this utility.

Even if you are not prompted to use the Setup program, you may want to change the configuration of your computer in the future. For example, you may want to enable the security password feature or make changes to the power management settings. This requires you to reconfigure your system using the BIOS Setup program so that the computer can recognize these changes and record them in the CMOS RAM of the Flash ROM.

The Flash ROM on the motherboard stores the Setup utility. When you start up the computer, the system provides you with the opportunity to run this program. Press <Delete> during the Power-On Self Test (POST) to enter the Setup utility, otherwise, POST continues with its test routines.

If you wish to enter Setup after POST, restart the system by pressing <Ctrl> + <Alt> + <Delete>, or by pressing the reset button on the system chassis. You can also restart by turning the system off and then back on. Do this last option only if the first two failed.

The Setup program is designed to make it as easy to use as possible. It is a menu-driven program, which means you can scroll through the various sub-menus and make your selections among the predetermined choices.



---

Because the BIOS software is constantly being updated, the following BIOS setup screens and descriptions are for reference purposes only, and may not exactly match what you see on your screen.

---

### 2.2.1 BIOS menu bar

The top of the screen has a menu bar with the following selections:

<b>MAIN</b>	Use this menu to make changes to the basic system configuration.
<b>ADVANCED</b>	Use this menu to enable and make changes to the advanced features.
<b>POWER</b>	Use this menu to configure and enable Power Management features.
<b>BOOT</b>	Use this menu to configure the default system device used to locate and load the Operating System.
<b>EXIT</b>	Use this menu to exit the current menu or to exit the Setup program.

To access the menu bar items, press the right or left arrow key on the keyboard until the desired item is highlighted.



## 2.2.2 Legend bar

At the bottom of the Setup screen is a legend bar. The keys in the legend bar allow you to navigate through the various setup menus. The following table lists the keys found in the legend bar with their corresponding functions.

Navigation Key(s)	Function Description
<F1> or <Alt + H>	Displays the General Help screen from anywhere in the BIOS Setup
<Esc>	Jumps to the Exit menu or returns to the main menu from a sub-menu
Left or Right arrow	Selects the menu item to the left or right
Up or Down arrow	Moves the highlight up or down between fields
- (minus key)	Scrolls backward through the values for the highlighted field
+ (plus key) or spacebar	Scrolls forward through the values for the highlighted field
<Enter>	Brings up a selection menu for the highlighted field
<Home> or <PgUp>	Moves the cursor to the first field
<End> or <PgDn>	Moves the cursor to the last field
<F5>	Resets the current screen to its Setup Defaults
<F10>	Saves changes and exits Setup

### General help

In addition to the Item Specific Help window, the BIOS setup program also provides a General Help screen. You may launch this screen from any menu by simply pressing <F1> or the <Alt> + <H> combination. The General Help screen lists the legend keys and their corresponding functions.

### Saving changes and exiting the Setup program

See "2.7 Exit Menu" for detailed information on saving changes and exiting the setup program.

### Scroll bar

When a scroll bar appears to the right of a help window, it indicates that there is more information to be displayed that will not fit in the window. Use <PgUp> and <PgDn> or the up and down arrow keys to scroll through the entire help document. Press <Home> to display the first page, press <End> to go to the last page. To exit the help window, press <Enter> or <Esc>.

## Sub-menu

Note that a right pointer symbol (as shown on the left) appears to the left of certain fields. This pointer indicates that you can display a sub-menu from this field. A sub-menu contains additional options for a field parameter. To display a sub-menu, move the highlight to the field and press <Enter>. The sub-menu appears. Use the legend keys to enter values and move from field to field within a sub-menu as you would within a menu. Use the <Esc> key to return to the main menu.

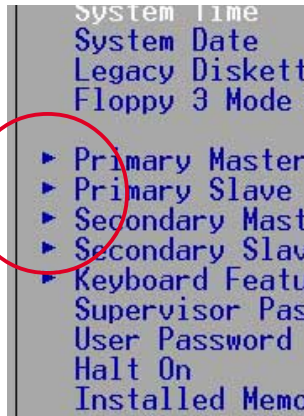

Take some time to familiarize yourself with the legend keys and their corresponding functions. Practice navigating through the various menus and sub-menus. If you accidentally make unwanted changes to any of the fields, use the set default hot key <F5> to load the Setup default values. While moving around through the Setup program, note that explanations appear in the Item Specific Help window located to the right of each menu. This window displays the help text for the currently highlighted field.

## 2.3 Main Menu

When you enter the Setup program, the following screen appears.

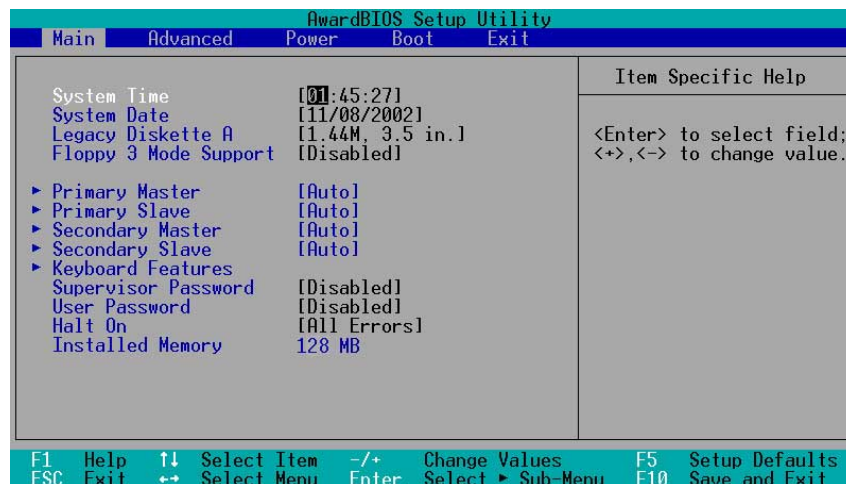

### System Time [XX:XX:XX]

Sets the system to the time that you specify (usually the current time). The format is hour, minute, second. Valid values for hour, minute and second are Hour: (00 to 23), Minute: (00 to 59), Second: (00 to 59). Use the <Tab> or <Shift> + <Tab> keys to move between the hour, minute, and second fields.

### System Date [XX/XX/XXXX]

Sets the system to the date that you specify (usually the current date). The format is month, day, year. Valid values for month, day, and year are Month: (1 to 12), Day: (1 to 31), Year: (up to 2099). Use the <Tab> or <Shift> + <Tab> keys to move between the month, day, and year fields.

### **Legacy Diskette A [1.44M, 3.5 in.]**

Sets the type of floppy drive installed. Configuration options: [None] [360K, 5.25 in.] [1.2M , 5.25 in.] [720K , 3.5 in.] [1.44M, 3.5 in.] [2.88M, 3.5 in.]

### **Floppy 3 Mode Support [Disabled]**

This is required to support older Japanese floppy drives. The Floppy 3 Mode feature allows reading and writing of 1.2MB (as opposed to 1.44MB) on a 3.5-inch diskette. Configuration options: [Disabled] [Enabled]

### **Supervisor Password [Disabled] / User Password [Disabled]**

These fields allow you to set passwords. To set a password, highlight the appropriate field and press <Enter>. Type in a password then press <Enter>. You can type up to eight alphanumeric characters. Symbols and other characters are ignored. To confirm the password, type the password again and press <Enter>. The password is now set to [Enabled]. This password allows full access to the BIOS Setup menus. To clear the password, highlight this field and press <Enter>. The same dialog box as above appears. Press <Enter>. The password is set to [Disabled].

#### **A note about passwords**

The BIOS Setup program allows you to specify passwords in the Main menu. The passwords control access to the BIOS during system startup. Passwords are not case sensitive, meaning, passwords typed in either uppercase or lowercase letters are accepted. The BIOS Setup program allows you to specify two different passwords: a Supervisor password and a User password. If you did not set a Supervisor password, anyone can access the BIOS Setup program. If you did, the Supervisor password is required to enter the BIOS Setup program and to gain full access to the configuration fields.

#### **Forgot the password?**

If you forget your password, you can clear it by erasing the CMOS Real Time Clock (RTC) RAM. The RAM data containing the password information is powered by the onboard button cell battery. If you need to erase the CMOS RAM, unplug the all the power cables and remove the button cell battery. Re-install the battery after about 2 seconds, then power up the system. Refer to section "2.1 Managing and updating your BIOS" on how to update the BIOS.

### **Halt On [All Errors]**

This field specifies the types of errors that will cause the system to halt. Configuration options: [All Errors] [No Error] [All but Keyboard] [All but Disk] [All but Disk/Keyboard]

### **Installed Memory [XXX MB]**

This field automatically displays the amount of conventional memory detected by the system during the boot process.

## 2.3.1 Primary and Secondary Master/Slave

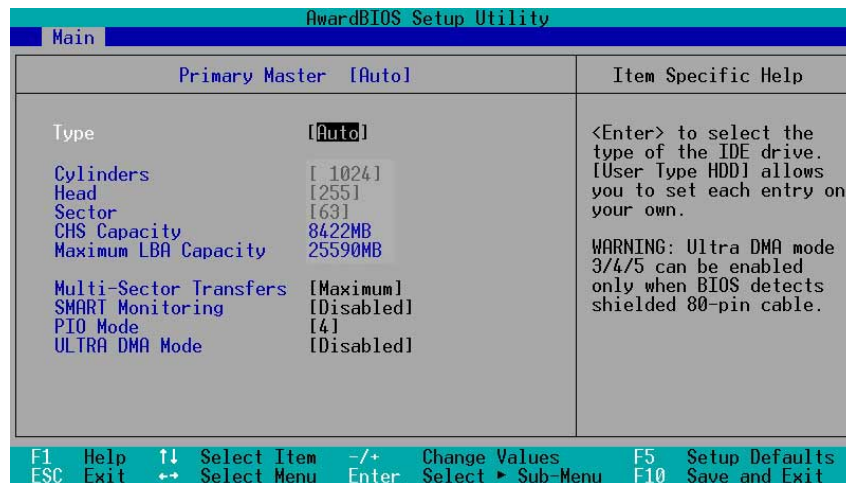

### Type [Auto]

Select [Auto] to automatically detect an IDE hard disk drive. If automatic detection is successful, Setup automatically fills in the correct values for the remaining fields on this sub-menu. If automatic detection fails, this may be because the hard disk drive is too old or too new. If the hard disk was already formatted on an older system, Setup may detect incorrect parameters. In these cases, select [User Type HDD] to manually enter the IDE hard disk drive parameters. Refer to the next section for details.



Before attempting to configure a hard disk drive, make sure you have the correct configuration information supplied by the drive manufacturer. Incorrect settings may cause the system to fail to recognize the installed hard disk.

### [User Type HDD]

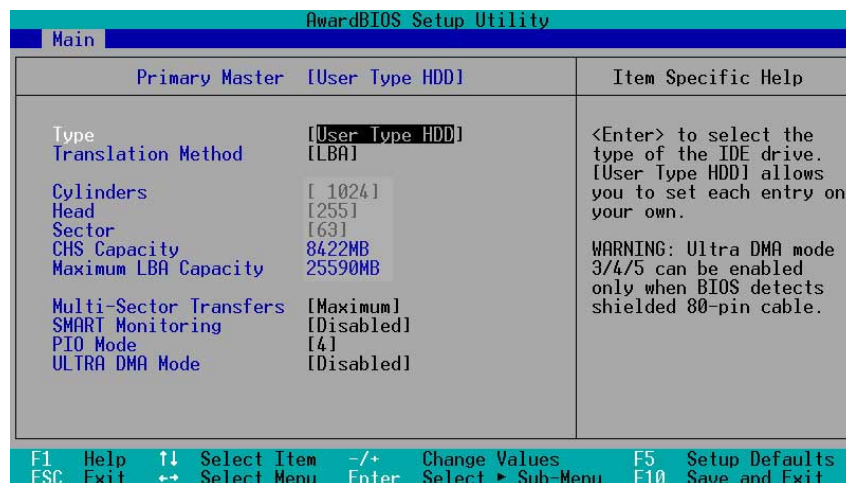

Manually enter the number of cylinders, heads and sectors per track for the drive. Refer to the drive documentation or on the drive label for this information.



---

After entering the IDE hard disk drive information into BIOS, use a disk utility, such as FDISK, to partition and format new IDE hard disk drives. This is necessary so that you can write or read data from the hard disk. Make sure to set the partition of the Primary IDE hard disk drives to active.

---

If no drive is installed or if you are removing a drive and not replacing it, select [None].

Other options for the Type field are:

**[CD-ROM]** - for IDE CD-ROM drives

**[LS-120]** - for LS-120 compatible floppy disk drives

**[ZIP]** - for ZIP-compatible disk drives

**[MO]** - for IDE magneto optical disk drives

**[Other ATAPI Device]** - for IDE devices not listed here

After making your selections on this sub-menu, press the <Esc> key to return to the Main menu. When the Main menu appears, the hard disk drive field displays the size for the hard disk drive that you configured.

### **Translation Method [LBA]**

Select the hard disk drive type in this field. When Logical Block Addressing (LBA) is enabled, the 28-bit addressing of the hard drive is used without regard for cylinders, heads, or sectors. Note that LBA Mode is necessary for drives with more than 504MB storage capacity. Configuration options: [LBA] [LARGE] [Normal] [Match Partition Table] [Manual]

### **Cylinders**

This field configures the number of cylinders. Refer to the drive documentation to determine the correct value. To make changes to this field, set the Type field to [User Type HDD] and the Translation Method field to [Manual].

### **Head**

This field configures the number of read/write heads. Refer to the drive documentation to determine the correct value. To make changes to this field, set the Type field to [User Type HDD] and the Translation Method field to [Manual].

### **Sector**

This field configures the number of sectors per track. Refer to the drive documentation to determine the correct value. To make changes to this field, set the Type field to [User Type HDD] and the Translation Method field to [Manual].

### **CHS Capacity**

This field shows the drive's maximum CHS capacity as calculated by the BIOS based on the drive information you entered.

## Maximum LBA Capacity

This field shows the drive's maximum LBA capacity as calculated by the BIOS based on the drive information you entered.

## Multi-Sector Transfers [Maximum]

This option automatically sets the number of sectors per block to the highest number that the drive supports. Note that when this field is automatically configured, the set value may not always be the fastest value for the drive. You may also manually configure this field. Refer to the documentation that came with the hard drive to determine the optimum value and set it manually. To make changes to this field, set the Type field to [User Type HDD]. Configuration options: [Disabled] [2 Sectors] [4 Sectors] [8 Sectors] [16 Sectors] [32 Sectors] [Maximum]

## SMART Monitoring [Disabled]

This field allows you to enable or disable the S.M.A.R.T. (Self-Monitoring, Analysis and Reporting Technology) system that utilizes internal hard disk drive monitoring technology. This parameter is normally disabled because the resources used in the SMART monitoring feature may decrease system performance. Configuration options: [Disabled] [Enabled]

## PIO Mode [4]

This option lets you set a PIO (Programmed Input/Output) mode for the IDE device. Modes 0 through 4 provide successive increase in performance. Configuration options: [0] [1] [2] [3] [4]

## Ultra DMA Mode [Disabled]

Ultra DMA capability allows improved transfer speeds and data integrity for compatible IDE devices. Set to [Disabled] to suppress Ultra DMA capability. To make changes to this field, set the Type field to [User Type HDD]. Configuration options: [0] [1] [2] [3] [4] [5] [Disabled]

## 2.3.2 Keyboard Features

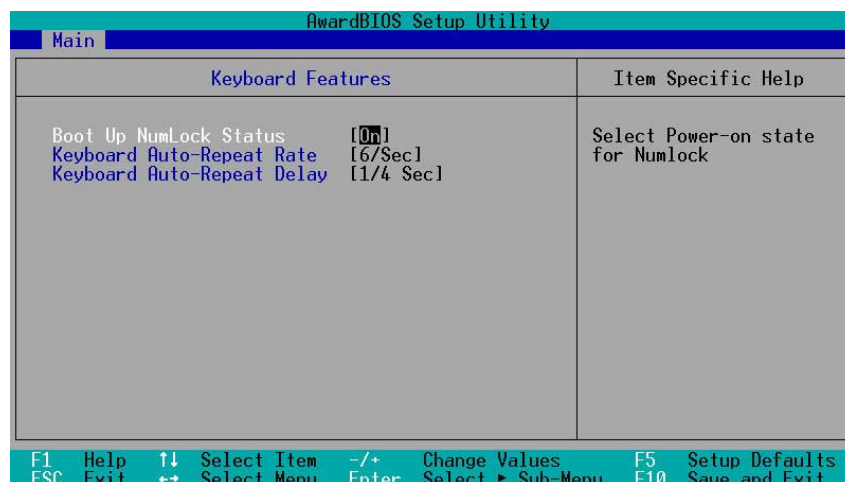

## Boot Up NumLock Status [On]

This field enables users to activate the Number Lock function upon system boot.  
Configuration options: [Off] [On]

## Keyboard Auto-Repeat Rate [6/Sec]

This controls the speed at which the system registers repeated keystrokes.  
Options range from 6 to 30 characters per second. Configuration options: [6/Sec] [8/Sec] [10/Sec] [12/Sec] [15/Sec] [20/Sec] [24/Sec] [30/Sec]

## Keyboard Auto-Repeat Delay [1/4 Sec]

This field sets the time interval for displaying the first and second characters.  
Configuration options: [1/4 Sec] [1/2 Sec] [3/4 Sec] [1 Sec]

## 2.4 Advanced Menu

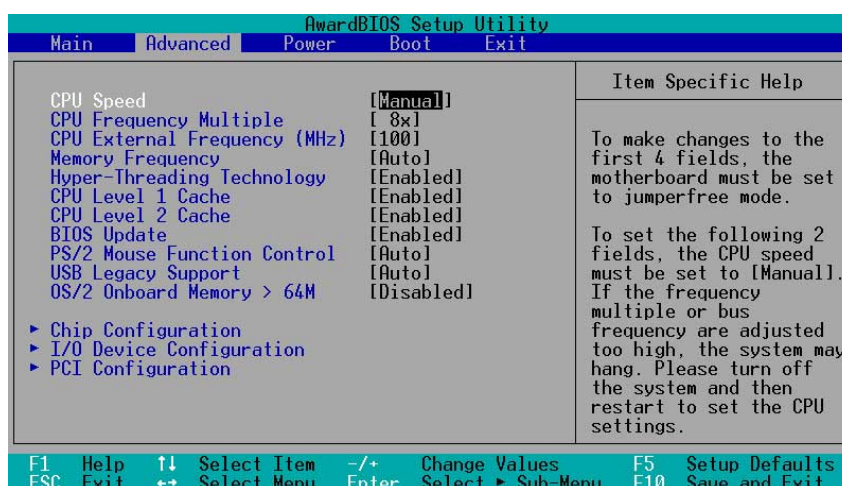

### CPU Speed [Manual]

When the motherboard is set to JumperFree™ mode, this field allows you to select the internal frequency of the CPU. Select [Manual] if you want to make changes to the two subsequent fields. Note that selecting a frequency higher than the CPU manufacturer recommends may cause the system to hang or crash.

### CPU Frequency Multiple (when CPU Speed is set to [Manual])

This field sets the frequency multiple between the CPU's internal frequency (CPU speed) and external frequency. Set this field in conjunction with CPU Frequency (MHz) to match the speed of the CPU.



The item **CPU Frequency Multiple** is accessible only if you have an unlocked processor. If your processor frequency multiple is locked, you cannot change the setting of this item.

### CPU External Frequency (MHz) (when CPU Speed is set to [Manual])

This feature tells the clock generator what frequency to send to the system bus and PCI bus. The bus frequency (external frequency) multiplied by the bus multiple equals the CPU speed.

## Memory Frequency [Auto]

This field determines whether the memory clock frequency is set to be in synchronous or asynchronous mode with respect to the system frequency. The options that appear in the popup menu vary according to the CPU Frequency (MHz). Configuration options: [Auto] [266MHz] [355MHz] [333MHz]

## Hyper-Threading Technology [Enabled]

This item allows you to enable or disable the processor Hyper-Threading Technology. Configuration options: [Disabled] [Enabled]



---

The item **Hyper-Threading Technology** appears only if you installed an Intel Pentium 4 CPU that supports this feature.

---

## CPU Level 1 Cache, CPU Level 2 Cache [Enabled]

These fields allow you to choose from the default [Enabled] or choose [Disabled] to turn on or off the CPU Level 1 and Level 2 built-in cache. Configuration options: [Disabled] [Enabled]

## BIOS Update [Enabled]

This field functions as an update loader integrated into the BIOS to supply the processor with the required data. When set to [Enabled], the BIOS loads the update on all processors during system bootup. Configuration options: [Disabled] [Enabled]

## PS/2 Mouse Function Control [Auto]

The default setting [Auto] allows the system to detect a PS/2 mouse at startup. If a mouse is detected, the BIOS assigns IRQ12 to the PS/2 mouse. Otherwise, IRQ12 can be used for expansion cards. When you set this field to [Enabled], BIOS reserves IRQ12, whether or not a PS/2 mouse is detected at startup. Configuration options: [Enabled] [Auto]

## USB Legacy Support [Auto]

This motherboard supports Universal Serial Bus (USB) devices. The default of [Auto] allows the system to detect a USB device at startup. If detected, the USB controller legacy mode is enabled. If not detected, the USB controller legacy mode is disabled.

When you set this field to [Disabled], the USB controller legacy mode is disabled whether or not you are using a USB device. Configuration options: [Disabled] [Enabled] [Auto]

## OS/2 Onboard Memory > 64M [Disabled]

When using OS/2 operating systems with installed DRAM of greater than 64MB, you need to set this option to [Enabled]. Otherwise, leave to the default setting [Disabled]. Configuration options: [Disabled] [Enabled]



## 2.4.1 Chip Configuration

AwardBIOS Setup Utility		
Advanced		
Chip Configuration		Item Specific Help
SDRAM Configuration	[By SPD]	<Enter> to select SDRAM configuration. [By SPD] is recommended. [User Defined] allows you to set each configuration on your own.
SDRAM CAS Latency	[1.5T]	
SDRAM RAS to CAS Delay	[3T]	
SDRAM RAS Precharge Delay	[3T]	
SDRAM Active Precharge Delay	[5T]	
SDRAM Idle Timer	[Auto]	
Onboard VGA	[Auto]	
Onboard VGA Share Memory Size	[8MB]	
NTSC/PAL Preference	[NTSC]	
Graphics Aperture Size	[128MB]	
AGP Capability	[4X Mode]	
Video Memory Cache Mode	[UC]	
Memory Hole At 15M-16M	[Disabled]	
Delay Transaction	[Enabled]	
Onboard PCI IDE	[Both]	
USB 2.0 HS Reference Voltage	[Medium]	

F1 Help ↑↓ Select Item -/+ Change Values F5 Setup Defaults  
ESC Exit ↔ Select Menu Enter Select ▶ Sub-Menu F10 Save and Exit

### SDRAM Configuration [By SPD]

This parameter allows you to set the optimal timings for items 2–5, depending on the memory modules that you are using. The default setting is [By SPD], which configures items 2–5 by reading the contents in the SPD (Serial Presence Detect) device. The EEPROM on the memory module stores critical information about the module, such as memory type, size, speed, voltage interface, and module banks. Configuration options: [User Defined] [By SPD]



The SDRAM parameters (items 2~5) become configurable only when you set the SDRAM Configuration to [User Defined].

### SDRAM CAS Latency (value depends on SDRAM SPD)

This item controls the latency between the SDRAM read command and the time the data actually becomes available. Configuration options: [2.5T] [2T] [1.5T]

### SDRAM RAS to CAS Delay (value depends on SDRAM SPD)

This item controls the latency between the DDR SDRAM active command and the read/write command. Configuration options: [3T] [2T]

### SDRAM RAS Precharge Delay (value depends on SDRAM SPD)

This item controls the idle clocks after issuing a precharge command to the DDR SDRAM. Configuration options: [3T] [2T]

### SDRAM Active Precharge Delay (value depends on SDRAM SPD)

This item controls the number of DDR SDRAM clocks used for DDR SDRAM parameters. Configuration options: [8T] [7T] [6T] [5T]

### SDRAM Idle Timer [Auto]

Configuration options: [Infinite] [0T] [8T] [16T] [64T] [Auto]

### **Onboard VGA [Auto]**

When set to Auto, this item allows BIOS to automatically detect the onboard VGA, and the AGP device if installed. Under this setting, the AGP device has higher priority over the onboard VGA. If an AGP device is present, the onboard VGA is disabled. If no AGP device is detected, the onboard VGA is automatically enabled. When set to Enabled, the onboard VGA is enabled. Any AGP device, even if present, is ignored. Configuration options: [Auto] [Enabled]

### **Onboard VGA Shared Memory [8 MB]**

This item allows you to select the size of memory shared to the onboard VGA. Configuration options: [1 MB] [8 MB]

### **NTSC/PAL Preference [NTSC]**

This item allows you to select the TV output standard. Configuration options: [NTSC] [PAL]

### **Graphics Aperture Size [64MB]**

This feature allows you to select the size of mapped memory for AGP graphic data. Configuration options: [4MB] [8MB] [16MB] [32MB] [64MB] [128MB] [256MB]

### **AGP Capability [4X Mode]**

This motherboard supports the AGP 4X interface that transfers video data at 1066MB/s. AGP 4X is backward-compatible, so you may keep the default [4X Mode] even if you are using an AGP 1X video card. When set to [1X Mode], the AGP interface only provides a peak data throughput of 266MB/s even if you are using an AGP 4X card.

Configuration options: [1X Mode] [4X Mode]

### **Video Memory Cache Mode [UC]**

USWC (uncacheable, speculative write combining) is a new cache technology for the video memory of the processor. It can greatly improve the display speed by caching the display data. You must set this to UC (uncacheable) if your display card does not support this feature, otherwise the system may not boot.

Configuration options: [UC] [USWC]

### **Memory Hole At 15M-16M [Disabled]**

This field allows you to reserve an address space for ISA expansion cards. Setting the address space to a particular setting makes that memory space unavailable to other system components. Expansion cards can only access memory up to 16MB.

Configuration options: [Disabled] [Enabled]

### **Delay Transaction [Enabled]**

When set to [Enabled], this feature frees the PCI bus when the CPU is accessing 8-bit ISA cards. This process normally consumes about 50-60 PCI clocks without PCI delayed transaction. Set this field to [Disabled] when using ISA cards that are not PCI 2.1 compliant. Configuration options: [Disabled] [Enabled]

## Onboard PCI IDE [Both]

This field allows you to enable either the primary IDE channel or secondary IDE channel, or both. You can also set both channels to [Disabled]. Configuration options: [Both] [Primary] [Secondary] [Disabled]

## USB 2.0 HS Reference Voltage [Medium]

This item controls the USB 2.0 high-speed drive strength reference voltage. Configuration options: [Low] [Medium] [High] [Maximum]

## 2.4.2 I/O Device Configuration

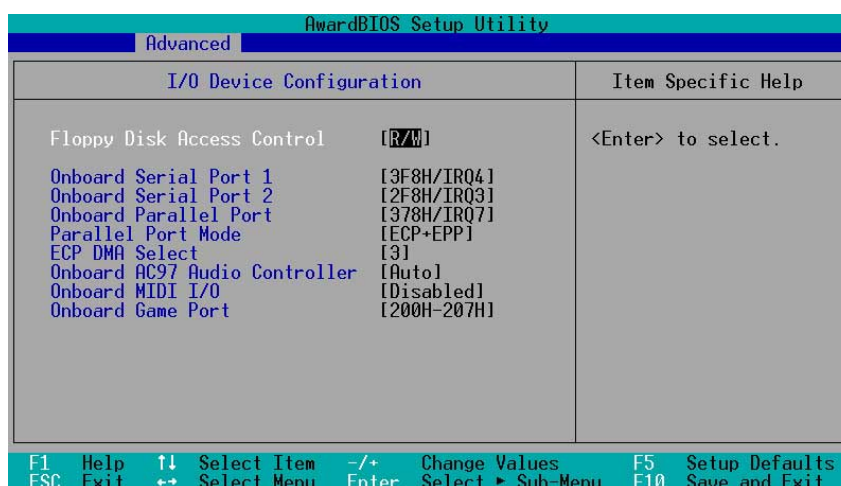

### Floppy Disk Access Control [R/W]

When set to [Read Only], this parameter protects files from being copied to floppy disks by allowing reads from, but not writes to, the floppy disk drive. The default setting [R/W] allows both reads and writes. Configuration options: [R/W] [Read Only]

### Onboard Serial Port 1 [3F8H/IRQ4]

### Onboard Serial Port 2 [2F8H/IRQ3]

These fields allow you to set the addresses for the onboard serial connectors. Serial Port 1 and Serial Port 2 must have different addresses. Configuration options: [3F8H/IRQ4] [2F8H/IRQ3] [3E8H/IRQ4] [2E8H/IRQ10] [Disabled]

### Onboard Parallel Port [378H/IRQ7]

This field allows you to set the address of the onboard parallel port connector. If you disable this field, the Parallel Port Mode and ECP DMA Select configurations are not available. Configuration options: [Disabled] [378H/IRQ7] [278H/IRQ5]

### Parallel Port Mode [ECP+EPP]

This field allows you to set the operation mode of the parallel port. [Normal] allows normal-speed operation but in one direction only; [EPP] allows bidirectional parallel port operation; [ECP] allows the parallel port to operate in bidirectional DMA mode; [ECP+EPP] allows normal speed operation in a two-way mode. Configuration options: [Normal] [EPP] [ECP] [ECP+EPP]

### ECP DMA Select [3]

This field allows you to configure the parallel port DMA channel for the selected ECP mode. This selection is available only if you select [ECP] or [ECP+EPP] in Parallel Port Mode above. Configuration options: [1] [3]

### Onboard AC97 Audio Controller [Auto]

[Auto] allows the BIOS to detect whether you are using any audio device. If an audio device is detected, the onboard audio controller is enabled; if no audio device is detected, the controller is disabled. Configuration options: [Disabled] [Auto]

### Onboard MIDI I/O [Disabled]

This field sets the I/O address for the MIDI I/O port. Configuration options: [Disabled] [330H-331H] [300H-301H]

### Onboard Game Port [200H-207H]

This field sets the I/O address for the game port. Configuration options: [Disabled] [200H-207H] [208H-20FH]

## 2.4.3 PCI Configuration

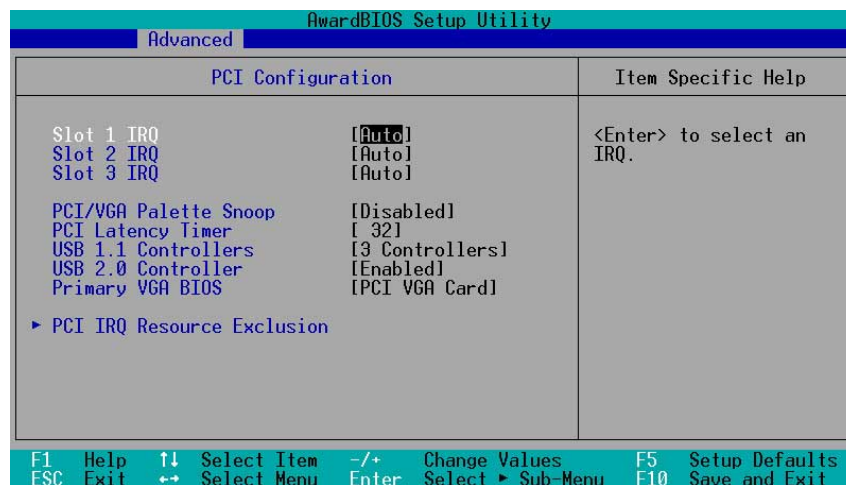

### Slot 1, Slot 2, Slot 3 IRQ [Auto]

These fields automatically assign the IRQ for each PCI slot. The default setting for each field is [Auto], which utilizes auto-routing to determine IRQ assignments. Configuration options: [Auto] [NA] [3] [4] [5] [7] [9] [10] [11] [12] [14] [15]

### PCI/VGA Palette Snoop [Disabled]

Some non-standard VGA cards, like graphics accelerators or MPEG video cards, may not show colors properly. Setting this field to [Enabled] corrects this problem. If you are using standard VGA cards, leave this field to the default setting [Disabled]. Configuration options: [Disabled] [Enabled]

## PCI Latency Timer [32]

Leave this field to the default setting [32] for best performance and stability.

## USB 1.1 Controllers [3 Controllers]

This field allows you to select the number of USB 1.1 controllers that you wish to activate. Configuration options: [Disabled] [3 Controllers]

## USB 2.0 Controller [Enabled]

This field allows you to enable or disable the onboard USB 2.0 controller. Set to [Enabled] if you wish to install USB 2.0 devices. Configuration options: [Disabled] [Enabled]

## Primary VGA BIOS [PCI VGA Card]

This field allows you to select the primary graphics card. Configuration options: [PCI VGA Card] [AGP VGA Card] [Onboard VGA]



The option [Onboard VGA] appears only when the onboard VGA is either used or enabled.

### 2.4.3.1 PCI IRQ Resource Exclusion

AwardBIOS Setup Utility		
Advanced		
PCI IRQ Resource Exclusion	Item Specific Help	
IRQ 3 Reserved [No/ICU]	Select [Yes] if this IRQ is required by a legacy ISA card and you are not using ICU; otherwise, select [No/ICU].	
IRQ 4 Reserved [No/ICU]		
IRQ 5 Reserved [No/ICU]		
IRQ 7 Reserved [No/ICU]		
IRQ 9 Reserved [No/ICU]		
IRQ 10 Reserved [No/ICU]		
IRQ 11 Reserved [No/ICU]		
IRQ 12 Reserved [No/ICU]		
IRQ 14 Reserved [No/ICU]		
IRQ 15 Reserved [No/ICU]		
F1 Help ↑↓ Select Item -/+ Change Values F5 Setup Defaults		
ESC Exit ↔ Select Menu Enter Select ▶ Sub-Menu F10 Save and Exit		

## IRQ XX Reserved [No/ICU]

These fields indicate whether or not the displayed IRQ for each field is being used by a legacy (non-PnP) ISA card. The setting [No/ICU] for an IRQ field indicates that you are using the ISA Configuration Utility (ICU), and that this particular IRQ is NOT required by a legacy ISA card. Set the IRQ field to [Yes] if you install a legacy ISA card that requires a unique IRQ and you are NOT using ICU. Configuration options: [No/ICU] [Yes]

## 2.5 Power Menu

The Power menu allows you to reduce power consumption. This feature turns off the video display and shuts down the hard disk after a period of inactivity.

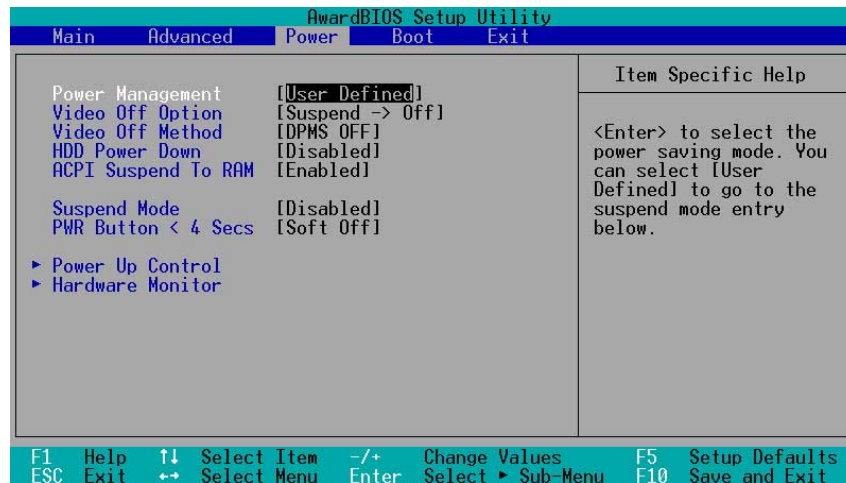

### Power Management [User Defined]

This field allows you to activate or deactivate the automatic power saving features. When set to [Disabled], the power management features do not function regardless of the other settings on this menu. The [User Defined] option allows you to set the period of inactivity before the system enters suspend mode. Refer to "Suspend Mode" item.

When set to [Max Saving], system power is conserved to its greatest amount. This setting automatically puts the system into suspend mode after a brief period of system inactivity. [Min Saving] allows the least power saving as the system enters suspend mode only after a long period of inactivity. Configuration options: [User Defined] [Disabled] [Min Saving] [Max Saving]



You should install the Advanced Power Management (APM) utility to keep the system time updated even when the computer enters suspend mode. In Windows 3.x and Windows 95, you need to install Windows with the APM feature. In Windows 98 or later, APM is automatically installed as indicated by a battery and power cord icon labeled "Power Management" in the Control Panel. Select the item "Advanced" in the Power Management Properties dialog box.

### Video Off Option [Suspend -> Off]

This field determines when to activate the video off feature for monitor power management. Configuration options: [Always On] [Suspend -> Off]

## Video Off Method [DPMS OFF]

This field defines the video off features. The Display Power Management System (DPMS) feature allows the BIOS to control the video display card if it supports the DPMS feature. [Blank Screen] only blanks the screen. Use this for monitors without power management or “green” features.



---

Even if installed, your screen saver does not display when you select [Blank Screen] for the above field.

---

[V/H SYNC+Blank] blanks the screen and turns off vertical and horizontal scanning. Configuration options: [Blank Screen] [V/H SYNC+Blank] [DPMS Standby] [DPMS Suspend] [DPMS OFF] [DPMS Reduce ON]

## HDD Power Down [Disabled]

Shuts down any IDE hard disk drives in the system after a period of inactivity as set in this user-configurable field. This feature does not affect SCSI hard drives. Configuration options: [Disabled] [1 Min] [2 Min] [3 Min]...[15 Min]

## ACPI Suspend To RAM [Disabled]

This field allows you to enable or disable the ACPI Suspend-to-RAM feature. To support this feature, the +5VSB of the power supply should have the capacity to provide more than 720mA current. Configuration options: [Disabled] [Enabled]

## Suspend Mode [Disabled]

Sets the time period before the system goes into suspend mode. Configuration options: [Disabled] [1~2 Min] [2~3 Min] [4~5 min] [8~9 Min] [20 Min] [30 Min] [40 Min] [1 hour]

## PWR Button < 4 Secs [Soft Off]

When set to [Soft off], the ATX switch can be used as a normal system power-off button when pressed for less than 4 seconds. [Suspend] allows the button to have a dual function where pressing less than 4 seconds puts the system in sleep mode. Regardless of the setting, holding the ATX switch for more than 4 seconds powers off the system. Configuration options: [Soft off] [Suspend]

## 2.5.1 Power Up Control

AwardBIOS Setup Utility		
Power		
Power Up Control		Item Specific Help
AC Power Loss Restart	[Disabled]	<Enter> to select whether or not to restart the system after AC power loss.
Wake/Power Up On Ext. Modem	[Disabled]	
Power Up On PCI Device	[Disabled]	
Power Up By PS/2 Keyboard	[Space Bar]	
Power On By PS/2 Mouse	[Disabled]	
Automatic Power Up	[Disabled]	

F1 Help ↑↓ Select Item -/+ Change Values F5 Setup Defaults  
ESC Exit ↔ Select Menu Enter Select ► Sub-Menu F10 Save and Exit

### AC PWR Loss Restart [Disabled]

This allows you to set whether or not to reboot the system after power interruptions. [Disabled] leaves your system off while [Enabled] reboots the system. [Previous State] sets the system back to the state it was before the power interruption. Configuration options: [Disabled] [Enabled] [Previous State]

### Wake/Power Up On Ext. Modem [Disabled]

This allows either settings of [Enabled] or [Disabled] for powering up the computer when the external modem receives a call while the computer is in Soft-off mode. Configuration options: [Disabled] [Enabled]



The computer cannot receive or transmit data until the computer and applications are fully running. Thus, connection cannot be made on the first try. Turning an external modem off and then back on while the computer is off causes an initialization string that turns the system power on.

### Power Up On PCI Device [Disabled]

When set to [Enabled], this parameter allows you to turn on the system through a PCI LAN or modem card. This feature requires an ATX power supply that provides at least 1A on the +5VSB lead. Configuration options: [Disabled] [Enabled]

### Power On By PS/2 Keyboard [Space Bar]

This parameter allows you to use specific keys on the keyboard to turn on the system. This feature requires an ATX power supply that provides at least 1A on the +5VSB lead. Configuration options: [Disabled] [Space Bar] [Ctrl-Esc] [Power Key]

### Power On By PS/2 Mouse [Disabled]

When set to [Enabled], this parameter allows you to use the PS/2 mouse to turn on the system. This feature requires an ATX power supply that provides at least 1A on the +5VSB lead. Configuration options: [Disabled] [Enabled]



## Automatic Power Up [Disabled]

This allows an unattended or automatic system power up. You may configure your system to power up at a certain time of the day by selecting [Everyday] or at a certain time and day by selecting [By Date]. Configuration options: [Disabled] [Everyday] [By Date]

## 2.5.2 Hardware Monitor

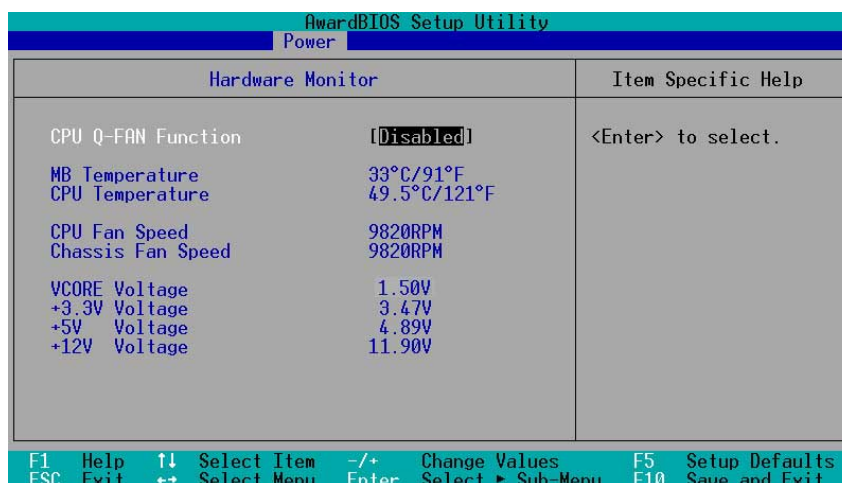

AwardBIOS Setup Utility		
Power		
Hardware Monitor	Item Specific Help	
CPU Q-FAN Function	[Disabled]	<Enter> to select.
MB Temperature	33°C/91°F	
CPU Temperature	49.5°C/121°F	
CPU Fan Speed	9820RPM	
Chassis Fan Speed	9820RPM	
VCORE Voltage	1.50V	
+3.3V Voltage	3.47V	
+5V Voltage	4.89V	
+12V Voltage	11.90V	

F1 Help ↑↓ Select Item -/+ Change Values F5 Setup Defaults  
ESC Exit ↔ Select Menu Enter Select ▶ Sub-Menu F10 Save and Exit

## CPU Q-Fan Function [Disabled]

This item allows you to enable or disable the ASUS Q-Fan feature that smartly adjusts the fan speeds for more efficient system operation. When this field is set to [Enabled], the **CPU Temperature Threshold** and **CPU Fan Lowest Level Voltage** items appear. Configuration options: [Disabled] [Enabled]

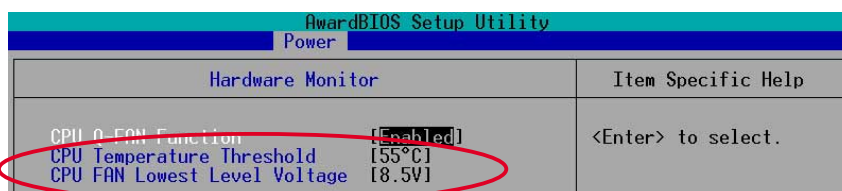

AwardBIOS Setup Utility		
Power		
Hardware Monitor	Item Specific Help	
CPU Q-FAN Function	[Enabled]	<Enter> to select.
CPU Temperature Threshold	[55°C]	
CPU FAN Lowest Level Voltage	[8.5V]	

## CPU Temperature Threshold

This item allows you to set the highest temperature for the CPU so that when exceeded by the actual CPU temperature, Q-Fan supplies more power to the CPU fan. When the CPU temperature goes below the setting, Q-Fan automatically reverts to the normal power supplied to the fan. Configuration options: [50°C] [55°C] [60°C] [65°C] [70°C]

## CPU Fan Lowest Level Voltage

This item allows you to set the lowest voltage applied to the CPU fan. Configuration options: [6V] [6.5V] [7V] [7.5] [8V] [8.5] [9V]

## MB Temperature [xxxC/xxxF]

## CPU Temperature [xxxC/xxxF]

The onboard hardware monitor automatically detects and displays the motherboard and CPU temperatures.

## CPU Fan Speed [xxxxRPM] or [N/A]

## Chassis Fan Speed [xxxxRPM] or [N/A]

The onboard hardware monitor automatically detects and displays the CPU, chassis, and power fan speeds in rotations per minute (RPM). If any of the fans is not connected to the motherboard, the specific field shows N/A.

## VCORE Voltage, +3.3V Voltage, +5V Voltage, +12V Voltage

The onboard hardware monitor automatically detects the voltage output through the onboard voltage regulators.



If any of the monitored items is out of range, the following error message appears: "Hardware Monitor found an error. Enter Power setup menu for details". You will then be prompted to "Press F1 to continue or DEL to enter SETUP".

## 2.6 Boot Menu

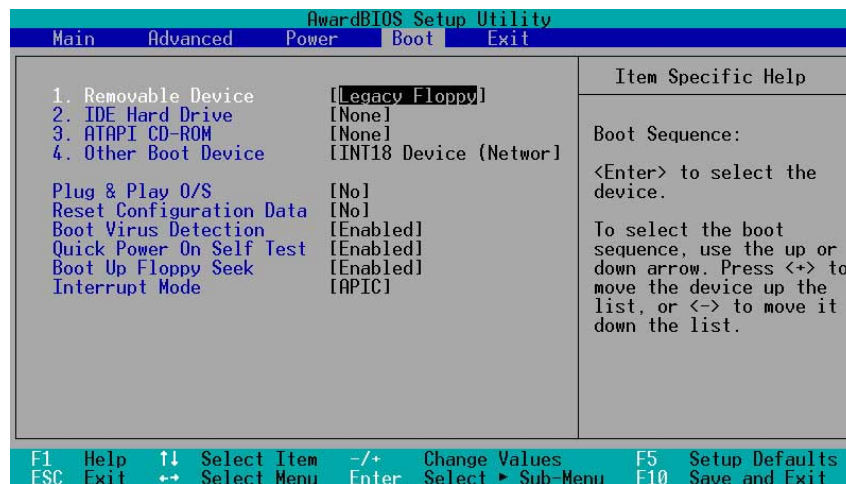

### Boot Sequence

The Boot menu allows you to select among the four possible types of boot devices listed using the up and down arrow keys. By using the <+> or <Space> key, you can promote devices and by using the <-> key, you can demote devices. Promotion or demotion of devices alters the priority which the system uses to search for a boot device on system power up. Configuration fields include Removable Devices, IDE Hard Drive, ATAPI CD-ROM, and Other Boot Device.

### Removable Device [Legacy Floppy]

Configuration options: [Disabled] [Legacy Floppy] [LS-120] [ZIP] [ATAPI MO]

## **IDE Hard Drive**

This field allows you to select which IDE hard disk drive to use in the boot sequence. Pressing [Enter] will show the product IDs of all connected IDE hard disk drives.

## **ATAPI CD-ROM**

This field allows you to select which ATAPI CD-ROM drive to use in the boot sequence. Pressing [Enter] will show the product IDs of all your connected ATAPI CD-ROM drives.

## **Other Boot Device Select [INT18 Device (Network)]**

Configuration options: [Disabled] [SCSI Boot Device] [INT18 Device (Network)]

## **Plug & Play O/S [No]**

This field allows you to use a Plug-and-Play (PnP) operating system to configure the PCI bus slots instead of using the BIOS. When [Yes] is selected, interrupts may be reassigned by the OS. If you installed a non-PnP OS or if you want to prevent reassigning of interrupt settings, keep the default setting [No]. Configuration options: [No] [Yes]

## **Reset Configuration Data [No]**

The Extended System Configuration Data (ESCD) contain information about non-PnP devices. It also holds the complete record of how the system was configured the last time it was booted. Select [Yes] if you want to clear these data during the Power-On-Self-Test (POST).

Configuration options: [No] [Yes]

## **Boot Virus Detection [Enabled]**

This field allows you to set boot virus detection, ensuring a virus-free boot sector. The system halts and displays a warning message when it detects a virus. If this occurs, you can either allow the operation to continue or use a virus-free bootable floppy disk to restart and investigate your system. Configuration options: [Disabled] [Enabled]

## **Quick Power On Self Test [Enabled]**

This field speeds up the Power-On-Self Test (POST) routine by skipping retesting a second, third, and fourth time. Configuration options: [Disabled] [Enabled]

## **Boot Up Floppy Seek [Enabled]**

When enabled, the BIOS will seek the floppy disk drive to determine whether the drive has 40 or 80 tracks. Configuration options: [Disabled] [Enabled]

## **Interrupt Mode [APIC]**

The Advanced Programmable Interrupt Controller (APIC) setting allows you to distribute interrupt routings other than the 16 IRQs. The Programmable Interrupt Controller (PIC) setting allows you to use the 16 IRQs only. Configuration options: [PIC] [APIC]

## 2.7 Exit Menu

When you have made all of your selections from the various menus in the Setup program, save your changes and exit Setup. Select Exit from the menu bar to display the following menu.

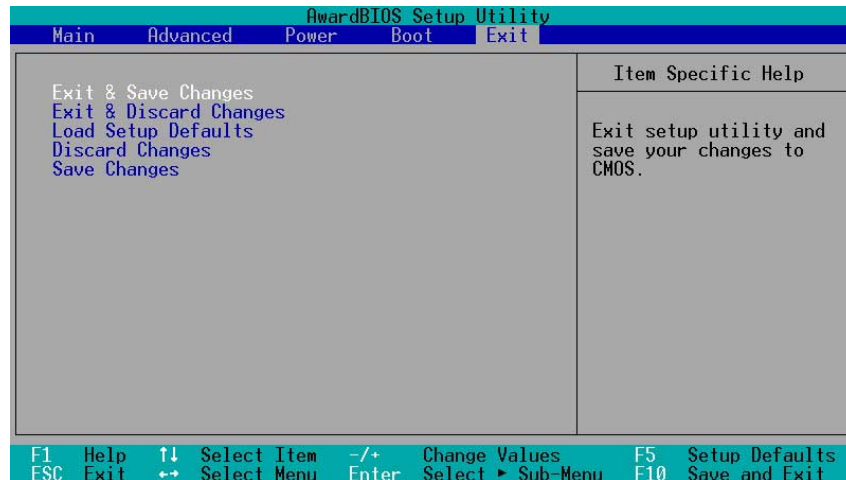

Pressing <Esc> does not immediately exit this menu. Select one of the options from this menu or <F10> from the legend bar to exit.

### Exit & Save Changes

Once you are finished making your selections, choose this option from the Exit menu to ensure the values you selected are saved to the CMOS RAM. The CMOS RAM is sustained by an onboard backup battery and stays on even when the PC is turned off. When you select this option, a confirmation window appears. Select [Yes] to save changes and exit.



If you attempt to exit the Setup program without saving your changes, the program prompts you with a message asking if you want to save your changes before exiting. Pressing <Enter> saves the changes while exiting.

### Exit & Discard Changes

Select this option only if you do not want to save the changes that you made to the Setup program. If you made changes to fields other than system date, system time, and password, the BIOS asks for a confirmation before exiting.

### Load Setup Defaults

This option allows you to load the default values for each of the parameters on the Setup menus. When you select this option or if you press <F5>, a confirmation window appears. Select [Yes] to load default values. Select Exit Saving Changes or make other changes before saving the values to the non-volatile RAM.

### Discard Changes

This option allows you to discard the selections you made and restore the previously saved values. After selecting this option, a confirmation appears. Select [Yes] to discard any changes and load the previously saved values.

### Save Changes

This option saves your selections without exiting the Setup program. You can then return to other menus and make further changes. After you select this option, a confirmation window appears. Select [Yes] to save changes to the non-volatile RAM.

# ***Chapter 3***

This chapter describes the contents of the support CD that comes with the motherboard package.

## **Software support**

## 3.1 Install an operating system

This motherboard supports Windows 98SE/ME/NT/2000/XP operating system (OS). Always install the latest OS version and corresponding updates so you can maximize the features of your hardware.



Because motherboard settings and hardware options vary, use the setup procedures presented in this chapter for general reference only. Refer to your OS documentation for more information.

## 3.2 Support CD information

The support CD that came with the motherboard contains useful software and several utility drivers that enhance the motherboard features.



The contents of the support CD are subject to change at any time without notice. Visit the ASUS website for updates.

### 3.2.1 Running the support CD

To begin using the support CD, simply insert the CD into your CD-ROM drive. The CD automatically displays the **Drivers** menu if Autorun is enabled in your computer.

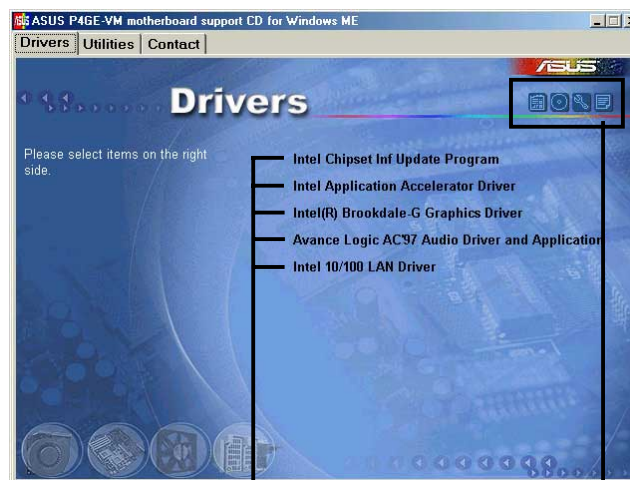

Click an item to install

Click an icon to display more information



If **Autorun** is NOT enabled in your computer, browse the contents of the support CD to locate the file **ASSETUP.EXE** from the **BIN** folder. Double-click the **ASSETUP.EXE** to run the CD.

## 3.2.2 Drivers menu

The drivers menu shows the available device drivers if the system detects installed devices. Install the necessary drivers to activate the devices.

### Intel Chipset Inf Update program

This item installs the Intel® Chipset INF Update Program that enables Plug-n-Play INF support for Intel chipset components. This utility installs to the target system the Windows INF files that outline to the operating system how the chipset components will be configured. Refer to the online help or readme file that came with the utility.

### Intel Application Accelerator Driver

This item installs the Intel Application Accelerator for Microsoft® Windows® 98SE/ME/NT4.0/2000. This program is designed to improve performance of the storage sub-system and overall system performance.



---

Install the INF Driver before installing the Intel Application Accelerator.

---

### Intel Brookdale-G Graphics Driver

This item installs the Intel the Brookdale-G graphics driver to allow enhanced video capability.

### Avance Logic AC'97 Audio Driver and Applications

This item installs the Avance Logic AC'97 audio driver and application.

### Intel 10/100 LAN Driver

This item installs the Fast Ethernet network driver.

## 3.2.3 Utilities menu

The Utilities menu shows the applications and other software that the motherboard supports.

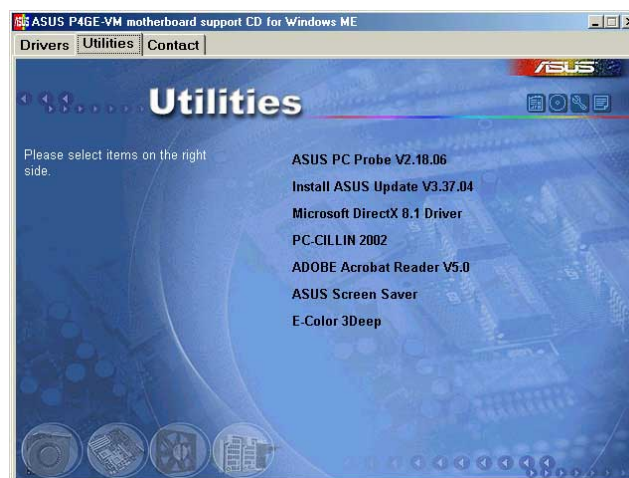

## ASUS PC Probe V2.18.07

This smart utility monitors the fan speed, CPU temperature, and system voltages, and alerts you on any detected problems. This utility helps you keep your computer at a healthy operating condition.

## Install ASUS Update V3.38.01

This program allows you to download the latest version of the BIOS from the ASUS website. Before using the ASUS Update, make sure that you have an Internet connection so you can connect to the ASUS website.

## Microsoft Direct X 8.1 Driver

This item installs the Microsoft V8.1 driver.

## PC-CILLIN 2002

This item installs the PC-cillin 2002 anti-virus program. View the PC-cillin online help for detailed information.

## Adobe Acrobat Reader V5.0

This item installs the Adobe Acrobat Reader V5.0. The Acrobat Reader software is for viewing files saved in Portable Document Format (PDF).

## ASUS Screen Saver

This item installs the ASUS screen saver.

## E-Color 3Deep

This item installs the 3Deep software. 3Deep is the first application that gives online gamers the competitive edge in multi-player skirmishes. This application removes dark washed-out graphics to deliver true vibrant colors.

## 3.2.4 ASUS Contact Information

Clicking the ASUS Contact Information tab displays as stated. You may also find this information on page viii of this user guide.





## Free Manuals Download Website

<http://myh66.com>

<http://usermanuals.us>

<http://www.somanuals.com>

<http://www.4manuals.cc>

<http://www.manual-lib.com>

<http://www.404manual.com>

<http://www.luxmanual.com>

<http://aubethermostatmanual.com>

Golf course search by state

<http://golfingnear.com>

Email search by domain

<http://emailbydomain.com>

Auto manuals search

<http://auto.somanuals.com>

TV manuals search

<http://tv.somanuals.com>