

# LAVAMAT 62840



User manual

Washing machine

# AEG

PERFEKT IN FORM UND FUNKTION

 Electrolux

Download from [www.Somanuals.com](http://www.Somanuals.com). All Manuals Search And Download.

## Dear Customer

Thank you for choosing one of our high-quality products.

With this appliance you will experience the perfect combination of functional design and cutting edge technology.

Convince yourself that our appliances are engineered to deliver the best performance and control - indeed we are setting the highest standards of excellence.

In addition to this you find environmental and energy saving aspects as an integral part of our products.

To ensure optimal and regular performance of your appliance please read this instruction manual carefully. It will enable you to navigate all processes perfectly and most efficiently. To refer to this manual any time you need to, we recommend you to keep it in a safe place. And please pass it to any future owner of the appliance.

We wish you much joy with your new appliance.

The following symbols are used in this manual:



Important information concerning your personal safety and information on how to avoid damaging the appliance



General information and tips



Environmental information

# Contents

---

Instruction for the user	6
Safety information	6-8
Product description	9
Detergent dispenser drawer	9
Control panel	10
First use	11
Personalization	11
Acoustic signals	11
Child safety lock	11
Daily use	12
Load the laundry	12
Measure out the detergent and the fabric softener	12
Select the required programme	13
Select the spin speed or the Rinse Hold option	13
Programm option button	14
Select the PREWASH option	14
Select the STAIN option	14
Select the SENSITIVE option	14
Select the TIME option	14-15
Display	15-16
Select the START/PAUSE	16
Select the DELAY START	16-17
Programme progress display	17
Select an additional rinse	17-18
Altering an option or a running programme	18
Interrupting a programme	18
Cancelling a programme	18

Opening the door after the programme has started	18
At the end of the programme	19
<b>Washing programmes</b>	<b>20-21</b>
<hr/>	
<b>Programme information</b>	<b>22</b>
<hr/>	
<b>Preparing the wash cycle</b>	<b>23-27</b>
<hr/>	
Sorting out the laundry	23
Temperatures	23
Before loading the laundry	23
Maximum loads	24
Laundry weights	24
Removing stains	25
Detergents and additives	26
Quantity of detergent to be used	26
Degrees of water hardness	27
<b>International wash code symbols</b>	<b>28</b>
<hr/>	
<b>Care and cleaning</b>	<b>29-33</b>
<hr/>	
Descaling	29
After each wash	29
Maintenance wash	29
External cleaning	29
Detergent dispenser drawer	29-30
Washing drum	30
Door seal	30
Drain pump	30-31
Water inlet filter	32
Emergency emptying out	32
Frost precautions	33

---

Something not working	34-37
Technical Data	38
Consumption value	39
Installation	40-46
Unpacking	40-41
Positioning and levelling	42
Water inlet	42-43
Water-stop device	43
Water drainage	43-44
In the interest of the environment	45
Electrical connection	45-46
Environment concerns	47
Packaging materials	47
Old machine	47
Ecological hints	47
Guarantee	48
Customer service centres	51

---

# Instruction for the user

## Safety information

### Prior to using for the first time

- The safety of AEG/ELECTROLUX appliances complies with the industry standards and with legal requirements on the safety of appliances. However, as manufacturers, we feel it is our duty to provide the following safety notes. You **MUST** read them carefully before installing or using the appliance.
- It is most important that this instruction book should be retained with the appliance for future reference. Should the appliance be sold or transferred to another owner, or should you move house and leave the appliance, always ensure that the book is supplied with the appliance in order that the new owner can get to know the functioning of the appliance and the relevant warnings.
- You **MUST** read them carefully before installing or using the appliance.
- Before first starting up, check the machine for any damage incurred during transport. Never connect up a damaged machine. If parts are damaged, contact your supplier.
- If the appliance is delivered in the winter months when there are minus temperatures: Store the washing machine at room temperature for 24 hours before using for the first time.

### General safety

- It is dangerous to alter the specifications or attempt to modify this product in any way.
- During high temperature wash programmes the door glass may get hot. Do not touch it!
- Make sure that small pets do not climb into the drum. To avoid this, please check into the drum before using.
- Any objects such as coins, safety pins, nails, screws, stones or any other hard, sharp material can cause extensive damage and must not be placed into the machine.
- Only use the advised quantities of fabric softener and detergent. Damage to the fabric can ensue if you over-fill. Refer to the manufacturer's recommendations of quantities.

- Wash small items such as socks, laces, washable belts etc in a washing bag or pillow case as it is possible for such items to slip down between the tub and the inner drum.
- Do not use your washing machine to wash articles with whalebones, material without hems or torn material.
- Always unplug the appliance and turn off the water supply after use, clean and maintenance.
- Under no circumstances should you attempt to repair the machine yourself. Repairs carried out by inexperienced persons may cause injury or serious malfunctioning. Contact your local Service Centre. Always insist on genuine spare parts.

## Installation

- When unpacking the appliance, check that it is not damaged. If in doubt, do not use it and contact the Service Centre.
- All packing and transit bolts must be removed before use. Serious damage can occur to the product and to property if this is not adhered to. See relevant section in the user manual.
- After having installed the appliance, check that it is not pressing or standing on its electrical supply cable, inlet hose and drain hose.
- If the machine is situated on a carpeted floor, please adjust the feet in order to allow air to circulate freely
- Always be sure, that there is no water leakage from hoses and their connections after the installation.
- If the appliance is installed in a location subject to frost, please read the **«dangers of freezing»** chapter.
- Any plumbing work required to install this appliance should be carried out by a qualified plumber or competent person.
- Any electrical work required to install this appliance should be carried out by a qualified electrician or competent person.

## Use

- This appliance is designed for domestic use. It must not be used for purposes other than those for which it was designed.
- Only wash fabrics which are designed to be machine washed. Follow the instructions on each garment label.
- Do not overload the appliance. See the relevant section in the user manual.

- Before washing, ensure that all pockets are empty and buttons and zips are fastened. Avoid washing frayed or torn articles and treat stains such as paint, ink, rust, and grass before washing. Underwired bras must NOT be machine washed.
- Garments which have been in contact with volatile petroleum products should not be machine washed. If volatile cleaning fluids are used, care should be taken to ensure that the fluid is removed from the garment before placing in the machine.
- Never pull the power supply cable to remove the plug from the socket; always take hold of the plug itself.
- Never use the washing machine if the power supply cable, the control panel, the working surface or the base are damaged so that the inside of the washing machine is accessible.

## Child Safety

- This appliance is not intended for use by person (including children) with reduced physical sensory or mental capabilities or lack of experience and knowledge unless they have been given supervision or instruction concerning use of the appliance by a person responsible for their safety.
- Young children should be supervised to ensure that they do not play with the appliance.
- The packaging components (e.g. plastic film, polystyrene) can be dangerous to children - danger of suffocation! Keep them out of children's reach.
- Keep all detergents in a safe place out of children's reach.
- Make sure that children or pets do not climb into the drum. To avoid this the machine incorporates special feature. To activate this device, rotate the button (without pressing it) inside the door clockwise until the groove is horizontal. If necessary use a coin. To disable this device and restore the possibility of closing the door, rotate the button anti-clockwise until the groove is vertical.

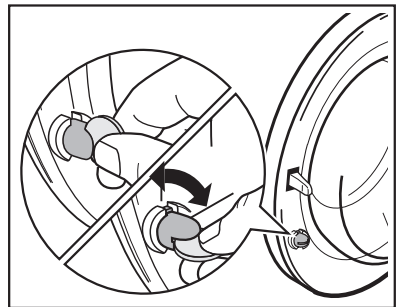



## Product description



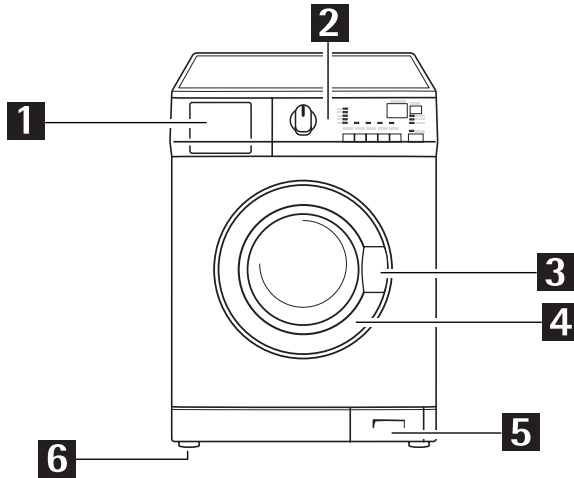

Your new appliance meets all modern requirements for effective treatment of laundry with low water, energy and detergent consumption.

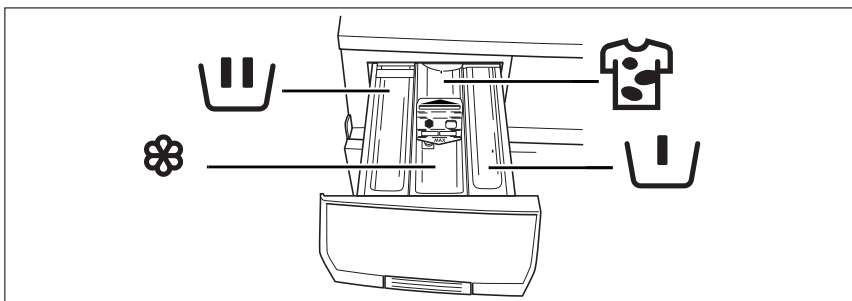

- |          |                            |          |                 |
|----------|----------------------------|----------|-----------------|
| <b>1</b> | Detergent dispenser drawer | <b>4</b> | Rating plate    |
| <b>2</b> | Control panel              | <b>5</b> | Drain pump      |
| <b>3</b> | Door opening handle        | <b>6</b> | Adjustable feet |

## Detergent dispenser drawer



-  Compartment for **prewash phase** used for **prewash**.
-  Compartment for powder or liquid detergent used for **main wash**.
-  Compartment for **liquid additives** (fabric softener, starch).
-  Compartment for stain remover used for main wash with **STAIN - option**.



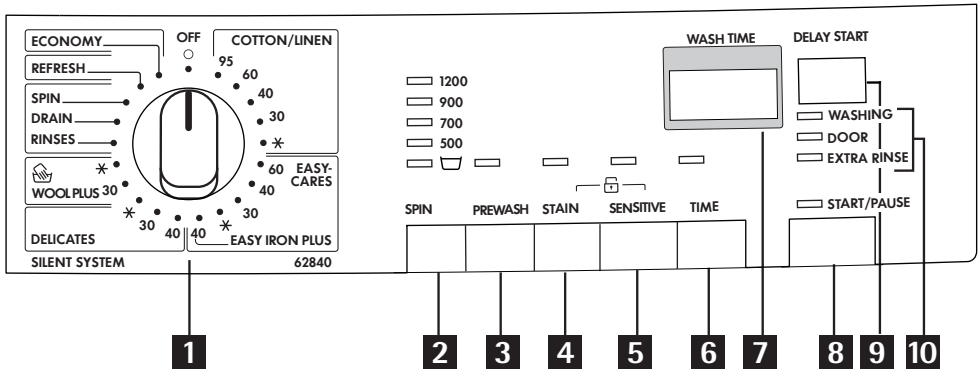

# Control panel



Henceforth the programme selector dial, the buttons and the display will be indicated with the numbers given in this table.

- |           |                            |
|-----------|----------------------------|
| <b>1</b>  | Programme selector dial    |
| <b>2</b>  | SPIN button                |
| <b>3</b>  | PREWASH button             |
| <b>4</b>  | STAIN button               |
| <b>5</b>  | SENSITIVE button           |
| <b>6</b>  | TIME button                |
| <b>7</b>  | Display                    |
| <b>8</b>  | START/PAUSE button         |
| <b>9</b>  | DELAY START button         |
| <b>10</b> | Programme progress display |

## First Use

-  Ensure that the electrical and water connections comply with the installation instructions.
-  Remove the polystyrene block and any material from the drum.
-  Pour 2 litres of water into the main wash compartment  of the detergent drawer in order to activate the ECO valve. Then run a cotton cycle at 95°C, without any laundry in the machine, to remove any manufacturing residue from the drum and tub. Pour 1/2 a measure of detergent into the dispenser drawer and start the machine.

## Personalization

### Acoustic signals

The machine is provided of an acoustic device, which sounds in the following cases:

- at the end of the cycle
- in the event of operating problems

By pressing the **3** and **4** buttons simultaneously for about 6 seconds, the acoustic signal is deactivated (except for the events of operating problems). By pressing these 2 buttons again, the acoustic signal is reactivated.

### Child safety lock

This device permits you to leave the appliance unsupervised without having the worry that children might be injured by or cause damage to the appliance.

This function remains able also when the washing machine is not working.

There are two different ways to set this option:

- before pressing the button **8**: it will be impossible to start the machine.
- after pressing the button **8** it will be impossible to change any other programme or option.

To enable (disable) this option press simultaneously for about 6 seconds **4** and **5** buttons until the icon  appears (disappears) on (from) the display.

## Daily Use

### Load the laundry



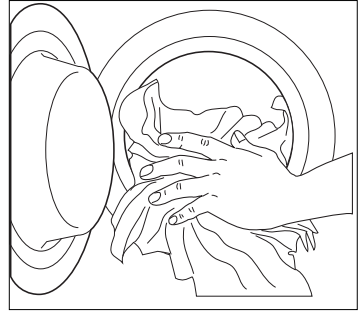

1. Open the door by carefully pulling the door handle outwards. Place the laundry in the drum, one item at a time, shaking them out as much as possible.
2. Close firmly the door. You must hear a click during closing.

**Attention!** Do not embed the laundry between the door and the rubber joint.



### Measure out the detergent and the fabric softener

Your new appliance was designed to reduce water, energy and detergent consumption.

1. Pull out the dispenser drawer until it stops. Measure out the amount of detergent required, pour it into the main wash compartment  and, if you wish to carry out the **prewash** phase, pour it into the compartment marked . If you wish to carry out to perform the **stain** function, pour it into the compartment .
2. If required, pour fabric softener into the compartment marked  (the amount used must not exceed the **MAX** mark in the drawer). Close the drawer gently.

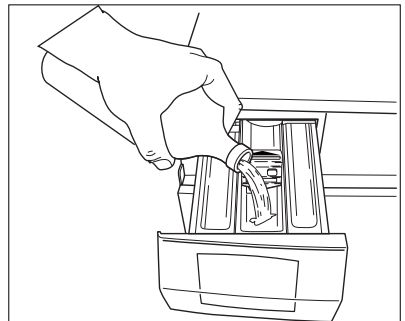
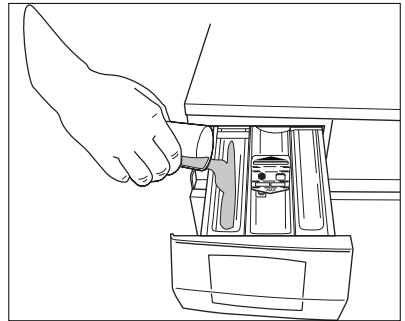

## Select the required programme (Position 1 on the control panel picture)

You can choose the right programme for any type of laundry following the descriptions on the washing programme tables (see Washing Programmes).

Turn the programme selector dial to the required programme. The programme selector determines the type of washing cycle (e.g. water level, drum movement, number of rinses) and the washing temperature according to the type of laundry.

The pilot light of button **8** starts blinking and the display shows the duration of the selected programme.

The selector dial can be turned either clockwise or anticlockwise. Position **O/OFF** to Reset programme/Switching OFF of the machine.

**At the end of the programme the selector dial must be turned to position O/OFF, to switch the machine off.**

Position **\*** = Cold wash

Easy-Cares = Synthetics.

### Attention!

If you turn the programme selector dial to another programme when the machine is working, the yellow pilot light of button **8** will flash 3 times and the message **Err** is displayed on the display to indicate a wrong selection. The machine will not perform the new selected programme.

## Select the SPIN speed reduction or the RINSE HOLD option (Button 2)

Press the button **2** repeatedly to change the spin speed, if you want your laundry to be spun at a speed different from the one proposed by the washing machine.

The relevant light will light up.

### Important!

For the maximum spin speed performed automatically by the washing machine, see chapter **Washing Programmes**.

**RINSE HOLD:** by selecting this option the water of the last rinse is not emptied out to prevent the fabrics from creasing. When the programme has finished the display shows a  flashing, the pilot lights **DOOR** illuminates, the pilot light of button **8** is off and the door is blocked to indicate that the water must be emptied out.

### To empty the water out:

- turn the programme selector dial to **O/OFF**
- select the **DRAIN** or **SPIN** programme

- reduce the spin speed if needed, by means of the relevant button
- depress button **8**
- when the programme has finished the display shows a  flashing. The pilot lights DOOR goes off and the door can be opened.

## Programme option button

Depending on the programme, different functions can be combined. These must be selected after choosing the desired programme and before depressing the button **8**.

When these buttons are pressed, the corresponding pilot lights come on. When they are pressed again, the pilot lights go out.

If an incorrect option is selected, the integrated yellow pilot light of the button **8** flashes for 3 times and the **Err** message appears on the display for some seconds.

### **Important!**

For the compatibility among the washing programmes and the options see chapter **Washing Programmes**.

## Select the PREWASH option (Button 3)

Select this option if you wish your laundry to be prewashed at 30°C before the main wash. The Prewash ends with a short spin in programmes for cotton and synthetic fabrics, whereas in the programmes for delicate fabrics the water is only drained.

The relevant light will light up.

## Select the STAIN option (Button 4)

Select this option to treat heavily soiled or stained laundry with stain remover (extended main wash with time optimised stain action phase). The relevant light will light up.

This option **is not** available with a temperature lower than 40°C.

**Attention!** If you wish to perform a programme with the stain option, pour stain remover into compartment .

## Select the SENSITIVE option (Button 5)

By depressing this button the washing intensity will be reduced. The machine adds one rinse in the programmes for Cotton and Synthetics.

This option is recommended for non fast coloureds items.

## Select the TIME option (Button 6)

This option allows you to modify the washing time, automatically proposed by the washing machine.

By pressing this button, the relative pilot light comes on and the washing duration will be reduced to wash daily soiled laundry.

On the display will be visualized the decreased washing time.

By pressing this button twice, the relative pilot light remains lit, the washing duration will be reduced to wash lightly soiled laundry or items that have been used or worn for a short time. On the display will be visualized the decreased washing time.

In this case the maximum recommended load for cottons is 3 kg and 1,5 kg for synthetics and delicates.

## Display (Position 7)

The display shows the following information:

### Duration of the selected programme

After selecting a programme, the duration is displayed in hours and minutes (for example **2.05**). The duration is calculated automatically on the basis of the maximum recommended load for each type of fabric.

After the programme has started, the time remaining is updated every minute.

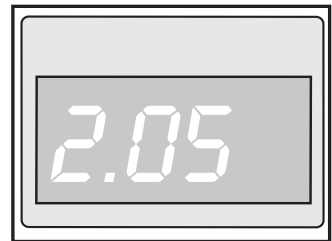

### Delay

The selected delay (20 hours max) set by means of the relevant button appears on the display for about 3 seconds, then the duration of the previously selected programme is displayed.

The DELAY START symbol  will appear on the display.

The delay time value decreases by one unit every hour. When only 1 hour remains, the time decreases every minute.

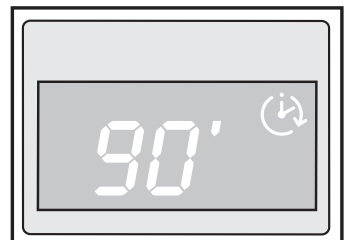

### Incorrect option selection

If an option which is not compatible with the set wash programme is selected, the message **Err** is

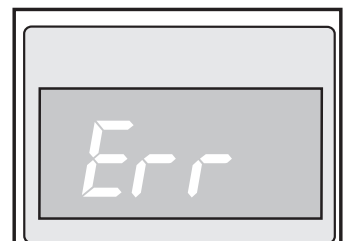

displayed for about 2 seconds and the yellow pilot light of button **8** light starts blinking.

### Alarm codes

In the event of operating problems, some alarm codes can be displayed, for example **E20** (see paragraph «Something not working»).

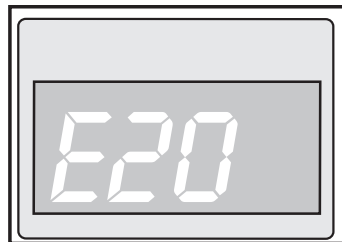

### End of programme

When the programme has finished a blinking zero is displayed, the DOOR and WASHING pilot lights and the pilot light of button **8** go out and the door can be opened.

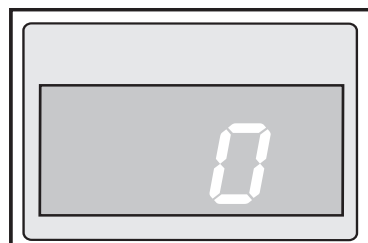

### Select the START/PAUSE (Button 8)

To start the selected programme, press the button **8**, the corresponding red pilot light stops blinking.

The WASHING pilot light is on to indicate that the appliance starts operating.

The DOOR pilot light is on to indicate the door is locked.

To interrupt a programme which is running, depress the button **8**: the corresponding red pilot light starts to flash.

To restart the programme from the point at which it was interrupted, **press** the button **8** again.

If you have chosen a delayed start, the machine will begin the countdown.

If an incorrect option is selected, the integrated yellow pilot light of the button **8** blinks for 3 times the message **Err** is displayed for about 2 seconds.

### Select the DELAY START (Button 9)

**Before you start the programme**, if you wish to delay the start, press the button **9** repeatedly, to select the desired delay.

The selected delay time value (up to 20 hours) will appear on the display for about 3 seconds, then the duration of the programme will appear again.

You must select this option after you have set the programme and before you press the button **8**.

The wash programme can be delayed from 30 min - 60 min - 90 min, 2 hours and then by 1 hour up to a maximum of 20 hours by means of this button.



If you wish to add laundry in the machine during the delay time you will press button **8** to put the machine in pause. Add the laundry, close the door and press button **8** again.

Selecting the delayed start.

- Select the programme and the required options.
- Select the delay start.
- Depress button **8**: the machine starts its hourly countdown. The programme will start after the selected delay has expired.

Cancelling the delayed start

- set the washing machine to PAUSE by pressing the button **8**;
- depress button **9** once until the symbol **U'** is displayed;
- press the button **8** again to start the programme.

### **Important!**

- Once the programme has already started, the selected delay can be changed only after selecting the washing programme again.
- The door will be locked throughout the delay time. If you need to open the door, you must first set the washing machine to PAUSE by pressing the button **8**. After you have closed the door, press the button **8** again.

The button **9** can not be selected with DRAIN programme.

## **Programme progress display (Position 10)**

After having pressed the button **8**, the WASHING pilot light comes on.

When the pilot light WASHING comes on this means that the machine is performing the washing cycle.

The DOOR pilot light indicates if the door can be opened:

- light on: the door cannot be opened. The appliance is running.
- light off: the door can be opened. The washing programme is finished.

When the appliance is performing additional rinses the EXTRA RINSE pilot light comes on.

## **Select an additional rinse (Extra rinse)**

This appliance is designed for saving water. However, for people with a very delicate skin (allergic to detergents) it may be necessary to rinse the laundry using an extra quantity of water (extra rinse).

Press simultaneously the buttons **2** and **3** for some seconds: the EXTRA RINSE pilot light comes on in the programme progress display. This function stays permanently on. To remove it press the same buttons again until the EXTRA RINSE light goes off.

## Altering an option or a running programme

It is possible to change any option before the programme carries it out. Before you make any change, you must pause the washing machine by pressing the button **8**.

Changing a running programme is possible **only by resetting it**. Turn the programme selector dial to **O/OFF** and then to the new programme position. Start the new programme by depressing the button **8** again. The washing water in the tub will be not emptied out.

## Interrupting a programme

Depress the button **8** to interrupt a programme which is running, the corresponding light starts blinking. Depress the button again to restart the programme.

## Cancelling a programme

Turn the selector dial to **O/OFF** to cancel a programme which is running. Now you can select a new programme.

## Opening the door after the programme has started

First set the machine to PAUSE by pressing the button **8**.

If the DOOR light goes off, the door can be opened.

If the DOOR light remains lit, this means that the machine is already heating, that the water level is above the bottom edge of the door. In this case the door can not be opened.

If you cannot open the door but you need to open it you have to switch the machine off by turning the selector dial to **O/OFF**. After about some minutes the door can be opened (**pay attention to the water level and temperature!**).

## At the end of the programme

The machine stops automatically, the pilot light of button **8** goes off, the DOOR and WASHING lights go off and a flashing  will appear on the display.

If the RINSE HOLD option have been selected, the DOOR pilot light illuminates, a flashing  will appear on the display, the pilot light of button **8** goes off and the door remains locked to indicate that the water must be emptied out before opening the door.

**To empty out the water please read the steps on the Rinse Hold option paragraph.**

Turn the programme selector dial to **O/OFF** to switch the machine off.

Remove the laundry from the drum and carefully check that the drum is empty.

If you do not intend to carry out another wash, close the water tap. Leave the door open to prevent the formation of mildew and unpleasant smells.

## Washing programmes

Programme/ Temperature	Type of laundry	Options	Description of programme
<b>COTTONS/LINENS</b> 95° - 60°	<b>White cotton</b> (heavily or normally soiled items)	SPIN, RINSE HOLD, PREWASH, STAIN, SENSITIVE, TIME, EXTRA RINSE	Main wash Rinses Long spin at maximum spin speed
<b>COTTONS</b> 60° - 40° - 30° - Cold	<b>Coloured cotton</b> (normally or lightly soiled items)	SPIN, RINSE HOLD, PREWASH, STAIN*, SENSITIVE, TIME, EXTRA RINSE	Main wash Rinses Long spin at maximum spin speed
<b>EASY-CARES</b> 60° - 40° - 30° - Cold	<b>Synthetic or mixed fabrics</b> (normally or lightly soiled items)	SPIN, RINSE HOLD, PREWASH, STAIN*, SENSITIVE, TIME, EXTRA RINSE	Main wash Rinses Short spin at 1200 rpm
<b>SYNTHETICS EASY IRON PLUS</b> 40°	<b>Synthetics to be gentle washed and spun</b>	SPIN, RINSE HOLD, PREWASH, EXTRA RINSE	Main wash Rinses Short spin at 1200 rpm
<b>DELICATES</b> 40° - 30° - Cold	<b>Delicate fabrics:</b> for example curtains	SPIN, RINSE HOLD, PREWASH, STAIN*, TIME, EXTRA RINSE	Main wash Rinses Short spin at 1200 rpm
<b>WOOL PLUS (HANDWASH)</b>  30° - Cold	Special programme for hand washing fabrics and specially programme for wool garments bearing the «Pure new wool, non-shrink, machine washable» label	SPIN, RINSE HOLD	Main wash Rinses Short spin at 1200 rpm



\* **STAIN option** can be selected only at the temperature of 40°C or higher.

## Washing programmes

Programme/ Temperature	Type of laundry	Options	Description of programme
<b>RINSES</b>	Separate rinse cycle for hand washed items.	SPIN, RINSE HOLD, EXTRA RINSE	Rinses Long spin at maximum spin speed
<b>DRAIN</b>	For emptying out the last rinse water in programmes with the Rinse Hold option.		Draining of water
<b>SPIN</b>	Separate spin for cotton fabric.	SPIN	Drain and long spin at the maximum speed
<b>REFRESH</b>	Quick wash for sport items, or cotton and synthetics items lightly soiled or worn once.	SPIN	Main wash Rinses Short spin at 1200 rpm
<b>ECONOMY</b>	<b>White and fast coloured cotton ECONOMY</b> , lightly- heavy soiled items	SPIN, RINSE HOLD, PREWASH, STAIN, SENSITIVE, EXTRA RINSE	Main wash Rinses Long spin at maximum spin speed
<b>O/OFF</b>	For cancelling the pro- gramme which is run- ning or to switch the machine off.		

Type of fabric	Max. Load
Cottons	6 kg
Synthetics and Delicates	3 kg
Easy Iron	1,5 kg
Wool (Handwash)	2 kg
Refresh	2 kg

## Programme information

<b>EASY IRON PLUS</b>	Selecting this programme the laundry is gently washed and spun to avoid any creasing. In this way ironing is easier. Furthermore the machine will perform additional rinses.
<b>WOOL PLUS (HANDWASH)</b>	Washing programme for machine washable wool  as well as for hand washable woollens and delicate fabrics with the "hand washing" care symbol  .
<b>RINSES</b>	With this programme it is possible to rinse and spin cotton garments which have been washed by hand. The machine performs 3 rinses, followed by a final spin at maximum speed. The spin speed can be reduced by depressing the button <b>2</b> .
<b>DRAIN</b>	For emptying out the water of the last rinse in programmes with the RINSE HOLD option. Turn first the programme selector dial to <b>O/OFF</b> , then select programme Drain and depress the button <b>8</b> .
<b>SPIN</b>	Separate spin for hand washed cotton garments and after programmes with Rinse Hold option. Before selecting this programme the selector dial must be turned to <b>O/OFF</b> . You can choose the speed by means of the relevant button to adapt it to the fabrics to be spun.
<b>REFRESH</b>	This programme can be selected with the following options: Spin Speed Reduction and DELAY START. This programme must be used for slightly soiled cotton items. Programme duration: 30 minutes
<b>ECONOMY</b>	This programme can be selected for slightly or normally soiled cotton items. The temperature will decrease and the washing time will be extended. This allows to obtain a good washing efficiency by saving energy.
<b>O/OFF</b>	To reset a programme and to switch off the machine turn the selector dial to <b>O/OFF</b> . Now can a new programme be selected.

## Preparing the wash cycle

### Sorting out the laundry

Follow the wash code symbols on each garment label and the manufacturer's washing instructions. Sort the laundry as follows: whites, coloureds, synthetics, delicates, woollens.

### Temperatures

<b>95° or 90°</b>	for normally soiled white cottons and linen (e.g. tea cloths, towels, tablecloths, sheets..).
<b>60°/50°</b>	for normally soiled, colour fast garments (e.g. shirts, night dresses, pyjamas....) in linen, cotton or synthetic fibres and for lightly soiled white cotton (e.g. underwear).
<b>40°-30°- Cold</b>	for delicate items (e.g. net curtains), mixed laundry including synthetic fibres and woollens bearing the label «pure new wool, machine washable, non-shrink».

### Before loading the laundry

Never wash whites and coloureds together. Whites may lose their "whiteness" in the wash.

New coloured items may run in the first wash; they should therefore be washed separately the first time.

**Make sure that no metal objects are left in the laundry (e.g. hair clips, safety pins, pins).**

Button up pillowcases, close zip fasteners, hooks and poppers. Tie any belts or long tapes.

Remove persistent stains before washing.

Rub particularly soiled areas with a special detergent or detergent paste.

Treat curtains with special care. Remove hooks or tie them up in a bag or net.

## Maximum loads

Recommended loads are indicated in the washing programme charts.

General rules:

**Cotton, linen:** drum full but not too tightly packed;

**Synthetics:** drum no more than half full;

**Delicate fabrics and woollens:** drum no more than one third full.

Washing a maximum load makes the most efficient use of water and energy.

For heavily soiled laundry, reduce the load size.

## Laundry weights

The following weights are indicative:

bathrobe	1200 g
napkin	100 g
quilt cover	700 g
sheet	500 g
pillow case	200 g
tablecloth	250 g
towelling towel	200 g
tea cloth	100 g
night dress	200 g
ladies' briefs	100 g
man's work shirt	600 g
man's shirt	200 g
man's pyjamas	500 g
blouse	100 g
men's underpants	100 g



## Removing stains

Stubborn stains may not be removed by just water and detergent. It is therefore advisable to treat them prior to washing.

**Blood:** treat fresh stains with cold water. For dried stains, soak overnight in water with a special detergent then rub in the soap and water.

**Oil based paint:** moisten with benzine stain remover, lay the garment on a soft cloth and dab the stain; treat several times.

**Dried grease stains:** moisten with turpentine, lay the garment on a soft surface and dab the stain with the fingertips and a cotton cloth.

**Rust:** oxalic acid dissolved in hot water or a rust removing product used cold. Be careful with rust stains which are not recent since the cellulose structure will already have been damaged and the fabric tends to hole.

**Mould stains:** treat with bleach, rinse well (whites and fast coloureds only).

**Grass:** soap lightly and treat with bleach (whites and fast coloureds only).

**Ball point pen and glue:** moisten with acetone (\*), lay the garment on a soft cloth and dab the stain.

**Lipstick:** moisten with acetone as above, then treat stains with methylated spirits. Treat any residual marks with bleach.

**Red wine:** soak in water and detergent, rinse and treat with acetic or citric acid, then rinse. Treat any residual marks with bleach.

**Ink:** depending on the type of ink, moisten the fabric first with acetone (\*), then with acetic acid; treat any residual marks on white fabrics with bleach and then rinse thoroughly.

**Tar stains:** first treat with stain remover, methylated spirits or benzine, then rub with detergent paste.

(\*) do not use acetone on artificial silk.

## Detergents and additives

Good washing results also depend on the choice of detergent and use of the correct quantities to avoid waste and protect the environment.

Although biodegradable, detergents contain substances which, in large quantities, can upset the delicate balance of nature.

The choice of detergent will depend on the type of fabric (delicates, woollens, cottons, etc.), the colour, washing temperature and degree of soiling.

All commonly available washing machine detergents may be used in this appliance:

- powder detergents for all types of fabric,
- powder detergents for delicate fabrics (60°C max) and woollens,
- liquid detergents, preferably for low temperature wash programmes (60°C max) for all types of fabric, or special for woollens only.

The detergent and any additives must be placed in the appropriate compartments of the dispenser drawer before starting the wash programme.

If using concentrated powder or liquid detergents, a programme **without** prewash must be selected.

Pour liquid detergent into the dispenser drawer compartment marked  **just before** starting the programme.

Any fabric softener or starching additives must be poured into the compartment marked  before starting the wash programme.

Follow the product manufacturer's recommendations on quantities to use and **do not exceed the «MAX» mark in the detergent dispenser drawer.**

## Quantity of detergent to be used

The type and quantity of detergent will depend on the type of fabric, load size, degree of soiling and hardness of the water used.

Follow the product manufacturers' instructions on quantities to use.

Use less detergent if:

- you are washing a small load,
- the laundry is lightly soiled,
- large amounts of foam form during washing.

## Degrees of water hardness









Water hardness is classified in so-called "degrees" of hardness. Information on hardness of the water in your area can be obtained from the relevant water supply company, or from your local authority.



**Note:** A water softener must be added when water has a medium-high degree of hardness (from degree of hardness II). Follow the manufacturer's instructions. The quantity of detergent can then always be adjusted to degree of hardness I (= soft).





Level	Characteristic	Degrees of water hardness	
		German °dH	French °T.H.
1	soft	0-7	0-15
2	medium	8-14	16-25
3	hard	15-21	26-37
4	very hard	> 21	> 37





### **i** International wash code symbols







These symbols appear on fabric labels, in order to help you choose the best way to treat your laundry.

<p><b>Energetic wash</b></p>   <p><b>Delicate wash</b></p>	 <p>Max. wash temperature 95°C</p>	 <p>Max. wash temperature 60°C</p>	 <p>Max. wash temperature 40°C</p>	 <p>Max. wash temperature 30°C</p>	 <p>Hand wash</p>	 <p>Do not wash at all</p>
--	---	---	---	---	--	--

 <p><b>Bleaching</b></p>	 <p>Bleach in cold water</p>	 <p>Do not bleach</p>
---	---	--

 <p><b>Ironing</b></p>	 <p>Hot iron max 200°C</p>	 <p>Warm iron max 150°C</p>	 <p>Lukewarm iron max 110°C</p>	 <p>Do not iron</p>
---	---	--	--	--

 <p><b>Dry cleaning</b></p>	 <p>Dry cleaning in all solvents</p>	 <p>Dry cleaning in perchlorethylene, petrol, pure alcohol, R 111 &amp; R 113</p>	 <p>Dry cleaning in petrol, pure alcohol and R 113</p>	 <p>Do not dry clean</p>
--	---	--	---	---

 <p><b>Drying</b></p>	 <p>Flat</p>	 <p>On the line</p>	 <p>On clothes hanger</p>	 <p>high temperature</p>  <p>low temperature</p> <p>Tumble dry</p>	 <p>Do not tumble dry</p>
--	---	--	--	--	--

## Care and cleaning

You must DISCONNECT the appliance from the electricity supply, before you can carry out any cleaning or maintenance work.

### Descaling

The water we use normally contains lime. It is a good idea to periodically use a water softening powder in the machine. Do this separately from any laundry washing, and according to the softening powder manufacturer's instructions.

This will help to prevent the formation of lime deposits.

### After each wash

Leave the door open for a while. This helps to prevent mould and stagnant smells forming inside the appliance. Keeping the door open after a wash will also help to preserve the door seal.

### Maintenance wash

With the use of low temperature washes it is possible to get a build up of residues inside the drum.

We recommend that a maintenance wash be performed on a regular basis.

To run a maintenance wash:

- The drum should be empty of laundry.
- Select the hottest cotton wash programme.
- Use a normal measure of detergent, must be a powder with biological properties.

### External cleaning

Clean the exterior cabinet of the appliance with soap and water only, and then dry thoroughly.

**Important:** do not use methylated spirits, solvents or similar products to clean the cabinet.

### Detergent dispenser drawer

The detergent dispenser drawer should be cleaned regularly.

1. Remove the detergent dispenser drawer by pulling it firmly.

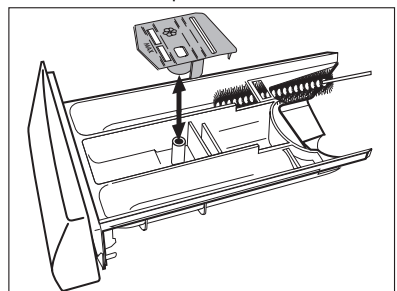

2. Remove the conditioner insert from the middle compartment.
3. Clean all parts with water.
4. Put the conditioner insert in as far as it will go, so that it is firmly in place.
5. Clean all parts of the washing machine, especially the nozzles in the top of the washing-in chamber, with a brush.
6. Insert the detergent dispenser drawer in the guide rails and push it in.

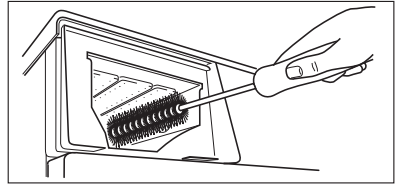

## Washing drum

Rust deposits in the drum may occur due to rusting foreign bodies in the washing or tap water containing iron.

**Important!** Do not clean the drum with acidic descaling agents, scouring agents containing chlorine or iron or steel wool.

1. Remove any rust deposits on the drum with a cleaning agent for stainless steel.
2. Run a washing cycle without any washing to clean off any cleaning agent residues. Programme: COTTONS/LINEN 95, press the button **8**, add approx. 1/4 measuring cup of detergent.

## Door seal

Check from time to time the door seal and eliminate eventual possible objects that could be trapped in the fold.

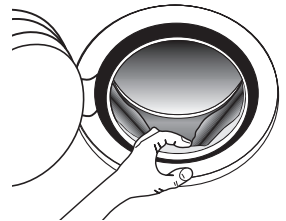

## Drain pump

The pump should be inspected regularly and particularly if

- the machine does not empty and/or spin
- the machine makes an unusual noise during draining due to objects such as safety pins, coins etc. blocking the pump.

Proceed as follows:

1. Disconnect the appliance.
2. If necessary wait until the water has cooled down.
3. Open the pump door.

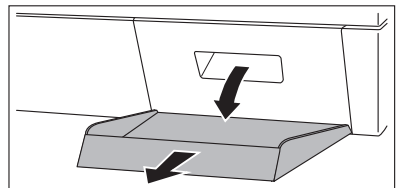

4. Place a container close to the pump to collect any spillage.
5. Release the emergency emptying hose, place it in the container and remove its cap.

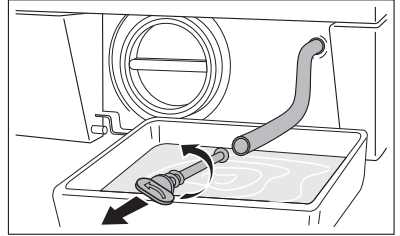
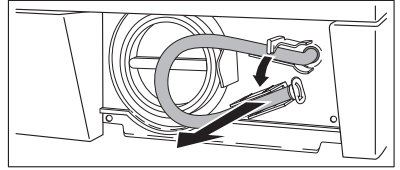

6. When no more water comes out, unscrew the pump and remove it. Always keep a rag nearby to dry up spillage of water when removing the pump.

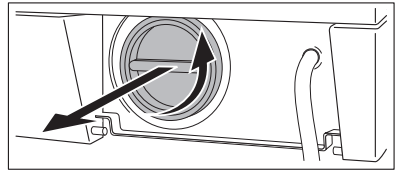

7. Remove any objects from the pump impeller by rotating it.

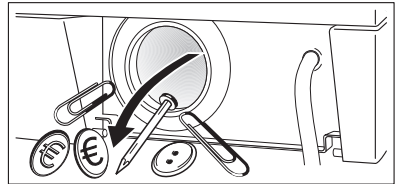

8. Put the cap back on the emergency emptying hose and place the latter back in its seat.

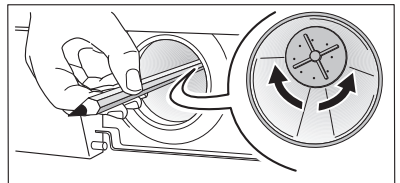

9. Screw the pump fully in.

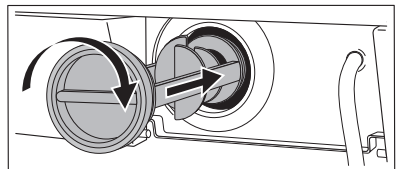

10. Close the pump door.

**Warning!**

When the appliance is in use and depending on the programme selected there can be hot water in the pump. Never remove the pump cover during a wash cycle, always wait until the appliance has finished the cycle, and is empty. When replacing the cover, ensure it is securely retightened so as to stop leaks and young children being able to remove it.

## Water inlet filter

If you notice that the machine is taking longer to fill, check that the filter in the water inlet hose is not blocked.

1. Turn off the water tap.
2. Unscrew the hose from the tap.
3. Clean the filter in the hose with a stiff brush.
4. Screw the hose back onto the tap.

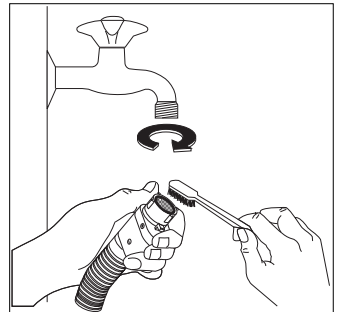

## Emergency emptying out

If the water is not discharged, proceed as follows to empty out the machine:

1. pull out the plug from the power socket;
2. close the water tap;
3. if necessary, wait until the water has cooled down;
4. open the the pump door;
5. place a bowl on the floor and place the end of the emergency emptying hose into the bowl. Remove its cap. The water should drain by gravity into the bowl. When the bowl is full, put the cap back on the hose. Empty the bowl. Repeat the procedure until water stops flowing out;
6. clean the pump if necessary as previously described;



7. replace the emergency emptying hose in its seat after having plugged it;
8. screw the pump again and close the door.

## Frost precautions

If the machine is installed in a place where the temperature could drop below 0°C, proceed as follows:

1. Close the water tap and unscrew the water inlet hose from the tap.
2. Place the end of the emergency emptying hose and that of the inlet hose in a bowl placed on the floor and let water drain out.
3. Screw the water inlet hose back on and reposition the emergency emptying hose after having put the cap on again.

By doing this, any water remaining in the machine is removed, avoiding ice forming and consequently damage to the appliance.

When you use the machine again, make sure that the ambient temperature is above 0°C.

**Important!** Every time you drain the water through the emergency emptying hose you must pour 2 litres of water into the main wash compartment of the detergent drawer and then run the drain programme. This will activate the ECO VALVE device avoiding that part of the detergent remains unused at next washing.

## Something not working

Certain problems are due to lack of simple maintenance or oversights, which can be solved easily without calling out an engineer. Before contacting your local Service Centre, please carry out the checks listed below.

During machine operation it is possible that the **yellow** pilot light of button **8** blinks, one of the following alarm codes appears on the display and at the same time some acoustic signals sound every 20 seconds to indicate that the machine is not working:

- **E10** : problem with the water supply
- **E20** : problem with the water draining
- **E40** : door open.

Once the problem has been eliminated, press the button **8** to restart the programme. If after all checks, the problem persists, contact your local Service Centre.

Problem	Possible cause/Solution
<p><b>The washing machine does not start:</b></p>	<p>The door has not been closed. <b>E40</b></p> <ul style="list-style-type: none"> <li>• Close firmly the door.</li> </ul> <p>The plug is not properly inserted in the power socket.</p> <ul style="list-style-type: none"> <li>• Insert the plug into the power socket.</li> </ul> <p>There is no power at the socket.</p> <ul style="list-style-type: none"> <li>• Please check your domestic electrical installation.</li> </ul> <p>The main fuse or the fuse in the plug has blown.</p> <ul style="list-style-type: none"> <li>• Replace the fuse.</li> </ul> <p>The selector dial is not correctly positioned and the button <b>8</b> has not been depressed.</p> <ul style="list-style-type: none"> <li>• Please turn the selector dial and press the button <b>8</b> again.</li> </ul> <p>The delay start has been selected.</p> <ul style="list-style-type: none"> <li>• If the laundry are to be washed immediately, cancel the delay start.</li> </ul>
<p><b>The machine does not fill:</b></p>	<p>The water tap is closed. <b>E10</b></p> <ul style="list-style-type: none"> <li>• Open the water tap.</li> </ul> <p>The inlet hose is squashed or kinked. <b>E10</b></p> <ul style="list-style-type: none"> <li>• Check the inlet hose connection.</li> </ul> <p>The filter in the inlet hose is blocked. <b>E10</b></p> <ul style="list-style-type: none"> <li>• Clean the water inlet hose filter.</li> </ul> <p>The door is not properly closed. <b>E40</b></p> <ul style="list-style-type: none"> <li>• Close firmly the door.</li> </ul>

Problem	Possible cause/Solution
<b>The machine fills then empties immediately:</b>	<p>The end of the drain hose is too low.</p> <ul style="list-style-type: none"> <li>• Refer to relevant paragraph in «water drainage» section.</li> </ul>
<b>The machine does not empty and/or does not spin:</b>	<p>The drain hose is squashed or kinked. <i>E20</i></p> <ul style="list-style-type: none"> <li>• Check the drain hose connection.</li> </ul> <p>The drain pump is clogged. <i>E20</i></p> <ul style="list-style-type: none"> <li>• Clean the drain pump.</li> </ul> <p>The RINSE HOLD option has been selected.</p> <ul style="list-style-type: none"> <li>• Disable the option.</li> <li>• Select the option DRAIN or SPIN.</li> </ul> <p>The laundry is not evenly distributed in the drum.</p> <ul style="list-style-type: none"> <li>• Redistribute the laundry.</li> </ul>
<b>There is water on the floor:</b>	<p>Too much detergent or unsuitable detergent (creates too much foam) has been used.</p> <ul style="list-style-type: none"> <li>• Reduce the detergent quantity or use another one.</li> </ul> <p>Check whether there are any leaks from one of the inlet hose fittings. It is not always easy to see this as the water runs down the hose; check to see if it is damp.</p> <ul style="list-style-type: none"> <li>• Check the water inlet hose connection.</li> </ul> <p>The drain hose is damaged.</p> <ul style="list-style-type: none"> <li>• Change it with a new one.</li> </ul> <p>The cap on the emergency emptying hose has not been replaced after cleaning the pump.</p> <ul style="list-style-type: none"> <li>• Put the cap back on the emergency emptying and place the latter back in its seat.</li> </ul>
<b>Unsatisfactory washing results:</b>	<p>Too little detergent or unsuitable detergent has been used.</p> <ul style="list-style-type: none"> <li>• Increase the detergent quantity or use another one.</li> </ul> <p>Stubborn stains have not been treated prior to washing.</p> <ul style="list-style-type: none"> <li>• Use commercial products to treat the stubborn stains.</li> </ul> <p>The correct temperature was not selected.</p> <ul style="list-style-type: none"> <li>• Check if you have selected the correct temperature.</li> </ul> <p>Excessive laundry load.</p> <ul style="list-style-type: none"> <li>• Introduce into the drum less laundry.</li> </ul>

Problem	Cause possible/Solution
<b>The door will not open:</b>	<p>The programme is still running.</p> <ul style="list-style-type: none"> <li>• Wait the end of washing cycle.</li> </ul> <p>The door lock has not been released.</p> <ul style="list-style-type: none"> <li>• Wait some minutes.</li> </ul> <p>There is water in the drum.</p> <ul style="list-style-type: none"> <li>• Select drain or spin programme to empty out the water.</li> </ul> <p>In any case, the door can be only opened when the DOOR light has gone off.</p>
<b>The machine vibrates or is noisy:</b>	<p>The transit bolts and packing have not been removed.</p> <ul style="list-style-type: none"> <li>• Check the correct installation of the appliance.</li> </ul> <p>The support feet have not been adjusted</p> <ul style="list-style-type: none"> <li>• Check the correct levelling of the appliance.</li> </ul> <p>The laundry is not evenly distributed in the drum.</p> <ul style="list-style-type: none"> <li>• Redistribute the laundry.</li> </ul> <p>Maybe there is very little laundry in the drum.</p> <ul style="list-style-type: none"> <li>• Load more laundry.</li> </ul>
<b>Spinning starts late or the machine does not spin:</b>	<p>The electronic unbalance detection device has cut in because the laundry is not evenly distributed in the drum. The laundry is redistributed by reverse rotation of the drum. This may happen several times before the unbalance disappears and normal spinning can resume. If, after some minutes, the laundry is still not evenly distributed in the drum, the machine will not spin.</p> <ul style="list-style-type: none"> <li>• Redistribute the laundry.</li> </ul>
<b>The machine makes an unusual noise:</b>	<p>The machine is fitted with a type of motor which makes an unusual noise compared with other traditional motors. This new motor ensures a softer start and more even distribution of the laundry in the drum when spinning, as well as increased stability of the machine.</p>
<b>No water is visible in the drum:</b>	<p>Machines based on modern technology operate very economically using very little water without affecting performance.</p>

If you are unable to identify or solve the problem, contact our service centre. Before telephoning, make a note of the model, serial number and purchase date of your machine: the Service Centre will require this information.

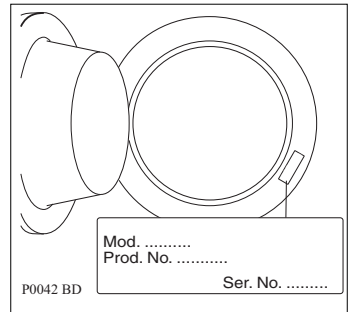

## Technical Data

Dimensions	Width Height Depth (door included)	60 cm 85 cm 63 cm
Electrical connection Voltage - Overall power - Fuse	Information on the electrical connection is given on the rating plate on the inner edge of the appliance door	
Water supply pressure	Minimum Maximum	0,05 MPa 0,8 MPa
Maximum Load	Cotton	6 kg
Spin Speed	Maximum	1200 rpm



## Consumption value

Programme	Water consumption (in litres)	Energy consumption (in kWh)	Programme duration (in minutes)
White Cottons 95°	61	2.0	For the duration of the programmes, please refer to the display on the control panel.
Cottons 40°	58	0.7	
Easy-Cares 60°	54	1.0	
Easy Iron Plus 40°	60	0.35	
Delicates 40°	60	0.55	
Wool Plus (Handwash) 30°	53	0.25	
Rinses	42	0.1	
Drain	-	-	
Spin	-	-	
Refresh 30°	55	0.25	
Economy 60° (*)	46	1.02	

**i** The consumption data shown on this chart is to be considered purely indicative, as it may vary depending on the quantity and type of laundry, on the inlet water temperature and on the ambient temperature. It refers to the highest temperature for each wash programme.

**i** (\*) «Cottons ECONOMY» at 60°C with a load of 6 kg is the reference programme for the data entered in the energy label, in compliance with EEC 92/75 standards.

# Installation

## Unpacking

All transit bolts and packing must be removed before using the appliance.

You are advised to keep all transit devices so that they can be refitted if the machine ever has to be transported again.

1. After removing all the packaging, carefully lay machine on it's back to remove the polystyrene base from the bottom.



2. Remove the power supply cable and the draining hose from the hose holders on the rear of the appliance.

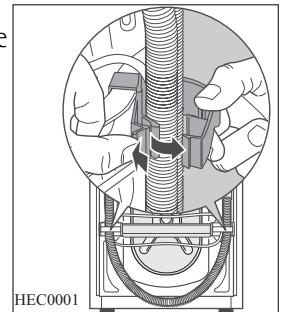

3. With the provided spanner unscrew and remove the central rear bolt **A**.

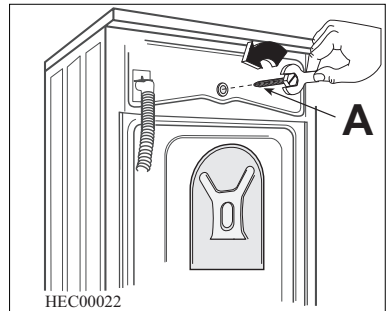



4. Unscrew and remove the two large rear bolts **B** and the six smaller bolts **C**.

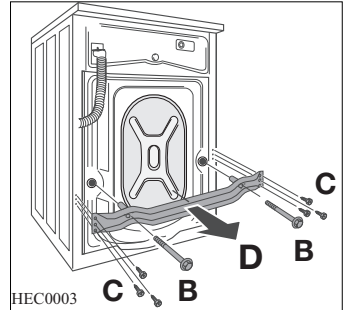

5. Remove the bracket **D** and tighten up the six smaller bolts **C**. Slide out the relevant plastic spacer **E**.

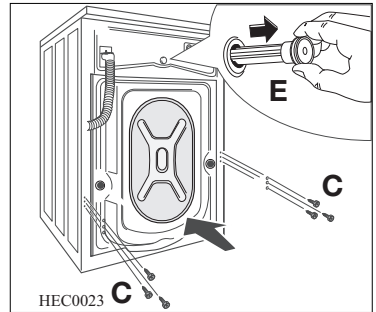

6. Open the porthole, take out the inlet hose from the drum and remove the polystyrene block fitted on the door seal.

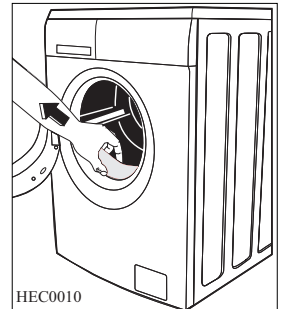

7. Fill the smaller upper hole and the two large ones with the corresponding plastic plug caps supplied in the bag containing the instruction booklet.
8. Connect the water inlet hose as described under the paragraph «Water inlet».

All the different plug caps are supplied with the appliance in the plastic bag containing the instruction booklet.

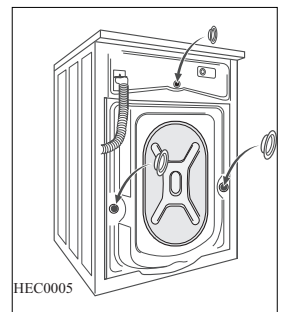

## Positioning and levelling

Install the machine on a flat hard floor.

Make sure that air circulation around the machine is not impeded by carpets, rugs etc.

Before placing it on small tiles, apply a rubber coating.

Never try to correct any unevenness in the floor by putting pieces of wood, cardboard or similar materials under the machine.

If it is impossible to avoid positioning the machine next to a gas cooker or coal-burning stove, an insulating panel covered with aluminium foil on the side facing the cooker or stove, must be inserted between the two appliances.

The machine must not be installed in rooms where the temperature can drop below 0.

The water inlet hose and the drain hose must not be kinked.

Please ensure that when the appliance is installed, it is easily accessible for the engineer in the event of a breakdown.

Carefully level by screwing the adjustable feet in or out. Never place cardboard, wood or similar materials under the machine to compensate for any unevenness in the floor.

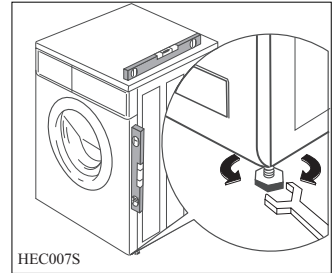

## Water inlet

An inlet hose is supplied and can be found inside the machine drum.

**Do not use the already employed hoses to connect to the water supply.**

**This appliance must be connected to a cold water supply.**

1. Open the porthole and extract the inlet hose.
2. Connect the hose with the angled connection to the machine.

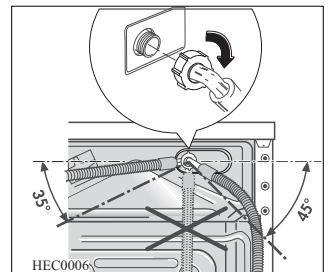
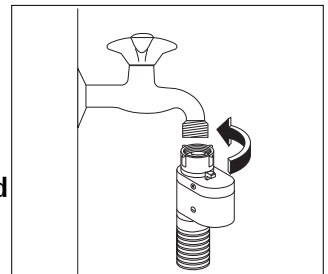

**Do not place the inlet hose downwards. Angle the hose to the left or right depending on the position of your water tap.**

3. Set the hose correctly by loosening the ring nut. After positioning the inlet hose, be sure to tighten the ring nut again to prevent leaks.
4. Connect the hose to a tap with a 3/4" thread. Always use the hose supplied with the appliance.

Installation should comply with local water authority and building regulations requirements. A minimum water pressure of 0.05 MPa is required for safe operation of the appliance.

If you cannot make the cold water connection direct from the rising mains, you may be able to operate the appliance from your cold water storage system. There should be a minimum distance of between the appliance's inlet and the bottom of the water storage tank.

## Water-stop device

The inlet hose is provided with a water stop device, which protects against damage caused by water leaks in the hose which could develop due to natural ageing of the hose. This fault is shown by a red sector in the window "A". Should this occur, turn the water tap off and refer to your Service Centre to replace the hose.

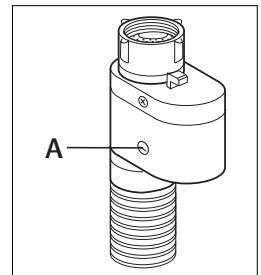

## Water drainage

This appliance is designed to be permanently plumbed into your home's drainage system using one of the following methods.

### 1. Into a drainage standpipe.

Firstly form a hook in the end of the drain hose using the "U" piece" supplied.

Place the drain hose into your standpipe, which should have an internal diameter of approximately 38mm thus ensuring there is an air break between the drain hose and standpipe.

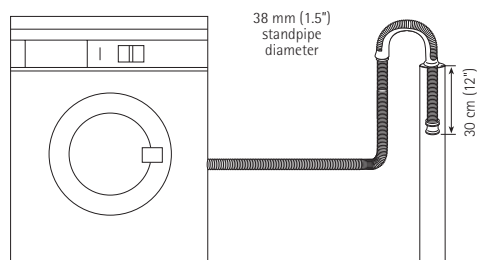
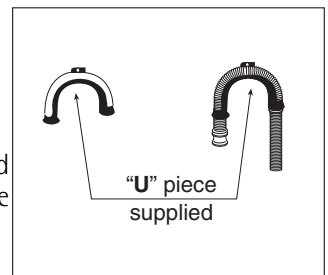

When discharging into a standpipe ensure that the top of the standpipe is no more than 90 cm (35.4") and no less than 60 cm (23.6") above floor level.

The drain hose may be extended to a maximum of 4 metres. An additional drain hose and joining piece is available from your local Service Force Centre. The joining piece must have an internal diameter of 18 mm.

If your drain hose looks like this (see the relevant picture) you do not require the "U" piece. Just push the hose firmly into the standpipe.

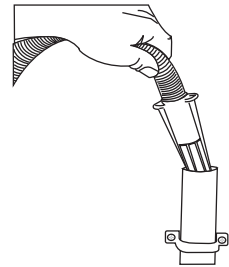
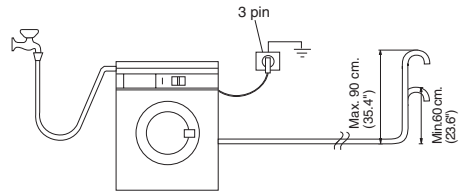

## 2. Onto a sink outlet spigot.

If the outlet spigot has not been used before, remove any blanking plug that may be in place.

Push the drain hose onto the spigot and secure with a clip if required, ensure a loop is formed in the drain hose (see diagram) to prevent waste from the sink entering the washing machine.

The drain hose may be extended to a maximum of 4 metres. An additional drain hose and joining piece is available from your local Service Force Centre. The joining piece must have an internal diameter of 18 mm.

If you intend the drain hose from the machine to empty into a sink, make sure that the sink is empty and the plug hole is not blocked. Use the plastic "U -Piece" supplied.

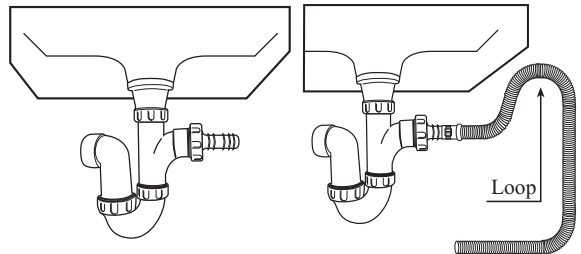

## Important

Before connecting up the machine to new pipework or to pipework that has not been used for some time, run off a reasonable amount of water to flush out any debris that may have collected in the pipes.

## In the interest of the environment

Washing machines and dishwashers should be connected to the FOUL drainage system, the water will then be taken to a sewage works for treatment before being discharged safely into a river.

It is essential that these appliances are not connected to the surface water drainage system as this water is discharged directly into a river or stream and may cause pollution.

If you require any further advice please contact your local water authority.

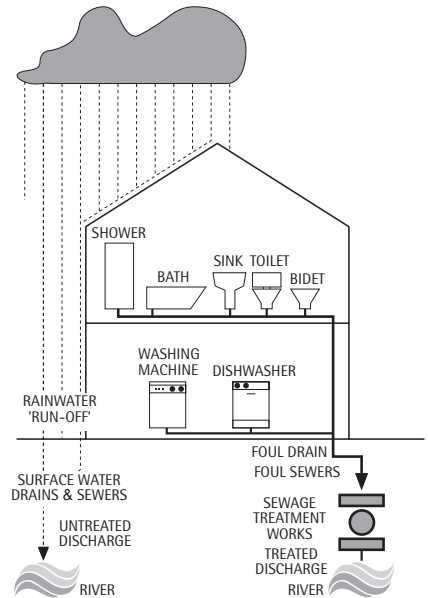

## Electrical connection



**WARNING: THIS APPLIANCE MUST BE EARTHED.**



**The manufacturer does not accept any responsibility for damage or injury through failure to comply with the above safety precaution.**

If the plug that is fitted to your appliance is not suitable for your socket outlet, it must be cut off and the appropriate plug fitted.

Remove the fuse from the cut off plug.

The cut off plug should then be disposed of to prevent the hazard of shocks in case it should be plugged into a 13 Amp socket in another part of your home.

### Important

The wires in the mains lead are coloured in accordance with the following code:

- |                  |           |
|------------------|-----------|
| Green and Yellow | - Earth   |
| Blue             | - Neutral |
| Brown            | - Live    |

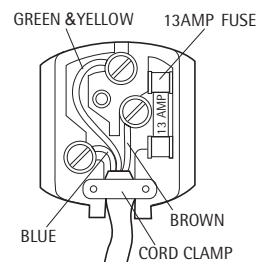

If you fit your own plug, the colours of the wires in the mains lead of your appliance may not correspond with the markings identifying the terminals in your plug, proceed as follows:

Connect the green and yellow (earth) wire to the terminal in the plug which is marked with the letter «E» or the earth symbol  or coloured green and yellow.

Connect the blue (neutral) wire to the terminal in the plug which is marked with the letter «N» or coloured black.

Connect the brown (live) wire to the terminal in the plug which is marked with the letter «L» or coloured red.

The plug moulded on to the lead incorporates a fuse. For replacement, use a 13 Amp BS1363/A fuse. Only ASTA or BSI approved fuses should be used.

The plug must not be used if the fuse cover/carrier is lost. The cover/carrier is indicated by the coloured insert at the base of the plug.

A replacement cover/carrier must be obtained from your local AEG/ELECTROLUX Service Centre.



**The power supply cable must be easily accessible after installing the machine.**



**Should the appliance power supply cable need to be replaced, this MUST be carried out by a Service Centre.**

## Environment concerns

### Packaging materials

The materials marked with the symbol  are recyclable.

>PE<=polyethylene

>PS<=polystyrene

>PP<=polypropylene

This means that they can be recycled by disposing of them properly in appropriate collection containers.

### Old machine

Use authorised disposal sites for your old appliance. Help to keep your country tidy!

The symbol  on the product or on its packaging indicates that this product may not be treated as household waste. Instead it shall be handed over to the applicable collection point for the recycling of electrical and electronic equipment. By ensuring this product is disposed of correctly, you will help prevent potential negative consequences for the environment and human health, which could otherwise be caused by inappropriate waste handling of this product. For more detailed information about recycling of this product, please contact your local city office, your household waste disposal service or the shop where you purchased the product.

### Ecological hints

To save water, energy and to help protect the environment, we recommend that you follow these tips:

- Normally soiled laundry may be washed without prewashing in order to save detergent, water and time (the environment is protected too!).
- The machine works more economically if it is fully loaded.
- With adequate pre-treatment, stains and limited soiling can be removed; the laundry can then be washed at a lower temperature.
- Measure out detergent according to the water hardness, the degree of soiling and the quantity of laundry being washed.

## Standard guarantee conditions

We, AEG-Electrolux, undertake that if within 12 months of the date of the purchase this AEG-Electrolux appliance or any part thereof is proved to be defective by reason only of faulty workmanship or materials, we will, at our option repair or replace the same FREE OF CHARGE for labour, materials or carriage on condition that:

- The appliance has been correctly installed and used only on the electricity supply stated on the rating plate.
- The appliance has been used for normal domestic purposes only, and in accordance with the manufacturer's instructions.
- The appliance has not been serviced, maintained, repaired, taken apart or tampered with by any person not authorised by us.
- Electrolux Service Force Centre must undertake all service work under this guarantee
- Any appliance or defective part replaced shall become the Company's property.
- This guarantee is in addition to your statutory and other legal rights.

### Exclusions

- Damage or calls resulting from transportation, improper use or neglect, the replacement of any light bulbs or removable parts of glass or plastic.
- Costs incurred for calls to put right an appliance which is improperly installed or calls to appliances outside the United Kingdom.
- Appliances found to be in use within a commercial environment, plus those which are subject to rental agreements.
- Products of Electrolux manufacturer that are not marketed by Electrolux

### Service and Spare Parts

In the event of your appliance requiring service, or if you wish to purchase spare parts, please contact your local Service Force Centre by telephoning

**0870 5 929 929**

Your telephone call will be automatically routed to the Service Force Centre covering your postcode area.



For the address of your local Service Force Centre and further information about Service Force, please visit the website at:

**[www.serviceforce.co.uk](http://www.serviceforce.co.uk)**

Before calling out an engineer, please ensure you have read the details under the heading "Something not working"

When you contact the Service Force Centre you will need to give the following details:

- 1 Your name, address and postcode.
- 2 Your telephone number.
- 3 Clear concise details of the fault.
- 4 The model and Serial number of the appliance (found on the rating plate).
- 5 The purchase date.

Please note a valid purchase receipt or guarantee documentation is required for in guarantee service calls.

### **Customer Care**

For general enquiries concerning your Electrolux appliance, or for further information on Electrolux products please contact our Customer Care Department by letter or telephone at the address below or visit our website at [www.electrolux.co.uk](http://www.electrolux.co.uk)

Customer Care Department Electrolux Major Appliances Addington Way Luton Bedfordshire, LU4 9QQ Tel: 08705 350 350 (\*)

(\*) Calls may be recorded for training purposes

For Customer Service in The Republic of Ireland please contact us at the address below:

AEG/ELECTROLUX  
Electrolux Group (Ire) Ltd  
Long Mile Road  
Dublin 12  
Republic of Ireland  
Tel: + 353 (0) 1 4090754  
email: [service.eid@electrolux.ie](mailto:service.eid@electrolux.ie)



## European Guarantee

This appliance is guaranteed by Electrolux in each of the countries listed at the back of this user manual, for the period specified in the appliance guarantee or otherwise by law. If you move from one of these countries to another of the countries listed, the appliance guarantee will move with you subject to the following qualifications:

- The appliance guarantee starts from the date you first purchased the appliance which will be evidenced by production of a valid purchase document issued by the seller of the appliance.
- The appliance guarantee is for the same period and to the same extent for labour and parts as exists in your new country of residence for this particular model or range of appliances.
- The appliance guarantee is personal to the original purchaser of the appliance and cannot be transferred to another user.
- The appliance is installed and used in accordance with instructions issued by Electrolux and is only used within the home, i.e. is not used for commercial purposes.
- The appliance is installed in accordance with all relevant regulations in force within your new country of residence.

The provisions of this European Guarantee do not affect any of the rights granted to you by law.

## www.electrolux.com

		
Albania	+35 5 4 261 450	Rr. Pjeter Bogdani Nr. 7 Tirane
Belgique/België/Belgien	+32 2 363 04 44	Bergensesteenweg 719, 1502 Lembeek
Česká republika	+420 2 61 12 61 12	Budějovická 3, Praha 4, 140 21
Danmark	+45 70 11 74 00	Sjællandsgade 2, 7000 Fredericia
Deutschland	+49 180 32 26 622	Muggenhofer Str. 135, 90429 Nürnberg
Eesti	+37 2 66 50 030	Mustamäe tee 24, 10621 Tallinn
España	+34 902 11 63 88	Carretera M-300, Km. 29,900 Alcalá de Henares Madrid
France	www.electrolux.fr	
Great Britain	+44 8705 929 929	Addington Way, Luton, Bedfordshire LU4 9QQ
Hellas	+30 23 10 56 19 70	4, Limnou Str., 54627 Thessaloniki
Hrvatska	+38 51 63 23 338	Slavonska avenija 3, 10000 Zagreb
Ireland	+353 1 40 90 753	Longmile Road Dublin 12
Italia	+39 (0) 434 558500	C.so Lino Zanussi, 26 - 33080 Porcia (PN)
Latvija	+37 17 84 59 34	Kr. Barona iela 130/2, LV-1012, Riga
Lituanija	+370 5 27 80 609	Verkių 2 9, 09108 Vilnius, Lithuania
Luxembourg	+35 2 42 43 13 01	Rue de Bitbourg, 7, L-1273 Hamm
Magyarország	+36 1 252 1773	H-1142 Budapest XIV, Erzsébet királyné útja 87
Nederland	+31 17 24 68 300	Vennootsweg 1, 2404 CG - Alphen aan den Rijn
Norge	+47 81 5 30 222	Risløkkvn. 2, 0508 Oslo
Österreich	+43 18 66 400	Herziggasse 9, 1230 Wien
Polska	+48 22 43 47 300	ul. Kolejowa 5/7, Warsaw
Portugal	+35 12 14 40 39 39	Quinta da Fonte - Edifício Gonçalves Zarco - Q35 - 2774-518 Paço de Arcos
Romania	+40 21 451 20 30	Str. Garii Progresului 2, S4, 040671 RO
Schweiz-Suisse-Svizzera	+41 62 88 99 111	Industriestrasse 10, CH-5506 Mägenwil
Slovenija	+38 61 24 25 731	Tr aška 132, 1000 Ljubljana
Slovensko	+421 2 43 33 43 22	Electrolux Slovakia s.r.o., Electrolux Domáce spotrebiče SK, Seberinoho 1, 821 03 Bratislava
Suomi	www.electrolux.fi	
Sverige	+46 (0)771 76 76 76	Electrolux Service, S:t Göransgatan 143, S-105 45 Stockholm
Türkiye	+90 21 22 93 10 25	Tarlabası caddesi no : 35 Taksim Istanbul
Россия	+7 095 937 7837	129090 Москва, Олимпийский проспект, 16, БЦ «Олимпик»

[www.electrolux.com](http://www.electrolux.com)

[www.aeg-electrolux.uk](http://www.aeg-electrolux.uk)

Subject to change without notice

132 969 060-00-302007

PERFEKT IN FORM UND FUNKTION



## Free Manuals Download Website

<http://myh66.com>

<http://usermanuals.us>

<http://www.somanuals.com>

<http://www.4manuals.cc>

<http://www.manual-lib.com>

<http://www.404manual.com>

<http://www.luxmanual.com>

<http://aubethermostatmanual.com>

Golf course search by state

<http://golfingnear.com>

Email search by domain

<http://emailbydomain.com>

Auto manuals search

<http://auto.somanuals.com>

TV manuals search

<http://tv.somanuals.com>