

PCM-9570/S

Socket 370 Celeron™/Pentium® III
SBC with LCD, Ethernet and SCSI

User's Manual

Copyright notice

This document is copyrighted, 2000. All rights are reserved. The original manufacturer reserves the right to make improvements to the products described in this manual at any time without notice.

No part of this manual may be reproduced, copied, translated or transmitted in any form or by any means without the prior written permission of the original manufacturer. Information provided in this manual is intended to be accurate and reliable. However, the original manufacturer assumes no responsibility for its use, or for any infringements upon the rights of third parties that may result from its use.

Part No. 2006957006
Printed in Taiwan

5th Edition
Feb. 2001

Acknowledgments

AMD is a trademark of Advanced Micro Devices, Inc.

Award is a trademark of Award Software International, Inc.

Cyrix is a trademark of Cyrix Corporation.

IBM, PC/AT, PS/2 and VGA are trademarks of International Business Machines Corporation.

Intel, Celeron, Pentium and Pentium II are trademarks of Intel Corporation.

Microsoft Windows® is a registered trademark of Microsoft Corp.

RTL is a trademark of Realtek Semi-Conductor Co., Ltd.

Symbios is a trademark of Symbios Inc.

Trident is a trademark of Trident Microsystems, Inc.

UMC is a trademark of United Microelectronics Corporation.

Windbond is a trademark of Winbond Electronics Corp.

All other product names or trademarks are properties of their respective owners.

For more information on this and other Advantech products please visit our websites at: **<http://www.advantech.com>**

<http://www.advantech.com/epc>

For technical support and service for please visit our support website at: **<http://support.advantech.com>**

This manual is for the PCM-9570S Rev. B1 & Rev. B2.

Packing list

Before you begin installing your card, please make sure that the following materials have been shipped:

- 1 PCM-9570/S all-in-one single board computer
- 1 CD disc with utility and drivers
- 1 Startup Manual

If any of these items are missing or damaged, contact your distributor or sales representative immediately.

Please refer to Appendix E for the optional interface wiring kit.

Contents

Chapter 1 General Information	1
1.1 Introduction	2
Highly integrated Socket 370 SBC	2
1.2 Features	3
1.3 Specifications	3
Standard SBC functions	3
PCI SVGA/flat panel interface	4
PCI bus Ethernet interface	5
Ultra2 SCSI (PCM-9570S only)	5
Solid state disk	5
PanelLink (optional)	5
Mechanical and environmental	5
1.4 Board layout and dimensions	6
Chapter 2 Installation	7
2.1 Jumpers	8
2.2 Connectors	9
2.3 Locating jumpers	10
2.4 Locating connectors	11
2.4.1 Component side	11
2.4.2 Solder side	12
2.5 Setting jumpers	13
2.6 CPU installation and upgrading	14
2.6.1 Installing a CPU in the ZIF socket	14
2.6.2 CMOS clear (J1)	15
2.6.3 Buzzer enable/disable (J9)	15
2.7 Installing DRAM (SODIMMs)	16
2.7.1 Introduction	16
2.7.2 Installing SODIMMs	16
2.8 IDE hard drive connector (CN11)	16
2.8.1 Connecting the hard drive	17

2.9	Floppy drive connector (CN9)	17
2.9.1	Connecting the floppy drive	18
2.10	Parallel port connector (CN12)	18
2.11	Keyboard and PS/2 mouse connector (CN5)	19
2.12	Front panel connector (CN18)	19
2.12.1	Speaker	19
2.12.2	LED interface	19
2.12.3	Watchdog output	19
2.12.4	Reset switch	20
2.13	Power connectors (FAN1, CN14, CN6)	20
2.13.1	Peripheral power connector, -5 V, -12 V (CN14) ...	20
2.13.2	Main power connector, +5 V, +12 V (CN6)	20
2.13.3	Fan power supply connector (FAN1)	20
2.14	ATX power control connector (CN2, J4)	21
2.14.1	ATX feature connector (CN2) and power button (J4)	21
2.15	ATX power on function select (J11)	22
2.16	IR connector (CN8)	22
2.17	COM-port connector (CN20)	22
2.17.1	COM2 RS-232/422/485 setting (J10)	22
2.17.2	COM3/COM4 RI pin setting (J6)	23
2.18	VGA interface connections	26
2.18.1	CRT display connector (CN15)	26
2.18.2	Flat panel display connector (CN16)	26
2.18.3	Ext. flat panel display connector (CN17)	26
2.18.4	Panel type select (SW1)	27
2.19	Ethernet configuration	28
2.19.1	100Base-T connector (CN1)	28
2.19.2	Network boot	28
2.19.3	LAN controller power select (J12)	28
2.20	Watchdog timer configuration	29
2.20.1	Watchdog timer action (J2)	29
2.21	USB connectors (CN19)	29
2.22	SCSI connectors (CN4)	30
2.23	PanelLink (CN22) (optional)	30

Chapter 3 Software Configuration	31
3.1 Introduction	32
3.2 Ethernet software configuration	33
Chapter 4 Award BIOS Setup	35
4.1 System test and initialization	36
4.1.1 System configuration verification	36
4.2 Award BIOS setup	37
4.2.1 Entering setup	37
4.2.2 Standard CMOS setup	38
4.2.3 BIOS features setup	39
4.2.4 Chipset features setup	40
4.2.5 Power management setup	41
4.2.6 PnP/PCI configuration	42
4.2.7 Integrated peripherals	43
4.2.8 Load BIOS defaults	44
4.2.9 Change password	45
4.2.10 Auto detect hard disk	46
4.2.11 Save & exit setup	46
4.2.12 Exit without saving	46
Chapter 5 PCI SVGA Setup	47
5.1 Introduction	48
5.1.1 Chipset	48
5.1.2 Display memory	48
5.1.3 Display types	48
5.1.4 Dual/simultaneous display	49
5.2 Installation of SVGA driver	50
5.2.1 Installation for Windows 95/98	51
5.2.2 Installation for Windows NT	54
5.3 Further information	57

Chapter 6 SCSI Setup and Configurations .. 59

6.1	Introduction	60
6.2	Before you begin	61
6.3	Basic rules for SCSI host adapter and device installation	61
6.4	Configuring the SCSI adapter	62
6.5	SCSI terminators	63
6.6	SDMS drivers	64
6.7	Utility user's guide and installation instructions	65
6.8	Driver and utility installation	67

Chapter 7 PCI Bus Ethernet Interface 69

7.1	Introduction	70
7.2	Installation of Ethernet driver	70
	7.2.1 Installation for MS-DOS and Windows 3.1	70
	7.2.2 Installation for Windows 95/98	71
	7.2.3 Installation for Windows NT	73
7.3	Further information	75

Appendix A Programming the Watchdog Timer 77

A.1	Programming the watchdog timer	78
------------	---	-----------

Appendix B Installing PC/104 Modules 81

B.1	Installing PC/104 modules	82
------------	--	-----------

Appendix C Pin Assignments 85

C.1	Ethernet 10/100Base-T connector (CN1)	86
C.2	ATX power feature connector (CN2)	86
C.3	SCSI Connector (CN4)	87
C.4	Keyboard and PS/2 mouse connector (CN5)	89
C.5	Main power connector (CN6)	90
C.6	IR connector (CN8)	90
C.7	Floppy drive connector (CN9)	91

C.8	IDE hard drive connector (CN11)	92
C.9	Parallel port connector (CN12)	93
C.10	Backlight connector (CN13)	94
C.11	Peripheral power connector (CN14)	94
C.12	CRT display connector (CN15)	95
C.13	24-bit LCD display connector (CN16)	96
C.14	Ext. LCD display connector (CN17)	97
C.15	LCD signal mapping	98
C.16	Front panel connector (CN18)	99
C.17	USB connectors (CN19)	99
C.18	COM port connector (CN20)	100
C.19	CompactFlash card connector (CN21)	102
C.20	PanelLink connector (CN22)	103
C.21	Fan power connector (FAN1)	104
Appendix D System Assignments		105
D.1	System I/O ports	106
D.2	1st MB memory map	107
D.3	DMA channel assignments	107
D.4	IRQ mapping chart	108
Appendix E Optional Extras		109
E.1	PCM-10586-4 cable kit for PCM-9570/S	110
E.2	USB cable	111
E.3	SCSI cables	111
E.4	24-bit LCD cable adapter	111
Appendix F Mechanical Drawings		113
F.1	Component side	114
F.2	Solder side	115

Tables

Table 2-1: Jumpers	8
Table 2-2: Connectors	9
Table 2-3: CMOS clear (J1)	15
Table 2-4: Buzzer enable/disable (J9)	15
Table 2-5: ATW power on function select (J11)	22
Table 2-6: COM2 RS-232/422/485 setting (J10)	23
Table 2-7: Serial port default settings	23
Table 2-8: COM1 RI pin setting (J6)	24
Table 2-9: COM2 RI pin setting (J6)	24
Table 2-10: COM3 RI pin setting (J6)	25
Table 2-11: COM4 RI pin setting (J6)	25
Table 2-12: Panel type select (SW1)	27
Table 2-13: LAN controller power select (J12)	28
Table 2-14: Watchdog timer action (J2)	29
Table B-1: PC/104 connectors (CN10)	84
Table C-1: Ethernet 10Base-T connector (CN1)	86
Table C-2: ATX power feature connector (CN2)	86
Table C-3: SCSI connector (CN4)	87
Table C-3: SCSI connector (CN4) [continued]	88
Table C-4: Keyboard and mouse connector (CN5)	89
Table C-5: Main power connector (CN6)	90
Table C-6: IR connector (CN8)	90
Table C-7: Floppy drive connector (CN9)	91
Table C-8: IDE hard drive connector (CN11)	92
Table C-9: Parallel port connector (CN12)	93
Table C-10: Backlight connector (CN13)	94
Table C-11: Peripheral power connector (CN14)	94
Table C-12: CRT display connector (CN15)	95
Table C-13: 24-bit LCD display connector (CN16)	96
Table C-14: Ext. LCD display connector (CN17)	97
Table C-15: LCD signal mapping	98
Table C-16: Front panel connector (CN18)	99
Table C-17: USB connectors (CN19)	99
Table C-18: COM port connector (CN20)	100
Table C-19: COM2 port for RS-232, RS-422 and RS-485 (CN20) ...	101

Table C-20: CompactFlash card connector (CN21) 102
Table C-21: PanelLink connector (CN22) 103
Table C-22: Fan power connector (FAN1) 104
Table D-1: System I/O ports 106
Table D-2: 1st MB memory map 107
Table D-3: DMA channel assignments 107
Table D-4: IRQ mapping chart 108

Figures

Figure 1-1: PCM-9570/S dimensions	6
Figure 2-1: Locating jumpers	10
Figure 2-2: Locating connectors (component side)	11
Figure 2-3: Locating connectors (solder side)	12
Figure 2-4: Wiring for ATX power switch function	21
Figure 4-1: Setup program initial screen	37
Figure 4-2: CMOS setup screen	38
Figure 4-3: BIOS features setup	39
Figure 4-4: Chipset features setup	40
Figure 4-5: Power management setup	41
Figure 4-6: PnP/PCI configuration	42
Figure 4-7: Integrated peripherals	43
Figure 4-8: Load BIOS defaults	44
Figure 4-9: IDE HDD auto detection screen	49
Figure 5-1: Selecting display settings	77
Figure B-1: PC/104 module mounting diagram	83
Figure B-2: PC/104 module dimensions (mm) (± 0.1)	83
Figure F-1: PCM-9570/S mechanical drawing - component side	114
Figure F-2: PCM-9570/S mechanical drawing - solder side	115

CHAPTER 1

General Information

This chapter gives background information on the PCM-9570/S.

Sections include:

- Introduction
- Features
- Specifications
- Board layout and dimensions

1.1 Introduction

The PCM-9570/S is an all-in-one Celeron™/Pentium® III level single board computer (SBC) with an Ultra2 SCSI controller (PCM-9570S), a 2x AGP LCD controller, a PCI Fast Ethernet interface and one PCI expansion slot. With the Intel Celeron™ processor, the PCM-9570/S achieves outstanding performance that surpasses any other SBC in its class. This compact unit is only 203 x 146 mm (8" x 5.75"). It offers all the functions of a single board industrial computer, but still fits in the space of a 5.25" floppy drive.

On-board features include four serial ports (three RS-232, one RS-232/422/485), one multi-mode parallel (ECP/EPP/SPP) port, two USB (Universal Serial Bus) ports, one infrared port (SIR), one CompactFlash socket for CFC, a floppy drive controller, and a keyboard/PS/2 mouse interface. The built-in high-speed PCI IDE controller supports PIO, UDMA/33 and bus master modes. Up to two IDE devices can be connected, including large hard disks, CD-ROM drives and tape backup drives.

The PCM-9570/S features power management to minimize power consumption. It complies with the "Green Function" standard and supports doze, standby and suspend modes. In addition, the board's watchdog timer can automatically reset the system or generate an interrupt in case the system stops due to a program bug or EMI.

The PCM-9570/S has been certified as complying with FCC Class A and CE Marking Class A.

Highly integrated Socket 370 SBC

The PCM-9570/S is a highly integrated SBC that combines Ultra2 SCSI, PanelLink, and network functions on a single computer board the size of a 5.25" floppy drive. Major on-board devices adopt PCI technology to achieve outstanding computing performance when used with Intel® Celeron™/Pentium® III processors, making the PCM-9570/S the world's smallest and most powerful all-in-one Socket 370 board.

1.2 Features

- **Ultra2 SCSI interface:** Supports up to 80 MB/sec transfer rates (PCM-9570S only)
- **3D VGA/LCD interface:** Supports a 2x AGP interface, 3D 64-bit engine, as well as a 2.5 MB embedded Trident 9525 DVD chip
- **Display resolution:** Up to 1024 x 768 @ 64 K colors, for both LCD and CRT displays
- **PanelLink (optional):** Scalable bandwidth of 25 ~ 112 MHz (VGA 640 x 480 ~ SXGA 1280 x 1024)
- **100 MHz FSB design:** To facilitate future upgrading to Pentium® III
- **Wake on LAN; modem**

1.3 Specifications

Standard SBC functions

- **CPU:** Socket 370 for Intel® Celeron™ processors up to 733 MHz or higher in the future (Rev. A); Socket 370 for Intel® Pentium® III processors up to 700 MHz for Rev. B1 and up to 850 MHz for Rev. B2.
- **BIOS:** Award 256 KB Flash BIOS, supports Plug & Play, APM
- **Chipset:** Intel 440BX
- **Green function:** APM 1.1 compliant
- **2nd level cache:** 128 KB on the Celeron™ processor; 256 KB on the Pentium® III processor
- **RAM:** Two 144-pin SODIMM sockets accept 8 ~ 256 MB SDRAM
- **Enhanced IDE interface:** Primary channel for 2 IDE devices. Secondary channel for CompactFlash card
- **FDD interface:** Supports up to two FDDs (360 KB/1.2 MB/ 720 KB/1.44 MB/2.88 MB)

- **Serial ports:** Four serial ports with +5 V / +12 V power capability (COM1, 3, 4: RS-232; and COM2: RS-232/422/485)
- **Watchdog timer:** Software enabled/disabled. 62-level interval from 1 to 62 seconds. Jumperless selection. Generates system reset or IRQ11
- **Keyboard/mouse connector:** 8-pin header connector for keyboard and PS/2 mouse
- **USB interface:** Two USB connectors with fuse protection. Complies with USB Spec. Rev. 1.0
- **Infrared port:** Supports up to 115 Kbps transfer rates
- **PC/104 expansion:** 104-pin 16-bit PC/104 module connector
- **I/O bus expansion:** One 32-bit PCI bus expansion slot

PCI SVGA/flat panel interface

- **Chipset:** Trident Cyber 9525 DVD, high performance 64-bit GUI, 3D engine
- **Display memory:** 2.5 MB of SDRAM frame buffer on cyber 9525DVD. 4 MB SDRAM frame buffer on Trident TM9540 (optional)
- **Display type:** Simultaneously supports CRT and flat panel (EL, LCD and gas plasma) displays
- **Interface:** 2x AGP, Accelerator Graphics Ports 1.0 compliant
- **Display mode:**

LCD panel supports up to 800 x 600 @ 24 bpp, 1024 x 768 @ 24 bpp.

CRT displays support up to 800 x 600 @ 24 bpp, 1024 x 768 @ 24 bpp

PCI bus Ethernet interface

- **Chipset:** Realtek RTL8139 PCI-bus Ethernet controller
- **Ethernet interface:** PCI 100/10 Mbps, IEEE 802.3U compatible
- **Remote boot ROM:** For diskless system

Ultra2 SCSI (PCM-9570S only)

- **Chipset:** SYM 53C895 chips
- **Performance:** Ultra2 SCSI interface, up to 80 MB/sec transfer rates

Solid state disk

- **One 50-pin socket:** For one CompactFlash card, shared with one IDE channel

PanelLink (optional)

- **Chipset:** Sil 154 Panel Link Digital Transmitter
- **Scalable band width:** Ranging from 25 ~ 112 MHz (VGA ~ SXGA)
- **24/48-bit one/two pixel per clock**

Mechanical and environmental

- **Power requirements:** 5.2 A @ 5 V (4.75 to 5.25) (typical); 4.9 A @ 5 V with Celeron™ 466 and 128 MB SODIMM
- **Operating temperature:** 0 ~ 60° C (32 ~ 140° F)
- **Size (L x W):** 203 x 146 mm (8" x 5.75")
- **Weight:** 0.32 kg (0.7 lb)

1.4 Board layout and dimensions

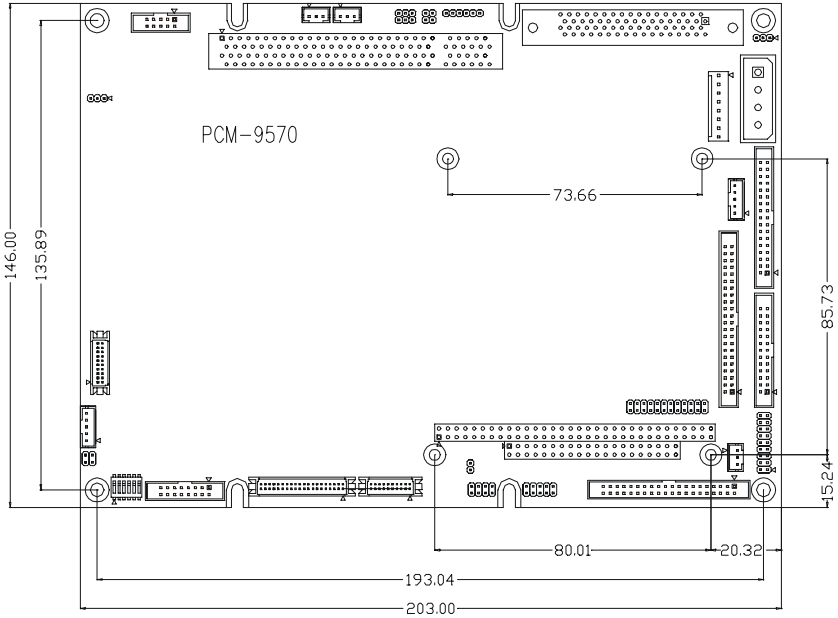

Figure 1-1: PCM-9570/S dimensions

CHAPTER 2

Installation

This chapter tells how to set up the PCM-9570/S hardware, including instructions on setting jumpers and connecting peripherals, switches and indicators. Be sure to read all the safety precautions before you begin the installation procedure.

2.1 Jumpers

The PCM-9570/S has a number of jumpers that allow you to configure your system to suit your application. The table below lists the function of each of the board's jumpers:

Table 2-1: Jumpers

Label	Function
J1	CMOS clear
J2	Watchdog timer action
J3	SCSI terminator power enable/disable
J4	ATX power switch button
J6	COM port RI pin setting
J7	PanelLink control
J9	Buzzer enable/disable
J10	COM2 RS-232/422/485 setting
J11	ATX power on function select
J12	LAN controller power select
SW1	Panel type select

2.2 Connectors

On-board connectors link the PCM-9570/S to external devices such as hard disk drives, a keyboard, or floppy drives. The table below lists the function of each of the board's connectors:

Table 2-2: Connectors

Label	Function
CN1	Ethernet 100/10Base-T connector
CN2	ATX feature connector
CN4	SCSI connector
CN5	Keyboard and PS/2 mouse connector
CN6	Main power connector
CN8	IR connector
CN9	Floppy drive connector
CN10	PC/104 ISA-bus expansion
CN11	IDE hard drive connector
CN12	Parallel port connector
CN13	Backlight connector
CN14	Peripheral power connector
CN15	CRT display connector
CN16	Flat panel connector
CN17	Ext. flat panel display connector
CN18	Front panel connector
CN19	USB channel 1, 2 connector
CN20	COM-port connector
CN21	CFC connector
CN22	PanelLink connector
FAN1	Fan power connector

Please refer to Appendix C for pin assignments.

2.3 Locating jumpers

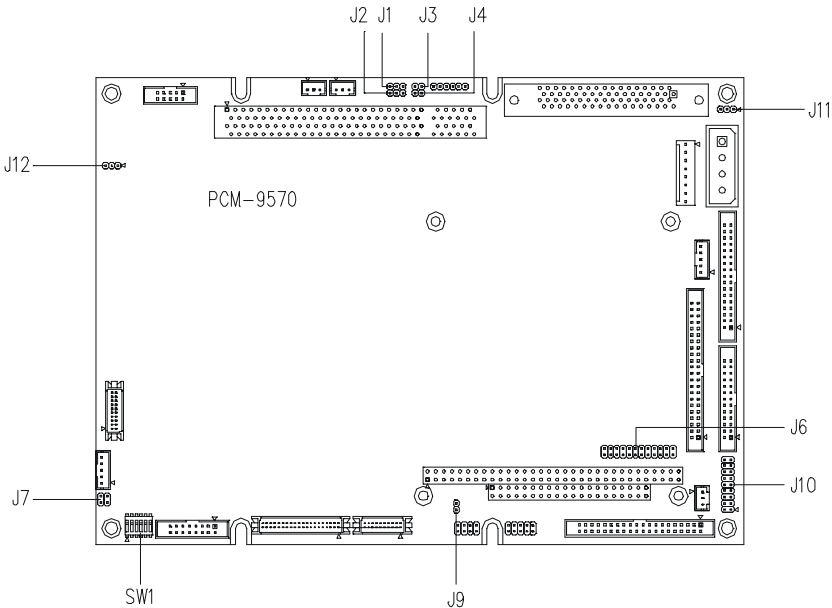

Figure 2-1: Locating jumpers

2.4 Locating connectors

2.4.1 Component side

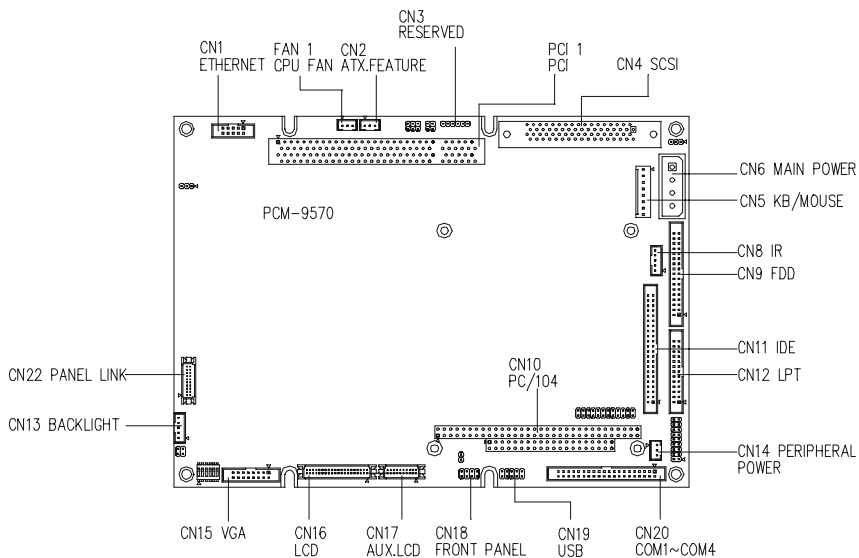

Figure 2-2: Locating connectors (component side)

2.4.2 Solder side

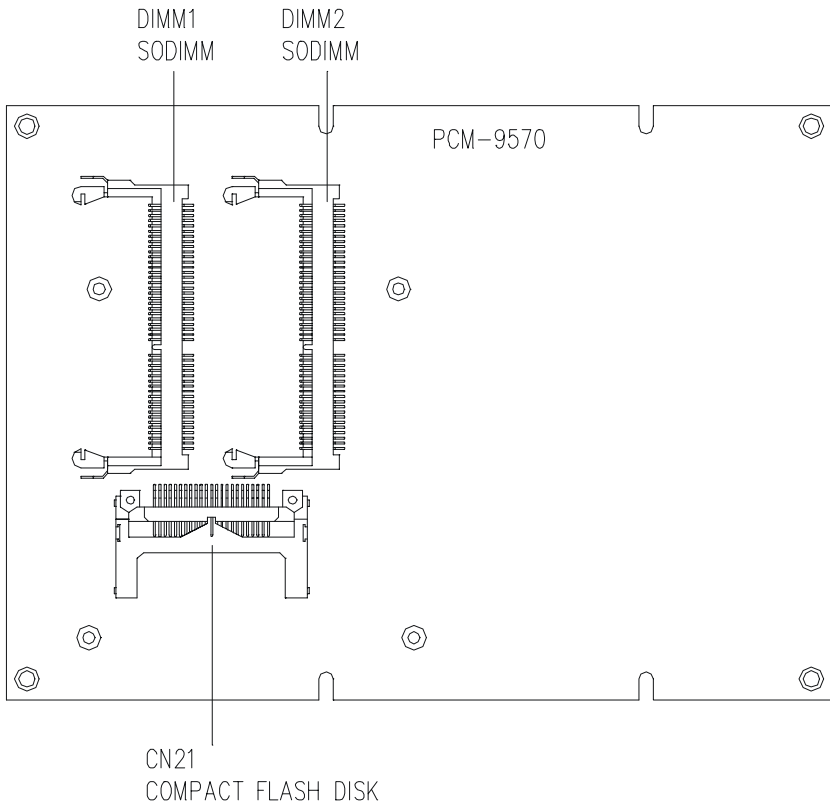
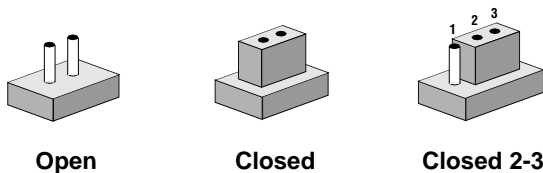

Figure 2-3: Locating connectors (solder side)

2.5 Setting jumpers

You configure your card to match the needs of your application by setting jumpers. A jumper is the simplest kind of electric switch. It consists of two metal pins and a small metal clip (often protected by a plastic cover) that slides over the pins to connect them. To “close” a jumper you connect the pins with the clip. To “open” a jumper you remove the clip. Sometimes a jumper will have three pins, labeled 1, 2, and 3. In this case you would connect either pins 1 and 2 or 2 and 3.



The jumper settings are schematically depicted in this manual as follows:

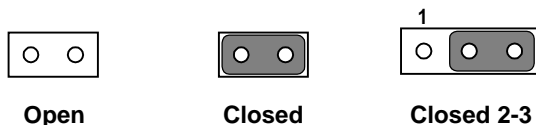

A pair of needle-nose pliers may be helpful when working with jumpers.

If you have any doubts about the best hardware configuration for your application, contact your local distributor or sales representative before you make any changes.

Generally, you simply need a standard cable to make most connections.

2.6 CPU installation and upgrading

You can upgrade to a higher power Pentium processor at any time. Simply remove the old CPU, install the new one, and set the jumpers for the new CPU type and speed.

Warning! *Always disconnect the power cord from your chassis when you are working on it. Do not make connections while the power is on as sensitive electronic components can be damaged by the sudden rush of power. Only experienced electronics personnel should open the PC chassis.*



Caution! *Always ground yourself to remove any static charge before touching the PC board. Modern electronic devices are very sensitive to static electric charges. Use a grounding wrist strap at all times. Place all electronic components on a static-dissipative surface or in a static-shielded bag when they are not in the chassis.*



2.6.1 Installing a CPU in the ZIF socket

The PCM-9570/S provides a Zero Insertion Force (ZIF) socket for easy CPU installation.

1. Make sure the ZIF socket lever is in the upright position. To raise the lever, pull it out to the side a little and raise it as far as it will go.
2. Place the CPU in the empty socket. Follow the instructions that came with the CPU. If you have no instructions, do the following: Carefully align the CPU so it is parallel to the socket and the notch on the corner of the CPU corresponds with the notch on the inside of the socket. Gently slide the CPU in. It should insert easily. If it doesn't, pull the lever up a little more.
3. Press the lever down. The plate will slide forward. You will feel some resistance as the pressure starts to secure the CPU in the socket. This is normal and will not damage the CPU.

When the CPU is installed, the lever should snap into place at the side of the socket.

Note: To remove a CPU, pull the lever out to the side a little and raise it as far as it will go. Lift out the CPU chip.

2.6.2 CMOS clear (J1)

Warning: To avoid damaging the computer, always turn off the power supply before setting "Clear CMOS." Set the jumper back to "3V Battery On" before turning on the power supply.

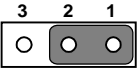
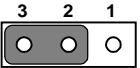

Table 2-3: CMOS clear (J1)

	* 3 V battery on	Clear CMOS
J1		

* default setting

2.6.3 Buzzer enable/disable (J9)

Table 2-4: Buzzer enable/disable (J9)

	* Enabled	Disabled
J9		

* default setting

2.7 Installing DRAM (SODIMMs)

2.7.1 Introduction

You can install anywhere from 16 MB to 128 MB of on-board DRAM memory using 16, 32, 64 or 128 MB 144-pin SODIMMs (Small Outline Dual In-Line Memory Modules).

2.7.2 Installing SODIMMs

Note: The modules can only fit into a socket one way and their gold pins must point down into the SODIMM socket.

The procedure for installing SODIMMs appears below. Please follow these steps carefully.

1. Ensure that all power supplies to the system are switched Off.
2. Install the SODIMM card. Install the SODIMM so that its gold pins point down into the SODIMM socket.
3. Slip the SODIMM into the socket at a 45 degree angle and carefully fit the bottom of the card against the connectors.
4. Gently push the SODIMM into a perpendicular position until the clips on the ends of the SODIMM sockets snap into place.
5. Check to ensure that the SODIMM is correctly seated and all connector contacts touch. The SODIMM should not move around in its socket.

2.8 IDE hard drive connector (CN11)

You can attach one or two Enhanced Integrated Device Electronics hard disk drives to the PCM-9570/S's internal controller. The PCM-9570/S's IDE controller uses a PCI local-bus interface. This advanced IDE controller supports faster data transfer, PIO mode 3, mode 4.

2.8.1 Connecting the hard drive

Connecting drives is done in a daisy-chain fashion and requires one of two cables (not included in this packing), depending on the drive size. 1.8" and 2.5" drives need a 1 x 44-pin to 2 x 44-pin flat-cable connector. 3.5" drives use a 1 x 44-pin to 2 x 40-pin connector.

Wire number 1 on the cable is red or blue, and the other wires are gray.

1. Connect one end of the cable to CN11. Make sure that the red (or blue) wire corresponds to pin 1 on the connector, which is labeled on the board (on the right side).
2. Plug the other end of the cable to the Enhanced IDE hard drive, with pin 1 on the cable corresponding to pin 1 on the hard drive. (See your hard drive's documentation for the location of the connector.)

Connect a second drive as described above.

Unlike floppy drives, IDE hard drives can connect to either end of the cable. If you install two drives, you will need to set one as the master and one as the slave by using jumpers on the drives. If you install just one drive, set it as the master.

2.9 Floppy drive connector (CN9)

You can attach up to two floppy drives to the PCM-9570/S's on-board controller. You can use any combination of 5.25" (360 KB and 1.2 MB) and/or 3.5" (720 KB, 1.44 MB, and 2.88 MB) drives.

A 34-pin daisy-chain drive connector cable is required for a dual-drive system. On one end of the cable is a 34-pin flat-cable connector. On the other end are two sets of floppy disk drive connectors. Each set consists of a 34-pin flat-cable connector (usually used for 3.5" drives) and a printed-circuit board connector (usually used for 5.25" drives).

2.9.1 Connecting the floppy drive

1. Plug the 34-pin flat-cable connector into CN9. Make sure that the red wire corresponds to pin one on the connector.
2. Attach the appropriate connector on the other end of the cable to the floppy drive(s). You can use only one connector in the set. The set on the end (after the twist in the cable) connects to the A: drive. The set in the middle connects to the B: drive.
3. If you are connecting a 5¼" floppy drive, line up the slot in the printed circuit board with the blocked-off part of the cable connector.

If you are connecting a 3½" floppy drive, you may have trouble determining which pin is pin number one. Look for a number printed on the circuit board indicating pin number one. In addition, the connector on the floppy drive connector may have a slot. When the slot is up, pin number one should be on the right. Check the documentation that came with the drive for more information.

If you desire, connect the B: drive to the connectors in the middle of the cable as described above.

If you need to make your own cable, you can find the pin assignments for the board's connector in Appendix C.

2.10 Parallel port connector (CN12)

Normally, the parallel port is used to connect the card to a printer. The PCM-9570/S includes a multi-mode (ECP/EPP/SPP) parallel port, accessed through CN12, a 26-pin flat-cable connector. You will need an adapter cable if you use a traditional DB-25 connector. The adapter cable has a 26-pin connector on one end and a DB-25 connector on the other.

The parallel port is designated as LPT1 and can be disabled or changed to LPT2 or LPT3 in the system BIOS setup.

The parallel port interrupt channel is designated to be IRQ7.

You can select ECP/EPP DMA channel via BIOS setup.

2.11 Keyboard and PS/2 mouse connector (CN5)

The PCM-9570/S board provides a keyboard connector that supports both a keyboard and a PS/2 style mouse. In most cases, especially in embedded applications, a keyboard is not used. The standard PC/AT BIOS will report an error or fail during power-on self-test (POST) after a reset if the keyboard is not present. The PCM-9570/S's BIOS standard setup menu allows you to select "All, But Keyboard" under the "Halt On" selection. This allows no-keyboard operation in embedded system applications without the system halting under POST (power-on-self-test).

2.12 Front panel connector (CN18)

Next, you may want to install external switches to monitor and control the PCM-9570/S. These features are optional - install them only if you need them. The front panel connector (CN18) is an 8-pin male, dual in-line header and provides connections for a speaker, hard disk access indicator, watchdog output and an input switch for resetting the card.

2.12.1 Speaker

The PCM-9570/S can drive an 8 Ω speaker at 0.5 watts. Make sure that alternatives to this specification do not overload the card.

2.12.2 LED interface

The front panel LED indicator for hard disk access is an active low signal (24 mA sink rate).

2.12.3 Watchdog output

When PCM-9570/S watchdog timer times out, the front panel pin 6 will output an active low pulse signal (25mA sink rate for 1 second).

2.12.4 Reset switch

If you install a reset switch, it should be an open single pole switch. Momentarily pressing the switch will activate a reset. The switch should be rated for 10 mA, 5 V.

If you need to make your own cable, you can find the pin assignments for the board's connector in Appendix C.

2.13 Power connectors (FAN1, CN14, CN6)

2.13.1 Peripheral power connector, -5 V, -12 V (CN14)

Supplies secondary power to devices that require -5 V and -12 V.

2.13.2 Main power connector, +5 V, +12 V (CN6)

Supplies main power to the PCM-9570/S (+5 V) and devices that require +12 V.

2.13.3 Fan power supply connector (FAN1)

Provides power supply to optional CPU cooling fan. Only present when +5 V and +12 V power is supplied to the board.

2.14 ATX power control connector (CN2, J4)

2.14.1 ATX feature connector (CN2) and power button (J4)

The PCM-9570/S can support an advanced power button if an ATX power supply is used. To enable the power button:

1. Take the specially designed optional ATX-to-PS/2 power cable (part no. 1703200201).
2. Connect the 3-pin plug of the cable to CN2 (ATX feature connector).
3. Connect the power on/off button to J4. (A momentary type of button should be used.)

Important: *Be sure that the ATX power supply can take at least a 10 mA load on the 5 V standby lead (5VSB). If not, you may have difficulty powering on your system.*

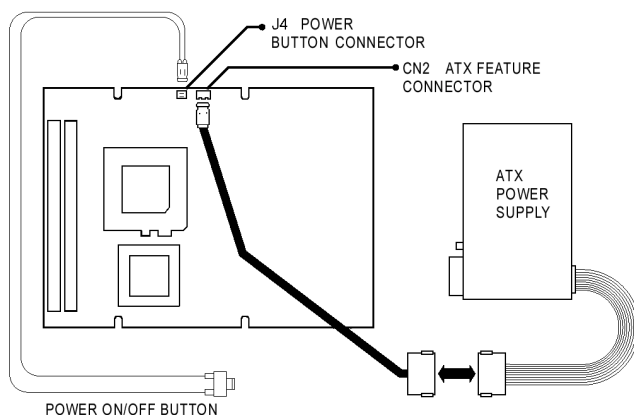



Figure 2-4: Wiring for ATX power switch function

2.15 ATX power on function select (J11)

TABLE	2-5:	ATX	POWER	ON	FUNCTION	SELECT	(J11)
					Default on		Default off *
					3 2 1		3 2 1
J11							

* default setting

Note1: J11 select 1-2, that while AC power is turned on, the system cannot boot up without ATX power switch button J4.

Note2: J11 select 2-3, that while AC power is turned on, the cannot boot up without ATX power switch button J4.

2.16 IR connector (CN8)

The PCM-9570/S provides an IrDA port for transfer rates of 115 Kbps. This connector supports the optional wireless infrared transmitting and receiving module. This module mounts on the system case. You must configure the setting through BIOS setup.

2.17 COM-port connector (CN20)

The PCM-9570/S provides four serial ports (COM1, 3, 4: RS-232; COM2: RS-232/422/485) in one COM port connector. The COM port connector is a 40-pin, dual-in-line, male header and provides connections for serial devices (a mouse, etc.) or a communication network. You can find the pin assignments for the COM port connector in Appendix C.

2.17.1 COM2 RS-232/422/485 setting (J10)

COM2 can be configured to operate in RS-232, RS-422, or RS-485 mode. This is done via J10.

Table 2-6: COM2 RS-232/422/485 setting (J10)

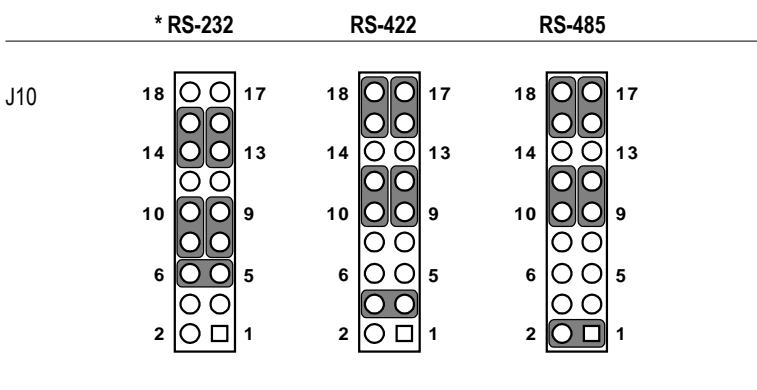

* default setting

The IRQ and the address range for COM1, 2, 3, 4 are fixed. However, if you wish to disable the port or change these parameters later you can do this in the system BIOS setup. The table below shows the settings for the PCM-9570/S's serial ports.

Table 2-7: Serial port default settings

Port	Address range	Interrupt
COM1	3F8 ~ 3FF	IRQ4
COM2	2F8 ~ 2FF	IRQ3
COM3	3E8 ~ 3EF	IRQ10
COM4	2E8 ~ 2EF	IRQ5

2.17.2 COM3/COM4 RI pin setting (J6)

COM1 through COM4 can supply +5 V or +12 V power to the serial devices via the RI pin of the COM port connector. The outputs of the COM1 ~ COM4 RI pins are selected by setting J6.

Table 2-8: COM1 RI pin setting (J6)

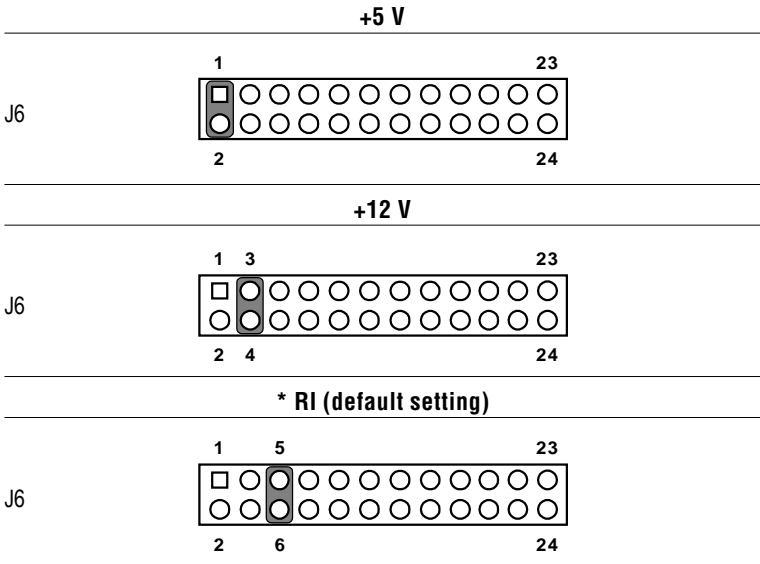

Table 2-9: COM2 RI pin setting (J6)

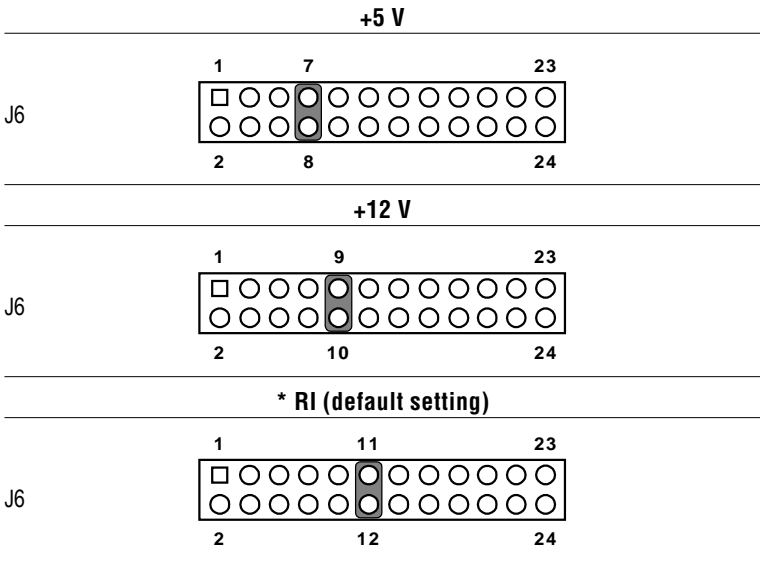

Table 2-10: COM3 RI pin setting (J6)

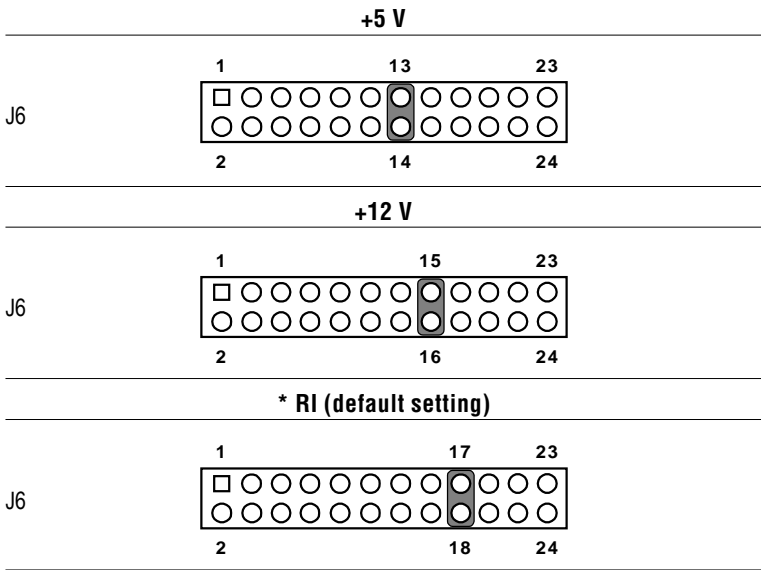
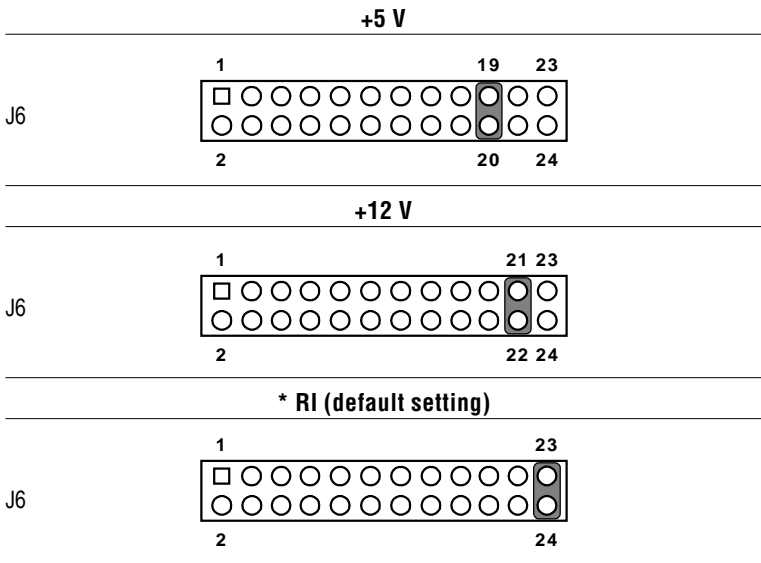

Table 2-11: COM4 RI pin setting (J6)



2.18 VGA interface connections

The PCM-9570/S's PCI SVGA interface can drive conventional CRT displays and is capable of driving a wide range of flat panel displays, including electroluminescent (EL), gas plasma, passive LCD and active LCD displays. The board has two connectors to support these displays, one for standard CRT VGA monitors and one for flat panel displays.

2.18.1 CRT display connector (CN15)

CN15 is a 16-pin, dual-in-line header used for conventional CRT displays. A simple one-to-one adapter can be used to match CN15 to a standard 15-pin D-SUB connector commonly used for VGA.

Pin assignments for CRT display connector CN15 are detailed in Appendix C.

2.18.2 Flat panel display connector (CN16)

CN16 is a 40-pin connector which can support a 24-bit TFT LCD. It is Hirose's product no. DF13A-40DP-1.25V.

The PCM-9570/S provides a bias control signal on CN16 that can be used to control the LCD bias voltage. It is recommended that the LCD bias voltage not be applied to the panel until the logic supply voltage (+5 V or +3.3 V) and panel video signals are stable. Under normal operation, the control signal (ENAVEE) is active high. When the PCM-9570/S's power is applied, the control signal is low until just after the relevant flat panel signals are present.

2.18.3 Ext. flat panel display connector (CN17)

CN17 consists of a 20-pin header, which is Hirose's product no. DF13A-20DP-1.25V. The PCM-9570/S supports a 36-bit LCD panel with connections to both CN16 and CN17. For details of pin assignments, refer to Appendix C.

2.18.4 Panel type select (SW1)

SW1 is a 6-pin dip switch for selecting the type of panel and display mode.

Table 2-12: Panel type select (SW1)

Panel type	Pin 1	Pin 2	Pin 3	Pin 4	Pin 5	Pin 6
TFT 640 x 480 18-bit	OFF	ON	ON	ON	ON	-
TFT 800 x 600 18-bit	OFF	OFF	ON	ON	ON	-
TFT 1024 x 768 24-bit	OFF	ON	OFF	ON	ON	-
TFT 1024 x 768 36-bit	OFF	OFF	OFF	ON	ON	-
STN 640 x 480 16-bit	OFF	ON	ON	ON	OFF	-
STN 800 x 600 16-bit	OFF	OFF	ON	ON	OFF	-
STN 1024 x 768 16-bit	OFF	ON	OFF	ON	OFF	-
STN 1024 x 768 24-bit	OFF	OFF	OFF	ON	OFF	-
Default setting	ON	ON	ON	ON	ON	ON

Note 1: If the Pin 1 of SW1 is in the ON position, the LCD is disconnected.

Note 2: Pin 6 is reserved for PanelLink setting.

2.19 Ethernet configuration

The PCM-9570/S is equipped with a high performance 32-bit PCI-bus Ethernet interface which is fully compliant with IEEE 802.3U 10/100Mbps CSMA/CD standards. It is supported by all major network operating systems.

The medium type can be configured via the RSET8139.EXE program included on the utility disk. (See Chapter 3 for detailed information.)

2.19.1 100Base-T connector (CN1)

100Base-T connects to the PCM-9570/S via an adapter cable to a 10-pin polarized header (CN1). For 10Base-T RJ-45 operation, an adapter cable converting CN1 into a standard RJ-45 jack is required.

2.19.2 Network boot

The Network Boot feature can be utilized by incorporating the Boot ROM image files for the appropriate network operating system. The Boot ROM BIOS files are on the included utility disk.

2.19.3 LAN controller power select (J12)

Table 2-13: LAN controller power select (J12)



*default setting

Note: PCM-9570/S supports wake-on LAN. For wake-on LAN, J12 has to select standby 5 V (2-3) position.

2.20 Watchdog timer configuration

An on-board watchdog timer reduces the chance of disruptions which EMP (electro-magnetic pulse) interference can cause. This is an invaluable protective device for standalone or unmanned applications. Setup involves one jumper and running the control software (refer to Appendix A).

2.20.1 Watchdog timer action (J2)

When the watchdog timer activates (CPU processing has come to a halt), it can reset the system or generate an interrupt on IRQ11. This can be set via setting J2 as shown below:

Table 2-14: Watchdog timer action (J2)

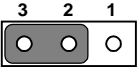
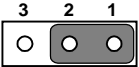
	* System reset	IRQ11
J2		

* default setting

2.21 USB connectors (CN19)

The PCM-9570/S board provides two USB (Universal Serial Bus) interfaces which gives complete plug and play, hot attach/detach for up to 127 external devices. The USB interfaces comply with USB specification rev. 1.0 and are fuse protected.

The USB interfaces are accessed through two 4-pin flat-cable connectors, CN19. You will need an adapter cable if you use a standard USB connector. The adapter cable has a 4-pin connector on one end and an USB connector on the other.

The USB interfaces can be disabled in the system BIOS setup.

2.22 SCSI connectors (CN4)

The PCM-9570/S has a 68-pin D-sub connector for Ultra2 SCSI devices. Connection of SCSI devices requires special attention, especially when determining the last drive on the SCSI chain. Refer to Chapter 6 and your device's operating manual for detailed installation information.

2.23 Panellink (CN22) (optional)

The PCM-9570/S optional Panellink function uses Silicon Image Inc.'s Universal Transmitter SiI150 chip. It can support 25 ~ 112 MHz clock speeds, for VGA through to SXGA LCD panels. The 20-pin Panellink transmitter connector is Hirose Electric Co., Ltd.'s product no. DF13A-20DP-1.25V.

Software Configuration

This chapter details the software configuration information. It shows you how to configure the card to match your application requirements. AWARD System BIOS is covered in Chapter 4.

Sections include:

- Introduction
- Ethernet interface configuration

3.1 Introduction

The PCM-9570/S system BIOS and custom drivers are located in a 256 Kbyte, 32-pin (JEDEC spec.) Flash ROM device, designated U15. A single Flash chip holds the system BIOS, VGA BIOS, and network Boot ROM image. The display can be configured via CMOS settings. This method minimizes the number of chips and difficulty of configuration. To set different types of LCD panels please choose “panel type” from the “Intergrated Peripherals” menu in CMOS setup.

3.2 Ethernet software configuration

The PCM-9570/S's on-board Ethernet interface supports all major network operating systems. To configure the medium type, to view the current configuration, or to run diagnostics, do the following:

1. Power the PCM-9570/S on. Make sure that the RSET8139.EXE file is located in the working drive.
2. At the prompt, type RSET8139.EXE and press <Enter>. The Ethernet configuration program will then be displayed.
3. This simple screen shows all the available options for the Ethernet interface. Just highlight the option you wish to change by using the Up and Down keys. To change a selected item, press <Enter>, and a screen will appear with the available options. Highlight your option and press <Enter>. Each highlighted option has a helpful message guide displayed at the bottom of the screen for additional information.
4. After you have made your selections and are sure this is the configuration you want, press ESC. A prompt will appear asking if you want to save the configuration. Press Y if you want to save.

The Ethernet Setup Menu also offers three very useful diagnostic functions. These are:

1. Run EEPROM test
2. Run Diagnostics on Board
3. Run Diagnostics on Network

Each option has its own display screen that shows the format and result of any diagnostic tests undertaken.

Note: For Ethernet installation, please see Chapter 7.

CHAPTER
4

Award BIOS Setup

This chapter describes how to set BIOS configuration data.

4.1 System test and initialization

These routines test and initialize board hardware. If the routines encounter an error during the tests, you will either hear a few short beeps or see an error message on the screen. There are two kinds of errors: fatal and non-fatal. The system can usually continue the boot up sequence with non-fatal errors. Non-fatal error messages usually appear on the screen along with the following instructions:

```
press <F1> to RESUME
```

Write down the message and press the F1 key to continue the bootup sequence.

4.1.1 System configuration verification

These routines check the current system configuration against the values stored in the board's CMOS memory. If they don't match, the program outputs an error message. You will then need to run the BIOS setup program to set the configuration information in memory.

There are three situations in which you will need to change the CMOS settings:

1. You are starting your system for the first time
2. You have changed the hardware attached to your system
3. The CMOS memory has lost power and the configuration information has been erased.

The PCM-9570/S's CMOS memory has an integral lithium battery backup. The battery backup should last ten years in normal service, but when it finally runs down, you will need to replace the complete unit.

4.2 Award BIOS setup

Award's BIOS ROM has a built-in Setup program that allows users to modify the basic system configuration. This type of information is stored in battery-backed CMOS RAM so that it retains the Setup information when the power is turned off.

4.2.1 Entering setup

Power on the computer and press immediately. This will allow you to enter Setup.

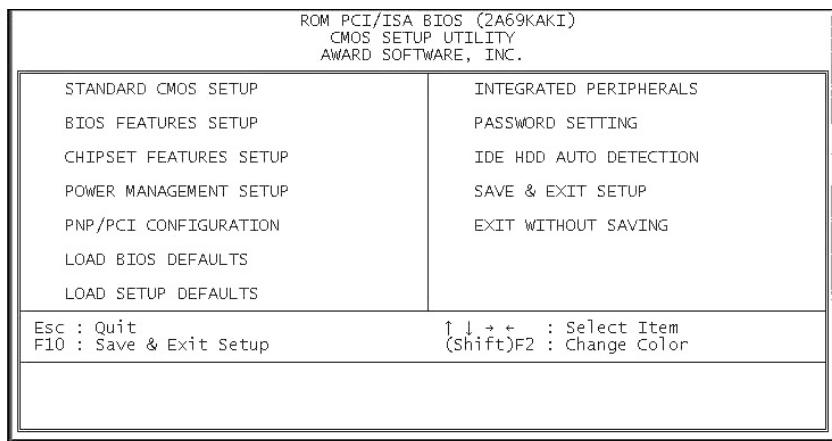

Figure 4-1: Setup program initial screen

4.2.2 Standard CMOS setup

When you choose the STANDARD CMOS SETUP option from the INITIAL SETUP SCREEN menu, the screen shown below is displayed. This standard Setup Menu allows users to configure system components such as date, time, hard disk drive, floppy drive and display. Once a field is highlighted, on-line help information is displayed in the left bottom of the Menu screen.

```
ROM PCI/ISA BIOS (2A69KAKI)
STANDARD CMOS SETUP
AWARD SOFTWARE, INC.

Date (mm:dd:yy) : Thu, Sep 16 1999
Time (hh:mm:ss) : 9 : 38 : 2

HARD DISKS          TYPE      SIZE  CYLS  HEAD  PRECOMP  LANDZ  SECTOR  MODE
-----
Primary Master    :    0      0      0    0      0      0      0  NORMAL
Primary Slave     :    0      0      0    0      0      0      0  NORMAL
Secondary Master  :    0      0      0    0      0      0      0  NORMAL

Drive A : None
Drive B : None

Video  : EGA/VGA
Halt On : All Errors

ESC : Quit
F1  : Help

↑ ↓ → ← : Select Item
(Shift)F2 : Change Color

PU/PD/+/- : Modify
```

Figure 4-2: CMOS setup screen

4.2.3 BIOS features setup

By choosing the BIOS FEATURES SETUP option from the INITIAL SETUP SCREEN menu, the screen below is displayed. This sample screen contains the manufacturer's default values for the PCM-9570/S.

ROM PCI/ISA BIOS (2A69KAKI)			
BIOS FEATURES SETUP			
AWARD SOFTWARE, INC.			
Virus Warning	: Enabled	Video BIOS Shadow	: Disabled
CPU Internal Cache	: Disabled	C8000-CBFFF Shadow	: Disabled
External Cache	: Disabled	CC000-CFFFF Shadow	: Disabled
CPU L2 Cache ECC Checking	: Enabled	D0000-D3FFF Shadow	: Disabled
Processor Number Feature	: Enabled	D4000-D7FFF Shadow	: Disabled
Quick Power On Self Test	: Disabled	D8000-DBFFF Shadow	: Disabled
Boot From LAN First	: Disabled	DC000-DFFFF Shadow	: Disabled
Boot Sequence	: A,C,SCSI		
Swap Floppy Drive	: Disabled		
Boot Up Floppy Seek	: Disabled		
Boot Up NumLock Status	: Off		
Gate A20 Option	: Normal		
Typematic Rate Setting	: Disabled		
Typematic Rate (Chars/Sec)	: 6		
Typematic Delay (Msec)	: 250		
Security Option	: Setup	ESC : Quit	↑↓+/- : Select Item
PS/2 mouse function control	: Disabled	F1 : Help	PU/PD/+/- : Modify
PCI/VGA Palette Snoop	: Disabled	F5 : Old Values	(Shift)F2 : Color
OS Select For DRAM > 64MB	: Non-OS2	F6 : Load BIOS Defaults	
Report No FDD For WIN 95	: No	F7 : Load Setup Defaults	

Figure 4-3: BIOS features setup

4.2.4 Chipset features setup

By choosing the CHIPSET FEATURES SETUP option from the INITIAL SETUP SCREEN menu, the screen below is displayed. This sample screen contains the manufacturer's default values for the PCM-9570/S.

ROM PCI/ISA BIOS (2A69KAKI) CHIPSET FEATURES SETUP AWARD SOFTWARE, INC.	
Auto Configuration	: Disabled
EDO CAS# MA Wait State	: 1
EDO RAS# Wait State	: 1
SDRAM RAS-to-CAS Delay	: 3
SDRAM RAS Precharge Time	: 3
SDRAM CAS latency Time	: 2
SDRAM Precharge Control	: Disabled
DRAM Data Integrity Mode	: Non-ECC
System BIOS Cacheable	: Disabled
Video BIOS Cacheable	: Disabled
Video RAM Cacheable	: Disabled
8 Bit I/O Recovery Time	: NA
16 Bit I/O Recovery Time	: NA
Memory Hole At 15M-16M	: Disabled
Passive Release	: Disabled
Delayed Transaction	: Disabled
AGP Aperture Size (MB)	: 4
Power-Supply Type	: AT
Auto Detect DIMM/PCI Clk	: Enabled
Spread Spectrum	: Disabled
CPU Host Clock (CPU/PCI)	: Default
CPU Warning Temperature	: Disabled
Current CPU Temperature	:
ESC	: Quit
F1	: Help
F5	: Old Values (Shift)
F6	: Load BIOS Defaults
F7	: Load Setup Defaults
↑↓←→	: Select Item
PU/PD/+/-	: Modify
F2	: Color

Figure 4-4: Chipset features setup

4.2.5 Power management setup

By choosing the POWER MANAGEMENT SETUP option from the INITIAL SETUP SCREEN menu, the screen below is displayed. This sample screen contains the manufacturer's default values for the PCM-9570/S.

ROM PCI/ISA BIOS (2A69KAKI)		
POWER MANAGEMENT SETUP		
AWARD SOFTWARE, INC.		
Power Management	: User Define	** Reload Global Timer Events **
PM Control by APM	: No	IRQ[3-7,9-15],NMI : Disabled
Video Off Method	: Blank Screen	Primary IDE 0 : Disabled
Video Off After	: NA	Primary IDE 1 : Disabled
MODEM Use IRQ	: NA	Secondary IDE 0 : Disabled
Doze Mode	: Disable	Secondary IDE 1 : Disabled
Standby Mode	: Disable	Floppy Disk : Disabled
Suspend Mode	: Disable	Serial Port : Disabled
HDD Power Down	: Disable	Parallel Port : Disabled
Throttle Duty Cycle	: 12.5%	
PCI/VGA Act-Monitor	: Disabled	
Soft-off by PWR-BTTN	: Instant-Off	
CPUFAN Off In Suspend	: Disabled	
PowerOn by Ring	: Disabled	
IRQ 8 Break Suspend	: Disabled	
		ESC : Quit ↑↓+* : Select Item
		F1 : Help PU/PD/+/- : Modify
		F5 : Old Values (Shift)F2 : Color
		F6 : Load BIOS Defaults
		F7 : Load Setup Defaults

Figure 4-5: Power management setup

4.2.6 PnP/PCI configuration

By choosing the PnP/PCI CONFIGURATION option from the Initial Setup Screen menu, the screen below is displayed. This sample screen contains the manufacturer's default values for the PCM-9570/S.

ROM PCI/ISA BIOS (2A69KAKI)	
PNP/PCI CONFIGURATION	
AWARD SOFTWARE, INC.	
PNP OS Installed : No	Assign IRQ For VGA : Disabled
Resources Controlled By : Manual	Used MEM base addr : N/A
Reset Configuration Data : Disabled	Assign IRQ For USB : Disabled
IRQ-3 assigned to : PCI/ISA PnP	
IRQ-4 assigned to : PCI/ISA PnP	
IRQ-5 assigned to : PCI/ISA PnP	
IRQ-7 assigned to : PCI/ISA PnP	
IRQ-9 assigned to : PCI/ISA PnP	
IRQ-10 assigned to : PCI/ISA PnP	
IRQ-11 assigned to : PCI/ISA PnP	
IRQ-12 assigned to : PCI/ISA PnP	
IRQ-14 assigned to : PCI/ISA PnP	
IRQ-15 assigned to : PCI/ISA PnP	
DMA-0 assigned to : PCI/ISA PnP	
DMA-1 assigned to : PCI/ISA PnP	ESC : Quit ↑↓+ : Select Item
DMA-3 assigned to : PCI/ISA PnP	F1 : Help PU/PD/+/- : Modify
DMA-5 assigned to : PCI/ISA PnP	F5 : Old Values (Shift)F2 : Color
DMA-6 assigned to : PCI/ISA PnP	F6 : Load BIOS Defaults
DMA-7 assigned to : PCI/ISA PnP	F7 : Load Setup Defaults

Figure 4-6: PnP/PCI configuration

4.2.7 Integrated peripherals

By choosing the INTEGRATED PERIPHERALS option from the INITIAL SETUP SCREEN menu, the screen below is displayed. This sample screen contains the manufacturer's default values for the PCM-9570/S. The PANEL TYPE by default supports an 18-bit 640 x 480 TFT LCD panel display.

ROM PCI/ISA BIOS (2A69KAKI) INTEGRATED PERIPHERALS AWARD SOFTWARE, INC.	
IDE HDD Block Mode	: Disabled
On-Chip Primary PCI IDE	: Disabled
On-Chip Secondary PCI IDE	: Disabled
Onboard PCI SCSI Chip	: Disabled
Onboard PCI Lan Chip	: Disabled
USB Keyboard Support	: Disabled
Init Display First	: PCI Slot
KBC input clock	: 6 MHz
Onboard FDC Controller	: Disabled
Onboard Serial Port 1	:
Onboard Serial Port 1 IRQ	: 3
Onboard Serial Port 2	:
Onboard Serial Port 2 IRQ	: 3
UART Mode Select	:
RxD , TxD Active	: Hi,Hi
IR Transmittiion delay	: Disabled
Onboard Parallel Port	:
Onboard Parallel Port IRQ	: 5
Parallel Port Mode	:
ECP Mode Use DMA	: 1
EPP Mode Select	: EPP1.9
Onboard Serial Port 3	: Disabled
Onboard Serial Port 4	: Disabled
Panel SHFCLK Polarity	: Normal
Boot Up Display Type	: Panel Only
Panel Type	: 640x480 24bit TFT

Figure 4-7: Integrated peripherals

4.2.8 Load BIOS defaults

LOAD BIOS DEFAULTS loads the default system values directly from ROM. If the stored record created by the Setup program becomes corrupted (and therefore unusable), these defaults will load automatically when you turn the PCM-9570/S on.

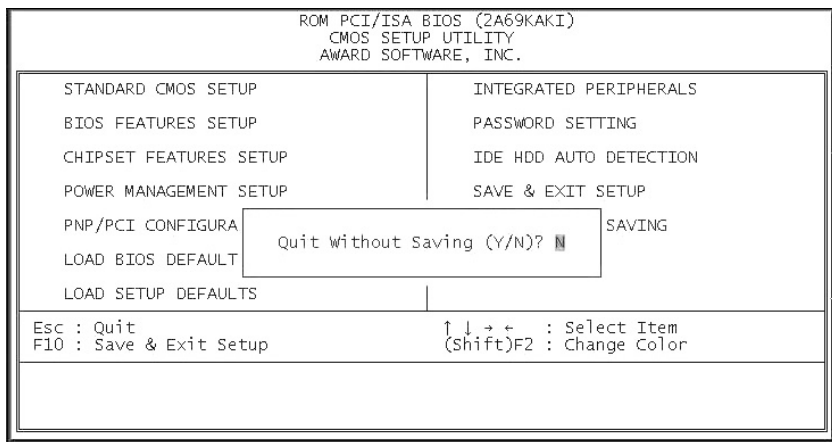

Figure 4-8: Load BIOS defaults

4.2.9 Change password

To change the password, choose the PASSWORD SETTING option from the Setup main menu and press <Enter>.

1. If the CMOS is bad or this option has never been used, a default password is stored in the ROM. The screen will display the following messages:

Enter Password:

Press <Enter>.

2. If the CMOS is good or this option has been used to change the default password, the user is asked for the password stored in the CMOS. The screen will display the following message:

Confirm Password:

Enter the current password and press <Enter>.

3. After pressing <Enter> (ROM password) or the current password (user-defined), you can change the password stored in the CMOS. The password can be at most eight (8) characters long.

Remember - to enable this feature, you must first select either Setup or System in the BIOS FEATURES SETUP.

4.2.10 Auto detect hard disk

The IDE HDD AUTO DETECTION utility can automatically detect the IDE hard disk installed in your system. You can use it to self-detect and/or correct the hard disk type configuration.

```
ROM PCI/ISA BIOS (2A5IHAKA)
CMOS SETUP UTILITY
AWARD SOFTWARE, INC.
```

```
HARD DISK TYPE  SIZE  CYLS.  HEADS  PRECOMP  LANDZ  SECTORS  MODE
Drive C        : (MB)  790    15    65535   789    57
```

```
SELECT SECONDARY SLAVE OPTION (N=Skip): N
```

```
ESC = SKIP
```

Figure 4-9: IDE HDD auto detection screen

4.2.11 Save & exit setup

If you select this option and press <Enter>, the values entered in the setup utilities will be recorded in the chipset's CMOS memory. The microprocessor will check this every time you turn your system on and compare this to what it finds as it checks the system. This record is required for the system to operate.

4.2.12 Exit without saving

Selecting this option and pressing <Enter> lets you exit the Setup program without recording any new values or changing old ones.

CHAPTER 5

PCI SVGA Setup

- Introduction
- Installation of SVGA driver for
 - Windows 95
 - Windows 98
 - Windows NT

5.1 Introduction

The PCM-9570/S has an on-board PCI flat panel/VGA interface. The specifications and features are described as follows:

5.1.1 Chipset

The PCA-9570/S uses a Trident 9525DVD chipset for its PCI/SVGA controller. It supports many popular LCD, EL, and gas plasma flat panel displays and conventional analog CRT monitors. The 9525 VGA BIOS supports monochrome LCD, EL, color TFT and STN LCD flat panel displays. In addition, it also supports interlaced and non-interlaced analog monitors (color and monochrome VGA) in high-resolution modes while maintaining complete IBM VGA compatibility. Digital monitors (i.e. MDA, CGA, and EGA) are NOT supported. Multiple frequency (multisync) monitors are handled as if they were analog monitors.

5.1.2 Display memory

With 2.5 MB display memory on board, the VGA controller can drive CRT displays or color panel displays with resolutions up to 1024 x 768 at 16.8 M colors. You have the option to use the Trident 9525 to expand the display memory to 4 MB (TM 9540 chip). This yields true-color resolution of 1280 x 1024.

5.1.3 Display types

CRT and panel displays can be used simultaneously. The PCA-9570/S can be set in one of three configurations: on a CRT, on a flat panel display, or on both simultaneously. The system is initially set to simultaneous display mode. The BIOS setup can be used to configure the display. In BIOS, select "Integrated Peripherals", then "Boot-up display type." You can then choose one of the following modes: "CRT only", "Panel only", or "Simultaneous."

5.1.4 Dual/simultaneous display

The PCM-9570/S uses a Trident Cyber 9525DVD LCD controller that is capable of providing multiple views and simultaneous display with mixed video and graphics on a flat panel and CRT.

To set up dual display under Windows 98, follow these steps:

1. Select “Windows98”, “Control panel”, “Display”, “Settings”.
2. Select “1” for current display, or “2” for second display.
3. Enable “Extend my Windows desktop onto this monitor”.
4. Click “OK”.

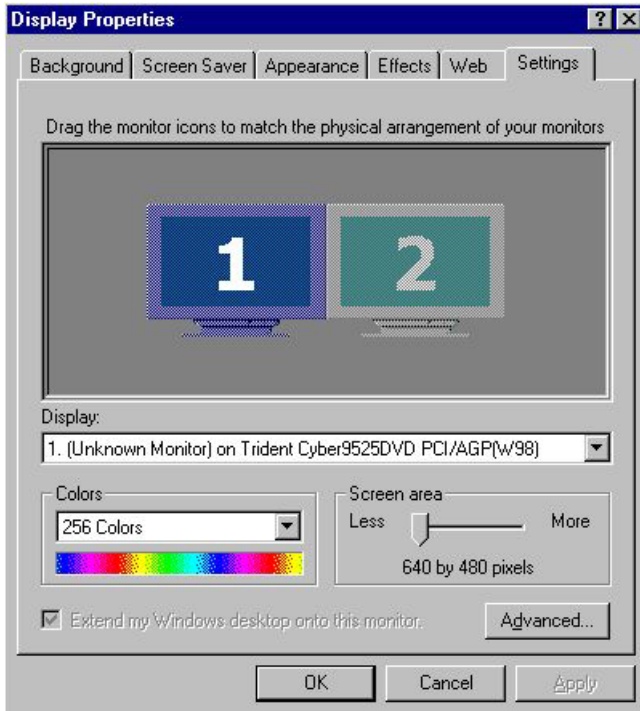

Figure 5-1: Selecting display settings

5.2 Installation of SVGA driver

Complete the following steps to install the SVGA driver. Follow the procedures in the flow chart that apply to the operating system that you are using within your PCM-9570/S.

Important: The following windows illustrations are examples only. You must follow the flow chart instructions and pay attention to the instructions which then appear on your screen.

Note: <Enter> means pressing the "Enter" key on the keyboard.

5.2.1 Installation for Windows 95/98

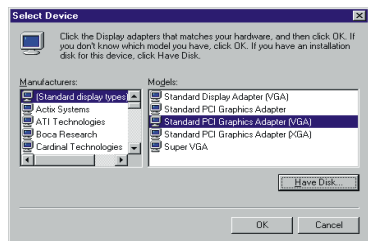
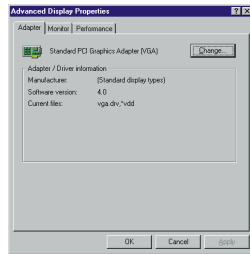
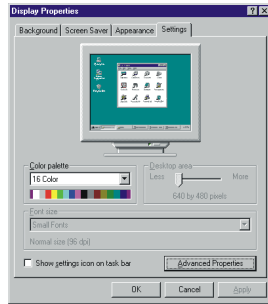
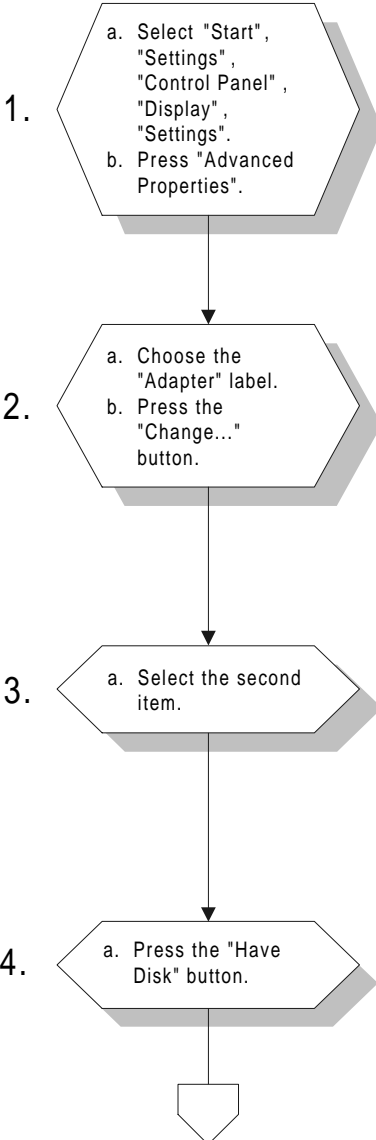

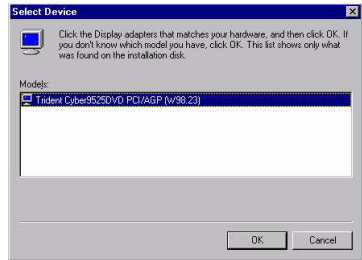
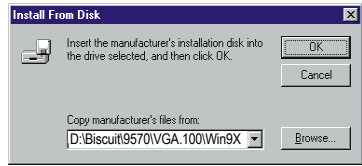
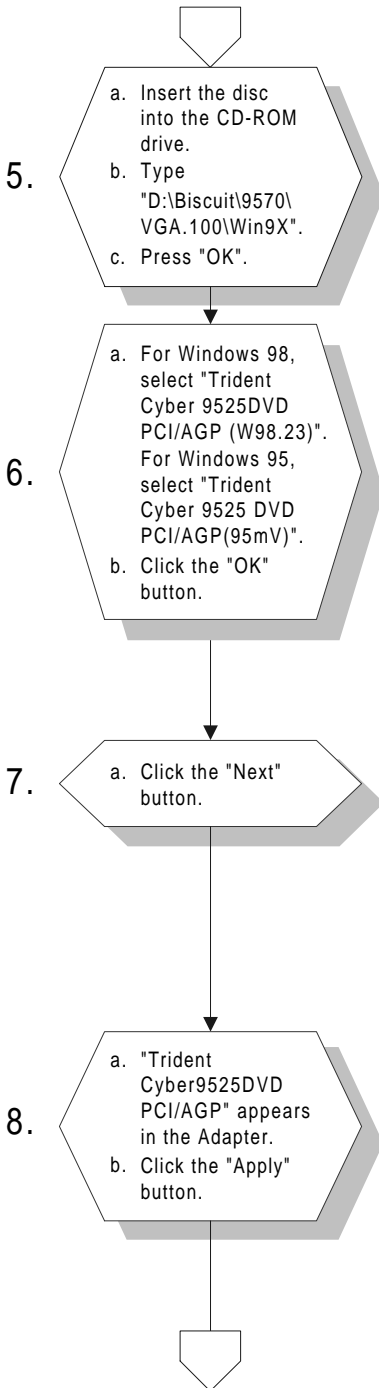

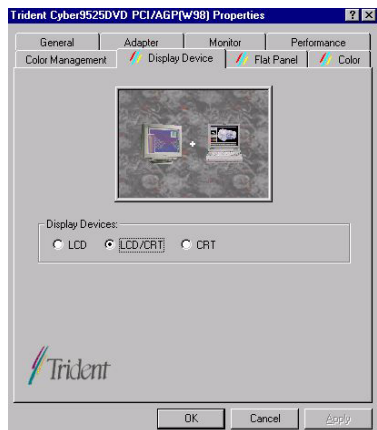
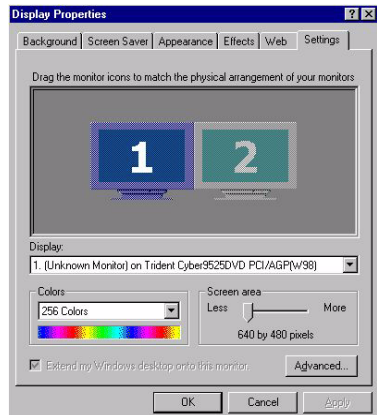
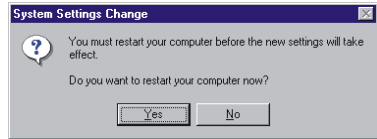
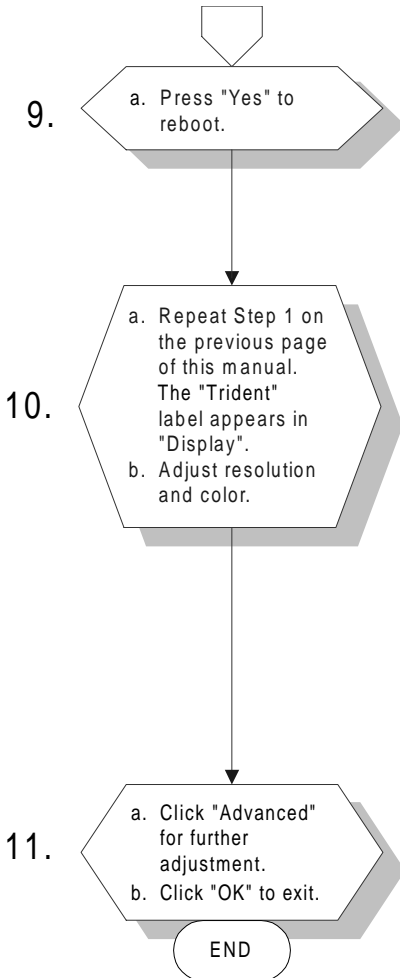

5.2.2 Installation for Windows NT

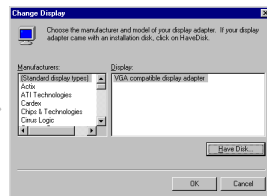
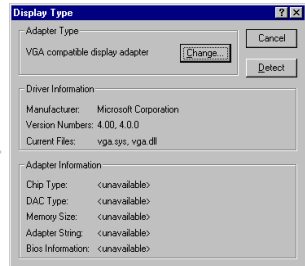
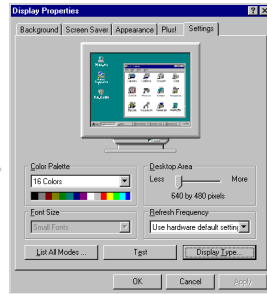
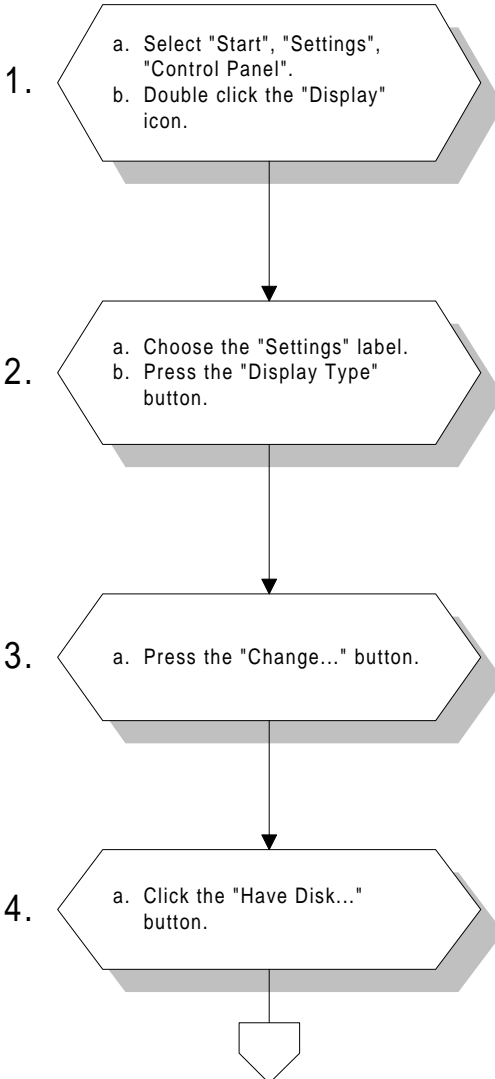

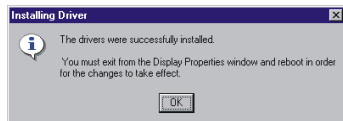
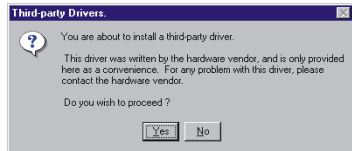
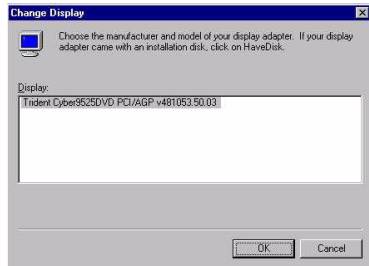
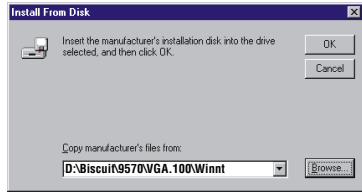
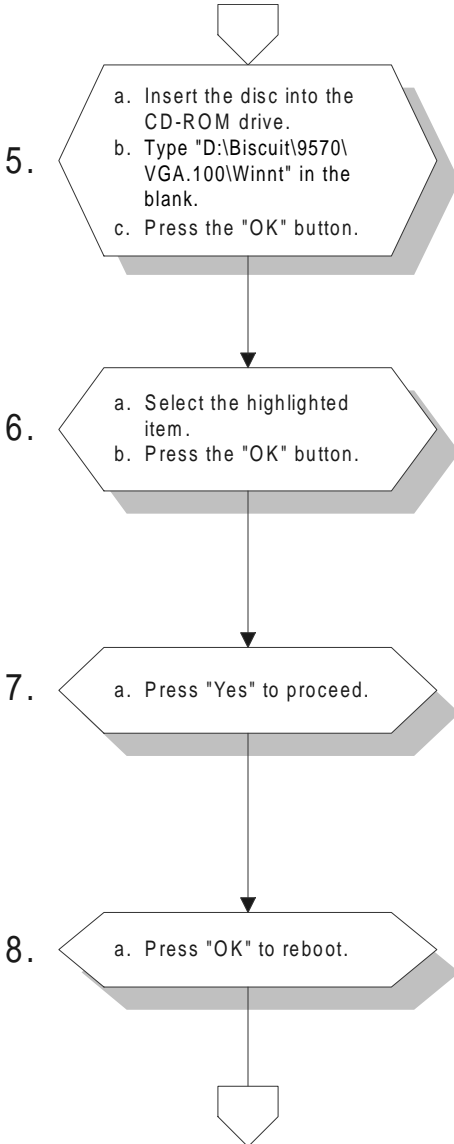

9.

- a. Repeat Step 1 in this manual, to select the "Settings" label.
- b. Adjust resolution and color.
- c. Click "Test" to see the result.
- d. Click "OK" to save the setting.

END

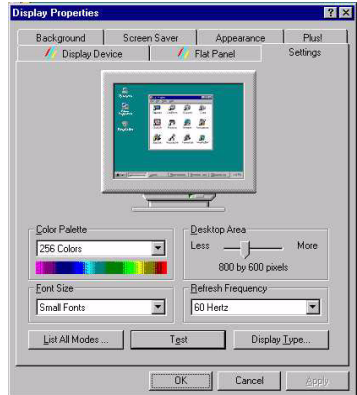

5.3 Further information

For further information about the PCI/SVGA installation in your PCM-9570/S, including driver updates, troubleshooting guides and FAQ lists, visit the following web resources:

Trident website: **www.trid.com**

Advantech websites: **www.advantech.com**
www.advantech.com.tw

CHAPTER 6

SCSI Setup and Configurations

The PCM-9570/S features an on-board SCSI interface. This chapter provides basic SCSI concepts and instructions for installing the software drivers with the SCSI driver disks/CD included in your package.

6.1 Introduction

The PCM-9570/S is equipped with a Symbios SYM53C895 single-chip PCI-to-SCSI host adapter which provides a powerful Ultra2 multitasking interface between your computer's PCI bus and SCSI devices (disk drives, CD-ROM drives, scanners, tape backups, removable media drives, etc.). Up to a total of 15 SCSI devices can be connected to the SCSI connector through the Symbios SYM53C895.

The SYMBIOS 53C895 is a 16-bit, LVD/SE (Low Voltage Differential/Single-Ended) SCSI solution for your computer. It can support both legacy Fast SCSI and Ultra SCSI devices, as well as the newest LVD Ultra2 SCSI devices.

If you need to configure the SCSI, the on-board SCSI Select configuration utility allows you to change host adapter settings without opening the computer or handling the board. The SCSI Select utility also contains a utility to low-level format and verifies the disk media on your hard disk drives.

Note: If any peripheral is attached to the Ultra2 SCSI segment and is running at SE mode, one or more Ultra/Ultra Wide peripherals will be attached to the Ultra2 SCSI segment and will cause the Ultra2 SCSI segment to run at speeds up to 40 MBytes/sec instead of 80 MBytes/sec.

6.2 Before you begin

SDMS software requires an IBM PC/AT or compatible computer with an 80486 or higher microprocessor. An understanding of basic operating system commands is assumed. In addition, users should have a general knowledge of the SCSI standard.

Before using the SDMS software, you should configure the Symbios SCSI controller into your system, taking into account the configuration of other host adapters and system resources (see Section 6.3).

Symbios recommends that you back up all data before making any changes or installing any software, including the Symbios SCSI controllers and software. Failure to adhere to this accepted computer practice may lead to loss of data.

6.3 Basic rules for SCSI host adapter and device installation

You must terminate both ends of the SCSI bus. Refer to the hardware manuals for the devices and the host adapter to properly terminate the bus.

Unless your system is SCSI Configured AutoMatically (SCAM) capable, you must configure each SCSI device with a different SCSI ID number. Refer to the hardware manuals for the devices to locate where the jumpers of dip switches are for setting SCSI ID numbers. Usually, the host adapter is ID 7. The devices are then set at IDs 0 through 6 (plus 8 through 15 for Wide SCSI). The bootable hard drive must have the lowest numerical SCSI ID, unless you are able to use the BIOS Boot Specification (BBS).

The red or blue line on a standard SCSI cable (or the black line on one end of a multi-colored SCSI cable) designates pin one on the cable connector and must connect to pin one on the device or host adapter connector. Refer to Appendix C to find pin one of the connector.

6.4 Configuring the SCSI adapter

Access the SCSI BIOS by holding down both the CTRL and C keys when you see the BIOS banner message listing the driver name and the attached devices. For example:

```
Symbios Inc. SDMS (TM) V 4.0 PCI SCSI BIOS
PCI Rev. 2.0, 2.1
Copyright 1995, 1998 Symbios Inc.
PCI-4.12.00
Press Ctrl-C to start Symbios Configuration
Utility...
```

The SCSI Select screen will come up. Instructions on how to move the cursor and select options are listed on the bottom of the program windows. You can select either Configure/View Host Adapter Settings or SCSI CD Utilities.

6.5 SCSI terminators

To ensure reliable communication, the SCSI bus must be properly terminated. Termination is controlled by a set of electrical resistors, called terminators. Terminators must be placed (or enabled) at the two extreme ends of the SCSI bus. All devices that lie between the ends must have their terminators removed (or disabled).

Since the method for terminating a SCSI peripheral can vary widely, refer to the peripheral's documentation for instructions on how to enable or disable termination. Here are some general guidelines for termination:

- Termination on internal SCSI peripherals is usually controlled by manually setting a jumper or switch on the peripheral, or by physically removing or installing one or more resistor modules on the peripheral.
- Termination on external SCSI peripherals is usually controlled by installing or removing a SCSI terminator. On some external peripherals, termination is controlled by setting a switch on the rear of the drive.
- By default, termination on the CPU card itself is automatic (the preferred method).
- Internal Ultra2 peripherals are set at the factory with termination disabled, which cannot be changed. Proper termination for internal Ultra2 peripherals is provided by the built-in terminator at the end of the Ultra2 internal SCSI cable.
- Most non-Ultra2 SCSI peripherals come from the factory with termination enabled.

6.6 SDMS drivers

The SDMS device drivers translate an operating system I/O request into a SCSI request. Each Symbios SCSI device driver is operating system specific and is designed to work on standard Symbios chip implementations.

We provide PCI SDMS device drivers for the following operating systems:

- MS-DOS/Windows
- Windows 95/98
- Windows NT - 3.51 and above
- OS/2 4.x Warp
- SCO UNIX - Open Server 5.0.2 and above
- Novell NetWare - 3.12, 4.11 (NWPA)

Note: When you start the Windows NT installation with either a CD-ROM boot or from the floppy disks, a black screen will initially appear with the following text at the top:

```
Setup is inspecting your computer's hardware
configuration...
```

While this is on the screen (before entering the initial blue screen), press the F6 key. Windows NT setup will allow a SCSI driver to be added before the second disk is requested. Add the appropriate driver from a prepared floppy disk. Follow the rest of the instructions to finish the installation.

6.7 Utility user's guide and installation instructions

The utility user's guide and installation instructions are provided in HTM format in the driver CD-ROM. Users can browse the instructions by using a java-aware browser such as Microsoft Internet Explorer v3.0 or later, or Netscape 2.0 or later. To utilize the full functionality of the CD, Microsoft Internet Explorer is recommended. Netscape will work, but links that launch applications are disabled in Netscape.

The instructions are located in the directory **Biscuit(9570)\SCSI.100**, and include:

For DOS:

- **ASPI8XX.HTM**: Installation guide for ASPI manager
- **DOS.HTM**: Device drivers for DOS/Windows 3.x
- **DOSCONF.HTM**: SDMS DOS configuration utility
- **SYMCD.HTM**: CDROM support using the ASPI manager
- **SYMDISK.HTM**: Device driver that provides support for non-INT13h SCSI disk drives and removable media devices using the ASPI manager
- **VERIFY.HTM**: SDMS DOS Verify Utility user's guide

For Windows 95/98:

- **DEVMGR95.HTM**: Installing the SYMC8XX.MPD/SYM_HI.MPD driver in Windows 95
- **SCSITOOL.HTM**: Installation guide for the Symbios SCSI tools for Windows 95/98 and Windows NT
- **WIN95.HTM**: Installation guide for device drivers for Windows 95 and Windows 98

For Windows NT:

- **WINNT.HTM:** Installation guide for device drivers for Windows NT
- **NEWASNT.HTM:** Windows NT 4.0 guided installation for installing SYMC8XX or SYM_HI drivers
- **NTCONFIG.HTM:** Windows NT configuration utility (NTCONFIG)
- **NTDMI.HTM:** Installation guide for the NT DMI 1.0 component instrumentation
- **NTDMI2.HTM:** Installation guide for the NT DMI 2.0 component instrumentation
- **SCSITOOOL.HTM:** Installation guide for the Symbios SCSI tools for Windows 95/98 and Windows NT

For SCO Unix:

- **BLDBTLD.HTM:** Building the SCO UnixWare BTLD diskette
- **BUILDSCO.HTM:** Building the SCO OpenServer BTLD diskette
- **SCOUNIX.HTM:** Installation guide for the Symbios SDMS SCO UNIX driver
- **UNIXWARE.HTM:** Installation guide for the Symbios SDMS UnixWare driver

For NetWare:

- **NETWDML.HTM:** NetWare DMI 1.0 SDMS component instrumentation
- **NWPA.HTM:** Installation guide for the Symbios NetWare NWPA drivers SYM8XXNW.HAM and SYMHINW.HAM

For OS/2:

- **OS2.HTM:** Driver installation for OS/2

For Solaris:

- **SOLARIS.HTM:** Installation guide for the Solaris device driver

Other tools and utilities:

- **BIOS.HTM:** User's guide for SCSI BIOS configuration utility
- **FLASH.HTM:** SDMS host adapter Flash utility
- **FORMAT.HTM:** SDMS SCSI low-level format utility
- **RAWRITE.HTM:** Description of RaWrite 1.3
- **UTILMAIN.HTM:** SDMS utilities user's guides

6.8 Driver and utility installation

The device drivers and utilities of the SCSI interface are provided in the **\Biscuit\9570\SCSI.100** directories of the driver CD-ROM. The file names and paths of the drivers and utilities are listed below:

For DOS and Windows 3.1:

- **\Biscuit\9570\SCSI.100\DOS**

For Windows 95/98:

- **\Biscuit\9570\SCSI.100\Win9X**

For Windows NT:

- **\Biscuit\9570\SCSI.100\Winnt**

For SCO Unix and Solaris:

- **\Biscuit\9570\SCSI.100\Unix**

For NetWare:

- **\Biscuit\9570\SCSI.100\Net**

For OS/2:

- **\Biscuit\9570\SCSI.100\OS2**

Other tools and utilities:

- **\Biscuit\9570\SCSI.100\Utility**

For detailed installation guides, refer to the related documents which are listed in Section 6.7.

CHAPTER 7

PCI Bus Ethernet Interface

This chapter provides information on Ethernet configuration.

- Introduction
- Installation of Ethernet driver for Windows 95/98/NT
- Further information

7.1 Introduction

The PCM-9570/S is equipped with a high performance 32-bit Ethernet chipset which is fully compliant with IEEE 802.3 100 Mbps CSMA/CD standards. It is supported by major network operating systems. It is also both 100Base-T and 10Base-T compatible. The medium type can be configured via the RSET8139.exe program included on the utility disk.

The Ethernet port provides a standard RJ-45 jack on board. The network boot feature can be utilized by incorporating the boot ROM image files for the appropriate network operating system. The boot ROM BIOS files are combined with system BIOS, which can be enabled/disabled in the BIOS setup.

7.2 Installation of Ethernet driver

Before installing the Ethernet driver, note the procedures below. You must know which operating system you are using in your PCM-9570/S, and then refer to the corresponding installation flow chart. Then just follow the steps described in the flow chart. You will quickly and successfully complete the installation, even if you are not familiar with instructions for MS-DOS or Windows.

Note: The windows illustrations in this chapter are examples only. You must follow the flow chart instructions and pay attention to the instructions which then appear on your screen.

7.2.1 Installation for MS-DOS and Windows 3.1

If you want to set up your Ethernet connection under the MS-DOS or Windows 3.1 environment, you should first check your server system model. For example, MS-NT, IBM-LAN server, and so on.

Then choose the correct driver to install in your panel PC.

The installation procedures for various servers can be found on CD-ROM, the correct path being:

D:\Biscuit\9570\Lan.100\8139B\wfw311

7.2.2 Installation for Windows 95/98

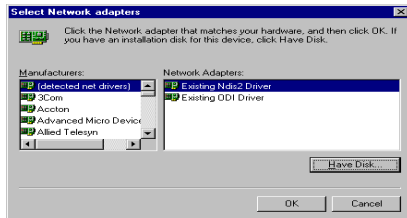
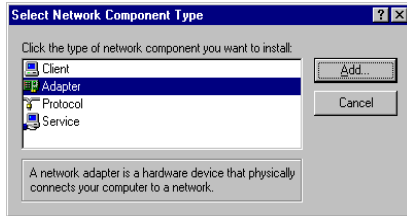
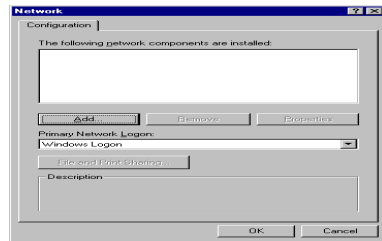
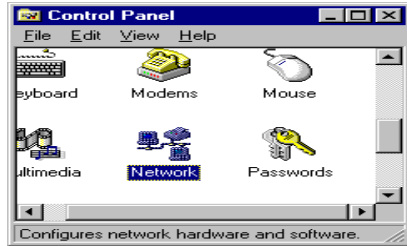
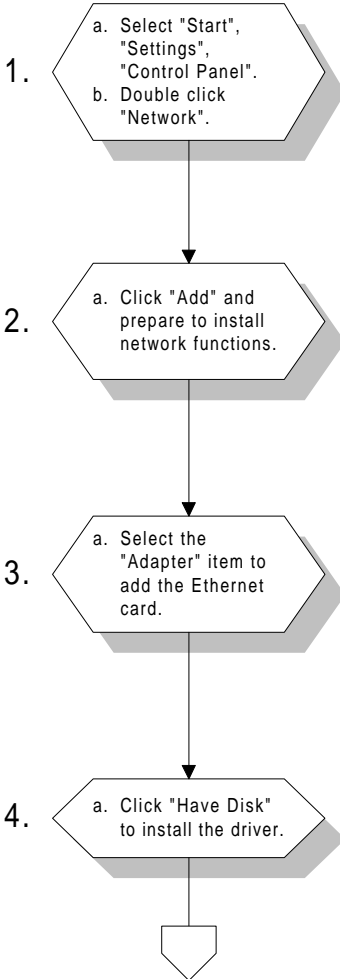

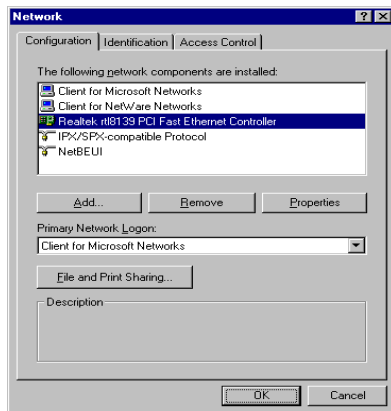
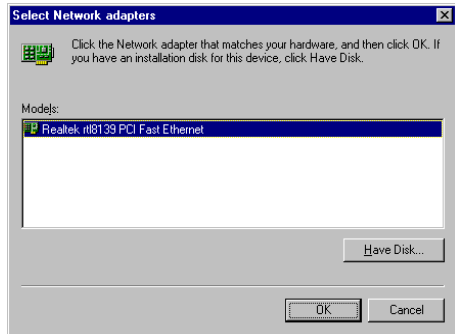
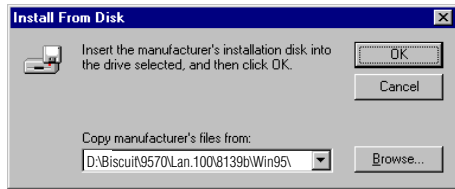
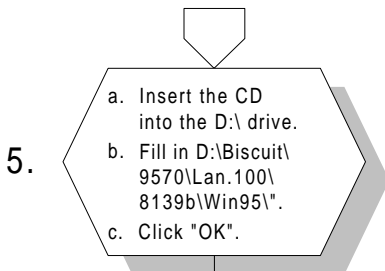

Note 1: The correct file path for Windows 98 is:
Biscuit\9570\Lan.100\8139b\Win98

Note 2: In the file path, choose "8139a" or "8139b" according to the type of Ethernet chip used.

7.2.3 Installation for Windows NT

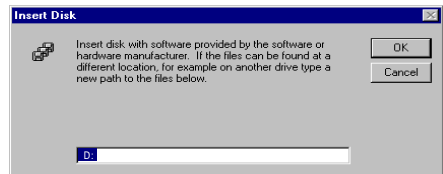
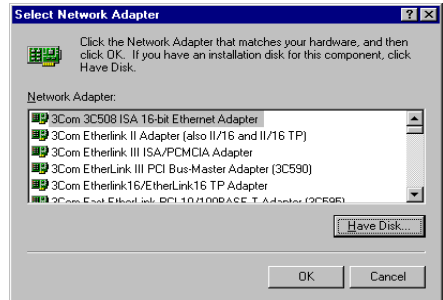
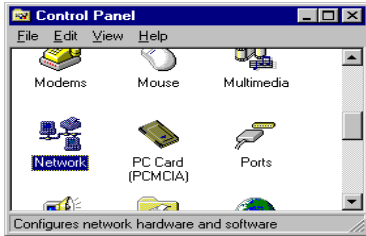
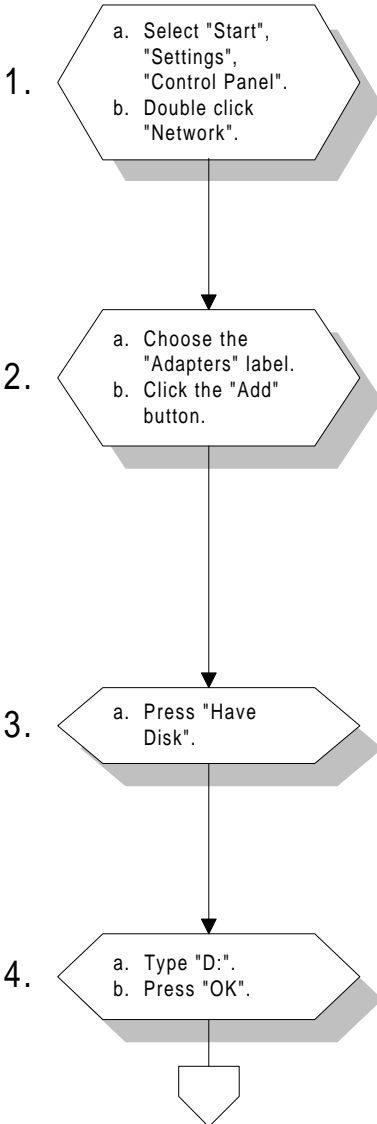

5.

- a. Insert the CD into the D:\ drive.
- b. Fill in "D:\Biscuit\9570\Lan.100\8139b\Winnt".
- c. Click "OK".

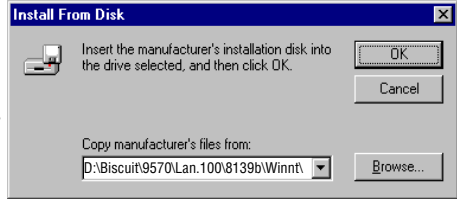

6.

- a. Choose the "Realtek" item.
- b. Click "OK".

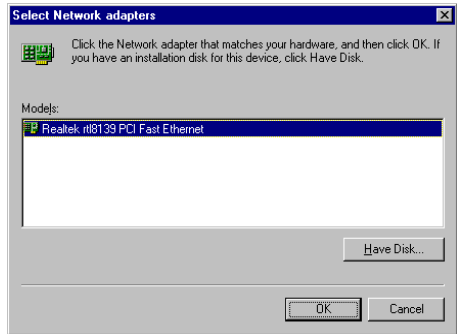

7.

- a. Make sure the configurations of relevant items are set correctly.
- b. Click "OK" to reboot.

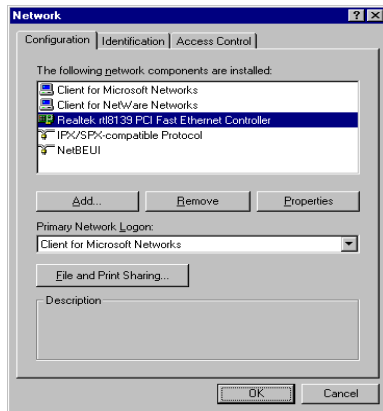

END

7.3 Further information

Realtek website: www.realtek.com

Advantech website: www.advantech.com
www.advantech.com.tw

Programming the Watchdog Timer

The PCM-9570/S is equipped with a watchdog timer that resets the CPU or generates an interrupt if processing comes to a standstill for whatever reason. This feature ensures system reliability in industrial standalone, or unmanned, environments.

A.1 Programming the watchdog timer

In order to program the watchdog timer, you must write a program which writes I/O port address 443 (hex). The output data is a value of time interval. The value range is from 01(hex) to 3E(hex), and the related time interval is 1 sec. to 62 sec.

Data	Time Interval
01	1 sec.
02	2 sec.
03	3 sec.
04	4 sec.
	.
	.
	.
3E	62 sec.

After data entry, your program must refresh the watchdog timer by rewriting the I/O port 443 (hex) while simultaneously setting it. When you want to disable the watchdog timer, your program should read I/O port 443 (hex).

The following example shows how you might program the watchdog timer in BASIC:

```
10      REM Watchdog timer example program
20      OUT &H443, data REM Start and restart the
        watchdog
30      GOSUB 1000 REM Your application task #1
40      OUT &H443, data REM Reset the timer
50      GOSUB 2000 REM Your application task #2
60      OUT &H443, data REM Reset the timer
70      X=INP (&H443) REM Disable the watchdog
        timer
80      END

1000    REM Subroutine #1, you application task
        .
        .
        .
1070    RETURN
2000    REM Subroutine #2, you application task
        .
        .
        .
2090    RETURN
```

APPENDIX

B

Installing PC/104 Modules

This appendix gives instructions for installing PC/104 modules.

B.1 Installing PC/104 modules

The PCM-9570/S's PC/104 connectors give you the flexibility to attach PC/104 modules.

Installing these modules on the PCM-9570/S is quick and simple. The following steps show how to mount the PC/104 modules:

1. Remove the PCM-9570/S from your system paying particular attention to the safety instructions already mentioned above.
2. Make any jumper or link changes required to the CPU card now. Once the PC/104 module is mounted you may have difficulty in accessing these.
3. Normal PC/104 modules have male connectors and mount directly onto the main card. (Refer to the diagram on the following page.)
4. Mount the PC/104 module onto the CPU card by pressing the module firmly but carefully onto the mounting connectors.
5. Secure the PC/104 module onto the CPU card using the four mounting spacers and screws.

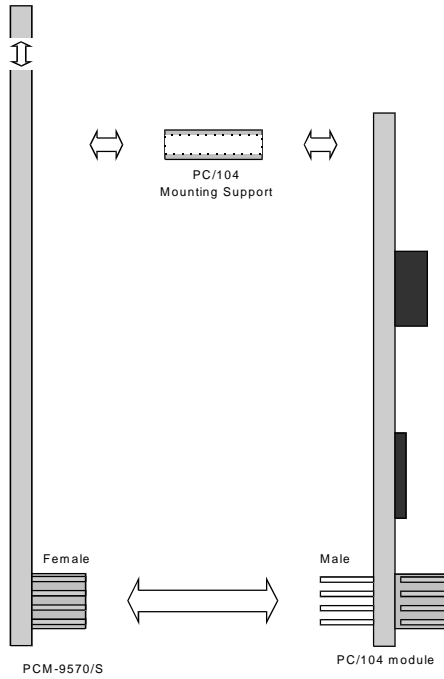

Figure B-1: PC/104 module mounting diagram

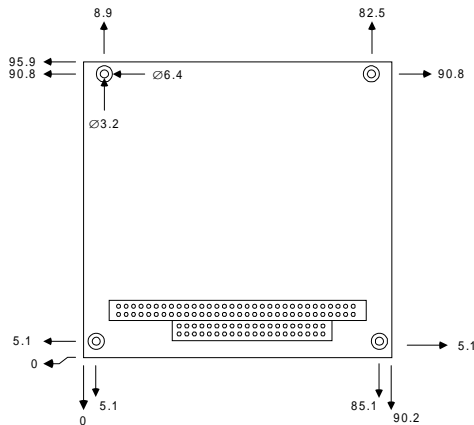

Figure B-2: PC/104 module dimensions (mm) (± 0.1)

Table B-1: PC/104 connectors (CN10)

Pin Number	Signal		Signal	
	Row A	Row B	Row C	Row D
0	—	—	0 V	0 V
1	IOCHCHK*	0 V	SBHE*	MEMCS16*
2	SD7	RESETDRV	LA23	IOCS16*
3	SD6	+5 V	LA22	IRQ10
4	SD5	IRQ9	LA21	IRQ11
5	SD4	-5 V	LA20	IRQ12
6	SD3	DRQ2	LA19	IRQ15
7	SD2	-12 V	LA18	IRQ14
8	SD1	ENDXFR*	LA17	DACK0*
9	SD0	+12 V	MEMR*	DRQ0
10	IOCHRDY	N/C	MEMW*	DACK5*
11	AEN	SMEMW*	SD8	DRQ5
12	SA19	SMEMR*	SD9	DACK6*
13	SA18	IOW*	SD10	DRQ6
14	SA17	IOR*	SD11	DACK7*
15	SA16	DACK3*	SD12	DRQ7
16	SA15	DRQ3	SD13	+5 V
17	SA14	DACK1*	SD14	MASTER*
18	SA13	DRQ1	SD15	0 V
19	SA12	REFRESH*	KEY	0 V
20	SA11	SYSCLK	—	—
21	SA10	IRQ7	—	—
22	SA9	IRQ6	—	—
23	SA8	IRQ5	—	—
24	SA7	IRQ4	—	—
25	SA6	IRQ3	—	—
26	SA5	DACK2*	—	—
27	SA4	TC	—	—
28	SA3	BALE	—	—
29	SA2	+5 V	—	—
30	SA1	OSC	—	—
31	SA0	0 V	—	—
32	0 V	0 V	—	—

* active low

Pin Assignments

This appendix contains information of a detailed or specialized nature. It includes:

- Ethernet 10/100Base-T connector
- ATX power feature connector
- SCSI connector
- Keyboard and PS/2 mouse connector
- Main power connector
- IR connector
- Floppy drive connector
- IDE hard drive connector
- Parallel port connector
- Backlight connector
- Peripheral power connector
- CRT display connector
- 24-bit LCD display connector
- Ext. LCD display connector
- LCD signal mapping
- Front panel connector
- USB connectors
- COM port connector
- CompactFlash card connector
- PanelLink connector
- Fan power connector

C.1 Ethernet 10/100Base-T connector (CN1)

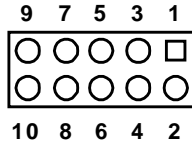

Table C-1: Ethernet 10Base-T connector (CN1)

Pin	Signal
1	V_{CC}
2	CRS LED
3	RCV+
4	RCV-
5	BNC LED
6	GND
7	N/C
8	GND
9	XMT+
10	XMT-

C.2 ATX power feature connector (CN2)

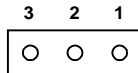

Table C-2: ATX power feature connector (CN2)

Pin	Signal
1	5 V SB (stand-by voltage)
2	NC
3	VPSON

C.3 SCSI Connector (CN4)

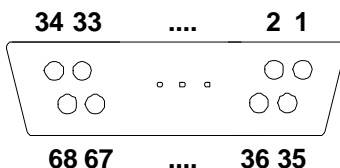

Table C-3: SCSI connector (CN4)

Pin	Function	Pin	Function
1	SD12+	35	SD12-
2	SD13+	36	SD13-
3	SD14+	37	SD14-
4	SD15+	38	SD15-
5	SDP1+	39	SDP1-
6	SD0+	40	SD0-
7	SD1+	41	SD1-
8	SD2+	42	SD2-
9	SD3+	43	SD3-
10	SD4+	44	SD4-
11	SD5+	45	SD5-
12	SD6+	46	SD6-
13	SD7+	47	SD7-
14	SDP0+	48	SDP0-
15	GND	49	GND
16	DIFFSENS	50	NC
17	TPWER	51	TPWER
18	TPWER	52	TPWER
19	NC	53	NC
20	GND	54	GND

[continued overleaf]

Table C-3: SCSI connector (CN4) (continued)

Pin	Function	Pin	Function
21	ATN+	55	ATN-
22	GND	56	GND
23	BSY+	57	BSY-
24	ACK+	58	ACK-
25	RST+	59	RST-
26	MSG+	60	MSG-
27	SEL+	61	SEL-
28	CD+	62	CD-
29	REQ+	63	REQ-
30	IO+	64	IO-
31	SD8+	65	SD8-
32	SD9+	66	SD9-
33	SD10+	67	SD10-
34	SD11+	68	SD11-

C.4 Keyboard and PS/2 mouse connector (CN5)



Table C-4: Keyboard and mouse connector (CN5)

Pin	Signal
1	GND
2	MS VCC
3	MS DATA
4	MS CLOCK
5	GND
6	KB VCC
7	KB DATA
8	KB CLOCK

C.5 Main power connector (CN6)

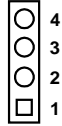

Table C-5: Main power connector (CN6)

Pin	Signal
1	+12 V
2	GND
3	GND
4	+5 V

C.6 IR connector (CN8)

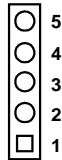

Table C-6: IR connector (CN8)

Pin	Signal
1	V_{cc}
2	NC
3	IR IN
4	GND
5	IR OUT

C.7 Floppy drive connector (CN9)

Table C-7: Floppy drive connector (CN9)

Pin	Signal	Pin	Signal
1	GND	2	DENSITY SELECT*
3	GND	4	N/C
5	GND	6	DRIVE TYPE
7	GND	8	INDEX*
9	GND	10	MOTOR 0*
11	GND	12	DRIVE SELECT 1*
13	GND	14	DRIVE SELECT 0*
15	GND	16	MOTOR 1*
17	GND	18	DIRECTION*
19	GND	20	STEP*
21	GND	22	WRITE DATA*
23	GND	24	WRITE GATE*
25	GND	26	TRACK 0*
27	GND	28	WRITE PROTECT*
29	GND	30	READ DATA*
31	GND	32	HEAD SELECT*
33	GND	34	DISK CHANGE*

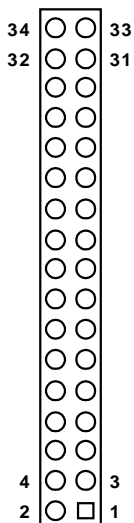

* low active

C.8 IDE hard drive connector (CN11)

Table C-8: IDE hard drive connector (CN11)

Pin	Signal	Pin	Signal
1	IDE RESET*	2	GND
3	DATA 7	4	DATA 8
5	DATA 6	6	DATA 9
7	DATA 5	8	DATA 10
9	DATA 4	10	DATA 11
11	DATA 3	12	DATA 12
13	DATA 2	14	DATA 13
15	DATA 1	16	DATA 14
17	DATA 0	18	DATA 15
19	SIGNAL GND	20	N/C
21	HDD 0	22	GND
23	IO WRITE	24	GND
25	IO READ	26	GND
27	HD READY	28	N/C
29	HDACK 0*	30	GND
31	IRQ14	32	N/C
33	ADDR 1	34	N/C
35	ADDR 0	36	ADDR 2
37	HARD DISK SELECT 0*		
38	HARD DISK SELECT 1*		
39	IDE ACTIVE*	40	GND
41	VCC	42	VCC
43	GND	44	N/C

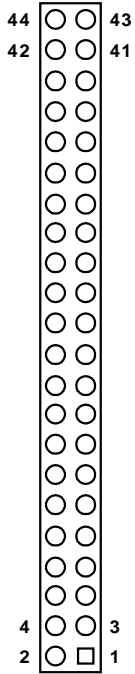

* low active

C.9 Parallel port connector (CN12)

Table C-9: Parallel port connector (CN12)

Pin	Signal	Pin	Signal
1	STROBE*	2	AUTOFD*
3	D0	4	ERR
5	D1	6	INIT*
7	D2	8	SLCTINI*
9	D3	10	GND
11	D4	12	GND
13	D5	14	GND
15	D6	16	GND
17	D7	18	GND
19	ACK*	20	GND
21	BUSY	22	GND
23	PE	24	GND
25	SLCT	26	N/C

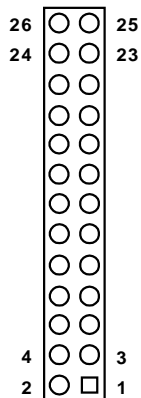

* low active

C.10 Backlight connector (CN13)

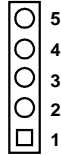

Table C-10: Backlight connector (CN13)

Pin	Signal
1	+12 V
2	GND
3	Enable
4	Reserved
5	N.C.

C.11 Peripheral power connector (CN14)

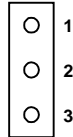

Table C-11: Peripheral power connector (CN14)

Pin	Function
1	-5 V
2	GND
3	-12 V

C.12 CRT display connector (CN15)

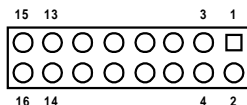

TABLE C-12: CRT DISPLAY CONNECTOR (CN15)			
Pin	Signal	Pin	Signal
1	RED	9	SIGNAL GND
2	DDC POWER	10	H-SYNC
3	GREEN	11	SIGNAL GND
4	SIGNAL GND	12	V-SYNC
5	BLUE	13	SIGNAL GND
6	N/C	14	N/C
7	N/C	15	SIGNAL GND
8	DDT_DAT	16	CHASSIS GND

C.13 24-bit LCD display connector (CN16)

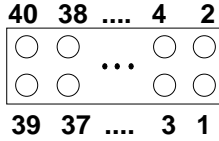

Table C-13: 24-bit LCD display connector (CN16)

Pin	Signal	Pin	Signal
1	VDD 5 V	2	VDD 5 V
3	GND	4	GND
5	VDD 3.3 V	6	VDD 3.3 V
7	Vcon	8	GND
9	PD23 (BØ)	10	PD22 (B1)
11	PD17 (B2)	12	PD16 (B3)
13	PD11 (B4)	14	PD10 (B5)
15	PD9 (B6)	16	PD8 (B7)
17	PD21 (GØ)	18	PD20 (G1)
19	PD15 (G2)	20	PD14 (G3)
21	PD7 (G4)	22	PD6 (G5)
23	PD5 (G6)	24	PD4 (G7)
25	PD19 (RØ)	26	PD18 (R1)
27	PD13 (R2)	28	PD12 (R3)
29	PD3 (R4)	30	PD2 (R5)
31	PD1 (R6)	32	PD0 (R7)
33	GND	34	GND
35	SHIFT CLOCK	36	FLM
37	M	38	LP
39	DCLK (reserved)	40	ENAVEE

Note 1: The model number of the CN16 connector is DF13A-40DP-1.25V (Hirose Electric Co., Ltd.)

Note 2: The signals shown in parentheses are for 24-bit TFT color bits.

C.14 Ext. LCD display connector (CN17)

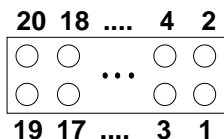

Table C-14: Ext. LCD display connector (CN17)

Pin	Signal	Pin	Signal
1	GND	2	GND
3	PD24	4	PD25
5	PD26	6	PD27
7	PD28	8	PD29
9	PD30	10	PD31
11	PD32	12	PD33
13	PD34	14	PD35
15	GND	16	GND
17	N/C	18	N/C
19	N/C	20	N/C

Note 1: The model number of the CN17 connector is DF13A-20DP-1.25V (Hirose Electric Co., Ltd.).

The model number of the CN16 connector is DF13A-40DP-1.25V (Hirose Electric Co., Ltd.).

Note 2: To support a 36-bit TFT LCD, connection must be made to both CN17 and CN16.

C.15 LCD signal mapping

Table C-15: LCD signal mapping

Pin Name	LCD			
	16-bit DSTN	18-bit TFT	24-bit TFT	36-bit TFT
PD0	LD0	R5	R7	Ro5
PD1	LD1	R4	R6	Ro4
PD2	LD2	R3	R5	Ro3
PD3	LD3	R2	R4	Ro2
PD4	LD4	G5	G7	Go5
PD5	LD5	G4	G6	Go4
PD6	LD6	G3	G5	Go3
PD7	LD7	G2	G4	Go2
PD8	UD0	B5	B7	Bo5
PD9	UD1	B4	B6	Bo4
PD10	UD2	B3	B5	Bo3
PD11	UD3	B2	B4	Bo2
PD12	UD4	R1	R3	Re5
PD13	UD5	R0	R2	Re4
PD14	UD6	G1	G3	Re3
PD15	UD7	G0	G2	Re2
PD16		B1	B3	Ge5
PD17		B0	B2	Ge4
PD18			R1	Ge3
PD19			R0	Ge2
PD20			G1	Be5
PD21			G0	Be4
PD22			B1	Be3
PD23			B0	Be2
PD24				Ro1
PD25				Ro0
PD26				Go1
PD27				Go0
PD28				Bo1
PD29				Bo0
PD30				Re1
PD31				Re0
PD32				Ge1
PD33				Ge0
PD34				Be1
PD35				Be0

C.16 Front panel connector (CN18)

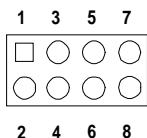

Table C-16: Front panel connector (CN18)

Pin	Signal
1	HDD LED- (HARD DISK ACTIVE)
2	HDD LED+ (V_{CC})
3	SPEAKER+
4	SPEAKER- (GND)
5	GND
6	WATCHDOG OUTPUT*
7	RESET SWITCH- (GND)
8	RESET SWITCH+

* low active

C.17 USB connectors (CN19)

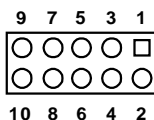

Table C-17: USB connectors (CN19)

Pin	Signal	Pin	Signal
1	+5 V	2	+5 V
3	UV0-	4	UV1-
5	UV0+	6	UV1+
7	GND	8	GND
9	Chassis GND	10	NC

C.18 COM port connector (CN20)

Table C-18: COM port connector (CN20)

Pin	Signal	Pin	Signal
1	DCD1	2	DSR1
3	RX1	4	RTS1
5	TX1	6	CTS1
7	DTR1	8	RI1
9	GND	10	NC
11	DCD2	12	DSR2
13	RX2	14	RTS2
15	TX2	16	CTS2
17	DTR2	18	RI2
19	GND	20	NC
21	DCD3	22	DSR3
23	RX3	24	RTS3
25	TX3	26	CTS3
27	DTR3	28	RI3
29	GND	30	NC
31	DCD4	32	DSR4
33	RX4	34	RTS4
35	TX4	36	CTS4
37	DTR4	38	RI4
39	GND	40	NC

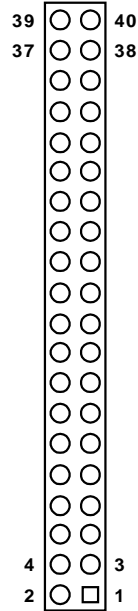

Note: The cable of serial port (CN20) comes with four DSUB-9 male connectors. The pin assignments of each DSUB-9 connector are listed below for your reference:

Table C-19: COM2 port for RS-232, RS-422 and RS-485 (CN20)

Pin	Signal	RS-232	RS-422	RS-485
11	DCD2		TX-	DATA-
13	RxD2		TX+	DATA+
15	TxD2		RX+	NC
17	DTR2		RX-	NC
19	GND		GND	GND
12	DSR2		DSR2 (not used)	DSR2 (not used)
14	RTS2		RTS2 (not used)	DSR2 (not used)
16	CTS2		CTS2 (not used)	DSR2 (not used)
18	RI2		RI2 (not used)	DSR2 (not used)

C.19 CompactFlash card connector (CN21)

Table C-20: CompactFlash card connector (CN21)

Pin	Signal	Pin	Signal
1	GND	2	D03
3	D04	4	D05
5	D06	6	D07
7	-CS0	8	A10 ²
9	-ATA SEL	10	A09 ²
11	A08 ²	12	A07 ²
13	VCC	14	A06 ²
15	A05 ²	16	A04 ²
17	A03 ²	18	A02
19	A01	20	A00
21	D00	22	D01
23	D02	24	-IOCS16
25	-CD2	26	-CD1
27	D11 ¹	28	D12 ¹
29	D13 ¹	30	D14 ¹
31	D15 ¹	32	-CS1 ¹
33	-VS1	34	-IORD
35	-IOWR	36	-WE ³
37	INTRQ	38	V _{CC}
39	-CSEL	40	-VS2
41	-RESER	42	IORDY
43	-INPACK	44	-REG ³
45	-DASP	46	-PDIAG
47	D08 ¹	48	D09 ¹
49	D10	50	GND

C.20 PanelLink connector (CN22)

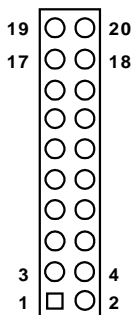

Table C-21: PanelLink connector (CN22)

Pin	Signal	Pin	Signal
1	TX1+	2	TX1-
3	TX1 GND	4	TXC GND
5	TXC+	6	TXC-
7	DDC GND	8	VDD 5 V
9	VDD 5 V	10	VDD 5 V
11	TX2+	12	TX2-
13	TX2 GND	14	TX0 GND
15	TX0+	16	TX0-
17	NC	18	NC
19	DDC/SDA (reserved)	20	DDC/SCL (reserved)

C.21 Fan power connector (FAN1)

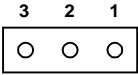

Table C-22: Fan power connector (FAN1)

Pin	Signal
1	NC
2	+12 V
3	GND

APPENDIX **D**

System Assignments

- System I/O ports
- 1st MB memory map
- DMA channel assignments
- Interrupt assignments

D.1 System I/O ports

Table D-1: System I/O ports

Addr. range (Hex)	Device
000-01F	DMA controller
020-021	Interrupt controller 1, master
022-023	Chipset address
040-05F	8254 timer
060-06F	8042 (keyboard controller)
070-07F	Real-time clock, non-maskable interrupt (NMI) mask
080-09F	DMA page register,
0A0-0BF	Interrupt controller 2
0C0-0DF	DMA controller
0F0	Clear math co-processor
0F1	Reset math co-processor
0F8-0FF	Math co-processor
1F0-1F8	Fixed disk
200-207	Reserved (Game I/O)
278-27F	Reserved
2E8-2EF	Serial port 4
2F8-2FF	Serial port 2
300-31F	Prototype card
360-36F	Reserved
378-37F	Parallel printer port 1 (LPT 2)
380-38F	SDLC, bisynchronous 2
3A0-3AF	Bisynchronous 1
3B0-3BF	Monochrome display and printer adapter(LPT1)
3C0-3CF	Reserved
3D0-3DF	Color/graphics monitor adapter
3E8-3EF	Serial port 3
3F0-3F7	Diskette controller
3F8-3FF	Serial port 1
443	Watchdog timer

* MPU-401 select from 300 ~ 330H (2 bytes)

D.2 1st MB memory map

Table D-2: 1st MB memory map

Addr. range (Hex)	Device
F000h - FFFFh	System ROM
E000h - EFFFh	Unused
D000h - DFFFh	SCSI ROM
*CC00h - CFFFh	Ethernet ROM
C000h - CBFFh	Expansion ROM
B800h - BFFFh	CGA/EGA/VGA text
B000h - B7FFh	Unused
A000h - AFFFh	EGA/VGA graphics
0000h - 9FFFh	Base memory

* If Ethernet boot ROM is enabled

D.3 DMA channel assignments

Table D-3: DMA channel assignments

Channel	Function
0	Available
1	Available
2	Floppy disk (8-bit transfer)
3	Available (Parallel Port)
4	Cascade for DMA controller 1
5	Available
6	Available
7	Available

** Parallel port DMA select 1 or 3

D.4 IRQ mapping chart

Table D-4: IRQ mapping chart

0	Interval timer
1	Keyboard
2	Interrupt from Controller 2
3	COM2
4	COM1
5	COM4
6	FDD
7	LPT1
8	RTC
9	Reserved
10	COM3
11	Reserved (watchdog timer)
12	PS/2 mouse
13	INT from co-processor
14	Primary IDE
15	Secondary IDE (reserved for CompactFlash)

* Ethernet interface IRQ select: 9, 11, 12, 15

* PnP USB IRQ select: 9, 11, 12, 15

* SCSI IRQ select: 9, 11, 12, 15

APPENDIX

E

Optional Extras

E.1 PCM-10586-4 cable kit for PCM-9570/S

The PCM-9570/S requires several cables for normal operation. You can make them yourself or purchase an optional cable kit assembly, which includes the following:

Part No.	Cable description	PCM-9570/S connector	Terminating connector
1701440350	2.5" and 1.8" IDE, IDC44P/IDC44P, IDC44P	CN11	44-pin, 2 mm, female IDC (350 mm)
1701440500	3.5 IDE (40P), IDC40P/IDC40P/ Housing 44P	CN11	40-pin, 2.54 mm, female IDC (500 mm)
1701340603	Dual floppy, 3.5" and 5.25" (34P)	CN9	34-pin dual floppy (2.0 mm)
1700260250	Parallel port	CN12	25-pin female D-SUB (2.0 mm)
1701100202	Network, 10Base-T	CN1	RJ-45 8-pin modular jack (2.0 mm)
1700160150	VGA CRT	CN15	15-pin D-SUB
1700060200	Keyboard and PS/2 mouse	CN5	5-pin circular DIN, 6-pin circular DIN
1703030300	Peripheral power (-5 V and -12 V)	CN14	(3p - 3p) (300 mm)
1701080300	Front Panel	CN18	(8-conductor pigtail)
1701400181	COM 1-4 cable	CN20	40-pin, 9-pin male D-SUB x 4

E.2 USB cable

Optional USB cable, part no: 1703100260

E.3 SCSI cables

Optional Ultra Wide SCSI cable, 60 cm, part no: 1701680600
(HPP68M/HPP68M/HPP68M)

Optional Ultra2 Wide SCSI cable, 120 cm, part no. 1701060000

E.4 24-bit LCD cable adapter

This converts from the Hirose “DF20A” type connector transfer to a 20 x 2-pin header. It supports 3.3 V or 5 V LCDs via pins 5 and 6.

Part no: 9681000040 (3.3 V LCD)
9681000041 (5 V LCD)

APPENDIX

F

Mechanical Drawings

F.1 Component side

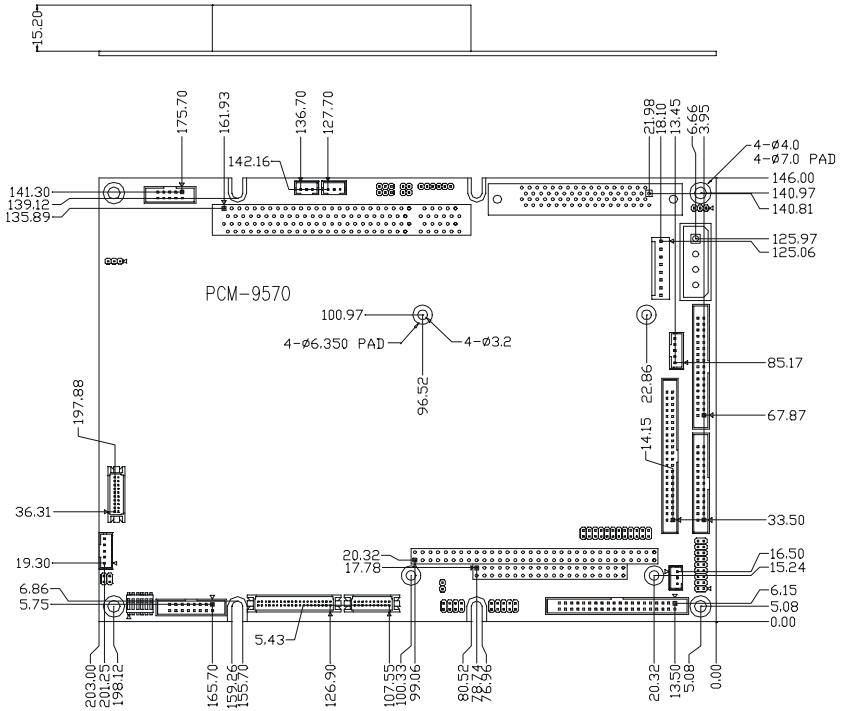

Figure F-1: PCM-9570/S mechanical drawing - component side

F.2 Solder side

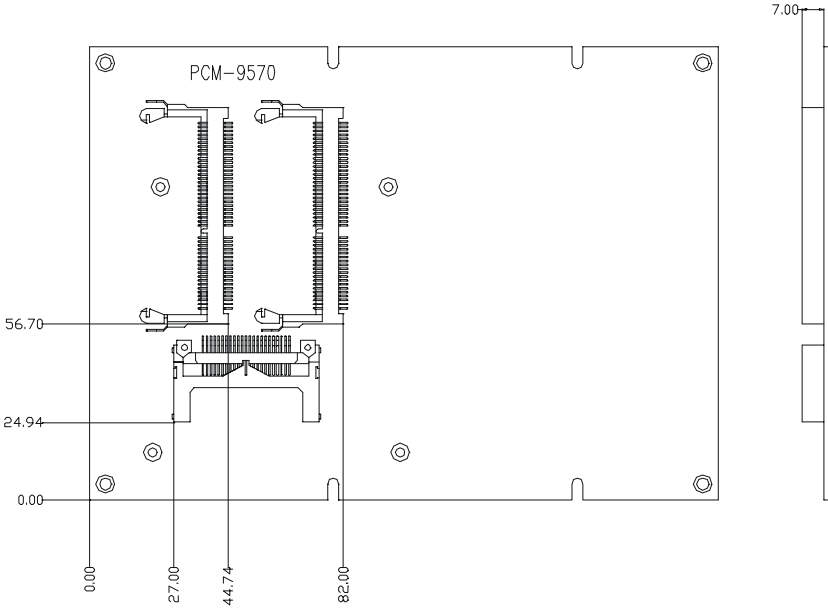

Figure F-2: PCM-9570/S mechanical drawing - solder side

Free Manuals Download Website

<http://myh66.com>

<http://usermanuals.us>

<http://www.somanuals.com>

<http://www.4manuals.cc>

<http://www.manual-lib.com>

<http://www.404manual.com>

<http://www.luxmanual.com>

<http://aubethermostatmanual.com>

Golf course search by state

<http://golfingnear.com>

Email search by domain

<http://emailbydomain.com>

Auto manuals search

<http://auto.somanuals.com>

TV manuals search

<http://tv.somanuals.com>