

DCD-PRO240

Professional Dual CD Player



Q-Start



AMERICAN AUDIO

4295 Charter Street
Los Angeles Ca. 90058
www.americandj.com
6/03

CONTENTS

CAUTIONS REGARDING HANDLING.....	3
PRODUCT INFORMATION.....	5
CUSTOMER SUPPORT	6
SET-UP.....	6
FEATURES.....	7
FUNCTIONS AND CONTROLS	
REMOTE UNIT.....	8
PLAYER UNIT.....	12
LIQUID CRYSTAL DISPLAY.....	13
BASIC OPERATION	
LOADING/EJECTING DISC.....	14
SELECTING TRACKS.....	14
STARTING/STOPPING PLAYBACK.....	14
ADJUSTING TIME DISPLAY.....	15
PITCH ADJUSTMENTS.....	15
PITCH BENDING.....	16
PROGRAMMING AND PROGRAM PLAY.....	17
FLIP-FLOP.....	18
SHUT DOWN PROCEDURES.....	18
HANDLING COMPACT DISC.....	19
WARRANTY.....	20
SPECIFICATIONS.....	21

Please Note: All specifications and improvements to and in the design of this unit and this manuals are subject to change at any time without any prior written or published noticed.

For service parts visit <http://parts.americandj.com>

ELECTRICAL SAFETY PRECAUTIONS

NOTE: This CD player uses a semiconductor laser. It is recommended for use in a room at the following temperature: 41°F - 95°F / 5°C - 35°C

CAUTION:

1. Handle the power supply cord carefully. Do not damage or deform; it may cause electric shock or malfunction when used. Hold plug attachment when removing from wall outlet. Do not pull on the cord.
2. To avoid electric shock, do not open the top cover when the unit is plugged in. If problems occur with the unit, call your local American Audio® dealer.
3. Do not place metal objects or spill liquid inside the CD player. Electric shock or malfunction may occur.

The serial and model number for this unit is located on the rear panel. Please write down the numbers here and retain for future reference.

Model No. _____

Serial No. _____

NOTE: This product satisfies FCC regulations when shielded cables and connectors are used to connect the unit to other equipment. To prevent electromagnetic interference with electrical appliances such as radios and televisions, use shielded cables and connectors for connections.

CAUTION:

USE OF CONTROLS OR ADJUSTMENTS OTHER THAN THOSE SPECIFIED HEREIN MAY RESULT IN HAZARDOUS RADIATION EXPOSURE

THE COMPACT DISC PLAYER SHOULD NOT BE ADJUSTED OR REPAIRED BY ANYONE EXCEPT PROPERLY QUALIFIED SERVICE PERSONNEL.

CAUTION: TO PREVENT ELECTRIC SHOCK DO NOT USE THIS (POLARIZED) PLUG WITH AN EXTENSION CORD, RECEPTACLE, OR OTHER OUTLET UNLESS THE BLADES CAN BE CAREFULLY INSERTED TO PREVENT BLADE EXPOSURE

ATTENTION: POUR PREVENIR LES CHOCS ELECTRIQUES NE PAS UTILISER CETTE FICHE POLARISEE AVEC UN PROLONGATEUR, UNE PRISE DE COURANT OU UNE AUTRE SORTIE DE COURANT, SAUF SI LES LAMES PEUVENT ETRE INSEREES A FOND SANS EN LAISSER AUCUNE PARTIE A DECOUVERT.

WARNING: TO PREVENT FIRE OR SHOCK HAZARD, DO NOT EXPOSE THIS UNIT TO WATER OR MOISTURE

This equipment has been tested and found to comply with the limits for a Class B digital device, pursuant to Part 15 of the FCC Rules. These limits are designed to provide reasonable protection against harmful interference in a residential installation. This equipment generates, uses, and can radiate radio frequency energy and, if not installed and used in accordance with the instructions, may cause harmful interference to radio communications. However, there is no guarantee that interference will not occur in a particular installation. If this equipment does cause harmful interference to radio or television reception, which can be determined by turning the equipment off and on, the user is encouraged to try to correct the interference by one or more of the following measures:

- Reorient or relocate the receiving antenna.
- Increase the separation between the equipment and receiver.
- Connect the unit into an electrical outlet on a circuit different from that to which the receiver is connected.
- Consult the dealer or an experienced radio/TV technician for help.

ELECTRICAL SAFETY PRECAUTIONS

ELECTRICAL PRECAUTIONS



The lightning flash with arrowhead symbol, within an equilateral triangle, is intended to alert the user to the presence of uninsulated "dangerous voltage" within the product's enclosure that may be of sufficient magnitude to constitute a risk of electric shock to persons.

CAUTION
RISK OF ELECTRIC SHOCK
DO NOT OPEN



The exclamation point within an equilateral triangle is intended to alert the user to the presence of important operating and maintenance (servicing) instructions in the literature accompanying the appliance.

IMPORTANT SAFETY INSTRUCTIONS

READ INSTRUCTIONS — All the safety and operating instructions should be read before the product is operated.

RETAIN INSTRUCTIONS — The safety and operating instructions should be retained for future reference.

HEED WARNINGS — All warnings on the product and in the operating instructions should be adhered to.

FOLLOW INSTRUCTIONS — All operating and use instructions should be followed.

CLEANING — The product should be cleaned only with a polishing cloth or a soft dry cloth. Never clean with furniture wax, benzene, insecticides or other volatile liquids since they may corrode the cabinet.

ATTACHMENTS — Do not use attachments not recommended by the product manufacturer as they may cause hazards.

WATER AND MOISTURE — Do not use this product near water — for example, near a bathtub, wash bowl, kitchen sink, or laundry tub; in a wet basement; or near a swimming pool; and the like.

ACCESSORIES — Do not place this product on an unstable cart, stand, tripod, bracket, or table. The product may fall, causing serious injury to a child or adult, and serious damage to the product. Use only with a cart, stand, tripod, bracket, or table recommended by the manufacturer, or sold with the product. Any mounting of the product should follow the manufacturer's instructions, and should use a mounting accessory recommended by the manufacturer.

CART — A product and cart combination should be moved with care. Quick stops, excessive force, and uneven surfaces may cause the product and cart combination to overturn.



VENTILATION — Slots and openings in the cabinet are provided for ventilation and to ensure reliable operation of the product and to protect it from overheating, and these openings must not be blocked or covered. The openings should never be blocked by placing the product on a bed, sofa, rug, or other similar surface. This product should not be placed in a built-in installation such as a bookcase or rack unless proper ventilation is provided or the manufacturer's instructions have been adhered to.

POWER SOURCES — This product should be operated only from the type of power source indicated on the marking label. If you are not sure of the type of power supply to your home, consult your product dealer or local power company.

LOCATION — The appliance should be installed in a stable location.

NONUSE PERIODS — The power cord of the appliance should be unplugged from the outlet when left unused for a long period of time.

GROUNDING OR POLARIZATION

- If this product is equipped with a polarized alternating current line plug (a plug having one blade wider than the other), it will fit into the outlet only one way. This is a safety feature. If you are unable to insert the plug fully into the outlet, try reversing the plug. If the plug should still fail to fit, contact your electrician to replace your obsolete outlet. Do not defeat the safety purpose of the polarized plug.

- If this product is equipped with a three-wire grounding type plug, a plug having a third (grounding) pin, it will only fit into a grounding type power outlet. This is a safety feature. If you are unable to insert the plug into the outlet, contact your electrician to replace your obsolete outlet. Do not defeat the safety purpose of the grounding type plug.

POWER-CORD PROTECTION - Power-supply cords should be routed so that they are not likely to be walked on or pinched by items placed upon or against them, paying particular attention to cords at plugs, convenience receptacles, and the point where they exit from the product.

OUTDOOR ANTENNA GROUNDING — If an outside antenna or cable system is connected to the product, be sure the antenna or cable system is grounded so as to provide some protection against voltage surges and built-up static charges. Article 810 of the National Electrical Code, ANSI/NFPA 70, provides information with regard to proper grounding of the mast and supporting structure, grounding of the lead-in wire to an antenna discharge unit, size of grounding conductors, location of antenna-discharge unit, connection to grounding electrodes, and requirements for the grounding electrode. See Figure A.

LIGHTNING — For added protection for this product during a lightning storm, or when it is left unattended and unused for long periods of time, unplug it from the wall outlet and disconnect the antenna or cable system. This will prevent damage to the product due to lightning and power-line surges.

POWER LINES — An outside antenna system should not be located in the vicinity of overhead power lines or other electric light or power circuits, or where it can fall into such power lines or circuits. When installing an outside antenna system, extreme care should be taken to keep from touching such power lines or circuits as contact with them might be fatal.

OVERLOADING — Do not overload wall outlets, extension cords, or integral convenience receptacles as this can result in a risk of fire or electric shock.

OBJECT AND LIQUID ENTRY - Never push objects of any kind into this product through openings as they may touch dangerous voltage points or short-out parts that could result in a fire or electric shock. Never spill liquid of any kind on the product.

SERVICING — Do not attempt to service this product yourself as opening or removing covers may expose you to dangerous voltage or other hazards. Refer all servicing to qualified service personnel.

DAMAGE REQUIRING SERVICE - Unplug this product from the wall outlet and refer servicing to qualified service personnel under the following conditions:

- When the power-supply cord or plug is damaged.
- If liquid has been spilled, or objects have fallen into the product.
- If the product has been exposed to rain or water.
- If the product does not operate normally by following the operating instructions. Adjust only those controls that are covered by the operating instructions as an improper adjustment of other controls may result in damage and will often require extensive work by a qualified technician to restore the product to its normal operation.
- If the product has been dropped or damaged in any way.
- When the product exhibits a distinct change in performance — this indicates a need for service.

REPLACEMENT PARTS — When replacement parts are required, be sure the service technician has used replacement parts specified by the manufacturer or have the same characteristics as the original part. Unauthorized substitutions may result in fire, electric shock, or other hazards.

SAFETY CHECK - Upon completion of any service or repairs to this product, ask the service technician to perform safety checks to determine that the product is in proper operating condition.

WALL OR CEILING MOUNTING — The product should not be mounted to a wall or ceiling.

HEAT — The product should be situated away from heat sources such as radiators, heat registers, stoves, or other products (including amplifiers) that produce heat.

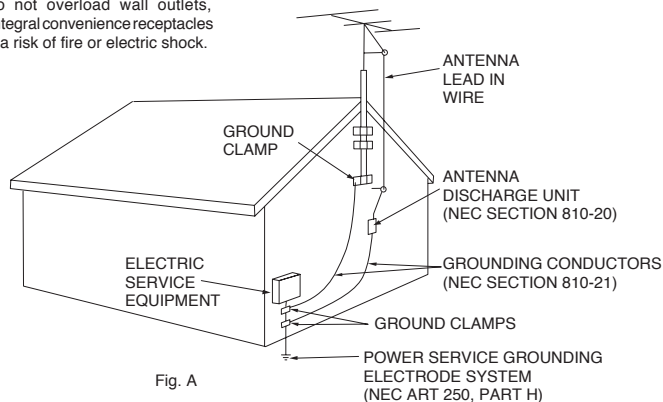

Fig. A

NEC — NATIONAL ELECTRICAL CODE

PRODUCT INFORMATION

1. Heat - The CD player should be situated away from heat sources such as radiators, heat registers, stoves, or other appliances (including amplifiers) that produce heat.
2. Do not let insecticides, benzene, or thinner come in contact with the surface of the unit.
3. Never disassemble or modify your unit in any way, doing so will void your manufacturer's warranty.
4. Never plug this unit into a dimmer pack.
5. Do not attempt to operate this unit if it becomes damaged in any way.
6. This unit is intended for indoor use only, use of this product outdoors voids all warranties.
7. Always mount this unit in a safe and stable manner.
8. Disconnect from main power before making any type of connection.
9. Cleaning -
 - The CD Player should be cleaned only as recommended by the manufacturer. Use a soft cloth to wipe down the outside of the unit. For stubborn stains, moisten a soft cloth with glass cleaner or other mild detergent to wipe away any stains. Use a soft cloth to wipe any residual cleaner. Never use volatile cleaners such as benzene, solvent, or thinner to clean your unit, these cleaners will damage the unit's surface.
 - Cleaning the pick-up lens - The pick-up lens should not become dirty under normal usage. If the lens does become dirty, contact American Audio Technical Support for further instructions. Third party lens cleaners are available but not highly recommended. Use of some of these cleaners may damage the pick-up lens, be sure to follow extreme caution when using these types of cleaners.

This unit has been thoroughly tested and has been shipped in perfect operating condition. Carefully check the shipping carton for damage that may have occurred during shipping. If the carton appears to be damaged, carefully inspect your unit for any damage. Be sure all accessories needed to operate the unit have arrived intact. In the event damage has been found or parts are missing, please contact our toll free customer support number for further instructions. Please do not return the unit to your dealer without first contacting customer support.

LINE VOLTAGE SELECTION

- The desired voltage may be set with the VOLTAGE SELECTOR switch on the rear panel (using a flat head screw driver).
- Do not force the VOLTAGE SELECTOR switch as this may cause damage.
- If the VOLTAGE SELECTOR switch does not move smoothly, please contact a qualified service technician.

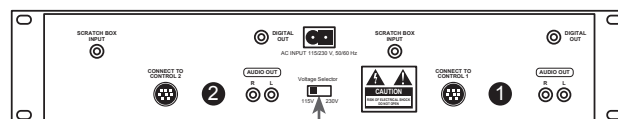

Voltage Line Selector Switch

WARRANTY INFORMATION

The DCD-PRO240™ carries a TWO year (730 days) limited warranty. This warranty covers parts and labor. Please fill out the enclosed warranty card to validate your purchase and warranty. All returned service items, whether under warranty or not, must be freight pre-paid and accompany a return authorization (R.A.) number. If the unit is under warranty, you must provide a copy of your proof of purchase invoice. Please contact American Audio® customer support at (800) 322-6337 for a R.A. number.

CUSTOMER SUPPORT

Customer Support: American Audio® provides a toll free customer support line, to provide set up help and to answer any question should you encounter problems during your set up or initial operation. You may also visit us on the web at www.AmericanAudio.us for any comments or suggestions. For service related issue please contact American Audio®. Service Hours are Monday through Friday 9:00 a.m. to 5:00 p.m. Pacific Standard Time.

Voice: (800) 322-6337
Fax: (323) 582-2941
E-mail: support@AmericanAudio.us

Warning! To prevent or reduce the risk of electrical shock or fire, do not expose this unit to rain or moisture.

Caution! There are no user serviceable parts inside this unit. Do not attempt any repairs yourself, doing so will void your manufactures warranty. In the unlikely event your unit may require service please contact customer support. Please do not return to your dealer without first contacting customer support.

SET-UP

1. Checking the Contents:

Be sure your DCD-PRO240™ was shipped with the following:

- | | |
|---|-------------------------------------|
| 1) DCD-PRO240™ Dual CD player unit. | 1) DCD-PRO240™ Controller Head Unit |
| 2) Dual Male to Male RCA cable. | 1) Warranty card. |
| 1) Operating instructions (this booklet). | |

2. Installing the Units

- 1) Place your unit on a flat surface or mount it in a secure rack mount case.
- 2) Be sure the player is mounted in a well ventilated area where it will not be exposed to direct sunlight, high temperatures, or high humidity.
- 3) Try to place the unit as far as possible from TVs and tuners, as the unit may cause undesirable interference.

3. Connections

- 1) Be sure main power is connected last to prevent any electrical damage.
- 2) AUDIO CONNECTIONS: Use the included RCA cable to connect the DCD-PRO240™ outputs to the line inputs of a mixer. Never connect a CD player's output to a mixers "phono" inputs.

CAUTION: Be sure to use the supplied control cables. Using a different type of cable may result in unit damage. To avoid server unit damage, be sure main power is off when connecting the control cables.

CAUTION:

- The player will work normally when the main unit is mounted with the front panel within 15 degrees of the vertical plane. If the unit is tilted excessively, discs may not be loaded or unloaded properly. (Figure 1)

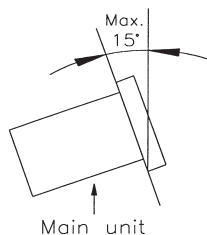

Figure 1

CAUTION:

- The LCD is designed to be clearly visible within the angles shown in Figure 2. Mount the control unit so that the visual angle is within this range.

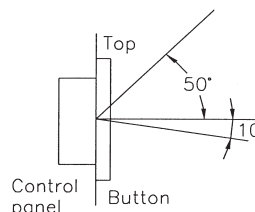

Figure 2

MAIN FEATURES

- 3 Selectable Colors for LCD Illumination
- Jog Wheel Pitch Bend (b)
- Single or Continuous Play
- Selectable Time Display
- Auto Cue
- Selectable Pitch: +/-8%, +/-12%, or +/-16%
- Flip Flop™ (Relay Playback) (d)
- 4 Different Speed Scans
- 8 Times Over Sampling 1 Bit D/A Converter
- 60 Second Transport Protection (a)
- Easy Track Programming
- 10+ Track Skipping
- Fader "Q" Start Control (c)
- 20 Programmable Tracks
- Pitch Display

(a) 60 SECOND TRANSPORT PROTECTION: The CD transport tray will automatically close if left open for more than 60 seconds. If a CD is left in the tray it will immediately cue.

(b) JOG WHEEL PITCH BEND: During normal playback, the inner jog wheel acts as a momentary pitch bend. Turning the wheel in a clockwise direction will increase the speed and turning the wheel in a counter-clockwise direction will decrease the speed.

(c) FADER "Q" START CONTROL: This feature is used in conjunction with American Audio® mixers that also feature "Fader Q Start" control. Connect your DCD-PRO240 as described in the set-up section of this manual. After set-up is completed, insert CD's in to both drives. By moving the mixer's crossfader from left to right you can start and pause your DCD-PRO240 playback functions. For Example, if your mixer's crossfader is all the way to the left player one is playing, player two is in cue or pause mode. If slice the fader at least 20% to the right, player one will continue to play and player two will begin to play, mixing both sides together. When the crossfader is slid all the way to the right, player two will be playing, and player one will go into cue or pause mode. You can create great effects similar to scratching with this feature. "Q" Start control is easy to use and mastering this feature will help you create amazing effects with your music.

(d) FLIP-FLOP™: This feature is used in conjunction with American Audio® mixers that also feature Fader "Q" Start. For FLIP-FLOP™ results you must use both disc drives. Connect your DCD-PRO240 as described in the set-up section of this manual. This feature will start the next player side once one player side has ended. For example, if disc drive one is playing a disc and it ends, disc drive two will instantly begin to play. You may set FLIP-FLOP™ to play track to track or disc to disc. For more information on this feature, see FLIP-FLOP™ on page 18.

GENERAL FUNCTIONS AND CONTROLS - REMOTE UNIT

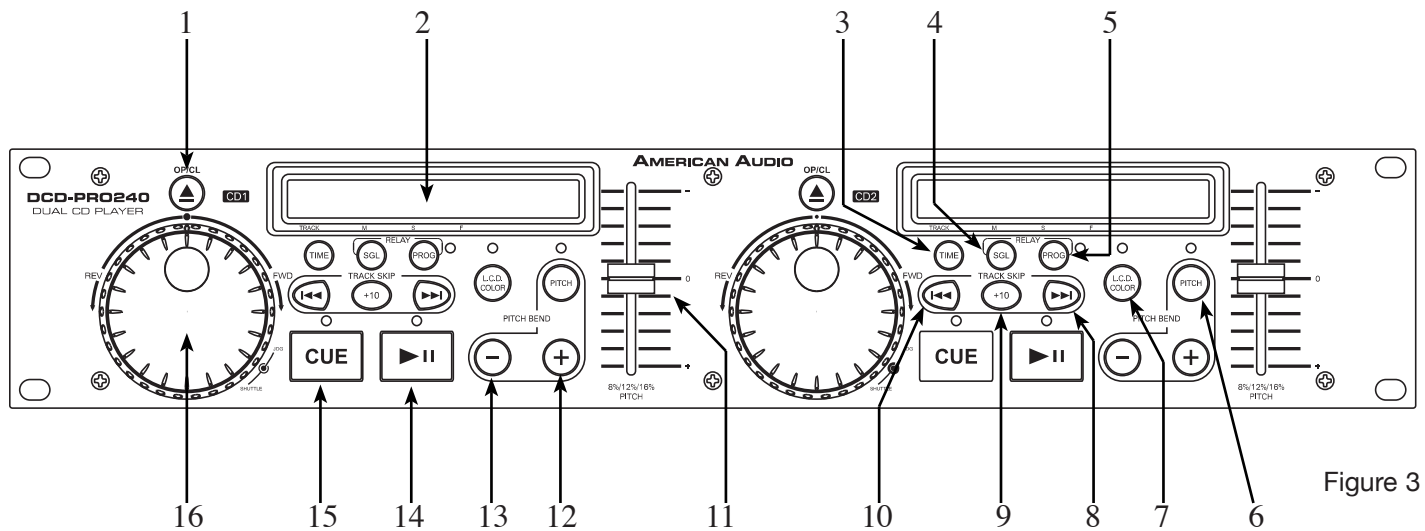

Figure 3

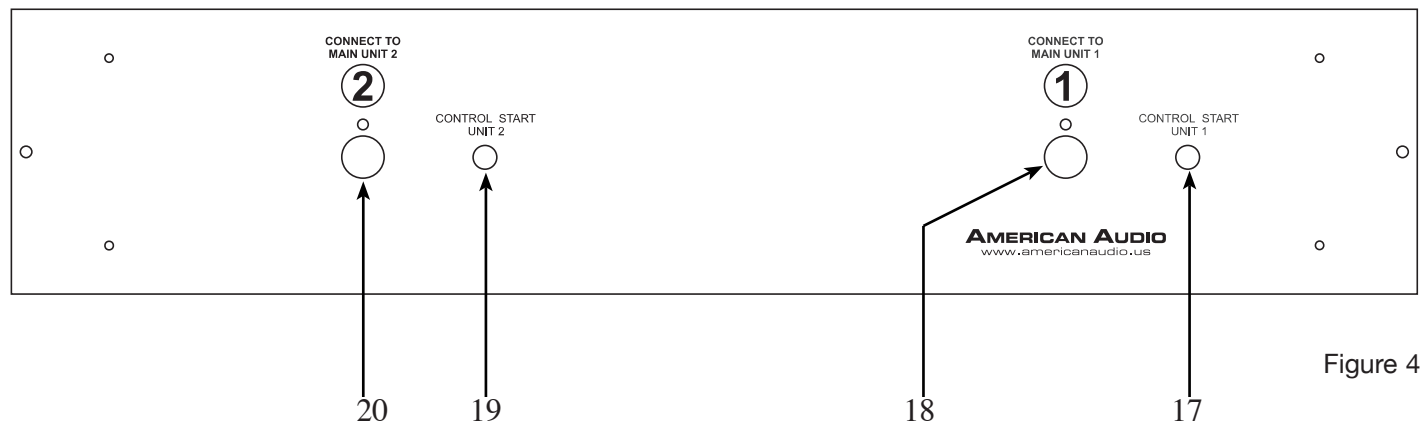

Figure 4

REMOTE CONTROL - FACE (FIGURE 3)

1. OPEN/CLOSE (Disc Tray Open/Close) - This button is used to open and close the disc transport tray door. NOTE: When a disc is loaded, the tray will not open unless the unit is in pause or cue mode.

2. LIQUID CRYSTAL DISPLAY (LCD) - This high quality LCD Indicates all the functions (play, pause, cue, etc...), as they occur. This display is viewable at several comfortable angles as described on page 6. The LCD icons will be described in the next section.

3. TIME - The TIME button is used to changed the displayed time values. Time can be displayed as elapsed track time, remaining track time, and total disc remaining time.

4. SGL - This button allows the unit's play mode to change between Single and Continuous. In single mode the unit will play a single track and return to cue mode. In continuous mode the unit continues to play track by track and returns to cue mode after all tracks have played. This function also operates in PROGRAM mode. In program mode the continuous function will play all tracks in a program,

GENERAL FUNCTIONS AND CONTROLS - REMOTE UNIT (CONT)

than return to cue mode on the first track in the program.

5. PRG - (PROGRAM BUTTON) The PROGRAM button will activate program mode. When program mode is activated the LED above the button will glow. For programming information see "Programming" on page 17.

6. PITCH BUTTON - This button is used to turn the pitch function on and off. The pitch functions of the PITCH SLIDER (11), PITCH BEND BUTTONS (12 & 13) and JOG WHEEL (16) will not function without this function being activated. By holding down this button and pressing (+) or (-) buttons, the pitch percentage value can be changed from (+/- 8%), (+/-12%), or (+/- 16%).

7. LCD COLOR - This button is used to change the illumination color of the LCD.

8. ►►| TRACK BUTTON - This button is used to select your desired track. Tapping this button will forward skip to the next track, holding down this button will rapidly forward skip through the tracks on your CD.

9. +10 TRACK SKIP - This button allows you to skip ahead by 10 tracks. Example: if you are at Track #1, pressing this button will skip you to Track #11, press the button again, it will skip to Track #21. If there are not that many tracks, it will go back to Track #1.

10. ◀◀| TRACK BUTTON - This button is used to select your desired track. Tapping this button will skip backward to the previous track, holding down this button will rapidly skip backward through the tracks on your CD.

11. PITCH SLIDER - This slider is used to adjust the playback pitch percentage when the PITCH (6) function is activated. The slider is a set adjustment and will remain set until the pitch slider is moved or the PITCH (6) function has been turned off. This adjustment can be made with or without a CD in the drive. The pitch adjustment will remain even if a disc has been removed, and will reflect on any other disc loaded into the unit. That is to say, if you set a +2% pitch on one disc, remove that disc and insert another, that disc will also have a +2% pitch. The amount of pitch being applied will be displayed in the LCD (2). Use this slider to match the BPM's of this unit to that of another music source. By changing the pitch of one disc with respect to the other in this way, the beats can be matched.

12. (+) PITCH BEND - The (+) pitch bend function creates a momentary "BUMP" in the CD's pitch speed (Beats per minute - BPM) when the PITCH (6) function is activated. This functions allows the beats between two CD's or any other music source to match. This is a momentary function. When the button is depressed the pitch speed will automatically return to PITCH SLIDER'S (11) selected pitch. Holding down this button will give a maximum of +16% pitch. Be sure to remember that this function is a momentary pitch adjustment, for a more precise adjustment use the PITCH SLIDER'S (11) to match the BPM's with another playing music source.

13. (-) PITCH BEND - The (-) pitch bend function creates a momentary "Slow Down" in the CD's pitch speed (Beats per minute - BPM) when the PITCH (6) function is activated. This functions allows the beats between two CD's or any other music source to match. This is a momentary function. When the button is depressed the pitch speed will automatically return to PITCH SLIDER'S (11) selected pitch. Holding down this button will give a maximum of -16% pitch. Be sure to remember that this function is a momentary pitch adjustment, for a more precise adjustment use the PITCH SLIDER'S (11) to match the BPM's with another playing music source.

14. PLAY/PAUSE BUTTON - Each press of the PLAY/PAUSE BUTTON causes the operation to change from play to pause or from pause to play. While in play mode the green play LED will glow, and while in pause mode the green play LED will flash.

GENERAL FUNCTIONS AND CONTROLS - REMOTE UNIT CONT.

15. CUE - Pressing the CUE button during playback immediately pauses playback and returns the track to the last set cue point. The red CUE LED will glow when the unit is in cue mode. The LED will also flash every time a new CUE POINT is set. The CUE button can also be held down to momentarily play the CD. When you release the CUE button it instantly returns to the last set CUE POINT.

16. SHUTTLE/JOG WHEEL -

Shuttle Wheel (Outer Ring) - This wheel has two forward and two reverse speed positions for speed searching through tracks. The more you turn the wheel in either direction, the faster you search.

Jog Wheel (Inner Wheel) - The inner wheel also works as a momentary pitch bend during playback. Turning the wheel clockwise will increase the pitch percentage up to +16%, and turning the wheel in the counter-clockwise direction will decrease the pitch percentage up to -16%. The pitch bend will be determined on how fast you turn the wheel.

REMOTE CONTROL - REAR (FIGURE 4)

17. CHANNEL 1 CONTROLLER JACK - Connect the supplied mini-plug from the CUE jack on the rear of your CD unit to the CONTROL out jack of a compatible American Audio® or American DJ® mixer. This will enable the CD "Q-Start" function. This feature is only available on American Audio® or American DJ® "Q" series mixers.

18. CHANNEL 1 REMOTE JACK - Connect the supplied 8 pin din cable from this jack to the player's channel 1 remote connector. This will allow you to control player 1's functions.

19. CHANNEL 2 CONTROLLER JACK - Connect the supplied mini-plug from the CUE jack on the rear of your CD unit to the CONTROL out jack of a compatible American Audio® or American DJ® mixer. This will enable the CD "Q-Start" function. This feature is only available on American Audio® or American DJ® "Q" series mixers.

20. CHANNEL 2 REMOTE JACK - Connect the supplied 8 pin din cable from this jack to the player's channel 2 remote connector. This will allow you to control the player functions.

GENERAL FUNCTIONS AND CONTROLS - PLAYER UNIT

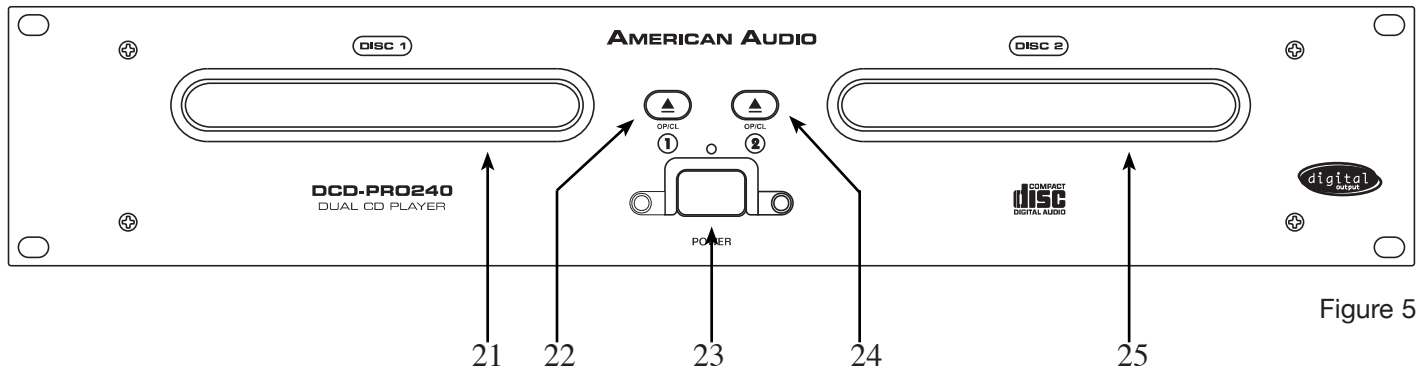

Figure 5

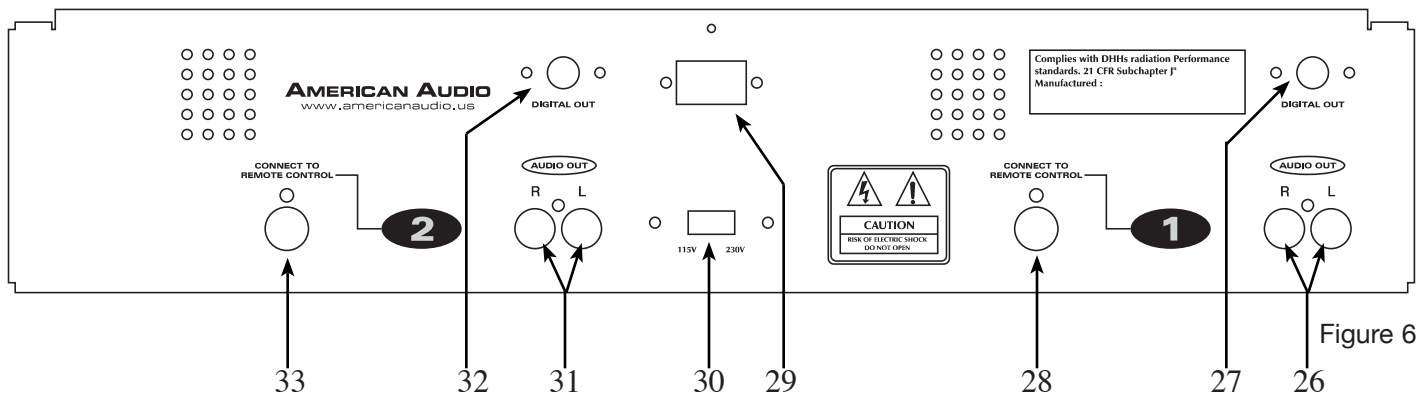

Figure 6

PLAYER UNIT - FACE (FIGURE 5)

21. DRIVE 1 TRANSPORT TRAY - This tray is used to load and unload a compact disc into the drive 1 mechanism. The tray is opened and closed by pressing the DRIVE 1 OPEN/CLOSE BUTTON (22). Never attempt to force the transport tray open or closed when the power is turned off.

22. DRIVE 1 OPEN/CLOSE (Transport Tray Open/Close) - This button is used to open and close the drive 1 transport tray. NOTE: When a disc is already loaded in the transport tray, the tray will not open unless the unit is in pause or cue mode.

23. POWER SWITCH - This switch is used to control the unit's main power. A blue LED directly above the power switch will glow to indicate main power is active.

24. DRIVE 2 OPEN/CLOSE (Transport Tray Open/Close) - This button is used to open and close the drive 2 transport tray. NOTE: When a disc is already loaded in the transport tray, the tray will not open unless the unit is in pause or cue mode.

25. DRIVE 2 TRANSPORT TRAY - This tray is used to load and unload a compact disc into the drive 2 mechanism. The tray is opened and closed by pressing the DRIVE 2 OPEN/CLOSE BUTTON (24). Never attempt to force the transport tray open or closed when the power is turned off.

TRANSPORT UNIT - REAR (FIGURE 6)

26. DRIVE 1 AUDIO OUT R & L - These jacks send a left and right analog mono output signal. Use these jacks to send standard audio to a mixer or receiver. The red colored jack represents the right

GENERAL FUNCTIONS AND CONTROLS - PLAYER UNIT

channel output and white jack represents the left channels output.

27. DRIVE 1 DIGITAL OUT - This jack sends a digital stereo out signal. Use this connection to create near perfect copies of your disc to a Mini disc, CD-R, or any other recording device with a digital input.

28. DRIVE 1 REMOTE JACK - Connect the supplied 8 pin cable from this jack to the remote control's channel 1 remote connector. This will allow you to control the player functions with the remote unit.

29. POWER CONNECTOR - This is the main power connection. Only use the supplied polarized power cord. Use of any other power may result in sever damage to the unit. Be sure the local power matches the unit's required power.

30. VOLTAGE SELECTOR - Because power supplies vary from location to location a voltage selector switch has been incorporated in the unit's design. This switch can select a voltage input of 120v or 220v to accommodate the two major power source. Always be sure to disconnect the power plug before changing the voltage.

31. DRIVE 2 AUDIO OUT R & L - These jacks send a left and right analog mono output signal. Use these jacks to send standard audio to a mixer or receiver. The red colored jack represents the right channel output and white jack represents the left channels output.

32. DRIVE 2 DIGITAL OUT - This jack sends a digital stereo out signal. Use this connection to create near perfect copies of your disc to a Mini disc, CD-R, or any other recording device with a digital input.

33. DRIVE 2 REMOTE JACK - Connect the supplied 8 pin cable from this jack to the remote control's channel 2 remote connector. This will allow you to control the player functions with the remote unit.

LIQUID CRYSTAL DISPLAY (LCD)

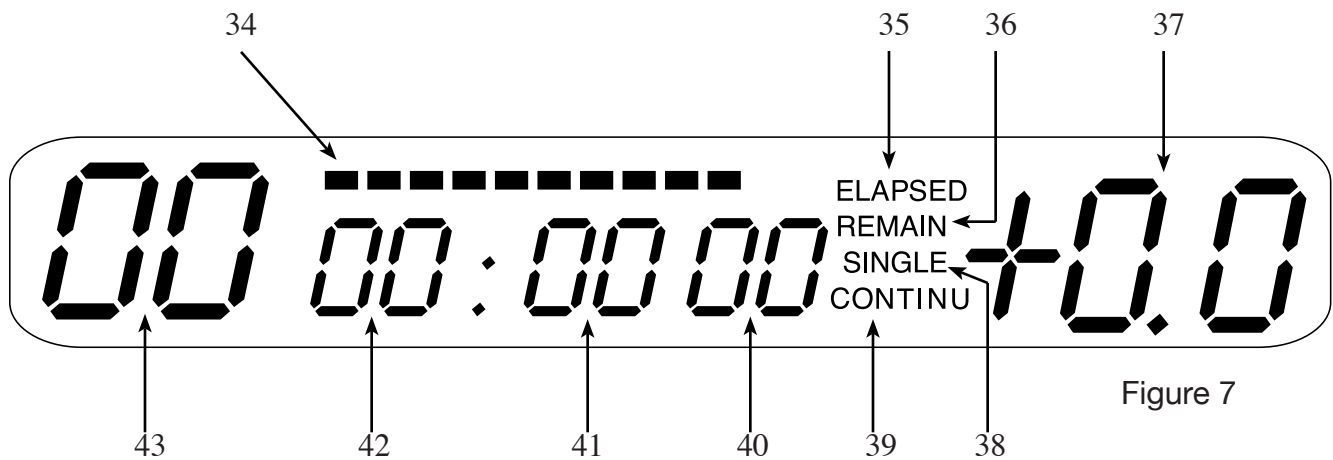

LCD DISPLAY (FIGURE 7)

34. TIME BAR INDICATOR - This bar visually details the time defined in the TIME METER (39, 40, & 41). As with the TIME METER (39, 40, & 41), this bar is also dependent on the selected time function REMAIN (35) OR ELAPSE (34). This bar will begin to flash when 15 seconds of a track remain and will begin to rapidly flash when three seconds of a track remain. The flashing bar is a great visual reminder a track is about to end. The flashing bar will function regardless of which time mode the unit is in.

35. ELAPSE INDICATOR - This indicator is in direct reference to the TIME METER (39, 40, & 41) When the ELAPSE indicator is displayed in the LCD (2), the time defined will refer to a single track's elapsed time. The time mode is changed by the tapping on the TIME BUTTON (3).

36. REMAIN INDICATOR - This indicator is in direct reference to the TIME METER (39, 40, & 41). When the REMAIN indicator is displayed in the LCD (2), the time defined will refer to a single track's remaining time. The time mode is changed by tapping on TIME BUTTON (3).

37. PITCH METER - This meter displays the pitch percentage being applied to playback by the PITCH SLIDER (11). If the meter read zero regardless of the PITCH SLIDER'S (11) position, the PITCH (6) function is not activated.

38. SINGLE INDICATOR - This indicates the unit is in single play mode. In single play mode, the unit will play a single and return to CUE mode.

39. CONTINU INDICATOR - This indicates the unit is in continuous play mode. In continuous play mode the unit will play through all the tracks on the disc. Once all the tracks have ended the unit will return to cue mode.

40. FRAME METER - This meter will display the elapse, total, or frames. The displayed frames will be indirect reference to the current time mode.

41. SECONDS METER - This meter will display the elapse, total, or remaining time in seconds. The display time will be indirect reference to the current time mode.

42. MINUTES METER - This meter will display the elapse, total, or remaining time in minutes. The display time will be indirect reference to the current time mode.

43. TRACK INDICATOR - This double digit indicator details a current track. The number displayed in the track indicator is a direct reference to a track being selected for programming or a track in play, pause, or cue mode.

BASIC OPERATIONS

1. OPENING AND CLOSING THE DISC TRAY/LOADING DISCS

This is an electronic operation and can only work when the power is on. Press the OPEN/CLOSE BUTTON (1) to open or close the disc tray. Pressing the PLAY/PAUSE BUTTON (14), will also automatically close the tray if it is open and immediately cue any CD that is in it. If the transport tray is left open for more than 60 seconds it will close automatically to prevent accidental damage to the transport. Again if a CD is left in the transport tray it will immediately cue to the first song. The disc trays cannot be opened during playback to prevent playback from being interrupted if the OPEN/CLOSE BUTTON (1) is pressed accidentally. Stop playback, then press the OPEN/CLOSE BUTTON (1).

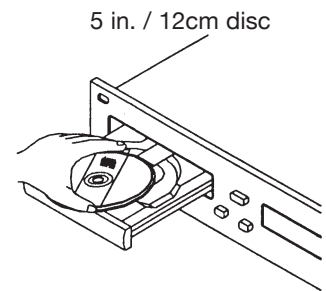

Figure 7

2. LOADING DISCS

The DCD-PRO240 can play both 3 inch (8 cm) and 5 inch (12 cm) compact discs (CD's). Odd shaped and oval CD's are not compatible. When loading a CD into the unit always hold the disc by its' edges and place it in the disc tray. Never touch the signal surface (the glossy side). When using 5 inch/12 cm discs, place the disc in the outer tray guides (figure 7), and when using 3 inch/8 cm discs, place them securely in the inner guides (figure 8).

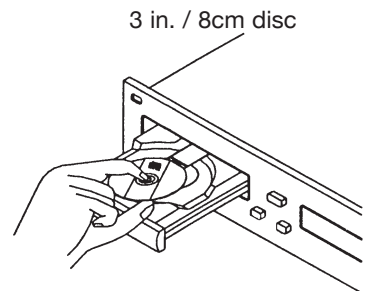

Figure 8

CAUTION:

- NEVER insert any foreign objects in the disc tray.
- NEVER attempt to insert more than one disc in the disc tray at a time. Doing so may result in severe damage to the unit.
- NEVER force the transport tray open or closed when the power is off, as this may result in malfunction and damage the transport system.

3. SELECTING TRACKS

Select a desired track by using either of the two TRACK BUTTONS (8 & 10). Tapping the TRACK BUTTONS (8 & 10) once will select either a higher or lower track. You may hold down the TRACK BUTTONS (8 & 10) to change tracks continuously at a higher speed. If you are using the TRACK BUTTONS (8 & 10) to select a new track during playback (a track already playing) the new track you selected will immediately begin playback as soon as the search operation is completed.

4. STARTING PLAYBACK

Insert an audio CD as described above (loading discs). Pressing the PLAY/PAUSE BUTTON (14) with an audio CD inserted will immediately start playback. The point at which playback starts (cue point) will automatically be stored in the memory as the cue point. The unit will return to this cue point (the point at which playback started) when the CUE BUTTON (15) is pressed.

5. STOPPING PLAYBACK

Stopping playback will not stop the drive mechanism, but merely pause or cue the track. There are two ways to stop playback:

- 1) Press the PLAY/PAUSE BUTTON (14) during playback to pause at that point.
- 2) Press the CUE BUTTON (15) during playback to return the track to it's last cue point.

6. PAUSING

Pausing temporarily stops playback. Pressing the PLAY/PAUSE BUTTON (14) changes the operating mode between play and pause.

7. AUTO CUE

"Cueing" is the action of preparing for playback. The unit is designed to automatically cue at the first audible signal on the first track of a disc when a disc is inserted. If a track is selected before a disc is inserted, the unit will automatically cue to the first audible signal for the selected track.

BASIC OPERATIONS (CONT)

8. CHANGING THE TIME DISPLAY (39, 40, & 41)/TIME BAR (33):

The time may be displayed in three different modes; Elapsed, Remain, and Total Remain. During normal playback, pressing the TIME BUTTON (3), will change the time display information (39, 40, & 41) in the LCD (2). The following is a break down of the time settings and their definitions:

- 1) ELAPSED (34) - This details the time in the LCD (2) as the current tracks' elapsed running time. The elapsed function only details a tracks elapsed time and not the entire disc.
- 2) REMAIN (35) - This details the time in the LCD (2) as the current tracks' remaining running time. By pressing the button again, it will read the total disc remaining time.

TIME BAR INDICATOR - The time bar in the LCD (2) visually details the time defined in the TIME METER (39, 40, & 41). This bar is also dependent on the selected time function REMAIN (35) or ELAPSE (34). This bar will begin to flash when 15 seconds of a track remain and will begin to rapidly flash when three seconds of a track remain. The flashing bar is a great visual reminder a track is about to end. The flashing bar will function regardless of which time mode the unit is in.

9. PITCH ADJUSTMENTS:

This function will increase or decrease a tracks playback speed or "PITCH," this is not a momentary change as in "PITCH BENDING" (see page 16). The maximum pitch bend percentage allowed is +/-16%. The PITCH SLIDER (11) is used to decrease or increase the playback pitch. If the slider is move up (towards the top of the unit) the pitch will decrease, if the slider is moved down (towards the bottom of the unit) the pitch will increase. The PITCH SLIDER (11) adjustment can be changed to range from +/-8%, +/- 12, or +/-16%. The pitch adjustments will affect playback.

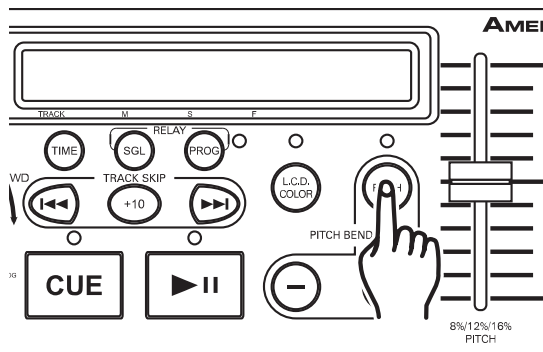

Figure 9

Activating the Pitch Slider (11): To activate the PITCH SLIDER (11), turn the pitch function on. Press the PITCH BUTTON (6) to turn on the pitch function, when the pitch function is activated a LED will begin to glow. If the pitch function is not activated neither the PITCH SLIDER (11) nor the PITCH BEND BUTTONS (12 & 13) will not function.

Using the Pitch Slider (11): To use the PITCH SLIDER (11) slide the slider up and down. Down will increase the pitch and up will decrease the pitch.

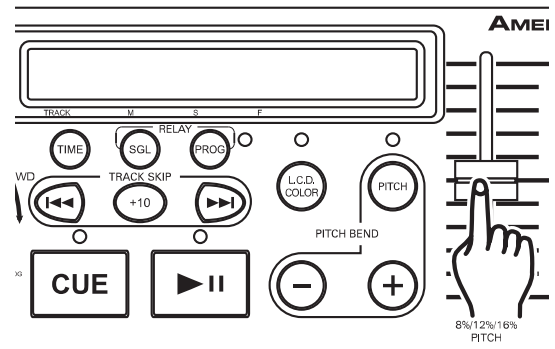

Figure 10

BASIC OPERATIONS (CONT)

10. PITCH BEND:

This function will momentarily increase or decrease a tracks playback speed. There are two ways to operate this function with the (-) & (+) PITCH BEND BUTTONS (12 & 13) or with the JOG WHEEL (16). The maximum pitch bend percentage allowed is +/- 16%. The pitch bend function will work in conjunction with the PITCH SLIDER (11) pitch setting. The PITCH SLIDER (11) adjustment can be changed to range from +/-8%, +/-12%, or +/-16%. For example, if the PITCH SLIDER (11) is set to a 2% pitch gain the pitch bending process will begin at 2% and will continue to the maximum of +/-16%.

PITCH BEND BUTTONS (12 & 13):

The (+) PITCH BEND BUTTON (12) will provide a speed bump and the (-) PITCH BEND BUTTON (13) will provide a slow down. The extent to which the speed changes is proportionate to the amount of time the button is pressed. For example, if the (+) PITCH BEND BUTTON (12) is held down continuously, the disc speed will increase and will continue to increase until reaches a maximum of 100% speed gain. When you release the (+) PITCH BEND BUTTON (12) the disc speed will automatically return to it's previous speed.

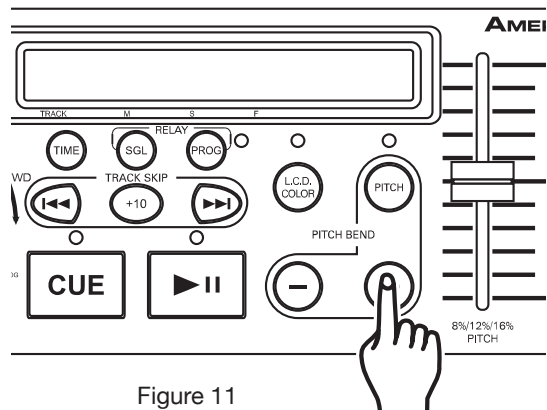

Figure 11

Holding down or tapping on the (+) PITCH BEND BUTTON (12) will provide a speed bump in the playback pitch.

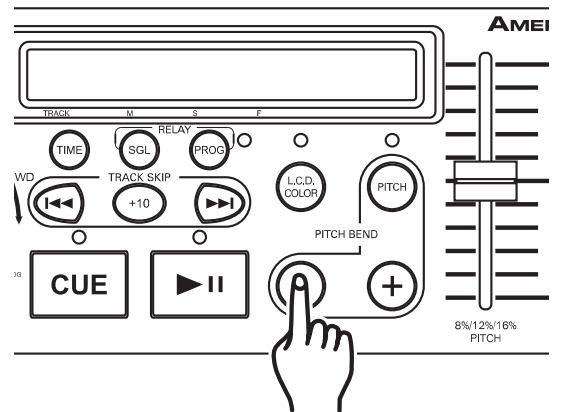

Figure 12

Holding down or tapping on the (-) PITCH BEND BUTTON (13) will provide a slow down in the playback pitch.

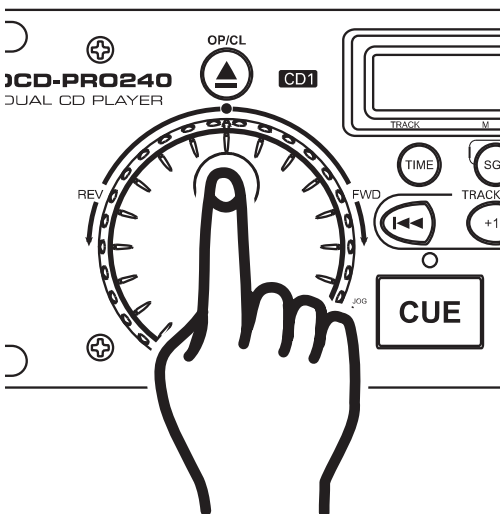

Figure 13

JOG WHEEL (16):

The JOG WHEEL (16) will temporarily bend the pitch if a track is in play mode. Rotating the wheel in a clockwise direction will increase your track pitch and rotating the wheel in a counter-clockwise direction will slow your track pitch. The speed you rotate the JOG WHEEL (16) will determine pitch bend percentage (%).

BASIC OPERATIONS (CONT)

11. PROGRAM PLAY

This operation allows you to customize your disc playback. You may select specific tracks to played and the order they will be played in. You may program a maximum of 20 tracks at once and program a single track to played more than once. To create a program:

- 1) Be sure a disc is inserted in the drive and press the PROG Button (5). Pressing the PROG Button (5) from any function will immediately pause the disc and enter the program mode.
- 2) After activating the program mode the PROGRAM INDICATOR LED will begin to glow indicating Program Mode has been activated.

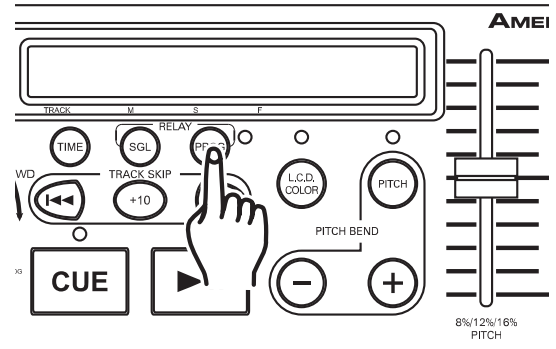
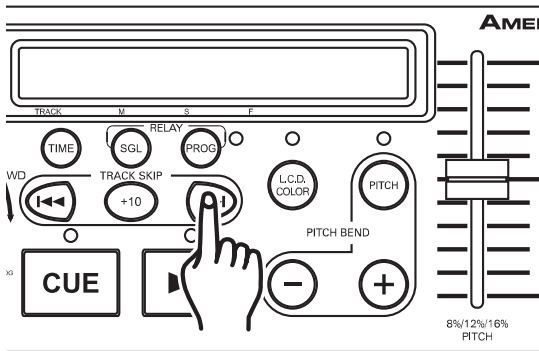

Figure 14



- 3) Select a track to be programmed by using the FORWARD TRACK SKIP (21) and BACK SKIP TRACK BUTTON (20).

Figure 15

- 4) Once you reach the track you wish to place into the program memory press PROG Button (13). Doing this will lock the track into memory.

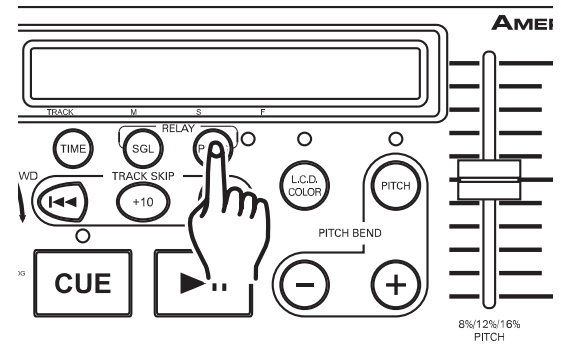

Figure 16

- 5) Repeat steps three and four up to 19 times (up to 20 tracks may be programmed).
- 6) As you program tracks into memory, the LCD (2) will indicate how many tracks have been programmed.

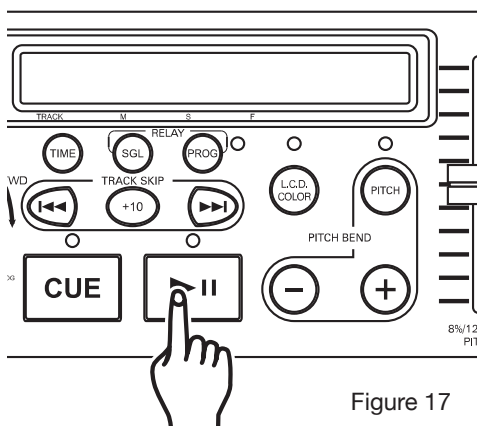

Figure 17

- 7) When you have finished your programming and are ready to begin playback simply press the PLAY/PAUSE BUTTON (14) and your program will begin to play.
- 8) After you have complete your program you can always add more tracks to your program by repeating the steps one through four. Remember that you can only a maximum of 20 track in a program and you can only add track not subtract.
- 9) To cancel and clear the program press and hold down the PROG Button(5) for more than two seconds, until the LED light turns off.

BASIC OPERATIONS (CONT)

12. FLIP-FLOP™

This feature is a kind of "auto pilot." "Flip-Flop™" mode can only function with the both drives of the DCD-PRO240. The "Flip-Flop™" function may be used with or without an American Audio® or American DJ® "Q" deck mixer. With "Flip-Flop™" you can have one disc drive begin playback when the other ends. You can "Flip Flop™" single tracks, the entire disc, a combination of the two, or you can even "Flip-Flop™" your programmed tracks.

To FLIP-FLOP™ single tracks or programmed tracks:

- 1) Connect your system as described in the set up section on page 6.
- 2) Set your mixer's crossfader to the center position.
- 3) Load disc drives with audio discs.
- 4) Press and hold the Program button (5), simultaneously press the Single button (4). Doing this will activate Flip-Flop™ mode. The track numbers on the LCD should be blinking, letting you know that Flip-Flop™ mode has been activated.
- 5) After they have both cued, press the PLAY/ PAUSE BUTTON (14) on one of your drives to begin playback.
- 6) After the first cds' single track has ended the second cds' track will immediately begin playback.
- 7) FLIP FLOP™ will continue until you stop it or power is interrupted.
- 8) To deactivate Flip-Flop™ mode, repeat step 4.

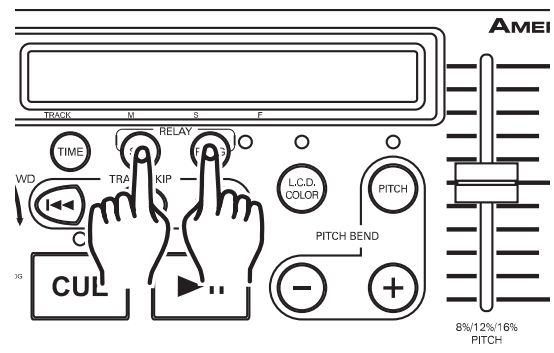
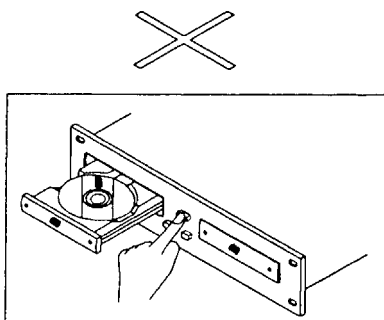

Figure 18

BEFORE SWITCHING OFF THE POWER

- When you have finished using the CD unit, and before switching off the power, be sure that the disc holder has been closed with the OPEN/CLOSE button.
- TRAY PROTECTION: If tray is not closed after 60 seconds, it will close automatically and pause.

CAUTION: DO NOT forcibly close the disc holder when the power is off.



Do not switch off the power when the disc holder is open.

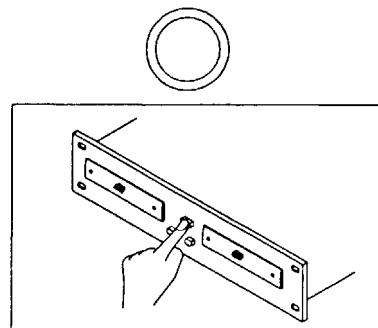

Switch off the power after the disc holder has been closed with the OPEN/CLOSE button.

DO NOT switch off the power when the disc holder is open. Switch off the power after the disc holder has been closed with the OPEN/CLOSE BUTTON (1).

COMPACT DISCS

1. PRECAUTIONS ON HANDLING COMPACT DISCS

Compact disc are constructed of the same types of plastic record are. To avoid severe damage to you valuable disc please observe the following guide lines. Following the these guide lines will ensure long disc life.

- Do not allow fingerprints, oil or dust to get on the surface of the disc. If the disc is dirty, wipe it off with a soft dry cloth.
- Do not use benzene, thinner, water, record spray, electrostatic-proof chemicals, or silicone-treated cloths to clean discs.
- Always handle discs carefully to prevent damaging the surface; in particular when removing a disc from the jewel case.
- Do not bend the disc.
- Do not apply heat.
- Do not enlarge the hole in the center of the disc.
- Do not write on the label (printed side) with a hard tipped implement such as a pencil or ball point pen.
- Condensation will form if a disc is brought into a warm area from a colder one, such as outdoors in winter. Do not attempt to dry the disc with a hair dryer, etc.

2. PRECAUTION ON STORAGE

- After playing a disc, always unload it from the unit.
- Always store the compact disc in the jewel case, protecting from dirt or damage.
- Do not place discs in the following areas:
 - a) Areas exposed to direct sunlight for a considerable time.
 - b) Areas subject to accumulation of dust or high humidity.
 - c) Areas affected by heat from indoor heaters, etc.

WARRANTY

2-YEAR LIMITED WARRANTY

A. American Audio® hereby warrants, to the original purchaser, American Audio® products to be free of manufacturing defects in material and workmanship for a period of 2 Year (730 days) from the date of purchase. This warranty shall be valid only if the product is purchased within the United States of America, including possessions and territories. It is the owner's responsibility to establish the date and place of purchase by acceptable evidence, at the time service is sought.

B. For warranty service, send the product only to the American Audio® factory. All shipping charges must be pre-paid. If the requested repairs or service (including parts replacement) are within the terms of this warranty, American Audio® will pay return shipping charges only to a designated point within the United States. If the entire instrument is sent, it must be shipped in its original package. No accessories should be shipped with the product. If any accessories are shipped with the product, American Audio® shall have no liability whatsoever for loss of or damage to any such accessories, nor for the safe return thereof.

C. This warranty is void if the serial number has been altered or removed; if the product is modified in any manner which American Audio® concludes, after inspection, affects the reliability of the product; if the product has been repaired or serviced by anyone other than the American Audio® factory unless prior written authorization was issued to purchaser by American Audio®; if the product is damaged because not properly maintained as set forth in the instruction manual.

D. This is not a service contract, and this warranty does not include maintenance, cleaning or periodic check-up. During the period specified above, American Audio® will replace defective parts at its expense, and will absorb all expenses for warranty service and repair labor by reason of defects in material or workmanship. The sole responsibility of American Audio® under this warranty shall be limited to the repair of the product, or replacement thereof, including parts, at the sole discretion of American Audio®. All products covered by this warranty were manufactured after January 1, 1990, and bear identifying marks to that effect.

E. American Audio® reserves the right to make changes in design and/or improvements upon its products without any obligation to include these changes in any products theretofore manufactured.

F. No warranty, whether expressed or implied, is given or made with respect to any accessory supplied with products described above. Except to the extent prohibited by applicable law, all implied warranties made by American Audio® in connection with this product, including warranties of merchantability or fitness, are limited in duration to the warranty period set forth above. And no warranties, whether expressed or implied, including warranties of merchantability or fitness, shall apply to this product after said period has expired. The consumer's and or Dealer's sole remedy shall be such repair or replacement as is expressly provided above; and under no circumstances shall American Audio® be liable for any loss or damage, direct or consequential, arising out of the use of, or inability to use, this product.

G. This warranty is the only written warranty applicable to American Audio® Products and supersedes all prior warranties and written descriptions of warranty terms and conditions heretofore published.

SPECIFICATIONS

GENERAL	Model: American Audio® DCD-PRO240™ - Professional Compact Disc Player
System:	Dual, CD Tray Loading, Digital Compact Disc Audio Player.
Disc type:	Standard compact discs (5 in / 12cm and 3in/8cm discs)
Dimensions:	Player unit: 19" (W) x 3 15/32" (H) x 9 55/64" (D) 482mm (W) x 88.8mm (H) x 262mm (D) (without feet) Control unit: 19"(W) x 5 3/4" (H) x 1 37/64" (D) 482mm (W) x 88.8mm (H) x 97mm (D) (without feet)
Installation:	Place on flat surface or mount in flat case
Weight:	5 Lbs. / 2 kgs
Power supply:	AC 115v/230v, 50/60Hz
Power consumption:	25W
Pitch control range:	+/-8%, +/-12%, +/-16%
Pitch bend:	+/-16%
Pitch accuracy:	0.1%
Environmental conditions:	Operational temperature: 5 to 35°C (41 to 95°F) Operational humidity: 25 to 85% RH (non-condensation) Storage temperature: -20 to 60°C (4 to 140°F)
Accessories:	Dual RCA Cable (for left and right channels) Control 1/8" miniplug type (3 feet)

AUDIO SECTION

Quantization:	16 bit linear per channel
Sampling rate:	44.1 kHz at normal pitch
Over sampling rate:	8 times over sampling 1 bit D/A converter
D/A conversion	16 bit
Frequency response:	+/- 1 dB 20 Hz to 20 KHz
Output level:	2.0V +/- 1dB
Load impedance:	47k ohm or more

AUDIO CHARACTERISTICS (TEST DISC: TCD-782, LOAD=47Kohm)

ITEM	NOMINAL	LIMIT	CONDITION
Output level	2.0Vrms	2.0V+/-1dB	1KHz,0dB
Channel balance	0.5dB	1.0dB	1KHz,0dB
Frequency response	+/-0.5dB	+/-1.0dB	20Hz-20KHz,0dB
De-emphasis response	+/-0.5dB	+/-1dB	20Hz-16KHz
Channel separation*	86dB	80dB	1KHz,0dB
T.H.D. + NOISE*	0.01%	0.02%	1KHz,0dB
S/N ratio (IHF-A)*	94dB	85dB	1KHz.0dB

NOTE: *With 20KHz low pass filter.

SEARCHING TIME (TEST DISC: TCD-792)

ITEM	NOMINAL	LIMITS	CONDITION
Short access time	1.7 sec	4 sec	Play next track
Long access time	3 sec	6 sec	Track 1 ->Track 20 / Track 20 ->Track 1
CD recover time	1 sec	2 sec	CD play interrupted by mechanical shock

PLAYABILITY

ITEM	NOMINAL	LIMIT	CONDITION
Interruption	1000um	800um	TCD-725
Black dot	1000um	600um	TCD-725
Finger prints	75um	65um	TCD-725
Eccentricity	140um	140um	TCD-712,
Vertical deviation	1mm	500um	TCD-731R

PICK-UP

System	Object lens drive system optical pick-up
Object lens drive system	2 dimensional parallel drive
Tracking detection	3 spot beam detection
Optical source	Semiconductor laser
Wave length	780nm



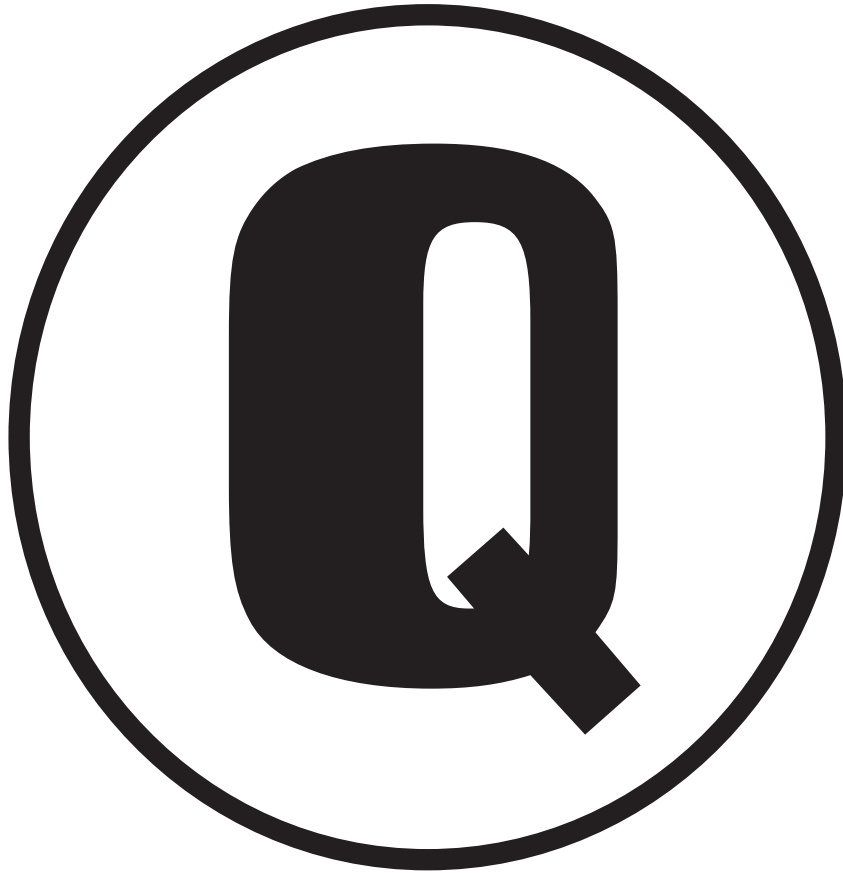

©American Audio®
A Division of the American DJ® Group of Companies
American Audio® World Headquarters:
4295 Charter Street
Los Angeles, CA 90058 USA
Tel: 323-582-2650 Fax: 323-582-2610
Web: www.AmericanAudio.us E-mail: info@AmericanAudio.us

Free Manuals Download Website

<http://myh66.com>

<http://usermanuals.us>

<http://www.somanuals.com>

<http://www.4manuals.cc>

<http://www.manual-lib.com>

<http://www.404manual.com>

<http://www.luxmanual.com>

<http://aubethermostatmanual.com>

Golf course search by state

<http://golfingnear.com>

Email search by domain

<http://emailbydomain.com>

Auto manuals search

<http://auto.somanuals.com>

TV manuals search

<http://tv.somanuals.com>