

**IVIE Enterprises**

[www.ivie-ent.com](http://www.ivie-ent.com)

Ph:(918)254-5161 or (888)262-5161 Fax:(918)250-4807



**Operator's  
Manual**

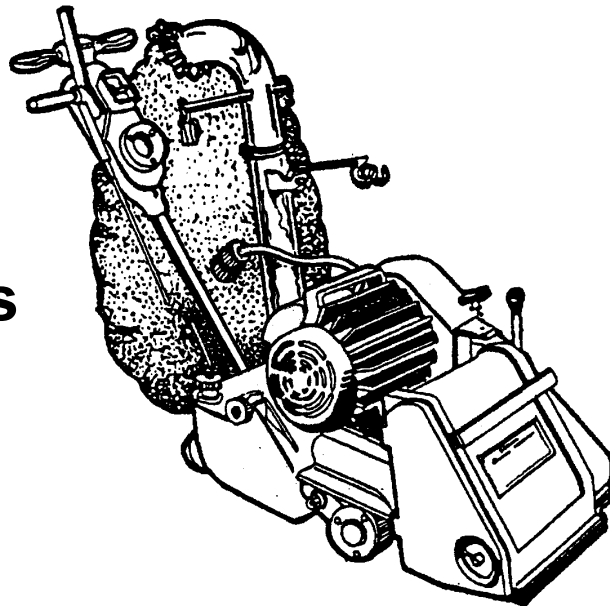

**Classic 8  
Belt Sander**

### **READ THIS BOOK**

This book has important information for the use and safe operation of this machine. Failure to read this book prior to operating or attempting any service or maintenance procedure to your ALTO machine could result in injury to you or to other personnel; damage to the machine or to other property could occur as well. You must have training in the operation of this machine before using it. If your operator cannot read English, have this manual explained fully before attempting to operate this machine.

Si Ud. o sus operadores no pueden leer el Inglés, se hagan explicar este manual completamente antes de tratar el manejo o servicio de esta máquina.

All directions given in this book are as seen from the operator's position at the rear of the machine.

For new books write to: **ALTO U.S. INC., 2100 Highway 265, Springdale, Arkansas 72764.**

## Contents of this Book

Operator Safety Instructions .....	3
Machine Safety Statements .....	5
Introduction and Machine Specifications .....	6
230V Electrical Connection Instructions .....	7
How to Transport the Machine .....	8
One Person .....	8
Two People .....	9
Machine Set-Up .....	10
How to Operate the Machine .....	11
Sanding Cuts and Sandpaper .....	14
Sander Adjustment Procedures .....	15
Routine Maintenance .....	17
Troubleshooting .....	18
Assembly Drawing #1 .....	20
Assembly Parts List #1 .....	21
Tension Assembly .....	22
Tension Assembly Parts List .....	23
Assembly Drawing #2 .....	34
Assembly Parts List #2 .....	25
Assembly Drawing #3 .....	26
Assembly Parts List #3 .....	27
Wiring Diagram .....	28
Chatter Wave Prevention .....	29
Chatter Causes and Prevention .....	29

### IVIE Enterprises

[www.ivie-ent.com](http://www.ivie-ent.com) Ph:(918)254-5161 or (888)262-5161 Fax:(918)250-4807

# OPERATOR SAFETY INSTRUCTIONS



**WARNING**



**AVERTISSEMENT**



**ADVERTENCIA**

<b>DANGER</b> means:	Severe bodily injury or death can occur to you or other personnel if the <b>DANGER</b> statements found on this machine or in this Owner's Manual are ignored or are not adhered to. Read and observe all <b>DANGER</b> statements found in this Owner's Manual and on your machine.
<b>WARNING</b> means:	Injury can occur to you or to other personnel if the <b>WARNING</b> statements found on your machine or in this Owner's Manual are ignored or are not adhered to. Read and observe all <b>WARNING</b> statements found in this Owner's Manual and on your machine.
<b>CAUTION</b> means:	Damage can occur to the machine or to other property if the <b>CAUTION</b> statements found on your machine or in this Owner's Manual are ignored or are not adhered to. Read and observe all <b>CAUTION</b> statements found in this Owner's Manual and on your machine.



**DANGER:**

Read the operator's manual before servicing or operating this machine. The manual contains information essential to the safe and reliable use of this machine.



**DANGER:**



Sanding/finishing wood floors can create conditions that could produce a fire or explosion. Follow these precautions:

- Do not sand over exposed nails. The grindings may enter the dust bag and ignite the contents. Set all exposed nails before sanding.
- Do not sand over sanding abrasive particles or embedded stones. The grindings may enter the dust bag and ignite the contents. Remove particles or stones before sanding.
- Do not leave wood dust in bag. The contents may spontaneously ignite or explode. Dispose in a metal container clear of any combustibles. Do not dispose in a fire.
- Do not use this machine with or near flammable fuels or agents. Read the manufacturer's label on all chemicals to determine flammability. Vapors or airborne wood dust can create an explosive environment. Open flames, electrical sparks or other sources of ignition should be extinguish or avoided. Do not over fill the dust bag. Ventilate the work area.
- Do not operate the machine on an electrical circuit that repeatedly trips or blows the fuse. The circuit may be undersized or faulty which could cause an electrical fire.



**DANGER:**



This machine operate on electric power. The power is sufficient to cause shock or electrocution. Follow these precautions:

- Do not connect the machine to an electrical circuit that has no grounding conductor. The grounding conductor will drain the power from the machine, should it become electrified. Consult an electrician if the grounding conductor is missing or you suspect the circuit has no grounding conductor. Do not remove or disable the grounding conductor on the electrical cord. For added protection, use machine on a circuit equipped with a ground fault circuit interrupter.
- Do not service the machine while connected to an electrical circuit. Doing so might result in contact with electrical components.
- Do not use the machine with a damaged electrical cord. Inspect the cord for damage to the jacket and connector(s) before connecting the machine to an electrical circuit. Do not use the cord to move the machine. Keep the cord clear of the sanding drum. Lift the cord over the machine when moving it from one side to the other.
- Do not expose this machine to rain or moisture. Damage to electrical components may occur. Store in a dry building.

**DANGER:**

This machine has rotating and moving elements that can cause serious injury. Follow these precautions:

- Do not operate this machine unless all guards, doors and covers are secure and in place.
- Keep hands, feet and loose clothing away from all moving parts.
- Do not service the machine while in operation. Disconnect the electrical cord before servicing.
- Do not change or make adjustments to the abrasive while the machine is in operation.

**WARNING:**

Any alterations, modifications or misuse of this machine, could result in damage to the machine or injury to the operator or bystanders. Alterations, modifications or uses not authorized by the manufacturer, voids any and all warranties and liabilities.

**WARNING:**

Do not operate a machine that is damaged or malfunctioning. Follow the maintenance schedule found in the "Routine Maintenance" section in this manual.

**WARNING:**

Wear eye, ear, respiratory protection and protective clothing while sanding.

**WARNING:**

See that the control switch is off and the drum raised before connecting the machine to an electrical circuit. Keep hands on the operating controls while sanding.

**CAUTION:**

Refer all maintenance and repairs to an authorized repair center.

**CAUTION:**

The machine is heavy. See the "How To Transport" section in this manual.

**CAUTION:**

Observe all warning and instructional labels on this machine. Replace any lost or damaged labels.

**CAUTION:**

Use of this machine to move other objects or to climb on could result in injury or damage. Do not use this machine as a step or furniture. Do not ride on this machine.

**CAUTION:**

Serious damage to the floor can occur if the machine is left running in one spot while the sanding drum is in contact with the floor. To avoid damage to the floor, feather cut in at a normal sanding rate. Do not dwell while lowering or raising the contact wheel. Always sand at a constant rate.

**IVIE Enterprises**

[www.ivie-ent.com](http://www.ivie-ent.com) Ph:(918)254-5161 or (888)262-5161 Fax:(918)250-4807

## Machine Safety Statements

The following safety decals are mounted on the machine as shown. If these or any other machine decal, label or plate should become damaged or illegible, install a new decal in its place. Contact your local authorized distributor for new decals.

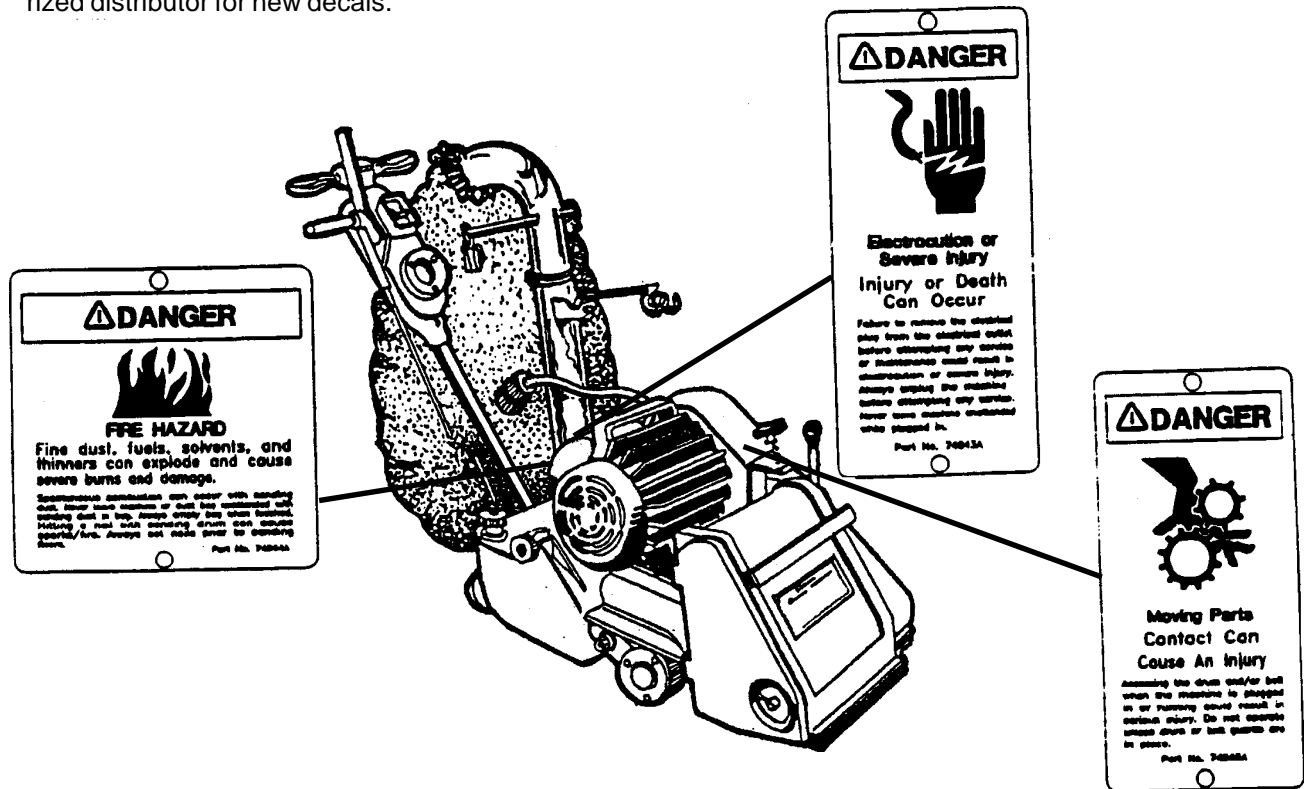

The following information signals potentially dangerous conditions to the operator and/or equipment. Read this manual carefully and familiarize yourself with the machine. Know when these conditions can exist. Locate all safety devices on the machine. Then, take the necessary steps to train the personnel that will be operating the machine. Report machine damage or faulty operation immediately.

1. Keep hands and clothing clear of rotating parts.
2. Keep hands on controls with the motor running.
3. Do not leave the machine with the motor running.
4. Do not operate the machine with the access door open or the belt guard removed.
5. Always operate the machine with the dust bag in place.
6. Do not remove dust bag with the motor running.
7. Always disconnect the motor pigtail power cord from the handle before servicing the machine.
8. Use caution if motor is removed for transporting (weight 108 lbs). The machine weighs 106 lbs. (minus the motor).
9. Always operate in a well ventilated area.
10. Always dispose of sanding dust properly.

## Introduction and Machine Specifications

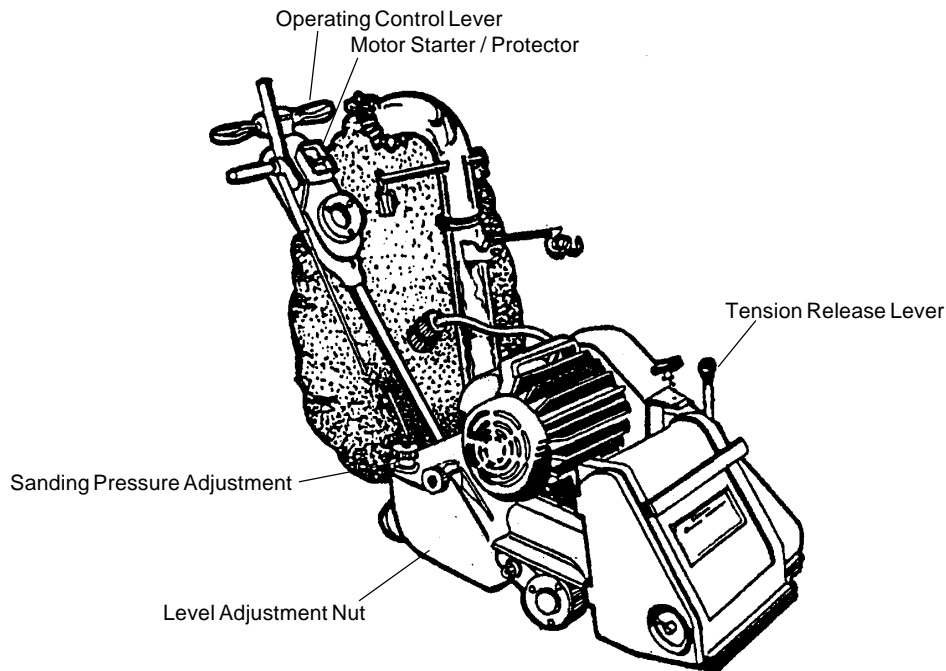

<b>PART NUMBER</b>	<b>07094C</b>
<b>ABRASIVE SIZE</b>	29½" x 7 7/8"
<b>CONTACT WHEEL SPEED</b>	2850 rpm (revolutions per minute)
<b>ABRASIVE SPEED</b>	4300 sfm (surface feet per minute)
<b>DUST FAN SPEED</b>	6800 rpm (revolutions per minute)
<b>DUST FAN FLOW</b>	234 cfm (cubic feet per minute)
<b>MOTOR</b>	4 hp 208-230V 60Hz 16A
<b>LEVELING CONTROL</b>	Externally adjustable
<b>OPERATING CONTROL</b>	Adjustable lever/grip
<b>MOTOR STARTER/PROTECTOR</b>	Magnetic circuit breaker
<b>SANDING PRESSURE ADJUSTMENT</b>	Infinitely adjustable
<b>WHEELS</b>	Replaceable 3½" O.D.
<b>BEARINGS</b>	Radial ball, permanently lubricated
<b>DIMENSIONS</b>	40½" L x 15" W x 36 ¾" H
<b>WEIGHT</b>	214 lbs.

**CAUTION:** Your equipment may be inappropriate on some installations. Some softer woods used in flooring cannot support the pressure created by hard wheels. A felt or rubber wheel should be used when these woods are encountered. See parts list for optional wheels.

Always consult with the flooring manufacturer on the proper installation, preparation, and finishing of their product. Determine suitability of your equipment in preparing the product.

## 230V Electrical Connection Instructions

**CAUTION:** This machine will operate only on AC frequency and on electrical voltage shown on the motor nameplate. Make sure you have the correct frequency and voltage before connecting the power cord to an outlet. The machine has a plug as shown below.

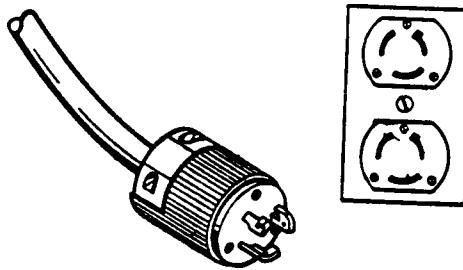

Figure #1

This machine must be connected to an electrically ground circuit in order to protect the operator from electric shock. This machine has an approved power cord with three conductors as well as a plug with three terminals. Connect the plug into an appropriate receptacle. For maximum protection against electric shock, use a circuit that is protected by a ground fault circuit interrupter.

**DANGER:** Electrocutation could occur if the machine is exposed to water or rain. Keep the machine in a dry building.

**DANGER:** Electrocutation could occur if machine is improperly connected to the electrical system. To prevent possible electric shock, always use a 3-wire electrical system connected to an electrical ground. For maximum protection against electrical shock, use a circuit that is protected by a ground fault circuit interrupter. Consult your electrical contractor.

**DANGER:** Electrocutation could occur if the ground pin is tampered with in any way. Do not cut, remove, or break the ground pin. Do not try to fit a three-terminal plug into a receptacle or connector body other than a three plug receptacle or connector body. If the outlet does not fit the plug, consult your electrical contractor.

**DANGER:** Electrocutation could occur if the machine is used with a damaged plug or power cord. If the cords or plugs are worn or damaged in any way, have them replaced by an authorized service person or electrician.

### Extension Cords

Use only an approved three-pronged extension cord with two main conductors and one earthing conductor. This machine's power cord has a wire size of 10 gauge. This machine is equipped with a 100' power cord. When greater range is needed follow the table below to determine cable guage of additional footage. Refer to the following chart for extension cord information.

Feet/Wire Guage (Stranded Copper)		
Source Voltage	0 - 100'	100 - 250'
208	6	Use Voltage Booster
230	10	8

If motor appears to labor or takes a considerably longer time to come up to speed, reduce sanding pressure.

## How to Transport the Machine

**▲ WARNING:** The machine is heavy. Remove the motor from the machine before transporting. Get help loading the machine and motor.

### Transporting the Machine - One Person

To transport the machine, follow this procedure:

1. Make sure the power cable is disconnected from the electrical outlet.
2. Disconnect the handle pigtail cord connection. (twist and pull) See figure #3.
3. Loosen the belt tension T-screw completely. Grasp the belt guard immediately above the left-hand truck wheel. Pull to gain access to the drive belts.
4. Grasp and pull the belt guard to gain entry to drive belts. Remove the drive belts. See figure #4.
5. Screw the motor mounting knob clear of the counterbore on chassis. See figure #5.
6. Straddle the machine. With your legs, lift the motor off of the chassis. Take the motor to worksite.
7. Lift the chassis by grasping the front handle and rear of chassis. Bring the belt guard against your chest. Take the chassis to worksite.

To assemble the machine after transporting, follow this procedure:

1. Place the motor on the chassis. Position the strap on the threaded end of the rear motor mount against the boss on the chassis.
2. Screw in the motor mounting knob completely.
3. Install the drive belts.
4. Tighten the belt tension T-screw until the contact drive wheel belt experiences a  $\frac{1}{2}$ " deflection at mid-span when 10 lbs. of effort is exerted upon it with a thumb.

**▲ CAUTION:** Premature bearing failure can occur if the fan belt is set too tight. The fan belt should deflect no less than  $\frac{1}{2}$ " at 5 lbs.

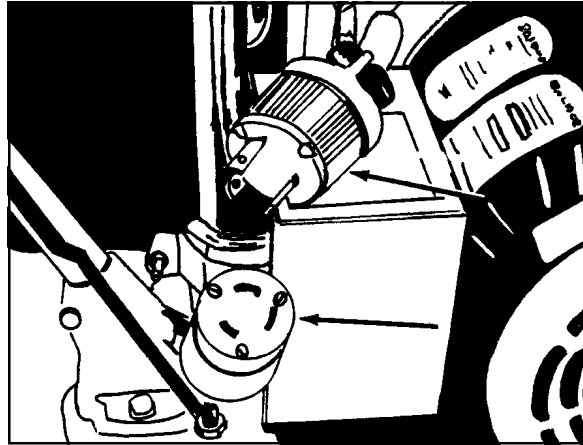

Figure 3

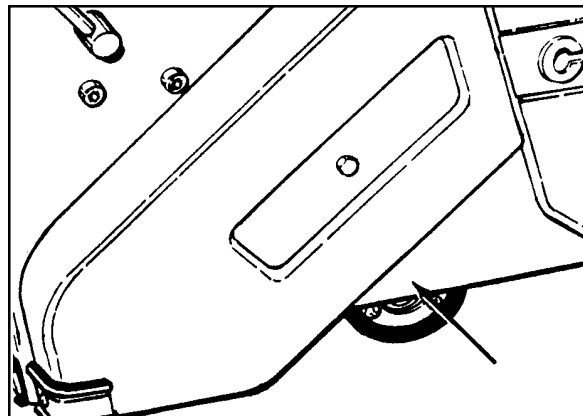

Figure 4

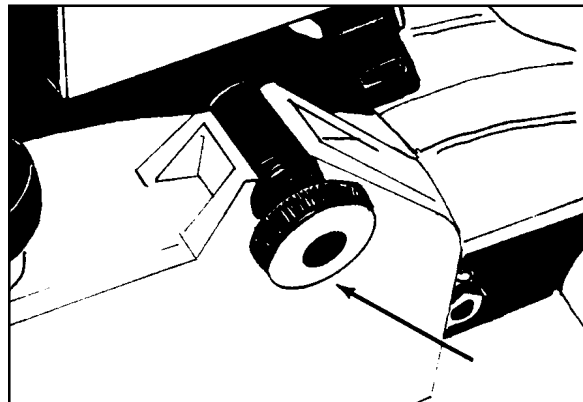

Figure 5



**NOTE:** It is not necessary to adjust the fan belt independently during this procedure or during replacement. The idler pulley is factory adjusted.

5. Close the belt guard door.
6. Plug the motor pigtail in, twisting to lock.

### **Transporting the Machine - Two People**

When transporting the machine with two people follow this procedure:

1. One operator places hands under the front of the machine main casting.
2. Person #2 lifts the machine by the handle

#### **IVIE Enterprises**

[www.ivie-ent.com](http://www.ivie-ent.com) Ph:(918)254-5161 or (888)262-5161 Fax:(918)250-4807

## Machine Set-Up

To set-up your machine follow this procedure:

1. Familiarize yourself with the machine and read all danger, warning and caution statements. Make sure all operators of this machine have read this Owner's Manual. If they cannot read English, have the manual explained fully before allowing anyone to operate the sander.
2. Locate the power supply. The receptacle should be compatible with the plug. The receptacle must be grounded and must be fused (30 amp) to avoid an electrical hazard.
3. Clip the dust bag to the elbow. See figure # 7. Cross the strings on the dust bag and draw tight over the flare on the elbow. Wrap the string around the elbow and secure.
4. Wind the power cord through the cable arm. See figure #8. Keep the power cord out of path of equipment.
5. Pull the draw latch forward to release the access door and gain entry to the sanding chamber.
6. Rotate the release lever forward. See figure #9.
7. Install a new abrasive belt by sliding the abrasive over the tension roller and contact wheel. See table on page 12 for abrasive belt selection. See figure #10.
8. Rotate the release lever upward and back to tighten the abrasive.
9. Plug the pigtailed power cord into the handle. Twist the cord connection to lock.
10. Turn on the motor starter switch momentarily.
11. Observe the belt tracking. Follow the procedures outlined in the "Sander Adjustment Procedures" on page 14 to correct the belt tracking. There is also a label on the inside of the access door that outlines tracking adjustment.
12. Close the access door. Place the end of the draw latch over the keeper on the access door and push the latch flat against the main frame to secure.

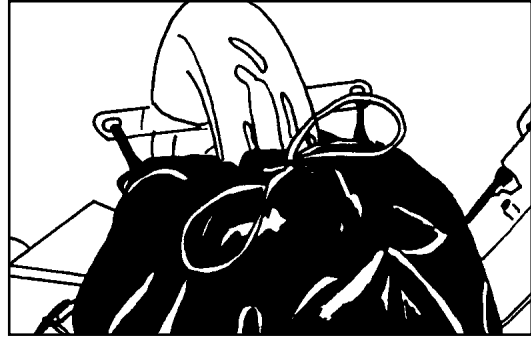

Figure 7

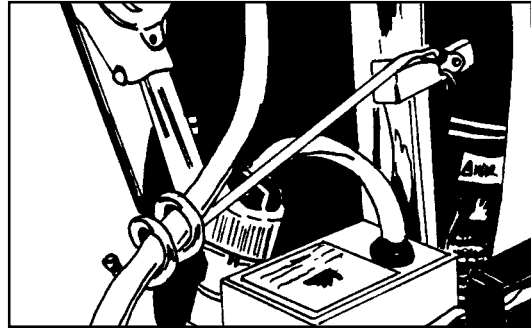

Figure 8

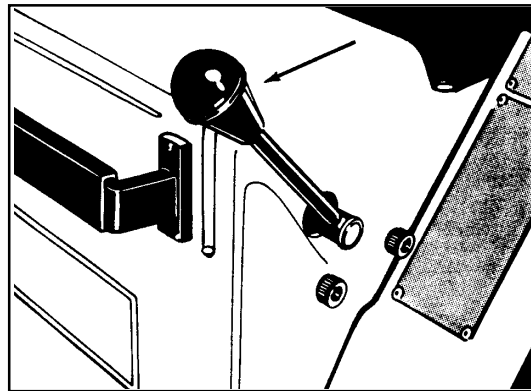

Figure 9

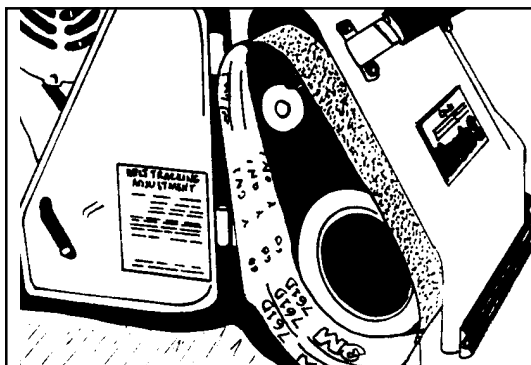





Figure 10

## How to Operate the Machine

 **DANGER:** Sanding/finishing wood floors can create an environment that can be explosive. Cigarette lighters, pilot lights and any other source of ignition can create an explosion when active during a sanding session. All sources of ignition should be extinguished or removed entirely if possible from the work area.

 **DANGER:** Work areas that are poorly ventilated can create an explosive environment when certain combustible materials are in the atmosphere, i.e., solvents, thinners, alcohol, fuels, certain finishes, wood dust and other combustible materials. Floor sanding machines can cause flammable material and vapors to ignite. Read the manufacturer's label on all chemicals used to determine combustibility. Keep the work area well ventilated.

 **DANGER:** Sanding dust can spontaneously ignite and cause an injury or damage. Sanding dust should be disposed of properly. Always empty the sanding dust into a metal container. Remove the contents of the dust bag when the bag is 1/3 full.

 **DANGER:** Sanding dust can spontaneously ignite and cause an injury or damage. Remove the contents of the dust bag each time you finish using the machine. Always dispose of the dust in a metal container located outside of the building. Never leave a dust bag unattended with sanding dust in it. Do not empty the contents of the dust bag into a fire.

 **DANGER:** Hitting a nail while sanding can cause sparks and create an explosion or fire. Always use a hammer and punch to countersink all nails before sanding floors.

**IVIE Enterprises**

[www.ivie-ent.com](http://www.ivie-ent.com) Ph:(918)254-5161 or (888)262-5161 Fax:(918)250-4807

To operate the machine follow this procedure:

1. Install the operator's belt as follows:
  - a. Position the operator's belt around waist.
  - b. Cross the straps at the waist. See figure #11.
  - c. Slide the belt loop end over the handle on the control lever side. Adjust the length as needed.
  - d. Wrap the remaining strap around the opposite side of the handle and hold it in place with your hand.

**⚠ WARNING:** **Should quick release of the machine be necessary, serious operator injury could occur if the operator has tied the loose end of the operator's belt strap to the machine. Always position the strap so that you can let go and get away quick in case of bag fire or explosion.**

2. Put the On/Off switch into the "ON" position.

**⚠ DANGER:** **Serious damage can occur to the floor surface if the machine is not in motion while the contact wheel is running on the floor surface. To prevent damage to the surface, make sure the machine is always moving when the contact wheel is in contact with the floor.**

3. Work right to left. For each forward pass, move the machine 4" over the pass you have just finished. Retrace your reverse path without overlapping. See figures 12A through 12E.
4. Feather-cut in by easing the contact wheel down onto the surface with the control lever while the sander is in motion.
5. When contact wheel is fully engaged with the surface, gradually adjust your pace for adequate finish removal. Keep sander in motion while the contact wheel is engaged with the surface or dwell marks will occur.
6. Move the machine in the direction of the grain in the wood whenever it is possible. Sand the surface at a constant pace.
7. Gradually feather-cut out at the termination point (the end of your pass) by easing the contact wheel up with the control lever. Stagger the termination points for a better blend when edging.

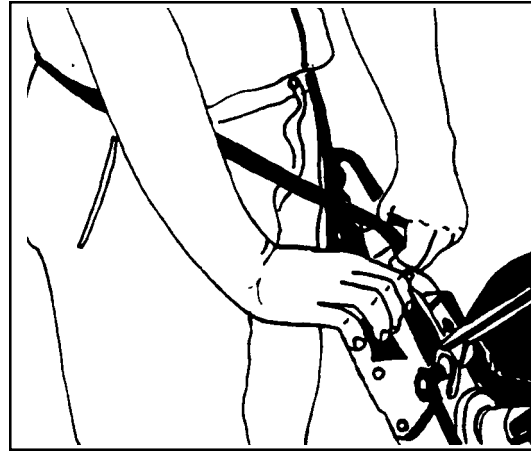
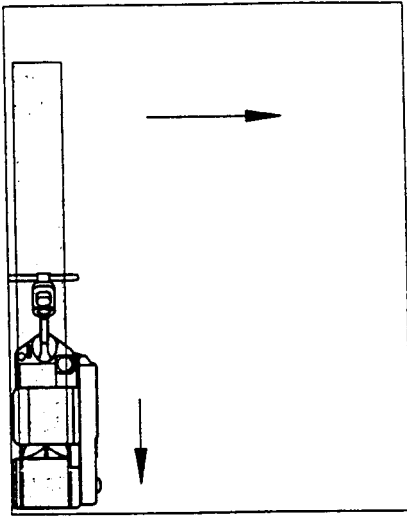

Figure 11

8. Empty dust bag whenever it is 1/3 full. Never leave a dust bag unattended with sanding dust in it. Sanding dust can spontaneously ignite and cause a fire or explosion. Empty dust into a metal container located **outside of the building**.

**IVIE Enterprises**

[www.ivie-ent.com](http://www.ivie-ent.com) Ph:(918)254-5161 or (888)262-5161 Fax:(918)250-4807



A. First pass forward, right to left.

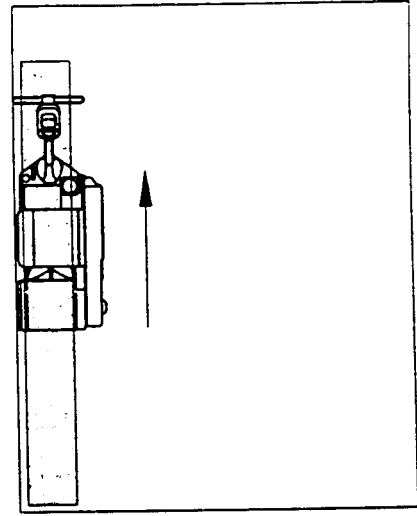

B. First pass reverse, retrace same path.

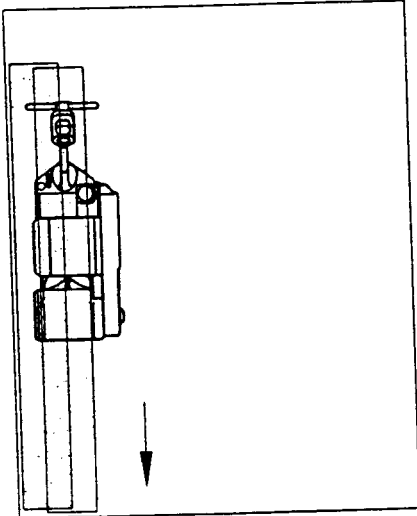

C. Second pass forward, overlap 1/2 the drum width.

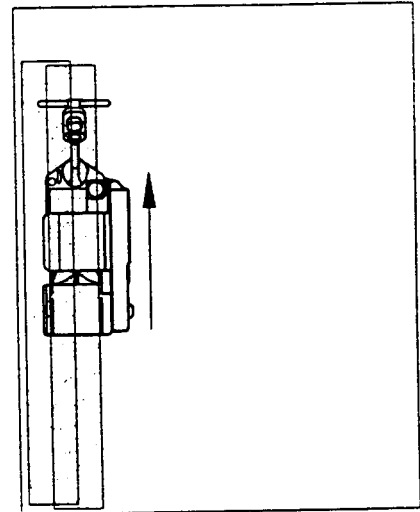

D. Second pass reverse, retrace second path forward, etc.....for the entire room.

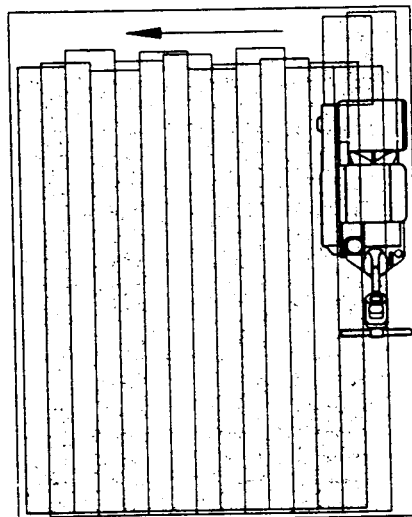

E. Work the remaining unsanded floor in the same fashion, right to left.

**Figure 12, A - E**

## Sanding Cuts and Sandpaper

### Initial Cut

The purpose of the initial cut is to remove old finish and gross imperfections on the floor surface. The sanding equipment should be adjusted to heavy sanding pressure setting and a coarse abrasive belt should be used. If the surface is severely damaged by deep scratches, pre-existing dwell marks, uneven planks, etc., it may be necessary to sand across or diagonally to the grain to restore evenness to the surface. If these conditions are not present, the initial cut should be done in the direction of the grain.

If glazing, loading, or burning takes place immediately into an initial cut, select a coarser abrasive. If this should occur during an initial cut, the abrasive has dulled and must be replaced.

### Final Cuts

The purpose of a finishing cut is to remove the scratches produced during the initial cut. Use a fine (60 - 80 grit) grain abrasive and a reduced sanding pressure setting.

If the surface remains rough after a finishing cut, it may be necessary to use an even finer grain of abrasive (80 - 100 grit). Care should be taken in selecting the grit size of the abrasive. A very fine grain will close the pores on a wood floor making admission of a stain difficult.

If glazing or burning should occur immediately into a finishing cut, reduce the sanding pressure. If it should occur during a finishing cut, the abrasive has dulled and must be replaced.

### Abrasive Belts

**Note:** All part numbers listed are for a carton of 10 belts

Grain	Use	Aluminum Oxide	Silicon Carbide	Ceramic Alum.Oxide
16 grit	For removing gross imperfections and restore evenness to old flooring. To remove build-up of paints and varnishes.	-	945844	-
36 grit	For first sanding of new flooring (maple, oak). For removing minor imperfections and finishes from old flooring.	-	945842	945901
40 grit	For first sanding of new flooring (oak, walnut). For removing minor imperfections and finishes from old flooring.	-	945541	945902
50 grit	For first sanding of new flooring (cedar, pine, fir) For clean-up of 16 grit.	-	945840	945903
60 grit	For clean-up from initial cut 36 - 40 grit.	945839	-	945904
80 grit	For final sanding of certain hardwoods. For clean-up of initial cuts (50 grit).	945838	-	945905
100 grit	For final sanding of certain hardwoods where a smooth surface is desired.	945837	-	945909
120 grit	For final sanding of certain conifers.	945836	-	945910
150 grit	For final sanding of certain conifers where a smooth surface is desired.	945835	-	945911
180 grit	For surface roughing between coats of finish.	945834	-	-

## Sander Adjustment Procedures

**⚠ DANGER:** Electrocutation could occur if maintenance and repairs are performed on a unit that is not properly disconnected from the power source. Disconnect the power supply before attempting any maintenance or service.

**⚠ DANGER:** Moving parts of this machine can cause serious injury and/or damage. Keep hands, feet and loose clothing away from all moving parts of the sander.

The following information provides details on how to adjust different features/controls of the sander.

### Dust Shoe

To adjust the dust shoe follow this procedure:

1. Disconnect machine from power supply.
2. Loosen the three screws fastening the dust shoe to the chassis.
3. Adjust the dust shoe down to reduce clearance.
4. Adjust the dust shoe up to increase clearance.
5. Align the dust shoe to the chassis and tighten all three screws. See figure #13.

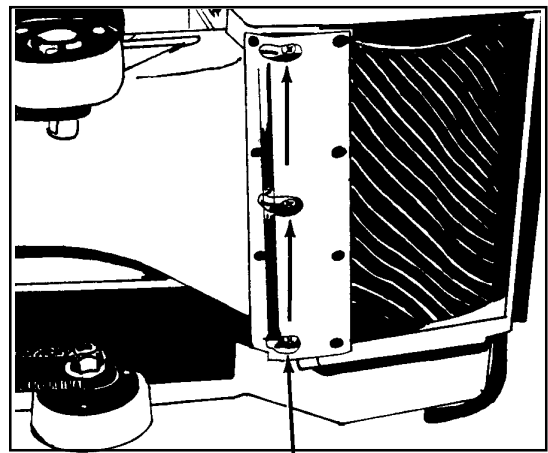

Figure 13

### Sanding Pressure

To adjust the sanding pressure follow this procedure:

1. Screw the sanding pressure knob down to increase the sanding pressure when making the roughing in cut.
2. Screw the sanding pressure knob up to decrease the sanding pressure when making the finishing cut.

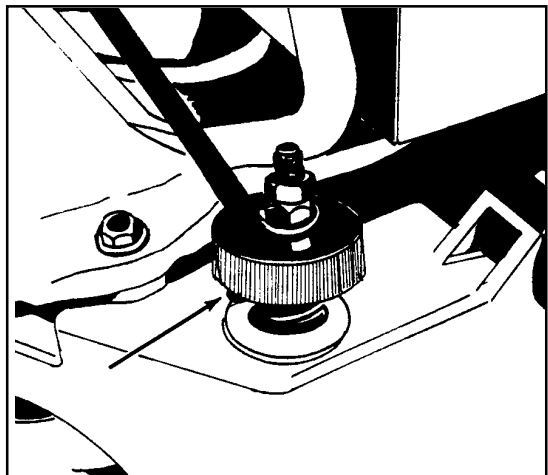

Figure 14

Minimum pressure is reached when the sanding pressure knob extends  $7/8$ " off of the casting. See figure #14.

**IVIE Enterprises**

[www.ivie-ent.com](http://www.ivie-ent.com) Ph:(918)254-5161 or (888)262-5161 Fax:(918)250-4807

## Leveling

To adjust the machine leveling follow this procedure:

1. Locate the leveling screw. See figure #15. The leveling screw is located towards the rear of the chassis beneath the sanding pressure knob.
2. Tighten the leveling screw (compress the leveling spring) to sand heavier on the drive belt side.
3. Loosen the leveling screw (relax the leveling spring) to sand heavier on the side opposite the drive belts.

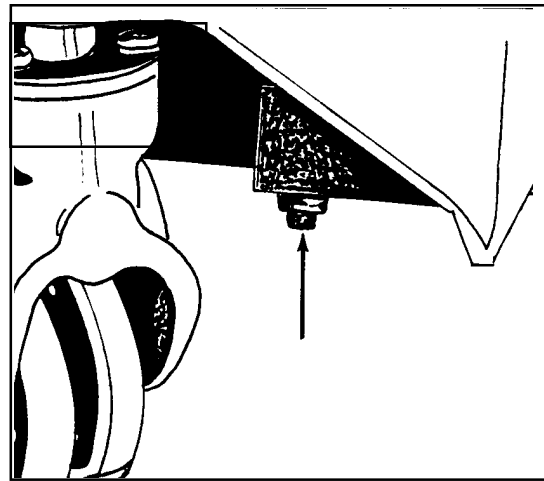

Figure 15

## Belt Tracking

**⚠ WARNING:** Injury to the operator could occur if any machine adjustments are made while the motor is running. Do not attempt to make any adjustments while the machine is plugged in or running.

To adjust the belt tracking follow this procedure:

1. Locate the belt tracking adjuster screw. See figure #16a.
2. Hold the belt tracking adjuster screw and loosen the locknut. See figure #16b.
3. Rotate the tracking adjuster screw counterclockwise to move the belt in.
4. Rotate the tracking adjuster screw clockwise to move the belt out.
5. Test adjustment and tighten the locknut.

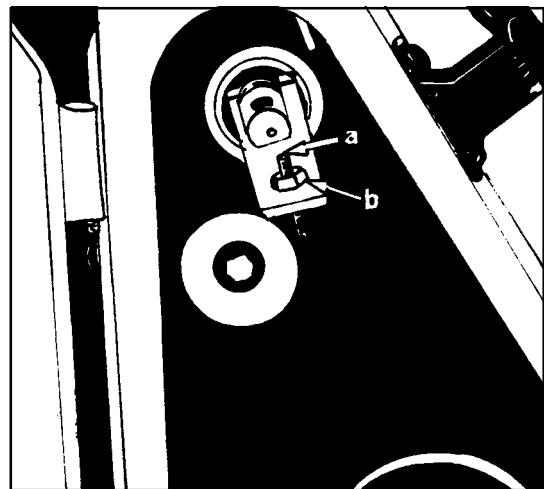

Figure 16

## Operating Control

To **increase** the travel or extend the reach on the grip control follow this procedure:

1. Loosen the locknut on the control rod. See figure #17.
2. Screw the control rod adjuster **in** until the desired reach is found.
3. Tighten the locknut.

To **decrease** the travel or reduce the reach on the grip control follow this procedure:

1. Loosen the locknut on the control rod. See figure #17.
2. Screw the control rod adjuster **out** until desired reach is found.
3. Tighten the locknut.

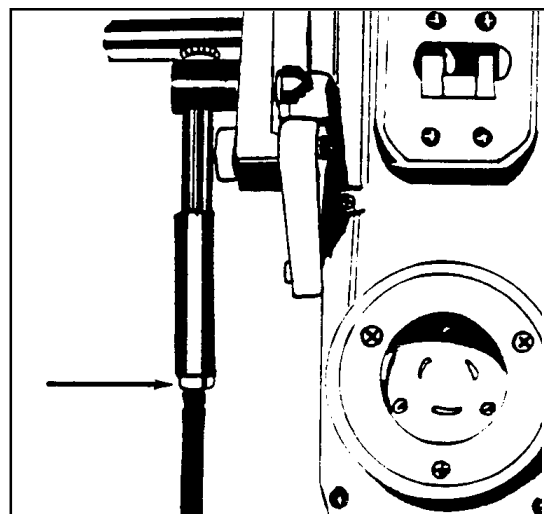

Figure 17

**IVIE Enterprises**

[www.ivie-ent.com](http://www.ivie-ent.com) Ph:(918)254-5161 or (888)262-5161 Fax:(918)250-4807



---

## Routine Maintenance

The following items need to be periodically inspected and maintained to keep your sander in good working condition.

### Sanding Chamber

Periodically blow out the sanding chamber to prevent large accumulations of debris which could interfere with the performance of the tension roller.

### Wheels

Periodically remove the debris from the truck and caster wheels. Debris can cause waves on a sanded surface.

### Dust Bag

Remove the dust bag from the machine and shake it thoroughly to remove the sanding dust from the dust bag. Turn the dust bag inside out and machine wash in cold water to prevent pore blockage and loss of dust recovery.

### Drive Belt

Periodically check the drive belt tension. See the adjustment procedure on page 6.

### Bearings

Periodically check the bearings for wear or damage according to the following schedule:

<i>Guide rollers</i>	after 1 <sup>st</sup> 650 hrs.
<i>Idler pulley</i>	after 1 <sup>st</sup> 1500 hrs.
<i>Fan shaft</i>	after 1 <sup>st</sup> 2500 hrs.
<i>Tension roller</i>	after 1 <sup>st</sup> 2500 hrs.
<i>Arbor shaft</i>	after 1 <sup>st</sup> 5000 hrs.
<i>Motor shaft</i>	after 1 <sup>st</sup> 5000 hrs.

### Rollers

Periodically check the guide rollers and the tension roller for wear.

**IVIE Enterprises**

[www.ivie-ent.com](http://www.ivie-ent.com) Ph:(918)254-5161 or (888)262-5161 Fax:(918)250-4807

## Troubleshooting

PROBLEM	CAUSE	ACTION
<b>Drive belts slip.</b> (Squeaking or squealing sound)	Insufficient tension.  Worn belts.	Tension drive belt as described in adjustment procedures.  Replace belts.
<b>Squealing, growling or grinding noise coming from machine.</b>	Damaged and/or worn bearing.	Remove drive belts, rotate arbor motor, fan, shafts and idler pulley to locate dragging or rough bearing. Contact an authorized dealer.
<b>Dust pick-up is poor.</b>	Dust bag is over 1/3 full.  Dust bag is dirty.  Dust shoe is improperly adjusted.  Dust chute is obstructed.	Empty contents of bag.  Shake debris from bag and wash.  Readjust dust shoe.  Remove fan cover and clear throat.
<b>Motor will not start.</b>	Defective motor starter.  Defective start capacitor.  Defective electronic start switch.  Low voltage from poor connection.  Defective motor.  No power.	Contact an authorized dealer.  Contact an authorized dealer.  Contact an authorized dealer.  Contact an authorized dealer.  Contact an authorized dealer.  Check power supply and connections.
<b>Motor runs sluggishly.</b>	Low voltage from excessive footage, undersized extension cord, or poor connection.  Defective run capacitor.  Defective motor.	Locate power source nearer to work site. Decrease sanding pressure.  Contact an authorized dealer.  Contact an authorized dealer.
<b>Motor starter trips/repeatedly trips.</b>	Excessive load.  Defective electronic start switch.  Defective motor starter.  Low voltage from poor connection.  Defective motor  Defective capacitor.	Contact an authorized dealer.  Contact an authorized dealer.  Contact an authorized dealer.  Contact an authorized dealer.  Contact an authorized dealer.  Contact an authorized dealer.
<b>Uneven cut.</b>	Leveling out of adjustment.  Abrasive belt tracking.	Readjust leveling.  Adjust belt to track towards the edge of drum with deepest cut.

### IVIE Enterprises

[www.ivie-ent.com](http://www.ivie-ent.com) Ph:(918)254-5161 or (888)262-5161 Fax:(918)250-4807

## Troubleshooting

PROBLEM	CAUSE	ACTION
<b>Burning or glazing.</b>	Dull abrasive. Excessive sanding pressure. Too fine of an abrasive.	Replace abrasive. Decrease sanding pressure setting. Fig. #14, page 13. Use coarser abrasive.
<b>Slow cutting.</b>	Dull abrasive. Too fine of an abrasive belt. Insufficient sanding pressure.	Replace abrasive. Use a coarser abrasive belt. Increase sanding pressure setting. Fig. #14, page13.
<b>Waves on sanded surface.</b>	Debris on wheel. Flat spot on tire(s).	Remove and clean wheels. Replace tires.
<b>Chatter marks on sanded surface</b> (close evenly spaced )	See Chatter Wave Prevention.	See Chatter Wave Prevention.
<b>Difficult to actuate tension release lever.</b>	Debris interferes with mechanism. Worn sleeve bearing. Galled linkages.	Blow out sanding chamber. Remove and disassemble mechanism. Clean out. Replace. Lubricate with WD-40.
<b>Abrasive belt will not track.</b>	Extreme difference in side-to-side length of belt. High edge on contact wheel.	Replace abrasive belt. Check several different abrasive belts. Contact an authorized dealer or replace the contact wheel.
<b>Abrasive belt tears along its length.</b>	Debris built-up on (top) tension roller.	Clean tension roller.

### IVIE Enterprises

[www.ivie-ent.com](http://www.ivie-ent.com) Ph:(918)254-5161 or (888)262-5161 Fax:(918)250-4807

## Free Manuals Download Website

<http://myh66.com>

<http://usermanuals.us>

<http://www.somanuals.com>

<http://www.4manuals.cc>

<http://www.manual-lib.com>

<http://www.404manual.com>

<http://www.luxmanual.com>

<http://aubethermostatmanual.com>

Golf course search by state

<http://golfingnear.com>

Email search by domain

<http://emailbydomain.com>

Auto manuals search

<http://auto.somanuals.com>

TV manuals search

<http://tv.somanuals.com>