

**L1N64-SLI WS**



# Motherboard

E3014

Second Edition V2

December 2006

**Copyright © 2006 ASUSTeK COMPUTER INC. All Rights Reserved.**

No part of this manual, including the products and software described in it, may be reproduced, transmitted, transcribed, stored in a retrieval system, or translated into any language in any form or by any means, except documentation kept by the purchaser for backup purposes, without the express written permission of ASUSTeK COMPUTER INC. ("ASUS").

Product warranty or service will not be extended if: (1) the product is repaired, modified or altered, unless such repair, modification or alteration is authorized in writing by ASUS; or (2) the serial number of the product is defaced or missing.

ASUS PROVIDES THIS MANUAL "AS IS" WITHOUT WARRANTY OF ANY KIND, EITHER EXPRESS OR IMPLIED, INCLUDING BUT NOT LIMITED TO THE IMPLIED WARRANTIES OR CONDITIONS OF MERCHANTABILITY OR FITNESS FOR A PARTICULAR PURPOSE. IN NO EVENT SHALL ASUS, ITS DIRECTORS, OFFICERS, EMPLOYEES OR AGENTS BE LIABLE FOR ANY INDIRECT, SPECIAL, INCIDENTAL, OR CONSEQUENTIAL DAMAGES (INCLUDING DAMAGES FOR LOSS OF PROFITS, LOSS OF BUSINESS, LOSS OF USE OR DATA, INTERRUPTION OF BUSINESS AND THE LIKE), EVEN IF ASUS HAS BEEN ADVISED OF THE POSSIBILITY OF SUCH DAMAGES ARISING FROM ANY DEFECT OR ERROR IN THIS MANUAL OR PRODUCT.

SPECIFICATIONS AND INFORMATION CONTAINED IN THIS MANUAL ARE FURNISHED FOR INFORMATIONAL USE ONLY, AND ARE SUBJECT TO CHANGE AT ANY TIME WITHOUT NOTICE, AND SHOULD NOT BE CONSTRUED AS A COMMITMENT BY ASUS. ASUS ASSUMES NO RESPONSIBILITY OR LIABILITY FOR ANY ERRORS OR INACCURACIES THAT MAY APPEAR IN THIS MANUAL, INCLUDING THE PRODUCTS AND SOFTWARE DESCRIBED IN IT.

Products and corporate names appearing in this manual may or may not be registered trademarks or copyrights of their respective companies, and are used only for identification or explanation and to the owners' benefit, without intent to infringe.

# Contents

Notices.....	vii
Safety information .....	viii
About this guide .....	ix
L1N64-SLI WS specifications summary .....	xi

## Chapter 1: Product introduction

1.1 Welcome! .....	1-1
1.2 Special features.....	1-2
1.2.1 Product highlights .....	1-2
1.2.2 ASUS Special features .....	1-4

## Chapter 2: Hardware information

2.1 Before you proceed .....	2-1
2.2 Motherboard overview .....	2-2
2.2.1 Placement direction .....	2-2
2.2.2 Screw holes .....	2-2
2.2.3 Motherboard layout.....	2-3
2.2.4 Layout contents.....	2-4
2.3 Central Processing Unit (CPU) .....	2-6
2.3.1 Installing the CPU .....	2-6
2.3.2 Installing the heatsink and fan .....	2-9
2.3.3 Installing the fan .....	2-12
2.4 System memory .....	2-13
2.4.1 Overview .....	2-13
2.4.2 Memory configurations.....	2-14
2.4.3 Installing a DIMM .....	2-15
2.4.4 Removing a DIMM .....	2-15
2.5 Expansion slots.....	2-16
2.5.1 Installing an expansion card .....	2-16
2.5.2 Configuring an expansion card .....	2-16
2.5.3 Interrupt assignments .....	2-17
2.5.4 PCI slot .....	2-18
2.5.5 PCI Express x1 slot.....	2-18
2.5.6 Four PCI Express x16 slots .....	2-18

# Contents

- 2.6 Jumper ..... 2-20
- 2.7 Connectors ..... 2-21
  - 2.7.1 Rear panel connectors ..... 2-21
  - 2.7.2 Internal connectors ..... 2-23
  
- Chapter 3: Powering up**
- 3.1 Starting up for the first time..... 3-1
- 3.2 Powering off the computer..... 3-2
  - 3.2.1 Using the OS shut down function..... 3-2
  - 3.2.2 Using the dual function power switch..... 3-2
  
- Chapter 4: BIOS setup**
- 4.1 Managing and updating your BIOS ..... 4-1
  - 4.1.1 ASUS Update utility ..... 4-1
  - 4.1.2 Creating a bootable floppy disk..... 4-4
  - 4.1.3 AFUDOS utility..... 4-5
  - 4.1.4 ASUS CrashFree BIOS 3 utility ..... 4-8
- 4.2 BIOS setup program ..... 4-9
  - 4.2.1 BIOS menu screen..... 4-10
  - 4.2.2 Menu bar..... 4-10
  - 4.2.3 Navigation keys..... 4-10
  - 4.2.4 Menu items ..... 4-11
  - 4.2.5 Sub-menu items..... 4-11
  - 4.2.6 Configuration fields ..... 4-11
  - 4.2.7 Pop-up window ..... 4-11
  - 4.2.8 Scroll bar..... 4-11
  - 4.2.9 General help ..... 4-11
- 4.3 Main menu ..... 4-12
  - 4.3.1 System Time ..... 4-12
  - 4.3.2 System Date ..... 4-12
  - 4.3.3 Legacy Diskette A ..... 4-12
  - 4.3.4 Language ..... 4-12
  - 4.3.5 Primary IDE Master/Slave..... 4-13
  - 4.3.6 SATA 1-12 ..... 4-14
  - 4.3.7 IDE Configuration..... 4-15
  - 4.3.8 System Information ..... 4-16

# Contents

<b>4.4</b>	<b>Advanced menu .....</b>	<b>4-17</b>
4.4.1	JumperFree Configuration .....	4-17
4.4.2	CPU Configuration .....	4-21
4.4.3	Chipset .....	4-22
4.4.4	Onboard Devices Configuration .....	4-25
4.4.5	PCI PnP .....	4-27
4.4.6	USB Configuration .....	4-28
<b>4.5</b>	<b>Power menu .....</b>	<b>4-29</b>
4.5.1	Suspend Mode [Auto] .....	4-29
4.5.2	ACPI 2.0 Support .....	4-29
4.5.3	ACPI APIC Support .....	4-29
4.5.4	APM Configuration .....	4-30
4.5.5	Hardware Monitor .....	4-32
<b>4.6</b>	<b>Boot menu .....</b>	<b>4-34</b>
4.6.1	Boot Device Priority .....	4-34
4.6.2	Boot Settings Configuration .....	4-35
4.6.3	Security .....	4-36
<b>4.7</b>	<b>Exit menu .....</b>	<b>4-39</b>

## **Chapter 5: Software support**

<b>5.1</b>	<b>Installing an operating system .....</b>	<b>5-1</b>
<b>5.2</b>	<b>Support CD information .....</b>	<b>5-1</b>
5.2.1	Running the support CD .....	5-1
5.2.2	Drivers menu .....	5-2
5.2.3	Utilities menu .....	5-3
5.2.4	Make Disk menu .....	5-4
5.2.5	Manuals menu .....	5-5
5.2.6	ASUS Contact information .....	5-5
5.2.7	Other information .....	5-6

# Contents

## Chapter 5: Software support

<b>5.1</b>	<b>Installing an operating system .....</b>	<b>5-1</b>
<b>5.2</b>	<b>Support CD information .....</b>	<b>5-1</b>
5.2.1	Running the support CD .....	5-1
5.2.2	Drivers menu.....	5-2
5.2.3	Utilities menu .....	5-3
5.2.4	Make Disk menu .....	5-5
5.2.5	Manuals menu .....	5-6
5.2.6	ASUS Contact information .....	5-7
5.2.7	Other information .....	5-7

# Notices

## Federal Communications Commission Statement

This device complies with Part 15 of the FCC Rules. Operation is subject to the following two conditions:

- This device may not cause harmful interference, and
- This device must accept any interference received including interference that may cause undesired operation.

This equipment has been tested and found to comply with the limits for a Class B digital device, pursuant to Part 15 of the FCC Rules. These limits are designed to provide reasonable protection against harmful interference in a residential installation. This equipment generates, uses and can radiate radio frequency energy and, if not installed and used in accordance with manufacturer's instructions, may cause harmful interference to radio communications. However, there is no guarantee that interference will not occur in a particular installation. If this equipment does cause harmful interference to radio or television reception, which can be determined by turning the equipment off and on, the user is encouraged to try to correct the interference by one or more of the following measures:

- Reorient or relocate the receiving antenna.
- Increase the separation between the equipment and receiver.
- Connect the equipment to an outlet on a circuit different from that to which the receiver is connected.
- Consult the dealer or an experienced radio/TV technician for help.



---

The use of shielded cables for connection of the monitor to the graphics card is required to assure compliance with FCC regulations. Changes or modifications to this unit not expressly approved by the party responsible for compliance could void the user's authority to operate this equipment.

---

## Canadian Department of Communications Statement

This digital apparatus does not exceed the Class B limits for radio noise emissions from digital apparatus set out in the Radio Interference Regulations of the Canadian Department of Communications.

This class B digital apparatus complies with Canadian ICES-003.

# Safety information

## Electrical safety

- To prevent electrical shock hazard, disconnect the power cable from the electrical outlet before relocating the system.
- When adding or removing devices to or from the system, ensure that the power cables for the devices are unplugged before the signal cables are connected. If possible, disconnect all power cables from the existing system before you add a device.
- Before connecting or removing signal cables from the motherboard, ensure that all power cables are unplugged.
- Seek professional assistance before using an adapter or extension cord. These devices could interrupt the grounding circuit.
- Make sure that your power supply is set to the correct voltage in your area. If you are not sure about the voltage of the electrical outlet you are using, contact your local power company.
- If the power supply is broken, do not try to fix it by yourself. Contact a qualified service technician or your retailer.

## Operation safety

- Before installing the motherboard and adding devices on it, carefully read all the manuals that came with the package.
- Before using the product, make sure all cables are correctly connected and the power cables are not damaged. If you detect any damage, contact your dealer immediately.
- To avoid short circuits, keep paper clips, screws, and staples away from connectors, slots, sockets and circuitry.
- Avoid dust, humidity, and temperature extremes. Do not place the product in any area where it may become wet.
- Place the product on a stable surface.
- If you encounter technical problems with the product, contact a qualified service technician or your retailer.



# About this guide

This user guide contains the information you need when installing and configuring the motherboard.

## How this guide is organized

This guide contains the following parts:

- **Chapter 1: Product introduction**  
This chapter describes the features of the motherboard and the new technology it supports.
- **Chapter 2: Hardware information**  
This chapter lists the hardware setup procedures that you have to perform when installing system components. It includes description of the switches, jumpers, and connectors on the motherboard.
- **Chapter 3: Powering up**  
This chapter describes the power up sequence and ways of shutting down the system.
- **Chapter 4: BIOS setup**  
This chapter tells how to change system settings through the BIOS Setup menu. Detailed descriptions of the BIOS parameters are also provided.
- **Chapter 5: Software support**  
This chapter describes the contents of the support CD that comes with the motherboard package.

## Where to find more information

Refer to the following sources for additional information and for product and software updates.

1. **ASUS websites**  
The ASUS website provides updated information on ASUS hardware and software products. Refer to the ASUS contact information.
2. **Optional documentation**  
Your product package may include optional documentation, such as warranty flyers, that may have been added by your dealer. These documents are not part of the standard package.

## Conventions used in this guide

To make sure that you perform certain tasks properly, take note of the following symbols used throughout this manual.



**DANGER/WARNING:** Information to prevent injury to yourself when trying to complete a task.



**CAUTION:** Information to prevent damage to the components when trying to complete a task.



**IMPORTANT:** Instructions that you **MUST** follow to complete a task.



**NOTE:** Tips and additional information to help you complete a task.

## Typography

**Bold text**

Indicates a menu or an item to select.

*Italics*

Used to emphasize a word or a phrase.

<Key>

Keys enclosed in the less-than and greater-than sign means that you must press the enclosed key.

Example: <Enter> means that you must press the Enter or Return key.

<Key1+Key2+Key3>

If you must press two or more keys simultaneously, the key names are linked with a plus sign (+).

Example: <Ctrl+Alt+D>

**Command**

Means that you must type the command exactly as shown, then supply the required item or value enclosed in brackets.

Example: At the DOS prompt, type the command line:

```
afudos /i[filename]
```

```
afudos /iL1N64WS.ROM
```

# L1N64-SLI WS specifications summary

<b>CPU</b>	Supports 2 AMD Atholon™ 64FX Socket L1 (1207FX) CPU Supports AMD Cool 'n' Quiet™ Technology AMD64 architecture enables simultaneous 32-bit and 64-bit computing
<b>Chipset</b>	2 x NVIDIA® MCP55PXE
<b>System bus</b>	2000 / 1600 MT/s
<b>Memory</b>	Dual-channel memory architecture <ul style="list-style-type: none"> <li>- 4 x 240-pin DIMM sockets support unbuffered ECC/non-ECC DDR2 800/667/533/400 MHz memory modules</li> <li>- Supports up to 8 GB system memory</li> </ul>
<b>Expansion slots</b>	4 x PCI Express™ x16 slots (at x16, x8, x16, x8) 1 x PCI-E x1 slot 1 x PCI 2.2 slot
<b>Scalable Link Interface (SLI™)</b>	Supports two identical NVIDIA® SLI™-ready graphics cards
<b>Storage</b>	2x NVIDIA® MCP55PXE supports: <ul style="list-style-type: none"> <li>- 1 x IDE connector for up to two Ultra DMA 133/100 devices</li> <li>- 12 x Serial ATA 3.0 Gb/s connectors support twelve Serial ATA devices</li> <li>- RAID 0, RAID1, RAID 0+1, RAID 5, and JBOD configurations spanning across Serial ATA drives via the onboard NVIDIA® MediaShield™ RAID controller</li> </ul> Silicon Image® SiI3531 Serial ATA controller supports: <ul style="list-style-type: none"> <li>- 1 x External Serial ATA 3.0 Gb/s on the rear panel</li> </ul>
<b>LAN</b>	2 x Marvell® 88E1116 PHY support: Gigabit LAN Firewall function Supports Teaming functions Wake up from S5
<b>High Definition Audio</b>	SoundMAX® ADI AD1988B 8-channel High Definition Audio CODEC Supports Jack-Sensing, Enumeration, Multi-Streaming, and Jack-Retasking Technology Optical and Coaxial S/PDIF Out interfaces at the rear panel
<b>IEEE 1394</b>	VIA 6308P 1394 controller supports: <ul style="list-style-type: none"> <li>- 2 x IEEE 1394a connectors</li> </ul>
<b>USB</b>	Supports up to 10 USB 2.0/1.1 ports

*(continued on the next page)*

# L1N64-SLI WS specifications summary

<b>ASUS special features Performance</b>	Intelligent overclocking tools: <ul style="list-style-type: none"> <li>- ASUS C.P.R. (CPU Parameter Recall)</li> <li>- Adjustable FSB/DDR2 ratio. Fixed PCI/PCIe frequencies.</li> <li>- Hyper Path 3</li> </ul> Precision Tweaker: <ul style="list-style-type: none"> <li>- vDIMM: 25-step DRAM voltage control</li> <li>- vCore: Adjustable CPU voltage at 0.0125 V increment</li> <li>- Stepless Frequency Selection(SFS) allows FSB tuning from 200 MHz up to 400 MHz at 1 MHz increment</li> <li>- PCI Express x16 frequency allows PCI Express x16 frequency tuning from 100 MHz to 150 MHz at 1 MHz increment</li> </ul>
<b>ASUS special features Thermal</b>	ASUS 8-Phase Power Design for each VRM Q-Fan 2 ASUS Heat-pipe Thermal solution
<b>ASUS special features Life</b>	Multi-language BIOS SATA on the Go CrashFree BIOS 3
<b>Rear panel</b>	1 x PS/2 keyboard port (purple) 1 x PS/2 mouse port (green) 1 x Parallel port 1 x External Serial ATA 3.0 Gb/s 1 x Optical S/PDIF Out port 1 x Coaxial S/PDIF Out port 2 x LAN (RJ-45) ports 4 x USB 2.0/1.1 ports 8-channel audio ports
<b>Internal connectors</b>	3 x USB 2.0 connectors support 6 additional USB 2.0 ports 1 x Floppy disk drive connector 1 x IDE connector 12 x Serial ATA connectors 2 x CPU / 4 x Chassis / 1 x Power / 3 x fan connectors 2 x IEEE 1394a connectors 1 x EZ-plug Chassis intrusion connector Front panel audio connector 1 x CD audio in connector 1 x TPM connector (optional) 24-pin ATX power connector 8-pin ATX 2.0/1.1 power connector System panel connector

*(continued on the next page)*

## L1N64-SLI WS specifications summary

<b>BIOS features</b>	8 Mb AMI BIOS, PnP, DMI 2.0, WfM2.0, SM BIOS 2.3
<b>Manageability</b>	WOL by PME, WOR by PME, PXE, AI NET 2, Chassis Intrusion
<b>Power requirements</b>	ATX power supply (with 24-pin and 4-pin 12 V plugs) ATX 12 V 2.0 compliant
<b>Support CD contents</b>	Device drivers BIOS flash utility under DOS ASUS PC Probe II ASUS Update NVIDIA® RAID
<b>Form factor</b>	CEB form factor: 12 in x 10.5 in (30.5 cm x 26.7 cm)

\*Specifications are subject to change without notice.



This chapter describes the motherboard features and the new technologies it supports.

# 1 Product introduction

# Chapter summary

# 1

1.1	Welcome! .....	1-1
1.2	Special features.....	1-2



## 1.1 Welcome!

Thank you for buying an **ASUS® L1N64-SLI WS motherboard!**

The motherboard delivers a host of new features and latest technologies, making it another standout in the long line of ASUS quality motherboards!

Before you start installing the motherboard, and hardware devices on it, check the items in your package with the list below.

## 1.2 Special features

### 1.2.1 Product highlights

#### Latest processor technology

The motherboard comes with dual 1207-pin surface mount Land Grid Array (LGA) sockets coded Socket L1 (1207FX), designed for AMD processors. The motherboard with the new socket delivers advanced performance and ensuring reliable data protection. See page 2-6 for details.

#### AMD Cool 'n' Quiet Technology



The motherboard supports the AMD Cool 'n' Quiet Technology, which monitors system operation and automatically adjusts CPU voltage and frequency for a cool and quiet operating environment. See page 4-18 for details.

#### NVIDIA® Scalable Link Interface (SLI™)



The NVIDIA® Scalable Link Interface (SLI™) technology allows two graphics processing units (GPUs) in a single system. This technology takes advantage of the PCI Express™ bus architecture and features intelligent hardware and software solutions that allows multiple GPUs to work together and achieve exceptional graphics performance.

#### 64-bit CPU support



The motherboard supports 64-bit computing, which is the next generation technology to replace the current 32-bit architecture. The 64-bit architecture delivers advanced system performance, faster memory access, and increased productivity. This motherboard provides excellent compatibility and flexibility by support either 64-bit or 32-bit architecture. See page 2-6 for details.

#### DDR2 memory support



The motherboard supports DDR2 memory that features data transfer rates of 800/667/533/400 MHz to meet the higher bandwidth requirements of the latest 3D graphics, multimedia, and Internet applications. The dual-channel DDR2 architecture doubles the bandwidth of your system memory to boost system performance, eliminating bottlenecks with peak bandwidths of up to 10.7 GB/s. See pages 2-13 to 2-14 for details.

## PCI Express™ interface

The motherboard fully supports PCI Express, the latest I/O interconnect technology that speeds up the PCI bus. PCI Express features point-to-point serial interconnections between devices and allows higher clockspeeds by carrying data in packets. This high speed interface is software compatible with existing PCI specifications. See page 2-18 for details.

## Serial ATA I/II technology and SATA-On-The-Go



The motherboard fully supports the Serial ATA II 3.0 Gb/s technology through the Serial ATA interfaces and the NVIDIA® nForce® 680a SLI™ chipset. The Serial ATA 3 Gb/s specification provides twice the bandwidth of the current Serial ATA products with a host of new features, including Power Management (PM) Implementation Algorithm. Serial ATA allows for thinner, more flexible cables with lower pin count and reduced voltage required. Leveraging these Serial ATA 3.0 Gb/s features is the SATA-On-The-Go. Supported by the Marvell® 88SE614x Serial ATA controller, four Serial ATA 3.0 Gb/s connectors (three at mid-board and one on the rear panel) provide smart setup, and hot-plug function. See pages 2-22 and 2-25 for details.

## IEEE 1394a support



The IEEE 1394a interface provides high-speed and flexible PC connectivity to a wide range of peripherals and devices compliant to the IEEE 1394a standard. The IEEE 1394a interface allows up to 400 Mbps transfer rates through simple, low-cost, high-bandwidth asynchronous (real-time) data interfacing between computers, peripherals, and consumer electronic devices such as camcorders, VCRs, printers, TVs, and digital cameras. See page 2-26 for details.

## S/PDIF digital sound ready

The motherboard supports the S/PDIF technology through the S/PDIF interfaces on the rear panel. The S/PDIF technology turns your computer into a high-end entertainment system with digital connectivity to powerful audio and speaker systems. See page 2-22 for details.

## USB 2.0 technology

The motherboard implements the Universal Serial Bus (USB) 2.0 specification, dramatically increasing the connection speed from the 12 Mbps bandwidth on USB 1.1 to a fast 480 Mbps on USB 2.0. USB 2.0 is backward compatible with USB 1.1. See pages 2-22 and 2-26 for details.

## Dual Gigabit LAN solution



The motherboard comes with dual Gigabit LAN controllers to provide the total solution for your networking needs. These network controllers use the PCI Express segment to provide faster data bandwidth for your wired or wireless Internet, LAN, and file sharing requirements. See page 2-21 for details.

## 1.2.2 ASUS Special features

### Advanced Thermal Design

#### 8-Phase Power Design



The ASUS 8-Phase Power Design prolongs CPU lifespan and keeps the system stable by preventing high power stress to the CPU and power supply module. The design ensures high efficiency operation to generate less heat compared with conventional power solutions, thus achieving cool system environment and making this motherboard ideal for overclocking.

#### ASUS CrashFree BIOS 3



The ASUS CrashFree BIOS 3 allows users to restore corrupted BIOS data from a USB flash disk containing the BIOS file. This utility saves users the cost and hassle of buying a replacement BIOS chip. See page 4-8 for details.

#### Precision Tweaker



This feature allows you to fine tune the CPU/memory voltage and gradually increase the memory Front Side Bus (FSB) and PCI Express frequency at 1MHz increment to achieve maximum system performance.

#### ASUS Multi-language BIOS



The multi-language BIOS allows you to select the language of your choice from the available options. The localized BIOS menus allow easier and faster configuration. See page 4-11 for details.

#### C.P.R. (CPU Parameter Recall)



The C.P.R. feature of the motherboard BIOS allows automatic re-setting to the BIOS default settings in case the system hangs due to overclocking. When the system hangs due to overclocking, C.P.R. eliminates the need to open the system chassis and clear the RTC data. Simply shut down and reboot the system, and the BIOS automatically restores the CPU default setting for each parameter.

This chapter lists the hardware setup procedures that you have to perform when installing system components. It includes description of the jumpers and connectors on the motherboard.

# Hardware information

A large, light gray, stylized number '2' is positioned behind the word 'Hardware' in the section header.

2.1	Before you proceed .....	2-1
2.2	Motherboard overview.....	2-2
2.3	Central Processing Unit (CPU) .....	2-6
2.4	System memory .....	2-13
2.5	Expansion slots.....	2-16
2.6	Jumper .....	2-20
2.7	Connectors .....	2-21

## 2.1 Before you proceed

Take note of the following precautions before you install motherboard components or change any motherboard settings.



- Unplug the power cord from the wall socket before touching any component.
- Use a grounded wrist strap or touch a safely grounded object or to a metal object, such as the power supply case, before handling components to avoid damaging them due to static electricity.
- Hold components by the edges to avoid touching the ICs on them.
- Whenever you uninstall any component, place it on a grounded antistatic pad or in the bag that came with the component.
- Before you install or remove any component, ensure that the ATX power supply is switched off or the power cord is detached from the power supply. Failure to do so may cause severe damage to the motherboard, peripherals, and/or components.

### Onboard LED

The motherboard comes with a standby power LED. The green LED lights up to indicate that the system is ON, in sleep mode, or in soft-off mode. This is a reminder that you should shut down the system and unplug the power cable before removing or plugging in any motherboard component. The illustration below shows the location of the onboard LED.

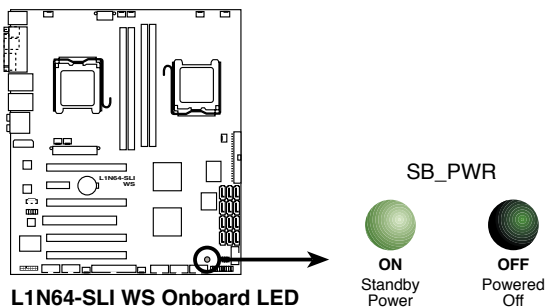

## 2.2 Motherboard overview

Before you install the motherboard, study the configuration of your chassis to ensure that the motherboard fits into it.



Make sure to unplug the power cord before installing or removing the motherboard. Failure to do so can cause you physical injury and damage motherboard components.

### 2.2.1 Placement direction

When installing the motherboard, make sure that you place it into the chassis in the correct orientation. The edge with external ports goes to the rear part of the chassis as indicated in the image below.

### 2.2.2 Screw holes

Place nine (9) screws into the holes indicated by circles to secure the motherboard to the chassis.



Do not overtighten the screws! Doing so can damage the motherboard.

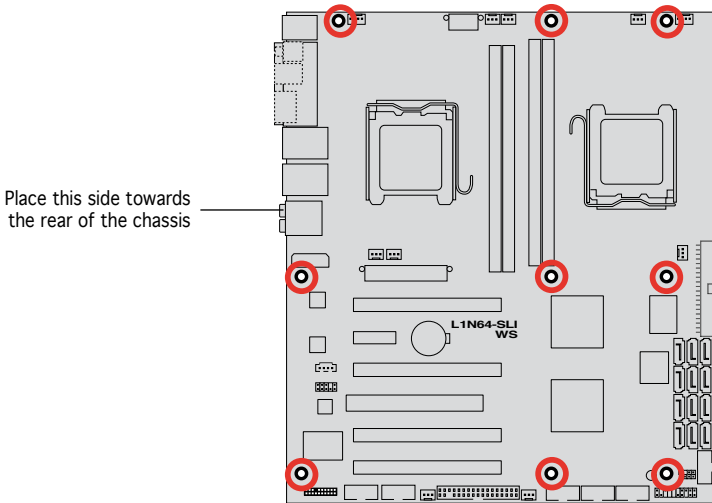



## 2.2.3 Motherboard layout

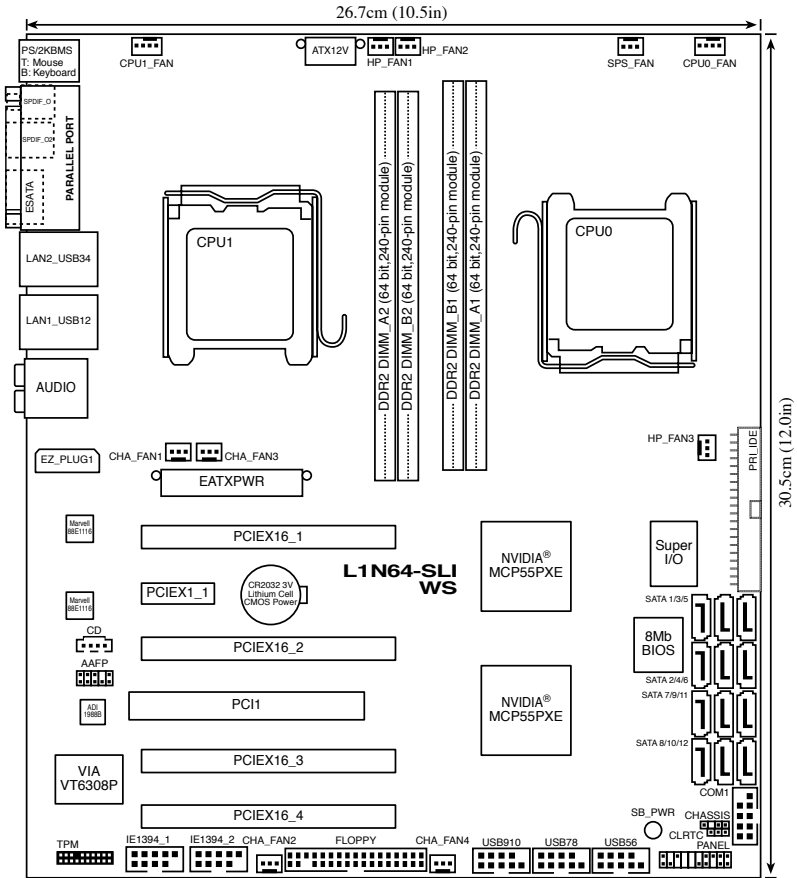

## 2.2.4 Layout contents

Slots		Page
1.	DDR2 DIMM slots	2-13
2.	PCI slots	2-18
3.	PCI Express x16 slots	2-18
4.	PCI Express x1 slot	2-18

Jumper		Page
1.	Clear RTC RAM (3-pin CLRTC)	2-20

Rear panel connectors		Page
1.	PS/2 mouse port (green)	2-21
2.	Parallel port	2-21
3.	LAN 1 (RJ-45) port	2-21
4.	LAN 2 (RJ-45) port	2-21
5.	Rear Speaker Out port (black)	2-21
6.	Center/Subwoofer port (orange)	2-21
7.	Line In port (light blue)	2-21
8.	Line Out port (lime)	2-21
9.	Microphone port (pink)	2-22
10.	Side Speaker Out port (gray)	2-22
11.	USB 2.0 ports 1 and 2	2-22
12.	USB 2.0 ports 3 and 4	2-22
13.	External SATA port	2-22
14.	Optical S/PDIF Out port	2-22
15.	Coaxial S/PDIF Out port	2-22
16.	PS/2 keyboard port (purple)	2-22

Internal connectors		Page
1.	Floppy disk drive connector (34-1 pin FLOPPY)	2-23
2.	NVIDIA® IDE connector (40-1 pin PRI_IDE)	2-23
3.	NVIDIA® MCP55PXE Southbridge Serial ATA connectors (7-pin SATA1-6 [red], SATA7-12 [black])	2-25
4.	USB connectors (10-1 pin USB56, USB78, USB910)	2-26
5.	IEEE 1394a port connectors (10-1 pin IE1394_1, 10-1 pin IE1394_2)	2-26
6.	CPU, chassis, power, and Heat-pipe Fan connectors (4-pin CPU0_FAN, 4-pin CPU1_FAN, 3-pin HP_FAN1~3, 3-pin CHA_FAN1~4, 3-pin SPS_FAN1)	2-27
7.	Chassis intrusion connector (4-1 pin CHASSIS)	2-28
8.	Power connectors (24-pin EATXPWR, 8-pin ATX12V, 4-pin EZ_PLUG1)	2-28
9.	Front panel audio connector (10-1 pin AAFP)	2-29
10.	Internal audio connector (4-pin CD [black])	2-30
11.	Serial port connector (10-1 pin COM1)	2-30
12.	TPM connector (20-1 pin TPM)	2-31
13.	System panel connector (20-8 pin PANEL) <ul style="list-style-type: none"> <li>• System power LED (2-pin PLED)</li> <li>• Hard disk drive activity LED (2-pin IDE_LED)</li> <li>• System warning speaker (4-pin SPEAKER)</li> <li>• ATX power button/soft-off button (2-pin PWR)</li> <li>• Reset button (2-pin RESET)</li> </ul>	2-32

## 2.3 Central Processing Unit (CPU)

The motherboard comes with dual surface mount Socket L1 (1207FX) designed for the AMD CPU in the Land Grid Array (LGA) package.



- Upon purchase of the motherboard, make sure that the PnP cap is on the socket and the socket contacts are not bent. Contact your retailer immediately if the PnP cap is missing, or if you see any damage to the PnP cap/socket contacts/motherboard components. ASUS shoulders the repair cost only if the damage is shipment/transit-related.
- Keep the cap after installing the motherboard. ASUS will process Return Merchandise Authorization (RMA) requests only if the motherboard comes with the cap on the Socket L1 (1207FX).
- The product warranty does not cover damage to the socket contacts resulting from incorrect CPU installation/removal, or misplacement/loss/incorrect removal of the PnP cap.

### 2.3.1 Installing the CPU

To install a CPU:

1. Locate the CPU socket on the motherboard.

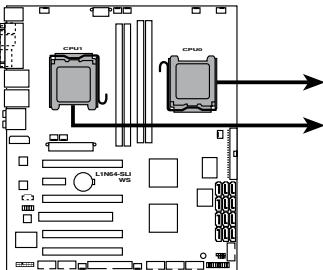

**L1N64-SLI WS CPU Socket**



- Before installing the CPU, make sure that the cam box is facing towards you and the load lever is on your left.
- When installing only one CPU, always install the CPU on the CPU0 socket; otherwise, the system will not boot up.

2. Press the load lever with your thumb (A), then move it to the left (B) until it is released from the retention tab.

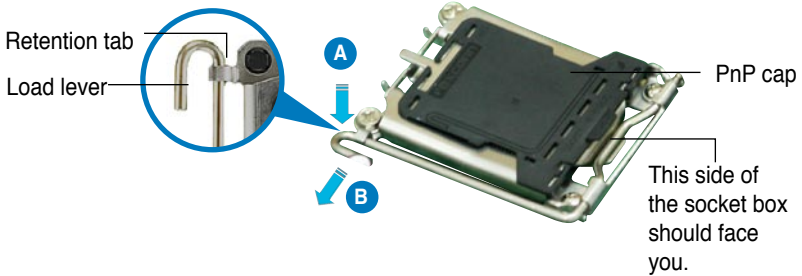

To prevent damage to the socket pins, do not remove the PnP cap until you are installing a CPU.

3. Lift the load lever in the direction of the arrow to a 135° angle.

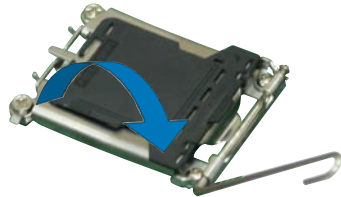

4. Lift the load plate with your thumb and forefinger to a 100° angle (A), then push the PnP cap from the load plate window to remove (B).

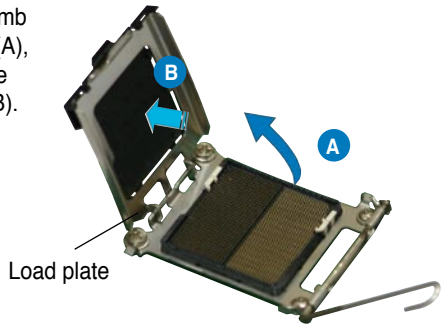

5. Position the CPU over the socket, making sure that the gold triangle is on the bottom-right corner of the socket. The socket alignment keys should fit into the CPU notches.

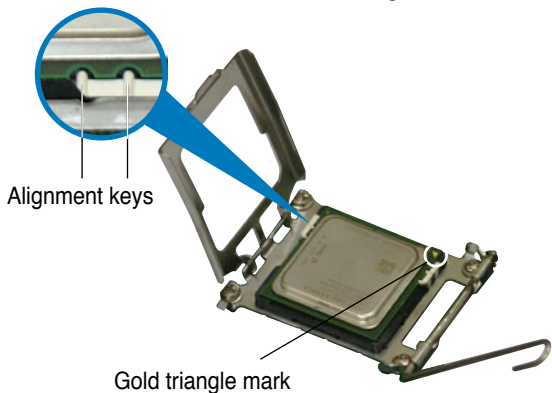



---

The CPU fits in only one correct orientation. DO NOT force the CPU into the socket to prevent bending the connectors on the socket and damaging the CPU!

---

6. Close the load plate (A), then push the load lever (B) until it snaps into the retention tab.

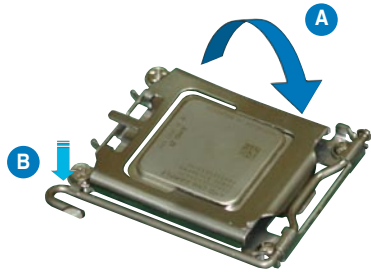

## 2.3.2 Installing the heatsink and fan

The AMD processor requires a specially designed heatsink and fan assembly to ensure optimum thermal condition and performance.



---

Make sure that you use only AMD-certified heatsink and fan assembly.

---

To install the CPU heatsink and fan:

1. Place the heatsink on top of the installed CPU, making sure that the heatsink fits properly on the retention module base.



- 
- The retention module base is already installed on the motherboard upon purchase.
  - You do not have to remove the retention module base when installing the CPU or installing other motherboard components.
  - If you purchased a separate CPU heatsink and fan assembly, make sure that a Thermal Interface Material is properly applied to the CPU heatsink or CPU before you install the heatsink and fan assembly.
- 

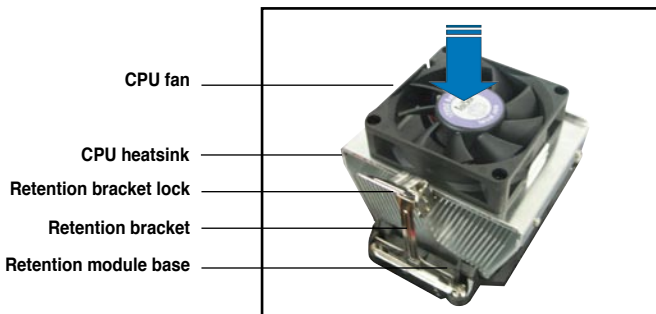

---

Your boxed CPU heatsink and fan assembly should come with installation instructions for the CPU, heatsink, and the retention mechanism. If the instructions in this section do not match the CPU documentation, follow the latter.

---

2. Attach one end of the retention bracket to the retention module base.



3. Align the other end of the retention bracket (near the retention bracket lock) to the retention module base. A clicking sound denotes that the retention bracket is in place.



Make sure that the fan and heatsink assembly perfectly fits the retention mechanism module base, otherwise you cannot snap the retention bracket in place.



4. Push up the retention bracket lock on the retention mechanism to secure the heatsink and fan to the module base.





- When the fan and heatsink assembly is in place, connect the CPU fan cable to the connector on the motherboard labeled CPU0\_FAN.

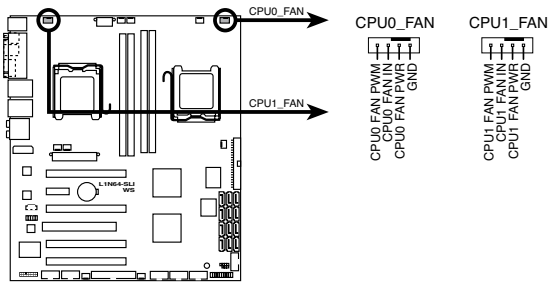

**L1N64-SLI WS CPU fan connectors**



---

Do not forget to connect the CPU fan connector! Hardware monitoring errors can occur if you fail to plug this connector.

---

- Repeat steps 1 to 5 to install the other heatsink if you have installed a second CPU, then connect the fan cable to the 4-pin connector labeled CPU1\_FAN.

### 2.3.3 Installing the fan



Install the fan only if you are using a passive cooler or a water cooler. Installing the fan with an active CPU cooler will interfere with the airflow and destabilize the system.



1. Position the fan above the pipe and heatsink assembly.

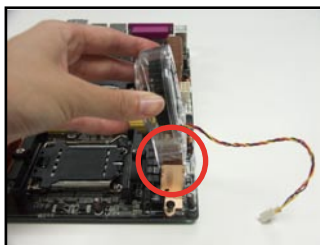

2. Fit the grooved edge to the heatsink.

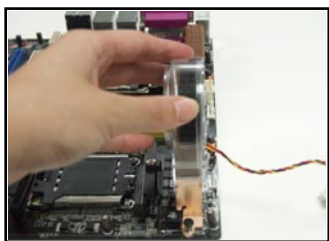

3. Carefully push down the fan until it snugly fits the heatsink, then connect the fan cables.

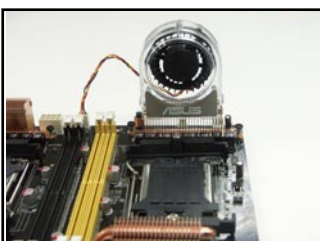

4. The above photo shows the fan installed on the motherboard.

5. Repeat step 1-4 to install the other fans.



- Plug the fan cables to any of the HP\_FAN1~3 connectors on the motherboard.
- Make sure the fan is installed correctly to prevent damage to the fan and motherboard components.

## 2.4 System memory

### 2.4.1 Overview

The motherboard comes with four Double Data Rate 2 (DDR2) Dual Inline Memory Modules (DIMM) sockets.

A DDR2 module has the same physical dimensions as a DDR DIMM but has a 240-pin footprint compared to the 184-pin DDR DIMM. DDR2 DIMMs are notched differently to prevent installation on a DDR DIMM socket.

The figure illustrates the location of the DDR2 DIMM sockets:

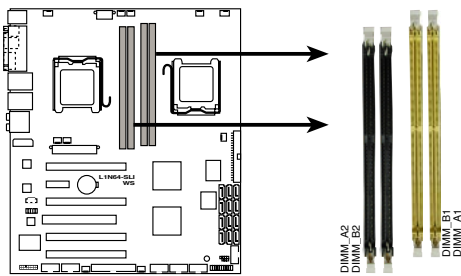

**L1N64-SLI WS 240-pin DDR2 DIMM sockets**

Channel	Sockets
Channel 1	DIMM_A1 and DIMM_B1
Channel 2	DIMM_A2 and DIMM_B2



- When using only one CPU, install memory modules to DIMM\_A1 and DIMM\_B1 slots only.
- Always use memory modules with same memory size and frequency.
- For dual-channel memory configuration, the DDR2 DIMMs can be installed in DIMM\_A1 and DIMM\_A2 either in one CPU mode or dual CPU mode.

## 2.4.2 Memory configurations

You may install 256 MB, 512 MB, and 1 GB unbuffered ECC/non-ECC DDR2 DIMMs into the DIMM sockets.



- For dual-channel configuration, the total size of memory module(s) installed per channel must be the same (DIMM\_A1 + DIMM\_B1 = DIMM\_A2 + DIMM\_B2).
- Always install DIMMs with the same CAS latency. For optimum compatibility, we recommend that you obtain memory modules from the same vendor. Visit the ASUS website ([www.asus.com](http://www.asus.com)) for the latest Qualified Vendors List.
- When using only one DDR2 DIMM module, install it into slot DIMM\_A1 only.
- For single-channel memory configuration, start installing the DDR2 DIMMs from slot DIMM\_A1 or DIMM\_B1.



### Important notice on installing Windows® XP 32-bit version

If you install Windows® XP 32-bit version Operating System (OS), the limitation of this OS version is that it may reserve a certain amount of memory space for system devices. We recommend that you install less than 3 GB system memory if you would like to work under Windows® XP 32-bit version OS. The excess memory installation will not cause any usage problem, but it will not give users the benefit of manipulating this excess memory space.

Visit the ASUS FAQ site for further explanation:

<http://support.asus.com/faq/faq.aspx?SLanguage=en-us>

Under **General Search**, make the selections as shown, then click **Search**. Click the article titled **“4GB memory installed but less memory size detected.”**

General Search

Please Select the Product

Motherboard

Socket 939

AP500-SLI Deluxe

Search

You also may check the URLs below for third party comments on this issue:

[http://dlsvr01.asus.com/pub/ASUS/mb/4GB\\_Rev1.pdf](http://dlsvr01.asus.com/pub/ASUS/mb/4GB_Rev1.pdf)

<http://www.intel.com/support/motherboards/server/sb/cs-016594.htm>

### 2.4.3 Installing a DIMM



Unplug the power supply before adding or removing DIMMs or other system components. Failure to do so can cause severe damage to both the motherboard and the components.

To install a DIMM:

1. Unlock a DIMM socket by pressing the retaining clips outward.
2. Align a DIMM on the socket such that the notch on the DIMM matches the break on the socket.
3. Firmly insert the DIMM into the socket until the retaining clips snap back in place and the DIMM is properly seated.

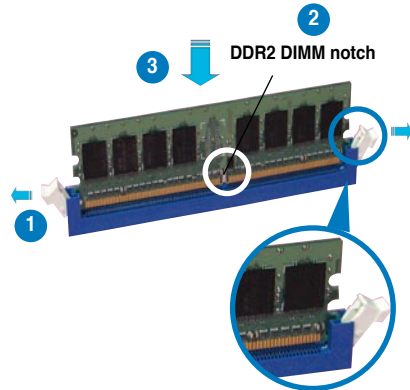

Unlocked retaining clip



- A DDR2 DIMM is keyed with a notch so that it fits in only one direction. Do not force a DIMM into a socket to avoid damaging the DIMM.
- The DDR2 DIMM sockets do not support DDR DIMMs. DO not install DDR DIMMs to the DDR2 DIMM sockets.

### 2.4.4 Removing a DIMM

To remove a DIMM:

1. Simultaneously press the retaining clips outward to unlock the DIMM.



Support the DIMM lightly with your fingers when pressing the retaining clips. The DIMM might get damaged when it flips out with extra force.

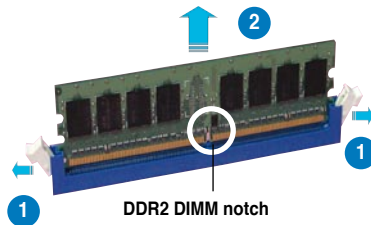

2. Remove the DIMM from the socket.

## 2.5 Expansion slots

In the future, you may need to install expansion cards. The following sub-sections describe the slots and the expansion cards that they support.



---

Make sure to unplug the power cord before adding or removing expansion cards. Failure to do so may cause you physical injury and damage motherboard components.

---

### 2.5.1 Installing an expansion card

To install an expansion card:

1. Before installing the expansion card, read the documentation that came with it and make the necessary hardware settings for the card.
2. Remove the system unit cover (if your motherboard is already installed in a chassis).
3. Remove the bracket opposite the slot that you intend to use. Keep the screw for later use.
4. Align the card connector with the slot and press firmly until the card is completely seated on the slot.
5. Secure the card to the chassis with the screw you removed earlier.
6. Replace the system cover.

### 2.5.2 Configuring an expansion card

After installing the expansion card, configure the it by adjusting the software settings.

1. Turn on the system and change the necessary BIOS settings, if any. See Chapter 4 for information on BIOS setup.
2. Assign an IRQ to the card. Refer to the tables on the next page.
3. Install the software drivers for the expansion card.



---

When using PCI cards on shared slots, ensure that the drivers support "Share IRQ" or that the cards do not need IRQ assignments; otherwise, conflicts will arise between the two PCI groups, making the system unstable and the card inoperable.

---

## 2.5.3 Interrupt assignments

### Standard interrupt assignments

IRQ	Standard function
0	System timer
1	Standard 101/102-key or Microsoft Natural Keyboard
4	Communications Port (COM1)*
5	NVIDIA nForce PCI system management
6	Standard floppy disk controller
8	System CMOS/real-time clock
9	Microsoft ACPI-compliant system
9	NVIDIA nForce networking controller
9	NVIDIA nForce networking controller #2
11	NVIDIA nForce PCI system management
12	PS/2 compatible mouse port
13	Numeric data processor
16	Silicon Image Sii 3531 SATA controller
17	NVIDIA GeForce 6600 GT
17	VIA OHCI compliant IEEE 1394 host controller
20	NVIDIA nForce 680a Serial ATA controller
20	Standard Enhanced PCI to USB host controller
21	Microsoft UAA Bus Driver for High Definition Audio
22	NVIDIA network bus enumerator
22	Standard OpenHCD USB host controller
22	NVIDIA nForce 680a Serial ATA controller
23	NVIDIA network bus enumerator
23	NVIDIA nForce 680a Serial ATA controller
45	NVIDIA nForce 680a Serial ATA controller
46	NVIDIA nForce 680a Serial ATA controller
47	NVIDIA nForce 680a Serial ATA controller

\* These IRQs are usually available for ISA or PCI devices.

## 2.5.4 PCI slot

The PCI slot supports cards such as a LAN card, SCSI card, USB card, and other cards that comply with PCI specifications. Refer to the figure below for the location of the slot.

## 2.5.5 PCI Express x1 slot

This motherboard supports PCI Express x1 network cards, SCSI cards and other cards that comply with the PCI Express specifications. Refer to the figure below for the location of the slot.

## 2.5.6 Four PCI Express x16 slots

This motherboard supports four SLI-ready PCI Express x16 graphic cards that comply with the PCI Express specifications. The cards run at x16, x8, x16, x8 mode. Refer to the figure below for the location of the slots.

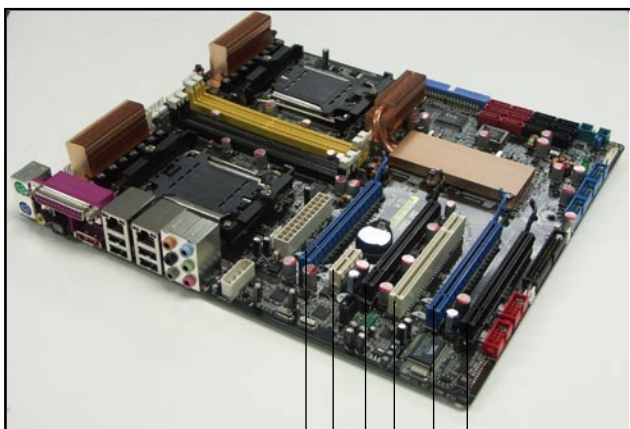

PCI Express x16 slot (blue)

PCI Express x1 slot

PCI Express x16 slot (black)

PCI Express x16 slot (black)

PCI Express x16 slot (blue)

PCI slot





- 
- Connect a rear chassis fan to the chassis (CHA\_FAN1 or CHA\_FAN2) connector when using two graphics cards for better thermal environment. See page 2-27 for details.
  - In single card mode, you may use either the blue or black slot for PCI Express x16 graphics cards.
  - We recommend that you provide sufficient power when running NVIDIA® SLI™ mode. See page 2-25 for details.
-

## 2.6 Jumper

### Clear RTC RAM (CLRRTC)

This jumper allows you to clear the Real Time Clock (RTC) RAM in CMOS. You can clear the CMOS memory of date, time, and system setup parameters by erasing the CMOS RTC RAM data. The onboard button cell battery powers the RAM data in CMOS, which include system setup information such as system passwords.

To erase the RTC RAM:

1. Turn OFF the computer and unplug the power cord.
2. Remove the onboard battery.
3. Move the jumper cap from pins 1-2 (default) to pins 2-3. Keep the cap on pins 2-3 for about 5~10 seconds, then move the cap back to pins 1-2.
4. Reinstall the battery.
5. Plug the power cord and turn ON the computer.
6. Hold down the <Del> key during the boot process and enter BIOS setup to re-enter data.



---

Except when clearing the RTC RAM, never remove the cap on CLRRTC jumper default position. Removing the cap will cause system boot failure!

---

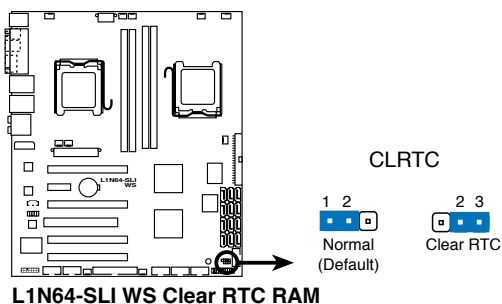

- Make sure to re-enter your previous BIOS settings after you clear the CMOS.
  - You do not need to clear the RTC when the system hangs due to overclocking. For system failure due to overclocking, use the C.P.R. (CPU Parameter Recall) feature. Shut down and reboot the system so the BIOS can automatically reset parameter settings to default values.
-

## 2.7 Connectors

### 2.7.1 Rear panel connectors

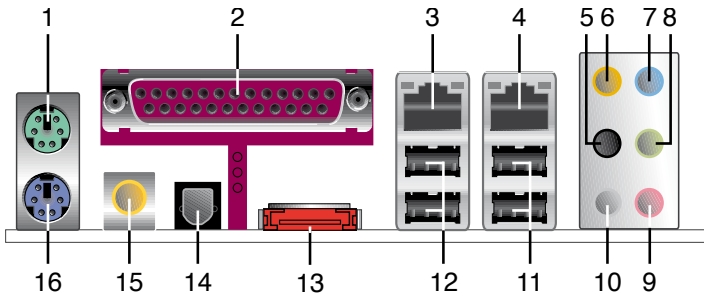

1. **PS/2 mouse port (green).** This port is for a PS/2 mouse.
2. **Parallel port.** This 25-pin port connects a parallel printer, a scanner, or other devices.
3. **LAN 1 (RJ-45) port.** Supported by Marvell® 88E1116 Gigabit LAN controller, this port allows Gigabit connection to a Local Area Network (LAN) through a network hub. Refer to the table below for the LAN port LED indications.
4. **LAN 2 (RJ-45) port.** Supported by the Marvell® 88E1116 Gigabit LAN controller, this port allows Gigabit connection to a Local Area Network (LAN) through a network hub. Refer to the table below for the LAN port LED indications.

#### LAN port LED indications

Activity/Link Speed LED			
Status	Description	Status	Description
OFF	No link	OFF	10 Mbps connection
ORANGE	Linked	ORANGE	100 Mbps connection
BLINKING	Data activity	GREEN	1 Gbps connection

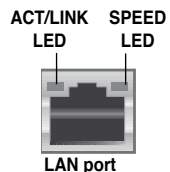

5. **Rear Speaker Out port (black).** This port connects the rear speakers in a 4-channel, 6-channel, or 8-channel audio configuration.
6. **Center/Subwoofer port (orange).** This port connects the center/subwoofer speakers.
7. **Line In port (light blue).** This port connects the tape, CD, DVD player, or other audio sources.
8. **Line Out port (lime).** This port connects a headphone or a speaker. In 4-channel, 6-channel, and 8-channel configuration, the function of this port becomes Front Speaker Out.

9. **Microphone port (pink).** This port connects a microphone.
10. **Side Speaker Out port (gray).** This port connects the side speakers in an 8-channel audio configuration.



Refer to the audio configuration table below for the function of the audio ports in 2, 4, 6, or 8-channel configuration.

## Audio 2, 4, 6, or 8-channel configuration

Port	Headset 2-channel	4-channel	6-channel	8-channel
Light Blue	Line In	Line In	Line In	Line In
Lime	Line Out	Front Speaker Out	Front Speaker Out	Front Speaker Out
Pink	Mic In	Mic In	Mic In	Mic In
Gray	–	–	–	Side Speaker Out
Black	–	Rear Speaker Out	Rear Speaker Out	Rear Speaker Out
Orange	–	–	Center/Subwoofer	Center/Subwoofer

11. **USB 2.0 ports 1 and 2.** These two 4-pin Universal Serial Bus (USB) ports are available for connecting USB 2.0 devices.
12. **USB 2.0 ports 3 and 4.** These two 4-pin Universal Serial Bus (USB) ports are available for connecting USB 2.0 devices.
13. **External SATA port.** This port connects to an external SATA box or a Serial ATA port multiplier.



The external SATA port supports external Serial ATA 3.0 Gb/s devices. Longer cables support higher power requirements to deliver signal up to two meters away, and enables improved hot-swap function.

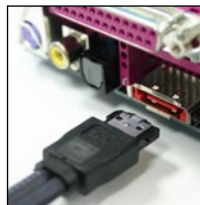

14. **Optical S/PDIF Out port.** This port connects an external audio output device via an optical S/PDIF cable.
15. **Coaxial S/PDIF Out port.** This port connects an external audio output device via a coaxial S/PDIF cable.
16. **PS/2 keyboard port (purple).** This port is for a PS/2 keyboard.

## 2.7.2 Internal connectors

### 1. Floppy disk drive connector (34-1 pin FLOPPY)

This connector is for the provided floppy disk drive (FDD) signal cable. Insert one end of the cable to this connector, then connect the other end to the signal connector at the back of the floppy disk drive.



Pin 5 on the connector is removed to prevent incorrect cable connection when using a FDD cable with a covered Pin 5.

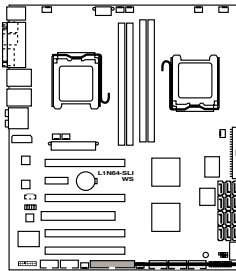

**L1N64-SLI WS Floppy disk drive connector**

#### FLOPPY



PIN 1

**NOTE:** Orient the red markings on the floppy ribbon cable to PIN 1.

### 2. NVIDIA® IDE connector (40-1 pin PRI\_IDE)

The onboard IDE connector is for the Ultra DMA (133/100/66) signal cable. There are three connectors on each Ultra DMA 133/100/66 signal cable: blue, black, and gray. Connect the blue connector to the motherboard's IDE connector, then select one of the following modes to configure your device.

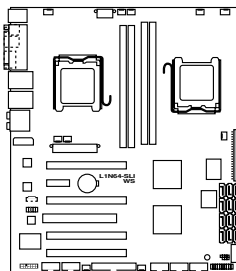

**L1N64-SLI WS IDE connector**

#### PRI\_IDE

**NOTE:** Orient the red markings (usually zigzag) on the IDE ribbon cable to PIN 1.



Drive jumper setting		Mode of device(s)	Cable connector
Single device	Cable-Select or Master	-	Black
Two devices	Cable-Select	Master	Black
		Slave	Gray
	Master	Master	Black or gray
	Slave	Slave	



- Pin 20 on the IDE connector is removed to match the covered hole on the Ultra DMA cable connector. This prevents incorrect insertion when you connect the IDE cable.
- Use the 80-conductor IDE cable for Ultra DMA 100/66 IDE devices.



If any device jumper is set as "Cable-Select," make sure all other device jumpers have the same setting.

**3. NVIDIA® MCP55PXE Southbridge Serial ATA connectors (7-pin SATA1-6 [red], SATA7-12 [black])**

These connectors are for the Serial ATA signal cables for Serial ATA 3.0 Gb/s hard disk and optical disk drives. The Serial ATA 3.0 Gb/s is backward compatible with Serial ATA 1.5 Gb/s specification.

If you installed Serial ATA hard disk drives, you can create a RAID 0, RAID 1, RAID 0+1, RAID 5, or JBOD configuration through the onboard NVIDIA® MediaShield™ controller.

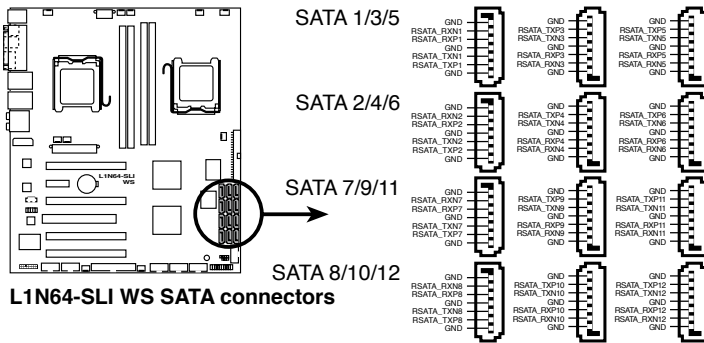

**4. USB connectors (10-1 pin USB56, USB78, USB910)**

These connectors are for USB 2.0 ports. Connect the USB/GAME module cable to any of these connectors, then install the module to a slot opening at the back of the system chassis. These USB connectors comply with USB 2.0 specification that supports up to 480 Mbps connection speed.

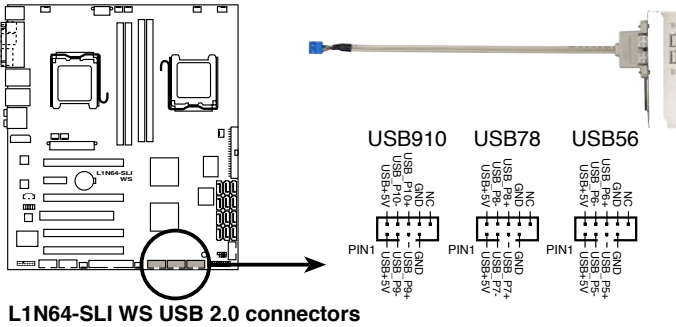

**L1N64-SLI WS USB 2.0 connectors**



Never connect a 1394 cable to the USB connectors. Doing so will damage the motherboard!

**5. IEEE 1394a port connectors (10-1 pin IE1394\_1; 10-1 pin IE1394\_2)**

These connectors are for IEEE 1394a ports. Connect the IEEE 1394a module cables to any of these connectors, then install the module to a slot opening at the back of the system chassis.

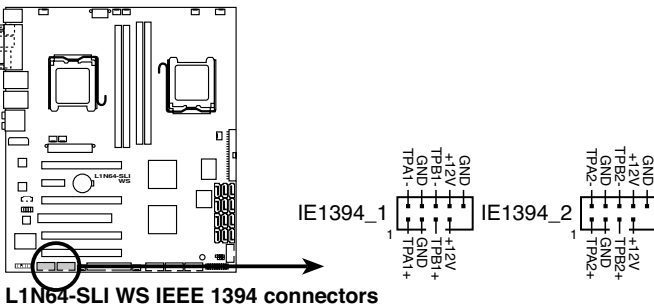

**L1N64-SLI WS IEEE 1394 connectors**



Never connect a USB cable to the IEEE 1394a connector. Doing so will damage the motherboard!



**6. CPU, Chassis, Power, and Heat-pipe Fan connectors  
(4-pin CPU0\_FAN, 4-pin CPU1-FAN, 3-pin HP\_FAN1~3 3-pin CHA\_FAN1~4, SPS\_FAN1)**

The fan connectors support cooling fans of 350 mA ~ 2000 mA (24 W max.) or a total of 1 A ~ 3.48 A (41.76 W max.) at +12V. Connect the fan cables to the fan connectors on the motherboard, making sure that the black wire of each cable matches the ground pin of the connector.



Do not forget to connect the fan cables to the fan connectors. Insufficient air flow inside the system may damage the motherboard components. These are not jumpers! Do not place jumper caps on the fan connectors!

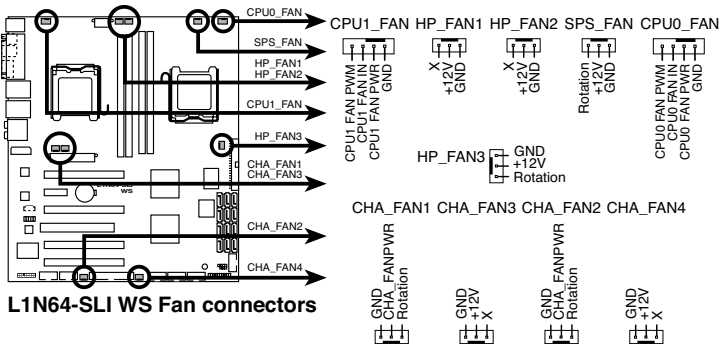

**7. Chassis intrusion connector (4-1 pin CHASSIS)**

This connector is for a chassis-mounted intrusion detection sensor or switch. Connect one end of the chassis intrusion sensor or switch cable to this connector. The chassis intrusion sensor or switch sends a high-level signal to this connector when a chassis component is removed or replaced. The signal is then generated as a chassis intrusion event.

By default, the pins labeled “Chassis Signal” and “Ground” are shorted with a jumper cap. Remove the jumper caps only when you intend to use the chassis intrusion detection feature.

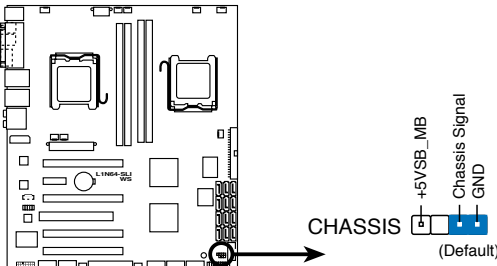

**L1N64-SLI WS Chassis intrusion connector**

**8. Power connectors (24-pin EATXPWR, 8-pin EATX12V, 4-pin EZ\_PLUG1)**

These connectors are for ATX power supply plugs. The power supply plugs are designed to fit these connectors in only one orientation. Find the proper orientation and push down firmly until the connectors completely fit.

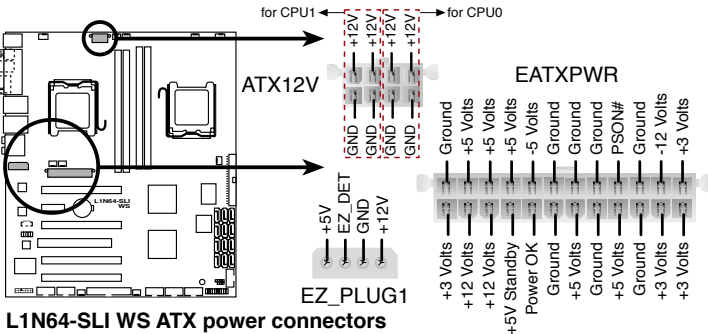

**L1N64-SLI WS ATX power connectors**



- Make sure to connect the 8-pin ATX +12V power plug when installing two CPUs.
- You can either use the 4-pin +12V power plug or 8-pin ATX +12V power plug when installing only one CPU.



- For a fully configured system, we recommend that you use a power supply unit (PSU) that complies with ATX 12 V Specification 2.0 (or later version) and provides a minimum power of 600 W.
- Do not forget to connect the 4-pin/8-pin ATX +12 V power plug; otherwise, the system will not boot up.
- Make sure to connect the EZ Plug™ when using two PCI Express graphics card and a 20-pin ATX power supply unit; otherwise, the system will be unstable.
- Use of a PSU with a higher power output is recommended when configuring a system with more power-consuming devices. The system may become unstable or may not boot up if the power is inadequate.

## 9. Front panel audio connector (10-1 pin AAFP)

This connector is for a chassis-mounted front panel audio I/O module that supports either HD Audio or legacy AC '97 audio standard. Connect one end of the front panel audio I/O module cable to this connector.

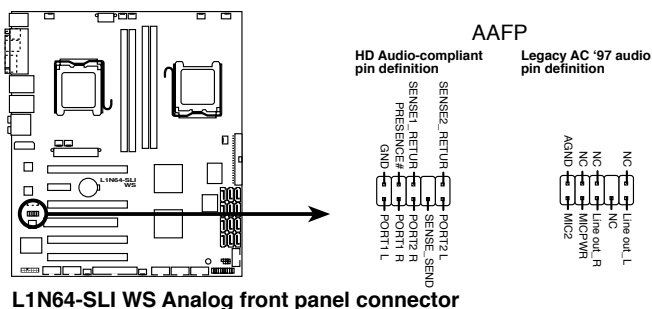

**L1N64-SLI WS Analog front panel connector**



- We recommend that you connect a high-definition front panel audio module to this connector to avail of the motherboard's high-definition audio capability.
- By default, this connector is set to [AC97]. If you want to connect a high-definition front panel audio module to this connector, set the **Front Panel Type** item in the BIOS to [HD Audio]. See page 4-23 for details.

**10. Internal audio connector (4-pin CD [Black])**

These connectors allow you to receive stereo audio input from sound sources such as a CD-ROM, TV tuner, or MPEG card.

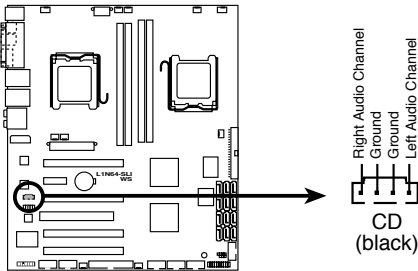

**L1N64-SLI WS Internal audio connector**

**11. Serial port connector (10-1 pin COM1)**

This connector is for a serial (COM) port. Connect the serial port module cable to this connector, then install the module to a slot opening at the back of the system chassis.

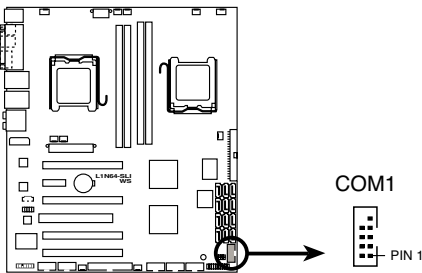

**L1N64-SLI WS COM port connector**

## 12. TPM connector (20-1 pin TPM) [Optional]

This connector supports a Trusted Platform Module (TPM) system, which can securely store keys, digital certificates, passwords, and data. A TPM system also helps enhance network security, protects digital identities, and ensures platform integrity.

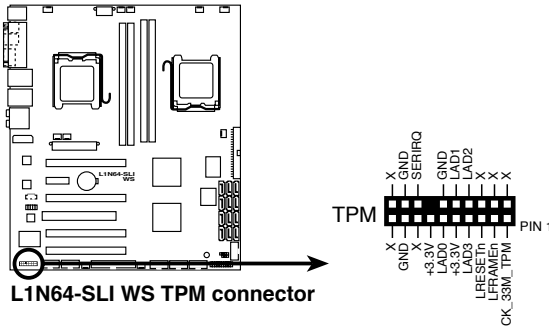

The TPM module is purchased separately.

### 13. System panel connector (20-8 pin PANEL)

This connector supports several chassis-mounted functions.

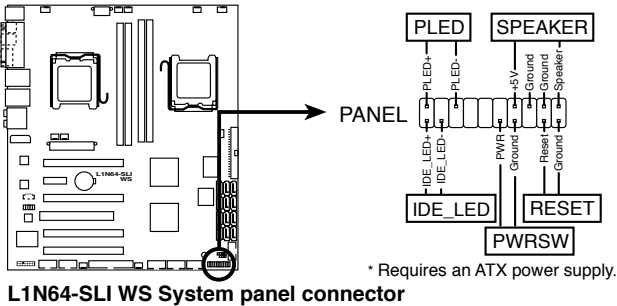

- **System power LED (2-pin PLED)**

This 3-pin connector is for the system power LED. Connect the chassis power LED cable to this connector. The system power LED lights up when you turn on the system power, and blinks when the system is in sleep mode.

- **Hard disk drive activity LED (2-pin IDE\_LED)**

This 2-pin connector is for the HDD Activity LED. Connect the HDD Activity LED cable to this connector. The IDE LED lights up or flashes when data is read from or written to the HDD.

- **System warning speaker (4-pin SPEAKER)**

This 4-pin connector is for the chassis-mounted system warning speaker. The speaker allows you to hear system beeps and warnings.

- **ATX power button/soft-off button (2-pin PWRSW)**

This connector is for the system power button. Pressing the power button turns the system on or puts the system in sleep or soft-off mode depending on the BIOS settings. Pressing the power switch for more than four seconds while the system is ON turns the system OFF.

- **Reset button (2-pin RESET)**

This 2-pin connector is for the chassis-mounted reset button for system reboot without turning off the system power.

This chapter describes the power up sequence and ways of shutting down the system.

# Powering up **3**

## Chapter summary

# 3

<b>3.1</b>	<b>Starting up for the first time.....</b>	<b>3-1</b>
<b>3.2</b>	<b>Powering off the computer.....</b>	<b>3-2</b>



## 3.1 Starting up for the first time

1. After making all the connections, replace the system case cover.
2. Be sure that all switches are off.
3. Connect the power cord to the power connector at the back of the system chassis.
4. Connect the power cord to a power outlet that is equipped with a surge protector.
5. Turn on the devices in the following order:
  - a. Monitor
  - b. External SCSI devices (starting with the last device on the chain)
  - c. System power
6. After applying power, the system power LED on the system front panel case lights up. For systems with ATX power supplies, the system LED lights up when you press the ATX power button. If your monitor complies with "green" standards or if it has a "power standby" feature, the monitor LED may light up or switch between orange and green after the system LED turns on.

The system then runs the power-on self tests or POST. While the tests are running, the BIOS beeps or additional messages appear on the screen. If you do not see anything within 30 seconds from the time you turned on the power, the system may have failed a power-on test. Check the jumper settings and connections or call your retailer for assistance.
7. At power on, hold down the <Delete> key to enter the BIOS Setup. Follow the instructions in Chapter 4.

## **3.2 Powering off the computer**

### **3.2.1 Using the OS shut down function**

If you are using Windows® 2000:

1. Click the Start button then click Shut Down...
2. Make sure that the Shut Down option button is selected, then click the OK button to shut down the computer.
3. The power supply should turn off after Windows® shuts down.

If you are using Windows® XP:

1. Click the Start button then select Turn Off Computer.
2. Click the Turn Off button to shut down the computer.
3. The power supply should turn off after Windows® shuts down.

### **3.2.2 Using the dual function power switch**

While the system is ON, pressing the power switch for less than four seconds puts the system to sleep mode or to soft-off mode, depending on the BIOS setting. Pressing the power switch for more than four seconds lets the system enter the soft-off mode regardless of the BIOS setting. Refer to section "4.5 Power Menu" in Chapter 4 for details.

This chapter tells how to change the system settings through the BIOS Setup menus. Detailed descriptions of the BIOS parameters are also provided.

# BIOS setup 4

4.1	Managing and updating your BIOS .....	4-1
4.2	BIOS setup program .....	4-9
4.3	Main menu .....	4-12
4.4	Advanced menu .....	4-17
4.5	Power menu.....	4-29
4.6	Boot menu .....	4-34
4.7	Exit menu.....	4-39

## 4.1 Managing and updating your BIOS

The following utilities allow you to manage and update the motherboard Basic Input/Output System (BIOS) setup.

1. ASUS Update (Updates the BIOS in Windows® environment.)
2. ASUS AFUDOS (Updates the BIOS in DOS mode using a bootable floppy disk.)

Refer to the corresponding sections for details on these utilities.



---

Save a copy of the original motherboard BIOS file to a bootable floppy disk in case you need to restore the BIOS in the future. Copy the original motherboard BIOS using the ASUS Update or AFUDOS utilities.

---

### 4.1.1 ASUS Update utility

The ASUS Update is a utility that allows you to manage, save, and update the motherboard BIOS in Windows® environment. The ASUS Update utility allows you to:

- Save the current BIOS file
- Download the latest BIOS file from the Internet
- Update the BIOS from an updated BIOS file
- Update the BIOS directly from the Internet, and
- View the BIOS version information.

This utility is available in the support CD that comes with the motherboard package.



---

ASUS Update requires an Internet connection either through a network or an Internet Service Provider (ISP).

---

### Installing ASUS Update

To install ASUS Update:

1. Place the support CD in the optical drive. The Drivers menu appears.
2. Click the Utilities tab, then click ASUS Update. See page 5-3 for the Utilities screen menu.
3. The ASUS Update utility is copied to your system.



---

Quit all Windows® applications before you update the BIOS using this utility.

---

## Updating the BIOS through the Internet

To update the BIOS through the Internet:

1. Launch the ASUS Update utility from the Windows® desktop by clicking Start > Programs > ASUS > ASUSUpdate > ASUSUpdate. The ASUS Update main window appears.

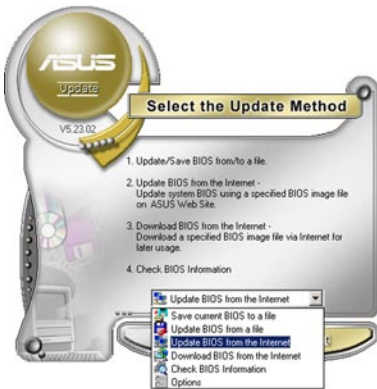
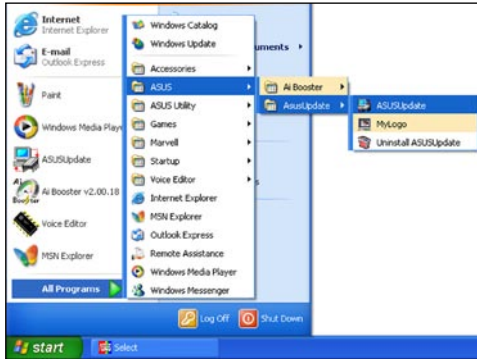

2. Select Update BIOS from the Internet option from the drop-down menu, then click Next.



3. Select the ASUS FTP site nearest you to avoid network traffic, or click Auto Select. Click Next.

- From the FTP site, select the BIOS version that you wish to download. Click Next.
- Follow the screen instructions to complete the update process.



The ASUS Update utility is capable of updating itself through the Internet. Always update the utility to avail of all its features.



## Updating the BIOS through a BIOS file

To update the BIOS through a BIOS file:

- Launch the ASUS Update utility from the Windows® desktop by clicking Start > Programs > ASUS > ASUSUpdate > ASUSUpdate. The ASUS Update main window appears.
- Select Update BIOS from a file option from the drop-down menu, then click Next.



- Locate the BIOS file from the Open window, then click Save.
- Follow the screen instructions to complete the update process.

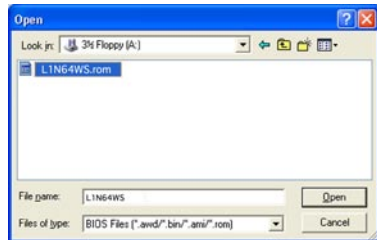

## 4.1.2 Creating a bootable floppy disk

1. Do either one of the following to create a bootable floppy disk.
  - DOS environment*
  - a. Insert a 1.44MB floppy disk into the drive.
  - b. At the DOS prompt, type `format A: /S` then press <Enter>.
  - Windows® XP environment*
  - a. Insert a 1.44 MB floppy disk to the floppy disk drive.
  - b. Click Start from the Windows® desktop, then select My Computer.
  - c. Select the 3 1/2 Floppy Drive icon.
  - d. Click File from the menu, then select Format. A Format 3 1/2 Floppy Disk window appears.
  - e. Windows® XP users: Select Create an MS-DOS startup disk from the format options field, then click Start.
  - Windows® 2000 environment*
  - To create a set of boot disks for Windows® 2000:
    - a. Insert a formatted, high density 1.44 MB floppy disk into the drive.
    - b. Insert the Windows® 2000 CD to the optical drive.
    - c. Click Start, then select Run.
    - d. In the Open field, type `D:\bootdisk\makeboot a:` assuming that D is your optical drive letter.
    - e. Press <Enter>, then follow screen instructions to continue.
2. Copy the original or the latest motherboard BIOS file to the bootable floppy disk.



### 4.1.3 AFUDOS utility

The AFUDOS utility allows you to update the BIOS file in DOS environment using a bootable floppy disk with the updated BIOS file. This utility also allows you to copy the current BIOS file that you can use as backup when the BIOS fails or gets corrupted during the updating process.

#### Copying the current BIOS

To copy the current BIOS file using the AFUDOS utility:



- Make sure that the floppy disk is not write-protected and has at least 1.2 MB free space to save the file.
- The succeeding BIOS screens are for reference only. The actual BIOS screen displays may not be same as shown.

1. Copy the AFUDOS utility (afudos.exe) from the motherboard support CD to the bootable floppy disk you created earlier.
2. Boot the system in DOS mode, then at the prompt type:

```
afudos /o[filename]
```

where the [filename] is any user-assigned filename not more than eight alphanumeric characters for the main filename and three alphanumeric characters for the extension name.

```
A:\>afudos /oOLDBIOS1.rom
```

Main filename

Extension name

3. Press <Enter>. The utility copies the current BIOS file to the floppy disk.

```
A:\>afudos /oOLDBIOS1.rom
AMI Firmware Update Utility - Version 1.19 (ASUS V2.07 (03.11.24BB))
Copyright (C) 2002 American Megatrends, Inc. All rights reserved.
Reading flash ..... done
Write to file..... ok
A:\>
```

The utility returns to the DOS prompt after copying the current BIOS file.

## Updating the BIOS file

To update the BIOS file using the AFUDOS utility:

1. Visit the ASUS website ([www.asus.com](http://www.asus.com)) and download the latest BIOS file for the motherboard. Save the BIOS file to a bootable floppy disk.



---

Write the BIOS filename on a piece of paper. You need to type the exact BIOS filename at the DOS prompt.

---

2. Copy the AFUDOS utility (`afudos.exe`) from the motherboard support CD to the bootable floppy disk you created earlier.
3. Boot the system in DOS mode, then at the prompt type:

```
afudos /i [filename]
```

where [filename] is the latest or the original BIOS file on the bootable floppy disk.

```
A:\>afudos /LIN64WS.rom
```

4. The utility verifies the file and starts updating the BIOS.

```
A:\>afudos /LIN64WS.rom
AMI Firmware Update Utility - Version 1.19(ASUS V2.07(03.11.24BB))
Copyright (C) 2002 American Megatrends, Inc. All rights reserved.

WARNING!! Do not turn off power during flash BIOS
Reading file ..... done
Reading flash ..... done

Advance Check .....
Erasing flash ..... done
Writing flash ..... 0x0008CC00 (9%)
```



---

Do not shut down or reset the system while updating the BIOS to prevent system boot failure!

---

5. The utility returns to the DOS prompt after the BIOS update process is completed. Reboot the system from the hard disk drive.

```
A:\>afudos /L1N64WS.com
AMI Firmware Update Utility - Version 1.19 (ASUS V2.07 (03.11.24BB))
Copyright (C) 2002 American Megatrends, Inc. All rights reserved.

WARNING!! Do not turn off power during flash BIOS
Reading file ..... done
Reading flash ..... done

Advance Check .....
Erasing flash ..... done
Writing flash ..... done
Verifying flash .... done

Please restart your computer

A:\>
```

## 4.1.4 ASUS CrashFree BIOS 3 utility

The ASUS CrashFree BIOS 3 is an auto recovery tool that allows you to restore the BIOS file when it fails or gets corrupted during the updating process. You can update a corrupted BIOS file using the motherboard support CD or the floppy disk that contains the updated BIOS file.



---

Prepare the motherboard support CD or the floppy disk containing the updated motherboard BIOS before using this utility.

---

### Recovering the BIOS from the support CD

To recover the BIOS from the support CD:

1. Turn on the system.
2. Insert the motherboard support CD to the optical drive.
3. The utility displays the following message and automatically checks the CD for the BIOS file.

```
Award BootBlock BIOS v1.0
Copyright (c) 2000, Award Software, Inc.

BIOS ROM checksum error
Detecting IDE ATAPI device...
```

When found, the utility reads the BIOS file and starts flashing the corrupted BIOS file.

```
Award BootBlock BIOS v1.0
Copyright (c) 2000, Award Software, Inc.

BIOS ROM checksum error
Detecting IDE ATAPI device...
Found CDROM, try to Boot from it... Pass
```

4. Restart the system after the utility completes the updating process.

### Recovering the BIOS from the USB flash disk

To recover the BIOS from the USB flash disk:

1. Insert the USB flash disk that contains BIOS file to the USB port.
2. Turn on the system.
3. The utility will automatically checks the devices for the BIOS file When found, the utility reads the BIOS file and starts flashing the corrupted BIOS file.
4. Restart the system after the utility completes the updating process.



- Only the USB flash disk with FAT 32/16/12 format and single partition can support ASUS CrashFree BIOS 3. The device size should be smaller than 8GB.
  - DO NOT shut down or reset the system while updating the BIOS! Doing so can cause system boot failure!
-

## 4.2 BIOS setup program

This motherboard supports a programmable firmware chip that you can update using the provided utility described in section “4.1 Managing and updating your BIOS.”

Use the BIOS Setup program when you are installing a motherboard, reconfiguring your system, or prompted to “Run Setup.” This section explains how to configure your system using this utility.

Even if you are not prompted to use the Setup program, you can change the configuration of your computer in the future. For example, you can enable the security password feature or change the power management settings. This requires you to reconfigure your system using the BIOS Setup program so that the computer can recognize these changes and record them in the CMOS RAM or the firmware hub.

The firmware hub on the motherboard stores the Setup utility. When you start up the computer, the system provides you with the opportunity to run this program. Press <Del> during the Power-On-Self-Test (POST) to enter the Setup utility; otherwise, POST continues with its test routines.

If you wish to enter Setup after POST, restart the system by pressing <Ctrl+Alt+Delete>, or by pressing the reset button on the system chassis. You can also restart by turning the system off and then back on. Do this last option only if the first two failed.

The Setup program is designed to make it as easy to use as possible. Being a menu-driven program, it lets you scroll through the various sub-menus and make your selections from the available options using the navigation keys.



- 
- The default BIOS settings for this motherboard apply for most conditions to ensure optimum performance. If the system becomes unstable after changing any BIOS settings, load the default settings to ensure system compatibility and stability. Select the Load Default Settings item under the Exit Menu. See section “4.7 Exit Menu.”
  - The BIOS setup screens shown in this section are for reference purposes only, and may not exactly match what you see on your screen.
  - Visit the ASUS website ([www.asus.com](http://www.asus.com)) to download the latest BIOS file for this motherboard.
-

## 4.2.1 BIOS menu screen

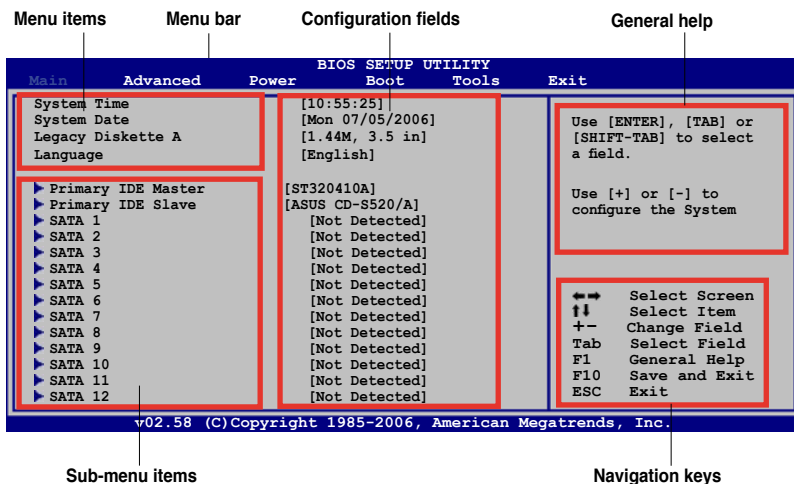

## 4.2.2 Menu bar

The menu bar on top of the screen has the following main items:

- Main** For changing the basic system configuration
- Advanced** For changing the advanced system settings
- Power** For changing the advanced power management (APM) configuration
- Boot** For changing the system boot configuration
- Tools** For configuring options for special functions
- Exit** For selecting the exit options and loading default settings

To select an item on the menu bar, press the right or left arrow key on the keyboard until the desired item is highlighted.

## 4.2.3 Navigation keys

At the bottom right corner of a menu screen are the navigation keys for that particular menu. Use the navigation keys to select items in the menu and change the settings.



Some of the navigation keys differ from one screen to another.

## 4.2.4 Menu items

The highlighted item on the menu bar displays the specific items for that menu. For example, selecting Main shows the Main menu items.

The other items (Advanced, Power, Boot, and Exit) on the menu bar have their respective menu items.

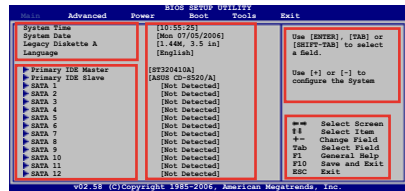

Main menu items

## 4.2.5 Sub-menu items

A solid triangle before each item on any menu screen means that the item has a sub-menu. To display the sub-menu, select the item and press <Enter>.

## 4.2.6 Configuration fields

These fields show the values for the menu items. If an item is user-configurable, you can change the value of the field opposite the item. You cannot select an item that is not user-configurable.

A configurable field is enclosed in brackets, and is highlighted when selected. To change the value of a field, select it then press <Enter> to display a list of options. Refer to “4.2.7 Pop-up window.”

## 4.2.7 Pop-up window

Select a menu item then press <Enter> to display a pop-up window with the configuration options for that item.

## 4.2.8 Scroll bar

A scroll bar appears on the right side of a menu screen when there are items that do not fit on the screen. Press the Up/Down arrow keys or <Page Up> /<Page Down> keys to display the other items on the screen.

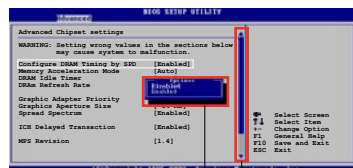

Pop-up window

Scroll bar

## 4.2.9 General help

At the top right corner of the menu screen is a brief description of the selected item.

## 4.3 Main menu

When you enter the BIOS Setup program, the Main menu screen appears, giving you an overview of the basic system information.



Refer to section "4.2.1 BIOS menu screen" for information on the menu screen items and how to navigate through them.

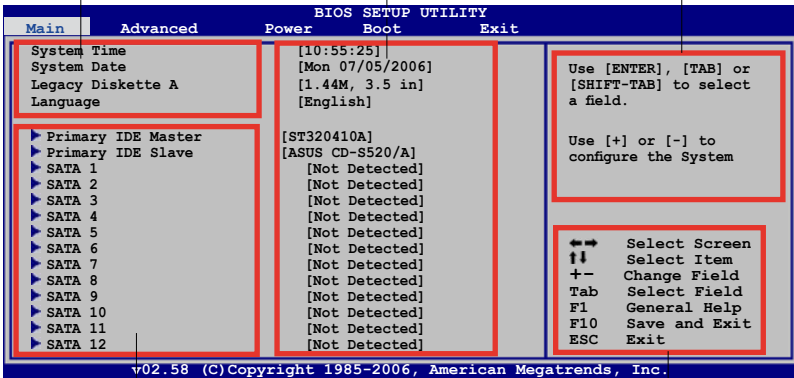

### 4.3.1 System Time [xx:xx:xx]

Allows you to set the system time.

### 4.3.2 System Date [Day xx/xx/xxxx]

Allows you to set the system date.

### 4.3.3 Legacy Diskette A [1.44M, 3.5 in.]

Sets the type of floppy drive installed. Configuration options: [Disabled] [360K, 5.25 in.] [1.2M, 5.25 in.] [720K, 3.5 in.] [1.44M, 3.5 in.] [2.88M, 3.5 in.]

### 4.3.4 Language [English]

Allows you to choose the BIOS language version from the options. Configuration options: [English] [Français] [German] [Japanese] [Chinese (GB)] [Chinese BIG5]



### 4.3.5 Primary IDE Master/Slave

The BIOS automatically detects the connected IDE devices. There is a separate sub-menu for each IDE device. Select a device item, then press <Enter> to display the IDE device information.

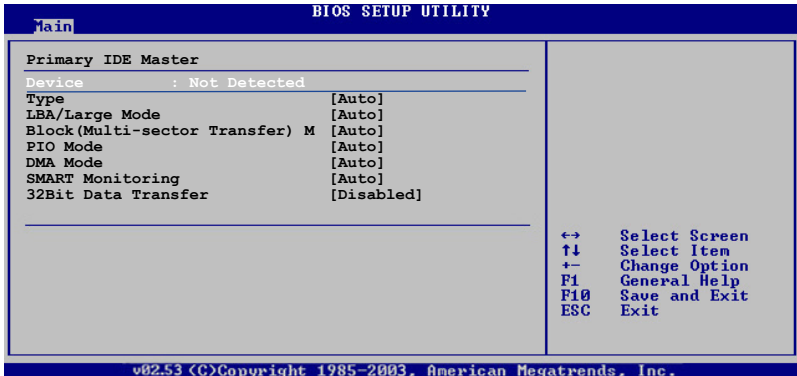

The BIOS automatically detects the values opposite the dimmed items (Device, Vendor, Size, LBA Mode, Block Mode, PIO Mode, Async DMA, Ultra DMA, and SMART monitoring). These values are not user-configurable. These items show N/A if no IDE device is installed in the system.

#### Type [Auto]

Selects the type of IDE drive. Setting to [Auto] allows automatic selection of the appropriate IDE device type. Select [CDROM] if you are specifically configuring a CD-ROM drive. Select [ARMD] (ATAPI Removable Media Device) if your device is either a ZIP, LS-120, or MO drive.

Configuration options: [Not Installed] [Auto] [CDROM] [ARMD]

#### LBA/Large Mode [Auto]

Enables or disables the LBA mode. Setting to [Auto] enables the LBA mode if the device supports this mode, and if the device was not previously formatted with LBA mode disabled. Configuration options: [Disabled] [Auto]

#### Block (Multi-sector Transfer) M [Auto]

Enables or disables data multi-sector transfer mode. When set to [Auto], the data transfer from and to the device occurs multiple sectors at a time if the device supports multi-sector transfer feature. When set to [Disabled], the data transfer from and to the device occurs one sector at a time. Configuration options: [Disabled] [Auto]

### PIO Mode [Auto]

Selects the PIO mode.

Configuration options: [Auto] [0] [1] [2] [3] [4]

### DMA Mode [Auto]

Selects the DMA mode. Configuration options: [Auto] [SWDMA0] [SWDMA1] [SWDMA2] [MWDMA0] [MWDMA1] [MWDMA2] [UDMA0] [UDMA1] [UDMA2] [UDMA3] [UDMA4] [UDMA5]

### SMART Monitoring [Auto]

Sets the Smart Monitoring, Analysis, and Reporting Technology. Configuration options: [Auto] [Disabled] [Enabled]

### 32Bit Data Transfer [Enabled]

Enables or disables 32-bit data transfer.

Configuration options: [Disabled] [Enabled]

## 4.3.6 SATA 1-12

While entering Setup, the BIOS automatically detects the presence of Serial ATA devices. There is a separate sub-menu for each SATA device. Select a device item, then press <Enter> to display the SATA device information.

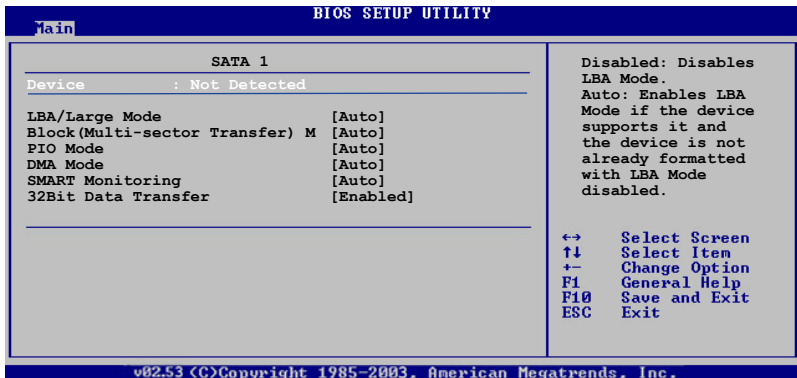

### LBA/Large Mode [Auto]

Enables or disables the LBA mode. Setting to [Auto] enables the LBA mode if the device supports this mode, and if the device was not previously formatted with LBA mode disabled. Configuration options: [Disabled] [Auto]

### Block (Multi-sector Transfer) M [Auto]

Enables or disables data multi-sector transfer mode. When set to [Auto], the data transfer from and to the device occurs multiple sectors at a time if the device supports multi-sector transfer feature. When set to [Disabled], the data transfer from and to the device occurs one sector at a time. Configuration options: [Disabled] [Auto]

### PIO Mode [Auto]

Selects the PIO mode.  
Configuration options: [Auto] [0] [1] [2] [3] [4]

### DMA Mode [Auto]

Selects the DMA mode. Configuration options: [Auto] [SWDMA0] [SWDMA1] [SWDMA2] [MWDMA0] [MWDMA1] [MWDMA2] [UDMA0] [UDMA1] [UDMA2] [UDMA3] [UDMA4] [UDMA5]

### SMART Monitoring [Auto]

Sets the Smart Monitoring, Analysis, and Reporting Technology. Configuration options: [Auto] [Disabled] [Enabled]

### 32Bit Data Transfer [Enabled]

Enables or disables 32-bit data transfer.  
Configuration options: [Disabled] [Enabled]

## 4.3.7 IDE Configuration

The items in this menu allow you to set or change the configurations for the IDE devices installed in the system. Select an item then press <Enter> if you want to configure the item.

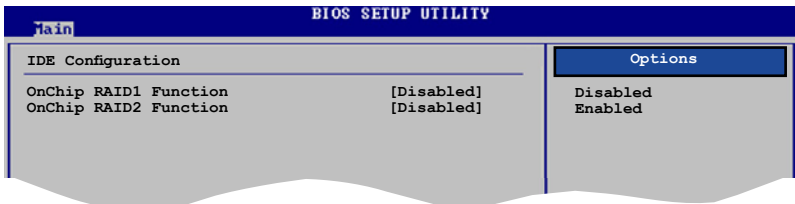

### OnChip RAID1 Function [Disabled]

Enables or disables the onchip RAID function.  
Configuration options: [Enabled] [Disabled]

### OnChip RAID2 Function [By RAID1]

Configuration options: [By RAID1]

### 4.3.8 System Information

This menu gives you an overview of the general system specifications. The BIOS automatically detects the items in this menu.

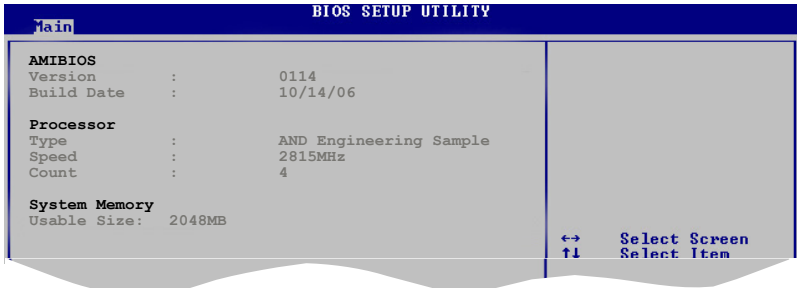

#### AMI BIOS

Displays the auto-detected BIOS information.

#### Processor

Displays the auto-detected CPU specification.

#### System Memory

Displays the auto-detected system memory.

## 4.4 Advanced menu

The Advanced menu items allow you to change the settings for the CPU and other system devices.



Take caution when changing the settings of the Advanced menu items. Incorrect field values can cause the system to malfunction.

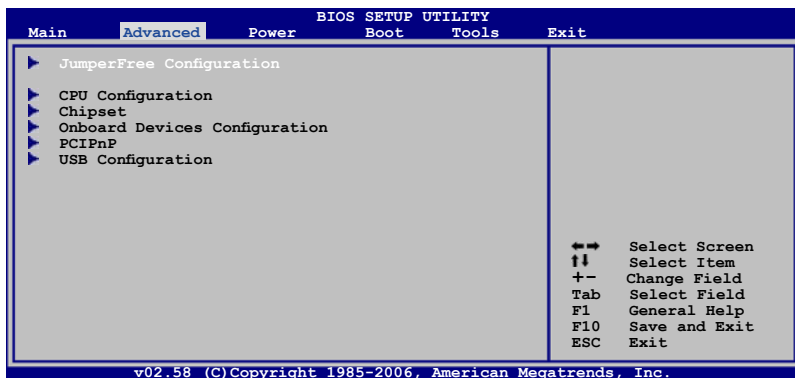

### 4.4.1 JumperFree Configuration

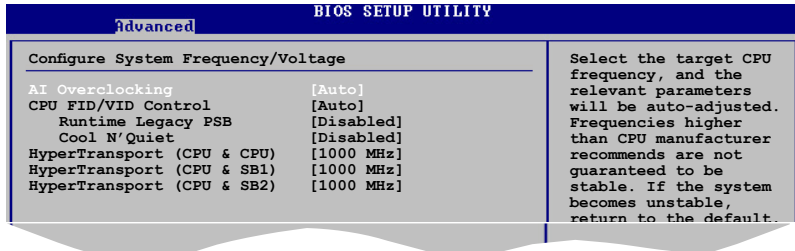

#### AI Overclocking [Auto]

Allows you to select the overclocking options to achieve the desired CPU internal frequency. Select either one of the preset overclocking configuration options.

- Manual Allows you to individually set overclocking parameters.
- Auto Loads the optimal settings for the system.
- Standard Loads the standard settings for the system.
- Overclock Profile Loads overclocking profiles with optimal parameters for stability when overclocking.

EPP Memory



---

The following items appear only when you set the AI Overclocking item to [manual].

---

#### ***FSB Frequency [200]***

Allows you to adjust the FSB frequency. The value of this item is auto-detected by the BIOS. Use the <+> and <-> keys to adjust the FSB frequency. You can also type the desired FSB frequency using the numeric keypad. The values range from 200 to 400.

#### ***PCIe Frequency [100]***

Allows you to adjust the PCIe frequency. The value of this item is auto-detected by the BIOS. Use the <+> and <-> keys to adjust the PCIe frequency. You can also type the desired PCIe frequency using the numeric keypad. The values range from 100 to 200.

---



The following items appear only when you set the AI Overclocking item to [manual] or [EPP Memory].

---

### **CPU1/CPU2 VCore Over-Voltage [Auto]**

Allows you to enable or disable VCore over-voltage.

Configuration options: [Auto] [+50mV] [+100mV] [+150mV] [+200mV]

### **DDR VTT Switch [Auto]**

Configuration options: [Auto] [0.6 x DDR Voltage] [0.5 x DDR Voltage]

### **DDR Voltage [Auto]**

Allows you to set the DDR memory voltage.

Configuration options: [Auto] [1.800V] [1.825V] [1.850V]...[2.475V] [2.500V]

---



Setting a very high voltage may damage the component permanently. Setting a very low voltage may cause the system to become unstable.

---

### **HyperTransport Voltage [Auto]**

Allows you to set the Hypertransport voltage.

Configuration options: [Auto] [1.200V] [1.250V] [1.300V] [1.350V] [1.400V]

### **1.5V Voltage [Auto]**

Configuration options: [Auto] [1.500V] [1.525V] [1.550V]...[1.675V] [1.700V]

### **1.5V Stand-By Voltage [Auto]**

Configuration options: [Auto] [1.500V] [1.600V] [1.700V]

### **AI Clock Skew 1 for Channel A/Channel B [Auto]**

Configuration options: [Auto] [Normal] [Advance 150ps] [Advance 300ps] ...[Advance 900] [Delay 150ps] [Delay 300ps]...[Delay 900]

### **AI Clock Skew 2 for Channel A/Channel B [Auto]**

Configuration options: [Auto] [Advance 900] [Advance 750ps] [Advance 600ps] ...[Advance 150] [Normal] [Delay 150ps] [Delay 300ps]...[Delay 900]

## CPU FID/VID Control [Auto]

When set to [Auto], FID/VID will be set at the rated frequency/voltage. When set to [Manual], FID/VID will be set based on the user selection.

Configuration options: [Auto] [Manual]

---



The following items appears only when you set the CPU FID/VID Control item to [Auto].

---

### Runtime Legacy PSB [Disabled]

Enables or disables the generation of Power State Block for the use of the PowerNow™ driver in a single-core system.

### Cool N' Quiet [Disabled]

Enables or disables the generation of ACPI\_PPC, ACPI\_PSS, and ACPI\_PCT objects.

---



The following items appears only when you set the CPU FID/VID Control item to [Auto] or set the AI Overclocking item to [EPP Memory].

---

### CPU Multiplier [Auto]

Allows you to set the operating CPU multiplier. The configuration options may vary depending on the type of CPU installed. Configuration options: [Auto] [x5.0] [x5.5] [x6.0] [x6.5] [x7.0] [x7.5]...[x24.5] [x25.0]

### CPU Voltage [Auto]

Allows you to set the operating CPU voltage.

Configuration options: [1.425V] [1.400V] [1.375V]...[0.825V] [0.800V] [Auto]

---

## HyperTransport (CPU & CPU) [1000MHz]

Configuration options: [200 MHz] [400 MHz] [600 MHz] [800 MHz] [1000 MHz]

## HyperTransport (CPU & SB1) [1000MHz]

Configuration options: [200 MHz] [400 MHz] [600 MHz] [800 MHz] [1000 MHz]

## HyperTransport (CPU & SB2) [1000MHz]

Configuration options: [200 MHz] [400 MHz] [600 MHz] [800 MHz] [1000 MHz]

---



The following item appears only when you set the AI Overclocking item to [Overclocking Profile] or [EPP Memory].

---

### Overclock Options [Overclock 5%]

Allows you to overclock the CPU speed through the available preset values.

Configuration options: [Overclock 3%] [Overclock 5%] [Overclock 10%] [Overclock 15%] [Overclock 20%] [Overclock 30%]

---



---

The following items appear only when you set the AI Overclocking item to [EPP Memory].

---

*EPP Mode [Optimal]*

Allows you to set the EPP mode.

Configuration options: [Optimal] [High Performance] [High Frequency]

*CPU OC Percentage [100]*

Allows you to adjust the CPU OC percentage. Use the <+> and <-> keys to adjust the value. You can also type the desired value using the numeric keypad. The values range from 100 to 200.



## 4.4.2 CPU Configuration

The items in this menu show the CPU-related information that the BIOS automatically detects.

BIOS SETUP UTILITY	
Advanced	
<b>CPU Configuration</b>	Sets the ratio between CPU Core Clock and the FSB Frequency. NOTE: If an invalid ratio is set in CMOS then actual and setpoint values may differ.
AMD Engineering Sample	
Revision: F2	
Cache L1: 128KB	
Cache L2: 2048KB	
Speed : 2815MHz	
Current FSB Multiplier: 14x	
Maximum FSB Multiplier: 25x	
Able to Change Freq. : Yes	
uCode Patch Level : None Required	
GART Error Reporting [Disabled]	
	←→ Select Screen ↑↓ Select Item ← Change Option F1 General Help F10 Save and Exit ESC Exit
v02.53 (C)Copyright 1985-2003. American Megatrends, Inc.	

### GART Error Reporting [Disabled]

Allows you to enable or disable GART error checking for testing purpose.  
Configuration options: [Disabled] [Enabled]

### 4.4.3 Chipset

The Chipset menu allows you to change the advanced chipset settings. Select an item then press <Enter> to display the sub-menu.

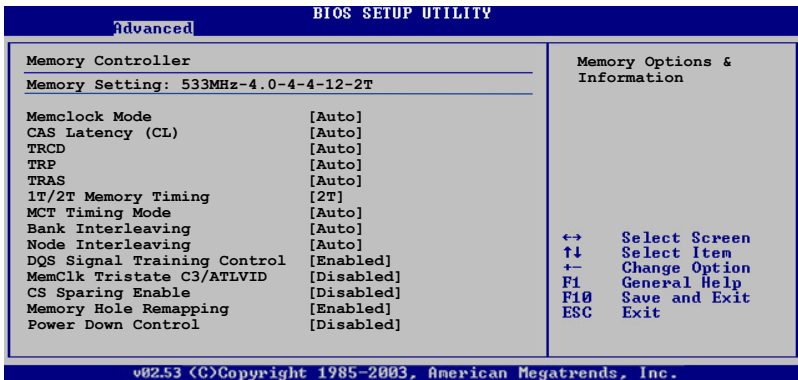
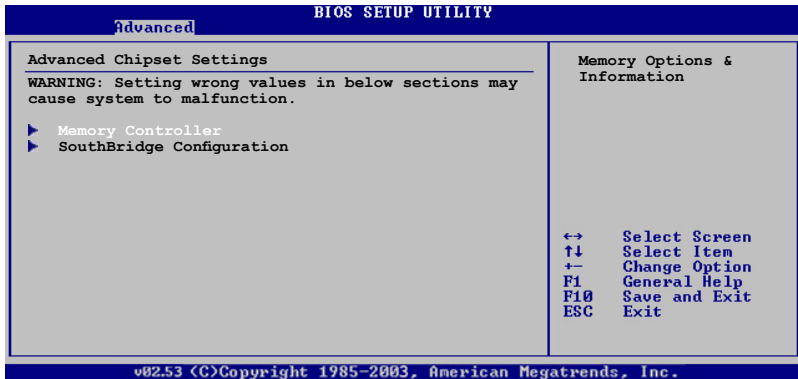

#### Memclock Mode [Auto]

[Auto] allows the BIOS to set the memclock mode automatically. [Limit] or [Manual] allows you to select from any of the standard values.

Configuration options: [Auto] [Limit] [Manual]



The following item appears when the Memclock Mode item is set to [Limit] or [Manual].

Memclock Value [400 MHz]

Allows you to set the memclock value.

Configuration options: [400 MHz] [533 MHz] [667 MHz] [800 MHz]

CAS Latency (CL) [Auto]

Configuration options: [Auto] [3.0] [4.0] [5.0] [6.0]

TRCD [Auto]

Configuration options: [Auto] [3 CLK] [4 CLK] [5 CLK] [6 CLK]

TRP [Auto]

Configuration options: [Auto] [3 CLK] [4 CLK] [5 CLK] [6 CLK]

TRAS [Auto]

Configuration options: [Auto] [5 CLK] [6 CLK] [7 CLK] [8 CLK]... [18 CLK]

1T/2T Memory Timing [2T]

Configuration options: [Auto] [1T] [2T]

MCT Timing Mode [Auto]

Allows you to manually configure the MCT Timing Mode parameters.

Configuration options: [Auto] [Manual]



---

The following items appear when the MCT Timing Mode item is set to [Manual].

---

TRRD [Auto]

Configuration options: [Auto] [2T] [3T] [4T] [5T]

TRC [Auto]

Configuration options: [Auto] [11T] [12T] [13T]...[25T] [26T]

Bank Interleaving [Auto]

Sets whether to allow memory accesses to be spread out over BANKS on the same node or across nodes, decreasing access contention.

Configuration options: [Disabled] [Auto]

Node Interleaving [Auto]

Sets whether to allow memory accesses to be spread out over NODES on the same node or across nodes, decreasing access contention.

Configuration options: [Disabled] [Auto]

DQS Signal Training Control [Disabled]

Enables or disable the DQS Signal Timing Training control.

Configuration options: [Enabled] [Disabled]

MemClk Tristate C3/ATLVID [Disabled]

Enables or disable the MemClk Tri-Stating during C3 and Alt VID.

Configuration options: [Enabled] [Disabled]

CS Sparing Enable [Disabled]

Configuration options: [Enabled] [Disabled]

Memory Hole Remapping [Enabled]

Enables or disable the memory remapping around the memory hole.

Configuration options: [Enabled] [Disabled]

Power Down Control [Disabled]

Allows DIMMs to enter the power down mode by deasserting the clock enable signal when DIMMs are not in use.

Configuration options: [Auto ] [Disabled]

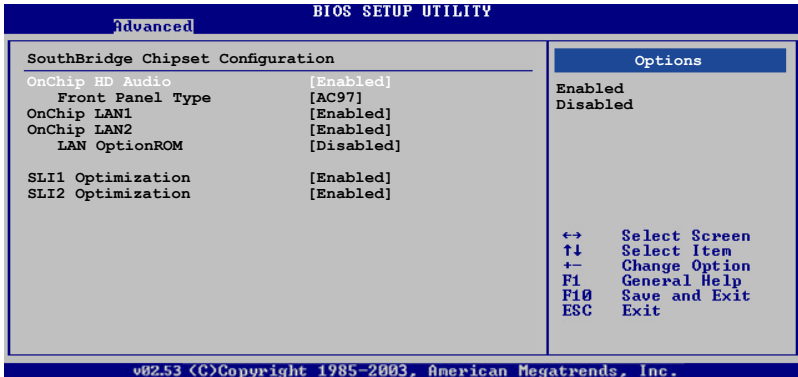

OnChip HD Audio [Enabled]

Enables or disables the onchip high-definition audio CODEC.

Configuration options: [Enabled] [Disabled]



The following item appears when the OnChip HD Audio item is set to [Enabled].

Front Panel Type [AC97]

Allows you to set the front panel audio connector (AAFP) mode to legacy AC'97 or high-definition audio depending on the audio standard that the front panel audio module supports.

Configuration options: [AC97] [HD Audio]

OnChip LAN1/LAN2 [Enabled]

Enables or disables the onchip LAN1/LAN2 controller.

Configuration options: [Enabled] [Disabled]

LAN OptionROM [Disabled]

Enables or disables the LAN boot ROM.

Configuration options: [Enabled] [Disabled]

SLI1/SLI2 Optimization [Enabled]

Configuration options: [Enabled] [Disabled]

## 4.4.4 Onboard Devices Configuration

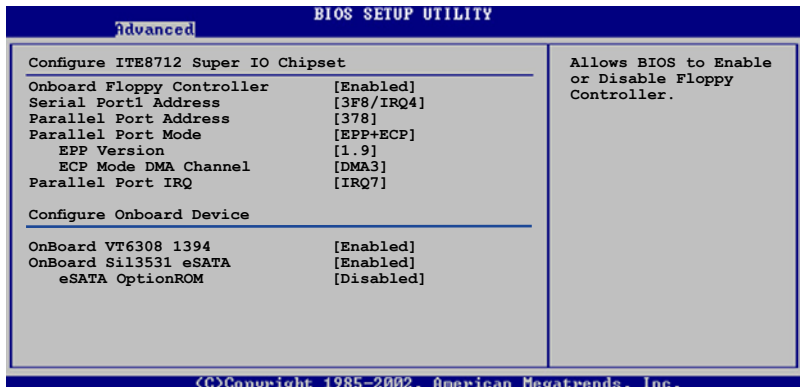

### Onboard Floppy Controller [Enabled]

Allows you to enable or disable the onboard floppy controller

Configuration options: [Enabled] [Disabled]

### Serial Port1 Address [3F8/IRQ4]

Allows you to select the Serial Port1 base address.

Configuration options: [Disabled] [3F8/IRQ4] [2F8/IRQ3] [3E8/IRQ4] [2E8/IRQ3]

### Parallel Port Address [378]

Allows you to select the Parallel Port base address.

Configuration options: [Disabled] [378] [278]

### Parallel Port Mode [EPP+ECP]

Allows you to select the Parallel Port mode.

Configuration options: [Normal] [EPP] [ECP] [EPP+ECP]

EPP Version [1.9]

Appears only when the Parallel Port Mode is set to [EPP] or [EPP+ECP]. This item allows the BIOS to select the Parallel Port EPP version.

Configuration options: [1.9] [1.7]

ECP Mode DMA Channel [DMA3]

Appears only when the Parallel Port Mode is set to [ECP] or [EPP+ECP]. This item allows the BIOS to set the Parallel Port ECP DMA.

Configuration options: [DMA0] [DMA1] [DMA3]

#### Parallel Port IRQ [IRQ7]

Allows you to select the parallel port IRQ.

Configuration options: [IRQ5] [IRQ7]

### **OnBoard VT6308 1394 [Enabled]**

Allows you to enable or disable the onboard VIA® VT6308 IEEE 1394a controller.  
Configuration options: [Enabled] [Disabled]

### **OnBoard Sil3531 eSATA [Enabled]**

Allows you to enable or disable the onboard Silicon Image® Sil3531 external SATA controller. Configuration options: [Enabled] [Disabled]

#### *eSATA OptionROM [Disabled]*

Allows you to enable or disable the Silicon Image® Sil3531 external SATA boot ROM.  
Configuration options: [Disabled] [Enabled]

## 4.4.5 PCI PnP

The PCI PnP menu items allow you to change the advanced settings for PCI/PnP devices.

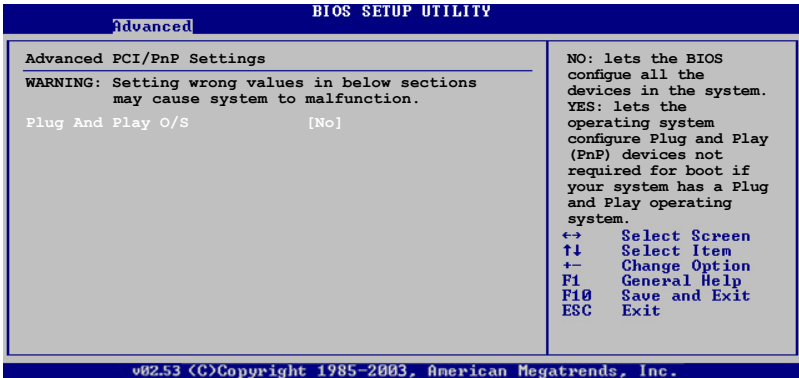

### Plug And Play O/S [No]

When set to [No], BIOS configures all the devices in the system. When set to [Yes] and if you install a Plug and Play operating system, the operating system configures the Plug and Play devices not required for boot. Configuration options: [No] [Yes]

## 4.4.6 USB Configuration

The items in this menu allows you to change the USB-related features. Select an item then press <Enter> to display the configuration options.

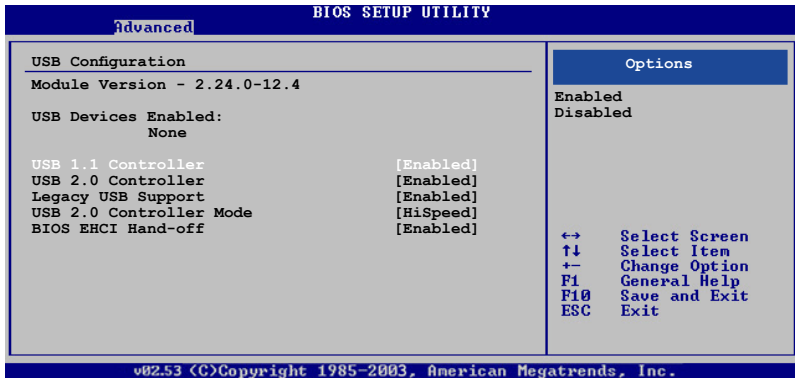

The Module Version and USB Devices Enabled items show the auto-detected values. If no USB device is detected, the item shows None.

### USB 1.1 Controller [Enabled]

Allows you to enable or disable the USB 1.1 controller.

Configuration options: [Enabled] [Disabled]



The following item appears only when the USB 1.1 Controller is set to [Enabled].

### USB 2.0 Controller [Enabled]

Allows you to enable or disable the USB 2.0 controller.

Configuration options: [Enabled] [Disabled]

### Legacy USB Support [Enabled]

Allows you to enable or disable support for legacy USB devices. Setting to [Auto] allows the system to detect the presence of USB devices at startup. If detected, the USB controller legacy mode is enabled. If no USB device is detected, the legacy USB support is disabled.

Configuration options: [Disabled] [Enabled] [Auto]

### USB 2.0 Controller Mode [HiSpeed]

Allows you to set the USB 2.0 controller mode to HiSpeed (480 Mbps) or FullSpeed (12 Mbps). Configuration options: [FullSpeed] [HiSpeed]

### BIOS EHCI Hand-off [Enabled]

Allows you to enable support for operating systems without an EHCI hand-off feature. Configuration options: [Disabled] [Enabled]



## 4.5 Power menu

The Power menu items allow you to change the settings for the ACPI and Advanced Power Management (APM) features. Select an item then press <Enter> to display the configuration options.

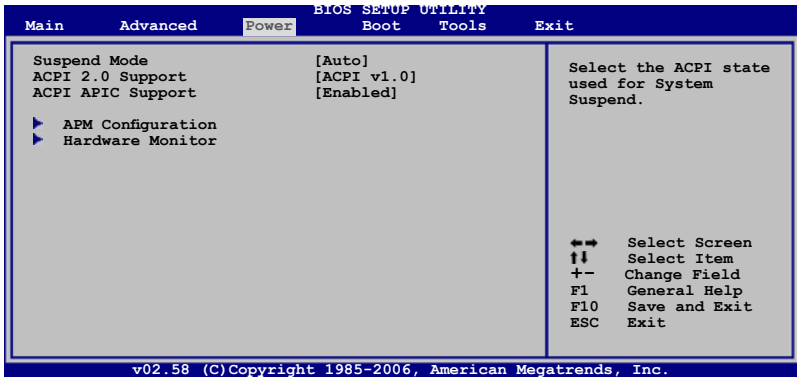

### 4.5.1 Suspend Mode [Auto]

Allows you to select the Advanced Configuration and Power Interface (ACPI) state to be used for system suspend. Setting this item to [Auto] allows the OS to select the ACPI state. Configuration options: [S1 (POS) only] [S3 only] [Auto]

### 4.5.2 ACPI 2.0 Support [ACPI v1.0]

Allows you to add more tables for Advanced Configuration and Power Interface (ACPI) 2.0 specifications. Configuration options: [ACPI v1.0] [ACPI v2.0] [ACPI v3.0]

### 4.5.3 ACPI APIC Support [Enabled]

Allows you to enable or disable the Advanced Configuration and Power Interface (ACPI) support in the Advanced Programmable Interrupt Controller (APIC). When set to Enabled, the ACPI APIC table pointer is included in the RSDT pointer list. Configuration options: [Disabled] [Enabled]

## 4.5.4 APM Configuration

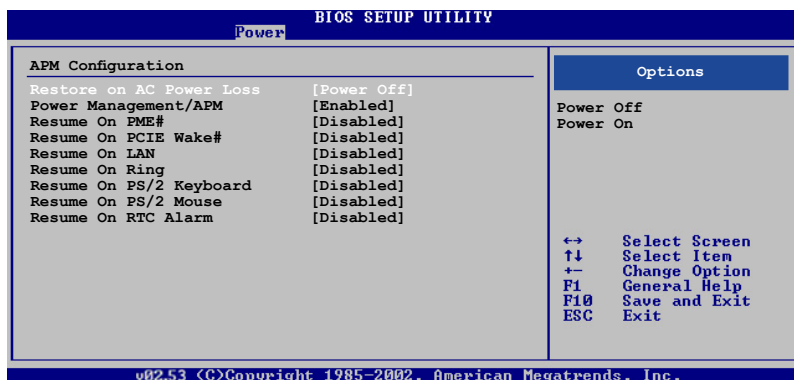

### Restore on AC Power Loss [Power Off]

When set to Power Off, the system goes into off state after an AC power loss. When set to Power On, the system goes on after an AC power loss. When set to Last State, the system goes into either off or on state, whatever the system state was before the AC power loss.

Configuration options: [Power Off] [Power On]

### Power Management/APM [Enabled]

Enables or disables the Advanced Power Management (APM) features.

Configuration options: [Disabled] [Enabled]



The succeeding items appear when the Power Management/APM item is set to [Enabled].

### Resume On PME# [Disabled]

Enables or disables the Power Management Event (PME) function to generate a wake event. Configuration options: [Disabled] [Enabled]

### Resume On PCIE Wake# [Disabled]

Enables or disables the PME to wake up from S5 by PCIE devices.

Configuration options: [Disabled] [Enabled]

### Resume On LAN [Disabled]

Enables or disables the Marvell® LAN to generate a wake event.

Configuration options: [Disabled] [Enabled]

### Resume On Ring [Disabled]

Enables or disables the RI to generate a wake event.

Configuration options: [Disabled] [Enabled]

## Resume On PS/2 Keyboard [Disabled]

Allows you to use specific keys on the keyboard to turn on the system. This feature requires an ATX power supply that provides at least 1A on the +5VSB lead. Configuration options: [Disabled] [Enabled]

## Resume On PS/2 Mouse [Disabled]

When set to [Enabled], this parameter allows you to use the PS/2 mouse to turn on the system. This feature requires an ATX power supply that provides at least 1A on the +5VSB lead. Configuration options: [Disabled] [Enabled]

## Resume on RTC Alarm [Disabled]

Allows you to enable or disable RTC to generate a wake event. Configuration options: [Disabled] [Enabled]

---

The succeeding items appear when the Resume on RTC Alarm item is set to [Enabled].

---

### RTC Alarm Date [xx]

To set the alarm date, highlight this item and press the <+> or <-> key to make the selection. Configuration options: [Every day] [1] [2] [3]... ~ [31]

### System Time [xx:xx:xx]

To set the alarm time, use [ENTER], [TAB], or [SHIFT-TAB] to select a field and press the <+> or <-> key to make the selection.

Configuration options: [00] [01]... ~ [23]

[00] [01]... ~ [59]

[00] [01]... ~ [59]

## 4.5.5 Hardware Monitor

BIOS SETUP UTILITY	
Power	
<b>Hardware Monitor</b>	
CPU1 Temperature	[60°C/140°F]
CPU2 Temperature	[60°C/140°F]
MB Temperature	[46°C/114.5°F]
Smart Fan Control [Disabled]	
CPU Fan Mode	[PWM]
CPU Fan1 Speed	[2564RPM]
CPU Fan2 Speed	[4354RPM]
CHA Fan1 Speed	[N/A]
CHA Fan2 Speed	[N/A]
SPS Fan Speed	[4655RPM]
HP Fan3 Speed	
VCORE1 Voltage	[ 1.440V]
VCORE2 Voltage	[ 1.440V]
3.3V Voltage	[ 2.992V]
5V Voltage	[ 4.889V]
12V Voltage	[10.579V]
CPU Temperature	
↔	Select Screen
↑↓	Select Item
+−	Change Option
F1	General Help
F10	Save and Exit
ESC	Exit

### CPU1/CPU2 Temperature [xxx°C/xxx°F]

### MB Temperature [xxx°C/xxx°F]

The onboard hardware monitor automatically detects and displays the motherboard and CPU temperatures. Select [Disabled] if you do not wish to display the detected temperatures.

### Smart Fan Control [Disabled]

Allows you to enable or disable the smart fan feature that smartly adjusts the fan speeds for more efficient system operation. Configuration options: [Disabled] [Enabled]

### CPU Fan Mode [PWM]

Allows you to select the type of CPU fan cable connected to the CPU fan connector. Set to [PWM] when using a 4-pin CPU fan cable. Set to [DC] when using a 3-pin CPU fan cable. Configuration options: [PWM] [DC]



Some CPU fans with a 4-pin cable do not comply with Intel®'s PWM fan specification. When using this type of CPU fan, you can not reduce the CPU fan speed even if you set the CPU Q-Fan Mode to [PWM].

### CPU Fan1/Fan2 Speed (RPM) [xxxxRPM] or [N/A] or [Ignored]

The onboard hardware monitor automatically detects and displays the CPU fan speed in rotations per minute (RPM). If the fan is not connected to the motherboard, the field shows N/A. Select [Ignore] from the item options to disable CPU fan speed monitoring.

### **CHA Fan1/Fan2 Speed (RPM) [xxxxRPM] or [N/A] or [Ignored]**

The onboard hardware monitor automatically detects and displays the chassis fan speed in rotations per minute (RPM). If the fan is not connected to the chassis, the specific field shows N/A. Select [Ignore] from the item options to disable chassis fan speed monitoring.

### **SPS Fan/HP Fan3 Speed (RPM) [xxxxRPM] or [N/A] or [Ignored]**

The onboard hardware monitor automatically detects and displays the SPS/Heatpipe fan speed in rotations per minute (RPM). If the fan is not connected to the chassis, the specific field shows N/A. Select [Ignore] from the item options to disable chassis fan speed monitoring.

### **VCORE1/VCORE2 Voltage, 3.3V Voltage, 5V Voltage, 12V Voltage**

The onboard hardware monitor automatically detects the voltage output through the onboard voltage regulators.

## 4.6 Boot menu

The Boot menu items allow you to change the system boot options. Select an item then press <Enter> to display the sub-menu.

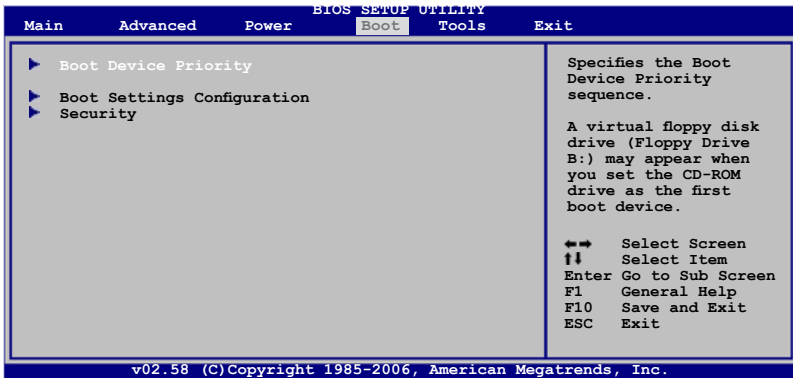

### 4.6.1 Boot Device Priority

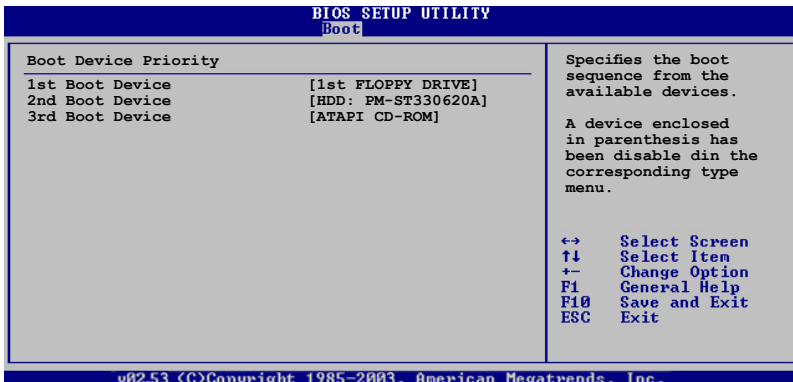

#### 1st ~ xxth Boot Device [1st FLOPPY DRIVE]

These items specify the boot device priority sequence from the available devices. The number of device items that appears on the screen depends on the number of devices installed in the system.

Configuration options: [1st FLOPPY DRIVE] [HDD:xxxxxx] [ATAPI CDROM] [Disabled]

## 4.6.2 Boot Settings Configuration

BIOS SETUP UTILITY	
Boot	
<b>Boot Settings Configuration</b>	
Quick Boot	[Enabled]
Full Screen Logo	[Enabled]
AddOn ROM Display Mode	[Force BIOS]
Bootup Num-Lock	[On]
PS/2 Mouse Support	[Auto]
Wait For 'F1' If Error	[Enabled]
Hit 'DEL' Message Display	[Enabled]
Interrupt 19 Capture	[Disabled]

Allows BIOS to skip certain tests while booting. This will decrease the time needed to boot the system.

### Quick Boot [Enabled]

Enabling this item allows the BIOS to skip some power on self tests (POST) while booting to decrease the time needed to boot the system. When set to [Disabled], BIOS performs all the POST items.

Configuration options: [Disabled] [Enabled]

### Full Screen Logo [Enabled]

Allows you to enable or disable the full screen logo display feature.

Configuration options: [Disabled] [Enabled]

### AddOn ROM Display Mode [Force BIOS]

Sets the display mode for option ROM.

Configuration options: [Force BIOS] [Keep Current]

### Bootup Num-Lock [On]

Allows you to select the power-on state for the NumLock.

Configuration options: [Off] [On]

### PS/2 Mouse Support [Auto]

Allows you to enable or disable support for PS/2 mouse.

Configuration options: [Disabled] [Enabled] [Auto]

### Wait for 'F1' If Error [Enabled]

When set to Enabled, the system waits for the F1 key to be pressed when error occurs. Configuration options: [Disabled] [Enabled]

### Hit 'DEL' Message Display [Enabled]

When set to Enabled, the system displays the message "Press DEL to run Setup" during POST. Configuration options: [Disabled] [Enabled]

### Interrupt 19 Capture [Disabled]

When set to [Enabled], this function allows the option ROMs to trap Interrupt 19.

Configuration options: [Disabled] [Enabled]

### 4.6.3 Security

The Security menu items allow you to change the system security settings. Select an item then press <Enter> to display the configuration options.

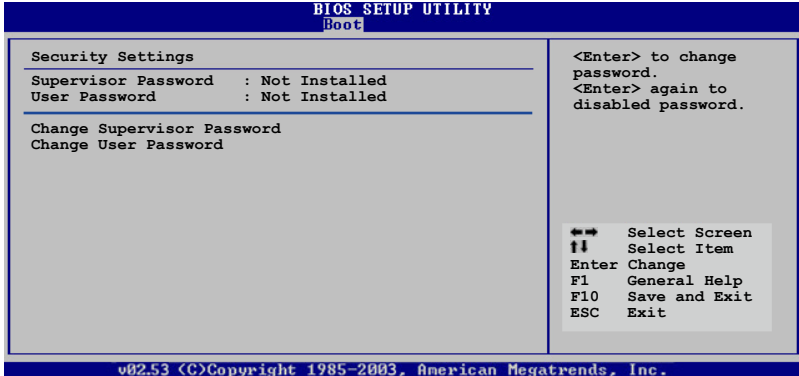

#### Change Supervisor Password

Select this item to set or change the supervisor password. The Supervisor Password item on top of the screen shows the default Not Installed. After you set a password, this item shows Installed.

To set a Supervisor Password:

1. Select the Change Supervisor Password item, then press <Enter>.
2. From the password box, type a password composed of at least six letters and/or numbers, then press <Enter>.
3. Confirm the password when prompted.

The message "Password Installed" appears after you successfully set your password.

To change the supervisor password, follow the same steps as in setting a user password.

To clear the supervisor password, select the Change Supervisor Password then press <Enter>. The message "Password Uninstalled" appears.



If you forget your BIOS password, you can clear it by erasing the CMOS Real Time Clock (RTC) RAM. See section "2.6 Jumper" for information on how to erase the RTC RAM.



After you have set a supervisor password, the other items appear to allow you to change other security settings.

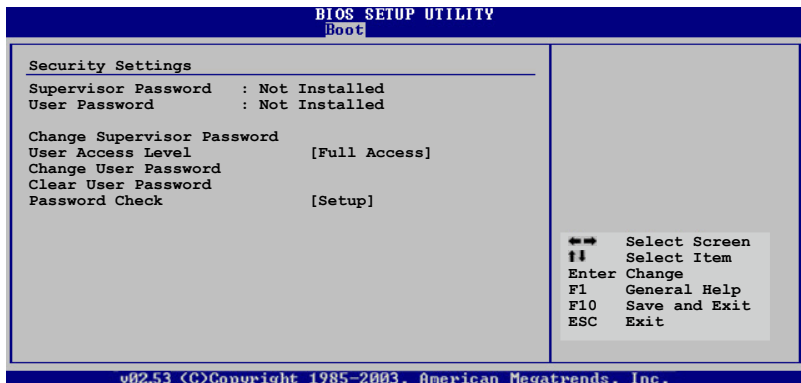

### User Access Level [Full Access]

This item allows you to select the access restriction to the Setup items. Configuration options: [No Access] [View Only] [Limited] [Full Access]

No Access prevents user access to the Setup utility.

View Only allows access but does not allow change to any field.

Limited allows changes only to selected fields, such as Date and Time.

Full Access allows viewing and changing all the fields in the Setup utility.

### Change User Password

Select this item to set or change the user password. The User Password item on top of the screen shows the default Not Installed. After you set a password, this item shows Installed.

To set a User Password:

1. Select the Change User Password item and press <Enter>.
2. On the password box that appears, type a password composed of at least six letters and/or numbers, then press <Enter>.
3. Confirm the password when prompted.

The message "Password Installed" appears after you set your password successfully.

To change the user password, follow the same steps as in setting a user password.

### **Clear User Password**

Select this item to clear the user password.

### **Password Check [Setup]**

When set to [Setup], BIOS checks for user password when accessing the Setup utility. When set to [Always], BIOS checks for user password both when accessing Setup and booting the system.

Configuration options: [Setup] [Always]

## 4.7 Exit menu

The Exit menu items allow you to load the optimal or failsafe default values for the BIOS items, and save or discard your changes to the BIOS items.

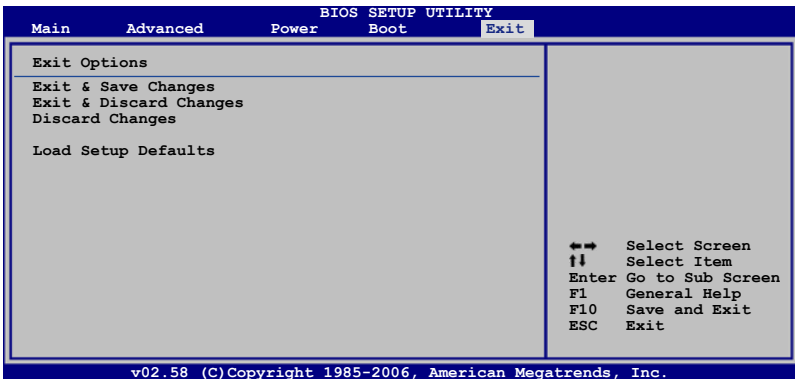

Pressing <Esc> does not immediately exit this menu. Select one of the options from this menu or <F10> from the legend bar to exit.

### Exit & Save Changes

Once you are finished making your selections, choose this option from the Exit menu to ensure the values you selected are saved to the CMOS RAM. An onboard backup battery sustains the CMOS RAM so it stays on even when the computer is turned off. When you select this option, a confirmation window appears. Select OK to save the changes and exit.



If you attempt to exit the Setup program without saving your changes, the program prompts you with a message asking if you want to save your changes before exiting. Press <Enter> to save the changes while exiting.

### Exit & Discard Changes

Select this option only if you do not want to save the changes that you made to the Setup program. If you made changes to fields other than System Date, System Time, and Password, the BIOS asks for a confirmation before exiting.

### Discard Changes

Allows you to discard the selections you made and restore the previously saved values. After selecting this option, a confirmation appears. Select Ok to discard any changes and load the previously saved values.

## **Load Setup Defaults**

Allows you to load the default values for each of the parameters on the Setup menus. When you select this option or if you press <F5>, a confirmation window appears. Select Ok to load default values. Select Exit & Save Changes or make other changes before saving the values to the non-volatile RAM.

This chapter describes the contents of the support CD that comes with the motherboard package.

# 5 Software support

## Chapter summary

# 5

5.1	Installing an operating system .....	5-1
5.2	Support CD information .....	5-1

## 5.1 Installing an operating system

This motherboard supports Windows® 2000/2003 Server/XP/64-bit XP operating systems (OS). Always install the latest OS version and corresponding updates to maximize the features of your hardware.



- Motherboard settings and hardware options vary. Use the setup procedures presented in this chapter for reference only. Refer to your OS documentation for detailed information.
- Make sure that you install Windows® 2000 Service Pack 4 or the Windows® XP Service Pack2 or later versions before installing the drivers for better compatibility and system stability.

## 5.2 Support CD information

The support CD that came with the motherboard package contains the drivers, software applications, and utilities that you can install to avail all motherboard features.



The contents of the support CD are subject to change at any time without notice. Visit the ASUS website([www.asus.com](http://www.asus.com)) for updates.

### 5.2.1 Running the support CD

Place the support CD to the optical drive. The CD automatically displays the Drivers menu if Autorun is enabled in your computer.

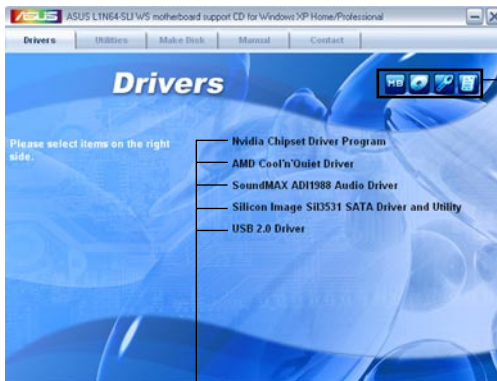

Click an icon to display support CD/motherboard information

Click an item to install



If Autorun is NOT enabled in your computer, browse the contents of the support CD to locate the file ASSETUP.EXE from the BIN folder. Double-click the ASSETUP.EXE to run the CD.

## 5.2.2 Drivers menu

The drivers menu shows the available device drivers if the system detects installed devices. Install the necessary drivers to activate the devices.

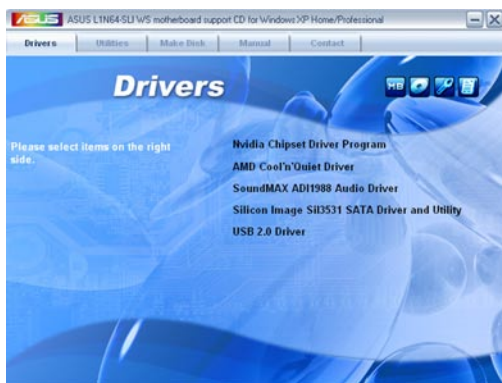

### **Nvidia Chipset Driver Program**

Installs the NVIDIA® Chipset drivers for the NVIDIA® nForce® 680a SLI chipset.

### **AMD Cool 'n' Quiet Driver**

Installs the AMD Cool 'n' Quiet™ technology driver.

### **SoundMAX ADI1988 Audio Driver**

Installs the SoundMAX® ADI1988 audio driver and application.

### **Silicon Image Sil3531 SATA Driver and Utility**

Installs the Silicon Image® Sil3531 SATA driver and utility.

### **USB 2.0 Driver**

Installs the Universal Serial Bus 2.0 (USB 2.0) driver.



## 5.2.3 Utilities menu

The Utilities menu shows the applications and other software that the motherboard supports.



### **ASUS Cool 'n' Quiet Utility**

Installs the AMD Cool 'n' Quiet™ software.

### **ASUS Update**

The ASUS Update utility allows you to update the motherboard BIOS in Windows® environment. This utility requires an Internet connection either through a network or an Internet Service Provider (ISP).

### **Adobe Acrobat Reader V7.0**

Installs the Adobe® Acrobat® Reader that allows you to open, view, and print documents in Portable Document Format (PDF).

### **Microsoft DirectX 9.0c**

Installs the Microsoft® DirectX 9.0c driver. The Microsoft DirectX® 9.0c is a multimedia technology that enhances computer graphics and sound. DirectX® improves the multimedia features of your computer so you can enjoy watching TV and movies, capturing videos, or playing games in your computer. Visit the Microsoft website ([www.microsoft.com](http://www.microsoft.com)) for updates.

### **Anti-virus Utility**

The anti-virus application scans, identifies, and removes computer viruses. View the online help for detailed information.

## 5.2.4 Make Disk menu

The Make Disk menu contains items to create the NVIDIA® nForce® 680a or Silicon Image SATA/PATA RAID driver disk.



### **Make nVidia 32bit/64bit SATA RAID Driver**

Allows you to create an NVIDIA® Serial ATA RAID driver disk for a 32-bit/64-bit system.

### **Silicon Image SiI3531 32bit/64bit SATA Driver**

Allows you to create a Silicon Image® SiI3531 Serial ATA driver disk for a 32-bit/64-bit system.

## 5.2.5 Manuals menu

The Manuals menu contains a list of supplementary user manuals. Click an item to open the folder of the user manual.



Most user manual files are in Portable Document Format (PDF). Install the Adobe® Acrobat® Reader from the Utilities menu before opening a user manual file.

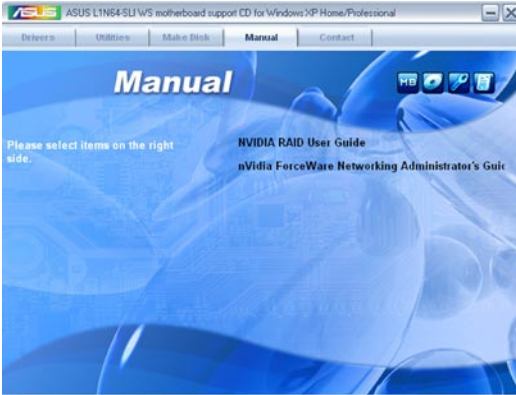

## 5.2.6 ASUS Contact information

Click the Contact tab to display the ASUS contact information. You can also find this information on the inside front cover of this user guide.



## 5.2.7 Other information

The icons on the top right corner of the screen give additional information on the motherboard and the contents of the support CD. Click an icon to display the specified information.

### Motherboard Info

Displays the general specifications of the motherboard.



### Browse this CD

Displays the support CD contents in graphical format.

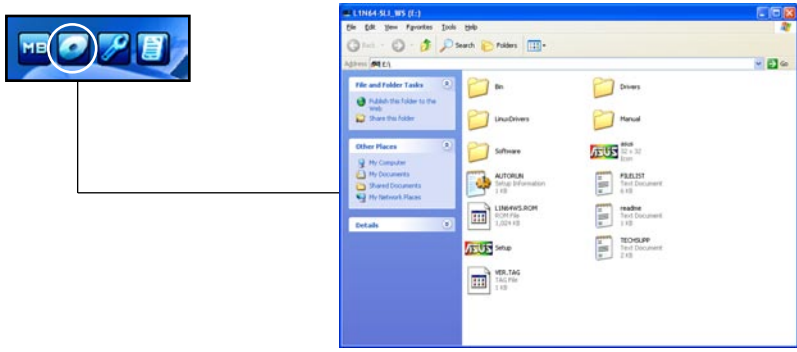

## Technical support Form

Displays the ASUS Technical Support Request Form that you have to fill out when requesting technical support.



```
ASUSTEK TECHNICAL SUPPORT REQUEST FORM DATE:
-----
ORIGINATOR DESCRIPTION
-----
COMPANY NAME: CONTACT NAME:
PHONE (AREA): FAX # (AREA):
EMAIL ADDRESS:
-----
HARDWARE DESCRIPTION
-----
MOTHERBOARD: REVISION #: BIOS:#A0L0A0-
CPU BRAND: SPEED(MHz):
DRAM BRAND: SPEED(Ms) : SIZE(MB):
CACHE BRAND: SPEED(Ms) : SIZE(KB):
HDD DISK: MODEL NAME: SIZE(MB):
BACKUP BRAND: MODEL NAME: SIZE(MB):
OTHER STORAGE: MODEL NAME: SIZE(MB):
-----
ADD-IN CARD DESCRIPTION (MODEL NAME/VENDOR)
-----
(O)ISA SLOT 1:
(O)ISA SLOT 2:
(O)ISA SLOT 3:
(O)ISA SLOT 4:
PCI-E SLOT 1:
PCI-E SLOT 2:
PCI-E SLOT 3:
PCI-E SLOT 4:
PCI SLOT 1:
PCI SLOT 2:
PCI SLOT 3:
PCI SLOT 4:
PCI SLOT 5:
-----
```

## Filelist

Displays the contents of the support CD in text format.



```
File list for the included support software for L1N64-SLI WS professional motherboard
-----
File name Description
-----
-drivers
-AMD AMD Cool'n'Quiet driver v1.0.1 for Windows 2000
AMD Cool'n'Quiet driver v1.3.2.0 for Windows XP/SP MCE/2003/XP 64bit
-mp_2003
-Audio SoundMAX ADI1988 Audio driver v5.10.1.4380 for Windows 2000/XP/SP M
SoundMAX ADI1988 Audio driver v5.10.2.4380 for Windows XP 64bit/200
-Chipset nVIDIA CHSPset Driver Package V9.19 for Windows 2000/XP/2003 Server
nVIDIA CHSPset Driver Package V9.19 for Windows XP 64 Bit/2003 64bit
-MakeMdisk -32bit Make nVidia 32bit SATA RAID driver for Windows 2000/XP/SP MCE/2003
-64bit Make nVidia 64bit SATA RAID driver for Windows XP 64bit/2003 64bit
-AIS nVidia CHSPset Configuring NVIDIA networking drivers with Microsoft
DOS Net3 Ethernet and Netware DOS 001 client driver.
-DOS_NET3
-RAID -driver stllcon image ST1 3331 SATA driver v1.5.9.0 for Windows 2000/XP/SP I
Make stllcon image ST1 3331 SATA driver disk for Windows 2000/XP/SP I
-USB USB 2.0 driver for Windows 2000/XP
USB 2.0 driver for Windows 2000
USB 2.0 driver for Windows XP/XP MCE
-LinuxDrivers Support Linux Drivers.
-Manual User guide pdf file.
```



## Free Manuals Download Website

<http://myh66.com>

<http://usermanuals.us>

<http://www.somanuals.com>

<http://www.4manuals.cc>

<http://www.manual-lib.com>

<http://www.404manual.com>

<http://www.luxmanual.com>

<http://aubethermostatmanual.com>

Golf course search by state

<http://golfingnear.com>

Email search by domain

<http://emailbydomain.com>

Auto manuals search

<http://auto.somanuals.com>

TV manuals search

<http://tv.somanuals.com>